



BILLY GOAT DL TRUCK LOADER VACUUM Owner's Manual DL1800V and DL2500S

Accessories

INTAKE

HOSE REPLACEMENT KIT

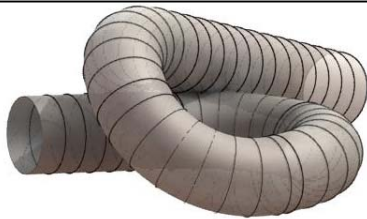

Standard on DL units. [12"(305mm) x 10' (3.0m)] [10"(254mm) X 10'(3.0m)]

10" HOSE P/N 791033
12" HOSE P/N 791034

Part No 791098

EXHAUST

EXHAUST HOSE KIT



[8"(203mm) x 5' (1.5m)] flexible hose increases exhaust distance.

P/N 791107

1

TRAILER

TRAILER DL



Heavy duty spring axle trailer designed for towing your DL. Allows unit to be mounted for pickup from rear.

P/N 791133

Form No F070207A



ABOUT THIS MANUAL

THANK YOU for purchasing a BILLY GOAT® *DL Vacuum*. Your new machine has been carefully designed and manufactured to provide years of reliable and productive service. This manual provides complete operating and maintenance instructions that will help to maintain your machine in top running order. Read this manual carefully before assembling, operating, or servicing your equipment.

CONTENTS

SERIAL PLATE DATA AND SPECIFICATIONS _____	3
GENERAL SAFETY _____	4-5
SOUND AND VIBRATION _____	6
INSTRUCTION LABELS _____	7
PACKING CHECKLIST & ASSEMBLY _____	8-9
OPERATION _____	9-11
MAINTENANCE _____	12
TROUBLESHOOTING AND WARRANTY PROCEDURE _____	13
ILLUSTRATED PARTS & PARTS LISTS _____	14-15
MAINTENANCE RECORD _____	16



SERIAL PLATE DATA

Record the model number, serial number, date of purchase, and where purchased.

Purchase Date: _____

Purchased From: _____

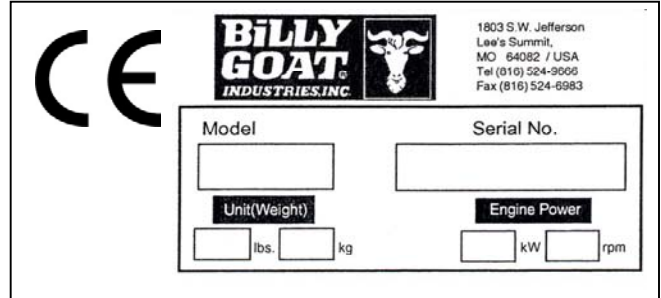

Specifications

	DL1800V	DL2500S
Engine: HP	18 (13.4kW)	25 (18.6kW)
Engine: Model	35644-70235-E1	EH720-DS0510
Engine: Type	VANGUARD	SUBARU
Engine: Fuel Capacity	6 gal. (22.7 L) REMOTE TANK	6 gal.. (22.7 L) REMOTE TANK
Engine: Oil Capacity	1.8 qt. (1.7 L)	1.63 qt. (1.55 L)
Total Unit Weight:	306 lbs (138.8 kg)	326 lbs (147.9 kg)
Max operating slope	25 ⁰	25 ⁰
Overall Height	74 7/8" (1.90m)	74 7/8" (1.90m)
Overall Height with optional trailer	91"(2.31m)	91"(2.31m)
Overall Width	32 1/4" (0.82m)	32 1/4" (0.82m)
Overall Length	60" (1.52m)	60" (1.52m)
In compliance with 2000/14/EEC standards	113.44 dB(a)	113.44 dB(a)
Sound at operators position	93.44 dB(a)	93.44 dB(a)
Vibration at operator position	0.11 g	0.11g

BATTERY NOT INCLUDED:

REQUIRES 12 V BATTERY, 40 AH, 240 CCA MIN. U1 SERIES GROUP BATTERY FOR PROPER FIT

GENERAL SAFETY INSTRUCTIONS and SYMBOLS

The safety symbols shown below are used throughout this manual. You should become familiar with them before assembling, operating, or servicing this equipment.



WARNING: This symbol indicates important information that will prevent injury to yourself or others.



This symbol indicates ear protection is recommended when operating this equipment.



This symbol indicates eye protection is recommended when operating this equipment.



This symbol indicates gloves should be worn when servicing this equipment.



This symbol indicates that this manual and the engine manufacturer's manual should be read carefully before assembling, operation, or servicing this equipment.



CAUTION: This symbol indicates important information that will prevent damage to your BILLY GOAT[®] DL VACUUM.



This symbol indicates the engine oil level should be checked before operating this equipment.

Read and make sure you thoroughly understand the following safety precautions before assembling, operating or servicing this equipment:



READ this manual and the engine manufacturer's manual carefully before assembling, operating, or servicing this equipment.



EAR PROTECTION is recommended when operating this equipment.



EYE PROTECTION is recommended when operating this equipment.



BREATHING PROTECTION is recommended when operating this equipment.





















WARNING: **EXHAUST** from this product contains chemicals known to the State of California to cause cancer, birth defects or other reproductive harm.







DO NOT operate this equipment on any unimproved forested, brushy, or grass covered land unless a spark arrester is installed on the muffler as required by Section 4442 of the California Public Resources Code. The arrester must be maintained in good working order. Other states may have similar laws. Federal laws apply on federal lands.

DO NOT run engine in an enclosed area. Exhaust gases contain carbon monoxide, an odorless and possibly fatal poison.

**WARNING:**

-  **DO NOT** run this equipment indoors or in any poorly ventilated area. Refueling outdoors is recommended.
-  **DO NOT** refuel this equipment while the engine is running. Allow engine to cool for at least two minutes before refueling.
-  **DO NOT** store gasoline near an open flame.
-  **DO NOT** remove gas cap while engine is running.
-  **DO NOT** start or operate engine if strong odor of gasoline is present.
-  **DO NOT** start or operate engine if gasoline is spilled. Move equipment away from spill until gasoline has completely evaporated.
-  **DO NOT** smoke while filling the fuel tank.
-  **DO NOT** check for spark with spark plug or spark plug wire removed. Use an approved spark tester.
-  **DO NOT** operate engine without a muffler. Inspect muffler periodically and replace if necessary. If equipped with muffler deflector, inspect deflector periodically and replace if necessary.
-  **DO NOT** operate engine with grass, leaves or other combustible material near the muffler.
-  **DO NOT** touch muffler, cylinder, or cooling fins when hot. Contact with hot surfaces may cause severe burns.
-  **DO NOT** leave equipment unattended while in operation.
-  **DO NOT** park equipment on a steep grade or slope.
-  **DO NOT** operate equipment with bystanders in or near the work area.
-  **DO NOT** allow children to operate this equipment.
-  **DO NOT** operate equipment with guards removed.
-  **DO NOT** operate equipment near or pick up hot or burning debris or any toxic or explosive materials.
-  **DO NOT** operate equipment on slopes greater than specified in Specifications section of this manual.
-  **DO NOT** place hands or feet inside nozzle intake, near debris outlet, or near any moving parts.

**WARNING: Important**

-  **DO NOT** use this machine for vacuuming **exclusively** sand, dust, fine dirt, rock, glass, string like material, grain, rags, cans, metal, bark or water.
-  **DO NOT** start engine without hose and exhaust elbow connected firmly in place to housing and outlet.
-  **DO NOT** operate without discharging exhaust into enclosed container.
-  **DO NOT** operate with hose or exhaust elbow removed
-  **DO NOT** remove hose until engine has been turned off and has come to a complete stop.
-  **DO NOT** transport unit without securing exhaust elbow and making sure that the elbow will not strike objects in transport.
-  **DO NOT** operate this unit freestanding. Unit must be secured in place during any operation.

ALWAYS remove spark plug wires when servicing equipment to prevent accidental starting.

ALWAYS check fuel lines and fittings frequently for cracks or leaks. Replace if necessary.

ALWAYS keep hands and feet away from moving or rotating parts.

ALWAYS store fuel in approved safety containers.



SOUND

 **L_{WA}** SOUND LEVEL 93 dB(a) at Operator Position
113 dB

Sound tests were conducted in accordance with 2000/14/EEC, and were performed on 6/18/07 under the conditions listed below.

 Sound power level listed is the highest value for any model covered in this manual. Please refer to serial plate on the unit for the sound power level for your model.

General Conditions:	Cloudy
Temperature:	74°F (23.2°C)
Wind Speed:	3.7 mph (21.6 kmh)
Wind Direction:	South
Humidity:	83.5%
Barometric Pressure:	29.8 Hg (756 mm Hg)

VIBRATION DATA

VIBRATION LEVEL 0.11g

Vibration levels at the operator's handles were measured in the vertical, lateral and longitudinal directions using calibrated vibration test equipment. Tests were performed on 7-10-07 under the conditions listed below.

General Conditions:	Sunny
Temperature:	86°F (17°C)
Wind Speed:	13 mph (20 kph)
Wind Direction:	North
Humidity:	49%
Barometric Pressure:	29.8" Hg (756mm Hg)

INTENDED USE

INTENDED USE: This machine is designed for vacuuming leaves, grass clippings and other types of organic litter. Debris mixed with cans, bottles and small amounts of sand can be vacuumed; however, it is not this machine's primary purpose. Vacuuming cans, bottles and sand will affect the longevity of your machine.

Do not operate if excessive vibration occurs. If excessive vibration occurs, shut engine off immediately and check for damaged or worn impeller, loose impeller bolt, loose impeller key, loose engine or lodged foreign objects. Note: See parts list for proper impeller bolt torque specifications. (See trouble shooting section on page 13).

INSTRUCTION LABELS

The labels shown below were installed on your BILLY GOAT® DL Vacuum. If any labels are damaged or missing, replace them before operating this equipment. Item numbers from the Illustrated Parts List and part numbers are provided for convenience in ordering replacement labels. The correct position for each label may be determined by referring to the Figure and Item numbers shown.



DANGER KEEP HANDS AND FEET AWAY
ITEM #3 P/N 400424

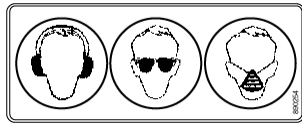

EAR EYE BREATHING
ITEM# 49 P/N 890254



WARNING SECURE
ITEM#72 P/N 790232



DANGER FLYING DEBRIS
ITEM #43 P/N 810736



READ OWNERS MANUAL
ITEM #50 P/N 830301



EXPLOSIVE FUEL
ITEM # 1 P/N 468572



DL INSTRUCT/WARN
ITEM #18 P/N 790142



WARNING ENGINE OVERHEAT
ITEM #58 P/N 811215



SECURE NOZZLE
ITEM #72 P/N 790232

ENGINE LABELS

VANGUARD

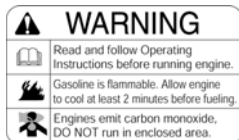

SUBARU

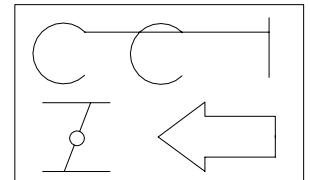

ENGINE CONTROLS

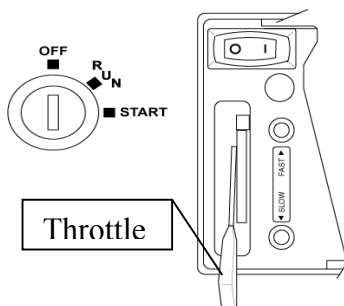

Part No 791098

Vanguard

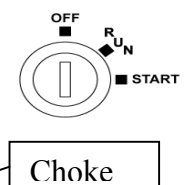
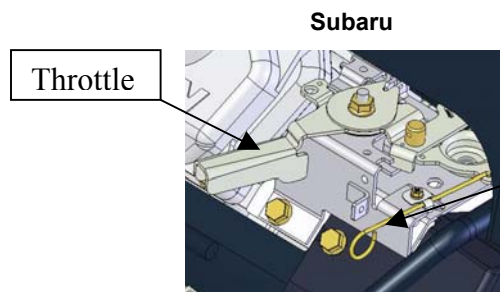

Subaru



PACKING CHECKLIST

Your Billy Goat is shipped from the factory in one carton and is completely assembled except for the exhaust elbow, nozzle, handle loop for nozzle, hose booms, hose bands, hose coupler, hose clamps and related hardware.



READ all safety instructions before assembling unit.
TAKE CAUTION when removing the unit from the box.



PUT OIL IN ENGINE BEFORE STARTING

PARTS BAG & LITERATURE ASSY

Warranty card P/N- 400972, Owner's Manual P/N-791098, Declaration of Conformity P/N-791090.

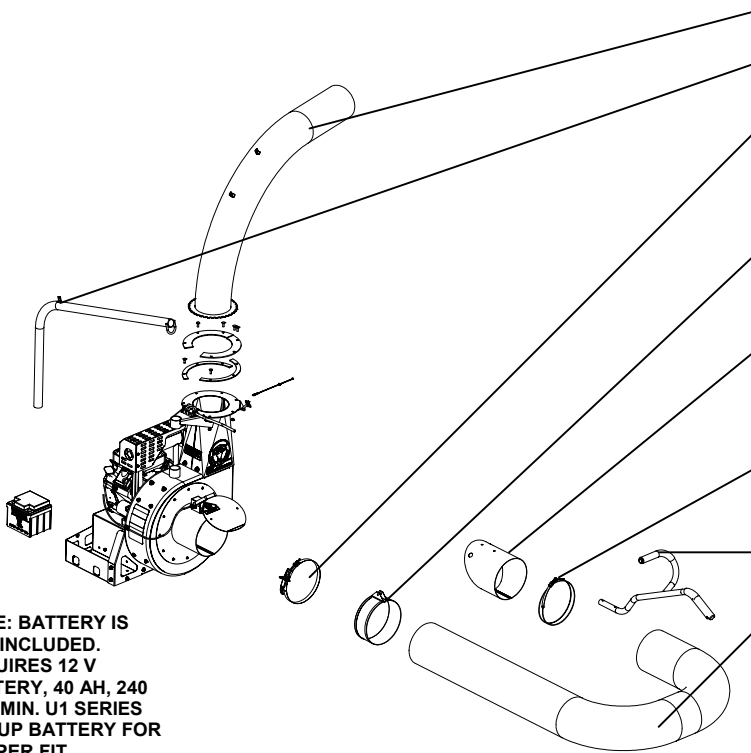

NOTE: BATTERY IS NOT INCLUDED. REQUIRES 12 V BATTERY, 40 AH, 240 CCA MIN. U1 SERIES GROUP BATTERY FOR PROPER FIT

Boxing Parts Checklist

- Exhaust Elbow PN# 791114-S qty 1
- Hose Boom Assembly PN# 791113 qty 1
- Hose quick clamp 12" PN# 791065 qty 1
OR
- Hose quick clamp 10" PN# 791064 qty 1
- Band hose boom 12" PN# 790153 qty 1
OR
- Band hose boom 10" PN# 810868 qty 1
- Nozzle DL 12" PN# 790149 qty 1
OR
- Nozzle DL 10" PN# 811005 qty 1
- Hose clamps 12" PN# 790150-01 Qty. 1
OR
- Hose clamps 10" PN# 810706-01 qty 1
- Handle Nozzle PN# 791116 qty 1
- Hose 12"x 10' DL PN# 791034 qty 1
OR
- Hose 10"x 10' DL PN# 791033 qty 1
- Vanguard 18 HP
OR
- Subaru 25 HP
- Parts Bag & Literature Assy P/N 791135

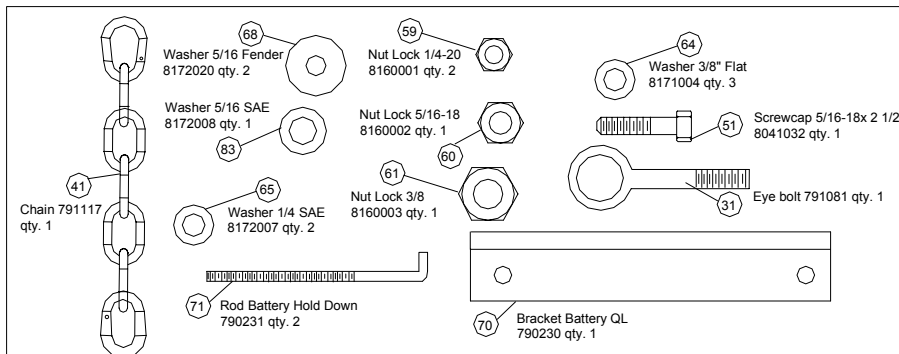

Parts Bag Hardware

ASSEMBLY

1. **SECURELY ATTACH** unit to the bed of a truck or to a trailer, so that the exhaust discharges into an enclosed container.
NOTE: This unit must be securely mounted to the bed of a truck or to a trailer before operating.
2. **ATTACH** hose to housing intake, using hose clamp (item 22) making sure to place the safety switch under the clamp. Then place the clamp (item 22) over around the end of the hose to be attached to housing. Slide the hose onto the housing intake and place the shut off switch under the clamp. Make sure the shut off switch is pressed in or the vacuum will not start, and clamp the hose to the intake.
3. **ASSEMBLE** nozzle handle (item 45), to nozzle (item 25), using screw (item 51), eye bolt (item 31), washers (item 66), washers (item 68) and lock nuts (item 60).
4. **ATTACH** assembled nozzle to hose using hose clamp (item 26). Before tightening hose clamp, position nozzle handle upward when hose is stretched to prevent twisting load on hose assembly during operation.
5. **ATTACH** the hose boom (item 9) by sliding the boom through the rings on the top of housing.
6. **ASSEMBLE** hose band (item 29) around hose and secure chain between flanges of the hose band using capscrew (item 63) and lock nut (item 59) Repeat same steps on the other chain. (See ADJUSTING HOSE BOOM on page 11).
7. **SECURELY ATTACH** exhaust elbow (item 21) capturing both flanges inside the clamp, then firmly tighten the clamp, securing the elbow to the housing (see MOUNTING on page 10).
8. **INSTALL** a standard 12 volt lawn and garden battery "U1" series (**not included**) with at least 240 cold cranking amps and a 40 amp hour rating by using battery bracket DL (item no. 70, hold down rods (item 71), washers (item 65), and lock nuts (item 59).
9. **ATTACH** red battery cable to + terminal and black battery cable to - terminal.

OPERATION

 Like all mechanical tools, reasonable care must be used when operating machine.

Inspect machine work area and machine before operating. Make sure that all operators of this equipment are trained in general machine use and safety.

 **PUT OIL IN ENGINE BEFORE STARTING**

STARTING

SECURE LOADER OR MOUNT BEFORE STARTING

 **ENGINE:** See engine manufacturer's instructions for type and amount of oil and gasoline used. Engine must be level when checking and filling oil and gasoline.

ENGINE SPEED: Controlled by throttle lever on the engine.

INTAKE HOSE: Hose mounting assembly must be properly attached to vac housing and safety switch must be engaged before engine will start. Note: Any damage to the switch or wiring harness will prevent engine from starting.

THROTTLE: Move throttle control to fast position.

KEY SWITCH: Turn to start position until engine begins to fire, immediately release the key to the run position.



Note: Do not hold key in start position more than 10 seconds per attempt.

IF YOUR UNIT FAILS TO START: See Troubleshooting on page 13. Also see engine owner's manual.

HANDLING & TRANSPORTING:



HOSE: DO NOT drag the hose with vehicle.

  Never lift the machine while the engine is running.

 **ALWAYS SECURE THE NOZZLE BEFORE TRANSPORTING UNIT**

MOUNTING: Main unit

GENERAL: Unit must be securely mounted to a trailer, truck bed, or other similar surface before use. Do not use this unit in a freestanding position. Unit is not stable until it has been secured in place.

Secure unit by bolting through the base of the unit and through the mounting surface using 3/8" dia. bolts, with washers and locking nuts (see fig. 1)

MOUNTING: Figure 2 illustrates the mounting position to the trailer (Billy Goat Part no. 791133) available from your Billy Goat dealer. The unit is only mounted one way.

MOUNTING: Exhaust elbow

Note: this process is easier with two people, one to support the exhaust elbow and one to attach plates and hardware.

- 1) Remove the loose hardware from the clamp assembly so that there are 4 separate pieces (two top plates and two bottom plates).
- 2) Apply good quality grease to the top and bottom of the toothed plate of the exhaust elbow (791114). Also grease top surface of housing and bottom of clamp plates where the gear will rotate.
- 3) Place the exhaust elbow on the chute with the teeth of the flange against the worm gear and the exhaust holes aligning.
- 4) Place the two bottom plates on the opposite edges beside the elbow teeth aligning the holes.
- 5) Place the top plates on top of the lower plates aligning the holes.
- 6) Secure the assembly with a plate half on top of the elbow flange and a plate half on bottom of the housing flange using 6, 1" carriage bolts and 6 lock nuts (removed hardware in step 1).

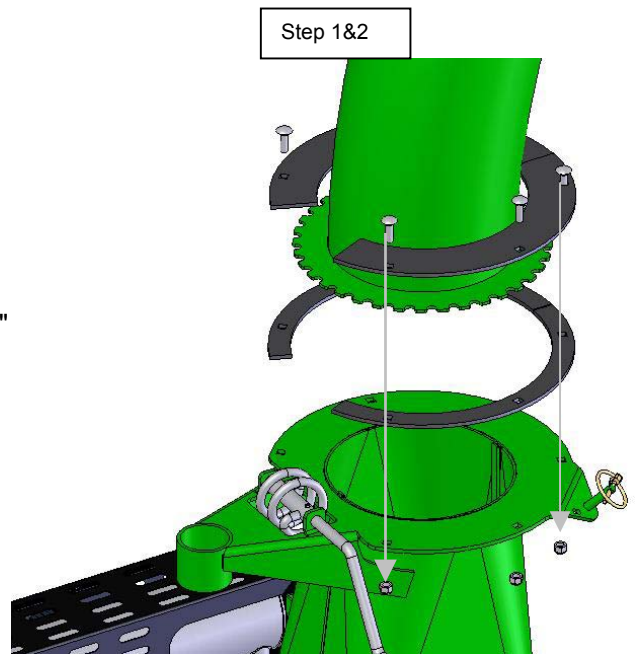
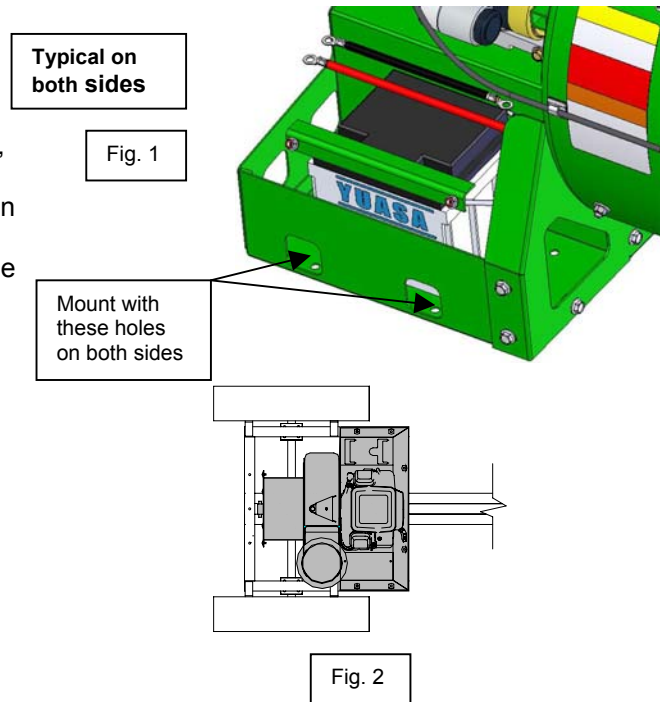

VACUUMING OPERATION

EXHAUST DIRECTION & DISTANCE: Exhaust direction and distance are controlled by the rotation of the exhaust elbow. Typically debris is aimed to discharge to the rear of the container. The direction of discharge is adjusted by turning the crank on the exhaust elbow clamp and rotating the elbow to the desired direction.

NOTE: Elbow is heavy. Use caution when adjusting. Never stand directly under the elbow while adjusting direction of exhaust.

Never direct exhaust into an area where bystanders may cross the path of the debris.

INTAKE OPERATION: With machine running and fully assembled, move the nozzle in sweeping motions over debris. Always allow air to flow into the nozzle along with the debris. Do not completely block the nozzle when vacuuming, it will reduce performance, and increase clogging (See figure 3).

For removal of heavier debris, or debris that is stuck to the ground, rock nozzle forward to concentrate suction power around the debris (See figure 4).

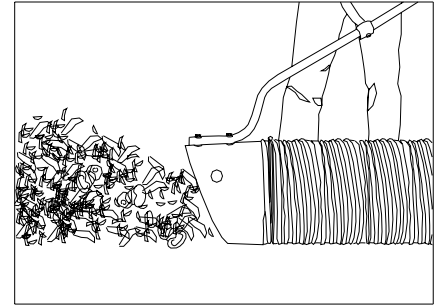

Fig. 3

ADJUSTING HOSE BOOM

Properly adjusting the boom will prevent most hose clogs from occurring and will maximize vacuum performance by keeping the hose straight and perpendicular to the housing (see fig. 5). Height adjustments are made by raising or lowering one of the attachment links to a different area on the chain.



Fig. 4

UNCLOGGING A CLOGGED HOSE

With engine running and unit secured to a trailer, truck bed, or other similar surface, fully stretch hose in a straight line to dislodge the clog. If the clog will not clear, turn unit off, and allow engine to come to a complete stop. Remove hose and manually clear hose clog. **NOTE:** The clogged debris may be sharp. Always wear durable gloves when removing clog.

UNCLOGGING A CLOGGED HOUSING OR EXHAUST ELBOW

Turn engine off and wait for impeller to come to a complete stop. Disconnect spark plug wires and battery cables. Remove the hose from the housing and determine where the clog is located. If possible clear the clog through the intake opening. It may require removal of the intake adaptor (item 33) to allow access to clear the housing. If clog is in the elbow, carefully remove the elbow. Remove elbow by removing the bolts and nuts on the elbow clamp so that the plates can be removed.

NOTE: Elbow is very heavy. Do not stand directly under elbow during removal.

Danger, the clog may contain sharp materials. Wearing durable gloves, clear the clog. Reconnect spark plug wire.

HOSE CARE AND TIPS

To increase hose life, periodically rotate hose and reposition nozzle and coupler on front plate of unit. This increases hose life by keeping hose from wearing only on one side.

Keep hose as straight as possible and avoid sharp bends during operation for best pick-up and to avoid clogs.

Never drag hose. Always remove and store hose before transporting unit.

Store hose straight and flat to maintain flexibility for next use.

THE HOSE IS A REPLACEABLE WEAR ITEM.

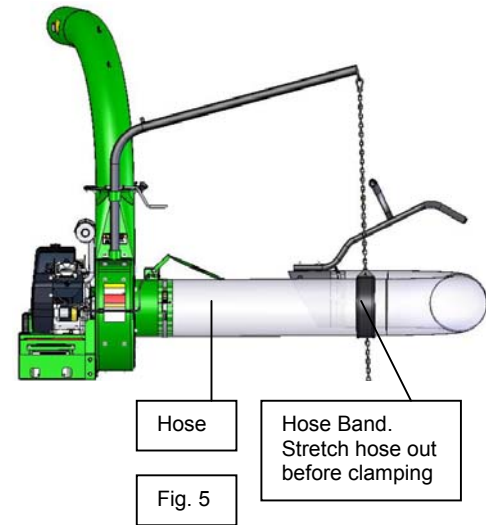

Fig. 5

STORAGE

Turn fuel supply off when unit is not in use. Never store engine indoors or in enclosed poorly ventilated areas with fuel in tank, where fuel fumes may reach an open flame, spark or pilot light, as on a furnace, water heater, clothes dryer or other gas appliance.

If engine is to be unused for 30 days or more, prepare as follows:

Be sure engine is cool. Do not smoke. Remove all gasoline from carburetor and fuel tank to prevent gum deposits from forming on these parts and causing possible malfunction of engine. Drain fuel outdoors, into an approved container, away from open flame. Run engine until fuel tank is empty and engine runs out of gasoline. **NOTE:** Fuel stabilizer (such as Sta-Bil) is an acceptable alternative in minimizing the formation of fuel gum deposits during storage. Add stabilizer to gasoline in fuel tank or storage container. Always follow mix ratio found on stabilizer container. Run engine at least 10 min. after adding stabilizer to allow it to reach the carburetor.

HOSE STORAGE: Storing hose in a covered area, out of sunlight and heat will prolong hose life. Do not store hose where it could be stepped on or where other objects could crush or damage hose.

MAINTENANCE

PERIODIC MAINTENANCE

Periodic maintenance should be performed at the following intervals:

Maintenance Operation	Every use	Every 5 hours (daily)	Every 10 Hours	Every 25 Hours
Inspect for loose, worn or damaged parts.		•		
Check engine oil and air filter	•			
Clean hose	•			
Engine (See Engine Manual)				
Inspect battery for damage or leak			•	
Keep engine free of debris	•			
Check battery terminal for corrosion				•
Check for excessive vibration		•		

IMPELLER REMOVAL

1. Wait for engine to cool and disconnect spark plug wires from the both sides of the engine.
 2. Disconnect the negative battery cable (black) (item 12) from the battery.
 3. Remove the hose from the unit.
 4. Unattach the hose from boom assembly.
 5. Remove the intake housing assembly (item 33) using 9/16" socket and socket wrench to remove (12) locknuts (item 47). Be careful to place intake assembly to the side without putting excess strain on safety switch wire harness
 6. Remove impeller bolt and lock washer using 5/8" socket and impact wrench (see fig. 6).
 7. Once bolt is removed impeller should slide out freely. If impeller will not slide free on crankshaft, obtain a 3/4"-16 x 3" bolt and thread it into the nut that is welded onto the center of the impeller and tighten slowly to push the impeller off the crankshaft.
- Note:** The 3/4"-16 x 3" bolt can be ordered from your local Billy Goat Dealer (part no. 440192).
8. When impeller is free of the engine shaft, align impeller with the opening and pull it straight out of the housing.
 9. Using a new impeller bolt, washer, and lock washer, install new impeller in reverse order.
- Note:** Be sure spacer is in place behind impeller before tightening.
10. Tighten impeller bolt. Torque impeller bolt to [60 Ft. Lbs. (81.4 N.m)].
 11. Repeat steps 2 through 5 in reverse order.
 12. Reinstall spark plug wires.

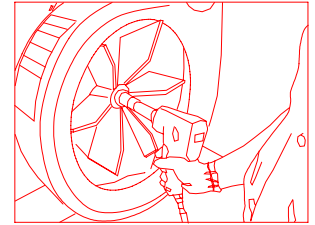
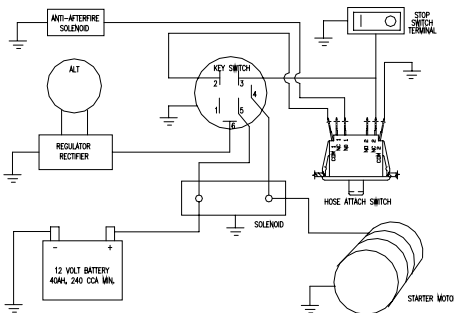

Fig. 6

INTERLOCK SYSTEM

With hose coupler installed (as shown in Fig. 8) the switch is open & engine is not grounded out, allowing engine to run.



BRIGGS WIRING DIAGRAM

Part No 791098

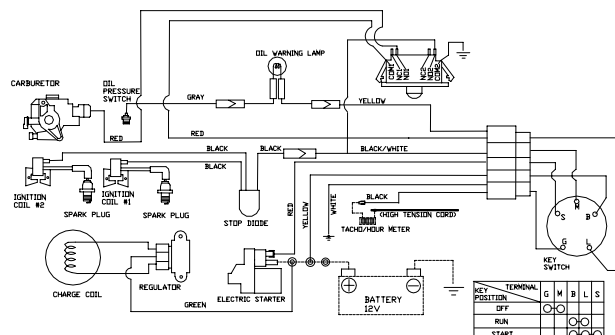

SUBARU WIRING DIAGRAM

12

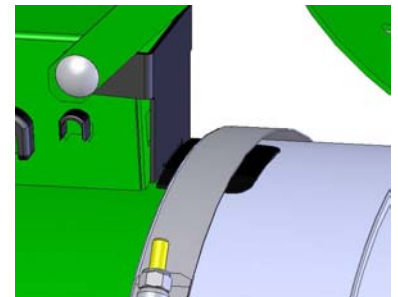

Hose must be installed and switch lever must engage switch for engine to start.

Form No F070207A



Troubleshooting

Problem	Possible Cause	Solution
Abnormal vibration.	Loose or out of balance impeller or loose engine	Check impeller and replace if necessary. Check engine.
Will not vacuum or has poor vacuum performance	· Nozzle buried in debris. Clogged hose or exhaust. Excessive quantity of debris.	· Withdraw nozzle from debris pile. Unclog hose or exhaust (see pg. 11) Allow air to feed debris.
Engine will not start. (Starter does not turn)	Battery is low or dead. Battery Cable is disconnected or battery terminal is corroded. Harness wire is bad or disconnected from interlock switch. Hose not installed, allowing interlock wire to ground.	Charge battery or replace if the battery does not hold charge. Clean battery terminal and cable then reconnect. Install hose coupler securely to the unit and check whether interlock switch is engaged by lever. Check harness wire connection and replace if necessary.
Engine will not start. (Starter turns)	· Throttle & / or stop switch in off position. Out of gasoline. Bad or old gasoline. Spark plug wire disconnected. Dirty air cleaner.	· Check stop switches, throttle, and gasoline. Connect spark plug wire. Clean or replace air cleaner. Or contact a qualified service person.
Engine is locked, will not pull over.	· Debris locked against impeller. Engine problem.	· See pg.11, Clearing a clogged impeller housing. Contact an engine servicing dealer for engine problems.

When servicing engine refer to specific manufacturers engine owner's manual. Engine warranty is covered by the specific engine manufacturer. If your engine requires warranty or other repair work contact your local servicing engine dealer. When contacting a dealer for service it is a good idea to have your engine model number available for reference (See table page 3). If you cannot locate a servicing dealer in your area you can contact the manufacturers national service organization.

To reach:

Briggs & Stratton: 800-233-3723 www.briggsandstratton.com

Subaru America: 800-277-6246 www.robinamerica.com

WARRANTY CLAIM PROCEDURE

Should a BILLY GOAT[®] machine fail due to a defect in material and/or workmanship, the owner should make a warranty claim as follows:

- The machine must be taken to the dealer from whom it was purchased or to an authorized Servicing BILLY GOAT Dealer.
- The owner must present the remaining half of the Warranty Registration Card, or, if this is not available, the invoice or receipt.
- The Warranty Claim will be completed by the authorized BILLY GOAT Dealer and submitted to their respective BILLY GOAT Distributor for their territory Attention: Service Manager. Any parts replaced under warranty must be tagged and retained for 90 days. The model number and serial number of the unit must be stated in the Warranty Claim.
- The distributor service manager will sign off on the claim and submit it to BILLY GOAT for consideration.
- The Technical Service Department at BILLY GOAT will study the claim and may request parts to be returned for examination. BILLY GOAT will notify their conclusions to the distributor service manager from whom the claim was received.
- The decision by the Technical Service Department at BILLY GOAT to approve or reject a Warranty Claim is final and binding.

For online product registration go to www.billygoat.com

PARTS DRAWING DL

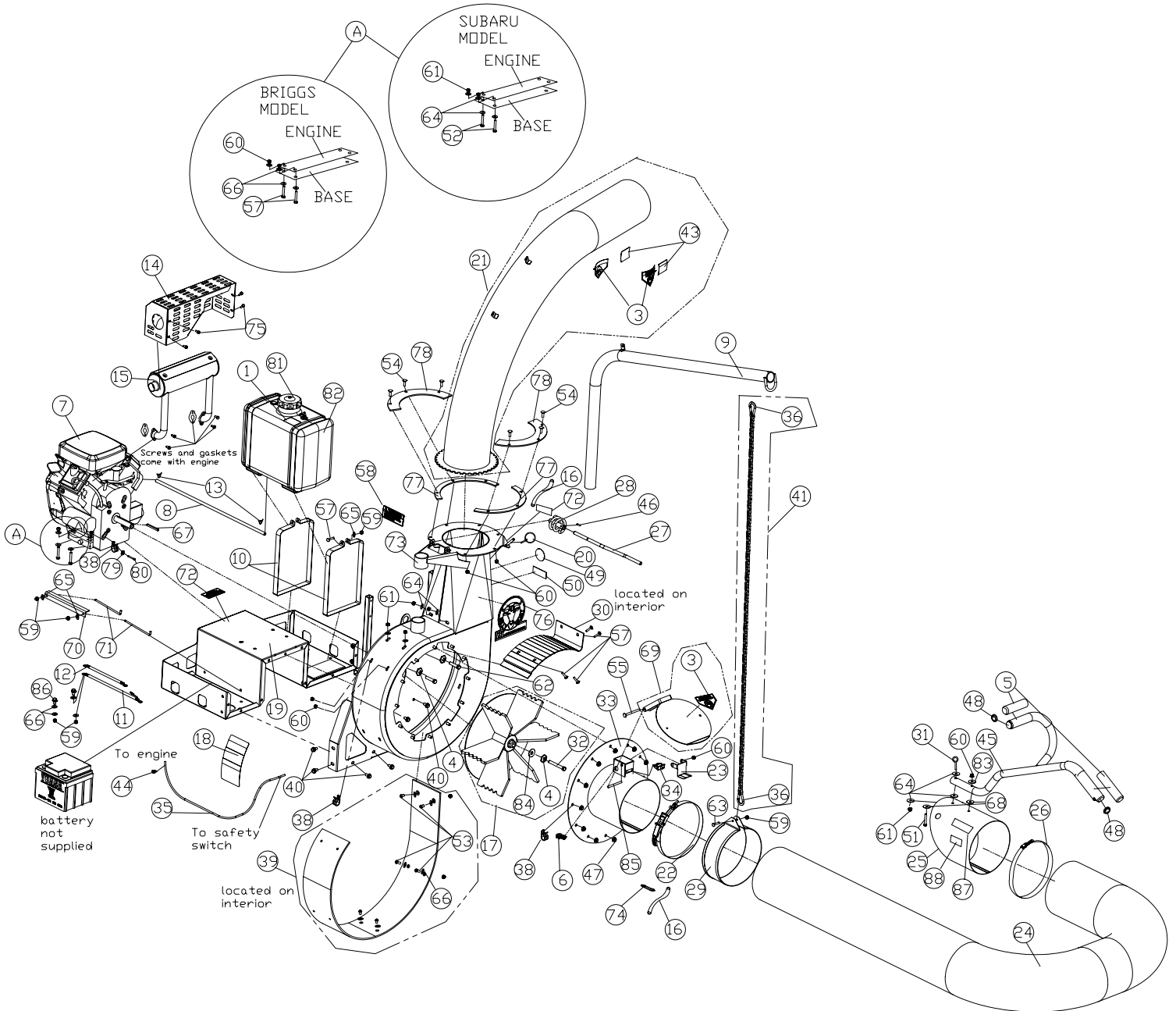



PARTS LIST

ITEM NO.	DESCRIPTION	DL25 PART NO.	QTY	DL18 PART NO.	QTY
1	LABEL WARNING EXPLOSIVE FUEL	468572	1	468572	1
2					
3	LABEL OPEI WARNING	400424	3	400424	3
4	WASHER TWISTED LOCK 7/16"	850132	3	850132	3
5	GRIP 1 1/4 ID X 9.5 LONG	440146	2	440146	2
6	STRAIN RELIEF HEYCO 1244	500252	1	500252	1
7	ENGINE 25 HP SUBARU	791119	1	-	-
	ENGINE 18 HP VANGUARD	-	-	791118	1
8	LINE FUEL DL	-	-	791060	1
9	TUBE BOOM ARM DL	791113	1	791113	1
10	CLAMP GAS TANK	791043	2	791043	2
11	CABLE BATTERY RED 26"	500304	1	500304	1
12	CABLE BATTERY BLACK 10"	790133	1	790133	1
13	CLAMP FUEL LINE	-	-	790134	2
14	EXHAUST GUARD	791045	1	791045	1
15	EXHAUST SUBARU	791042	1	-	-
	EXHAUST VANGUARD	-	-	791041	1
16	LAYNARD 10" PLASTIC	360243	2	360243	2
17	IMPELLER DL	791120-S	1	791120-S	1
18	LABEL DL INSTRUCT/WARN	790142	1	790142	1
19	BASE ENGINE ASSY DL	791100	1	791100	1
20	LYNCH PIN	520004	1	520004	1
21	ELBOW ASSY DL	791114-S	1	791114-S	1
22	CLAMP QUICK RELEASE 12"	791065	1	-	-
	CLAMP QUICK RELEASE 10"	-	-	791064	1
23	LEVER HOSE SWITCH	791068	1	791068	1
24	HOSE 12" x 10' INTAKE	791034	1	-	-
	HOSE 10" X 10' INTAKE	-	-	791033	1
25	NOZZLE INTAKE 12" FORMED	790149	1	-	-
	NOZZLE INTAKE 10" FORMED	-	-	811005	1
26	CLAMP HOSE 12"	790150-01	1	-	-
	CLAMP HOSE 10"	-	-	810706-01	1
27	SHAFT GEAR WORM	791038	1	791038	1
28	GEAR WORM	791109	1	791109	1
29	BAND HOSE BOOM 12" FORMED	790153	1	-	-
	BAND HOSE BOOM 10" FORMED	-	-	810868	1
30	CUT OFF LOADER	791020-S	1	791020-S	1
31	EYE BOLT	791081	1	791081	1
32	SCREWCAP 7/16-20X3 1/2" GR.8 WITH PATCH (TORQUE 60 ft.lb. (81.4N	440150	1	440150	1
33	INTAKE HOUSING DL 12"	791105	1	-	-
	INTAKE HOUSING DL 10"	-	-	791104	1
34	PLUNGE SWITCH	791095	1	791095	1
35	HARNNESS WIRE DL	791096	1	791096	1
36	HOOK SNAP SAFETY	791027	2	791027	2
37					
38	CLAMP FUEL HOSE LINE	791070	3	791070	3
39	INTERIOR LINER	791018-S	1	791018-S	1
40	WASHER FACE BOLT	791080	8	791080	8
41	CHAIN HANG HOSE DL	791117	1	791117	1
42					
43	LABEL FLYING DEBRIS	810736	2	810736	2
44	WIRE TAP IN	840215	1	840215	1
45	HANDLE NOZZLE	791116	1	791116	1
46	ROLL PIN .1875 X 0.875	8195162	1	8195162	1
47	NUT WASHER FACE	791079	12	791079	12
48	PLUG TUBE INSERT 1.25 OD	791056	2	791056	2
49	LABEL EAR EYE BREATHE	890254	1	890254	1
50	LABEL READ	890301	1	890301	1

ITEM NO.	DESCRIPTION	DL25 PART NO.	QTY	DL18 PART NO.	QTY
51	SCREWCAP 5/16-18 x 2	8041032	1	8041032	5
52	SCREWCAP 3/8-16 X 2	8041054	4	-	-
53	BUTTON HEAD 5/16-18 X 3/4	791078	10	791078	10
54	CARRIAGE BOLT 5/16x18x1	8024040	6	8024040	6
55	BOLT CARR. 5/16 - 18 x 3 1/2	*8024050	1	*8024050	1
56	CARRIAGE BOLT 3/8x16x1	8024058	4	8024058	4
57	CARRIAGE BOLT 1/4-20 X 1 3/4	8024025	2	8024025	2
58	LABEL WARNING ENGINE OVERHEAT	811215	1	811215	1
59	NUT LOCK 1/4"-20 HEX Z/P	*8160001	7	*8160001	7
60	NUT LOCK 5/16-18	*8160002	8	*8160002	12
61	NUT LOCK 3/8	*8160003	9	*8160003	5
62	SCREWCAP 7/16-14 X 2 GR 5 W/ PATCHLOC	790307	2	790307	2
63	SCREWCAP 1/4-20 x 1 1/2	8041008	1	8041008	1
64	WASHER FLAT 3/8	*8171004	15	*8171004	7
65	WASHER 1/4 SAE	*8172007	10	*8172007	18
66	WASHER 5/16 FLAT	8171003	16	8171003	16
67	KEY 1/4" SQ X 2 3/4"	9201125	1	9201125	1
68	WASHER 5/16 FENDER	*8172020	2	*8172020	2
69	DOOR FLAPPER INTAKE DL 12"	791103-S	1	-	-
	DOOR FLAPPER INTAKE DL 10"	-	-	791102-S	1
70	BRACKET BATTERY DL	790230	1	790230	1
71	ROD BATTERY HOLD DOWN	790231	2	790231	2
72	LABEL WARNING SECURE	790232	1	790232	1
73	HOUSING ASSY DL	791101-S	1	791101-S	1
74	SAFETY PIN	800365	1	800365	1
75	SCREW 1/4-20 X 5/8 HWH	390359	4	350359	4
76	LABEL DL	791099	1	791099	1
77	PLATE CLAMP SPLIT	791049	2	791049	2
78	PLATE CLAMP HALF	791047	2	791047	2
79	WASHER LOCK 5/16	8181008	1	8181008	1
80	SCREWCAP 5/16-24 X 3/4	8042026	1	8042026	1
81	CAP TANK FUEL 6 GAL	791074	1	791074	1
82	TANK FUEL 6 GAL	791035	1	791035	1
83	WASHER 5/16 SAE	8172008	1	8172008	1
84	WASHER 1.5 OD X .453 ID X .5	440176	1	440176	1
85	SPACER 3/8 X 2 1/2	900503	1	900503	1
86	SCREWCAP 1/4-20 x 3/4	8041004	2	8041004	2
87	LABEL NOZZLE SECURE	811215	1	811215	1
88	LABEL WARNING NOZZLE	790301	1	790301	1

Free Manuals Download Website

<http://myh66.com>

<http://usermanuals.us>

<http://www.somanuals.com>

<http://www.4manuals.cc>

<http://www.manual-lib.com>

<http://www.404manual.com>

<http://www.luxmanual.com>

<http://aubethermostatmanual.com>

Golf course search by state

<http://golfingnear.com>

Email search by domain

<http://emailbydomain.com>

Auto manuals search

<http://auto.somanuals.com>

TV manuals search

<http://tv.somanuals.com>