

BenQ

MP620c Digital Projector

Mainstream Series

User Manual

Welcome

Copyright

Copyright 2007 by BenQ Corporation. All rights reserved. No part of this publication may be reproduced, transmitted, transcribed, stored in a retrieval system or translated into any language or computer language, in any form or by any means, electronic, mechanical, magnetic, optical, chemical, manual or otherwise, without the prior written permission of BenQ Corporation.

Disclaimer

BenQ Corporation makes no representations or warranties, either expressed or implied, with respect to the contents hereof and specifically disclaims any warranties, merchantability or fitness for any particular purpose. Further, BenQ Corporation reserves the right to revise this publication and to make changes from time to time in the contents hereof without obligation to notify any person of such revision or changes.

*DLP, Digital Micromirror Device and DMD are trademarks of Texas Instruments. Others are copyrights of their respective companies or organizations.

Table of contents

Important safety instructions	1
Introduction	5
Projector features	5
Shipping contents	6
Projector exterior view	7
Controls and functions	8
Positioning your projector	12
Choosing a location	12
Safety instructions for ceiling mounting of the projector	13
Obtaining a preferred projected image size	14
Connection	17
Wireless connection (optional)	17
Cable connection	17
Operation	25
Start up	25
Utilizing the password function	26
Switching input signal	28
Adjusting the projected image	28
Selecting the aspect ratio	30
Selecting a picture mode	31
Hiding the image	32
Creating your own startup screen - MyScreen function	32
Activating panel key lock	34
Setting the presentation timer	35
Freezing the image	35
Utilizing FAQ function	36
Shutting down the projector	36
Menu operation	37
Maintenance	46
Care of the projector	46
Lamp information	47

Troubleshooting	53
Specifications	54
Projector specifications	54
Timing chart	55
Dimensions	56
Warranty	57
Limited warranty	57
Regulation statements	58
FCC statement	58
EEC statement	58
WEEE directive	58

1 Important safety instructions

Your BenQ projector is designed and tested to meet the latest standards for safety of information technology equipment. However, to ensure safe use of this product, it is important that you follow the instructions mentioned in this manual and marked on the product.

Safety Instructions

1. **Please read this manual before you operate your projector.** Save it for future reference.

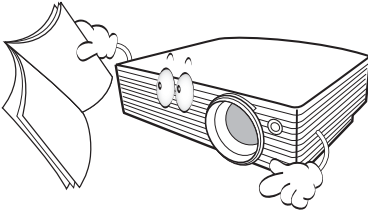

2. **Do not look straight at the projector lens during operation.** The intense light beam may damage your eyes.

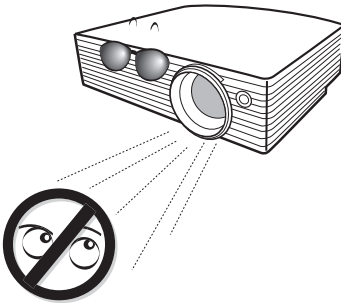

3. **Refer servicing to qualified service personnel.**

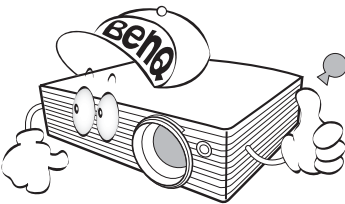

4. **Always open the lens shutter or remove the lens cap when the projector lamp is on.**

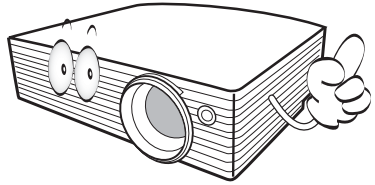

5. In some countries, the line voltage is NOT stable. This projector is designed to operate safely within a mains voltage between 100 to 240 volts AC, but could fail if power cuts or surges of ± 10 volts occur. **In areas where the mains voltage may fluctuate or cut out, it is recommended that you connect your projector through a power stabilizer, surge protector or uninterruptible power supply (UPS).**

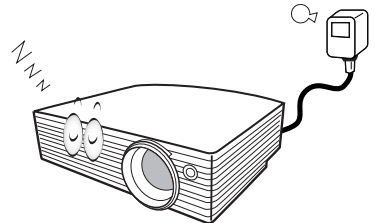

6. Do not block the projection lens with any objects when the projector is under operation as this could cause the objects to become heated and deformed or even cause a fire. To temporarily turn off the lamp, press **BLANK** on the projector or remote control.

Safety Instructions (Continued)

12. Do not place this projector in any of the following environments.
- Space that is poorly ventilated or confined. Allow at least 50 cm clearance from walls and free flow of air around the projector.
 - Locations where temperatures may become excessively high, such as the inside of a car with all windows rolled up.
 - Locations where excessive humidity, dust or cigarette smoke may contaminate optical components, shortening the projector's life span and darkening the image.

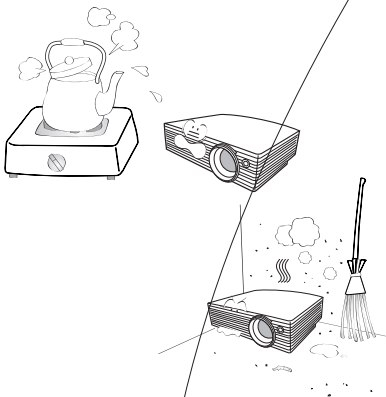

- Locations near fire alarms
- Locations with an ambient temperature above 40°C / 104°F
- Locations where the altitudes are higher than 10000 feet.

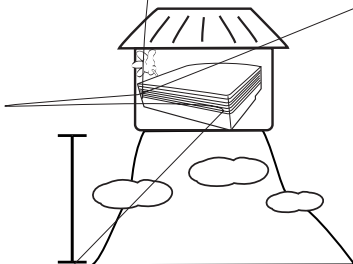

13. Do not block the ventilation holes.
- Do not place this projector on a blanket, bedding or any other soft surface.
 - Do not cover this projector with a cloth or any other item.
 - Do not place inflammables near the projector.

If the ventilation holes are seriously obstructed, overheating inside the projector may result in a fire.

14. Always place the projector on a level, horizontal surface during operation.
- Do not use if tilted at an angle of more than 10 degrees left to right, nor at angle of more than 15 degrees front to back. Using the projector when it is not fully horizontal may cause a malfunction of, or damage to, the lamp.

15. Do not stand the projector on end vertically. Doing so may cause the projector to fall over, causing injury or resulting in damage to the projector.

Safety Instructions (Continued)

16. Do not step on the projector or place any objects upon it. Besides probable physical damage to the projector, doing so may result in accidents and possible injury.

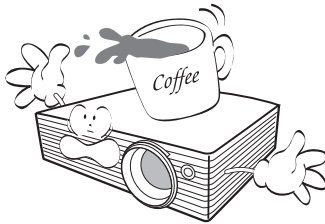

17. Do not place liquids near or on the projector. Liquids spilled into the projector may cause it to fail. If the projector does become wet, disconnect it from the power supply's wall socket and call BenQ to have the projector serviced.

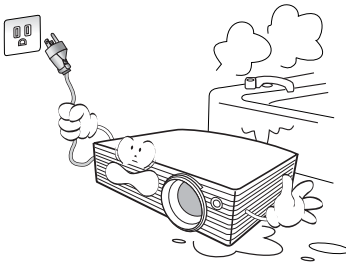

18. This product is capable of displaying inverted images for ceiling mount installation.



Use only BenQ's Ceiling Mount Kit for mounting the projector and ensure it is securely installed.

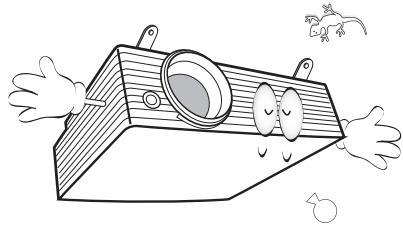

19. When the projector is under operation, you may sense some heated air and odor from its ventilation grill. It is a normal phenomenon and not a product defect.

2 Introduction

Projector features

The projector integrates high-performance optical engine projection and a user-friendly design to deliver high reliability and ease of use.

The projector offers the following features.

- Selectable password protected function
 - Compact and portable unit
 - High quality manual zoom lens
 - One-key auto-adjustment to display the best picture quality
 - Digital keystone correction to correct distorted images
 - Adjustable color balance control for data/video display
 - Ultra-high brightness projection lamp
 - Ability to display 16.7 million colors
 - Multi-language On-Screen Display (OSD) menus
 - Switchable normal and Economic modes to reduce the power consumption
 - Built-in speaker provides mixed mono audio when an audio input is connected
 - Powerful AV function to provide high quality video image
 - Component HDTV compatibility (YPbPr)
-  • **The apparent brightness of the projected image will vary depending on the ambient lighting conditions, selected input source contrast/brightness settings, and is directly proportional to projection distance.**
- **The lamp brightness will decline over time and may vary within the lamp manufacturers specifications. This is normal and expected behavior.**

Shipping contents

The projector is shipped with the cables required for connection to a PC or video equipment. Carefully unpack and verify that you have all of the items shown below. If any of these items are missing, please contact your place of purchase.

Standard accessories

 **The supplied accessories will be suitable for your region, and may differ from those illustrated.**

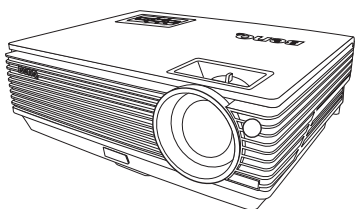

Projector



Soft carry case



Quick start
guide



User manual
CD



User manual

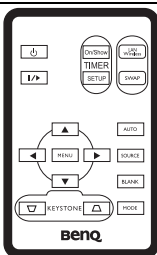

Remote control with batteries

 **Pull the tab before using the remote control**

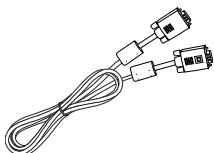
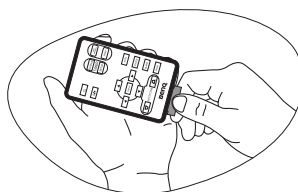

VGA cable

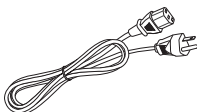

Power cord



Video cable

Optional accessories

Projector exterior view

Front/upper side

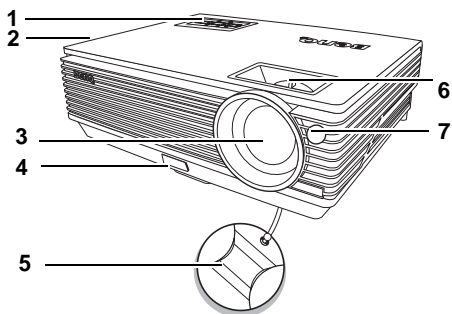

1. External control panel
(See "Projector" on page 8 for details.)
2. Vent (heated air exhaust)
3. Projection lens
4. Quick-release button
5. Lens cap
6. Focus ring and Zoom ring
7. Front IR remote sensor

Rear side

See "Connection" on page 17 for details.

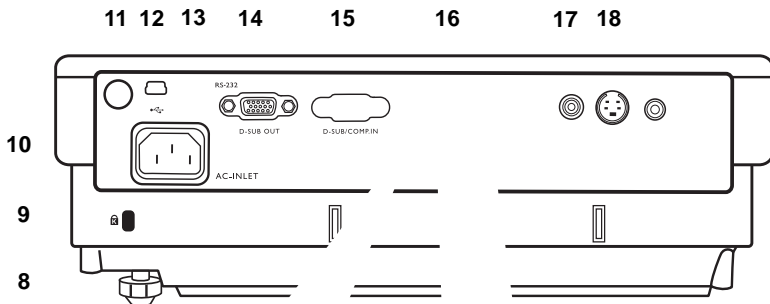

- | | |
|---|---|
| <ol style="list-style-type: none"> 8. Rear adjuster foot 9. Kensington anti-theft lock 10. AC power cord inlet 11. Rear IR remote sensor 12. USB socket 13. RS232 control 14. RGB signal | <ol style="list-style-type: none"> 15. Component video (YPbPr) signal input socket 16. S-video input socket 17. Video input socket 18. Audio input socket |
|---|---|

Lower/side

Controls and functions

Projector

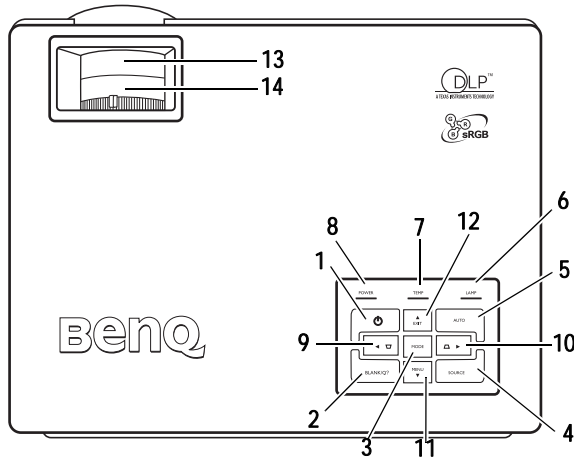

- 1. Power** (Refer to ["Start up" on page 25](#) and ["Shutting down the projector" on page 36](#) for more information.)
Turns the projector on or off.
- 2. Blank/Q?** (Refer to ["Hiding the image" on page 32](#) and ["Utilizing FAQ function" on page 36](#) for more information.)
Used to hide the screen image. You can press any key on the control panel to bring the image back.
To start FAQ function, press and hold for 3 seconds.
- 3. Mode** (Refer to ["Selecting a picture mode" on page 31](#) for more information.)
Sequentially selects a predefined picture setting available for each input.
When a wireless module is installed and the Wireless Connection menu is displayed, press this button to change among LAN, IEEE 802.11 a, and IEEE 802.11 b/g. (The wireless module is available through BenQ retailers.)
- 4. Source** (Refer to ["Switching input signal" on page 28](#) for more information.)
Sequentially selects the input signal RGB, Component Video, S-Video, Video or DVI-I.
- 5. Auto** (Refer to ["Auto-adjusting the image" on page 29](#) for more information.)
Automatically determines the best picture timings for the selected input.
When a wireless module is installed, the Wireless Connection menu is displayed and the IEEE 802.11 a is selected, press this button to search for a reliable channel. (The wireless module is available through BenQ retailers.)
- 6. Lamp indicator light** (Refer to ["Indicators" on page 51](#) for more information.)
Indicates the status of the lamp. Lights up or flashes when the lamp has developed a problem.
- 7. Temperature warning light** (Refer to ["Indicators" on page 51](#) for more information.)
Flashes red if the projector's temperature becomes too high.

8. **Power indicator light** (Refer to **"Indicators"** on page 51 for more information.)
Lights up or flashes when the projector is under operation.
9. **3 Left**
10. **Right 4** (Refer to **"Correcting keystone"** on page 29 for more information.)
When the on-screen menu is not activated, #9 and #10 function as **Keystone -/+** hot keys.
11. **6 Menu** (Refer to **"Using the menus"** on page 38 for more information.)
Turns on the on-screen display control menu.
12. **5 Exit**
Exits and saves the menu settings.
When the on-screen menu is activated, the #9 to #12 buttons are used as directional arrows to select the desired menu items and to make adjustments.
13. **Focus ring** (Refer to **"Fine-tuning the image size and clarity"** on page 29 for more information.)
Adjusts the focus of the projected image.
14. **Zoom ring** (Refer to **"Fine-tuning the image size and clarity"** on page 29 for more information.)
Adjusts the size of the image. Rotate clockwise to enlarge the image or rotate counter-clockwise to reduce the image size.

Remote control

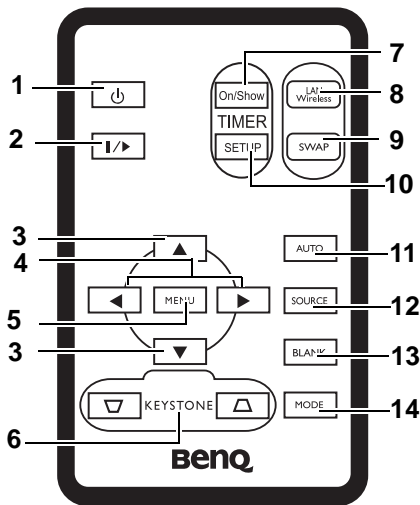

1. **Power** (Refer to **"Start up"** on page 25 and **"Shutting down the projector"** on page 36 for more information.)
Turns the projector on or off.
2. **Freeze**
The image is frozen when **Freeze** is pressed. An icon "■" will display in the lower right corner of the screen. To release the function, press **Freeze** again.
3. **5 Up, 6 Down**

4. **3 Left, Right**
When the on-screen menu is activated, the 5 **Up**, 6 **Down**, 3 **Left** and **Right** buttons are used as directional arrows to select the desired menu items and to make adjustments.
5. **Menu (Refer to "Using the menus" on page 38 for more information.)**
Displays or hides the On-Screen Display (OSD) menu system.
6.  **Keystone** (Refer to page "Correcting keystone" on page 29 for more information.)
Manually corrects distorted images resulting from an angled projection.
7. **Timer On/Show (Refer to "Setting the presentation timer" on page 35 for more information.)**
A multifunctional key that activates, displays or hides on-screen timer based on your own timer setting.
8. **LAN/Wireless (Refer to "Wireless connection (optional)" on page 17 for more information.)**
When a wireless module is installed and the Wireless Connection menu is displayed, press this button to toggle between LAN or Wireless connection modes. (The wireless module is available through BenQ retailers.)
9. **SWAP (Refer to "Wireless connection (optional)" on page 17 for more information.)**
When a wireless module is installed and the Wireless Connection menu is displayed, press this button to change the wireless connection mode between IEEE 802.11 a and IEEE 802.11 b/g. (The wireless module is available through BenQ retailers.)
10. **Timer Setup (Refer to "Setting the presentation timer" on page 35 for more information.)**
Enters presentation timer setting directly.
11. **Auto (Refer to "Auto-adjusting the image" on page 29 for more information.)**
Automatically determines the best picture settings for the displayed image.
12. **Source (Refer to "Switching input signal" on page 28 for more information.)**
Sequentially selects the input signal RGB, Component Video, S-Video, Video or DVI-I.
13. **Blank (Refer to "Hiding the image" on page 32 for more information.)**
Used to hide the screen image. Press any key on the remote control to restore the image.
14. **Mode (Refer to "Selecting a picture mode" on page 31 for more information.)**
Sequentially selects a predefined picture setting available for each input.

Remote control effective range

Infra-Red (IR) remote control sensors are located on the front and the back of the projector. The remote control must be held at an angle within 30 degrees perpendicular to the projector's IR remote control sensors to function correctly. The distance between the remote control and the sensors should not exceed 6 meters (~ 20 feet).

Make sure that there are no obstacles between the remote control and the IR sensors on the projector that might obstruct the infra-red beam.

- **Operating the projector from the front**

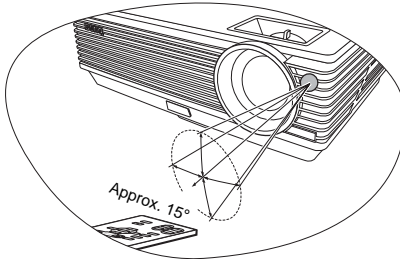

- **Operating the projector from the rear**

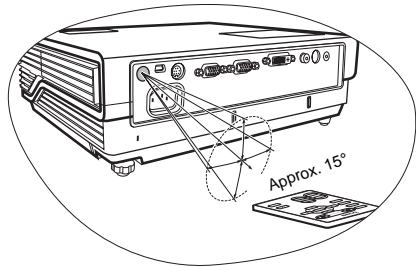

Replacing the remote control battery

1. Pull out the battery holder.

 **Please follow the illustrated instructions. Push and hold the locking arm whilst pulling out the battery holder.**

2. Insert the new battery in the holder. Note the positive polarity should face outward.
3. Push the holder into the remote control.



- **Avoid excessive heat and humidity.**
- **There may be battery damage if the battery is incorrectly replaced.**
- **Replace only with the same or equivalent type recommended by the battery manufacturer.**
- **Dispose of the used battery according to the battery manufacturer's instructions.**
- **Never throw a battery into a fire. There may be danger of an explosion.**
- **If the battery is dead or if you will not be using the remote control for a long time, remove the battery to prevent damage to the remote control from possible battery leakage.**

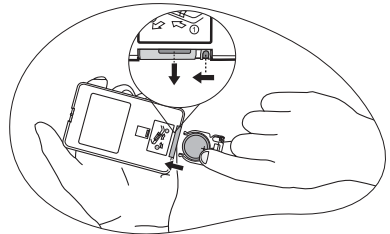





3 Positioning your projector

Choosing a location

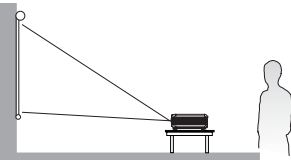
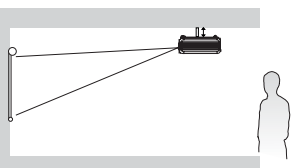
Your projector is designed to be installed in one of four possible installation locations:

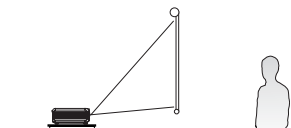
1. Table in front of screen;
2. Ceiling in front of screen;
3. Table at rear of screen;
4. Ceiling at rear of screen.

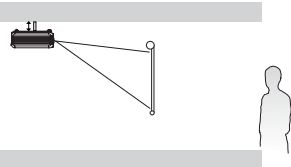
<p>1. Front Table Select this location with the projector placed near the floor in front of the screen. This is the most common way to position the projector for quick setup and portability.</p>	
<p>2. Front Ceiling Select this location with the projector suspended upside-down from the ceiling in front of the screen. Purchase the BenQ Projector Ceiling Mounting Kit from your dealer to mount your projector on the ceiling.</p>	
<p>Set  in the Advanced > Mirror menu after you turn the projector on.</p> <p>3. Rear Table Select this location with the projector placed near the floor behind the screen. Note that a special rear projection screen is required.</p>	
<p>Set  in the Advanced > Mirror menu after you turn the projector on.</p> <p>4. Rear Ceiling Select this location with the projector suspended upside-down from the ceiling behind the screen. Note that a special rear projection screen and the BenQ Projector Ceiling Mounting Kit are required for this installation location.</p> <p>Set  in the Advanced > Mirror menu after you turn the projector on.</p>	

Your room layout or personal preference will dictate which installation location you select. Take into consideration the size and position of your screen, the location of a suitable power outlet, as well as the location and distance between the projector and the rest of your equipment.

Safety instructions for ceiling mounting of the projector

We want you to have a pleasant experience using your BenQ projector, so we need to bring this safety matter to your attention to prevent possible damage to person and property.

If you intend to mount your projector on the ceiling, we strongly recommend that you use a

Obtaining a preferred projected image size

The distance from the projector lens to the screen, the zoom setting, and the video format each factors in the projected image size.

The native resolution of the projector is 1024 x 768 pixels, which is a 4 to 3 aspect ratio (expressed as 4:3). To be able to project a complete 16:9 (widescreen) aspect ratio image, the projector can resize and scale a widescreen image to the projector's native aspect width. This will result in a proportionally smaller height equivalent to 75% of the projector's native aspect height.

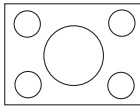

4:3 aspect image in a 4:3 aspect display area

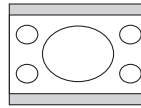

16:9 aspect image scaled to a 4:3 aspect display area

Thus, a 16:9 aspect image will not utilize 25% of the height of a 4:3 aspect image displayed by this projector. This will be seen as darkened (unlit) bars along the top and bottom (vertical 12.5% height respectively) of the 4:3 projection display area whenever displaying a scaled 16:9 aspect image in the vertical center of the 4:3 projection display area.

When determining the position of your projector, you should consider its intended use and input signal aspect ratios. All inputs (other than composite Video being fed a 16:9 aspect signal) will display in a 4:3 aspect ratio (and will require an additional 33% display height than that of the scaled 16:9 aspect image projection area).

IMPORTANT: Do not select a permanent projector position based upon a 16:9 projection if you will ever need to select an input (other than composite Video being fed a 16:9 aspect signal).

The projector should always be placed horizontally level (like flat on a table), and positioned directly perpendicular (90° right-angle square) to the horizontal center of the screen. This prevents image distortion caused by angled projections (or projecting onto angled surfaces).

The modern digital projector does not project directly forward (like older style reel-to-reel film projectors did). Instead, digital projectors are designed to project at a slightly upward angle above the horizontal plane of the projector. This is so that they can be readily placed on a table and will project forward and upwards onto a screen positioned so that the bottom edge of the screen is above the level of the table (and everyone in the room can see the screen).

If the projector is mounted on a ceiling, it must be mounted upside-down so that it projects at a slightly downward angle.

You can see from the diagram on page 16, that this type of projection causes the bottom edge of the projected image to be vertically offset from the horizontal plane of the projector. When ceiling mounted, this refers to the top edge of the projected image.

If the projector is positioned further away from the screen, the projected image size increases, and the vertical offset also increases proportionately.

When determining the position of the screen and projector, you will need to account for both the projected image size and the vertical offset dimension, which are directly proportional to the projection distance.

BenQ has provided a table of 4:3-aspect-ratio screen sizes to assist you in determining the ideal location for your projector. There are two dimensions to consider, the perpendicular horizontal distance from the center of the screen (projection distance), and the vertical offset height of the projector from the horizontal edge of the screen (offset).

How to determine the position of the projector for a given screen size

1. Select your screen size.
2. Refer to the table and find the closest match to your screen size in the left columns labelled '4:3 Screen Diagonal'. Using this value, look across this row to the right to find the corresponding average distance from screen value in the column labelled 'Average'. This is the projection distance.
3. On that same row, look across to the right column and make note of the vertical Offset value. This will determine the final vertical offset placement of the projector in relation to the edge of the screen.
4. The recommended position for the projector is aligned perpendicular to the horizontal center of the screen, at the distance from the screen determined in step 2 above, and offset by the value determined in step 3 above.

For example, if you are using a 120 inch screen, the average projection distance is 4467 mm and with a vertical offset of 183 mm.

If you place the projector in a different position (to that recommended), you will have to tilt it down or up to center the image on the screen. In these situations, some image distortion will occur. Use the Keystone function to correct the distortion. See "[Correcting keystone](#)" on [page 29](#) for details.

How to determine the recommended screen size for a given distance

This method can be used for situations where you have purchased this projector and would like to know what screen size will fit in your room.

The maximum screen size is limited by the physical space available in your room.

1. Measure the distance between the projector and where you want to position the screen. This is the projection distance.
2. Refer to the table and find the closest match to your measurement in the average distance from screen column labelled 'Average'. Check that your measured distance is between the min and max distances listed on either side of the average distance value.
3. Using this value, look across that row to the left to find the corresponding screen diagonal listed in that row. That is the projected image size of the projector at that projection distance.
4. On that same row, look across to the right column and make note of the vertical Offset value. This will determine the final placement of the screen in relation to the horizontal plane of the projector.

For example, if your measured projection distance was 4.5m (4500mm), the closest match in the Average column is 4593 mm. Looking across this row shows that a 3000 mm (3 m) screen is required. If you can only obtain imperial sized screens, the listed screen sizes on either side of the 3 m screen are the 9' and 10' screens.

Checking the min and max projection distance values for these screen sizes, indicates that the 4.5 m measured projection distance will need to be reduced to fit the 9' size screen, or increased to fit the 10' size screen. The projector can be adjusted (using the zoom control) to display on these different screen sizes at those projection distances. Be aware that these different screens have different vertical offset values.

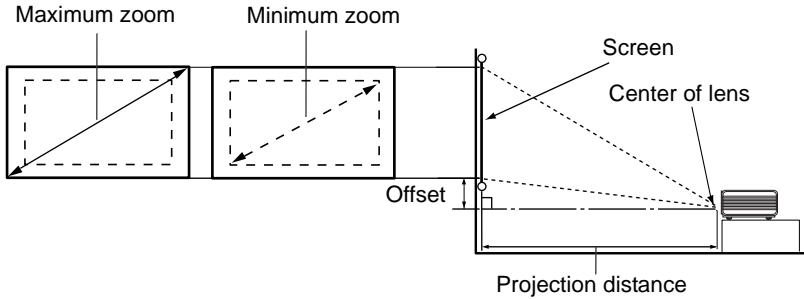

4:3 Screen Diagonal			Distance from Screen in mm			Vertical Offset in mm
Feet	Inches	mm	Min length (with max. zoom)	Average	Max length (with min. zoom)	
4	48	1219	1778	1867	1956	73
		1500	2187	2297	2406	90
5	60	1524	2222	2333	2444	91
		1829	2667	2800	2933	110
6	72	2000	2916	3062	3208	120
		2134	3111	3267	3422	128
8	96	2438	3556	3733	3911	146
		2500	3645	3828	4010	150
9	108	2743	4000	4200	4400	165
		3000	4347	4593	4812	180
10	120	3048	4444	4667	4889	183
		3500	5104	5359	5614	210
12	144	3658	5334	5601	5867	219
		4000	5833	6124	6416	240
15	180	4572	6667	7000	7333	274
		5000	7291	7655	8020	300
18	216	5486	7999	8399	8799	329
		6000	8749	9186	9624	360
25	300	7620	11111	11667	12222	457

ⓘ There is 3% tolerance among these numbers due to optical component variations. BenQ recommends that if you intend to permanently install the projector, you should physically test the projection size and distance using the actual projector in situ before you permanently install it, so as to make allowance for this projector's optical characteristics. This will help you determine the exact mounting position so that it best suits your installation location.

Connection

When connecting a signal source to the projector, be sure to:

1. Turn all equipment off before making any connections.
2. Use the correct signal cables for each source.
3. Ensure the cables are firmly inserted.

In the connections shown below, some cables may not be included with the projector (see "[Shipping contents](#)" on page 6). They are commercially available from electronics stores.

Wireless connection (optional)

The Wireless module allows for simultaneous wireless connectivity to multiple computers which are wireless enabled. This saves you from having to swap data cables between the projector and different computers during a presentation. Wireless connectivity is most suitable for situations where multiple presenters with separate notebooks are required to seamlessly present individual presentations, like in meetings, conferences, lectures and, classrooms.

Even though the Wireless module is not attached to the projector, everytime the projector is turned on, the status of wireless connection will display on the screen while the projector is searching for input signals during the start up procedure.

The Wireless module connects and att

Laptop or desktop computer

Connecting a monitor

If you want to view your presentation close-up on a monitor as well as on the screen, you can connect the RGB signal output socket on the projector to an external monitor with a VGA cable following the instructions below:

1. Connect the projector to a computer as described in "[Connecting a computer](#)" on page 17.
 2. Take a suitable VGA cable (only one supplied) and connect one end of the cable to the D-Sub input socket of the video monitor.
 3. Connect the other end of the cable to the D-SUB OUT socket on the projector.
- The final connection path should be like that shown in the following diagram:

Laptop or desktop computer

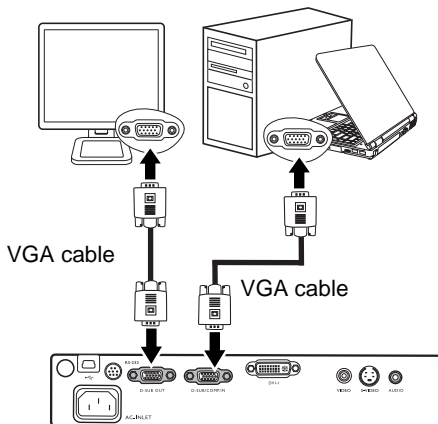

 The D-Sub output only works when an appropriate D-Sub input is made to the projector.

Connecting Video source devices

This section describes how to connect the projector to Video source devices using video cables. Video cable connections are recommended for Video presentations.

 **This projector also supports data (graphic) "PC" connection using wireless function. Wireless connection is not recommended for Video presentations. See ["Wireless connection \(optional\)" on page 17](#).**

You can connect your projector to various Video source devices that provide any one of the following output sockets:

- DVI
- Component Video
- S-Video
- Video (composite)

You need only connect the projector to a Video source device using just one of the above connecting methods, however each provides a different level of video quality. The method you choose will most likely depend upon the availability of matching terminals on both the projector and the Video source device as described below:

Best video quality

The best available video connection method is DVI. If your source device is equipped with a DVI socket, based on the type of DVI connector you have, you can enjoy digital or high-end analog video quality.

See ["Connecting a Component Video source device" on page 21](#) for how to connect the projector to a DVI source device and other details.

If no DVI source is available, the next best video signal is Component Video (not to be confused with composite Video). Digital TV tuners and DVD players output Component Video natively, so if available on your devices, they should be your connection method of choice in preference to S-Video or (composite) Video.

See ["Connecting a Component Video source device" on page 21](#) for how to connect the projector to a component video device.

Better video quality

The S-Video method provides a better quality analog video than standard composite Video. If you have both composite Video and S-Video output terminals on your Video source device, you should elect to use the S-Video option.

See ["Connecting an S-Video source device" on page 23](#) for how to connect the projector to an S-Video device.

Least video quality

Composite Video is an analog video and will result in a perfectly acceptable, but less than optimal result from your projector, being the least video quality of the available methods described here.

See ["Connecting a composite Video source device" on page 24](#) for how to connect the projector to a composite Video device.

Connecting Audio

The projector has a built-in mono speaker which is designed to provide basic audio functionality accompanying data presentations for business purposes only. It is not designed for, nor intended for stereo audio reproduction use as might be expected in home theatre or home cinema applications. Any stereo audio input (if provided), is mixed into a common mono audio output through the projector speaker.

If you have a separate sound system, you will most likely want to connect the audio output of your Video source device to that sound system, instead of to the mono audio projector. The audio connections illustrated in the following sections are provided for informational purposes only. You need not connect audio to the projector if there is an alternate sound system available, or if audio is not required.

Connecting a Component Video source device

Examine your Video source device to determine if it has a set of unused Component Video output sockets available:

- If so, you can continue with this procedure.
- If not, you will need to reassess which method you can use to connect to the device.

To connect the projector to a Component Video source device through a Component Video to VGA (D-Sub) adaptor cable:

<ul style="list-style-type: none"> • With a Component Video to VGA (D-Sub) adaptor cable: 	<ul style="list-style-type: none"> • With a DVI cable:
<ol style="list-style-type: none"> 1. Take the (optional accessory) Component Video to VGA (D-Sub) adaptor cable and connect the end with 3 RCA type connectors to the Component Video output sockets of the Video source device. Match the color of the plugs to the color of the sockets; green to green, blue to blue; and red to red. 2. Connect the other end of the Component Video to VGA (D-Sub) adaptor cable (with a D-Sub type connector) to the D-SUB/COMP IN socket on the projector. 	<ol style="list-style-type: none"> 1. Take a DVI cable and connect one end of the cable to the DVI output socket of the Video source device. 2. Connect the other end of the cable to the DVI-I socket on the projector.
<ol style="list-style-type: none"> 3. If you wish to make use of the projector (mixed mono) speaker, take a suitable audio cable and connect one end of the cable to the audio output socket of the computer, and the other end to the Audio socket of the projector. 	

The final connection path should be like that shown in the following diagram:

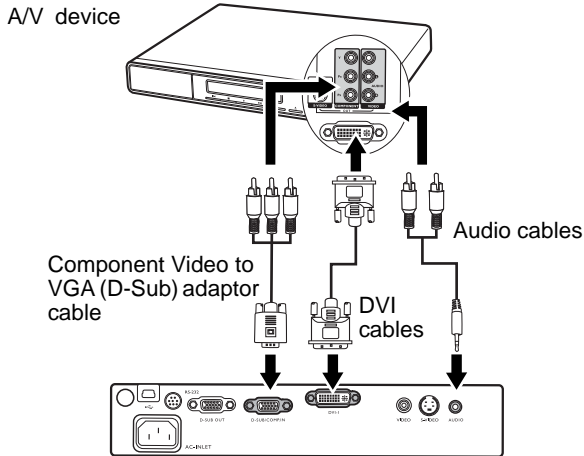

- **The projector is only capable of playing mixed mono audio, even if a stereo audio input is connected. See ["Connecting Audio" on page 20](#) for details.**
- **Component Video is the only video output that delivers native 16:9 aspect ratio picture.**

If you connect the projector to a High Definition TV (HDTV) tuner, the following standards are supported:

- 480i
- 480p
- 576i
- 576p
- 720p (50/ 60 Hz)
- 1080i (50/ 60 Hz)

- **If the selected video image is not displayed after the projector is turned on and the correct video source has been selected, check that the Video source device is turned on and operating correctly. Also check that the signal cables have been connected correctly.**

Connecting an S-Video source device

Examine your Video source device to determine if it has an unused S-Video output socket available:

- If so, you can continue with this procedure.
- If not, you will need to reassess which method you can use to connect to the device.

To connect the projector to an S-Video source device:

1. Take the (optional accessory) S-Video cable and connect one end to the S-Video output socket of the Video source device.
2. Connect the other end of the S-Video cable to the S-VIDEO socket on the projector.
3. If you wish to make use of the projector (mixed mono) speaker, take a suitable audio cable and connect one end of the cable to the audio output socket of the computer, and the other end to the Audio socket of the projector.

The final connection path should be like that shown in the following diagram:

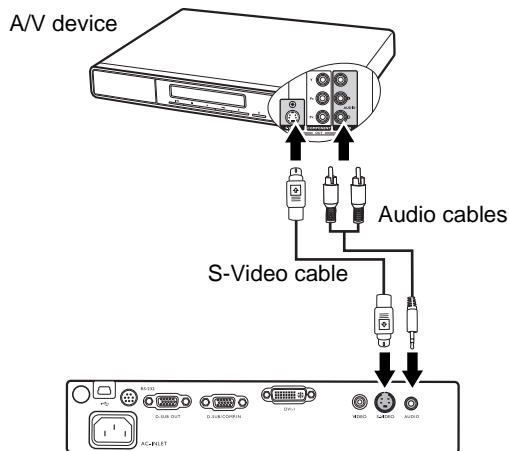

- ☞ • **The projector is only capable of playing mixed mono audio, even if a stereo audio input is connected. See "[Connecting Audio](#)" on page 20 for details.**
- **If the selected video image is not displayed after the projector is turned on and the correct video source has been selected, check that the Video source device is turned on and operating correctly. Also check that the signal cables have been connected correctly.**
- **If you have already made a Component Video connection between the projector and this S-Video source device using Component Video connections, you need not connect to this device using an S-Video connection as this makes an unnecessary second connection of poorer picture quality. See "[Connecting Video source devices](#)" on page 20 for details.**

Video source device

Use if it has a set of unused composite Video

ports.

Method you can use to connect to the device.

Using a Video source device:

1. Turn off the projector and connect one end to the composite Video

ports to the VIDEO socket on the projector.

2. For a (mixed mono) speaker, take a suitable audio

connector from the audio socket of the computer,

and connect it to the AUDIO socket of the projector. See the following diagram:

AV



3. Turn on the projector. If you are using a (mixed mono) speaker, turn on the speaker. For

more information on how to connect a video source device, see [page 20](#) for details. Note that the projector is turned on and the video source device is turned on only after the signal cables have been connected.

4. If you are using a composite Video connection if Component Video is not available, see ["Connecting Video source"](#) for use. See ["Connecting Video source"](#)

5 Operation

Start up

1. Plug the power cord into the projector and into a wall socket. Turn on the wall socket switch (where fitted). Check that the **Power indicator** on the projector lights orange after power has been applied..

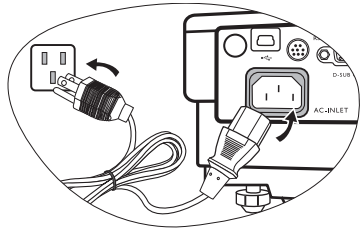

2. Remove the lens cap. If it is left on, it could become deformed due to the heat produced by the projector lamp.

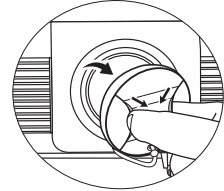



3. Press and hold (for 2 seconds)

 **Power** on the projector or remote control to start the projector. As soon as the lamp lights up, a "Power On Tone" will be heard. The **Power indicator light** flashes green and stays green when the projector is on.

The start up procedure takes about 30 seconds. In the later stage of start up, a startup logo is projected.

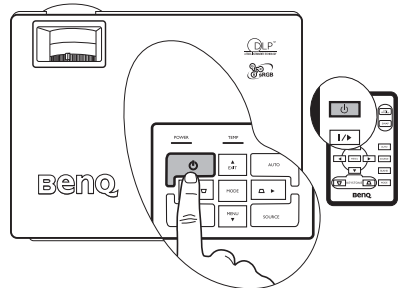
(If necessary) Rotate the focus ring to adjust the image clearness.



-  • **If you don't want to activate Power on/off tone, you can enter the OSD menu to disable this function. See "Mute (off)" on page 42 for details.**

- **If the projector is still hot from previous activity, it will run the cooling fan for approximately 90 seconds before energizing the lamp.**

4. If you are prompted for a password, press the arrow buttons to enter a four digit password. See "[Utilizing the password function](#)" on page 26 for details.

5. Switch on all of the connected equipment.

The projector will start to search for input signals. The current input source being scanned displays in the center of the screen. The searching message will continue displaying until an input source signal is found.

You can press **SOURCE** on the projector or remote control to select your desired input signal. See "[Switching input signal](#)" on page 28 for details.

-  • **A message of "Resolution Reminding" will display when the projector detects that the resolution of the input source is not XGA.**

- If the frequency/resolution of the input signal exceeds the projector's operating range, you will see the message 'Out of Range' displayed on a blank screen.

Utilizing the password function

For security purposes and to help prevent unauthorized use, the projector includes an option for setting up password security. The password can be set through the On-Screen Display (OSD) menu. For details of the OSD menu operation, please refer to "[Using the menus](#)" on page 38.

WARNING: You will be inconvenienced if you activate the password functionality and subsequently forget the password. Print out this manual (if necessary) and write the password you used in this manual, and keep the manual in a safe place for later recall.

Setting a password

Once a password has been set and activated, the projector cannot be used unless the correct password is entered every time the projector is started.

1. Open the OSD menu and go to **Setting > Password.** Sel65(t2.4a27yc-0.00 Tc411 0 TD06

If you forget the password

You will be asked to enter the four digit password every time you turn on the projector. If you enter the wrong password, the password error message displays. You can retry by pressing **Up 5** , or if you did not record the password in this manual, and you absolutely do not remember it, you can use the password recall procedure.

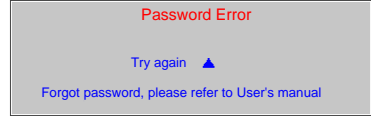

Entering the password recall procedure

Press and hold **Right4** on the projector for 3 seconds. The projector will display 4 sets of coded number on the screen. Write down the number and turn off your projector. Seek help from the local BenQ service center to decode the number. You may be required to provide proof of purchase documentation to verify that you are an authorized user of the projector.

Changing the password

1. Open the on-screen menu and go to  **Setting > Change Password**.
2. Press **Left 3** or **Right4** .
3. Enter the old password.
 - i. If the password is correct, you can go on to enter new password.
 - ii. If the password is incorrect, a "Password Error" message displays. Press **Up 5** to try again or press **Down 6** to cancel.
4. Enter a new password.

 **IMPORTANT: The digits being input will display as asterisks on-screen. Write your selected password down here in this manual in advance or right after the password is entered so that it is available to you should you ever forget it.**

Password: _ _ _ _

Keep this manual in a safe place.

5. Perform one of the following 3 steps.
 - i. Press **AUTO** to confirm.
 - ii. Press **Up 5** to try again.
 - iii. Press **Down 6** to cancel the set-up and return to the on-screen menu.
6. Confirm the new password by re-entering the new password.
7. Perform one of the following 3 steps.
 - i. Pressing **AUTO** completes the procedure.
 - ii. Press **Up 5** to try again.
 - iii. Press **Down 6** to cancel the set-up and return to the on-screen menu.

Switching input signal

The projector can be connected to multiple devices at the same time. However, it can only display one at a time.

When **SOURCE** on the projector control panel or the remote control is pressed, information of current signal and resolution will display at the lower right corner. Press **SOURCE** again to display a source selection bar. You can manually press **SOURCE** repeatedly until your desired signal is selected or let the projector automatically search for the available signal.

Once detected, the selected source information will display at the lower right corner of the screen for 3 seconds. If there is multiple equipment connected to the projector, you can press the button again to search for another signal.

Be sure the **Source Scan** function in the **Advanced** menu is activated if you want the projector to automatically search the signals. See "[Source Scan \(on\)](#)" on page 43 for details.

If no input is detected after auto searching for two rounds, a message of "**No Signal**" will be shown on the screen.

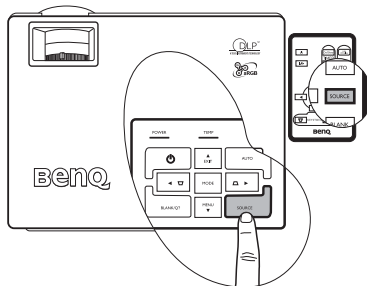

 **The brightness level of the projected image will change accordingly when you switch between different input signals. Data (graphic) "PC" presentations using mostly static images are generally brighter than "Video" using mostly moving images (movies).**

The input type affects the options available for the Application Mode. See "[Selecting a picture mode](#)" on page 31 for details.

Adjusting the projected image

Adjusting the projection angle

The projector is equipped with 1 quick-release adjuster foot and 1 rear adjuster foot. These adjusters change the image height and projection angle. To adjust the projector:

1. Lift the projector up and press the adjuster button to release the adjuster. The adjuster will drop into position and be locked.

 **Do not look into the lens while the lamp is on. The strong light from the lamp may cause damage to your eyes.**

2. Screw the rear adjuster foot to fine tune the horizontal angle.

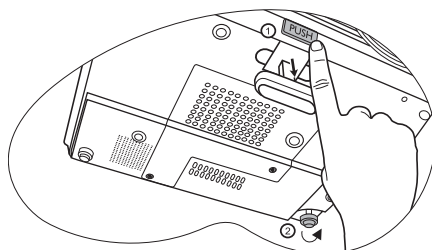

To retract the foot, hold up the projector while pressing the quick-release button, then slowly lower the projector. Screw the rear adjuster foot in a reverse direction.

 **If the screen and the projector are not perpendicular to each other, the projected image becomes vertically trapezoidal. To correct this situation, adjust the value of **Keystone** in the Picture menu, on the projector control panel, or on the remote control. See "[Correcting keystone](#)" on page 29 for details.**

Auto-adjusting the image

In some cases, you may need to optimize the picture quality. To do this, press **AUTO** on the projector or remote control. Within 3 seconds, the built-in Intelligent Auto Adjustment function will re-adjust the values of Frequency and Clock to provide the best picture quality.

The current source information will be displayed in the lower right corner of the screen for 3 seconds.

The screen will be blank while AUTO is functioning.

Fine-tuning the image size and clarity

Correcting keystone

Keystoning refers to the situation where the projected image is noticeably wider at either the top or bottom. It occurs when the projector is not perpendicular to the screen.

To correct this, besides adjusting the height of the projector, you will need to manually correct it following ONE of these steps.

1. Press **Left 3 /Right 4** on the control panel of the projector to display the status bar labelled Keystone. Press **Left 3** to correct keystone at the top of the image. Press **Right 4** to correct keystone at the bottom of the image.

2. Press **Left 3 /Right 4** on the remote control to display the status bar labelled Keystone, then press **Left 3** to correct keystone at the top of the image or press **Right 4** to correct keystone at the bottom of the image.

3. Press **6 MENU** on the projector or **MENU** on the remote control. Go to **Pro-Picture > Keystone** and adjust the values by pressing **Left 3 /Right 4** on the projector or **Left 3 /Right 4** on the remote control.

For example,



Keystone 0

1. Press **Left 3** on the projector or
2. Press **▽** on the remote control or
3. Press **Left 3** on the projector or **3** on the remote control when you are in Picture --> Keystone menu.



Keystone -6



Keystone 0

1. Press **Right 4** on the projector or
2. Press **△** on the remote control or
3. Press **Right 4** on the projector or **4** on the remote control when you are in Picture -> Keystone menu.



Keystone +6

Selecting the aspect ratio

The 'aspect ratio' is the ratio of the image width to the image height. Most analog TV and computers are in 4:3 ratio, which is the default for this projector, and digital TV and DVDs are usually in 16:9 ratio.

With the advent of digital signal processing, digital display devices like this projector can dynamically stretch and scale the image output to a different aspect than that of the image input source.

You can change the projected image ratio (no matter what aspect the source is) by entering



Pro-Picture > Aspect Ratio. Select an aspect ratio to suit the format of the

video signal and your display requirements. There are three aspect ratios available:

In the pictures below, the black portions are inactive areas and the white portions are active areas.

1. **Native:** The image is projected at its original aspect ratio, and resized to fit within the display area. For input signals with lower resolutions, the projected image will display smaller than if resized to full screen. You could adjust the zoom setting or move the projector towards the screen to increase the image size if necessary. You may also need to refocus the projector after making these adjustments.
2. **4:3:** Scales an image so that it is displayed in the center of the screen with a 4:3 aspect ratio. This is most suitable for 4:3 images like computer monitors, standard definition TV and 4:3 aspect DVD movies, as it displays them without aspect alteration.
3. **16:9:** Scales an image so that it is displayed in the center of the screen with a 16:9 aspect ratio. This is most suitable for images which are already in a 16:9 aspect, like high definition TV, as it displays them without aspect alteration.

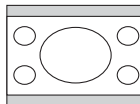
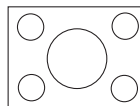
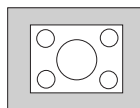

16:9 aspect ratio is only sourced through the Component Video input when being fed an appropriate 16:9 aspect signal. See "Connecting a Component Video source device" on page 21 and "Obtaining a preferred projected image size" on page 14 for details.

Selecting a picture mode

The projector is preset with several predefined application modes so that you can choose one to suit your operating environment and input source picture type. To select a operation mode that suits your need, press **MODE** repeatedly until your desired mode is selected. The picture modes available for different types of signals are listed below.

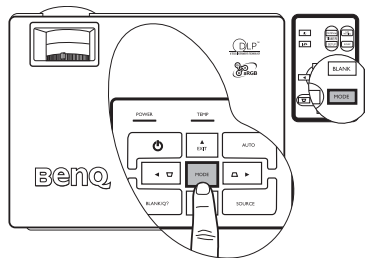

PC Signal Input

1. **Dynamic Mode (Default):** Maximizes the brightness of the projected image. This mode is suitable for environments where extra-high brightness is required, such as using the projector in well lit rooms.
2. **Presentation Mode:** Is designed for presentations. The brightness is emphasized in this mode to match PC and notebook coloring.
3. **sRGB Mode:** Maximizes the purity of RGB colors to provide true-to-life images regardless of brightness setting. It is most suitable for viewing photos taken with an sRGB compatible and properly calibrated camera, and for viewing PC graphic and drawing applications such as AutoCAD.
4. **Cinema Mode:** Is appropriate for playing colorful movies, video clips from digital cameras or DVs through the PC input for best viewing in a blackened (little light) environment.
5. **Blackboard Mode:** Is designed for educational use. Images are allowed to be projected on a dark background, such as a blackboard instead of a normal screen. It is most suitable for a well lit environment with a dark background for projection.

YPbPr/S-Video/Video Signal Input

1. **Dynamic Mode:** Is suitable for playing gamebox-based video games in a normal living room lighting level environment.
2. **Standard Mode (Default):** Is appropriate for viewing colorful movies, video clips from digital cameras or DVs.
3. **Cinema Mode:** Is suitable for enjoying dark movies or DVD movies best viewed in a blackened (little light) home cinema or lounge room environment.
4. **Blackboard Mode:** Is designed for educational use. Images are allowed to be projected on a dark background, such as a blackboard instead of a normal screen. It is most suitable for a well lit environment with a dark background for projection.

Hiding the image

In order to draw the audience's full attention to the presenter, you can use **BLANK** to hide the screen image. Press any key on the control panel to restore the image.

The word "**BLANK**" appears at the lower right corner of the screen while the image is hidden. When this function is activated with video/S-video signal connected, the audio can still be heard.

You can set the blank time in the  **Setting** > **Blank Time** to let the projector return the image automatically after a period of time when there is no action taken on the blank screen.

Note that once **BLANK** is pressed, the projector enters Economic mode automatically.

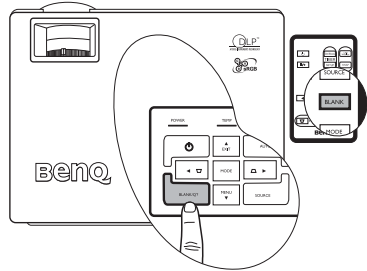

 **Do not block the projection lens from projecting as this could cause the blocking object to become heated and deformed or even cause a fire.**

Creating your own startup screen - MyScreen function

In addition to selecting the projector preset startup screen from among BenQ logo, Black or Blue screen, you can create your own startup screen by downloading pictures from your computer to the projector.

1. Connect the projector to a desktop computer via RS232 cable (optional accessory). See "[Connecting a computer](#)" on page 17.
2. Before download starts, be sure the projector has entered Standby Mode. Follow the instructions below to enter Standby Mode:
 - i. Plug AC power, and **POWER**, **TEMP** and **LAMP** LEDs on the projector will flash orange and then go off at the same time.
 - ii. **POWER** LED then turns solid orange.
3. Insert the bundled CD into the CD drive of your computer. Click **Install MyScreen Wizard** and follow the on-screen instructions to proceed.

-  **Ensure you have sufficient privileges to install software.**
- MyScreen utility may not be compatible with Windows 98/ME or Windows 2000. We recommend you to run MyScreen utility on Windows XP.**

4. To execute MyScreen utility:
- After MyScreen Wizard is successfully installed, execute MyScreen utility by selecting the



from Program Files .

- Click **Next**.

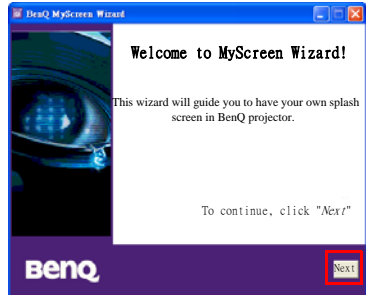

- Click **Next**

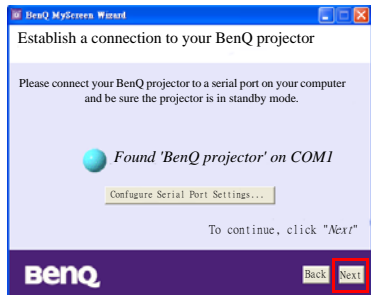

- Click **Browse** to choose your desired image and then click **Next**.

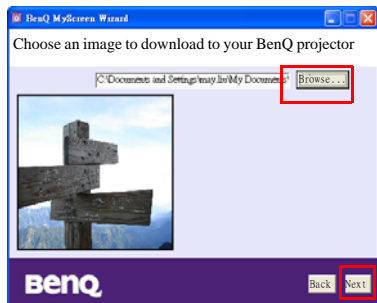

- Click **MyScreen** to begin download.

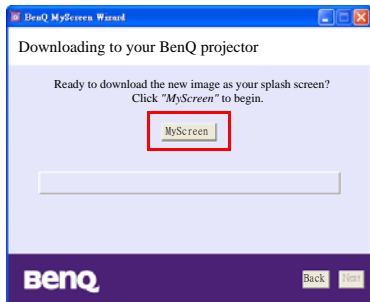

Setting the presentation timer

Presentation timer can indicate the remaining presentation time on the screen to help you achieve better time management when giving presentation. Follow these steps to utilize this function:

1. Go to  **Advanced > Presentation Timer** or press **TIMER SETUP** on the remote control to enter timer setting directly.
2. Select **On** by pressing **Left3 /Right4** . A confirmation message displays. Press **Down 6** to confirm or press **Up 5** to cancel.
3. Press **6 Down** to go to the next option and decide the timer period by pressing **Left3 /Right4** .
4. Press **6 Down** and choose if you want the timer to show up on the screen by pressing **Left3 /Right4** .
5. If you select **Yes**, press **6 Down** to go to the next option and set the timer position as in the upper left, upper right, lower left, or lower right corner by pressing **Left3 / Right4** .
6. Press **6 Down** and select your desired counting direction by pressing **Left3 /Right4** .
7. Press **6 Down** and decide if you want to activate sound reminding by pressing **Left3 / Right4** . If you select **Yes**, a double beep sound will be heard at the last 30 seconds of counting down/up, and a triple beep sound will be produced when the timer is up.

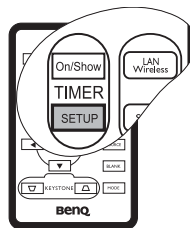

TIMER On/Show on the remote control is a multifunctional key. If the presentation timer is off, pressing this button for the first time will activate timer and second push on the button will display timer on the screen. If the timer is already on, pressing this button will display the timer on the screen.

-  **The duration of the on-screen timer is consistent with your timer setting. For example, if you set the timer to always display, after pressing this button for the first time to activate the timer, it will remain on the screen. If you set the timer to never display, the timer will only display on the screen for 5 seconds. Then it will disappear. Please note the timer is still counting after hidden.**
- **If the timer is already on, you need to reactivate the timer everytime a new timer period is set.**

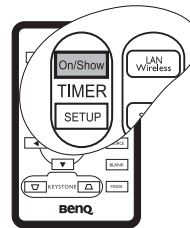

Freezing the image

Press **Freeze** on the remote control to freeze the image. An icon  will display in the lower right corner of the screen. To release the function, press the **Freeze** button on the remote control, or the **Source** button on the projector control panel. Note that pressing the **Source** button will also change the input source.

Even if an image is frozen on the screen, the pictures are running on the video or other device. If the connected devices have active audio output, you will still hear the audio even though the image is frozen.

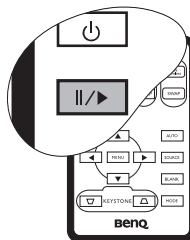







Menu operation

Menu system

Please note that the on-screen display (OSD) menus vary according to the signal type selected.

	Functions available when receiving different signal types...		
Sub-Menu	PC	Video / S-Video	Component Video
 Picture	Picture Mode Color Temp Brightness Contrast	Picture Mode Color Temp Brightness Contrast Color Tint* Sharpness	
 Pro-Picture	Keystone Auto Resize Aspect Ratio H Position V Position Phase H. Size	Keystone Auto Resize Aspect Ratio	
 Setting	Mute Volume OSD Time Blank Time Quick Cooling Panel Key Lock Password Change Password Reset		
 Advanced	Mirror Source Scan Language Splash Screen High Altitude Mode Auto Off Economic Mode Presentation Timer FAQ		
 Information	Source Resolution Picture Mode Equivalent Lamp Hour	Source System Picture Mode Equivalent Lamp Hour	Source Resolution Picture Mode Equivalent Lamp Hour

*When a Video or S-Video signal is connected, the function is only available with NTSC system selected.

Using the menus

The projector is equipped with on-screen display (OSD) menus for making various adjustments and settings.

There are 17 different menu languages. (Refer to page "[Advanced menu](#)" on page 43 for more details.)

The following example describes the adjustment of the keystone.

1. Press **MENU6** on the projector or **MENU** on the remote control to turn the on-screen menu on.
4. Adjust keystone values by pressing **Left 3 /Right 4** on the projector or **Left 3 /Right 4** on the remote control.

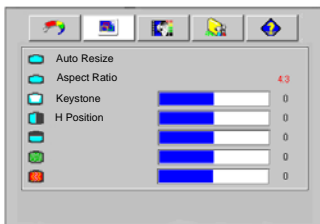









2. Use **Left3 /Right 4** on the projector or **Left 3 /Right 4** on the remote control to select the **Pro-Picture** menu.
3. Press **EXIT5** or **MENU6** on the projector or **6 /5** on the remote control to select **Keystone**.
5. Press **EXIT5** on the projector or press **MENU** twice* on the remote control to leave and save the setting.

***The first press leads you back to the submenu and the second press closes the on-screen menu.**

Picture menu



 Some picture adjustments are available only when certain input sources are in use. Unavailable adjustments are not shown on the screen.

FUNCTION (default setting / value)	DESCRIPTION
<p>Picture Mode</p> <p>(PC: Dynamic; YPbPr/ S-Video/ Video: Standard)</p>	<p>Pre-defined application modes are provided so you can optimize your projector image set-up to suit your program type.</p> <p> You can use the remote control 'Mode' button to select a predefined application mode. See "Selecting a picture mode" on page 31 for details.</p>
<p>Color Temp (depends on the selected Application mode)</p>	<p>There are four color temperature* settings available.</p> <ol style="list-style-type: none"> T1: With the highest color temperature, T1 makes the image appear the most bluish white than other settings. T2: Makes images appear bluish white. T3: Maintains normal colorings for white. T4: Makes images appear reddish white. <p>*About color temperatures: There are many different shades that are considered to be "white" for various purposes. One of the common methods of representing white color is known as the "color temperature". A white color with a low color temperature appears to be reddish white. A white color with a high color temperature appears to have more blue in it.</p>
<p>Brightness (depends on the selected input source)</p>	<p>Adjusts the brightness of the image. The higher the value, the brighter the image. And lower the setting, darker the image. Adjust this control so the black areas of the image appear just as black and that detail in the dark areas is visible.</p> <div style="display: flex; justify-content: space-around; align-items: center;">    </div> <div style="display: flex; justify-content: space-around; align-items: center; margin-top: 5px;"> <div style="text-align: center;">-30</div> <div style="text-align: center;">50</div> <div style="text-align: center;">+70</div> </div>
<p>Contrast (depends on the selected input source)</p>	<p>Adjusts the degree of difference between dark and light in the image. The higher the value, the greater the contrast. Use this to set the peak white level after you have previously adjusted the Brightness setting to suit your selected input and viewing environment.</p> <div style="display: flex; justify-content: space-around; align-items: center;">    </div> <div style="display: flex; justify-content: space-around; align-items: center; margin-top: 5px;"> <div style="text-align: center;">-30</div> <div style="text-align: center;">50</div> <div style="text-align: center;">+70</div> </div>



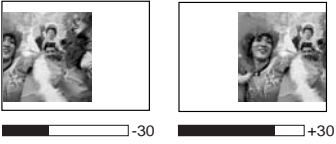
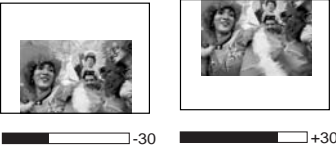

Color (depends on the selected input source)	Increases or decreases the color intensity of the image.
Tint (50)	<p>Adjusts the color tones of the image. The higher the value, the more reddish the image becomes. The lower the value, the more greenish the image becomes.</p> <p> When a Video or S-Video signal is connected, the function is only available with NTSC system selected.</p>
Sharpness (15)	Adjusts the image to make it look sharper or softer.

Pro-Picture menu

 Some picture adjustments are available only when certain input sources are in use. Unavailable adjustments are not shown on the screen.

FUNCTION (default setting / value)	DESCRIPTION
Keystone (0)	Corrects any keystone of the image. Refer to "Correcting keystone" on page 29 for more information.
Auto Resize (on)	Automatically resizes the input signal pixel resolution to the native resolution of the projector. On: The pixel resolution of the input signal is converted to the native resolution of the projector (1024 x 768). For input signals with lower resolutions, gaps in the pixels are automatically interpolated into the image before being projected. This may distort the image clarity. Off: If larger than the native resolution of the projector, the image is resized to fit within the display area. For input signals with lower resolutions, the projected image will display smaller than if resized to full screen. You could adjust the zoom setting or move the projector towards the screen to increase the image size if necessary. You may also need to refocus the projector after making these adjustments.
Aspect Ratio (Native)	There are three options to set the image's aspect ratio depending on your input signal source. See "Selecting the aspect ratio" on page 30 for details.
H Position (0)	Adjusts the horizontal position of the projected image. 
V Position (0)	Adjusts the vertical position of the projected image. 
Phase (depends on the selected input source)	Adjusts the video input clock to synchronise with the video signal. This helps reduce image distortion produced by some PC video timings. 
H Size (0)	Adjusts the horizontal width of the image.

Setting menu

FUNCTION (default setting / value)	DESCRIPTION
Mute (off)	Toggles projector audio and Power On/Off Tone between on and off. To disable Power On/Off Tone , go to  Setting > Mute and press Left3 /Right 4 . Then press Down 6 to choose Power On/Off Tone and press Left3 /Right 4 to select off .
Volume (5)	Adjusts audio volume level.
OSD Time (20)	Sets the length of time the OSD will remain active after your last button press. The range is from 5 to 100 seconds.
Blank Time (20)	Sets the image blank time when the Blank feature is activated, once elapsed the image will return to the screen.
Quick Cooling (on)	Enables or disables the Quick Cooling function. Selecting On enables the function and projector cooling time will be shortened from a normal 90-second duration to approximately 30 seconds.
Panel Key Lock (off)	Disables or enables all panel key functions except POWER on the projector and buttons on the remote control.
Password (off)	<p>This is a selectable function. Selecting On limits use of the projector to only those who know the correct password. When the function is activated for the first time, you have to set a password for it. For more information, refer to "Utilizing the password function" on page 26. Once the password is set and this function is selected, the projector is password-protected. Users who do not know the correct password can not use the projector.</p> <p> WARNING: You will be inconvenienced if you activate the password functionality and subsequently forget the password. Print out this manual (if necessary) and write the password you used in this manual, and keep the manual in a safe place for later recall.</p> <p>The password can be entered by using either the buttons on the projector or the remote control.</p> <p> The digits being input will display as asterisks on-screen.</p>
Change Password	You will be asked to enter the current password before changing to a new one. For more information, refer to " Utilizing the password function " on page 26.
Reset (No)	Returns all settings to the factory preset values.  The following settings will still remain: Mirror, Language, Password, High Altitude Mode, Phase and H Position.

Advanced menu

FUNCTION (default setting / value)	DESCRIPTION
Mirror (Floor front)	The projector can be installed on a ceiling or behind a screen, or with one or more mirrors. Contact your dealer for the ceiling mount bracket (optional accessory) if you need to install the projector on your ceiling. Refer to " Choosing a location " on page 12 for more information.
Source Scan (on)	Sets whether the projector searches automatically for input signals. If the source scan is On , the projector will scan for input signals until it acquires a signal. If the function is not activated, the projector selects the last used input signal. The default value is 'RGB'.
Language (English)	Language sets the language for the OSD control menus. Use Left 3 /Right 4 on the projector or remote control to select your desired language.
Splash Screen (BenQ logo)	Allows you to select which logo screen will display during projector start-up. Four modes are available: BenQ logo, Black screen, Blue screen or MyScreen.

<p>High Altitude Mode (off)</p>	<p>A mode for operation in areas like high altitude or high temperature. We recommend you use the High Altitude Mode when your environment is higher than 3000 feet above sea level, or is hotter than 40°C, or whenever the projector will be used for extended periods of time (>10 hours) without shutdown.</p> <p>To activate the High Altitude Mode, select On by pressing Left 3 /Right 4 on the projector or remote control. A confirmation message displays. Press 6.</p> <div data-bbox="333 320 994 456" style="border: 1px solid gray; padding: 5px; text-align: center;"> <p>We recommend you use the High Altitude Mode by selecting On whenever your environment is higher than 1500m.</p> <p>Confirm to turn High Altitude Mode on?</p> <p>Yes 6 No 5</p> </div> <p>Next time you turn on the projector, it will show a message pictured below as a reminder during the start-up.</p> <div data-bbox="333 523 994 643" style="border: 1px solid gray; padding: 5px; text-align: center;"> <p>Current Status</p> <p>High Altitude Mode On</p> <p>This mode is used for protecting projector from extreme environment and may cause high fan speed.</p> </div> <p>Operation under "High Altitude Mode" may cause a higher decibel operating noise level because of increased fan speed necessary to improve overall system cooling and performance.</p> <p>If you use this projector under other extreme conditions excluding the above, it may display auto shut-down symptoms, which is designed to protect your projector from over-heating. In cases like this, you should switch to High Altitude mode to solve these symptoms. However, this is not to state that this projector can operate under any and all harsh or extreme conditions.</p>
<p>Auto Off</p>	<p>This function allows the projector to turn off automatically if no input signal is detected after a set period of time. Press Left 3 /Right 4 on the projector or remote control to set the duration before the projector is turned off.</p>
<p>Economic Mode (off)</p>	<p>Use this mode to reduce system noise and reduce power consumption by 20%. If this mode is activated, the light output will be reduced and result in darker projected images.</p> <p> Setting the projector in Economic mode extends the lamp timer automatic shutdown feature. For more information on how the total lamp hour is calculated, see "Calculation of lamp hour" on page 47.</p>
<p>Presentation Timer</p>	<p>Helps to remind the presenter to finish the presentation within a certain timeframe. Refer to "Setting the presentation timer" on page 35 for more information.</p>
<p>FAQ</p>	<p>Displays possible solutions to problems you may encounter.</p>

Information menu

This menu shows you the current operating status of the projector.

 **Some picture adjustments are available only when certain input sources are in use. Unavailable adjustments are not shown on the screen.**

FUNCTION	DESCRIPTION
Source	Shows the current signal source.
Resolution	Shows the resolution of the input signal.
Picture Mode	Shows the selected mode in the  Picture menu.
Equivalent Lamp Hour	Displays the equivalent lamp hour calculated by the built-in timer.
System	Shows the Video input system format, NTSC, SECAM or PAL.

6 Maintenance

Care of the projector

Your projector needs little maintenance. The only thing you need to do on a regular basis is to keep the lens clean.

Never remove any parts of the projector except the lamp. Contact your dealer if other parts need replacing.

Cleaning the lens

Clean the lens whenever you notice dirt or dust on the surface.

- Use a canister of compressed air to remove dust.
- If there is dirt or smears, use lens-cleaning paper or moisten a soft cloth with lens cleaner and gently wipe the lens surface.

 **Never rub the lens with abrasive materials.**

Cleaning the projector case

Before you clean the case, turn the projector off using the proper shutdown procedure as described in "[Shutting down the projector](#)" on [page 36](#) and unplug the power cord.

- To remove dirt or dust, wipe the case with a soft, lint-free cloth.
- To remove stubborn dirt or stains, moisten a soft cloth with water and a neutral pH detergent. Then wipe the case.

 **Never use wax, alcohol, benzene, thinner or other chemical detergents. These can damage the case.**

Storing the projector

If you need to store the projector for an extended time, please follow the instructions below:

- Make sure the temperature and humidity of the storage area are within the recommended range for the projector. Please refer to "[Specifications](#)" on [page 54](#) or consult your dealer about the range.
- Retract the adjuster feet.
- Remove the batteries from the remote control.
- Pack the projector in its original packing or equivalent.

Transporting the projector

It is recommended that you ship the projector with its original packing or equivalent. When you carry the projector yourself, please use the original box or provided soft carry case.

Lamp information

Calculation of lamp hour

When the projector is in operation, the duration (in hours) of lamp usage is automatically calculated by the built-in timer. The method of calculating the equivalent lamp hour is as follows:

Total (equivalent) lamp hour

= (hours used in Economic mode) + 4/3 (hours used in normal mode)

 See **"Economic Mode (off)"** on page 44 for more information on Economic mode.

The lamp hour in Economic mode is calculated as 2/3 of that in normal mode. That is, using the projector in Economic mode helps to extend the lamp life by 1/3.



Warning message

When the **Lamp indicator** lights up red or a message appears suggesting it is time to replace the lamp, please install a new lamp or consult your dealer. An old lamp may cause a malfunction in the projector and in some instances the lamp may explode.

For more detailed information on projector warnings, please refer to **"Indicators"** on page 51.

 **The Lamp indicator light and Temperature warning light will light up if the lamp becomes too hot. Turn the power off and let the projector cool for 45 minutes. If the Lamp or Temp indicator still lights up after turning the power back on, please contact your dealer.**

The following Lamp warning displays will remind you to change the lamp.

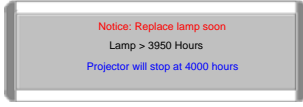
Message	Status
 	Total (equivalent) lamp hour has reached 3000 hours. Install a new lamp for optimal performance.
 	Total (equivalent) lamp hour has reached 3950 hour. A new lamp should be fitted to avoid the inconvenience when the projector runs out of lamp time.

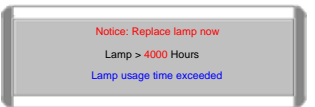
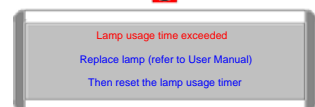
	<p>Total (equivalent) lamp hour has reached 4000 hours. This message will flash in the center of the screen for about 30 seconds together with the Lamp indicator lighting up red for 40 seconds.</p> <p>It is strongly recommended that you replace the lamp at this age. The lamp is a consumable item. With the usage time increase, the lamp brightness diminished gradually. This is normal lamp behaviour. You can replace the lamp whenever you notice that the brightness level has significantly diminished. If the lamp is not replaced beforehand, it must be replaced after 4000 hours usage.</p>
	<p>If this warning message displays, the projector will shut down in 40 seconds. The lamp MUST be replaced before the projector will operate normally.</p>

Replacing the lamp



- **To reduce the risk of electrical shock, always turn the projector off and disconnect the power cord before changing the lamp.**
 - **To reduce the risk of severe burns, allow the projector to cool for at least 45 minutes before replacing the lamp.**
 - **To reduce the risk of injuries to fingers and damage to internal components, use caution when removing lamp glass that has shattered into sharp pieces.**
 - **To reduce the risk of injuries to fingers and/or compromising image quality by touching the lens, do not touch the empty lamp compartment when the lamp is removed.**
 - **This lamp contains mercury. Consult your local hazardous waste regulations to dispose of this lamp in a proper manner.**
1. Turn the power off and disconnect the projector from the wall socket. If the lamp is hot, avoid burns by waiting for approximately 45 minutes until the lamp has cooled.
 2. Turn the projector over. Then loosen the screws on the lamp cover.

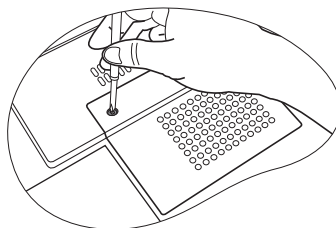

9. Tighten the screw that secures the lamp.



• **Loose screw may cause a bad connection, which could result in malfunction.**

• **Do not over tighten the screw.**

10. Connect the lamp connector to the projector.

11. Place the lamp cords back to the slots.

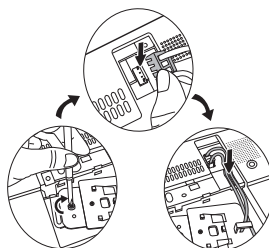

12. Replace the lamp cover on the projector.



13. Tighten the screw that secures the lamp cover.

• **Loose screw may cause a bad connection, which could result in malfunction.**

• **Do not over tighten the screw.**

14. Restart the projector.

Do not turn the power on with the lamp cover removed.

15. Resetting the lamp counter

Do not reset if the lamp is not replaced as this could cause damage.

- i. Press and hold the **Exit 5** button on the projector for 5 seconds to display the total used lamp time.
- ii. Press **Auto** on the projector or on the remote control to reset the lamp hour to "0".
- iii. Wait about 5 seconds to let the OSD disappear.

Temperature information



When the Temperature warning light is on, it is warning you of the following possible problems:











1. The internal temperature is too high.
2. The fans are not working.

Turn the projector off and contact qualified service personnel for further help. For more detailed information, please refer to "[Indicators](#)" on page 51.

Indicators

Illustration

- **Blank** -: Light OFF
-  -: Light flashing
-  -: Light ON
- **O**: Orange light
- **R**: Red light
- **G**: Green light

Light			Status & Description
Power	Temp	Lamp	
Power events			
			The projector has just been connected to a power outlet.
	-	-	Stand-by mode.
	-	-	Powering up.
	-	-	Normal operation.
	-	-	1. The projector needs 90 seconds to cool down as it was abnormally shut down without the normal cooling down process. Or 2. The projector needs to cool for 90 seconds after the power is turned off.
	-	-	The projector has shutdown automatically. If you try to re-start the projector, it will shutdown again. Please contact your dealer for assistance.
Lamp events			
	-		The projector has shutdown automatically. If you try to re-start the projector, it will shutdown again. Please contact your dealer for assistance.
-	-		1. The projector needs 90 seconds to cool down. Or 2. Please contact your dealer for assistance.

Light			Status & Description
Power	Temp	Lamp	
Thermal events			
-	R	-	The projector has shutdown automatically. If you try to re-start the projector, it will shutdown again. Please contact your dealer for assistance.
-	R	R	
-	R	G	
	R	O	
R	R	R	
R	R	G	
R	R	O	
G	R	R	
G	R	G	
G	R	O	
O	R	R	
O	R	G	
O	R	O	
-	G	R	
-	G	G	

7 Troubleshooting

② THE PROJECTOR DOES NOT TURN ON.

Cause	Remedy
There is no power from the power cable.	Plug the power cord into the AC inlet on the projector, and plug the power cord into the power outlet. If the power outlet has a switch, make sure that it is switched on.
Attempting to turn the projector on again during the cooling process.	Wait until the cooling down process has completed.

② NO PICTURE

Cause	Remedy
The video source is not turned on or connected correctly.	Turn the video source on and check that the signal cable is connected correctly.
The projector is not correctly connected to the input source device.	Check the connection.
The input signal has not been correctly selected.	Select the correct input signal with the Source key on the projector or remote control.
The lens cap is still attached to the lens.	Remove the lens cap.

② BLURRED IMAGE

Cause	Remedy
The projection lens is not correctly focused.	Adjust the focus of the lens using the focus ring.
The projector and the screen are not aligned properly.	Adjust the projection angle and direction as well as the height of the unit if necessary.
The lens cap is still attached to the lens.	Remove the lens cap.

② REMOTE CONTROL DOES NOT WORK

Cause	Remedy
The battery is out of power.	Replace the battery with a new one.
There is an obstacle between the remote control and the projector.	Remove the obstacle.
You are too far away from the projector.	Stand within 6 meters (19.5 feet) of the projector.

② THE PASSWORD IS INCORRECT

Cause	Remedy
You do not remember the password.	Please see "Entering the password recall procedure" on page 27 for details.

8 Specifications

Projector specifications

 All specifications are subject to change without notice.

General

Product name	Digital Projector
Model name	MP620c

Optical

Resolution	1024 x 768 XGA
Display system	1-CHIP DMD
Lens F/Number	F=2.6 to 2.77, f= 20.4 to 23.5 mm
Lamp	200W lamp

Electrical

Power supply	AC100–240V, 4.0A, 50–60 Hz (Automatic)
Power consumption	285W (Max)

Mechanical

Dimensions	278 mm (W) x 94 mm (H) x 219.5 mm (D)
Weight	5.9 lbs (2.67 Kg)

Input terminal

Computer input	
RGB input	D-sub 15-pin (female) x 1
DVI-I input	(Using DVI-A signal)
Video signal input	
S-VIDEO	Mini DIN 4-pin port x 1
VIDEO	RCA jack x1
HDTV signal input	D-sub <--> Component RCA jack x3, through RGB input
Audio signal input	
Audio in	Mini jack stereo port

Output

RGB output	D-sub 15-pin (female) x 1
USB mouse connector	A/B series x 1
Speaker	(mixed mono) 2 watt x 1

Environmental Requirements

Operating temperature	0°C ~ 40°C at sea level
Operating relative humidity	10% ~ 90% (without condensation)
Operating altitude	<ul style="list-style-type: none">• 0–1499 m at 0°C–35°C• 1500–3000 m at 0°C–30°C

Timing chart

Supported timing for PC input

Resolution	Horizontal Frequency (kHz)	Vertical Frequency (Hz)	Pixel Frequency (MHz)	Mode
640 x 480	31.469	59.940	25.175	VGA_60
	37.861	72.809	31.500	VGA_72
	37.500	75.000	31.500	VGA_75
	43.269	85.008	36.000	VGA_85
720 x 400	31.469	70.087	28.3221	720 x 400_70
800 x 600	37.879	60.317	40.000	SVGA_60
	48.077	72.188	50.000	SVGA_72
	46.875	75.000	49.500	SVGA_75
	53.674	85.061	56.250	SVGA_85
1024 x 768	48.363	60.004	65.000	XGA_60
	56.476	70.069	75.000	XGA_70
	60.023	75.029	78.750	XGA_75
	68.667	84.997	94.500	XGA_85
1280 x 768	47.77	60.09	80.768	SXGA_60
1280 x 800	49.65	59.96	83.458	SXGA_60
1280 x 1024	63.981	60.020	108.000	SXGA_60

Supported timing for Component-YPbPr input

Signal Format	Horizontal Frequency (kHz)	Vertical Frequency (Hz)
480i(525i)@60Hz	15.73	59.94
480p(525p)@60Hz	31.47	59.94
576i(625i)@50Hz	15.63	50.00
576p(625p)@50Hz	31.25	50.00
720p(750p)@60Hz	45.00	60.00
720p(750p)@50Hz	37.50	50.00
1080i(1125i)@60Hz	33.75	60.00
1080i(1125i)@50Hz	28.13	50.00

Supported timing for Video and S-Video inputs

Video mode	Horizontal Frequency (kHz)	Vertical Frequency (Hz)	Color sub-carrier Frequency (MHz)
NTSC	15.73	60	3.58
PAL	15.63	50	4.43
SECAM	15.63	50	4.25 or 4.41
PAL-M	15.73	60	3.58
PAL-N	15.63	50	3.58
PAL-60	15.73	60	4.43
NTSC4.43	15.73	60	4.43

Dimensions

278 mm (W) x 94 mm (H) x 219.5 mm (D)

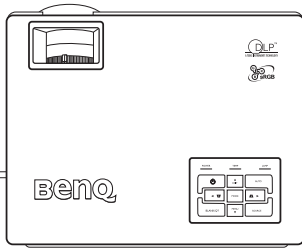

Unit: mm

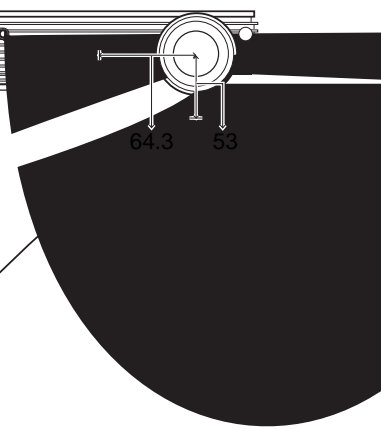
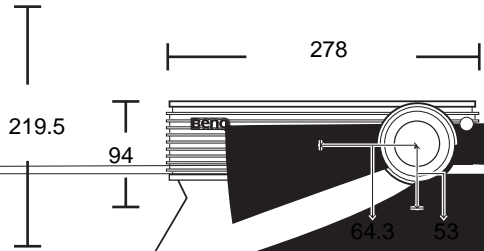

Warranty

Limited warranty

BenQ warrants this product against any defects in material and workmanship, under normal usage and storage.

Proof of purchase date will be required with any warranty claim. In the event this product is found to be defective within the warranty period, BenQ's only obligation and your exclusive remedy shall be replacement of any defective parts (labor included). To obtain warranty service, immediately notify the dealer from which you purchased the product of any defects.

Important: The above warranty shall be void if the customer fails to operate the product in accordance with BenQ's written instructions, especially the ambient humidity must be in-between 10% and 90%, temperature in-between 0°C and 40°C, altitude lower than 10000 feet, and avoiding to operate the projector in a dusty environment. This warranty gives you specific legal rights, and you may have other rights which vary from country to country.

For other information, please visit support.BenQ.com.

10 Regulation statements

FCC statement

CLASS B: This equipment generates, uses and can radiate radio frequency energy and, if not installed and used in accordance with the instructions, may cause harmful interference to radio communications. However, there is no guarantee that interference will not occur in a particular installation. If this equipment does cause harmful interference to radio or television reception, which can be determined by turning the equipment off and on, the user is encouraged to try to correct the interference by one or more of the following measures:

- Reorient or relocate the receiving antenna.
- Increase the distance between the equipment and receiver.
- Connect the equipment into an outlet on a circuit different from that to which the receiver is connected.
- Consult the dealer or an experienced radio/TV technician for help.

EEC statement

This machine was tested against the 89/336/EEC (European Economic Community) for EMC (Electronic Magnetic Compatibility) and fulfills these requirements.

WEEE directive

Disposal of Waste Electrical and Electronic Equipment by users in private households in the European Union.

This symbol on the product or on the packaging indicates that this can not be disposed of as household waste. You must dispose of your waste equipment by handing it over to the applicable take-back scheme for the recycling of electrical and electronic equipment. For more information about recycling of this equipment, please contact your city office, the shop where you purchased the equipment or your household waste disposal service. The recycling of materials will help to conserve natural resources and ensure that it is recycled in a manner that protects human health and environment.



Free Manuals Download Website

<http://myh66.com>

<http://usermanuals.us>

<http://www.somanuals.com>

<http://www.4manuals.cc>

<http://www.manual-lib.com>

<http://www.404manual.com>

<http://www.luxmanual.com>

<http://aubethermostatmanual.com>

Golf course search by state

<http://golfingnear.com>

Email search by domain

<http://emailbydomain.com>

Auto manuals search

<http://auto.somanuals.com>

TV manuals search

<http://tv.somanuals.com>