

# AXIS 241Q and AXIS 241S Video Servers

## User's Manual

Installation instructions are also available in German, French, Italian and Spanish in this manual.

## About This Document

This manual is intended for administrators and users of the AXIS 241Q/241S Video Server, and is applicable for software release 4.20. It includes instructions for installing, using and managing the AXIS 241Q/241S on your network. Previous experience of networking will be of use when installing and using this product. Some knowledge of UNIX or Linux-based systems would also be beneficial, for developing shell scripts and applications. Later versions of this document will be posted to the Axis Website, as required. See also the product's online help, available via the Web-based interface.

### Safety Notices Used In This Manual

**Caution!** - Indicates a potential hazard that can damage the product.

**Important!** - Indicates a hazard that can seriously impair operation.

Do not proceed beyond any of the above notices until you have fully understood the implications.

### Intellectual Property Rights

Axis AB has intellectual property rights relating to technology embodied in the product described in this document. In particular, and without limitation, these intellectual property rights may include one or more of the patents listed at <http://www.axis.com/patent.htm> and one or more additional patents or pending patent applications in the US and other countries.

This product contains licensed third-party software. See the menu item "About" in the product's user interface for more information.

### Legal Considerations

Camera surveillance can be prohibited by laws that vary from country to country. Check the laws in your local region before using this product for surveillance purposes. This product includes one (1) MPEG-4 decoder license. To purchase further licenses, contact your reseller.

### Electromagnetic Compatibility (EMC)

This equipment generates, uses and can radiate radio frequency energy and, if not installed and used in accordance with the instructions, may cause harmful interference to radio communications. However, there is no guarantee that interference will not occur in a particular installation. If this equipment does cause harmful interference to radio or television reception, which can be determined by turning the equipment off and on, the user is encouraged to try to correct the interference by one or more of the following measures: Re-orient or relocate the receiving antenna. Increase the separation between the equipment and receiver. Connect the equipment to an outlet on a different circuit to the receiver. Consult your dealer or an experienced radio/TV technician for help. Shielded (STP) network cables must be used with this unit to ensure compliance with EMC standards.

**USA** - This equipment has been tested and found to comply with the limits for a Class B computing device pursuant to Subpart B of Part 15 of FCC rules, which are designed to provide reasonable protection against such interference when operated in a commercial environment. Operation of this equipment in a residential area is likely to cause interference, in which case the user at his/her own expense will be required to take whatever measures may be required to correct the interference.

**Europe** -  This digital equipment fulfills the

requirements for radiated emission according to limit B of EN55022/1998, and the requirements for immunity according to EN55024/1998 residential, commercial, and light industry.

### Liability

Every care has been taken in the preparation of this manual; Please inform your local Axis office of any inaccuracies or omissions. Axis Communications AB cannot be held responsible for any technical or typographical errors and reserves the right to make changes to the product and manuals without prior notice. Axis Communications AB makes no warranty of any kind with regard to the material contained within this document, including, but not limited to, the implied warranties of merchantability and fitness for a particular purpose. Axis Communications AB shall not be liable nor responsible for incidental or consequential damages in connection with the furnishing, performance or use of this material.

### Trademark Acknowledgments

Acrobat, Adobe, Boa, Ethernet, IBM, Internet Explorer, LAN Manager, Linux, Macintosh, Microsoft, Mozilla, Netscape Navigator, OS/2, UNIX, Windows, WWW are registered trademarks of the respective holders. QuickTime™ is a trademark of Apple Computer, Inc., registered in the U.S. and other countries. Java and all Java-based trademarks and logos are trademarks or registered trademarks of Sun Microsystems, Inc. in the United States and other countries. Axis Communications AB is independent of Sun Microsystems Inc. UPnP™ is a certification mark of the UPnP™ Implementers Corporation.

### Support Services

Should you require any technical assistance, please contact your Axis reseller. If your questions cannot be answered immediately, your reseller will forward your queries through the appropriate channels to ensure a rapid response. If you are connected to the Internet, you can:

- download user documentation and firmware updates
- find answers to resolved problems in the FAQ database. Search by product, category, or phrases
- report problems to Axis support staff by logging in to your private support area
- visit the Axis Support Web at [www.axis.com/techsup/](http://www.axis.com/techsup/)

### Safety Notice - Battery Replacement

The AXIS 241Q/241S uses a 3.0V CR2032 Lithium battery as the power supply for its internal real-time clock (RTC). This battery will, under normal conditions, last for a minimum of 5 years. Low battery power affects the operation of the RTC, causing it to reset at every power-up. A log message will appear when battery replacement is required.

The battery should not be replaced unless required!

If the battery does need replacing, observe the following points:

**Caution!**

- Danger of Explosion if battery is incorrectly replaced
- Replace only with the same or equivalent battery, as recommended by the manufacturer.
- Dispose of used batteries according to the manufacturer's instructions.

AXIS 241Q/241S User's Manual  
Revision 2.1  
Dated: March 2005  
Part No: 24241  
Copyright© Axis Communications AB, 2004-2005

# Table of contents

---

- Product Description . . . . . 6
  - Hardware Inventory . . . . . 6
  - AXIS 241Q Front Panel . . . . . 7
  - AXIS 241S Front Panel . . . . . 8
  - AXIS 241Q/241S Rear Panel . . . . . 9
- Installation . . . . . 10
  - Mounting . . . . . 10
  - Connecting video cameras . . . . . 11
  - Installation Methods . . . . . 11
  - AXIS IP Utility . . . . . 11
  - UPnP™ . . . . . 12
  - ARP and Ping in Windows . . . . . 13
  - ARP and Ping in UNIX/Linux . . . . . 14
- Using the video server . . . . . 16
  - Accessing the video server . . . . . 16
  - The Live View page . . . . . 17
- Video Streams . . . . . 19
  - Stream Types . . . . . 19
  - MPEG-4 protocols and communication methods . . . . . 20
  - How to stream MPEG-4? . . . . . 20
  - The AXIS Media Control . . . . . 21
  - Other methods of accessing the video stream . . . . . 21
- Configuring the video server . . . . . 23
  - Accessing the Setup tools . . . . . 23
- Video & Image Settings . . . . . 24
  - Image Settings . . . . . 24
  - Video Source Settings . . . . . 25
  - Pan Tilt Zoom . . . . . 26
  - Advanced - MPEG-4 Settings . . . . . 26
  - Quad Stream Settings (AXIS 241Q only) . . . . . 26
  - Overlay Image Settings . . . . . 27
- Live View Config . . . . . 28
  - Layout . . . . . 28
  - HTML Examples . . . . . 31
  - External Video . . . . . 31
  - Sequence Mode . . . . . 31

Event Configuration .....	32
Event Servers .....	32
Event Types .....	33
Motion Detection .....	35
Port Status .....	36
Pan Tilt Zoom .....	37
Installing PTZ Devices .....	39
System Options .....	40
Security .....	40
Date & Time .....	41
Network - Basic TCP/IP Settings .....	42
Network - Advanced TCP/IP Settings .....	43
SOCKS .....	44
SMTP (email) .....	44
UPnP™ .....	44
RTP (Multicast)/MPEG-4 .....	44
Ports & Devices .....	45
Maintenance .....	45
Support .....	46
Advanced .....	46
Resetting to the Factory Default Settings .....	47
Unit Connectors .....	48
The D-Sub Connector .....	48
The I/O Terminal Connector .....	49
Schematic Diagram - I/O Terminal Connector .....	50
COM Ports RS-232 and RS-485 .....	50
Y/C to BNC Cable (AXIS 241S only) .....	51
Troubleshooting .....	52
Checking the Firmware .....	52
Upgrading the Firmware .....	52
Support .....	53
Technical Specifications .....	57
General performance considerations .....	59
Optimizing your system .....	59
Frame rates - Motion JPEG .....	60
Frame rates - MPEG-4 .....	60
Bandwidth .....	61

Installation .....	62
Montage .....	62
Videokameras anschließen.....	63
Installationsmethoden .....	63
AXIS IP Utility.....	64
UPnP™ .....	65
ARP und Ping unter Windows .....	65
ARP and Ping unter UNIX/Linux .....	67
Installation .....	70
Montage .....	70
Connexion des caméras vidéo .....	71
Méthodes d'installation .....	71
Application AXIS IP Utility.....	71
UPnP™ .....	73
ARP et Ping sous Windows .....	73
ARP et Ping sous UNIX/Linux .....	75
Installazione .....	78
Montaggio.....	78
Connessione delle videocamere.....	79
Metodi di installazione .....	79
AXIS IP Utility.....	79
UPnP™ .....	81
ARP e Ping in Windows .....	81
ARP e Ping in UNIX/Linux .....	83
Instalación.....	86
Montaje.....	86
Conexión de las cámaras de vídeo .....	87
Métodos de instalación .....	87
AXIS IP Utility.....	87
UPnP™ .....	89
ARP y Ping en Windows .....	89
ARP y Ping en UNIX/Linux .....	90
Glossary .....	92
Index .....	94

## Product Description

The AXIS 241Q/241S is a fully featured video server for security surveillance and remote monitoring needs. Based on the AXIS ARTPEC-2 compression chip, it can digitize up to 4 analog video sources and make these available on the network as real-time, full frame rate Motion JPEG and/or MPEG-4 video streams.

The AXIS 241Q has 4 BNC inputs for analog video devices and the AXIS 241S has 1 BNC input and a matching loop-through output. The AXIS 241S can also accommodate Y/C video using an Y/C to BNC cable (not included).

The AXIS 241Q/241S is equipped with RS-232 and RS-485 ports for the connection of third party PTZ systems. It also has 4 alarm inputs and 4 alarm outputs, which can be used to connect various third party devices, e.g. door sensors and alarm bells.

Up to 20 viewers can access the camera simultaneously when using Motion JPEG and MPEG-4 unicast. If MPEG-4 multicast is used, the number of viewers is unlimited, but when viewing with the AXIS Media Control (AMC), each viewer still needs a separate MPEG-4 decoder license. The AXIS 241Q/241S includes one such decoder license. Additional licenses can be purchased separately from your Axis dealer. If using other clients to view the video stream, no further MPEG-4 decoder licenses are required.

Video can be viewed in 5 resolutions (up to 4CIF), and image compression is configurable. The video server contains support for video motion detection, which allows the unit to trigger on activity in the video image, and advanced scheduling tools which can also be used to trigger an event. As the AXIS 241Q/241S is designed for use in security systems, it is equipped with several security features, such as IP address filtering, several user levels with passwords, and HTTPS.

The AXIS 241Q/241S has a built-in web server, providing full access to all features through the use of a standard browser. The built-in scripting tool allows basic applications to be created, providing basic surveillance solutions. For advanced functionality, the video server can be integrated via the use of the AXIS HTTP API (see [www.axis.com/developer](http://www.axis.com/developer)).

## Hardware Inventory

Check the items supplied with your AXIS 241Q/241S against the following list:

Item	Title/variant	Notes
Video Server	AXIS 241Q or AXIS 241S	
Printed user documentation	AXIS 241S/241Q User's Manual	This document
Warranty Document	Warranty Document	
Power adapter	PS-K	Country-specific
Terminal block connector	12-pin	
Mounting kit		For wall or rack mounting
Converter cable (optional)	ACC Y/C to BNC cable	AXIS 241S only. Not included.
MPEG-4 licences (optional)	10-user licence pack	Not included

## AXIS 241Q Front Panel



**Indicators** - After completion of the startup and self-test routines, the multi-colored Network, Status, Power Indicators flash as follows:

Network	Amber	Flashes for activity on a 10 Mbit/s network
	Green	Flashes for activity on a 100 Mbit/s network
	Red	Flashes rapid red for hardware error, together with the Status indicator
	None	No connection
Status	Green	Normal operation
	Amber	Flashes during reset to factory default or at firmware upgrade
	Red	Flashes rapid red for a hardware error, together with the Network indicator
Power	Green	Normal operation
	Amber	Flashes green/amber during upgrade

**DIP Switches** - A corresponding line termination switch for each of the supported video inputs. All units are shipped with the line termination enabled for each supported video input; that is, with the DIP switches set in the down-position.

**Note:** If the AXIS 241Q is to be connected in parallel with other equipment, disable the input termination by turning the corresponding DIP switch to the up-position (OFF). Failure to do so may cause reduced image quality.

**Control Button** - Press this button to restore the factory default settings, as described in *Resetting to the Factory Default Settings, on page 47*, or to install using AXIS Internet Dynamic DNS Service (page 15).

**Video Inputs** - Accommodates up to 4 separate video sources (VIDEO 1 - VIDEO 4) simultaneously. Each supported video input is connected using a coax/BNC connector. Physical connections made using e.g. 75 Ohm coax video cable have a recommended maximum length of 800 feet (250 meters).

## AXIS 241S Front Panel



**Indicators** - After completion of the startup and self test routines, the multi-colored Network, Status, Power Indicators flash as follows:

Network	Amber	Flashes for activity on a 10 Mbit/s network
	Green	Flashes for activity on a 100 Mbit/s network
	Red	Flashes rapid red for hardware error, together with the Status indicator
	None	No connection
Status	Green	Normal operation
	Amber	Flashes during reset to factory default or at firmware upgrade
	Red	Flashes rapid red for a hardware error, together with the Network indicator
Power	Green	Normal operation
	Amber	Flashes green/amber during upgrade

**DIP Switches** - upon delivery the AXIS 241S is configured for composite video input.

Switch	1	2	3	4
Description	75 ohm video in termination	75 ohm video out termination	Connects video in and video out	Not used
Composite video input	on	off	on	n/a
Y/C video input	on	on	off	n/a

**Note:** If the AXIS 241S is to be connected in loop-through with other equipment, disable the input termination by setting switch 1 to the up-position (OFF). Failure to do this may cause reduced image quality.

**Control Button** - Press this button to restore the factory default settings, as described in *Resetting to the Factory Default Settings, on page 47*, or to install using AXIS Internet Dynamic DNS Service, see page 15.

**Video Input** - Coaxial BNC connector supporting a single composite video source. The physical connection is made using 75 Ohm coax video cable with a recommended maximum length of 800 feet (250 meters).

**Note:** The AXIS 241S supports conversion between composite video and Y/C (S-video) using an Y/C to BNC cable.

**Video Output** - A single video loopthrough (VIDEO OUT) connected in parallel with VIDEO IN and terminated with a coax/BNC connector. Allows direct connection of e.g. an external monitor. Set dipswitch to OFF when in use.



## AXIS 241Q/241S Rear Panel



The Serial Number is located on the label on the underside of the unit.

**Power Supply Connector** - A single socket for connection of the PS-K power adapter.

**I/O Terminal connector** - The I/O Terminal connector provides the physical interface to 4 digital transistor outputs, 4 digital inputs and an RS-485 interface. See *Unit Connectors*, on page 48 for more information.

**Note:** The I/O Terminal connector also provides an auxiliary connection point for DC power.

**Network Connector** - The AXIS 241Q/241S connects to the network via a standard network cable. The AXIS 241Q/241S detects the speed of the local network segment (10BaseT/100BaseTX Ethernet).

**RS-232 Serial Connector** - A 9-pin D-sub connector providing an RS-232 serial connection. Typically used for connecting Pan/Tilt/Zoom devices. See *Unit Connectors*, on page 48 for more information.

## Installation

### Mounting

The AXIS 241Q/241S is supplied with a mounting kit for wall or rack mounting. The mounting brackets can be positioned for mounting the video server on a vertical surface or in a rack (4U). Follow the instructions below to attach the brackets to the video server:

- 1 Slide the grey frame off the front panel of the video server (no tools needed).



- 2 Insert the metal plates in the slots on each side of the video server.

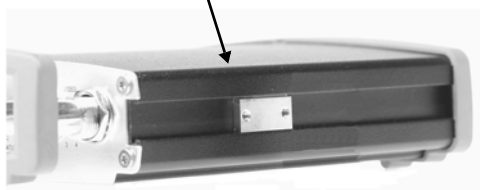

Alternative B

- 3 Position and attach the brackets on each side, using the screws provided.

Alternative A

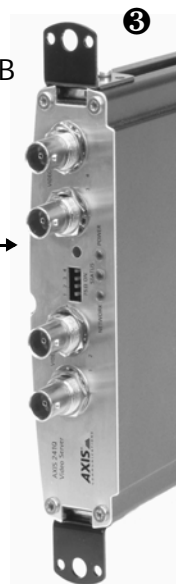
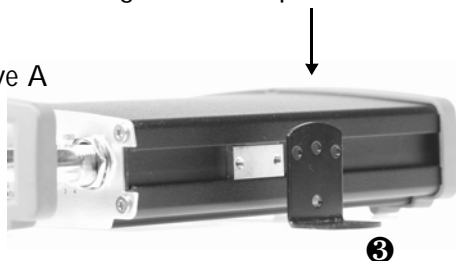

## Connecting video cameras

Connect the video output of your camera(s) to the AXIS 241Q/241S video server using a standard 75 Ohm coaxial video cable with BNC connectors.



**Note:** Use a RCA-to-BNC adapter if your camera has a standard phono-type (RCA) connector.

## Installation Methods

The AXIS 241Q/241S is designed for installation on an Ethernet network. This involves assigning it an IP address, either manually or via an automated network service (DHCP). Select one of the following procedures depending on your network:

- In Windows, use AXIS IP Utility to discover a dynamic IP address, or to set the IP address manually.
- If your network uses a DHCP server, view its administration pages to discover which IP address has been assigned to your AXIS 241Q/241S.
- If your network uses a DHCP server and your computer is running UPnP™, the AXIS 241Q/241S will automatically be detected and displayed on your screen. See page 12.
- Assign an IP address manually using the ARP/Ping method, as described on page 13.
- If your network has an Internet connection (with no HTTP proxy) and uses a DHCP server to assign IP addresses, use the One-Click installation procedure. See page 15.

**Notes:**

- The AXIS 241Q/241S has a default IP address: 192.168.0.90
- DHCP is enabled by default in the AXIS 241Q/241S
- UPnP™ is enabled by default in the AXIS 241Q/241S

## AXIS IP Utility

AXIS IP Utility is a free Windows application that discovers and displays Axis devices on your network. The application can also be used to manually set a static IP address. Download AXIS IP utility from the support pages at: [www.axis.com/techsup/software](http://www.axis.com/techsup/software)

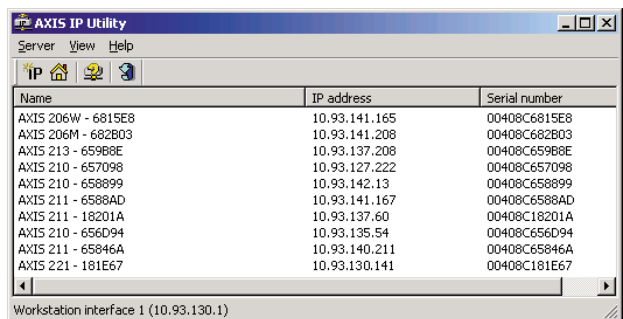

### Automatic discovery

1. Check that the network and power cables are connected to the AXIS 241Q/241S.
2. Start AXIS IP Utility. When the AXIS 241Q/241S appears in the window, double-click it to open the home page.

## Set the IP address manually

If the AXIS 241Q/241S does not appear in the window, click the **Refresh** button to try again. If it still does not appear, set the IP address manually.

1. Acquire an unused IP address. AXIS IP Utility detects the subnet your computer is connected to. The AXIS 241Q/241S must be installed on the same network segment.
2. Click the button "Set IP address using serial number" and enter the serial number and IP address for the AXIS 241Q/241S.
3. Click the **Set IP** button and then restart the AXIS 241Q/241S (within 2 minutes).
4. Click **View Home Page** to access the AXIS 241Q/241S Web pages.
5. Enter a password for the **root** user (administrator).
6. If required, accept the installation of **AMC** onto your workstation.

**Notes:**

- AXIS IP Utility can also be used to change the IP address of a previously discovered Axis device.
- AMC (AXIS Media Control) must be installed to view live video in Microsoft Internet Explorer. If your working environment restricts additional software components, you can configure your AXIS 241Q/241S to use a Java applet for updating the images. See the help file Live View Config > Layout > Default Viewer for Internet Explorer, or use another supported Web browser, see *Technical Specifications*, on page 57.

7. The installation is now complete. Proceed to *Using the video server*, on page 16.

The serial number (S/N) is located on the label on the underside of the AXIS 241Q/241S

## UPnP™

UPnP functionality is enabled by default in the AXIS 241Q/241S. If also enabled on your computer (Windows ME or XP), the video server will automatically be detected and a new icon will be added to "My Network Places." Click this icon to access the AXIS 241Q/241S.

### Note:

To install the UPnP service on your computer, open the Control Panel from the Start Menu and select **Add/Remove Programs**. Select **Add/Remove Windows Components** and open the **Networking Services** section. Click **Details** and then select **UPnP** as the service to add.

UPnP™ is a certification mark of the UPnP™ Implementers Corporation.

## ARP and Ping in Windows

Assign your product a unique IP address from a computer on your network as follows:

1. Acquire an unused IP address for the AXIS 241Q/241S from your network administrator.
2. Connect the AXIS 241Q/241S to the network using a standard network cable.
3. Locate the serial number (S/N) found on the label on the underside of the AXIS 241Q/241S.
4. From a computer on your network, open a Command Prompt, i.e. from the Windows Start menu, select Run... and type cmd (command in Windows 98/ME). Click OK.
5. Enter the commands:

Syntax:

```
arp -s <IP address> <Serial number>
ping -l 408 -t <IP address>
```

**Note:** The ping command is followed by -l (lower case L)

### Example

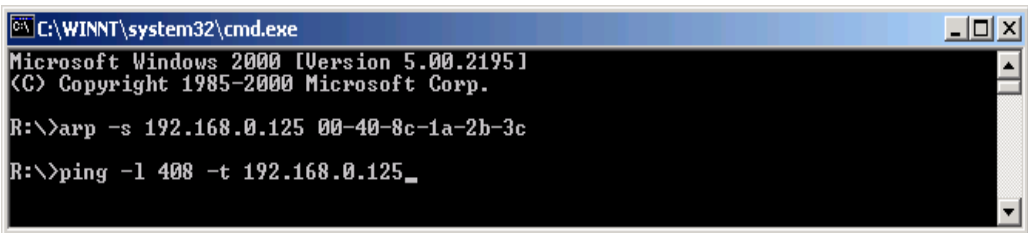

6. Start/restart the AXIS 241Q/241S. This must be done no later than 2 minutes after entering the ARP and Ping commands.
7. When 'Reply from 192.168.0.125: ...' is displayed (approximately 10-15 seconds), type Ctrl+C to stop Ping.
8. Start a browser and enter the IP address in the Address/Location field.
9. Press Enter.
10. Enter a password for the root user (administrator).
11. If required, accept the installation of AMC onto your workstation.

**Note:** AMC must be installed to view live video images in Microsoft Internet Explorer. If your working environment restricts additional software components, you can configure your AXIS 241Q/241S to use a Java applet for updating the images. See the help file under Live View Config > Layout > Default Viewer for Internet Explorer for information. Or use another supported Web browser, see *Technical Specifications*, on page 57.

12. The installation is now complete. Proceed to *Using the video server*, on page 16.

## ARP and Ping in UNIX/Linux

Assign your product with a unique IP address from a computer on your network, as follows:

1. Acquire an unused IP address for the AXIS 241Q/241S from your network administrator.
2. Connect the AXIS 241Q/241S to the network using a standard network cable.
3. Locate the serial number (S/N) found on the label on the underside of the AXIS 241Q/241S.

Syntax:

```
arp -s <IP Address> <Serial number> temp  
ping -s 408 <IP address>
```

Example:

```
arp -s 192.168.0.125 00:40:8c:18:10:00 temp  
ping -s 408 192.168.0.125
```

4. Start/restart the AXIS 241Q/241S. This must be done no later than 2 minutes after entering the ARP and Ping commands.
5. Close the ARP/Ping session when 'Reply from 192.168.0.125: ...' (or similar) is displayed (approximately 10-15 seconds).
6. Start a browser and enter the IP address in the Address/Location field.
7. Press Enter.
8. Enter a password for the root user (administrator).
9. The installation is now complete. Proceed to *Using the video server*, on page 16.

## AXIS Internet Dynamic DNS Service

The AXIS Internet Dynamic DNS Service is a free service provided by Axis. The service allows you to quickly and simply install your video server, which then receives a static name (DNS name) and a dynamic IP address. More information about the AXIS Internet Dynamic DNS Service is available at [www.axiscam.net](http://www.axiscam.net)

The video server can be unregistered from the service at any time.

Please visit [www.axiscam.net](http://www.axiscam.net) for more details on the AXIS Internet Dynamic DNS Service.

### Requirements

Using the AXIS Internet Dynamic DNS Service requires an Internet connection that does not require a proxy server for HTTP access. A DHCP server in the network for assigning IP addresses is recommended.

### Installation Procedure

Please note that this procedure will send the AXIS 241Q/241S's IP address, firmware version, product type and serial number to the Axis Internet Dynamic DNS Service. No personal information will be transferred.

1. Connect the AXIS 241Q/241S to your local network, using a standard network cable.
2. Connect power to the video server.
3. Wait for the Status indicator on the front of the video server to show a steady green, whereupon it will have received a dynamic IP address from a DHCP server on your network.
4. Wait 60 seconds and push the control button on the front panel once. The Status indicator on the front of the video server will flash green while it connects to the AXIS Internet Dynamic DNS service. When the registration process is complete, the indicator will return to steady green.
5. Visit [www.axiscam.net](http://www.axiscam.net) where you will be guided through the remainder of the installation. Please have the serial number of your product ready and follow the instructions on the screen.

The serial number (S/N) is located on the label on the underside of the AXIS 241Q/241S

6. Enter a password for the root user (administrator).
7. If required, accept the installation of **AMC** onto your workstation.

**Note:** AMC must be installed to view live images in Microsoft Internet Explorer. If your working environment restricts additional software components, you can configure your AXIS 241Q/241S to use a Java applet for updating the images. See the help file under Live View Config > Layout > Default Viewer for Internet Explorer for information. See also the *Technical Specifications*, on page 57.

8. The installation is now complete. Proceed to *Using the video server*, on page 16.

## Using the video server

The AXIS 241Q/241S can be used with most standard operating systems and supports Microsoft Internet Explorer 5.x or later. Other browsers may impose limitations when using the AXIS 241Q/241S. For more information please see [www.axis.com/techsup](http://www.axis.com/techsup)

### Accessing the video server

1. Start your browser.
2. Enter the IP address or host name of the AXIS 241Q/241S in the Location/Address field of your browser.
3. Enter the user name and password set by the administrator.
4. A video image is displayed in your Web browser.

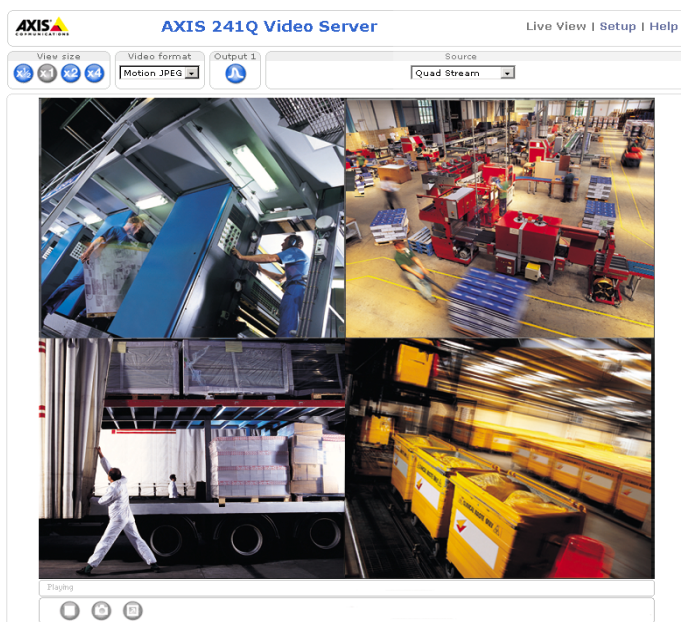
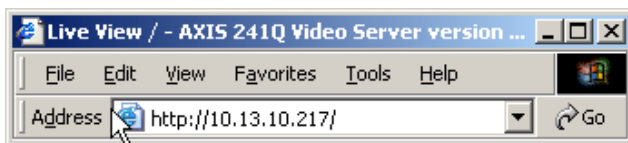

Axis Communications AB | MyCompany Link

- Notes:**
- To view streaming video in Microsoft Internet Explorer, you must set your browser to allow ActiveX controls and allow AMC (AXIS Media Control) to be installed on your workstation. AMC is required to view MPEG-4. If your workstation restricts the use of additional software components, the AXIS 241Q/241S can be configured to use a Java applet for updating JPEG images. Please see the online help for more information.
  - User functions in the AXIS 241Q/241S may have been customized to meet the specific requirements of the application. Consequently, the examples and functions in this section may differ from those displayed on your Live View page.



## The Live View page

If the AXIS 241Q/241S has been customized, the buttons and other items described below will be displayed accordingly on the Live View page. The following provides an overview of each button:



To resize the displayed image, click the **View Size** buttons: half-size ( $x_{1/2}$ ), full-size ( $x1$ ),  $x2$  or  $x4$ . This will not change the resolution of the image (not available in Sequence Mode).

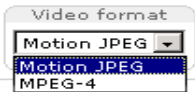

The **Video Format** drop-down list allows the video format on the Live View page to be temporarily changed.



The **Output** buttons control an output directly from the Live View page. These buttons are configured under **Setup > Live View Config > Layout**.



**Pulse** - click this button to activate the port for a defined period of time, e.g. to switch on a light for 20 seconds.

**Active/Inactive** - click these buttons to manually start and stop a connected device, e.g. switch a light on/off.



These buttons start/stop the **Sequence Mode**. This mode is created in **Setup > Live View Config > Sequence mode** and automatically displays the view from 2 or more video sources at set intervals.

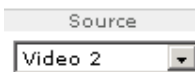

From the **Source** list, select the desired video image(s). The list can contain internal video sources, external video sources, or the Quad Stream view (AXIS 241Q only). The **Quad Stream** option displays all four video images in one stream.



The **Action** buttons trigger an event directly from the Live View page. These buttons are configured under **Setup > Live View Config > Layout**. Click these buttons to manually start and stop events.



Use the **Snapshot** button to capture a snapshot of the image currently being displayed in the window. Right-click on the image to save it in on your computer.

The **AMC viewer toolbar** (AXIS Media Control) is available in **Microsoft Internet Explorer only** and displays the following buttons:



The **Play/Stop** buttons start and stop the live video stream.



The **Snapshot** button takes a snapshot of the currently displayed image. The Snapshot function and the target directory for saving snapshots can be configured from AMC (AXIS Media Control), which is available from the Windows Control Panel (Internet Explorer only).



Click the **View Full Screen** button and the video image will fill the entire screen area. No other windows will be visible. Press Esc (Escape) on your keyboard to cancel full screen view.

Note that these AMC toolbar functions can also be accessed by right-clicking in the image.

For information on using Pan/Tilt/Zoom controls, please see page 37.

## Video Streams

---

The AXIS 241Q/241S provides several different image and video stream formats. The type to use depends on your requirements and on the properties of your network.

The Live View page in the AXIS 241Q/241S provides access to Motion JPEG and MPEG-4 video streams, as well as to single JPEG images. Other applications and clients can also access these video streams/images directly, without going via the Live View page.

### Stream Types

#### Motion JPEG

This format uses standard JPEG still images in the video stream. These images are then displayed and updated at a rate sufficient to create a stream that shows constantly updated motion.

The Motion JPEG stream uses considerable amounts of bandwidth, but also provides excellent image quality and access to each and every individual image contained in the stream.

Note also that multiple clients accessing Motion JPEG streams can use different image settings.

#### MPEG-4

This is a video compression standard that makes good use of bandwidth, and which can provide high-quality video streams at less than 1 Mbit/s.

- Notes:**
- MPEG-4 is licensed technology. The AXIS 241Q/241S includes one viewing client license. Installing additional unlicensed copies of the viewing client is prohibited. To purchase additional licenses, contact your Axis reseller.
  - All clients viewing the MPEG-4 stream must use the same image settings.

The MPEG-4 standard provides scope for a large range of different coding tools for use by various applications in different situations, and the AXIS 241Q/241S provides certain subsets of these tools. These are represented as **Video object types**, which are selected for use with different viewing clients. The supported video object types are:

- **Simple** - sets the coding type to H.263, as used by e.g. QuickTime™.
- **Advanced Simple** - sets the coding type to MPEG-4 Part 2, as used by AMC (AXIS Media Control)

When using MPEG-4 it is also possible to control the bit rate, which in turn allows the amount of bandwidth usage to be controlled. CBR (constant bit rate) is used to achieve a specific bit rate by varying the quality of the MPEG-4 stream. When using VBR (variable bit rate), the quality of the video stream is kept as constant as possible, at the cost of a varying bit rate.

## MPEG-4 protocols and communication methods

To deliver live streaming video over IP networks, various combinations of transport protocols and broadcast methods are employed.

- RTP (Realtime Transport Protocol) is a protocol that allows programs to manage the real-time transmission of multimedia data, via unicast or multicast.
- RTSP (Real Time Streaming Protocol) serves as a control protocol, to negotiate which transport protocol to use for the stream. RTSP is thus used by a viewing client to start a unicast session, see below.
- UDP (User Datagram Protocol) is a communications protocol that offers limited service for exchanging data in a network that uses the Internet Protocol (IP). UDP is an alternative to the Transmission Control Protocol (TCP). The advantage of UDP is that it is not required to deliver all data and may drop network packets when there is e.g. network congestion. This is suitable for live video, as there is no point in re-transmitting old information that will not be displayed anyway.
- Unicasting is communication between a single sender and a single receiver over a network. This means that the video stream goes independently to each user, and each user gets their own stream. A benefit of unicasting is that if one stream fails, it only affects one user.
- Multicast is bandwidth-conserving technology that reduces bandwidth usage by simultaneously delivering a single stream of information to multiple network recipients. This technology is used primarily on delimited networks (intranets), as each user needs an uninterrupted data flow and should not rely on network routers.

## How to stream MPEG-4?

Deciding on the combination of protocols and methods to use depends on your viewing requirements, and on the properties of your network.

### RTP+RTSP

This method (actually RTP over UDP and RTSP over TCP) should be your first consideration for live video, especially when it is important to always have an up-to-date video stream, even if some images do get dropped. This can be configured as multicast or unicast.

Multicasting provides the most efficient usage of bandwidth, especially when there are large numbers of clients viewing simultaneously. Note however, that a multicast broadcast cannot pass a network router unless the router is configured to allow this. It is thus not possible to multicast over e.g. the Internet.

Unicasting should be used for video-on-demand broadcasting, so that there is no video traffic on the network until a client connects and requests the stream. However, if more and more unicast clients connect simultaneously, the server will at some point become overloaded. There is also a maximum of 20 simultaneous viewers to be considered.

### RTP/RTSP

This unicast method is RTP tunneled over RTSP. This can be used to exploit the fact that it is relatively simple to configure firewalls to allow RTSP traffic.

### RTP/RTSP/HTTP or RTP/RTSP/HTTPS

These two methods can also be used to traverse firewalls. Firewalls are commonly configured to allow the HTTP protocol, thus allowing RTP to be tunneled.

## The AXIS Media Control

The recommended method of accessing live video (MPEG-4 and/or Motion JPEG) from the AXIS 241Q/241S is to use the AXIS Media Control (AMC) in Microsoft Internet Explorer in Windows. This ActiveX component is automatically installed on first use, after which it can be configured by opening the AMC Control Panel applet from the Windows Control Panel. Alternatively, right-click the video image in Internet Explorer.

## Other methods of accessing the video stream

Video/images from the AXIS 241Q/241S can also be accessed in the following ways:

- If supported by the client, the AXIS 241Q/241S can use Motion JPEG server push to display video. This option maintains an open HTTP connection to the browser and sends data as and when required, for as long as required.
- As single JPEG images in a browser. Enter e.g. the path:  
http://<ip>/axis-cgi/jpg/image.cgi?resolution=CIF
- Windows Media Player. This requires AMC and the MPEG-4 decoder to be installed. The paths that can be used are listed below, in the order of preference.
  - Unicast via RTP: axrtpu://<ip>/mpeg4/#/media.amp
  - Unicast via RTSP: axrtsp://<ip>/mpeg4/#/media.amp
  - Unicast via RTSP, tunneled via HTTP: axrtsphhttp://<ip>/mpeg4/#/media.amp
  - Unicast via RTSP, tunneled via HTTPS: axrtsphhttps://<ip>/mpeg4/#/media.amp
  - Multicast: axrtpm://<ip>/mpeg4/#/media.amp

- Notes:**
- <ip> = IP address.
  - # = video source number or the quad stream. This is set to 1 if omitted.

## Other MPEG-4 clients

Although it may be possible to use other clients to view the MPEG-4 stream, this is not guaranteed by Axis.

For some other clients, e.g. QuickTime™ the Video Object Type must be set to *Simple*. It may also be necessary to adjust the advanced MPEG-4 settings.

To assess the video stream from e.g. QuickTime™ the following path can be used:

```
rtsp://<ip>/mpeg4/#/media.amp
```

This path is for all supported methods, and the client will negotiate with the video server to determine exactly which transport protocol to use.

- Notes:**
- <ip> = IP address.
  - # = video source number or the quad stream. This is set to 1 if omitted.

# Configuring the video server

This section describes how to configure the AXIS 241Q/241S and is intended for:

- administrators, who have unrestricted access to all the Setup tools
- operators, who have access to the Video & Image, Live View Config and Event Configuration settings.

The AXIS 241Q/241S is configured from the Setup link, in a standard browser (see *Technical Specifications*, on page 57).

## Accessing the Setup tools

Follow the instructions below to access the Setup Tools from a browser.

1. Start the browser and enter the IP address or host name of the AXIS 241Q/241S in the location/address field.
2. The Live View page is now displayed. Click Setup to display the Setup tools.



## Video & Image Settings

The following descriptions show examples of the available features in the AXIS 241Q/241S. For details of each setting, please refer to the online help available from each page. Click  to access the online help.

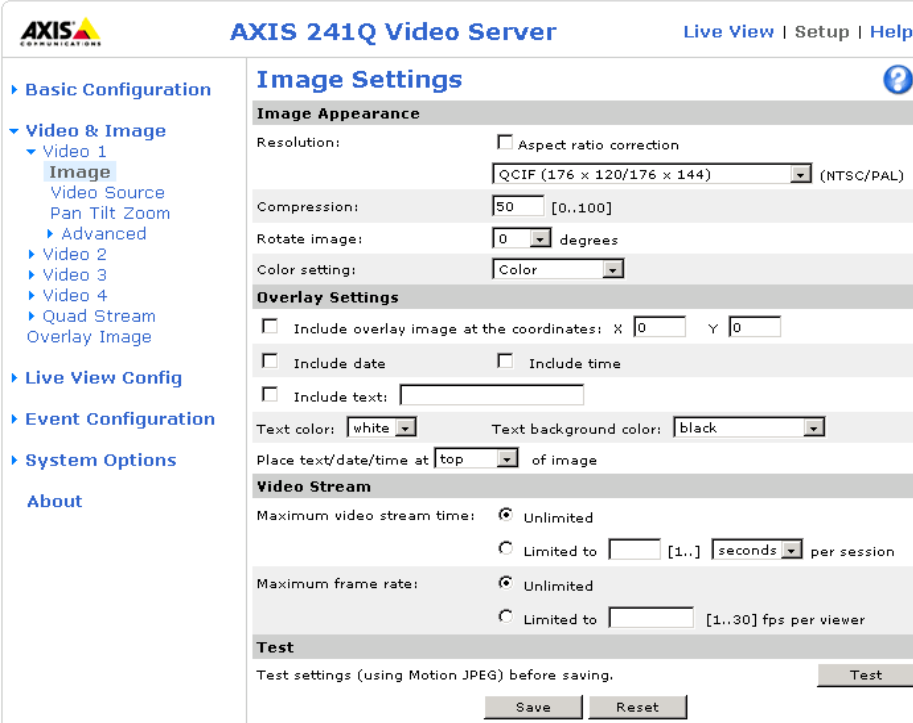

**AXIS 241Q Video Server** Live View | Setup | Help

**Image Settings** 

**Image Appearance**

Resolution:  Aspect ratio correction  
 QCIF (176 × 120/176 × 144) (NTSC/PAL)

Compression: 50 [0..100]

Rotate image: 0 degrees

Color setting: Color

**Overlay Settings**

Include overlay image at the coordinates: X 0 Y 0

Include date  Include time

Include text: [ ]

Text color: white Text background color: black

Place text/date/time at top of image

**Video Stream**

Maximum video stream time:  Unlimited  
 Limited to [ ] [1..] seconds per session

Maximum frame rate:  Unlimited  
 Limited to [ ] [1..30] fps per viewer

**Test**

Test settings (using Motion JPEG) before saving. Test

Save Reset

## Image Settings

### Image Appearance

Modify the **Image Appearance** to optimize the video images according to your requirements.

All configuration of images and overlays will affect the performance of the video server, depending on the usage and the available bandwidth.

- High resolution generates larger files
- Lower compression improves image quality, but generates larger files
- Black & White uses less bandwidth than Color
- Rotating the image 90 or 270 degrees will lower the maximum frame rate

See also the specifications for frame rates and bandwidth on page 60.



## Overlay Settings

Use these settings to include a) an image as an overlay, and/or b) the date and time, along with text of your own.

Text overlays are all included on one line at the top or bottom of the video image. Image overlays can be placed anywhere in the video image.

To upload an overlay image, see below.



**Example:** If there is information in a monitored area that you do not wish to disclose, you can mask it out by placing an overlay image on top. Setting the overlay image anywhere in the video image using coordinates allows precision detail masking.

## Video Stream

The **Maximum video stream time** can be set as *Unlimited*, or a **maximum stream time** per session in seconds, minutes or hours can be defined. When the set time has expired, a new stream can be started by refreshing the page in the Web browser. Note that the maximum video stream time does not apply to clients connecting via multicast.

To avoid bandwidth problems on the network, the **frame rate** allowed to each viewer can also be limited. Select either *Unlimited* or define a maximum frame rate per viewer.

For a preview of the image and overlay settings before saving, click **Test**. When you are satisfied with the settings, click **Save**.

## Video Source Settings

Enter a descriptive name for the **Video source**.

Black borders surrounding the image can be eliminated by adjusting the **offset position**. See the online help for more information.

### AXIS 241S only:

Select the physical connector the video source is connected to, **BNC** or **Y/C**. The AXIS 241S supports conversion between composite video and Y/C (s-video) using an ACC Y/C to BNC cable.

- **BNC** (composite video) connects a standard video camera or other video equipment
- **Y/C** (S-video) connects a Y/C (S-video) camera or other video equipment

## Pan Tilt Zoom

The settings here are for configuring preset positions and the PTZ Control Queue. For detailed information on these settings, please see the online help. For an overview of Pan Tilt Zoom functionality, please see page 37.

## Advanced - MPEG-4 Settings

Tools for adjusting the MPEG-4 settings and for controlling the video bit rate.

The MPEG-4 standard provides many different coding tools for various applications in different situations. As most MPEG-4 clients do not support all of these tools, it is usual to instead define and use subsets for different clients or groups of clients. These settings allow you to define the type of viewing client to use.

Adjusting the maximum bit rate and setting it to variable or constant is a good way of controlling the bandwidth used by the MPEG-4 video stream.

For more information on these advanced settings, please see the online help.

## Quad Stream Settings (AXIS 241Q only)

The settings are the same as the individual image settings and are active only when the quad stream view is selected, see *Image Settings*, on page 24.

## Overlay Image Settings

An overlay image is an image superimposed over the video image.

Follow these instructions to upload and use an overlay image:

1. To upload the file (the image) to the AXIS 241Q/241S, click the **Browse** button and locate it on your computer or server.
2. Click the **Upload** button and follow the on-screen instructions.
3. The image is now available in the **Use overlay image** drop-down list.
4. Click **Save**.

### Overlay image requirements:

Image Formats	Image Size
<ul style="list-style-type: none"> <li>• Windows 24-bit BMP (full color)</li> <li>• Windows 4-bit BMP (16 colors)</li> <li>• OS/2 4-bit BMP (16 colors)</li> </ul>	The height and width of the overlay image in pixels must be exactly divisible by 4.

### Overlay image limitations:

- The maximum overlay image size supported by the AXIS 241Q/241S is the same as the maximum image resolution. See Technical Specifications, on page 57.
- When a text overlay is also used, this reduces the amount of space available to the overlay image. To keep the text readable at lower resolutions, the text overlay occupies proportionally more and more space, i.e., 16 pixels in height at 640x480, 32 pixels at 320x240 and 64 pixels at 160x120.
- If the overlay is initially positioned so that part of it is outside the video image, it will be relocated so that it appears over the video image, i.e. it is always the entire image that is displayed.

Please see the online help [?](#) for more information.

# Live View Config

## Layout

These are the tools for deciding the layout of the Live View page.

The layout can be set in 3 ways:

- Use Axis look - the layout is unchanged.
- Use custom settings - modify the default page with your own colors, images etc. Click the **Configure** button and see the following page.
- Own Home Page - Upload and use your own custom made page as the default web page. Click the **Configure** button and see the following page.

The other settings on this page concern which other features to include, e.g. buttons and links. See page 29 for more information.

## Customizing the default page

The appearance of the default AXIS 241Q/241S Live View page can be customized to suit your own requirements, or you can upload and use your own home page. To upload your own files, click the **Upload/Remove** button and see the description below.

Note that the setup address is `http://<ip address>/operator/basic.shtml`

## Upload Own Web Files

Your own web files, background picture, color etc. must first be uploaded to the AXIS 241Q/241S in order to be available for selection in the Custom Settings setup dialog. Once uploaded, the files are shown in the drop-down list.

1. Enter the path to the file, e.g. a file located on your workstation or click the **Browse** button.
2. Select the user level for the uploaded file. Setting the user access level means that you have complete control over which pages can be viewed by which users.
3. When the path is shown correctly in the text field, click the **Upload** button.

All uploaded files are shown in the list in the lower section of the page. To remove a file, check the box provided next to it and then click the **Remove** button.

- To use your uploaded file, click the radio button and select the file from the drop-down list by **Own**:
- To use an external file located somewhere other than in the AXIS 241Q, click the radio button and enter the URL by **External**:

## Own Home Page

To use a previously uploaded web page as the default page, check the checkbox, select the page from the drop-down list and click **OK**.

## User Defined Links

Enter a descriptive name and enter the URL in the provided field. The link will appear on the **Live View** page.

User defined CGI links can be used to issue HTTP API requests, e.g. PTZ commands.

Example:

1. Check **Show Custom Link 1**
2. Enter a descriptive name, e.g. **CAM1 Start PTZ**.
3. Enter the cgi link:  
`http://192.168.0.125/axis-cgi/com/ptz.cgi?camera=1&continuouspaniltmove=30,-30`
4. Check **Show Custom Link 2**.
5. Enter a descriptive name, e.g. **CAM1 Stop PTZ**.

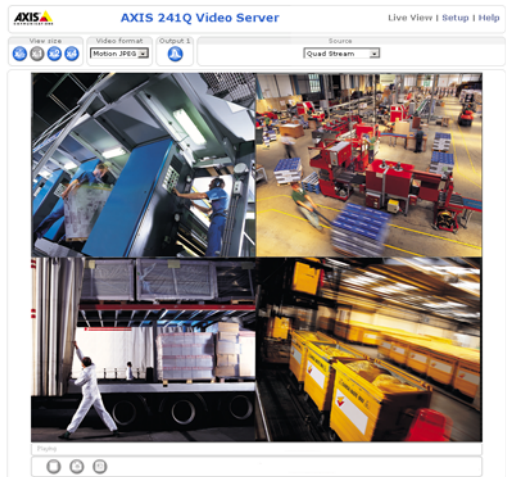

Axis Communications AB | MyCompany Link

↑  
User Defined Links

6. Enter the cgi link:

`http://192.168.0.125/axis-cgi/com/ptz.cgi?camera=1&continuouspaniltmove=0,0`

7. These links will appear in the web interface and can be used to control the PTZ camera

For more information on the Axis HTTP API, see the Support / Developer pages on the Axis Web site at <http://www.axis.com>. See also the section on PTZ, on page 37.

## Action Buttons

These buttons can be used to manually trigger and stop an event from the Live View page. See *Event Servers*, on page 32. The snapshot button allows you to take a snapshot of the video stream and save it to a computer.

## Output Buttons

These buttons are used to control the outputs on the AXIS 241Q/241S and thus the equipment connected to them, e.g. to switch a light on or off:

- The Pulse button activates the port for a defined period
- Active/Inactive displays 2 buttons, one for each action (on/off)

## Default Video Format in Internet Explorer for Windows

Select the default format to use on the Live View page. Checking the box for Show video format selection displays a drop-down list on the Live View page allowing you to temporarily change the format.

## AMC (AXIS Media Control) Settings

Checking the Show viewer toolbar box displays the AMC toolbar under the video stream.

By checking the Enable MPEG-4 decoder installation box, it is also possible for the Administrator to enable or disable the installation of the MPEG-4 decoder. This is used to prevent the installation of unlicensed copies. Further decoder licenses can be purchased from your Axis dealer.

## Default Viewer for Motion JPEG

Select the appropriate radio button to define the method for viewing moving video images, depending on your browser and settings.

Please see the online help  for more information.

## HTML Examples

You can add live video from your AXIS 241Q/241S to your own web site. The video server can send Motion-JPEG or MPEG-4 images to up to 20 simultaneous connections, although an administrator can restrict this to fewer. This does not affect or include the number of multicast viewers.

Enter the Image Type, Image size and other settings to suit your web page and click Update.

## External Video

You can add links to other Axis network devices available over the network. These sources can be displayed on the Live View page, just as if they were video sources connected directly to the AXIS 241Q/241S.

Click the **Add** button to open the External Video Source Setup dialog, which is used to make all the necessary settings.

Example of a path to an external video source:

```
http://192.168.0.125/axis-cgi/mjpeg/video.cgi
```

## Sequence Mode

The live view page can be configured to rotate through selected internal and/or external video sources, in order or randomly. PTZ preset positions can also be included.



Select the desired video sources and enter the time in seconds to display each source (up to 59 minutes). Click Save.

The Sequence buttons will appear on the Live View page to allow the viewer to start and stop the sequence mode.

Please see the online help  for more information.

## Event Configuration

This section describes how to configure the AXIS 241Q/241S for alarm handling. Various actions can be configured to run when certain types of events occur.

Event type	A set of parameters describing how and when the video server is to perform certain actions	
Triggered Event (see page 33)	- the circumstances that start an event	e.g. at a signal from an external device, such as a door switch or a motion sensor
Scheduled Event (see page 34)	- the circumstances that start an event	e.g. at a pre-programmed time
Action	- what occurs when the event runs	e.g. video images uploaded to an FTP server, email notification sent, etc.

### Event Servers

Event Servers are used for e.g. receiving uploaded image files and/or notification messages. To set up Event server for your AXIS 241Q/241S, go to **Setup > Event Configuration > Event Servers** and enter the required information according to the selected server type.

Server type	Purpose	Information required
FTP Server	<ul style="list-style-type: none"> <li>receives uploaded images</li> </ul>	<ul style="list-style-type: none"> <li>Descriptive name of your choice</li> <li>User Name and Password (to FTP server)</li> <li>Upload path, e.g. images/</li> <li>Port number</li> <li>Use passive mode if there is a firewall between the video server and FTP server</li> </ul>
HTTP Server	<ul style="list-style-type: none"> <li>receives notification messages</li> <li>receives uploaded images</li> </ul>	<ul style="list-style-type: none"> <li>Descriptive name of your choice</li> <li>URL (address)</li> <li>User Name and Password (to HTTP server)</li> <li>Proxy address/Proxy port (if required)</li> <li>Proxy User Name and Password (if required)</li> </ul>
TCP Server	<ul style="list-style-type: none"> <li>receives notification messages</li> </ul>	<ul style="list-style-type: none"> <li>Descriptive name of your choice</li> <li>User Name and Password (for TCP server)</li> <li>Port number</li> </ul>

For details on each setting, please refer to the online help  available from each web page.

**Note:** Pre-trigger and Post-trigger buffers will be lost if the connection to the event server fails.

When the setup is complete, the connection can be tested by clicking the Test button (the connection test takes approximately 10 seconds).



## Event Types

An Event Type is a set of parameters describing how and when the video server is to perform certain actions.

**Example:** If somebody walks past the connected camera, and an event has been configured to act on this, the video server can e.g. record and send video images to an FTP server, or send a notification email to a pre-configured email address with a pre-configured message. Video images can be sent as an attachment with the email.

Name	Status	Enabl.	Priority	Trig./Sched.	Actions*
My Event	Inactive	Yes	Normal	Manual	Fu
Scheduled up...	Inactive	No	Normal	Time frame	Hn
Triggered up...	Inactive	Yes	Normal	Video loss	En

\*Fu=FTP upload, Hu=HTTP upload, Eu=Email upload, O=Output port, En=Email notification, Hn=HTTP notification, Tn=TCP notification, P=PTZ preset.

### Triggered Event

A triggered event is activated by e.g.

- a push button connected to an input port on the video server
- detected movement in a configured motion detection window
- a lost signal from a video source
- a manually activated action e.g. from an action button in the web interface
- on restart (reboot) after e.g. power loss

### How to set up a triggered event

This example describes how to set the video server to upload images when the main door is opened:

1. Click **Add triggered** on the Event types page.
2. Enter a descriptive name for the event, e.g. Main door.
3. Set the **priority** - High, Normal or Low (see online help files).
4. Select which **Video Source** the event is to act on, e.g. Video 1 on Main door.
5. Set the **Respond to Trigger...** parameters when the event is to be active, e.g. only after office hours
6. Select the trigger alternative from the **Triggered by...** drop-down list, e.g. an Input port with a connected sensor if the door is opened.
7. Set the **When Triggered...** parameters, i.e. set what the video server should do if the main door is opened, e.g. upload images to an FTP server.
8. Click **OK** to save the event in the Event Types list.

Please see the online help  for descriptions of each available option.

## Pre-trigger and Post-trigger buffers

This function is very useful when checking to see what happened immediately before and after a trigger, e.g. 2 minutes before and after a door was opened. Check the **Upload images** checkbox under **Event Types > Add Triggered... > Triggered by...** to expand the web page with the available options.

**Buffer size** - AXIS 241Q - up to 36 MB buffer; AXIS 241S - up to 9 MB buffer. The maximum length of time of the pre-/post-buffer depends on the selected image size and frame rate.

**Include pre-trigger buffer** - images stored internally in the server from the time immediately preceding the trigger. Check the box to enable the pre-trigger buffer, enter the desired length of time and specify the required image frequency.

**Include post-trigger buffer** - contains images from the time immediately after the trigger. Configure as for pre-trigger.

**Note:** If the pre- or post-buffer is too large for the AXIS 241Q's internal memory, the frame rate will be reduced and individual images may be missing. If this occurs, an entry will be created in the unit's log file.

**Continue image upload (unbuffered)** - enable the upload of images for a fixed length of time. Specify the length of time for the uploaded recording, in seconds, minutes or hours, or for as long as the trigger is active. Finally, set the desired image frequency to the maximum (the maximum available) or to a specified frame rate. The frame rate will be the best possible, but might not be as high as specified, especially if uploading via a slow connection.

## Scheduled Event

A **Scheduled event** can be activated at pre-set times, in a repeating pattern on selected weekdays.

### How to set up a scheduled event

This example describes how to set the video server to send an email notification with saved images from a set time:

1. Click **Add scheduled** on the **Event types** page.
2. Enter a descriptive **name** for the event, e.g. Scheduled email.
3. Set the **priority** (High, Normal or Low).
4. Select the **video source** i.e. the source the event should act on, e.g. Video 2 in Storage room.
5. Set the **Activation Time** parameters (24h clock) when the event should be active, e.g. start on Sundays at 13.00 with a duration of 12 hours.
6. Set the **When Activated...** parameters i.e. set what the video server should do at the specified time e.g. send uploaded images to an email address.

7. Click OK to save the Event in the Event Types list.

Please see the online help  for descriptions of each available option.

## Motion Detection

In the Motion Detection menu, you can configure the video source(s) for motion detection. The motion detection feature is used to generate an alarm whenever movement occurs (or stops) in the image. The AXIS 241Q can use a maximum of 40 Include/Exclude windows, whilst the AXIS 241S can use a maximum of 10.

- Include windows target specific areas within the image
- Exclude windows are areas to be ignored within the Include window

Once configured, the motion detection windows will appear in a list when motion detection is selected to trigger an event. See *How to set up a triggered event* above.

**Note:** Using the motion detection feature may decrease overall performance in the video server.

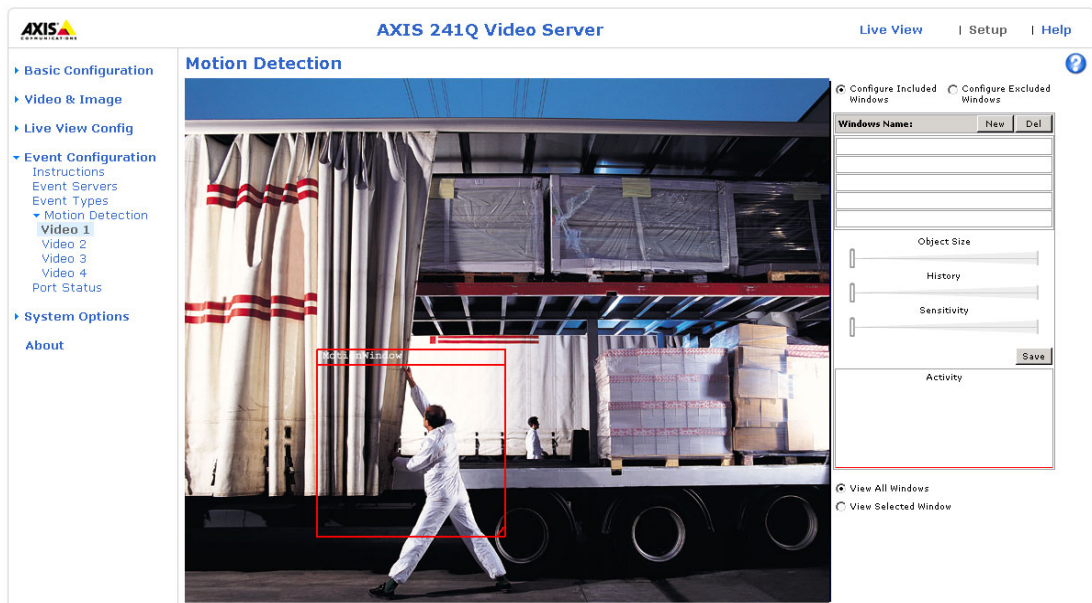

The screenshot displays the 'Motion Detection' configuration page for the 'AXIS 241Q Video Server'. The left sidebar contains a navigation menu with options like 'Basic Configuration', 'Video & Image', 'Live View Config', 'Event Configuration', and 'System Options'. The main area shows a video feed with a red bounding box labeled 'Video 1 Window' around a person. The right-hand panel includes radio buttons for 'Configure Included Windows' (selected) and 'Configure Excluded Windows'. Below this is a table with columns for 'Windows Name', 'New', and 'Del'. Further down are sliders for 'Object Size', 'History', and 'Sensitivity', followed by a 'Save' button and radio buttons for 'View All Windows' and 'View Selected Window'.

### How to configure Motion Detection

This example describes how to configure Video 1 for motion detection:

1. Click Motion Detection in the Event Configuration menu.
2. Select video source 1 from the menu (AXIS 241Q only).
3. Click the Configure Included Windows radio button.
4. Click New.
5. Enter a descriptive name of your choice under Windows name.

6. Adjust the size (drag the bottom right-hand corner) and position (click on the text at the top and drag to the desired position).
7. Adjust the Object size, History and Sensitivity profile sliders (see table below for details). Any detected motion within an active window is then indicated by red peaks in the **Activity** window (the active window has a red frame).
8. Click **Save**.

If there are parts of the Include window that you wish to exclude, click the **Configure Excluded Windows** radio button and repeat steps 1-8 above.

Please use the online help  for descriptions of each available option.

Parameter	Size	History	Sensitivity
High	Only very large objects trigger motion detection	An object that appears in the region will trigger the motion detection for a long period	Ordinary colored objects against ordinary backgrounds will trigger the motion detection
Low	Even very small objects trigger motion detection	An object that appears in the region will trigger motion detection for only a very short period	Only very bright objects against a dark background will trigger motion detection
Default values	Low	Medium to High	Medium to High

### Examples:

- Avoid triggering on small objects in the image by selecting a high size level.
- To trigger motion detection as long as there is activity in the area, select a high history level.
- To only detect flashing light, low sensitivity can be selected. In other cases, a high sensitivity level is recommended.

## Port Status

Under **Event Configuration > Port Status**, there is a list that shows the status for the connected inputs and outputs of the AXIS 241Q/241S. This is for the benefit of an operator, who cannot access the **System Options** section.

**Example:** If the Normal state for a push button connected to an input is set to Open circuit, as long as the button is not pushed, the state is inactive. If the button is pushed, the state of the input changes to active.

## Pan Tilt Zoom

If the AXIS 241Q/241S has been appropriately configured, the Live View page will display the controls available for the installed Pan Tilt Zoom (PTZ) device. The administrator can enable/disable the controls for specified users.



The exact controls shown depends on the make and model of PTZ device. There may be e.g. Focus and Iris bars available as well, but the most common controls are;

- the Pan bar - moves the camera to the right and left
- the Tilt bar - tips the camera up and down
- the Zoom bar - zooms the view in and out. Note that this is only available if the camera is fitted with a zoom lens.

Clicking on the bars themselves or on the arrows at the end of the bars will move the camera to a new position. The type of movement and the location of this new position depends on the type of PTZ driver.

When controlling the camera using a relative PTZ driver (see the bars in the illustration above) the new position will be relative to the previous position, e.g. left of, below, above, etc. Clicking the bar further from the center results in a larger movement.

In contrast, when using an **absolute** driver, each position on the bar (see right) represents a defined position in the device's range of movement, with the center of the bar representing the point midway between the two extremes of movement.



Clicking a position directly on the bar moves the camera directly to the new position in one smooth movement. Clicking on the arrows at the ends of a bar causes a stepped, incremental change.

### Click-in-image

The PTZ device can also be controlled using **click-in-image** movement, which can also be of relative or absolute type.

Absolute click-in-image movement means that the camera view will center on the absolute position that was clicked.

Relative click-in-image movement can be used when using the AXIS Media Control with Microsoft Internet Explorer, and when using a PTZ driver that supports it. By clicking and holding the mouse button down in the image, the PTZ device moves the camera in that direction, relative to the center of the image. The further from the center the image is clicked, the greater the movement.

### Preset Positions

Also available with many PTZ devices are **Preset positions**. These presets are selected from the drop-down **Source** list on the Live View page and will move and/or zoom the camera to a pre-defined position, i.e. to cover an area of particular interest. Events can also be configured to go to preset positions when triggered. For information on setting up preset positions, please see the online help.

### PTZ Control Queue

This indicates that PTZ queueing has been enabled. This means that the time the user is in control of the PTZ device is limited and that a user queue has been set up. Use the buttons to request or release control of the PTZ controls. For information on how to set up the control queue, please see the online help.

### Using CGI links to control PTZ devices

User-defined CGI links on the Live View page can be used to issue HTTP API requests, e.g. PTZ commands. These links are configured in the Live View Layout settings, see page 29.

## Installing PTZ Devices

The AXIS 241Q/241S supports several PTZ devices. Please see [www.axis.com](http://www.axis.com) for a complete list of supported devices, and to obtain the correct driver. Follow the instructions below to install a PTZ device:

1. Using an appropriate cable, connect the device to your selected port (RS-232 or RS-485). These ports are available via the D-Sub connector and the I/O terminal connector, respectively. See pages 48 and 49 for more information.
2. In the setup tools, go to **Setup > System Options > Ports & Devices** and then select the port (RS-232 or RS-485) to configure.
3. Select **Pan Tilt Zoom** from the Usage drop-down list.
4. Click **Upload** to install a PTZ driver.  
(PTZ drivers are available from the Axis Web site at [www.axis.com](http://www.axis.com))
5. Click **Port Options...** to modify the port settings. The default values correspond to the values specified by the PTZ driver.
6. From **System Options > Ports & Devices**, select the port configured for PTZ and then select the video source to use with the device.
7. If required, click the **Advanced Options** button to make further settings.

**Note:** Advanced users and application developers can also use the Axis Application Programming Interface and HTTP specification for generic control of PTZ devices using CGI commands or a TCP/IP client. Please refer to the Axis Website at [www.axis.com](http://www.axis.com) for further information.

## System Options

---

### Security

User access control is enabled by default, when the administrator sets the root password on first access. New users are authorized with user names and passwords, or the administrator can choose to allow anonymous viewer login to the Live View page, as described below:

Users - the user list displays the authorized users and access levels:

Viewer	Provides the lowest level of access, which only allows the user access to the Live View page
Operator	An Operator can view the Live View page, create and modify event types and adjust certain other settings. The Operator does not have access to the Systems Options configuration pages.
Administrator	An administrator has unrestricted access to the Setup Tools and can determine the registration of all other users.

User Settings - check the corresponding checkboxes to enable:

- **Anonymous viewer login** - allows any viewer direct access to the Live View page.
- **Anonymous PTZ control login** - allows any viewer access to the Pan Tilt Zoom controllers on the Live View page (if Pan/Tilt/Zoom is available).

### IP Address Filtering

**Allowed IP Addresses** - The administrator can add up to 256 IP addresses to this list. If the IP address filtering checkbox is checked, the AXIS 241Q/241S will only allow access to requests coming from the IP addresses in the list.

The users from these IP addresses need to be specified in the user list with the appropriate access rights (**User**, **Operator** or **Administrator**).

**Referrals** - to prevent unauthorized sources from including the video stream from the AXIS 241Q/241S into external Web pages, check the Referrals box and enter the IP address or Host name of the computer that hosts the Web pages with the included video stream. Multiple IP addresses/host names can be defined and are separated by semicolons(;

- Notes:**
- If the referrals feature is enabled and you wish to also allow normal access to the Live View page, the product's own IP address or host name must be added to the list of allowed referrers.
  - Restricting referrers has no effect on an MPEG-4 video stream. To restrict an MPEG-4 stream, IP address filtering must be enabled.
  - Restricting referrers is of greatest value when not using IP address filtering. If IP address filtering is used, then the allowed referrers are automatically restricted to those allowed IP addresses.



## HTTPS

For greater security, the AXIS 241Q/241S can be configured to use HTTPS (Hypertext Transfer Protocol over SSL (Secure Socket Layer)). That is, all communication that would otherwise go via HTTP will instead go via an encrypted HTTPS connection.

**Certificate** - to use HTTPS for communication with the AXIS 241Q/241S, a **Certificate** must be created using one of these methods:

- A self-signed certificate can be created in the video server, but this does not guarantee the same level of security as an official certificate.
- An official certificate issued by a CA (Certificate Authority). A CA issues and manages security credentials and public keys for message encryption.
  1. Click either **Create self-signed certificate** or **Create Certificate Request** and enter the required information in the provided fields
  2. Click **OK**.
  3. **Create self-signed certificate** generates and installs a certificate which will be displayed under **Installed Certificate**.  
**Create Certificate Request** generates a PEM formatted request which you copy and send to a CA for signing. When the signed certificate is returned, click **Install signed certificate...** to install the certificate in the AXIS 241Q/241S.
  4. Set the **HTTPS Connection Policy** for the administrator, Operator and Viewer to enable HTTPS connection (set to HTTP by default)

Please refer to the home page of your preferred CA for information on where to send the request etc. For more information, please see the online help 

## Date & Time

**Current Server Time** - displays the current date and time (24h clock). The time can be displayed in 12h clock format in overlay images.

**New Server Time** - Select your time zone from the drop-down list and check the daylight saving time changes, if desired.

From the **Time Mode** section, select the preferred method to use for setting the time:

- **Synchronize with computer time** - sets the time from the clock on your computer.
- **Synchronize with NTP Server** - the video server will obtain the time from an NTP server every 60 minutes. Specify the NTP server's IP address or host name.

**Note:** Note that if using a host name for the NTP server, a DNS server must be configured under TCP/IP settings. See **Network > Advanced TCP/IP Settings** below.

- **Set manually** - this option allows you to manually set the time and date.

**Date & Time Format Used in Images** - specify the formats for the date and time (12h or 24h) displayed in the Live View video streams.

Use the predefined formats or use your own custom date and time formats. See **File Naming & Date/Time Formats** in the online help  for information on how to create your own file formats.

## Network - Basic TCP/IP Settings

### IP Address Configuration

The IP address of the video server can be set automatically via DHCP, or a fixed IP address can be set manually. DHCP is enabled by default. To use a fixed IP address, you must also enter the correct subnet mask and default router.

- Notes:**
- DHCP is a protocol for automatic IP address assignment on a network. IP address assignment via DHCP may lead to the situation where the IP address changes and you lose contact. Configure the options for notification of IP address change (under Services) to receive notification from the video server when the IP address changes.
  - Alternatively, if your DHCP server can update a DNS server, you can access the AXIS 241Q/241S by host name which is always the same, regardless of the IP address.

### Services

**Options for notification of IP address change** - if the IP address for the video server changes, e.g. automatically by DHCP, you can choose to be notified of the change. Click **Settings...** and enter the required information.

**AXIS Internet Dynamic DNS Service** - If the AXIS 241Q/241S Video Server has been registered with the Axis Internet Dynamic DNS service and the IP address for the product changes, the service is updated to reflect the change. Check the box to enable/disable automatic updates.

The domain name currently registered at the Axis Internet Dynamic DNS service for your product can at any time be removed. To do this click **Settings...** and follow the instructions.

For more information, please refer to the online help .

## Network - Advanced TCP/IP Settings

### DNS Configuration

DNS (Domain Name Service) provides the translation of host names to IP addresses on your network.

Obtain DNS server address via DHCP - automatically use the DNS server settings provided by the DHCP server. Click the View button to see the current settings.

Use the following DNS server address - enter the desired DNS server by specifying the following:

Domain name - enter the domain(s) to search for the host name used by the AXIS 241Q/241S. Multiple domains can be separated by semicolons (;). The host name is always the first part of a Fully Qualified Domain Name, e.g. myserver is the host name in the Fully Qualified Domain Name myserver.mycompany.com where mycompany.com is the Domain name.

DNS servers - enter the IP addresses of the primary and secondary DNS servers.

### Host Name Configuration

The AXIS 241Q/241S can be accessed using a host name, instead of an IP address. The host name is usually the same as the assigned DNS Name.

For more information, please see the online help 

### Link-Local Address

This is enabled by default and assigns the AXIS 241Q/241S an additional IP address for use with UPnP™. The AXIS 241Q/241S can have both a Link-Local IP and a static/DHCP-supplied IP address at the same time - these will not affect each other.

### HTTP

The default HTTP port number (80) can be changed to any port within the range 1024-65535. This is useful for e.g. simple port mapping.

### RTSP

The RTSP protocol allows a connecting client to start an MPEG-4 stream. Enter the RTSP port number to use. The default setting is 554.

## Network Traffic

The default setting is **Auto-negotiate** which means that the correct speed is automatically selected. If necessary, you can set the connection speed by selecting it from the drop-down list.

**Maximum bandwidth** - Specify, in Mbit/s or kbit/s, the maximum bandwidth that the video server is allowed to use on your network. This is a useful function when connecting your video server to busy or heavily loaded networks. The default setting is **Unlimited**.

**Note:** When using MPEG-4 as the video format, remember that setting a maximum bandwidth value here may create problems for individual video streams if the maximum value is less than the sum of the bit rates set for the video streams.

For more information, please see the online help 

## SOCKS

SOCKS is a networking proxy protocol. The AXIS 241Q/241S can be configured to use a SOCKS server to reach networks on the other side of a firewall/proxy server. This functionality is useful if the video server is located on a local network behind a firewall, but notifications, uploads, alarms, etc., need to be sent to a destination outside the local network (e.g. to the Internet).

## SMTP (email)

Enter the host names or addresses for your primary and secondary mail servers in the fields provided, to enable event and error email messages from the video server to predefined addresses, via SMTP.

If the mail server requires SMTP authentication, check the box for **Use authentication to log in to this server** and enter the user name and password used for logging in. Several different methods of authentication are available. See the online help for more information.

## UPnP™

The video server includes support for UPnP™ in Windows ME and Windows XP. UPnP™ is enabled by default.

**Note:** UPnP™ must be installed on your workstation. To do this, open the Control Panel from the Start Menu and select **Add/Remove Programs**. Select **Add/Remove Windows Components** and open the **Networking Services** section. Click **Details** and then select UPnP™ as the service to add.

## RTP (Multicast)/MPEG-4

These settings are the IP address, port number, and Time-To-Live value to use for the video stream(s) in multicast MPEG-4 format. Only certain IP addresses and port numbers should be used for multicast streams. For more information, please see the online help.

## Ports & Devices

I/O Ports - the pinout, interface support and the control and monitoring functions provided by this connector are described in *Unit Connectors*, on page 48.

## Maintenance

- **Restart** - The unit is restarted without changing any of the settings. Use this method if the unit is not behaving as expected.
- **Restore** - The unit is restarted and most current settings are reset to factory default values. The settings that will not be reset are as follows:
  - the boot protocol (DHCP or static)
  - the static IP address
  - the default router
  - the subnet mask
  - the system time
- **Default** - The default button should be used with caution. Pressing this will return all of the video server's settings to the factory default values (including the IP address)

**Upgrade Server** - See *Upgrading the Firmware*, on page 52.

**Backup** - To take a backup of all of the parameters, and any user-defined scripts, click this button. If necessary, it is then possible to return to a previous configuration if settings are changed and there is unexpected behavior.

**Restore** - click the **Browse** button to locate the saved backup file (see above) and then click the **Restore** button. The settings will be restored to the previous configuration.

**Note:** Backup and Restore can only be used on the same unit running the same firmware. This feature is not intended for multi-configurations or for firmware upgrades.

## Support

The support overview page provides valuable information on troubleshooting and contact information, should you require technical assistance.

**Logs & Reports** - when contacting Axis support, please be sure to provide a valid Server Report with your query.

**View Information** - The Log report and the Parameter List also provide valuable information for troubleshooting and when contacting Axis' support service.

**Configuration:**

**Log Level for Log Files** - from the drop-down list, select the level of information to be added to the Log file

**Log Level for Email** - from the drop-down list, select the level of information to send as email and enter the destination email address.

### Advanced

Scripting is an advanced function that provides the possibility to customize and use scripts. This function is a very powerful tool.

#### Caution!

Improper use may cause unexpected behavior or even cause loss of contact with the unit. If a script does cause problems, reset the unit to its factory default settings. A backup file may be of use to return the unit to its latest configuration).

**Axis strongly recommends that you do not use this function unless you fully understand the consequences.** Note that Axis support does not provide assistance for problems with customized scripts.

For more information, please visit the Developer pages at [www.axis.com/developer](http://www.axis.com/developer)

**Plain Config** - this function is for the advanced user with experience of Axis video server configuration. All parameters can be set and modified from this page. Help is available from the standard help pages.

## Resetting to the Factory Default Settings

To reset the AXIS 241Q/241S to the original default settings, go to the **System Options > Maintenance** web page (described in *Maintenance*, on page 45) or use the control button on the AXIS 241Q/241S, as described below:

### Using the Control Button

Follow the instructions below to reset the AXIS 241Q/241S to the factory default settings using the Control Button.

1. Switch off the AXIS 241Q/241S by disconnecting power.
2. Press and hold the Control button while reconnecting the power.
3. Keep the Control button pressed until the **Status Indicator** displays yellow (this may take up to 15 seconds).
4. Release the Control button.
5. When the Status Indicator changes to Green (may take up to 1 minute), the process is complete and the AXIS 241Q/241S has been reset.
6. Re-install the AXIS 241Q/241S, as described elsewhere in this manual.

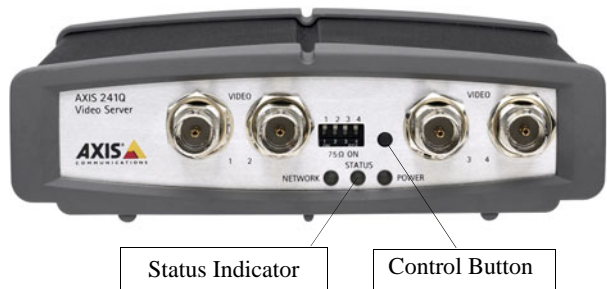

## Unit Connectors

---

The following connectors are described in this section:

- *The D-Sub Connector*, on page 48
- *The I/O Terminal Connector*, on page 49
- *COM Ports RS-232 and RS-485*, on page 50
- *Y/C to BNC Cable (AXIS 241S only)*, on page 51

### The D-Sub Connector

The AXIS 241Q/241S provides one 9-pin D-sub connector, providing the physical interface for an RS-232 port, used for connecting accessory equipment; such as stand-alone PTZ devices for the remote control of connected video cameras.

Pin assignment table and pinout of the RS-232 connector:

Pin	Function
1	CD
2	- RXD
3	- TXD
4	DTR
5	GND
6	DSR
7	RTS
8	CTS
9	RI

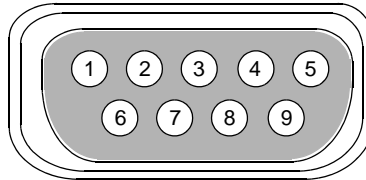



## The I/O Terminal Connector

This section describes the pinout and interface support provided by the 12-pin I/O terminal connector, which includes:

- 4 digital transistor outputs
- 4 digital inputs
- an RS-485 interface
- auxiliary power and GND

The terminal connector is used in applications for e.g. motion detection, event triggering, time lapse recording, alarm notification via email, image storage to FTP locations, etc.

- **Inputs** - e.g. a push button. If the button is pressed, the state changes, and the input will be active (shown under **Event Configuration > Port Status**).
- **Outputs** - e.g. an alarm device that can be activated from Output buttons on the **Live View** page or as an action to an **Event Type**. The output will show as active (in **Event Configuration > Port Status**), if the device is activated.

Pin	Function	Description
1	Auxiliary DC Power Input	7-20 VDC/min 7W. Electrically connected in parallel with PS-k power connector, provides an auxiliary connector for mains power to the unit. If the product is powered via this pin, use a fuse (Fuse rating: 1A Slow). This pin can also be used to power auxiliary equipment, max 100mA
2	GND	
3	Digital Input 1	Connect to GND to activate or leave floating (or unconnected) to deactivate.
4	Digital Input 2	
5	Digital Input 3	
6	Digital Input 4	
7	Transistor Output	With a maximum load of 100mA and maximum voltage of 24V DC, this output has an open-collector NPN transistor with the emitter connected to pin 2 (GND). If it is to be used with an external relay, a diode must be connected in parallel with the load for protection against any voltage transients.
8	Transistor Output	
9	Transistor Output	
10	Transistor Output	
11	RS-485 - A (non-inverting)	A half-duplex RS-485 interface for controlling auxiliary equipment, e.g. PTZ devices.
12	RS-485 - B (inverting)	

The AXIS 241Q/241S includes one (green) 12-pin connector block. Connect input/output devices to this block:

1. Loosen the corresponding screw on top of the pin on the connector block (see the table above to determine which pin to use).
2. Push the cable into the connector block and secure it by fastening the screw.
3. Once all devices are connected, connect the connector block to the video server's terminal connector.

## Schematic Diagram - I/O Terminal Connector

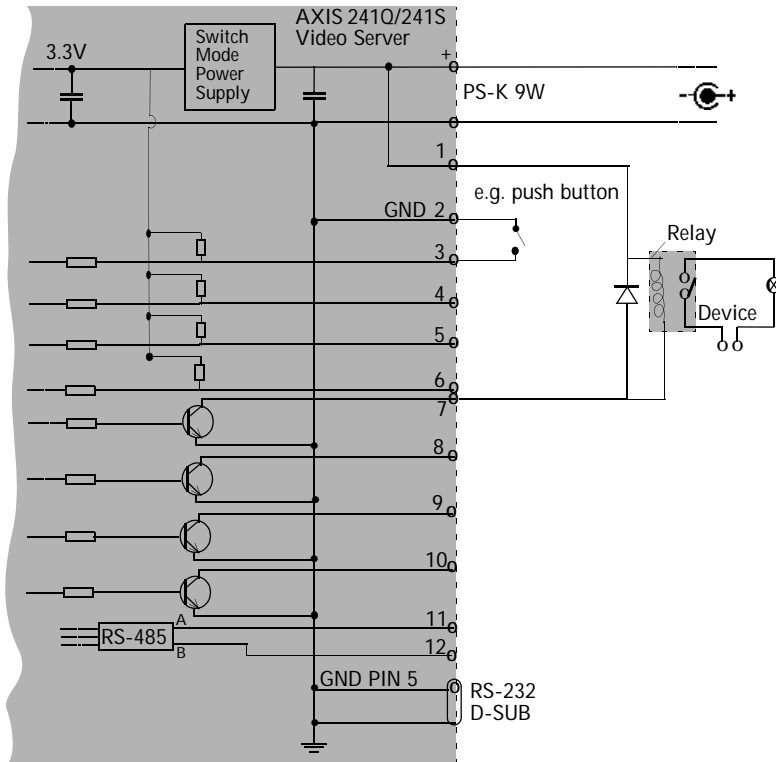

## COM Ports RS-232 and RS-485

The COM Ports RS-232 and RS-485 support several operational modes:

- **Generic TCP/IP** - enables the video server to receive status/data and send commands via TCP/IP
- **Generic HTTP** - enables the video server to receive status/data and send commands via HTTP
- **Pan Tilt Zoom (PTZ)** - for controlling a PTZ device. A PTZ device requires a driver for its function. Drivers can be obtained from [www.axis.com](http://www.axis.com). Please see page 37 for information on how to connect PTZ devices.

## Y/C to BNC Cable (AXIS 241S only)

The AXIS 241S supports conversion from Y/C (S-video) to composite video using an Y/C to BNC cable. The cable is available as an accessory - see the Axis Web site at: <http://www.axis.com>. Follow these instructions to connect the Y/C to BNC cable:

1. Connect the BNC connector marked **IN** to the **Video In** connector on the video server.
2. Connect the BNC connector marked **OUT** to the **Video OUT** connector on the video server.
3. Connect the Y/C connector to the Y/C video unit (S-video).
4. Set the dip switches on the front panel of the unit to 1=on, 2=on, 3=off, 4=off.
5. Go to the AXIS 241S Web pages under **Setup > Video & Image > Video Source** and select **Y/C (S-video)** from the **Physical connector** drop-down list.



One female MiniDin 4-pol connector  
split into two BNC connectors

Below is a description of how the cable is assembled for those who wish to use standard components:

1. Use two male BNC connectors and one female 4-pole MiniDin connector.
2. Connect pin 1, 2 and shield on the MiniDin connector to the shield on the two BNC connectors.
3. Connect pin 3 (Y) on the MiniDin connector to centre pin on one of the male BNC connectors, mark this BNC connector with **IN**.
4. Connect pin 4 (C) on the MiniDin connector to centre pin on the other male BNC connector, mark this BNC connector with **OUT**.

The pins on the  
MiniDin connector

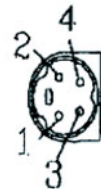

# Troubleshooting

---

## Checking the Firmware

Firmware is software that determines the functionality of the AXIS 241Q/241S. One of your first actions when troubleshooting a problem should be to check the currently installed version. The latest version may contain a correction that fixes your particular problem. The current firmware version in your AXIS 241Q/241S can be seen under **Setup > Basic Configuration**.

## Upgrading the Firmware

When you download firmware from the Axis Web site, your Axis product will receive the latest available functionality. Always read the upgrade instructions and release notes available with each new release, before updating the firmware.

New firmware can be downloaded to the AXIS 241Q/241S over the network.

**Note:** Pre-configured and customized settings will be retained for use when the new firmware is running (provided the features are available in the new firmware) although this is not guaranteed by Axis Communications.

1. Save the firmware file to your computer. The latest version of the AXIS 241Q/241S firmware is available free of charge from the Axis Web site at [www.axis.com/techsup](http://www.axis.com/techsup) or from your local distributor.
2. Go to **Setup > System Options > Maintenance** in the video server's Web pages.
3. In the **Upgrade Server** section and browse to the desired firmware file on your computer. Click **Upgrade**.

### Upgrade Server

Upgrade the AXIS 241Q Video Server with the latest firmware.

Specify the firmware to upgrade to:  **Browse...** and click **Upgrade**

**Note:** Do not disconnect power to the unit during the flash upgrade. The unit restarts automatically after the upgrade has completed. (1-10 minutes.)

- Notes:**
- Always read the upgrade instructions available with each new release, before updating the firmware.
  - After starting the process, you should always wait at least 20 minutes before restarting the AXIS 241Q/241S, even if you suspect the procedure has failed.
  - Your dealer reserves the right to charge for any repair attributable to faulty updating by the user.

## Emergency Recovery Procedure

If power or the network connection to the AXIS 241Q/241S is lost during the upgrade, the process will fail and the unit will become unresponsive. A flashing red Status LED indicates a failed upgrade. To recover the unit, follow the steps below. The serial number is found on the underside label on the product casing.

1. **Unix/Linux** - From the command line, type the following:  
`arp -s <IP address of AXIS 241Q/241S> <Serial number> temp`  
`ping -s 408 <IP address of AXIS 241Q/241S>`

**Windows** - From a command/DOS prompt, type the following:  
`arp -s <IP address of AXIS 241Q/241S> <Serial number>`  
`ping -l 408 -t <IP address of AXIS 241Q/241S>`

2. If the unit does not reply within a few seconds, restart it and wait for a reply. Press CTRL+C to stop Ping.
3. Open a browser and type in the AXIS 241Q/241S's IP address. In the page that appears, use the **Browse** button to select the upgrade file to use, e.g. axis241q.bin or axis241s.bin. Then click the **Load** button to restart the upgrade process.
4. After the upgrade has completed (1-10 minutes), the unit will automatically restart and show a steady green on the Power and Status LED:s and flashing green or amber on the Network LED.
5. Reinstall the AXIS 241Q/241S.

If the emergency recovery procedure does not get the AXIS 241Q/241S up and running again, please contact Axis support at [www.axis.com/techsup/](http://www.axis.com/techsup/)

## Support

If you contact Axis support, please help us help you resolve your problems expediently by providing a server report, log file and a brief description of the problem.

**Server Report** - go to **Setup > System Options > Support Overview**. The server report contains important information about the server and its software, as well as a list of the current parameters.

**Log file** - go to **Setup > System Options > Logs & Reports**. The Log file records events within the unit since the last restart of the system and can prove a useful diagnostic tool for troubleshooting.

## Symptoms, Possible Causes and Remedial Actions

### Problems setting the IP address

Using ARP/Ping - the IP address must be set within two minutes after power has been applied to the video server	Restart the server and try again. Ensure also the ping length is set to 408. See or <i>ARP and Ping in Windows</i> on page 13, or <i>ARP and Ping in UNIX/Linux</i> on page 14.
The video server is located on a different subnet.	If the IP address intended for the AXIS 241Q/241S and the IP address of your computer are located on different subnets, you will not be able to set the IP address. Contact your network administrator for an IP address on the same subnet as the computer you are performing the installation from.
The IP address is being used by another device	Disconnect power from the AXIS 241Q/241S. Run the Ping command (in a Command/DOS window, type ping <IP address of unit>  If you receive: Reply from <IP address>: bytes = 32; time = 10 ms..... - this means that the IP address may already be in use by another device on your network. You must obtain a new IP address and reinstall the unit.  If you receive: Request timed out - this means that the IP address is available for use with your video server. In this case, check all cabling and reinstall the unit.

### The AXIS 241Q/241S cannot be accessed from a Web browser

Cannot log in.	If the AXIS 241Q/241S has been configured to use HTTPS, check that the protocol in the URL used to access the unit is correct. You may need to type this in manually (i.e. http or https) in the browser's address field.
The IP address has been changed by DHCP	1) Move the AXIS 241Q/241S to an isolated network or to one with no DHCP or BOOTP server. Set the IP address again, using the ARP Ping command. 2) Access the unit and disable BOOTP and DHCP in the TCP/IP settings. Return the unit to the main network. The unit now has a fixed IP address that will not change. 3) As an alternative to 2), if dynamic IP address via DHCP or BOOTP is required, select the required service and then configure IP address change notification from the network settings. Return the unit to the main network. The unit will now have a dynamic IP address, but will notify you if the address changes.
Other networking problems	Test the network cable by connecting it to another network device, then Ping that device from your workstation. See instructions above.

### Cannot send notifications, uploads, alarms, etc, to a destination outside the local network

Firewall protection	The video server can be configured to use a SOCKS server to reach networks on the other side of a firewall/proxy server
---------------------	---

### Your AXIS 241Q/241S is accessible locally, but not externally

Firewall protection	Check the Internet firewall with your system administrator.
Default routers required	Check if you need to configure the default router settings.
The Internet site is too heavily loaded	Use a script on your web server to relay images from the AXIS 241Q/241S to the Internet.

### The Power indicator is not constantly lit

Faulty power supply	Verify that you are using an AXIS PS-K power supply.
---------------------	--

### The Status and network indicators are flashing red

Hardware failure	Contact your Axis dealer.
------------------	---------------------------

### The Status indicator is flashing red and the server is inaccessible

A firmware upgrade has been interrupted or the firmware has been damaged in some other way.	A rescue firmware is running in the product. First, set the IP address using AXIS IP utility or ARP and Ping, see page 10. Then, using a browser, access the unit and download the latest firmware to the product, see <i>Upgrading the Firmware</i> , on page 52.
---	--

**No images displayed in the Web interface**

Problem with AMC ( <i>Internet Explorer only</i> )	To enable the updating of images in Microsoft Internet Explorer, set your Web browser to allow ActiveX controls. Also, make sure that AXIS Media Control (AMC) component is installed on your workstation.
Installation of additional ActiveX component restricted or prohibited	Configure your AXIS 241Q/241S to use a Java applet for updating the images under Live View Config > Layout > Default Viewer for Internet Explorer. See the online help for more information.

**Video Image Problems**

Image too dark or too light.	Check that the termination dip switch for the video source is set to the correct position. See also the online help on Video Source Settings
Black borders around the video image	Adjust the X and/or Y offset, in the Video Source Settings. See the online help for information.
Problems uploading own files	There is only limited space available for the upload of your own files. Try deleting one or more existing files, to free up space
Missing images in uploads	This can occur when trying to use a larger image buffer than is actually available. Try lowering the frame rate or the upload period.
Slow image update	Configuring e.g. pre-buffers, motion detection, high resolution images, high frame rates, etc., will reduce the performance of the video server.
Slow performance	Slow performance may be caused by e.g. heavy network traffic, multiple users accessing the unit, low performance clients, use of features such as Motion Detection, Event handling, Image rotation.

**Bad snapshot images**

Display incorrectly configured on your workstation	In Display Properties, configure your display to show at least 65000 colors, i.e. at least 16-bit. Using only 16 or 256 colors on your display will produce dithering artifacts in the image.
--	---

**Incorrect exposure in images**

Incorrect line termination	If the AXIS 241Q/241S is to be connected in loop through with other equipment, disable the input termination by turning the corresponding DIP switch to OFF.
----------------------------	--

**Problems with the MPEG-4 format**

Lower frame rate than expected.	<p>Check with the administrator that there is enough bandwidth available. Check also the settings for bit rate control, in the Video &amp; Image &gt; Advanced &gt; MPEG-4 settings. Using an inappropriate video object type can also affect the frame rate. See the online help for more information.</p> <p>Check in the AMC control panel applet (MPEG-4 tab) that video processing is not set to Decode only I frames.</p> <p>Lower the image resolution.</p> <p>Reduce the number of applications running on the client computer.</p>
No MPEG-4 displayed in the client.	<p>Check that the correct network interface is selected in the AMC control panel applet (network tab).</p> <p>Check that the relevant MPEG-4 connection methods are enabled in the AMC control panel applet (network tab).</p> <p>In the AMC control applet, select the MPEG-4 tab and click the button Set to default MPEG-4 decoder.</p>
No multicast MPEG-4 displayed in the client.	<p>Check with your network administrator that the multicast addresses used by the AXIS 241Q/241S are valid for your network.</p> <p>Check with your network administrator to see if there is a firewall preventing viewing.</p>
Multicast MPEG-4 only accessible by local clients.	Check if your router supports multicasting, or if the router settings between the client and the server need to be configured. The TTL (Time To Live) value may need to be increased.

Poor rendering of MPEG-4 images.	Color depth set incorrectly on clients. Set to 16-bit or 32-bit color. If text overlays are blurred, or if there are other rendering problems, you may need to enable Advanced Video Rendering. This is done on the MPEG-4 tab in the AMC control panel applet. Ensure that your graphics card is using the latest device driver. The latest drivers can usually be downloaded from the manufacturer's web site.
Color saturation is different in MPEG-4 and Motion JPEG.	Modify the settings for your graphics adapter. Please see the adapter's documentation for more information.

For additional assistance, please contact your reseller or check the product's support pages on the Axis Website at [www.axis.com/techsup](http://www.axis.com/techsup)



# Technical Specifications

Item	Specification
Models	<ul style="list-style-type: none"> <li>• AXIS 241Q: 4-channel video server</li> <li>• AXIS 241S: 1-channel video server</li> </ul>
Video compression	<ul style="list-style-type: none"> <li>• Motion-JPEG, including single snapshot JPEG images.</li> <li>• MPEG-4 Part2 (ISO/IEC 14496-2), Profiles: ASP and SP</li> </ul>
Resolutions	<ul style="list-style-type: none"> <li>• 4CIF, 2CIF Expanded, 2CIF, CIF, QCIF</li> <li>• Maximum 768x576 (PAL) 704x480 (NTSC)</li> <li>• Minimum 176x144 (PAL) 160x120 (NTSC)</li> </ul>
Frame rates	<ul style="list-style-type: none"> <li>• Motion JPEG: up to 25/30 fps in 4CIF (1 channel), up to 25/30 fps in CIF (4 channels)</li> <li>• MPEG-4: up to 25/30 fps in 2CIF (1 channel), up to 17/20 fps in CIF (4 channels)</li> </ul>
Video streaming	<ul style="list-style-type: none"> <li>• Simultaneous Motion JPEG and MPEG-4</li> <li>• Controllable frame rate and total bandwidth</li> <li>• Constant and variable bit rate (MPEG-4)</li> </ul>
Image settings	<ul style="list-style-type: none"> <li>• Compression levels: 11 (Motion JPEG), 23 (MPEG-4)</li> <li>• Rotation: 90°, 180°, 270°</li> <li>• Aspect ratio correction</li> <li>• Color and black/white</li> <li>• Overlays: time, date, text, image</li> </ul>
Security	<ul style="list-style-type: none"> <li>• Multiple user levels with password protection</li> <li>• IP address filtering</li> <li>• HTTPS encryption</li> </ul>
Users	<ul style="list-style-type: none"> <li>• 20 simultaneous viewers</li> <li>• Unlimited users using MPEG-4 multicast</li> </ul>
Alarm and event management	<ul style="list-style-type: none"> <li>• Events triggered by built-in multi-window motion detection, external inputs or according to set schedule</li> <li>• Image uploads via FTP, email and HTTP</li> <li>• Event notification via TCP, email, HTTP and external outputs</li> <li>• Pre- and post-alarm buffer of 9 MB per channel (approx 4 min CIF video at 4 fps)</li> </ul>
Pan/Tilt/Zoom	<ul style="list-style-type: none"> <li>• Drivers for all supported PTZ units available from <a href="http://www.axis.com">www.axis.com</a></li> <li>• PTZ control queuing capability</li> </ul>
Connectors	<ul style="list-style-type: none"> <li>• Analog composite video, PAL/NTSC autosensing inputs</li> <li>• AXIS 241Q: 4 BNC video inputs</li> <li>• AXIS 241S: 1 BNC video input, 1 BNC output (loop through) or Y/C video input</li> <li>• Ethernet 10BaseT/100BaseTX, RJ-45</li> <li>• Terminal block: 4 alarm inputs, 4 output transistors (max 24V, 0.1 A), 2-wire RS-485/422 (half-duplex), alternative voltage input</li> <li>• D-Sub connector: RS-232</li> <li>• Power: 9V DC</li> </ul>
Processors and memory	<ul style="list-style-type: none"> <li>• CPU: ETRAX-100 LX 32-bit</li> <li>• Video processing and compression: ARTPEC-2 chip</li> <li>• RAM AXIS 241Q - 64MB RAM</li> <li>• RAM AXIS 241S - 32MB RAM</li> <li>• Flash memory - 8 MB</li> </ul>

Item	Specification
Power	<ul style="list-style-type: none"> <li>External power adapter PS-K (included): 9V DC, 9W</li> <li>Via terminal connector: 7-20V DC, max 8W</li> </ul>
Operating conditions	<ul style="list-style-type: none"> <li>Temperature: 5°C (41°F) to 50°C (122°F)</li> <li>Humidity: 20-80% RH (non-condensing)</li> </ul>
System integration support	<ul style="list-style-type: none"> <li>API for software integration available at <a href="http://www.axis.com">www.axis.com</a> includes HTTP API, AXIS Media Control SDK</li> <li>Event trigger data in video stream</li> <li>Embedded scripting</li> <li>Access to serial port peripherals via HTTP/TCP</li> <li>Embedded operating system: Linux 2.4</li> </ul>
Minimum web browsing requirements	<ul style="list-style-type: none"> <li>Pentium III 500 MHz or higher or equivalent AMD</li> <li>128 MB RAM</li> <li>AGP graphics card, DirectDraw, 32 MB video RAM</li> <li>Windows: XP, 2000, NT 4.0, ME or 98</li> <li>DirectX 9.0 or later</li> <li>Internet Explorer 5.x or later</li> </ul> <p>For other operating systems and browsers, see <a href="http://www.axis.com/techsup">www.axis.com/techsup</a></p>
Supported protocols	<p>HTTP, HTTPS, SSL/TLS*, TCP SNMPv1/v2c/v3 (MIB-II), RTSP, RTP, UDP, IGMP, RTCP, SMTP, FTP, DHCP, UPnP, ARP, DNS, DynDNS, SOCKS</p> <p>*This product includes software developed by the Open SSL Project for use in the Open SSL Tool kit. See <a href="http://www.openssl.org">www.openssl.org</a></p>
Approvals - EMC	<ul style="list-style-type: none"> <li>EN55022:1998+A1 (CISPR 22:1997+A1) Class B</li> <li>EN55024:1998+A1+A2</li> <li>EN61000-3-2:2000</li> <li>EN61000-3-3:1995+A1</li> <li>VCCI:2003, Class B, ITE (CISPR 22:1997+A1:2000, Class B)</li> <li>C-Tick AS/NZS 3548</li> <li>FCC part 15, Subpart B, Class B, demonstrated by compliance with EN55022:1998 (CISPR 22:1997) Class B</li> <li>ICES-003 Class B, demonstrated by compliance with EN 55022:1998, Class B</li> </ul>
Approvals - Safety	<ul style="list-style-type: none"> <li>EN60950</li> <li>UL, CSA (PS-K power adapter)</li> </ul>
Dimensions	<ul style="list-style-type: none"> <li>HxWxD = 42 x 140 x 155mm (1 11/16 x 5 1/2 x 6 1/8")</li> <li>Weight: 540g (1.2 lb) excluding power adapter</li> </ul>
Complimentary Software	<ul style="list-style-type: none"> <li>AXIS Media Control (AMC) - ActiveX component software required for Microsoft Internet Explorer, installed automatically on first use.</li> <li>Optional: AXIS IP Utility - Windows installation</li> </ul>
MPEG-4 licensing	License for one MPEG-4 encoder and one MPEG-4 decoder included. Additional licenses available from Axis dealers.

## General performance considerations

When setting up your system, it is important to consider how various settings and situations will affect performance. Some factors affect the amount of bandwidth (the bit rate) required, others can affect the frame rate, and some will affect both. If the load on the CPU reaches its maximum, this will also affect the frame rate.

The following factors are among the most important to consider:

- High image resolutions and/or lower compression levels result in larger images. Bandwidth affected.
- Access by large numbers of Motion JPEG and/or unicast MPEG-4 clients. Bandwidth affected.
- Simultaneous viewing of different streams (resolution, compression, etc.) by different clients. Frame rate and bandwidth affected.
- Accessing both Motion JPEG and MPEG-4 video streams simultaneously. Frame rate and bandwidth affected.
- Heavy usage of event settings affects the CPU load. Frame rate affected.
- Enabled motion detection. Frame rate and bandwidth affected.
- Heavy network utilization due to poor infrastructure. Bandwidth affected
- Viewing on poorly performing client PC's lowers perceived performance. Frame rate affected.

## Optimizing your system

To see the bandwidth and frame rate currently required by the video stream, the AXIS 241S/241Q provides a tool that can be used to display these values directly in the video image.

To do this, special format strings are added as part of a text overlay. Simply add #r (average frame rate in fps) and/or #b (average bandwidth in Kbps) bandwidth in Kbps) to the overlay.

For detailed instructions, please see the online help for **Video & Image > Overlay Settings**, and the help for **File Naming & Date/Time Formats**.



### Important!

- The figures displayed here are the values as delivered by the server. If other restrictions are currently in force, (e.g. bandwidth limitation) these values might not correspond to those actually received by the client.
- For Motion JPEG, these values will only be accurate as long as no frame rate limit has been specified.

## Frame rates - Motion JPEG

The following test results show the frame rates in frames/second (fps) for Motion JPEG streams from the AXIS 241S/241Q, using a compression level of 50%. Note that these values are guidelines only - actual values may vary.

	fps (PAL/NTSC) 1 channel	fps (PAL/NTSC) 4 channels
4CIF	25/30	8/10
2CIF expanded	25/30	13/15
2CIF	25/30	22/27
CIF	25/30	25/30
QCIF	25/30	25/30

## Frame rates - MPEG-4

The following test results show the frame rates in frames/second (fps) for MPEG-4 streams from the AXIS 241S/241Q. Note that these values are guidelines only - actual values may vary.

The MPEG-4 test conditions:

- Compression level = 50%
- Video Object Type = Advanced Simple
- GOV structure = IP\*

	fps (PAL/NTSC) 1 channel	fps (PAL/NTSC) 4 channels
4CIF	17/21	3/4
2CIF expanded	17/21	4/5
2CIF	25/30	9/10
CIF	25/30	17/20
QCIF	25/30	25/30

\*Note that setting the GOV structure to use "I-frames only" will increase the frame rate.

## Bandwidth

As there are many factors affecting bandwidth, it is very difficult to predict the required amounts. The settings that affect bandwidth are:

- the image resolution
- the image compression
- the frame rate
- the MPEG-4 object type
- the MPEG-4 GOV structure
- the analog cameras connected to the video server

There are also factors in the monitored scene that will affect the bandwidth. These are:

- the amount of motion
- the image's complexity
- the lighting conditions.

For MPEG-4, if there is only limited bandwidth available, and if this is more important than the image quality, using a constant bit rate (CBR) is recommended. Use a variable bit rate (VBR) if the image quality needs to be maintained at a higher level. If supported on the network, consider also using MPEG-4 multicasting, as the bandwidth consumption will be much lower.

# Installation

## Montage

Im Lieferumfang des AXIS 241Q/241S ist ein Montagesatz für die Wandanbringung oder den Rackeinbau enthalten. Die Halterungen können so montiert werden, dass der Videosever auf einer senkrechten Fläche angebracht oder in ein Rack (4 HE) eingebaut werden kann. Gehen Sie folgendermaßen vor, um die Halterungen an den Videosever anzubringen:

- 1 Ziehen Sie den grauen Rahmen vorn am Videosever ab (kein Werkzeug erforderlich).



- 2 Schieben Sie die Metallplatten in die Schlitze auf beiden Seiten des Videosevers.

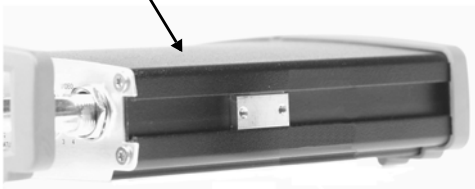

Alternative B

- 3 Bringen Sie die Halterungen auf beiden Seiten in die richtige Lage, und schrauben Sie diese mit den dafür vorgesehenen Schrauben fest.

Alternative A

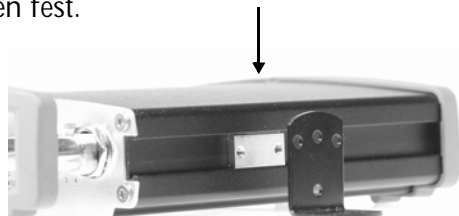

3



## Videokameras anschließen

Schließen Sie den Video-Ausgang Ihrer Kamera(s) mit einem Standard-Koaxial-Video-kabel (75 Ohm) mit BNC-Anschlüssen an den AXIS 241Q/241S Videosever an.



**Hinweis:** Verwenden Sie einen RCA/BNC-Adapter, falls Ihre Kamera über einen RCA-Anschluss verfügt.

## Installationsmethoden

Der AXIS 241Q/241S ist für die Installation in einem Ethernet-Netzwerk vorgesehen. Dazu muss dem Videosever entweder manuell oder über einen automatischen Netzwerkservice (DHCP) eine IP-Adresse zugewiesen werden. Wählen Sie entsprechend Ihrem Netzwerk eine der folgenden Methoden:

- Verwenden Sie unter Windows das Programm AXIS IP Utility, um eine dynamisch zugewiesene IP-Adresse zu ermitteln oder eine IP-Adresse manuell zuzuweisen.
- Bei Verwendung eines DHCP-Servers können Sie auf den Administrationsseiten dieses Servers herausfinden, welche IP-Adresse dem AXIS 241Q/241S zugewiesen wurde.
- Falls Sie einen DHCP-Server verwenden und auf Ihrem Computer der UPnP™-Dienst ausgeführt wird, wird AXIS 241Q/241S automatisch erkannt und auf dem Bildschirm angezeigt. Siehe Seite 65.
- Weisen Sie die IP-Adresse manuell mit der ARP/Ping-Methode zu. Die Anleitung hierzu finden Sie auf Seite 65.
- Wenn Ihr Netzwerk über einen Internetanschluss (ohne Proxyserver für HTTP-Zugang) verfügt und Sie zur Zuweisung von IP-Adressen einen DHCP-Server verwenden, sollten Sie nach dem One-Click-Verfahren vorgehen. Siehe Seite 68.

**Hinweise:**

- Die Standard-IP-Adresse des AXIS 241Q/241S lautet: 192.168.0.90
- DHCP ist im AXIS 241Q/241S standardmäßig aktiviert.
- UPnP™ ist im AXIS 241Q/241S standardmäßig aktiviert.

## AXIS IP Utility

AXIS IP Utility ist eine kostenlose Windows-Anwendung, mit der Axis-Geräte im Netzwerk erkannt und angezeigt werden. Die Anwendung dient außerdem zum manuellen Festlegen einer statischen IP-Adresse. Sie können AXIS IP Utility von den Supportseiten unter [www.axis.com/techsup/software](http://www.axis.com/techsup/software) herunterladen.

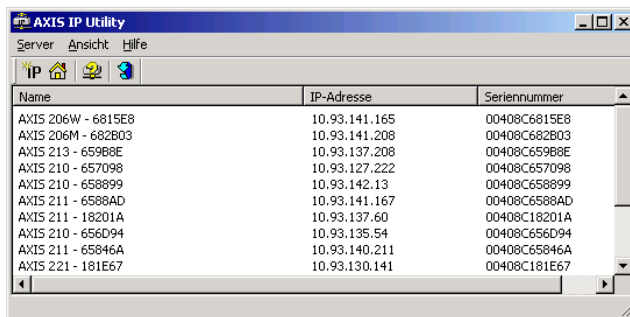

### Automatische Erkennung

1. Prüfen Sie, ob Netzwerk- und Stromkabel mit dem AXIS 241Q/241S verbunden sind.
2. Starten Sie AXIS IP Utility. Klicken Sie auf das Symbol des AXIS 241Q/241S, um die entsprechende Homepage zu öffnen.

### IP-Adresse manuell einstellen

Wenn das Symbol des AXIS 241Q/241S nicht im Fenster angezeigt wird, klicken Sie auf die Schaltfläche **Aktualisieren**, um erneut nach dem Gerät zu suchen. Wird das Gerät immer noch nicht angezeigt, müssen Sie die IP-Adresse manuell zuweisen.

1. Wählen Sie eine nicht zugewiesene IP-Adresse. AXIS IP Utility erkennt das Subnetz, an das Ihr Computer angeschlossen ist. Der AXIS 241Q/241S muss im selben Netzwerksegment installiert werden.
2. Klicken Sie auf die Schaltfläche  (IP-Adresse mit Seriennummer festlegen), und geben Sie die Seriennummer und die IP-Adresse für die AXIS 241Q/241S ein.
3. Klicken Sie auf die **IP-Adresse festlegen** und starten Sie die AXIS 241Q/241S innerhalb von zwei Minuten neu.
4. Klicken Sie auf **Homepage anzeigen**, um auf die Webseiten der AXIS 241Q/241S zu gelangen.
5. Geben Sie ein Passwort für den **Root-Benutzer (Administrator)** ein.
6. Bestätigen Sie die Installation von **AMC** auf Ihrem Computer.

**Hinweis:**

- Mit AXIS IP Utility lässt sich auch die IP-Adresse ändern, die zuvor einem Axis-Gerät zugewiesen wurde.
- AMC (AXIS Media Control) muss installiert sein, damit Video-Direktübertragungen im Microsoft Internet Explorer angezeigt werden können. Falls in Ihrer Arbeitsumgebung die Installation weiterer Softwarekomponenten nicht zugelassen ist, können Sie Ihren AXIS 241Q/241S so konfigurieren, dass zum Aktualisieren der Bilder ein Java-Applet verwendet wird. Siehe Hilfedatei unter Live View Config (Direktübertragung konfigurieren) > Layout (Ansicht) > Default Viewer for Internet Explorer (Standard-Viewer für Internet Explorer), oder verwenden Sie einen anderen unterstützten Webbrowser (siehe *Technical Specifications*, auf Seite 57).



- Die Installation ist damit abgeschlossen. Fahren Sie mit dem Abschnitt *Using the video server*, auf Seite 16 fort.

Die Seriennummer (S/N) befindet sich auf dem Etikett auf der Unterseite des AXIS 241Q/241S.

## UPnP™

Die UPnP-Funktionalität des AXIS 241Q/241S ist standardmäßig aktiviert. Sofern diese Funktionalität auch auf Ihrem Computer (Windows ME oder XP) aktiviert ist, wird der Videoserver automatisch erfasst, und unter "Netzwerkumgebung" wird ein entsprechendes Symbol hinzugefügt. Klicken Sie auf dieses Symbol, um auf den AXIS 241Q/241S zuzugreifen.

### Hinweis:

Zur Installation des UPnP-Dienstes auf Ihrem Computer öffnen Sie im Startmenü die Systemsteuerung. Wählen Sie hier "Software". Wählen Sie "Windows-Komponenten hinzufügen/entfernen", und wechseln Sie zum Bereich "Netzwerkdienste". Klicken Sie auf "Details", und wählen Sie dann UPnP als hinzuzufügenden Dienst aus.

UPnP™ ist eine Zertifizierungsmarke der UPnP™ Implementers Corporation.

## ARP und Ping unter Windows

Gehen Sie folgendermaßen vor, um Ihrem Produkt von einem Computer Ihres Netzwerks aus eine eindeutige IP-Adresse zuzuweisen:

- Lassen Sie sich von Ihrem Netzwerkadministrator eine nicht zugewiesene IP-Adresse für den AXIS 241Q/241S geben.
- Schließen Sie den AXIS 241Q/241S über ein Standard-Netzwerkkabel an das Netzwerk an.
- Die Seriennummer/MAC-Adresse (S/N) ist auf dem Etikett auf der Unterseite des AXIS 241Q/241S zu finden.
- Öffnen Sie auf einem Computer Ihres Netzwerks das Befehlszeilenprogramm. Wählen Sie dazu beispielsweise im Windows-Startmenü die Option **Ausführen...**, und geben Sie `cmd` ein (`command` für Windows 98/ME). Klicken Sie auf **OK**.
- Geben Sie folgende Befehle ein:

Syntax:

```
arp -s <IP-Adresse> <Seriennummer>
ping -l 408 -t <IP-Adresse>
```

**Hinweis:** Auf den Ping-Befehl folgt `-l` (kleines L).

## Beispiel

```

C:\WINNT\system32\cmd.exe
Microsoft Windows 2000 [Version 5.00.2195]
(C) Copyright 1985-2000 Microsoft Corp.

R:\>arp -s 192.168.0.125 00-40-8c-1a-2b-3c

R:\>ping -l 408 -t 192.168.0.125_
  
```

6. Starten Sie den AXIS 241Q/241S, bzw. starten Sie ihn neu. Der Start/Neustart muss binnen zwei Minuten nach Eingabe der Befehle "ARP" und "Ping" erfolgen.
7. Sobald "Antwort von 192.168.0.125: ..." angezeigt wird, also nach ca. 10–15 Sekunden, können Sie den Ping-Befehl durch Betätigen von Ctrl+C stoppen.
8. Starten Sie einen Webbrowser, und geben Sie im Adressfeld die IP-Adresse ein.
9. Betätigen Sie die Eingabetaste.
10. Geben Sie ein Passwort für den Root-Benutzer (Administrator) ein.
11. Bestätigen Sie die Installation von AMC auf Ihrem Computer.

**Hinweis:** AMC muss installiert sein, damit Video-Direktübertragungen im Microsoft Internet Explorer angezeigt werden können. Falls in Ihrer Arbeitsumgebung die Installation weiterer Softwarekomponenten nicht zugelassen ist, können Sie Ihren AXIS 241Q/241S so konfigurieren, dass zum Aktualisieren der Bilder ein Java-Applet verwendet wird. Einzelheiten dazu finden Sie in der Hilfedatei unter Live View Config (Direktübertragung konfigurieren) > Layout (Ansicht) > Default Viewer for Internet Explorer (Standard-Viewer für Internet Explorer). Oder verwenden Sie einen anderen unterstützten Webbrowser (siehe *Technical Specifications*, auf Seite 57).

12. Die Installation ist damit abgeschlossen. Fahren Sie mit dem Abschnitt *Using the video server*, auf Seite 16 fort.

## ARP and Ping unter UNIX/Linux

Gehen Sie folgendermaßen vor, um Ihrem Produkt von einem Computer Ihres Netzwerks aus eine eindeutige IP-Adresse zuzuweisen:

1. Lassen Sie sich von Ihrem Netzwerkadministrator eine nicht zugewiesene IP-Adresse für den AXIS 241Q/241S geben.
2. Schließen Sie den AXIS 241Q/241S über ein Standard-Netzwerkkabel an das Netzwerk an.
3. Die Seriennummer (S/N) ist auf dem Etikett auf der Unterseite des AXIS 241Q/241S zu finden.

Syntax:

```
arp -s <IP-Adresse > <Seriennummer> temp
ping -s 408 <IP-Adresse>
```

Beispiel:

```
arp -s 192.168.0.125 00:40:8c:18:10:00 temp
ping -s 408 192.168.0.125
```

4. Starten Sie den AXIS 241Q/241S, bzw. starten Sie ihn neu. Der Start/Neustart muss binnen zwei Minuten nach Eingabe der Befehle "ARP" und "Ping" erfolgen.
5. Beenden Sie die ARP/Ping-Sitzung, sobald "Antwort von 192.168.0.125: ..." oder etwas Ähnliches angezeigt wird (nach ca. 10–15 Sekunden).
6. Starten Sie einen Webbrowser, und geben Sie im Adressfeld die IP-Adresse ein.
7. Betätigen Sie die Eingabetaste.
8. Geben Sie ein Passwort für den Root-Benutzer (Administrator) ein.
9. Die Installation ist damit abgeschlossen. Fahren Sie mit dem Abschnitt *Using the video server*, auf Seite 16 fort.

## AXIS Internet Dynamic DNS Service

Der AXIS Internet Dynamic DNS Service wird von Axis als kostenloser Service zur Verfügung gestellt. Damit können Sie Ihren Videosever schnell und einfach installieren. Der Videosever erhält dabei einen statischen Namen (DNS-Namen) und eine dynamische IP-Adresse. Weitere Einzelheiten zum AXIS Internet Dynamic DNS Service erhalten Sie unter [www.axiscam.net](http://www.axiscam.net).

Die Registrierung des Videosevers bei diesem Service kann jederzeit gelöscht werden.

Unter [www.axiscam.net](http://www.axiscam.net) finden Sie weitere Informationen zum AXIS Internet Dynamic DNS Service.

### Anforderungen

Voraussetzung für die Verwendung des AXIS Internet Dynamic DNS Service ist eine Internetverbindung, bei der für den HTTP-Zugriff kein Proxyserver verwendet wird. Für das Zuweisen von IP-Adressen wird die Verwendung eines DHCP-Servers empfohlen.

### Installationsvorgang

Hinweis: Bei diesem Verfahren werden die IP-Adresse, Firmware-Version, Seriennummer sowie der Produkttyp des AXIS 241Q/241S an den Axis Internet Dynamic DNS Service übermittelt. Es werden keine persönlichen Daten übertragen.

1. Schließen Sie den AXIS 241Q/241S über ein Standard-Netzwerkkabel an das Netzwerk an.
2. Schließen Sie den Videosever ans Stromnetz an.
3. Warten Sie, bis die Statusanzeige an der Vorderseite des Videosevers konstant grün leuchtet. Dadurch wird angezeigt, dass der Server eine dynamische IP-Adresse von einem DHCP-Server im Netzwerk erhalten hat.
4. Warten Sie 60 Sekunden, und betätigen Sie danach die Steuertaste an der Vorderseite des Servers einmal. Die Statusanzeige vorn am Server blinkt während der Verbindung mit dem AXIS Internet Dynamic DNS Service grün. Nach Abschluss der Registrierung geht die Anzeige wieder auf Dauergrün über.
5. Auf der Website [www.axiscam.net](http://www.axiscam.net) werden Sie durch den restlichen Installationsprozess geführt. Halten Sie die Seriennummer Ihres Produktes bereit, und befolgen Sie die Anweisungen auf dem Bildschirm.

Die Seriennummer (S/N) befindet sich auf dem Etikett auf der Unterseite des AXIS 241Q/241S.

6. Geben Sie ein Passwort für den Root-Benutzer (Administrator) ein.
7. Bestätigen Sie die Installation von AMC auf Ihrem Computer.

**Hinweis:** MC muss installiert sein, damit direkt übertragene Bilder im Microsoft Internet Explorer angezeigt werden können. Falls in Ihrer Arbeitsumgebung die Installation weiterer Softwarekomponenten nicht zugelassen ist, können Sie Ihren AXIS 241Q/241S so konfigurieren, dass zum Aktualisieren der Bilder ein Java-Applet verwendet wird. Einzelheiten dazu finden Sie in der Hilfedatei unter Live View Config (Direktübertragung konfigurieren) > Layout (Ansicht) > Default Viewer for Internet Explorer (Standard-Viewer für Internet Explorer). Siehe auch Abschnitt *Technical Specifications*, auf Seite 57.

8. Die Installation ist damit abgeschlossen. Fahren Sie mit dem Abschnitt *Using the video server*, auf Seite 16 fort.

## Installation

### Montage

Votre AXIS 241Q/241S est équipé d'un kit de montage pour support mural ou sur baie (rack). Les supports de montage peuvent être positionnés pour monter le serveur vidéo sur une surface verticale ou dans une baie (4U). Suivez les instructions ci-dessous pour fixer les supports de montage au serveur vidéo :

- 1 Faites glisser la structure du panneau avant du serveur pour l'enlever (pas besoin d'outils).



- 2 Insérez les plaques métalliques dans les logements de chaque côté du serveur vidéo.

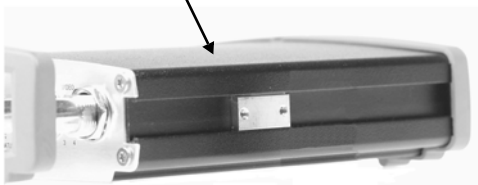

Solution B

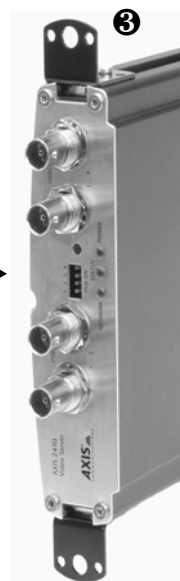

- 3 Positionnez et fixez les supports de chaque côté à l'aide des vis prévues à cet effet.

Solution A

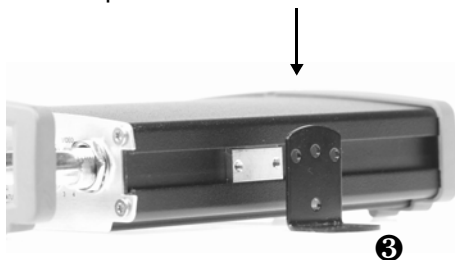

## Connexion des caméras vidéo

Connectez la sortie vidéo de votre ou vos caméras à votre AXIS 241Q/241S à l'aide d'un câble vidéo coaxial standard de 75 Ohms avec connecteurs BNC.



**Remarque :** Utilisez un adaptateur RCA/BNC si votre caméra dispose d'un connecteur de type phono (RCA).

## Méthodes d'installation

Votre AXIS 241Q/241S est conçu pour une installation dans un réseau Ethernet. Cela implique de lui affecter une adresse IP, soit manuellement soit via un service réseau automatisé (DHCP). Sélectionnez l'une des procédures suivantes en fonction de votre réseau :

- Sous Windows, utilisez l'application AXIS IP Utility pour obtenir une adresse IP dynamique ou définir manuellement cette adresse.
- Si votre réseau utilise un serveur DHCP, consultez-en les pages d'administration pour déterminer l'adresse IP affectée à votre AXIS 241Q/241S.
- Si votre réseau utilise un serveur DHCP et si votre ordinateur exécute le service UPnP™, votre AXIS 241Q/241S est détecté automatiquement et s'affiche sur votre écran. Reportez-vous à la page 73.
- Pour l'attribution manuelle de l'adresse IP selon la méthode ARP/Ping, reportez-vous à la page 73.
- Si votre réseau comporte une connexion à Internet (sans proxy HTTP) et utilise un serveur DHCP pour attribuer les adresses IP, utilisez la méthode AXIS Internet Dynamic DNS Service. Reportez-vous à la page 76.

**Remarques :**

- L'adresse IP du AXIS 241Q/241S par défaut est 192.168.0.90
- DHCP est activé par défaut dans votre AXIS 241Q/241S.
- UPnP™ est activé par défaut dans votre AXIS 241Q/241S.

## Application AXIS IP Utility

L'utilitaire AXIS IP Utility est une application Windows gratuite servant à détecter et afficher les périphériques Axis de votre réseau. Cette application peut également être utilisée pour définir manuellement une adresse IP statique. Vous pouvez télécharger AXIS IP Utility depuis les pages de support sur : [www.axis.com/techsup/software](http://www.axis.com/techsup/software)

Nom	Adresse IP	Numéro de série
AXIS 206W - 6815E8	10.93.141.165	00408C6815E8
AXIS 206M - 682B03	10.93.141.208	00408C682B03
AXIS 213 - 659B8E	10.93.137.208	00408C659B8E
AXIS 210 - 657098	10.93.127.222	00408C657098
AXIS 210 - 658899	10.93.142.13	00408C658899
AXIS 211 - 6588AD	10.93.141.167	00408C6588AD
AXIS 211 - 18201A	10.93.137.60	00408C18201A
AXIS 210 - 656D94	10.93.135.54	00408C656D94
AXIS 211 - 65846A	10.93.140.211	00408C65846A
AXIS 221 - 181E67	10.93.130.141	00408C181E67

## Détection automatique

1. Vérifiez que les câbles d'alimentation et le réseau sont bien raccordés à votre AXIS 241Q/241S.
2. Démarrez AXIS IP Utility. Double-cliquez sur l'icône AXIS 241Q/241S lorsqu'elle apparaît dans la fenêtre de façon à en ouvrir la page d'accueil.

### Définissez manuellement l'adresse IP.

Si AXIS 241Q/241S ne s'affiche pas, cliquez sur le bouton **Actualiser** pour réessayer. Si l'icône ne s'affiche toujours pas, définissez l'adresse IP manuellement.

1. Trouvez une adresse IP inutilisée. AXIS IP Utility détecte le sous-réseau auquel votre ordinateur est connecté. Votre AXIS 241Q/241S doit être installé sur le même segment de réseau.
2. Cliquez sur le bouton  (Paramétrer l'adresse IP en utilisant le numéro de série) puis saisissez le numéro de série et l'adresse IP de votre AXIS 241Q/241S.
3. Cliquez sur le bouton **Paramétrer IP** puis redémarrez votre AXIS 241Q/241S (dans les 2 minutes).
4. Cliquez sur **Afficher page d'accueil** pour accéder aux pages Web de votre AXIS 241Q/241S.
5. Entrez un mot de passe pour l'utilisateur root (administrateur).
6. Le cas échéant, acceptez l'installation de **AMC** sur votre station de travail.

**Remarques :**

- AXIS IP Utility permet également de modifier l'adresse IP d'un appareil Axis détecté précédemment.
- AMC (AXIS Media Control) doit être installé pour visionner les données vidéo en direct dans Microsoft Internet Explorer. Si votre environnement de travail limite les composants logiciels supplémentaires, vous pouvez configurer votre AXIS 241Q/241S pour utiliser un applet Java pour mettre à jour les images. Consultez le fichier d'aide Live View Config > Layout > Default Viewer for Internet Explorer ou utilisez un autre navigateur Web pris en charge (voir *Technical Specifications*, à la page 57).

7. L'installation est terminée. Passez à *Using the video server*, à la page 16.

Le numéro de série (S/N) figure sur l'étiquette sous le serveur vidéo AXIS 241Q/241S



## UPnP™

La fonction UPnP est activée par défaut dans votre AXIS 241Q/241S. Si elle est aussi activée sur votre ordinateur (Windows ME ou XP), le serveur vidéo sera automatiquement détecté et une nouvelle icône sera ajoutée à « Mes emplacements réseau ». Cliquez sur cette icône pour accéder à votre AXIS 241Q/241S.

Remarque :

Pour installer le service UPnP sur votre ordinateur, ouvrez le Panneau de configuration depuis le menu Démarrer et sélectionnez Ajout/suppression de programmes. Sélectionnez Ajouter/Supprimer des composants Windows et ouvrez la section Services de mise en réseau. Cliquez sur Détails, puis sélectionnez UPnP comme service à ajouter.

UPnP™ est une marque de certification de UPnP™ Implementers Corporation.

## ARP et Ping sous Windows

Affectez une adresse IP unique à votre ordinateur à partir d'un ordinateur du réseau, en procédant comme suit :

1. Trouvez une adresse IP non utilisée pour votre AXIS 241Q/241S en la demandant à votre administrateur de réseau.
2. Connectez votre AXIS 241Q/241S à votre réseau à l'aide d'un câble de réseau standard.
3. Repérez le numéro de série (S/N) sur l'étiquette collée sur la partie inférieure de votre AXIS 241Q/241S
4. A partir d'un ordinateur de votre réseau, ouvrez une invite de commande, par exemple à partir du menu Démarrer de Windows, sélectionnez Exécuter... et tapez cmd (command sous Windows 98/ME). Cliquez sur OK.
5. Entrez les commandes :

Syntaxe :

```
arp -s <Adresse IP> <Numéro de série>
ping -l 408 -t <Adresse IP>
```

**Remarque :** La commande Ping est suivie de -l (L minuscule)

### Exemple

The screenshot shows a Windows command prompt window titled "C:\WINNT\system32\cmd.exe". The text inside the window is as follows:

```
Microsoft Windows 2000 [Version 5.00.2195]
(C) Copyright 1985-2000 Microsoft Corp.

R:\>arp -s 192.168.0.125 00-40-8c-1a-2b-3c
R:\>ping -l 408 -t 192.168.0.125_
```

6. Démarrez/redémarrez votre AXIS 241Q/241S. Vous devez le faire dans les 2 minutes qui suivent la saisie des commandes ARP et Ping.
7. Lorsque le message « Reply from 192.168.0.125: ... » (Réponse de) s'affiche (au bout d'environ 10-15 secondes), tapez Ctrl+C pour fermer la session Ping.
8. Lancez un navigateur Web et entrez l'adresse IP dans le champ Adresse/emplacement.
9. Appuyez sur Entrée.
10. Entrez un mot de passe pour l'utilisateur root (administrateur).
11. Le cas échéant, acceptez l'installation de AMC sur votre station de travail.

**Remarque :** AMC doit être installé pour visionner les images vidéo en direct dans Microsoft Internet Explorer. Si votre environnement de travail limite les composants logiciels supplémentaires, vous pouvez configurer votre AXIS 241Q/241S pour utiliser un applet Java pour mettre à jour les images. Reportez-vous au fichier d'aide sous Live View Config > Layout > Default Viewer for Internet Explorer pour de plus amples informations. Vous pouvez également utiliser un autre navigateur Web pris en charge ; reportez-vous aux *Technical Specifications*, à la page 57.

12. L'installation est terminée. Passez à *Using the video server*, à la page 16.

## ARP et Ping sous UNIX/Linux

Affectez une adresse IP unique à votre ordinateur à partir d'un ordinateur du réseau, en procédant comme suit :

1. Trouvez une adresse IP non utilisée pour votre AXIS 241Q/241S en la demandant à votre administrateur de réseau.
2. Connectez votre AXIS 241Q/241S à votre réseau à l'aide d'un câble de réseau standard.
3. Repérez le numéro de série (S/N) sur l'étiquette collée sur la partie inférieure de votre AXIS 241Q/241S

Syntaxe:

```
arp -s <Adresse IP> <Numéro de série> temp  
ping -s 408 <Adresse IP>
```

Exemple :

```
arp -s 192.168.0.125 00:40:8c:18:10:00 temp  
ping -s 408 192.168.0.125
```

4. Démarrez/redémarrez votre AXIS 241Q/241S. Vous devez le faire dans les 2 minutes qui suivent la saisie des commandes ARP et Ping.
5. Fermez la session ARP Ping dès que le message « Reply from 192.168.0.125: ... » (Réponse de) ou similaire s'affiche (au bout d'environ 10-15-secondes).
6. Lancez un navigateur Web et entrez l'adresse IP dans le champ Adresse/emplacement.
7. Appuyez sur Entrée.
8. Entrez un mot de passe pour l'utilisateur root (administrateur).
9. L'installation est terminée. Passez à *Using the video server*, à la page 16.

## AXIS Internet Dynamic DNS Service

AXIS Internet Dynamic DNS Service est un service gratuit offert par Axis pour vous permettre d'installer rapidement et facilement votre serveur vidéo, qui reçoit ainsi un nom statique (nom DNS) et une adresse IP dynamique. Davantage d'informations sur l'AXIS Internet Dynamic DNS Service sont disponibles sur le site [www.axiscam.net](http://www.axiscam.net).

Le serveur vidéo peut être désactivé à tout moment.

Visitez [www.axiscam.net](http://www.axiscam.net) pour de plus amples détails sur AXIS Internet Dynamic DNS Service.

### Configuration minimale requise

AXIS Internet Dynamic DNS Service nécessite une connexion Internet qui n'exige pas de serveur proxy pour l'accès http. Nous recommandons un serveur DHCP dans le réseau pour l'affectation des adresses IP.

### Procédure d'installation

Remarquez que cette procédure enverra l'adresse IP de votre AXIS 241Q/241S, la version du logiciel microprogrammé et le numéro de série à Axis Internet Dynamic DNS Service. Aucune information personnelle ne sera transmise.

1. Connectez votre AXIS 241Q/241S à votre réseau local à l'aide d'un câble réseau standard.
2. Connectez le cordon d'alimentation au serveur vidéo.
3. Attendez que le voyant d'état sur la partie avant du serveur vidéo passe au vert, ce qui signale la réception d'une adresse IP dynamique d'un serveur DHCP sur votre réseau.
4. Attendez 60 secondes et appuyez une fois sur le bouton de commande du panneau avant. Le voyant d'état sur la partie avant du serveur vidéo clignote (vert) pendant la connexion à AXIS Internet Dynamic DNS Service. Une fois le processus d'enregistrement terminé, le voyant arrête de clignoter (vert fixe).
5. Visitez le site [www.axiscam.net](http://www.axiscam.net) où vous serez guidé pour l'exécution des dernières phases de l'installation. Veuillez avoir le numéro de série de votre produit à portée de main et suivre les instructions qui s'affichent à l'écran.

Le numéro de série (S/N) figure sur l'étiquette sous votre AXIS 241Q/241S

6. Entrez un mot de passe pour l'utilisateur root (administrateur).

7. Le cas échéant, acceptez l'installation de **AMC** sur votre station de travail.

**Remarque :** AMC doit être installé pour visionner les images en direct dans Microsoft Internet Explorer. Si votre environnement de travail limite les composants logiciels supplémentaires, vous pouvez configurer votre AXIS 241Q/241S pour utiliser un applet Java pour mettre à jour les images. Reportez-vous au fichier d'aide sous Live View Config > Layout > Default Viewer for Internet Explorer pour de plus amples informations. Consultez également les *Technical Specifications*, à la page 57.

8. L'installation est terminée. Passez à *Using the video server*, à la page 16.

## Installazione

### Montaggio

AXIS 241Q/241S comprende un kit per montaggio a parete o su rack. Le staffe di montaggio possono essere posizionate per montare il server video su una superficie verticale o in un armadio rack (4U). Seguire le istruzioni in basso per collegare le staffe al server video:

- 1 Estrarre il telaio grigio dal pannello anteriore del server video (non sono necessari attrezzi).



- 2 Inserire le piastre di metallo negli slot su entrambi i lati del server video.

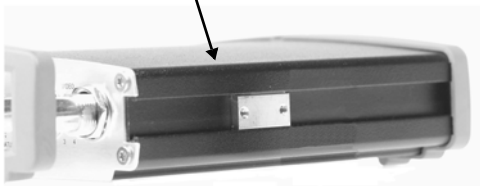

- 3 Posizionare e collegare le staffe su ciascun lato utilizzando le viti fornite.

Alternativa A



Alternativa B

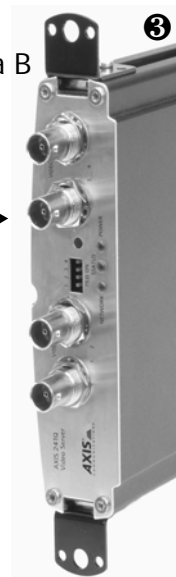

## Connessione delle videocamere

Collegare l'uscita video delle videocamere al server video AXIS 241Q/241S utilizzando un cavo coassiale standard 75 Ohm con connettori BNC.



**Nota:** Utilizzare un convertitore RCA-BNC se la videocamera è dotata di un connettore standard RCA.

## Metodi di installazione

L'AXIS 241Q/241S è progettata per l'installazione in una rete Ethernet. Ciò implica l'assegnazione automatica, ad esempio tramite un servizio di rete quale DHCP o manuale di un indirizzo IP. Selezionare una delle seguenti procedure in base alla rete:

- In Windows, utilizzare AXIS IP Utility individuare un indirizzo IP dinamico o per impostare manualmente l'indirizzo IP.
- Se la rete utilizza un server DHCP, visualizzarne le pagine di amministrazione per individuare l'indirizzo IP assegnato all'AXIS 241Q/241S.
- Se la rete utilizza un server DHCP e il computer esegue UPnP™, l'AXIS 241Q/241S sarà rilevata automaticamente e visualizzata sullo schermo. Vedere pagina 81.
- Assegnare manualmente l'indirizzo IP mediante il metodo ARP/Ping, descritto a pagina 81.
- Se la rete dispone di una connessione Internet (senza proxy HTTP) e utilizza un server DHCP per assegnare gli indirizzi IP, utilizzare la procedura di installazione in un solo clic. Vedere pagina 84.

**Note:**

- L'indirizzo IP predefinito per l'AXIS 241Q/241S è 192.168.0.90
- Nell'AXIS 241Q/241SDHCP è attivo per impostazione predefinita
- Nell'AXIS 241Q/241SUPnP™ è attiva per impostazione predefinita

## AXIS IP Utility

AXIS IP Utility è un'applicazione gratuita per Windows che consente di individuare e visualizzare la presenza di periferiche Axis sulla rete. Permette inoltre di impostare manualmente un indirizzo IP statico. Scaricare l'utility AXIS IP dalle pagine di supporto al seguente indirizzo: [www.axis.com/techsup/software](http://www.axis.com/techsup/software)

Nome	Indirizzo IP	Numero di serie
AXIS 206W - 6815E8	10.93.141.165	00408C6815E8
AXIS 206M - 682B03	10.93.141.208	00408C682B03
AXIS 213 - 659B8E	10.93.137.208	00408C659B8E
AXIS 210 - 657098	10.93.127.222	00408C657098
AXIS 210 - 658899	10.93.142.13	00408C658899
AXIS 211 - 6588AD	10.93.141.167	00408C6588AD
AXIS 211 - 18201A	10.93.137.60	00408C18201A
AXIS 210 - 656D94	10.93.135.54	00408C656D94
AXIS 211 - 65846A	10.93.140.211	00408C65846A
AXIS 221 - 181E67	10.93.130.141	00408C181E67

### Rilevamento automatico

1. Controllare che i cavi di rete e di alimentazione siano collegati all'AXIS 241Q/241S.
2. Avviare AXIS IP Utility. Quando l'AXIS 241Q/241S verrà visualizzata, fare doppio clic su di essa per aprirne l'home page.

### Impostazione manuale dell'indirizzo IP

Se l'AXIS 241Q/241S non viene visualizzata all'interno della finestra, fare clic sul pulsante **Aggiorna** per effettuare un nuovo tentativo. Se fallisce anche questo tentativo, è possibile impostare manualmente l'indirizzo IP.

1. Acquisire un indirizzo IP non utilizzato. AXIS IP Utility rileva la subnet a cui è connesso il computer. L'AXIS 241Q/241S deve essere installata sullo stesso segmento di rete.
2. Fare clic sul pulsante  (Imposta indirizzo IP mediante numero di serie) e immettere il numero di serie e l'indirizzo IP dell'AXIS 241Q/241S.
3. Fare clic sul pulsante **Imposta IP** e riavviare l'AXIS 241Q/241S (entro 2 minuti).
4. Fare clic su **Visualizza la Home Page** per accedere alle pagine Web dell'AXIS 241Q/241S.
5. Immettere una password per l'utente **root** (amministratore).
6. Se necessario, accettare l'installazione di **AMC** sulla workstation.

**Note:**

- AXIS IP Utility può anche essere utilizzato per modificare l'indirizzo IP di un dispositivo Axis rilevato in precedenza.
- AMC (AXIS Media Control) deve essere installato per visualizzare le immagini dal vivo con Internet Explorer di Microsoft. Se l'ambiente di lavoro non consente l'aggiunta di componenti software, è possibile configurare AXIS 241Q/241S in modo da utilizzare un'applet Java per l'aggiornamento delle immagini. Vedere il file della Guida Live View Config (Config immagini dal vivo) > Layout (Layout) > Default Viewer for Internet Explorer (Visualizzazione predefinita per Internet Explorer) oppure utilizzare un altro browser Web supportato, vedere *Technical Specifications*, alla pagina 57.

7. L'installazione è stata completata. Andare alla sezione *Using the video server*, alla pagina 16.

Il numero di serie (S/N) è riportato sull'etichetta sulla parte inferiore dell'AXIS 241Q/241S.



## UPnP™

La funzionalità UPnP è attiva per impostazione predefinita nell'AXIS 241Q/241S. Se è abilitata anche sul computer in uso (con sistema operativo Windows ME o XP), il server video verrà automaticamente rilevato e verrà aggiunta una nuova icona in "Risorse di rete". Fare clic su questa icona per accedere all'AXIS 241Q/241S.

### Nota:

Per installare il servizio UPnP sul computer, aprire il Pannello di controllo dal menu Start e selezionare Installazione applicazioni. Selezionare Installazione componenti di Windows e aprire la sezione Servizi di rete. Fare clic su Dettagli e selezionare UPnP come servizio da aggiungere.

UPnP™ è un marchio di certificazione dell'UPnP™ Implementers Corporation.

## ARP e Ping in Windows

Assegnare al prodotto un indirizzo IP unico da un computer della rete, come segue:

1. Ottenere un indirizzo IP non utilizzato per l'AXIS 241Q/241S dall'amministratore di rete.
2. Collegare l'AXIS 241Q/241S alla rete mediante un cavo di rete standard.
3. Individuare il numero di serie (S/N) sull'etichetta sulla parte inferiore dell'AXIS 241Q/241S.
4. Da un computer della rete, aprire un prompt dei comandi, ad esempio, dal menu Start di Windows, selezionare Esegui... e digitare cmd (command in Windows 98/ME). Fare clic su OK.
5. Immettere i comandi:

Sintassi:

```
arp -s <Indirizzo IP> <Numero di serie>
ping -l 408 -t <Indirizzo IP>
```

**Nota:** il comando ping è seguito da -l (L minuscola)

### Esempio

The screenshot shows a Windows command prompt window titled "C:\WINNT\system32\cmd.exe". The text in the window is as follows:

```
Microsoft Windows 2000 [Version 5.00.2195]
(C) Copyright 1985-2000 Microsoft Corp.

R:\>arp -s 192.168.0.125 00-40-8c-1a-2b-3c
R:\>ping -l 408 -t 192.168.0.125_
```

6. Avviare/riavviare l'AXIS 241Q/241S. Tale operazione deve essere eseguita entro 2 minuti dall'immissione dei comandi ARP e Ping.

7. Quando viene visualizzato 'Reply from 192.168.0.125: ...' (circa 10-15 secondi), digitare Ctrl+C per interrompere la sessione Ping.
8. Avviare un browser Web e immettere l'indirizzo IP nel campo Indirizzo/Posizione.
9. Premere **Invio**.
10. Immettere una password per l'utente **root** (amministratore).
11. Se necessario, accettare l'installazione di **AMC** sulla workstation.

**Nota:** AMC deve essere installato per visualizzare le immagini dal vivo in Internet Explorer di Microsoft. Se l'ambiente di lavoro non consente l'aggiunta di componenti software, è possibile configurare AXIS 241Q/241S in modo da utilizzare un'applet Java per l'aggiornamento delle immagini. Vedere il file della Guida in Live View Config (Config immagini dal vivo) > Layout (Layout)> Default Viewer for Internet Explorer (Visualizzazione predefinita per Internet Explorer) per informazioni. Oppure utilizzare un altro browser Web supportato, vedere *Technical Specifications*, alla pagina 57.

12. L'installazione è stata completata. Andare alla sezione *Using the video server*, alla pagina 16.

## ARP e Ping in UNIX/Linux

Assegnare al prodotto un indirizzo IP unico da un computer della rete, come segue:

1. Ottenere un indirizzo IP non utilizzato per l'AXIS 241Q/241S dall'amministratore di rete.
2. Collegare l'AXIS 241Q/241S alla rete mediante un cavo di rete standard.
3. Individuare il numero di serie (S/N) sull'etichetta sulla parte inferiore dell'AXIS 241Q/241S.

Sintassi:

```
arp -s <Indirizzo IP> <Numero di serie> temp
ping -s 408 <Indirizzo IP>
```

Esempio:

```
arp -s 192.168.0.125 00:40:8c:18:10:00 temp
ping -s 408 192.168.0.125
```

4. Avviare/riavviare l'AXIS 241Q/241S. Tale operazione deve essere eseguita entro 2 minuti dall'immissione dei comandi ARP e Ping.
5. Chiudere la sessione ARP/Ping una volta visualizzato 'Reply from 192.168.0.125: ...' o un messaggio simile (circa 10-15 secondi).
6. Avviare un browser Web e immettere l'indirizzo IP nel campo Indirizzo/Posizione.
7. Premere **Invio**.
8. Immettere una password per l'utente root (amministratore).
9. L'installazione è stata completata. Andare alla sezione *Using the video server*, alla pagina 16.

## Servizio AXIS Internet Dynamic DNS

Il servizio AXIS Internet Dynamic DNS è un servizio gratuito fornito da Axis, che consente di installare in modo rapido e facile il server video, che riceve un nome statico (nome DNS) e un indirizzo IP dinamico. Ulteriori informazioni sul servizio AXIS Internet Dynamic DNS sono disponibili all'indirizzo [www.axiscam.net](http://www.axiscam.net).

La registrazione per l'assistenza del server video può essere annullata in qualsiasi momento.

Per ulteriori dettagli sul servizio AXIS Internet Dynamic DNS, visitare il sito Web [www.axiscam.net](http://www.axiscam.net).

### Requisiti

L'utilizzo del servizio AXIS Internet Dynamic DNS richiede una connessione Internet che non necessiti di un server proxy per l'accesso HTTP. È consigliata la presenza di un server DHCP nella rete per l'assegnazione degli indirizzi IP.

### Procedura di installazione

Si noti che con questa procedura si invia l'indirizzo IP, la versione del firmware, il tipo di prodotto e il numero di serie dell'AXIS 241Q/241S al servizio Axis Internet Dynamic DNS. Non vengono trasferite informazioni personali.

1. Collegare l'AXIS 241Q/241S alla rete locale mediante un cavo di rete standard.
2. Collegare l'alimentazione al server video.
3. Attendere che l'indicatore di stato sulla parte anteriore del server video emetta una luce verde fissa, segno che ha ricevuto un indirizzo IP dinamico da un server DHCP della rete.
4. Attendere 60 secondi, quindi premere una sola volta il pulsante di controllo sul pannello anteriore. Durante il collegamento al servizio AXIS Internet Dynamic DNS, l'indicatore di stato sulla parte anteriore del server video emette una luce verde lampeggiante. Completato il processo di registrazione, la luce verde dell'indicatore ritorna fissa.
5. Visitare il sito Web [www.axiscam.net](http://www.axiscam.net) per essere guidati attraverso la parte restante dell'installazione. Tenere il numero di serie del prodotto a portata di mano ed eseguire le istruzioni visualizzate sullo schermo.

Il numero di serie (S/N) è riportato sull'etichetta sulla parte inferiore dell'AXIS 241Q/241S

6. Immettere una password per l'utente root (amministratore).
7. Se necessario, accettare l'installazione di AMC sulla workstation.

**Nota:** AMC deve essere installato per visualizzare le immagini dal vivo in Internet Explorer di Microsoft. Se l'ambiente di lavoro non consente l'aggiunta di componenti software, è possibile configurare AXIS 241Q/241S in modo da utilizzare un'applet Java per l'aggiornamento delle immagini. Vedere il file della Guida in Live View Config (Config immagini dal vivo) > Layout (Layout)> Default Viewer for Internet Explorer (Visualizzazione predefinita per Internet Explorer) per informazioni. Vedere anche *Technical Specifications*, alla pagina 57.

8. L'installazione è stata completata. Andare alla sezione *Using the video server*, alla pagina 16.

## Instalación

### Montaje

El AXIS 241Q/241S se suministra con un kit especial para montaje de pared o sobre un bastidor (rack). Los soportes de montaje se pueden colocar de manera que servidor de vídeo pueda montarse en una superficie vertical o sobre un bastidor (4U). Siga las instrucciones siguientes para fijar los soportes de montaje en el servidor de vídeo:

- 1 Retire el armazón gris del panel frontal del servidor de vídeo (no necesita herramientas).



- 2 Introduzca las placas metálicas en las ranuras a cada lado del servidor de vídeo.

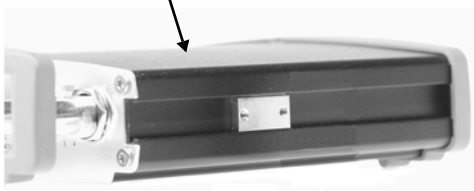

Alternativa B

- 3 Sitúe y fije los soportes a cada lado con los tornillos suministrados.

Alternativa A



## Conexión de las cámaras de vídeo

Conecte la salida de vídeo de su(s) cámara(s) al servidor de vídeo AXIS 241Q/241S utilizando un cable de vídeo coaxial de 75 ohmios con conectores BNC.



**Notas:** Utilice un adaptador de RCA a BNC si su cámara tiene un conector estándar tipo fono (RCA).

## Métodos de instalación

El AXIS 241Q/241S está diseñado para instalarse en una red Ethernet. Esto supone asignar una dirección IP, ya sea manualmente o a través de un servicio de red automatizado (DHCP). Seleccione uno de los procedimientos siguientes según su red:

- En Windows, utilice la AXIS IP Utility para encontrar una dirección IP dinámica, o para definir la dirección IP manualmente.
- Si su red utiliza un servidor DHCP, consulte las páginas de administración del mismo para encontrar la dirección IP que se le ha asignado a su AXIS 241Q/241S.
- Si su red utiliza un servidor DHCP y su PC ejecuta UPnP™, el AXIS 241Q/241S se detectará y aparecerá automáticamente en la pantalla. Consulte la página 89.
- Asigne una dirección IP manualmente utilizando el método ARP/Ping, que se describe en la página 89.
- Si su red dispone de una conexión a Internet (sin proxy HTTP) y utiliza un servidor DHCP para asignar direcciones IP, utilice el Procedimiento de instalación con un solo clic. Consulte la página 91.

**Notas:**

- El AXIS 241Q/241S tiene la siguiente dirección IP predeterminada: 192.168.0.90
- El DHCP está habilitado por defecto en el AXIS 241Q/241S
- La funcionalidad UPnP™ está habilitada por defecto en el AXIS 241Q/241S

## AXIS IP Utility

AXIS IP Utility es una aplicación de Windows gratuita que detecta y muestra dispositivos Axis en su red, y que, además, puede utilizarse para asignar manualmente una dirección IP estática. Descargue AXIS IP Utility de las páginas de asistencia técnica en: [www.axis.com/techsup/software](http://www.axis.com/techsup/software)

Nombre	Dirección IP	Número de serie
AXIS 206W - 6815E8	10.93.141.165	00408C6815E8
AXIS 206M - 682B03	10.93.141.208	00408C682B03
AXIS 213 - 659B8E	10.93.137.208	00408C659B8E
AXIS 210 - 657098	10.93.127.222	00408C657098
AXIS 210 - 658899	10.93.142.13	00408C658899
AXIS 211 - 6588AD	10.93.141.167	00408C6588AD
AXIS 211 - 18201A	10.93.137.60	00408C18201A
AXIS 210 - 656D94	10.93.135.54	00408C656D94
AXIS 211 - 65846A	10.93.140.211	00408C65846A
AXIS 221 - 181E67	10.93.130.141	00408C181E67

## Detección automática

1. Compruebe que los cables de red y alimentación estén conectados al AXIS 241Q/241S.
2. Inicie AXIS IP Utility. Cuando aparezca el AXIS 241Q/241S en la ventana, haga doble clic en el icono para abrir la página de inicio.

## Configuración manual de la dirección IP

Si el AXIS 241Q/241S no aparece en la ventana, haga clic en el botón **Actualizar** y vuelva a intentarlo. Si sigue sin aparecer, defina la dirección IP manualmente.

1. Obtenga una dirección IP que no esté en uso. AXIS IP Utility detecta a qué subred está conectado su PC. El AXIS 241Q/241S tiene que estar instalado en el mismo segmento de red.
2. Haga clic en el botón  (Configurar la dirección IP con el número de serie) e introduzca el número de serie y la dirección IP de la AXIS 241Q/241S.
3. Haga clic en el botón **Configurar IP** y, a continuación, reinicie la AXIS 241Q/241S (antes de transcurridos 2 minutos desde el clic).
4. Haga clic en **Ver Página de inicio** para acceder a las páginas web de AXIS 241Q/241S.
5. Introduzca una contraseña para el usuario root (administrador).
6. Si es necesario, acepte la instalación de **AMC** en su estación de trabajo.

**Notas:**

- También puede utilizarse AXIS IP Utility para cambiar la dirección IP de un dispositivo de Axis que se haya detectado con anterioridad.
- AMC (AXIS Media Control) tiene que estar instalado para ver vídeos en vivo en Microsoft Internet Explorer. Si su entorno de trabajo posee una limitación de componentes de software adicionales, puede configurar su AXIS 241Q/241S para que utilice Java applet para actualizar las imágenes. Consulte el archivo de ayuda Live View Config > Layout > Default Viewer para Internet Explorer, o utilice otro navegador de Web compatible, consulte *Technical Specifications*, en la página 57.

7. La instalación ha finalizado. Vaya a *Using the video server*, en la página 16.

El número de serie (S/N) está situado en la etiqueta en el lado inferior del AXIS 241Q/241S



## UPnP™

La funcionalidad UPnP está habilitada de forma predeterminada en el AXIS 241Q/241S. Si también está habilitada en su equipo (Windows ME o XP), el servidor de vídeo detectará la cámara automáticamente y agregará un nuevo icono a "Mis sitios de red". Haga clic en este icono para acceder al AXIS 241Q/241S.

### Nota:

Para instalar el servicio UpnP en su equipo, abra el Panel de control desde el menú Inicio y seleccione Agregar o quitar programas. Seleccione Agregar o quitar componentes de Windows y abra la sección Servicios de red. Haga clic en Detalles y después seleccione UPnP para agregarlo.

UPnP™ es una marca de certificación de UPnP™ Implementers Corporation.

## ARP y Ping en Windows

Asigne una dirección IP única a su producto desde un ordenador de su red, de la siguiente manera:

1. Obtenga una dirección IP que no esté en uso para el AXIS 241Q/241S desde su administrador de red.
2. Conecte el AXIS 241Q/241S a la red con un cable de red estándar.
3. Localice el número de serie (S/N) que está situado en la etiqueta en el lado inferior del AXIS 241Q/241S.
4. Desde un ordenador de su red, abra un Símbolo del sistema, es decir desde el menú Inicio de Windows, seleccione Ejecutar... y teclee cmd (command en Windows 98/ME). Haga clic en Aceptar.
5. Introduzca los comandos:

### Syntaxis:

```
arp -s <Dirección IP> <Número de serie>
ping -l 408 -t <Dirección IP>
```

**Nota:** El comando ping está seguido de -l (L minúscula)

### Ejemplo:

```
C:\WINNT\system32\cmd.exe
Microsoft Windows 2000 [Version 5.00.2195]
(C) Copyright 1985-2000 Microsoft Corp.
R:\>arp -s 192.168.0.125 00-40-8c-1a-2b-3c
R:\>ping -l 408 -t 192.168.0.125_
```

6. Inicie/reinicie el AXIS 241Q/241S. Para ello, dispone de 2 minutos después de haber introducido los comandos ARP y Ping.

7. Cuando aparezca 'Reply from 192.168.0.125: ...' (aproximadamente 10-15 segundos), presione Ctrl+C para detener Ping.
8. Inicie un navegador e introduzca la dirección IP en el campo Dirección/Ubicación.
9. Presione **Intro**.
10. Introduzca una contraseña para el usuario root (administrador).
11. Si es necesario, acepte la instalación de AMC en su estación de trabajo.

**Nota:** AMC debe estar instalado para ver videos en vivo en Microsoft Internet Explorer. Si su entorno de trabajo posee una limitación de componentes de software adicionales, puede configurar su AXIS 241Q/241S para que utilice Java applet para actualizar las imágenes. Para más información, consulte el archivo de ayuda Live View Config > Layout > Default Viewer para Internet Explorer. O utilice otro navegador de Web compatible, consulte *Technical Specifications*, en la página 57.

12. La instalación ha finalizado. Vaya a *Using the video server*, en la página 16.

## ARP y Ping en UNIX/Linux

Asigne una dirección IP única a su producto desde un ordenador de su red, de la siguiente manera:

1. Obtenga una dirección IP que no esté en uso para el AXIS 241Q/241S desde su administrador de red.
2. Conecte el AXIS 241Q/241S a la red con un cable de red estándar.
3. Localice el número de serie (S/N) que está situado en la etiqueta en el lado inferior del AXIS 241Q/241S.

Sintaxis:

```
arp -s <Dirección IP> <Número de serie> temp
ping -s 408 <Dirección IP>
```

Ejemplo:

```
arp -s 192.168.0.125 00:40:8c:18:10:00 temp
ping -s 408 192.168.0.125
```

4. Inicie/reinicie el AXIS 241Q/241S. Para ello, dispone de 2 minutos después de haber introducido los comandos ARP y Ping.
5. Cierre la sesión de ARP/Ping cuando aparezca 'Reply from 192.168.0.125: ...' (o similar) (aproximadamente 10-15 segundos).
6. Inicie un navegador e introduzca la dirección IP en el campo Dirección/Ubicación.
7. Presione **Intro**.
8. Introduzca una contraseña para el usuario root (administrador).
9. La instalación ha finalizado. Vaya a *Using the video server*, en la página 16.

## El AXIS Internet Dynamic DNS Service

El AXIS Internet Dynamic DNS Service es un servicio gratuito de Axis, que le permite instalar su servidor de vídeo de forma rápida y sencilla y, después, recibir un nombre estático (nombre DNS) y una dirección IP dinámica. Encontrará más información sobre el AXIS Internet Dynamic DNS Service en [www.axiscam.net](http://www.axiscam.net)

El servidor de vídeo puede darse de baja del servicio en cualquier momento.

Para más información sobre AXIS Internet Dynamic DNS Service, visite [www.axicam.net](http://www.axicam.net).

### Requisitos

Para utilizar AXIS Internet Dynamic DNS Service necesita una conexión a Internet que no requiera un servidor proxy para acceso HTTP. Se recomienda el uso de un servidor DHCP en la red que se utiliza para asignar direcciones IP.

### Procedimiento de instalación

Tenga en cuenta que, al llevar a cabo este procedimiento, se enviará la dirección IP del AXIS 241Q/241S, la versión de firmware, el tipo de producto y el número de serie al Axis Internet Dynamic DNS Service. No se transferirá ninguna información de carácter personal.

1. Conecte el AXIS 241Q/241S a su red local con un cable de red estándar.
2. Conecte la alimentación al servidor de vídeo.
3. Espere a que el indicador de estado situado en la parte delantera del servidor de vídeo se ilumine con una luz verde fija, indicando que ha recibido una dirección IP dinámica de un servidor DHCP en su red.
4. Espere 60 segundos y presione una vez el botón de control del panel frontal. El indicador de estado del servidor de vídeo parpadea con luz verde mientras se conecta a AXIS Internet Dynamic DNS Service. Una vez finalizado el proceso de inscripción, el indicador vuelve a brillar con luz verde fija.
5. Visite [www.axiscam.net](http://www.axiscam.net) donde le guiarán a través del resto de la instalación. Tenga listo el número de serie de su producto y siga las instrucciones de la pantalla.

El número de serie (S/N) está situado en la etiqueta en el lado inferior del AXIS 241Q/241S

6. Introduzca una contraseña para el usuario root (administrador).
7. Si es necesario, acepte la instalación de AMC en su estación de trabajo.

**Nota:** AMC debe estar instalado para poder ver imágenes en vivo en Microsoft Internet Explorer. Si su entorno de trabajo posee una limitación de componentes de software adicionales, puede configurar su AXIS 241Q/241S para que utilice Java applet para actualizar las imágenes. Para más información, consulte el archivo de ayuda Live View Config > Layout > Default Viewer para Internet Explorer. Consulte también *Technical Specifications*, en la página 57.

8. La instalación ha finalizado. Vaya a *Using the video server*, en la página 16.

## Glossary

---

**ActiveX** - A control (or set of rules) used by a browser. ActiveX controls are often downloaded and installed automatically as required.

**API** - Application Programming Interface. The Axis API can be used for integrating Axis products into other applications.

**ARP** - Address Resolution Protocol. Used to associate an IP address to a hardware MAC address. A request is broadcast on the local network to find out what the MAC address is for the IP address.

**ARTPEC** - Axis Real Time Picture Encoder - used for image compression.

**BOOTP** - A protocol that can automatically configure a network device (give it an IP address).

**CGI** - Common Gateway Interface. A set of rules (or a program) that allows a Web Server to communicate with other programs.

**Client/Server** - Describes the network relationship between two computer programs, in which one, the client, makes a service request from another - the server.

**DC-Iris** - This special type of iris is electrically controlled by the Axis camera, to automatically regulate the amount of light allowed to enter.

**DSL** - Digital Subscriber Line. A means of transferring data via standard phone lines.

**Ethernet** - A widely used networking standard.

**ETRAX** - Axis' own microprocessor.

**Firewall** - A virtual barrier between a LAN (Local Area Network) and other networks, e.g. the Internet.

**FTP** - File Transfer Protocol. Used for the simple transfer of files to and from an FTP-server.

**Full-duplex** - Transmission of data, e.g. audio, in two directions simultaneously.

**Half-duplex** - A half-duplex link communicates in one direction at a time only, much like a walkie-talkie. Two way communication is possible, but not simultaneously.

**HTTP** - Hypertext Transfer Protocol. The set of rules for exchanging files (text, images, sound, video, and other files) on the World Wide Web.

**Intranet** - A private network limited to an organization or corporation. Usually closed to external traffic.

**IP** - Internet Protocol. See TCP/IP.

**IP address** - A unique number used by a computer on the network to allow it to be identified and found.

**ISMA** - Internet Streaming Media Alliance.

**JPEG** - A standard image format, used widely for

photographs. Also known as JPG.

**LAN** - A local area network (LAN) is a group of computers and associated devices that typically share common resources within a limited geographical area.

**Linux** - A popular operating system that is "open source" and practically free of charge.

**Lux** - A standard unit for light measurement.

**Mbit/s** - Megabits per second. A unit for measuring speeds in networks. A LAN might run at 10 or 100 Mbit/s.

**MPEG-4** - A video compression standard that makes good use of bandwidth, and which can provide DVD-quality video streams at less than 1 Mbit/s.

**Multicast** - A bandwidth-conserving technology that reduces bandwidth usage by simultaneously delivering a single stream of information to multiple network recipients.

**PEM** - Privacy Enhanced Mail. An early standard for securing electronic mail. The PEM-format is often used for representing an HTTPS certificate or certificate request.

**Ping** - A small utility used for sending data packets to network resources to check that they are working and that the network is intact.

**Pre/post alarm image** - The images from immediately before and after an alarm.

**Protocol** - A special set of rules governing how two entities will communicate. Protocols are found at many levels of communication, and there are hardware protocols and software protocols.

**Router** - A device that determines the next network point to which a packet should be forwarded on its way to its final destination. A router is often included as part of a network switch (see below).

**RTP** - Real-Time Transfer Protocol. A transfer protocol designed for the delivery of live content, e.g. MPEG-4.

**Simplex** - In simplex operation, a network cable or communications channel can only send information in one direction; it's a "one-way street".

**Subnet Mask** - An IP address consists of two components: the network address and the host address. "Subnetting" enables a network administrator to further divide the host part of the address into two or more subnets. The subnet mask identifies the subnet to which an IP address belongs.

**Switch** - Whilst a simple hub transmits all data to all devices connected to it, a switch only transmits the data to the device it is specifically intended for.

**SMTP** - A common e-mail protocol.

**TCP/IP** - Transmission Control Protocol/Internet Protocol. A suite of network protocols that determine how data is transmitted. TCP/IP is used on many networks, including the Internet. TCP keeps track of the individual packets of information and IP contains the rules for how the packets are actually sent and received.

**UDP** - The User Datagram Protocol is a communications protocol that offers a limited amount of service when messages are exchanged between computers in a network that uses the Internet Protocol (IP). UDP is an alternative to the Transmission Control Protocol (TCP) and, together with IP, is also known as UDP/IP.

**Unicast** - Communication between a single sender and a single receiver over a network. A new connection is established for each new user.

**URL** - Uniform Resource Locator. An "address" on the network.

**Varifocal** - A varifocal lens provides a wide range of focal lengths, as opposed to a lens with a fixed focal length, which only provides one.

**WAN** - Wide-Area-Network. Similar to a LAN, but on a larger geographical scale.

**Web server** - A program on a computer that delivers the resources (usually web pages) requested by the web user (the client).

# Index

---

## A

Accessing the video stream 21  
Action 32  
Action buttons 17, 30  
Active/Inactive 17, 30  
Administrators 23, 40  
Advanced TCP/IP settings 43  
Alarm 32, 35, 49  
Allowed IP addresses 40  
AMC 16, 21, 74  
Anonymous viewers 40  
ARP and Ping 13  
AXIS Internet Dynamic DNS Service 15, 42  
AXIS IP Utility 11

## B

Backup 45  
Bandwidth 19, 61  
Basic TCP/IP settings 42  
Buffers 34

## C

CGI links 29, 38  
Click-in-image 38  
COM Port RS-485 50  
Constant bit rate 19  
Control button 7, 8, 47  
Customize 28

## D

Date & Time 41  
DC power 49  
Default viewer 30  
Digital input 49  
DIP switch 7, 8  
DNS configuration 43

## E

Email server 44  
Emergency recovery 53

Event servers 32  
Event types 32  
External video 31  
External video sources 17

## F

Factory default settings 47  
Frame rates 25, 60  
FTP server 32

## G

Generic HTTP 50  
Generic TCP/IP 50

## H

Host name 43  
HTML examples 31  
HTTP API 29, 38  
HTTP port number 43  
HTTP server 32  
HTTPS 41

## I

I/O Ports 45  
I/O terminal connector 9  
Include windows 35  
Installation methods 11  
Installing PTZ devices 39  
Internal video sources 17  
IP address filtering 40

## L

Live view config 28  
Live View page 23  
Logs & Reports 46

## M

Maximum bandwidth 44  
Motion detection 35  
Motion JPEG 19  
Mounting 10  
MPEG-4 19  
MPEG-4 clients 22

MPEG-4 protocols 20  
 MPEG-4 settings 44  
 Multicasting 20

## N

Network indicator 8  
 Network settings 42  
 Network traffic 44  
 Notification of IP address change 42

## O

Operators 40  
 Output buttons 17, 30  
 Overlays 25, 27  
 Own home page 29  
 Own web files 29

## P

Pan/Tilt/Zoom 37, 50  
 Pinout - I/O connectors 49  
 Port status 36  
 Ports & Devices 44  
 Post-trigger buffer 34  
 Preset positions 38  
 Pre-trigger buffer 34  
 PTZ commands 29, 38  
 PTZ control queue 38  
 Pulse 17, 30

## Q

Quad stream 17, 26

## R

Recovery 53  
 Referrals 40  
 Relative and absolute PTZ drivers 37  
 Restart 45  
 Restore 45  
 RS-232 serial connector 9  
 RS-485 49  
 RTP 20, 44  
 RTSP 20, 43

## S

Scheduled event 32  
 Security 40  
 Sequence mode 17, 31  
 Serial number 9  
 Services 42  
 Set the IP address 12  
 SMTP settings 44  
 Snapshot 17  
 SOCKS server 44  
 Specifications 57  
 Streaming MPEG-4 20  
 Support 46  
 S-Video 51  
 System options 40

## T

TCP server 32  
 TCP/IP settings 42  
 Transistor output 49  
 Triggered event 32  
 Troubleshooting 52

## U

UDP 20  
 Unicasting 20  
 Upgrade Server 45  
 UPnP 44  
 User defined links 29  
 Users 40

## V

Variable bit rate 19  
 Video input 7, 8  
 Video output 8  
 Video source 17, 25  
 Video streams 19, 25  
 View size 17

## Y

Y/C to BNC cable 51

## Free Manuals Download Website

<http://myh66.com>

<http://usermanuals.us>

<http://www.somanuals.com>

<http://www.4manuals.cc>

<http://www.manual-lib.com>

<http://www.404manual.com>

<http://www.luxmanual.com>

<http://aubethermostatmanual.com>

Golf course search by state

<http://golfingnear.com>

Email search by domain

<http://emailbydomain.com>

Auto manuals search

<http://auto.somanuals.com>

TV manuals search

<http://tv.somanuals.com>