



**Atlas Sound MG2500
Sound Masking Generator
with 2-Channel DSP
and Page Input**

Operation Manual

TABLE OF CONTENTS

Front & Rear Panel Features	pg. 2
Setup	pgs. 3-11
Logic Inputs	pg. 12
RS-232 Control	pg. 13
Specifications & Block Diagram	pg. 14
Warranty	pg. 15
Leveler FAQ's	pg. 16

INTRODUCTION

The Atlas Sound **MG2500** Sound Masking Processor provides a digital pink-noise generator, a balanced line-level audio input, and a 2-channel DSP processor, all in a single rack-space unit. Noise & audio levels, plus two channels of EQ, gain management, & delay, are adjusted via computer software. Sixteen presets can be recalled via contact-closures, RS-232, or other remote control options. The **MG2500** carries a five-year warranty.

MG2500 features include:

- ◆ pink-noise & audio input, with 2-channel DSP processor
- ◆ noise generator spectral purity ($\pm 0.1\text{dB}$ @ 0Hz-20kHz)
- ◆ precision pink-noise filtering (-3dB per octave low-pass)
- ◆ generator repeat time of noise (200 minutes)
- ◆ combined 1/3-octave & parametric equalization per channel
- ◆ selectable high & low frequency shelving filters per channel
- ◆ HPF & LPF with variable frequency & slope per channel
- ◆ leveling, compression, limiting, & soft-gating per channel
- ◆ output delay, with distance/delay calculation, per channel
- ◆ two independent matrixes for channel-to-channel mixing
- ◆ variable noise, input, & output levels with software metering
- ◆ sixteen non-volatile memory presets store/recall settings
- ◆ balanced input & outputs on plug-in barrier strip connectors
- ◆ software for Windows® 95/98/NT/2000/XP & cable included
- ◆ no manual controls on front panel, to prevent tampering
- ◆ remote control via RS-232 & programmable logic inputs
- ◆ incorporates **AES** recommended grounding practices
- ◆ **CE** marked and **UL / C-UL** listed power source
- ◆ covered by Atlas Sound's five-year warranty

FRONT & REAR PANEL FEATURES

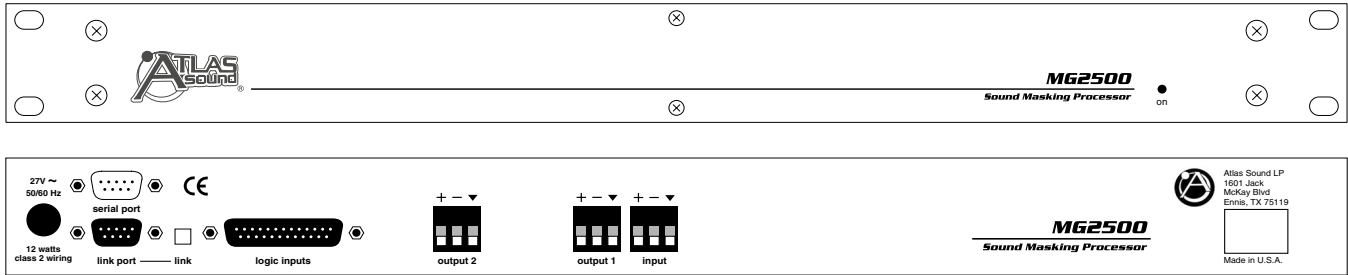

On Indicator: When power is applied to the MG2500, this red LED will light indicating power to the unit is On. When power is turned off, all current settings will be stored in non-volatile memory and recalled when power is turned back on. **NOTE:** During setup the MG2500 may instead be set to recall a special preset whenever power is turned on (see Setup on pg. 10).

AC Power Cord: The power transformer provides 27 Volts AC to the MG2500, and is detachable via a 5-pin DIN connector. The MG2500 has two internal 'self-resetting' fuses (there are no user serviceable parts inside the unit). If the internal fuses blow, they will attempt to re-set after a short period. However, this may be an indication that the MG2500 requires service.

Serial Port: This 9-pin Sub-D (male) connector provides an RS-232 Serial Port for remote control via computer or third-party controllers (see RS-232 Control on pg. 13). The Serial Port has the following pin assignments (left-to-right & top-to-bottom): **Pin 1** not used; **Pin 2** Receive Data (RxD) input; **Pin 3** Transmit Data (TxD) output; **Pin 4** Data Terminal Ready (DTR) output; **Pin 5** Ground; **Pin 6** not used; **Pin 7** Request To Send (RTS) output; **Pin 8** not used; **Pin 9** not used. The default baud rate for the Serial Port is 38,400 (See RS-232 Control on pg. 13). Atlas Sound MG2500 software and a serial cable are provided for programming via Windows® 95/98/NT/2000/XP (see Setup on pg. 3). **NOTE:** The Serial Port can also transmit commands received via the Logic Inputs (see Setup on pg. 10).

Link Port: This 9-pin Sub-D (female) connector provides a Link Port for RS-232 control of multiple ATLAS SOUND® MG2500's (see RS-232 Control on pg. 13). The Link Port of one device simply connects to the Serial Port of the next device (and so forth). **NOTE:** All but the final MG2500 in a system should have the Link Switch pressed in (see below). The Link Port has the following pin assignments (right-to-left & top-to-bottom): **Pin 1** not used; **Pin 2** Transmit Data (TxD) output; **Pin 3** Receive Data (RxD) input; **Pin 4** not used; **Pin 5** Ground; **Pin 6** not used; **Pin 7** not used; **Pin 8** not used; **Pin 9** not used. **NOTE:** The Link Port will also transmit commands received via the Logic Inputs (see Setup on pg. 10).

Link Switch: The Link Switch is used when connecting multiple devices in a 'Link Port to Serial Port' configuration (see Link Port above). From the factory, the Link Switch is released (out). When connecting multiple devices, the Link Switch must be depressed (in) on all devices except the final device in the system (the device with no Link Port connection). **NOTE:** The Link switch must remain OUT when only a single device is being used.

Logic Inputs: This 25-pin Sub-D (female) connector provides sixteen logic inputs for controlling the MG2500 via contact-closures (see Logic Inputs on pg. 12). Logic Inputs are programmed using the software and serial cable provided with the MG2500 (see Setup on pg. 10). **NOTE:** From the factory, Logic Inputs 1-16 have no pre-programmed function.

Outputs 1 & 2: These plug-in barrier strips provide the balanced analog line-level Outputs from processor Channels 1 & 2. For balanced output, wire high to (+), low to (-), and ground to (▼). For unbalanced output, wire high to (+) and ground to (▼), leaving (-) unconnected. Signal level will be reduced by 6dB when outputs are unbalanced.

Input: This plug-in barrier strip provides the balanced analog line-level audio input. For balanced input, wire high to (+), low to (-), and ground to (▼). For unbalanced input, wire high to (+) and ground to both (-) & (▼). **NOTE:** The internal pink-noise generator provides a second input. Input & noise may be assigned in any combination to the two processing channels (see Setup on pg. 4).

SETUP

MG2500 parameters are all adjustable using the Windows® 95/98/NT/2000/XP software and serial cable provided with the unit. The MG2500 program includes several control screens, which are described on the following pages. Once the software is started (and Comm Port Configuration is set), the control screens are accessed via the drop-down menus at the top of the opening screen. The Main screen appears whenever an MG2500 file is opened. Gain Matrix #1, Gain Manager, EQ, Gain Matrix #2, & Delay screens are then available from the Main screen. Logic Definition & Configuration Options screens are also available from the Configure MG2500 menu. The File menu provides functions such as save, open, download, etc. The Settings menu recalls the Comm Port Configuration screen. The Window menu arranges the active product screens. The Help menu explains the available adjustments. To install MG2500 Software: Select 'Run' from the 'Start' menu, and enter A:\SETUP. System Requirements: Windows® 95/98/NT/2000/XP with 5MB of available hard disk space (serial port required for 'on-line' operation).

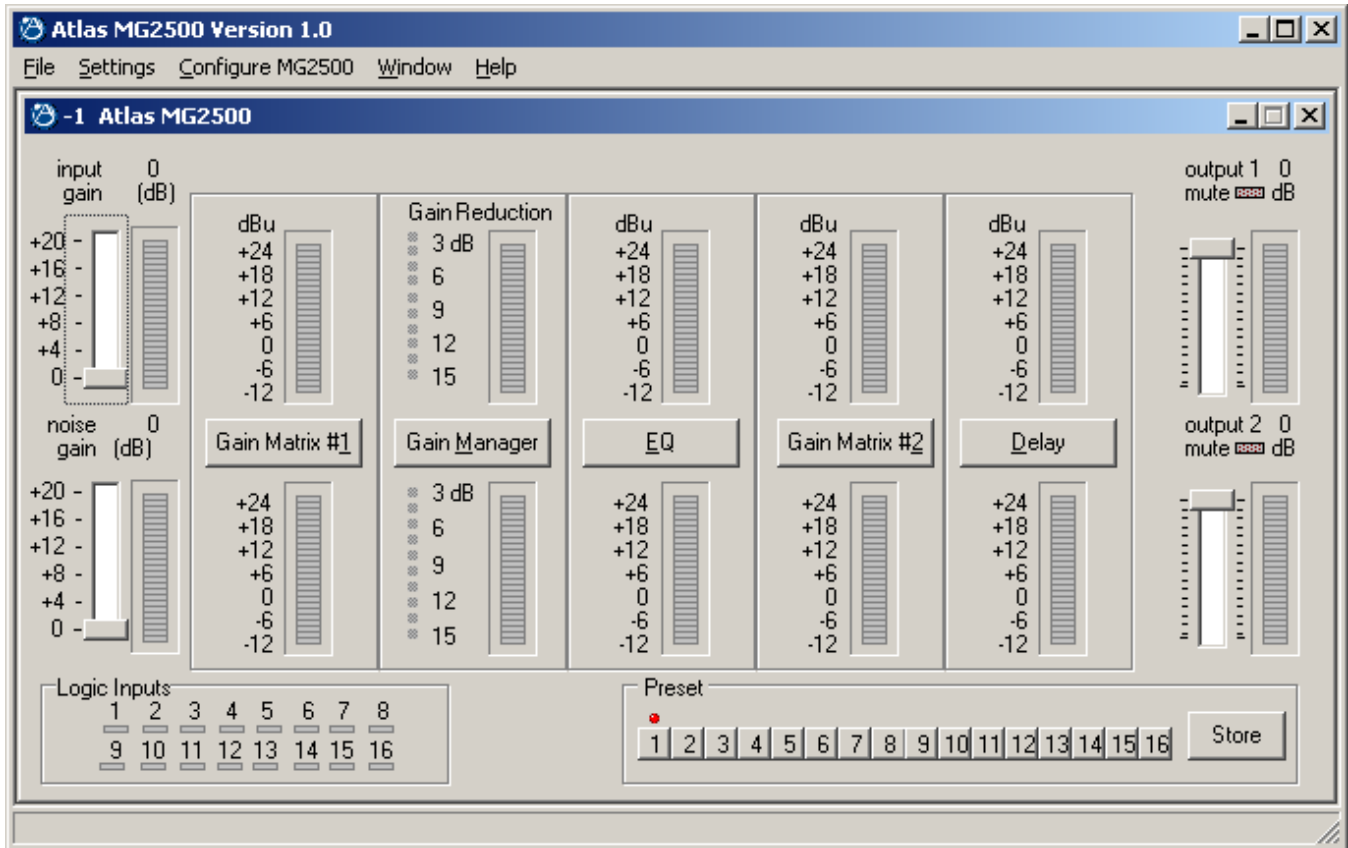

MAIN SCREEN

The Main Screen is used to adjust MG2500 input/output levels, to access the processing control screens, and to store/recall Presets 1~16. Adjustments are made with the computer mouse (or keyboard). Input, Noise, Output 1, & Output 2 levels are adjusted by dragging the corresponding 'faders' up or down. These are the analog signal input & output circuits. 'Meters' are provided on each channel to display input/output levels at specific points along the digital signal processing paths, and at the analog outputs. **NOTE:** For best performance, adjust levels so the meters show occasional peaks in the yellow area, but never to the top (red). Output 1 Mute & Output 2 Mute will toggle the respective output signal on/off, as well as indicate the output muting status. Logic Inputs indicators will light whenever the respective Logic Inputs are turned on via external remote control (see Logic Inputs on pg. 12). Preset buttons recall the corresponding presets from non-volatile memory. Presets must first be created & stored by the user (no factory presets). The Store button opens a menu for storing current settings in any of the Presets 1~16. Presets may be stored and recalled (in total or in part) via remote control (see Logic Input Definitions screen on pg. 10). The title bar across the top of the Main screen will indicate the Device #, the custom Device Name, and the model of product being controlled. MG2500 software can operate 'off-line' (with no product connected) by opening a 'new' file for the desired product. The Device # for 'off-line' files is assigned sequentially as a negative number.

SETUP

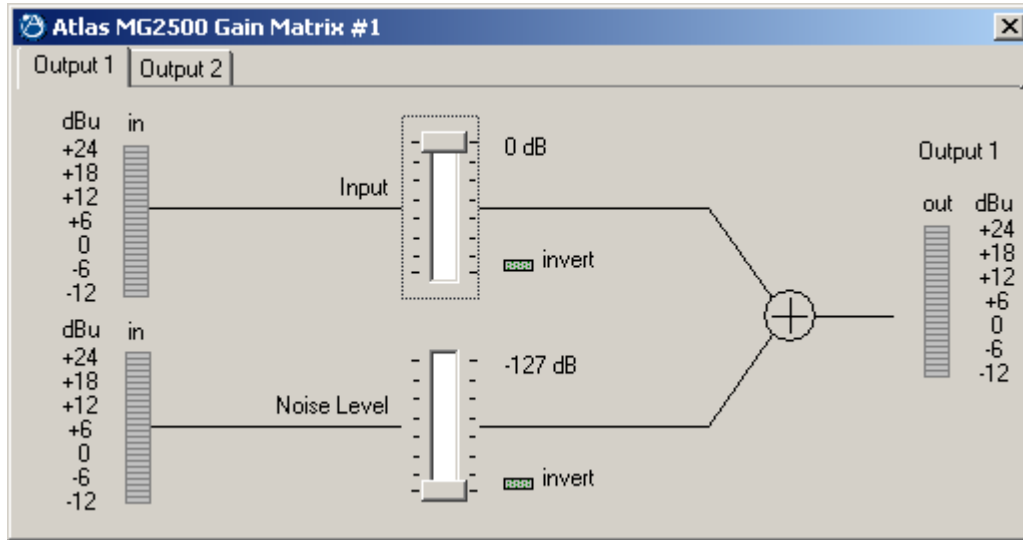

GAIN MATRIX #1 SCREEN

The Gain Matrix #1 screen provides a channel-to-channel (2x2) mix matrix, which can be used to adjust the amount of Input & Noise signal being routed to each of the processing channels (Output 1 & Output 2). From the factory, Input 1 is routed to Output 1 only, and Noise is routed to Output 2 only, providing two independent signal paths. Levels are adjusted by dragging the corresponding 'faders' up or down. 'Meters' are provided on each channel to display input/output levels at Gain Matrix #1. **NOTE:** For best performance, adjust levels so the meters show occasional peaks in the yellow area, but never to the top (red). Invert allows the phase of each corresponding signal path to be reversed (180°).

The MG2500 has two basic applications which utilize Gain Matrix #1:

- 1) Input 1 can be routed to Output 1 and Noise can be routed to Output 2. Each channel of processing is dedicated to either Input 1 or Noise signal. Switching between Input 1 & Noise signals (to either Output) is then accomplished via Gain Matrix #2 presets (see Gain Matrix #2 screen on pg. 8). This is effective when only a single output (zone), or two outputs (zones) with independent delay, are required.
- 2) Gain Matrix #1 presets can be used to switch between Input 1 or Noise signal being routed to either Output. Each channel of processing is dedicated to a specific Output (zone), via Gain Matrix #2. Separate EQ presets for Input 1 & Noise signals, as they appear at each output (zone), can also be used. This is effective when two outputs (zones), each with dedicated processing, are required.

Of course, the MG2500 can simply be configured for processing Noise (or Input 1) signal only, at both Outputs.

SETUP

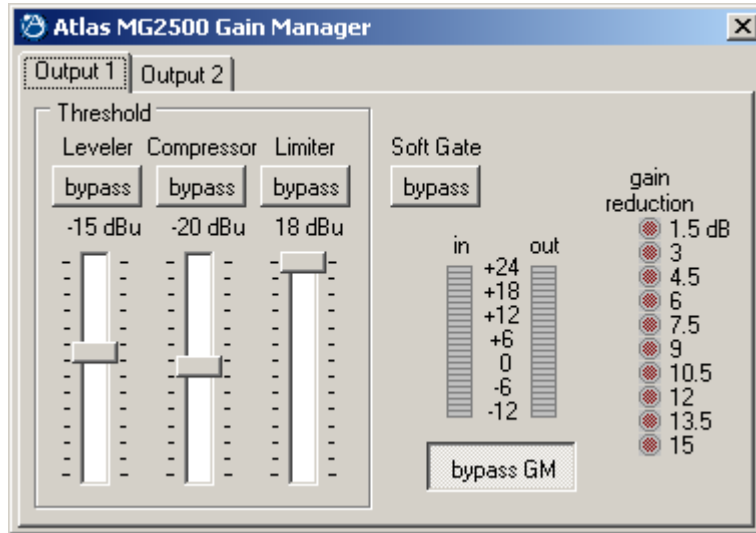

GAIN MANAGER SCREEN

The Gain Manager screen is used to adjust Leveler, Compressor, Limiter & Soft Gate settings for each of the processing channels (Output 1 & Output 2). Threshold adjusts the signal level at which the Leveler, Compressor, & Limiter functions are triggered. Therefore, these controls determine the amount and type of gain processing to be applied to the signals. The Leveler controls the long-term average signal level. If the average signal level increases, the Leveler will reduce gain to compensate. If the average signal level decreases, the Leveler will increase gain to compensate. The Compressor controls short-term peaks in signal level by providing 'soft-knee' compression, which automatically varies in ratio from 1.1:1 on signals just slightly above Threshold, to more than 10:1 at full compression. The Compressor responds to average & peak levels, working with the Leveler to maintain a constant output level. The Limiter controls short-term peaks in signal level by providing 'hard' limiting, which establishes an absolute ceiling level. The Limiter provides protection against clipping distortion, and the chance of amplifier overload or speaker damage, due to sudden transients. From the factory, the default Threshold settings will provide approximately 6dB of gain reduction on input signals of nominal level. Bypass defeats the individual Leveler, Compressor, or Limiter functions for that Channel, without changing the actual settings. Soft Gate Bypass defeats a downward expander circuit for that Channel, which reduces gain 2dB for each 1dB that signal falls below threshold (-30dBu). The Soft Gate gracefully attenuates background/ambient noise during periods of silence. Bypass GM defeats all Leveler, Compressor, Limiter, & Soft Gate functions for that Channel, without changing the actual settings. 'Meters' are provided on each channel to display input/output levels, as well as the amount of gain reduction, at the Gain Manager section. **NOTE:** *The Gain Manager provides gain reduction even on input signals of nominal level. Therefore, all subsequent meters will indicate the resultant lower levels.* **CAUTION:** *The Gain Manager can increase gain for lower level signals. Therefore, after all system settings have been adjusted, temporarily bypass the Gain Manager as a test of system feedback stability. If acoustic feedback occurs, reduce the system amplifier levels or use the MG2500 parametric equalizer to eliminate feedback nodes, before re-enabling the Gain Manager.*

SETUP

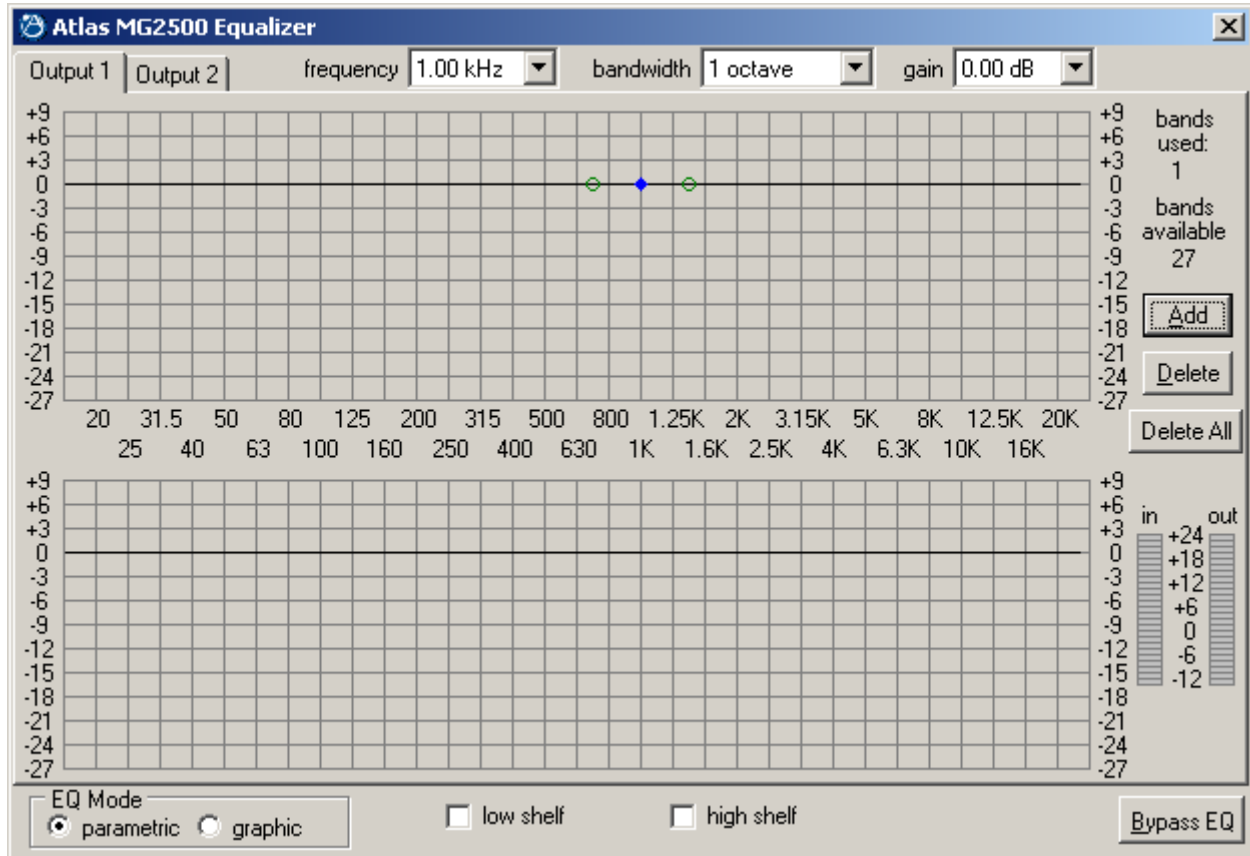

PARAMETRIC EQ SCREEN

The Parametric EQ screen is used to adjust equalization for each of the processing channels (Output 1 & Output 2). Up to 28 bands of equalization, plus high-pass & low-pass filters, are available per channel. **NOTE:** *Parametric & Graphic equalization techniques may be used simultaneously on the same channel, as long as the total number of bands per channel does not exceed 28.* **Frequency** selects a center frequency for the current band. **Gain** selects the amount of cut or boost applied at the center frequency for the current band. **Bandwidth** selects the range of frequencies, above & below the center frequency, which will also be affected by the current band. Frequency, Gain, & Bandwidth may also be adjusted by dragging the cursors shown inside the **upper graph** area. Dragging the solid dot affects both Frequency & Gain. Dragging either of the open circles will affect Bandwidth. **Add** advances to a new parametric filter band (at 1kHz), leaving place-mark cursors for any previous bands. **NOTE:** *Initially, there are no parametric filter bands available for adjustment, until Add has been selected.* **Delete** erases the current band, and returns to the previous band. **Delete All** erases all parametric bands. **Bands Used** & **Bands Available** are shown above. The **lower graph** area shows the cumulative effect of all equalization. Right-clicking provides a menu of copy/paste functions, which allows settings of the 28 bands, plus high-pass & low-pass filters, to be copied from one channel to the other, or to another unit. **Meters** are provided on each channel to display input/output levels at the EQ section. **EQ Mode** selects the Parametric EQ Screen or the Graphic EQ Screen (see Graphic EQ Screen on next page). **Low Shelf** adds a low-frequency shelving parametric band. **High Shelf** adds a high-frequency shelving parametric band. **NOTE:** *Low Shelf & High Shelf bands are NOT affected by the Delete or Delete All buttons. They may only be deleted by means of their individual check boxes.* **Bypass EQ** defeats all parametric & graphic equalization for that channel, without changing actual settings

SETUP

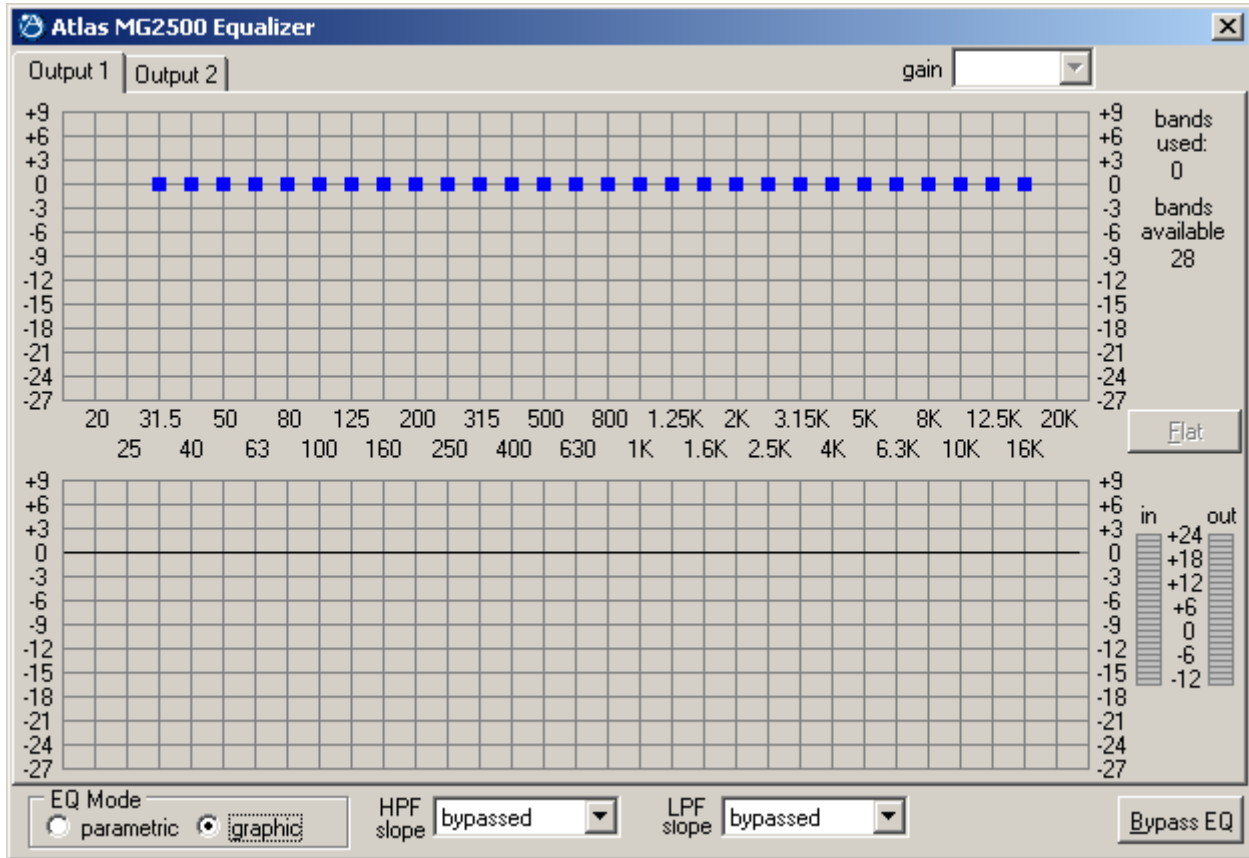

GRAPHIC EQ SCREEN

The Graphic EQ screen is used to adjust equalization for each of the processing channels (Output 1 & Output 2). Up to 28 bands of equalization, plus high-pass & low-pass filters, are available per channel. **NOTE:** *Parametric & Graphic equalization techniques may be used simultaneously on the same channel, as long as the total number of bands per channel does not exceed 28.* Default operation of the Graphic EQ is 1/3-octave, 28-bands, and ISO standard center frequencies. Therefore, gain for each band can be simply adjusted by dragging the square cursors up or down inside the upper graph area. Flat erases all graphic bands, setting all faders to the center line. Right-clicking provides a menu of copy/paste functions, which allows settings of the 28 bands, plus high-pass & low-pass filters, to be copied from one channel to the other, or to another unit. Bands Used & Bands Available are shown above. The lower graph area shows the cumulative effect of all equalization. Meters are provided on each channel to display input/output levels at the EQ section. EQ Mode selects either Parametric or Graphic equalization (see Parametric EQ Screen on previous page). HPF Slope enables a High-Pass Filter by selecting a desired slope. LPF Slope enables a Low-Pass Filter by selecting a desired slope. Once a High-Pass Filter or Low-Pass Filter is enabled, a square cursor appears in the upper graph area to allow frequency adjustment for that filter. The effect of High-Pass & Low-Pass Filters is also shown in the lower graph area. **NOTE:** *HPF & LPF are NOT affected by the Flat button. They may only be deleted by means of their individual menu boxes.* Bypass EQ defeats all parametric & graphic equalization filters for that channel, without changing actual settings.

SETUP

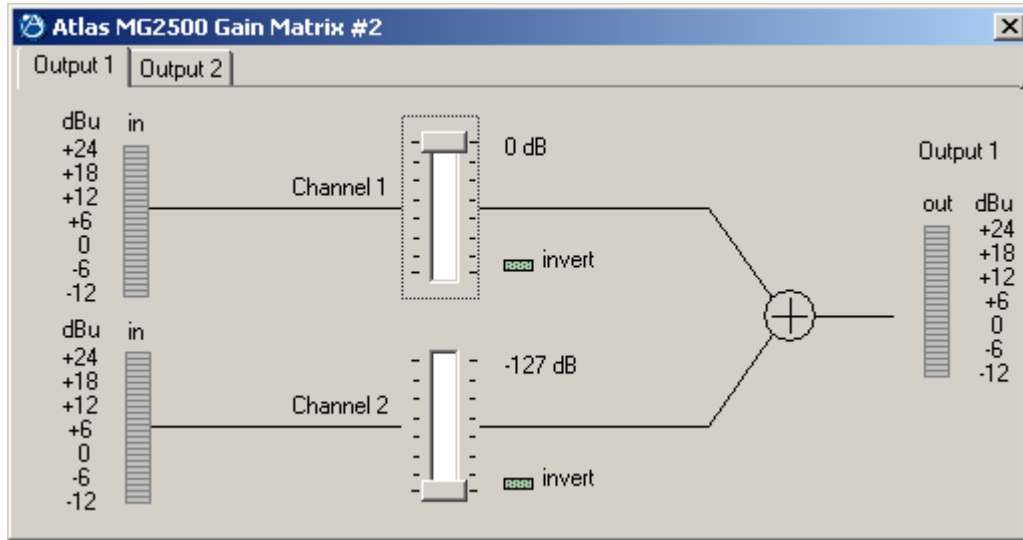

GAIN MATRIX #2 SCREEN

The Gain Matrix #2 screen provides a channel-to-channel (2x2) mix matrix (identical to Gain Matrix #1), which can be used to adjust the amount of signal being routed from each channel to the other. From the factory, Channel 1 is routed to Output 1 only, and Channel 2 is routed to Channel 2 only, providing two independent signal paths. Levels are adjusted by dragging the corresponding 'faders' up or down. 'Meters' are provided on each channel to display input/output levels at Gain Matrix #1. **NOTE:** For best performance, adjust levels so the meters show occasional peaks in the yellow area, but never to the top (red). Invert allows the phase of each corresponding signal path to be reversed (180°).

The MG2500 has two basic applications which utilize Gain Matrix #2:

- 1) Each channel of processing is dedicated to either Input 1 or Noise signal, using Gain Matrix #1 (see Gain Matrix #1 screen on pg. 4). Switching between Input 1 & Noise signals (to either Output) is then accomplished via Gain Matrix #2 presets. This is effective when only a single output (zone), or two outputs (zones) with independent delay, are required.
- 2) Gain Matrix #1 presets can be used to switch between Input 1 or Noise signal being routed to either Output (see Gain Matrix #1 screen on pg. 4). Each channel of processing is dedicated to a specific Output (zone), via Gain Matrix #2. Separate EQ presets for Input 1 & Noise signals, as they appear at each output (zone), can also be used. This is effective when two outputs (zones), each with dedicated processing, are required.

Of course, the MG2500 can simply be configured for processing Noise (or Input 1) signal only, at both Outputs.

SETUP

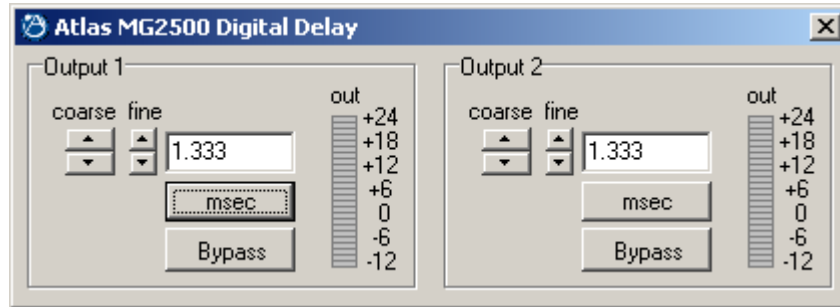

DIGITAL DELAY SCREEN

The Digital Delay screen is used to adjust delay time settings for each Output. Delay time is shown in the window, with adjacent buttons providing the up/down adjustments. Coarse buttons change the delay time in 1 milli-second increments. Fine buttons change the delay time in 21 micro-second increments. Delay time may also be entered directly into the window, but will be rounded to the nearest available setting. Msec allows delay times to instead be entered & calculated in terms of distance measurements (inches, feet, centimeters, or meters). Bypass temporarily sets delay time for the corresponding Output to minimum (1.333 msec).

SETUP

Atlas MG2500 Logic Input Definitions

Echo Character: none

Power-Up Actions

Store System Preset: [dropdown]

Recall System Preset: [dropdown]

Input Gain: [dropdown]

Noise Gain: [dropdown]

Gain Matrix 1: [dropdown]

Output 1 Gain Manager: [dropdown]

Output 2 Gain Manager: [dropdown]

Output 1 EQ: [dropdown]

Output 2 EQ: [dropdown]

Gain Matrix 2: [dropdown]

Output 1 Delay: [dropdown]

Output 2 Delay: [dropdown]

Output 1 Gain: [dropdown]

Output 2 Gain: [dropdown]

Binary Mode: disabled

Binary Combination: [dropdown]

Logic Inputs:

13 Open	14 Open	15 Open	16 Open
13 Close	14 Close	15 Close	16 Close
9 Open	10 Open	11 Open	12 Open
9 Close	10 Close	11 Close	12 Close
5 Open	6 Open	7 Open	8 Open
5 Close	6 Close	7 Close	8 Close
1 Open	2 Open	3 Open	4 Open
1 Close	2 Close	3 Close	4 Close

Clear Help Close

LOGIC INPUT DEFINITIONS SCREEN

The Logic Input Definitions screen is used to assign specific 'actions' to the sixteen Logic Inputs. Logic Inputs allow remote control of the MG2500 via external circuits, such as switches, contact-closures, active driver circuits, and/or 'open-collector' logic outputs (see Logic Inputs on pg. 12). From the factory, Logic Inputs 1-16 have no pre-programmed functions. However, using the Logic Input Definitions screen, each Logic Input may be assigned various 'actions'. Logic Inputs selects which Logic Input is to be defined. **NOTE:** *Since Logic Inputs are controlled by switches, contact-closures, etc., each Logic Input may be assigned certain actions to perform when the switch is 'opened', and different actions to perform when that same switch is 'closed'.* Binary Mode selects a special group of Logic Inputs which can also be defined. This allows certain actions to be performed only when a specified condition of open/closed Logic Inputs exists within the group. When a Binary Mode is selected, indicators for the chosen group of Logic Inputs will appear below. Binary Combination then selects the specific combination of open/closed (on/off) Logic Inputs that needs to exist (for the assigned actions to be performed). When a combination is selected, indicators will light (red) to designate which of the Logic Inputs within the group are closed (on) for that condition. **NOTE:** *When a Binary Mode is selected, the chosen group of Logic Inputs can no longer be defined individually. It is not necessary to select a Binary Mode when simply defining individual Logic Inputs.* Power-Up Actions allows specific actions to be assigned for the MG2500 to perform each time power is turned on. Echo Character selects the RS-232 ASCII character which will be transmitted via the MG2500 Serial Port whenever the selected Logic Input is switched. **NOTE:** *From the factory, no echo characters are assigned to the Logic Inputs. Echo Characters are used primarily for customizing remote control commands amongst various RS-232 controlled products within a system (see RS-232 Control on pg. 13).* Store System Preset allows store actions for Temp Presets A-D to be assigned to the selected Logic Input. Temp Presets A-D allow current settings of the MG2500 to be temporarily stored in memory. Temp Presets are useful when re-establishing settings which existed prior to a change. For example: recalling settings for noise masking, after paging has occurred. Recall System Preset allows recall actions for Presets 1-16, and Temp Presets A-D, to be assigned to the selected Logic Input. **NOTE:** *System Preset actions affect settings from all stages of the MG2500 (Inputs, Gain Matrix #1, Gain Manager, EQ, Gain Matrix #2, Delay, & Outputs). However, the settings that Presets 1-16, and Temp Presets A-D, store for specific stages of the MG2500 may be recalled independently.* Input/Noise Gain, Gain Matrix #1, Output 1/2 Gain Manager, Output 1/2 EQ, Gain Matrix #2, Output 1/2 Delay, and Output 1/2 Gain allow recall actions for their respective portions of Presets 1-16, and Temp Presets A-D, to be assigned to the selected Logic Input. For example: two independent processing channels, each with independent preset selection. Output 1/2 Gain also allow various output volume & muting actions to be assigned to the selected Logic Input. Clear allows all actions assigned to the selected Logic Input (or all Logic Inputs) to be cleared. Help provides additional instruction. Close will close the Logic Input Definition screen.

SETUP

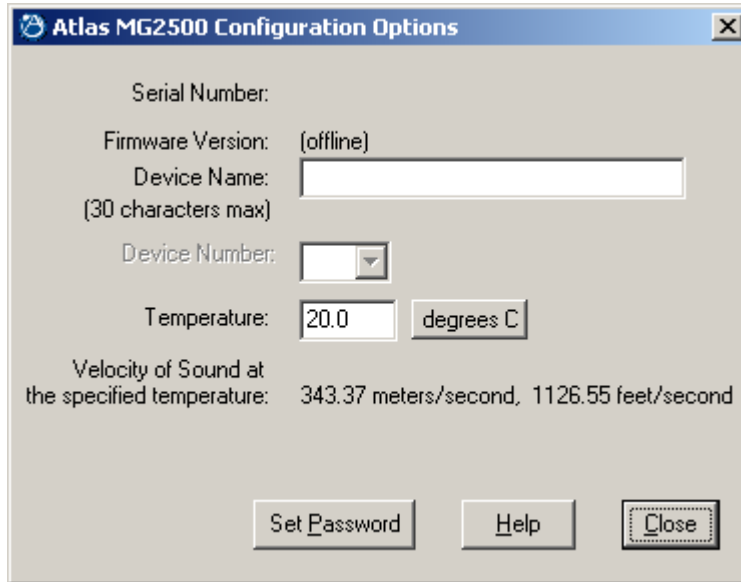

CONFIGURATION OPTIONS SCREEN

The Configuration Options screen is used to select options which customize the operation of the MG2500. At the top of the Configuration Options screen, the Serial Number and Firmware Version of the MG2500 will be displayed. MG2500 software can operate 'off-line' (with no product connected) by opening a 'new' file. The Serial Number and Firmware Version are not displayed for 'new' ('off-line') files. Device Name allows a custom name to be given to the particular MG2500, by entering up to 30 characters of text. The Device Name will be stored in the MG2500 memory, and will be displayed on the title bar of the Main screen whenever that MG2500 is accessed with the software. Device Number allows a device number (0-63) to be assigned to the currently active MG2500. This allows multiple MG2500 (or other ATLAS SOUND[®] programmable products) to be individually controlled when linked together. Unique device numbers must be assigned to each device before the devices are linked together. Temperature selects the desired air temperature to be used in calculating Velocity of Sound (seen below). Temperature, and the resultant Velocity of Sound, are global parameters which affect distance/delay calculations for the Delay section. Set Password allows the MG2500 to be assigned a password (up to seven characters), which will then be required before any future software communication with that unit is allowed. **NOTE:** *When multiple programmable products are connected in a system configuration (via Serial & Link Ports), it is strongly recommended that only one unit in the system be assigned a password. A single unit having a password will prevent software communication with all units in the system. Communication with other units will still be possible, but only by first dis-connecting them from the unit which has been assigned a password.* Help provides additional instruction. Close will close the Configuration Options screen.

LOGIC INPUTS

Sixteen Logic Inputs are available on a rear panel 25-pin Sub-D (female) connector. Logic Inputs allow remote control of the MG2500 via external circuits, such as switches, contact-closures, active driver circuits, and/or 'open-collector' logic outputs. From the factory, Logic Inputs 1~16 have no pre-programmed function. However, each Logic Input may be assigned different 'actions' using the MG2500 software and serial cable provided with the unit (see Setup on pg. 10). Since Logic Inputs are controlled by switches, contact-closures, etc., each Logic Input may be assigned two functions (one for switch 'closed' and one for switch 'open').

Logic Inputs have the following pin assignments (right-to-left & top-to-bottom): **Pins 1-16** Logic Inputs 1-16; **Pins 17-25** Ground.

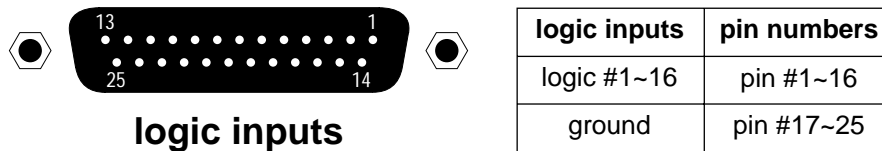

When nothing is connected to a Logic Input, an internal pull-up resistor keeps it at a 'high' idle state (+5.0 VDC). The Logic Input is activated when its input goes 'low' (less than +0.8 VDC), and is de-activated when its input goes 'high' (greater than +2.4 VDC). A Logic Input is controlled in one of three ways: 1) Use an NPN style 'open-collector' logic output from an external device (such as another product or third-party controller) to short the Logic Input to ground. 2) Use a switch, relay, or other contact-closure (such as from a third-party controller) to short the Logic Input to ground. 3) Use an active TTL output driver circuit (such as from a third-party controller) to actively drive the Logic Input to a 'high' or 'low' state.

Multiple contact-closures or 'open-collector' logic outputs may be wired in parallel to a single Logic Input (see diagram below). Logic Outputs and contact-closures should be rated for at least 5 Volts / 1mA operation. Low-current / dry-contact closures are recommended for reliability. Active output driver circuits should not exceed a signal range of 0~5 Volts DC, and should have a minimum pulse width of 100 milli-seconds. Logic Input impedances are approximately 10k ohms.

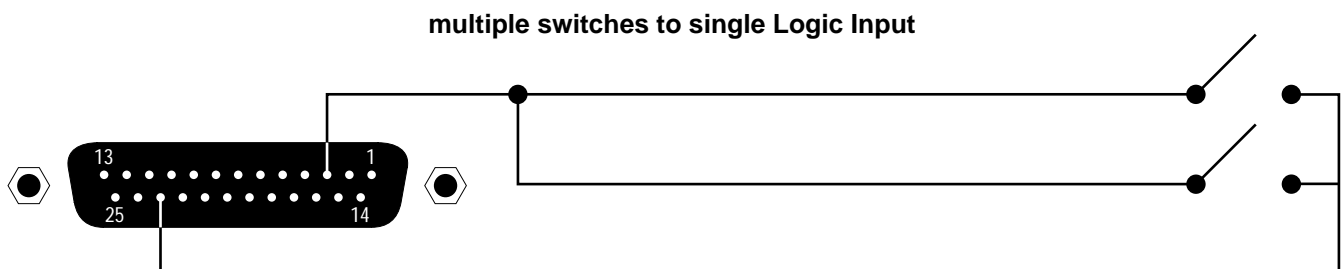

RS-232 CONTROL

Serial Port: The 9-pin Sub-D (male) connector on the MG2500 rear panel provides the RS-232 compatible serial interface signals used for computer control. The MG2500 Serial Port transmits serial data on pin 3 (TxD), receives serial data on pin 2 (RxD), and provides a ground on Pin 5. The Data Terminal Ready (DTR) & Request To Send (RTS) output signals are connected to the +12 Volt power supply (through a resistor) and are always asserted when the MG2500 power is on. **NOTE:** *The Serial Port may also transmit commands which are received via the Logic Inputs, depending upon the echo character assignments (see Setup on pg. 10).*

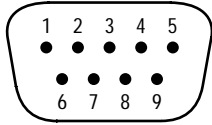

- | | |
|--|--|
| pin #1 = not used | pin #6 = not used |
| pin #2 = Receive Data (RxD) input | pin #7 = Request To Send (RTS) output |
| pin #3 = Transmit Data (TxD) output | pin #8 = not used |
| pin #4 = Data Terminal Ready (DTR) output | pin #9 = not used |
| pin #5 = ground | |

serial port

The MG2500 only requires receive data (pin 2), transmit data (pin 3), and signal ground (pin 5) to be connected for successful data communications (see cable diagram below). However, the PC may require that signals be present on the data set ready, clear to send, or carrier detect inputs, as well as the receive data, transmit data, and signal ground pins. Success or failure depends entirely on the actual computer hardware and software being used. When trying to solve an interfacing problem, the most important thing to remember is that an output of one device should connect to one or more inputs of the other device, and that two outputs should never be connected together. Also, keep in mind that the RS-232 specification calls for the cable length to be no greater than 50 feet (although it is not unusual to be able to operate over distances of 150 to 250 feet), and the connectors must be of the appropriate gender (male or female) to mate properly. For best results, a shielded cable should be used, with the shield connected to chassis ground. Since the MG2500 serial interface ground is also tied (indirectly) to the analog signal ground, undesirable ground loops may occur when the MG2500 is connected to a PC (if the system grounding is not carefully designed). For best performance, the PC ground and the chassis ground of the MG2500 should be at the same potential, and the PC should get AC power from the same source as the MG2500 (and any other audio equipment which is connected to the MG2500). Since most lap-top computers are isolated from earth ground, this should rarely pose a problem.

Serial Port Data Communications Parameters: The MG2500 communicates through the Serial Port at the factory selected rate of 38400 bits per second, with 8 data bits, 1 stop bit, and no parity. The MG2500 utilizes a subset of the standard 7-bit ASCII character set. The eighth data bit of each character (the most significant bit) should always be 0. The computer should not echo the characters it receives. The computer should not be set for either hardware (DTR) or software (XON/XOFF) flow control. The baud rate may be changed to either 2400, 9600, or 19200 bits per second by means of the software (see Setup on pg. 3). **NOTE:** *Baud rate may need to be changed when the MG2500 is being used in RS-232 systems with other products having a lower maximum baud rate.*

Link Port Connections: The 9-pin Sub-D (female) connector on the MG2500 rear panel provides the RS-232 compatible serial interface signals used for linking multiple products within a system. The Link Port of one device simply connects to the Serial Port of the next device, and so forth (see diagram below). **NOTE:** *All but the final device in a system should have its 'Link' switch pressed in (see Front & Rear Panel Features on pg. 2). The Link Port may also transmit commands which are received via the Logic Inputs, depending upon the echo character assignments (see Setup on pg. 10).*

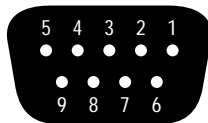

- | | |
|--|--------------------------|
| pin #1 = not used | pin #6 = not used |
| pin #2 = Transmit Data (TxD) output | pin #7 = not used |
| pin #3 = Receive Data (RxD) input | pin #8 = not used |
| pin #4 = not used | pin #9 = not used |
| pin #5 = ground | |

link port

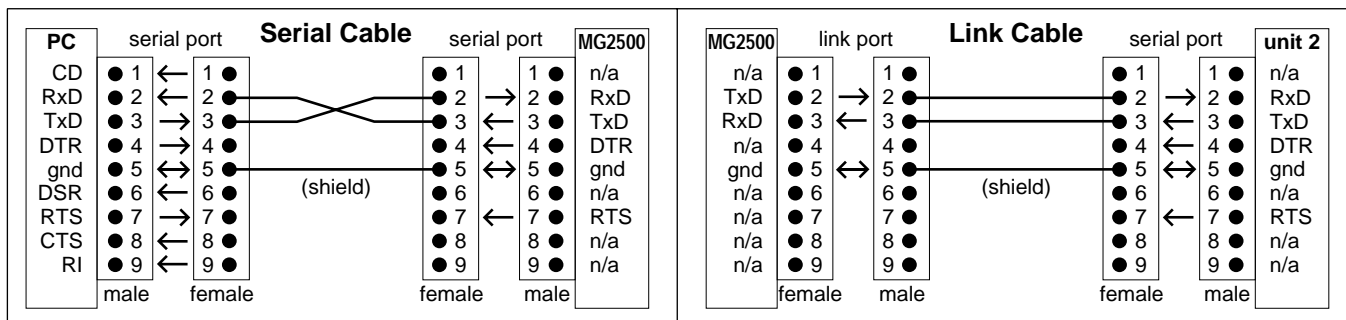

SPECIFICATIONS & BLOCK DIAGRAM

Frequency Response (20Hz-20kHz @ +4dBu):	+0/-0.5dB	Sampling Rate:	48kHz
THD+Noise (20Hz-20kHz @ +4dBu):	< 0.002%	A/D & D/A Converters:	128x oversampled 24-bit sigma delta
Dynamic Range (20Hz-20kHz):	> 100dB	Power Consumption:	< 15 watts
Maximum Gain:	20dB	Dimensions:	
Input Impedance (balanced):	20k ohms	height (1 rack space)	1.75" (44mm)
Maximum Input (balanced):	+24dBu	width	19" (483mm)
Output Impedance (balanced):	200 ohms	depth	7" (178mm)
Maximum Output (balanced):	+24dBu	Weight:	4.5 lbs. (2.04kg)

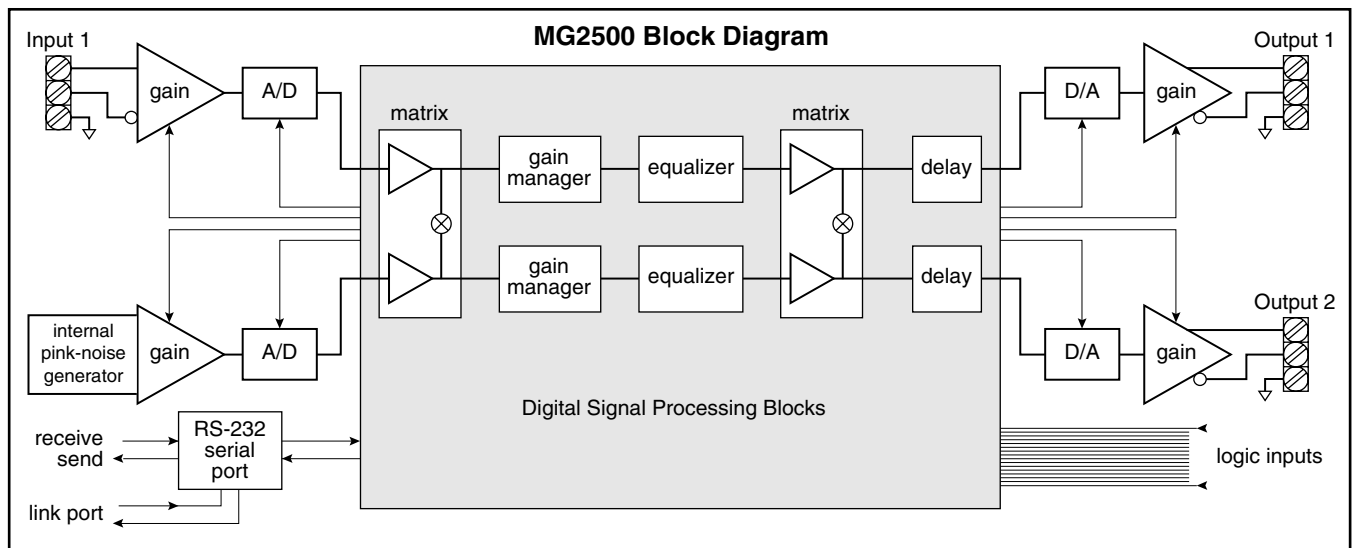

WARRANTY

ATLAS SOUND IS PLEASED TO EXTEND THE FOLLOWING 5-YEAR LIMITED WARRANTY TO THE ORIGINAL PURCHASER OF THE PROFESSIONAL SOUND EQUIPMENT DESCRIBED IN THIS MANUAL.

Limited Warranty:

All products manufactured by Atlas Sound are warranted to the original dealer/installer, industrial or commercial purchaser to be free from defects in material and workmanship and to be in compliance with our published specifications, if any. "This warranty shall extend from the date of purchase for a period of five years on the Atlas Sound MG2500.

Electrolytic capacitors, and the normal wear and tear of appearance items such as paint, knobs, handles, fuses and lamps are not covered under this warranty.

This warranty will be VOIDED if the serial number has been removed or defaced; or if the product has been subjected to accidental damage, abuse, rental usage, alterations, or attempted repair by any person not authorized by ATLAS SOUND to make repairs; or if the product has been installed contrary to ATLAS SOUND recommendations.

Atlas Sound will solely at its discretion, re-place at no charge or repair free of charge defective parts or products when the product has been applied and used in accordance with our published operation and installation instructions. We will not be responsible for defects caused by improper storage, misuse (including failure to provide reasonable and necessary maintenance), accident, abnormal atmospheres, water immersion, lightning discharge, or malfunctions when products have been modified or operated in excess of rated power, altered, serviced or installed in other than a workmanlike manner. The original sales invoice should be retained as evidence of purchase under the terms of this warranty. All warranty returns must comply with our re-turns policy set forth below. When products returned to Atlas Sound do not qualify for repair or replacement under our warranty, repairs may be performed at prevailing costs for material and labor unless there is included with the returned product(s) a written request for an estimate of repair costs before any non-warranty work is performed. In the event of replacement or upon completion of repairs, return shipment will be made with the transportation charges collect.

EXCEPT TO THE EXTENT THAT APPLICABLE LAW PREVENTS THE LIMITATION OF CONSEQUENTIAL DAMAGES FOR PERSONAL INJURY, ATLAS SOUND SHALL NOT BE LIABLE IN TORT OR CONTRACT FOR ANY DIRECT, CONSEQUENTIAL OR INCIDENTAL LOSS OR DAMAGE ARISING OUT OF THE INSTALLATION, USE OR INABILITY TO USE THE PRODUCTS. THE ABOVE WARRANTY IS IN LIEU OF ALL OTHER WARRANTIES INCLUDING BUT NOT LIMITED TO WARRANTIES OF MERCHANTABILITY AND FITNESS FOR A PARTICULAR PURPOSE.

Returns:

No merchandise will be accepted for return without prior authorization. Unauthorized returns will be refused and placed in the hands of the carrier at the expense of the shipper. To request a return authorization number please call the Atlas Sound warranty department at 800-876-3333.

Q: What is this 'Leveler' inside the MG2500?

The Leveler function, in the Gain Manager section of an MG2500, is an automatic gain control (AGC). This means that the Leveler automatically adjusts volume levels up or down to compensate for signals that are softer or louder than normal.

Q: What can this 'Leveler' do for me and my customer?

The two most common applications for the Leveler are to control music sources which have been recorded at different levels, and to control different levels of speech caused by the person(s) speaking and/or their varying distances from the microphones.

Example: A background music system utilizing a CD player as the primary source. Since CDs can be recorded at different levels, the volume from one CD to another can vary significantly. In the background music system it is desirable for the music to maintain a consistent level. A Limiter or Compressor could be employed, but they would only squash the dynamics, and diminish the quality of the music signal. A Leveler, on the other hand, actually controls the overall level of the signal, without adversely affecting the dynamics of the signal itself. Therefore, a Leveler can be used to provide a constant volume from the system, regardless of varying CD levels. This is also true for systems with a variety of music sources (i.e...cassette, tuner, etc.).

Q: How should I adjust this 'Leveler' to do what I want?

- 1) Using a typical input signal, adjust the source output and the MG2500 input for proper levels.
(The MG2500 software input meter should indicate occasional peaks into the yellow, but never to the red.)
- 2) Select the Gain Manager section of the MG2500 software.
- 3) Bypass all Gain Manager functions except the Leveler.
(This allows the Gain Reduction meter to be used for setup of the Leveler specifically.)
- 4) Adjust the Leveler 'threshold' so the Gain Reduction meter indicates the desired amount of gain reduction.
(The amount of gain reduction employed on 'normal' level signals equals the gain available for raising 'softer' level signals.)
(Example: Play a normal level CD. Adjust for 6dB of gain reduction. CDs with lower levels can be raised as much as 6dB.)
(Likewise, 'louder' signals will be lowered. The Leveler will attempt to bring softer or louder signals to the threshold level.)

NOTE: *The Gain Manager provides gain reduction even on input signals of nominal level. Therefore, all subsequent software meters will indicate the resultant lower level. This lower level can then be compensated for by increasing the input level on the next device in the system (i.e...power amplifier).*

CAUTION: *The Gain Manager can increase gain for lower level signals. Therefore, once all of the system settings have been adjusted, temporarily bypass the Gain Manager as a test of system feedback stability. If acoustic feedback occurs, reduce the system amplifier level or use the MG2500 parametric equalizer to eliminate feedback nodes, before re-enabling the Gain Manager.*

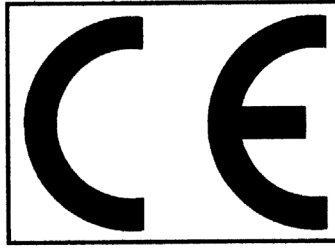

Declaration of Conformity

Atlas Sound, as the seller, hereby declares that the following described product, in our delivered version, complies with the provisions of the DIRECTIVES except as noted herein. In case of alteration of the product, not agreed upon or directed by us, this declaration is no longer valid.

Product Model: MG2500

Product Description: Noise Masking Processor

Applicable EC Directives: EMC Directive (89/336/EEC), LVD Directive (73/23/EEC)

Applicable Harmonized Standards: EN55103-1 emissions EN55103-2 immunity EN60065 safety

Special Considerations for Product Environment or Compliance:

Shielded cabling must be used for system connections. The apparatus is deemed incapable of producing harmonic emissions or flicker levels sufficient enough to interfere with other apparatus as noted in EN61000-3-2 and EN61000-3-3.

This apparatus operates from a removeable external power source at voltages below the levels encompassed by the LVD. The external power source complies with the applicable requirements of EN60065. The apparatus itself is outside of the scope of the LVD and presents no hazardous voltages, as defined in the LVD. For compliance, the apparatus shall be powered only from the separate CE marked power source supplied with the apparatus.

RF interference conducted through interconnect cabling may cause varying degrees of random signal degradation. The effect of increased noise or distortion due to this interference is typically masked by the desired signal. In no instance is operation inhibited.

The Technical Report/File is maintained at:

Atlas Sound
1601 Jack McKay BLVD
Ennis, TX
75119
(972) 975-8413

Authorized Representative: Bruce E. Marlin

Authorized Representative Signature:

A handwritten signature in black ink, appearing to read 'B. Marlin', written over a horizontal line.

Issued: April, 2002

SAFETY INFORMATION

The words **WARNING** and **CAUTION** throughout the manual, and on the device, call attention to important safety information. These words have the following meanings.

WARNING: The related information alerts you to conditions that could result in serious injury or damage to property if the instructions are not followed properly.

CAUTION: The related information instructs you on how to prevent damage to the equipment or how to avoid conditions that could result in minor injury if proper steps are not followed.

Product labelling and the operation manual may use the internationally recognized symbols defined below to note safety messages.



The lightning flash with arrowhead symbol, enclosed within a triangle, is intended to alert the user to the presence of uninsulated "dangerous voltage" within the apparatus's enclosure or at connection terminals that may be of sufficient magnitude to constitute a risk of electrical shock.



The exclamation point, enclosed within a triangle, is intended to alert the user to important installation, operation, and maintenance (servicing) instructions in the literature accompanying the apparatus.

WARNING: TO REDUCE THE RISK OF FIRE OR ELECTRICAL SHOCK, DO NOT EXPOSE THIS APPARATUS TO RAIN OR MOISTURE.

CAUTION: Installation of this apparatus should be made by a qualified installation person and should conform to all applicable local codes.



Modification and optional equipment information referenced in this manual is for use by qualified installation and service personnel only.



"INFORMACIÓN DE SEGURIDAD"

Las palabras **PELIGRO** (**WARNING**) y **PRECAUCIÓN** (**CAUTION**) a lo largo del manual y en el dispositivo (sistema), llaman la atención acerca de una importante información de seguridad. Estas palabras tienen los siguientes significados:

PELIGRO : la información relata las condiciones en que podría ser dañada seriamente la propiedad si no se siguen adecuadamente las instrucciones.

PRECAUCIÓN : la información que se relata le instruye en cómo prevenir daños al equipo o como evitar condiciones que podrían resultar en perjuicio menor si los pasos adecuados no son seguidos correctamente.

El etiquetado del producto y el manual de operación pueden hacer uso de los símbolos reconocidos internacionalmente y cuyos mensajes están definidos a continuación para modificar mensajes de seguridad:



El símbolo del rayo encerrado en un triángulo pretende alertar al usuario de la presencia de un peligroso voltaje no aislado, dentro de la caja del aparato o a un terminal de conexión y que podría ser de suficiente magnitud como para constituir un grave riesgo de descarga eléctrica.



El punto de exclamación dentro de un triángulo pretende alertar al usuario de la importancia de las instrucciones de instalación, operación y mantenimiento (servicio) que acompañan al aparato.

PELIGRO : para reducir el riesgo de fuego o una descarga eléctrica, no exponer este aparato a la lluvia o la humedad.

PRECAUCIÓN : la instalación de este aparato debería hacerse por una persona calificada en la instalación, y debería conformar todos los códigos locales aplicables.



La modificación y la información opcional del equipo referenciada en este manual es para ser utilizada únicamente por personal cualificado en instalación y servicio.



INFORMATION CONCERNANT VOTRE SECURITE

Les mots **WARNING** et **CAUTION** dans le manuel d'utilisation et sur les appareils attirent votre attention sur les plus importantes informations concernant votre sécurité. Ces mots ont la signification suivante:

WARNING: Ce mot vous indique les circonstances dans lesquelles vous pourriez être blessé ou endommager votre équipement si les instructions ne sont pas suivies correctement.

CAUTION: Ce mot vous indique comment éviter d'endommager votre matériel et comment éviter de vous blesser si vous ne suivez pas les instructions.

Vous trouverez peut-être les symboles suivants sur votre appareil ou dans le manuel d'utilisation.



L'éclair se terminant en flèche dans un triangle permet de prévenir l'utilisateur d'un voltage dangereux non isolé dans l'appareil ou d'une connexion d'une amplitude suffisante pour constituer un risque de choc électrique.



Le point d'exclamation dans un triangle permet de prévenir l'utilisateur des points importants concernant l'installation, le fonctionnement et l'entretien de l'appareil figurant dans le manuel d'utilisation.

WARNING: POUR REDUIRE LES RISQUES DE FEU OU DE CHOC ELECTRIQUE, NE PAS METTRE L'APPAREIL SOUS LA PLUIE OU DANS L'HUMIDITE.

CAUTION: L'installation de cet appareil doit être faite par un installateur qualifié et doit être en conformité avec toutes les lois locales en application.



Les informations concernant une modification ou un équipement en option dans le manuel doivent être effectués par du personnel qualifié.

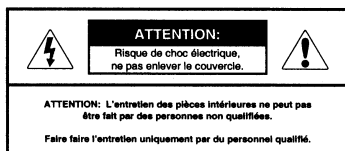

INFORMAZIONI PER LA SICUREZZA

Le parole **AVVERTENZA** (**WARNING**) e **PRUDENZA** (**CAUTION**) poste sul manuale d'uso e sul apparato richiamano la vostra attenzione su delle importanti informazioni per la vostra sicurezza. Queste parole hanno il seguente significato.

AVVERTENZA: La suddetta indicazione vi avvisa sul rischio di incorrere in danni a cose o a persone, se le procedure d'uso e installazione non saranno seguite propriamente.

PRUDENZA: La suddetta indicazione vi instruisce su come prevenire e ridurre al minimo, il rischio di danni agli apparati e alle persone se le istruzioni saranno seguite propriamente.

Le apparecchiature e i manuali di istruzioni riporteranno la simbologia standard raffigurata qui sotto, accompagnate dalle relative informazioni per la sicurezza.



La simbologia con il fulmine all'interno di un triangolo, intende avvisare l'utente della presenza di alto voltaggio all'interno del apparecchio in questione, e che il suddetto apparecchio si alimenta attraverso una tensione di rete ad alto voltaggio e che dunque si potrebbe incorrere sul rischio di una possibile scossa elettrica.



La simbologia con il punto esclamativo all'interno di un triangolo, intende avvisare l'utente di una serie di istruzioni contenute nel manuale d'uso riguardanti: operato, manutenzione e assistenza. Il suddetto manuale sarà a corredo dell'apparecchio.

AVVERTENZA: PER RIDURRE IL RISCHIO DI POSSIBILI INCENDI O SCOSSE ELETTRICHE, SCONSIGLIAMO DI ESPORRE L'APPARECCHIO ALLA PIOGGIA O ALL'UMIDITA'.

PRUDENZA: L'installazione di questo apparato dovrà essere effettuata solo da personale qualificato e il tipo di installazione dovrà essere in regola con le norme vigenti locali.



Modifiche e ulteriori informazioni specificate in questo manuale sono solamente riservate al personale qualificato all'installazione.

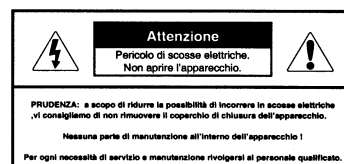

Sicherheitshinweise

Die Begriffe **WARNUNG** (engl. WARNING) und **ACHTUNG** (engl. CAUTION) in der Bedienungsanleitung und auf den Geräten machen auf wichtige Sicherheitsinformationen aufmerksam. Diese Begriffe haben die folgende Bedeutung:

WARNUNG: Der folgende Text warnt Sie vor ernsthaften Verletzungen oder Beschädigungen, (WARNING) die aus einer fehlerhaften Bedienung bzw. Handhabung des Gerätes resultieren können.

ACHTUNG: Der folgende Text informiert Sie über Bedienungshinweise zum Schutz Ihres Gerätes oder weist auf mögliche Schäden hin, wenn die Bedienungshinweise nicht beachtet werden.

Die Beschriftung der Geräte und die Bedienungsanleitungen weisen unter Umständen international bekannte Symbole auf, die die folgende Bedeutung haben:



Das Blitzsymbol im Dreieck warnt vor anliegender, nicht isolierter „gefährlicher Spannung“ im Inneren oder an den Anschlüssen des Gerätes. Die Berührung der unter Spannung stehenden Teile kann zu einem elektrischen Schock führen.



Das Rufzeichen im Dreieck macht auf wichtige Installations-, Bedienungs- und Servicehinweise in der zugehörigen Bedienungsanleitung aufmerksam.

WARNUNG: Zur Minderung des Risikos von Feuer und elektrischem Schock schützen Sie das Gerät vor Regen und Feuchtigkeit.

ACHTUNG: Die Installation des Gerätes sollte nur durch qualifiziertes Personal durchgeführt werden und muß den jeweiligen Bestimmungen entsprechen.



Die Modifikationen und die Informationen zu den optionalen Erweiterungen in der Bedienungsanleitung sind nur für qualifiziertes Personal bestimmt.

	ACHTUNG Risiko von elektrischem Schock Gerät nicht öffnen	
Achtung: Zur Minderung des Risikos von elektrischem Schock das Gerät nicht öffnen		
Keine Bedienungselemente im Inneren des Gerätes		
Service nur durch qualifiziertes Personal durchführen lassen		

Sikkerhedsinformation

Ordene **ADVARSEL** (WARNING) og **FORSIGTIG** (CAUTION), brugt i henholdsvis brugervejledning og på selve produktet, indikerer, at vigtig information omkring sikkerhed følger. Ordene betyder følgende:

ADVARSEL: Den efterfølgende information advarer Dem om forhold, der kan føre til alvorlige ulykker og ejendomsskader, hvis ikke vejledningen følges.

FORSIGTIG: Den efterfølgende information vejleder Dem i, hvordan De undgår skade på produktet, samt undgår forhold der kan føre til mindre ulykker og ejendomsskader, hvis ikke vejledningen følges.

Produktetiketter og brugervejledning kan indeholde de internationalt anerkendte symboler der er vist nedenfor:



Trekanten med et lyn i midten har til hensigt at advare brugeren om, at produktet indeholder "farlig spænding", og at det derfor er forbundet med fare for elektrisk stød at åbne produktet.



Trekanten med udråbstegn har til hensigt at advare brugeren om, at vigtig information omkring installation, brug, service og vedligeholdelse af produktet er indeholdt i den medfølgende brugervejledning.

ADVARSEL: Med henblik på at reducere risikoen for brand eller elektrisk stød, må produktet ikke udsættes for regn eller fugt.

FORSIGTIG: Installation af dette produkt foretages af en autoriseret installatør og skal være i overensstemmelse med alle anvendelige lokale retningslinier.



Modifikationer samt alternativt udstyr beskrevet i denne brugervejledning er kun henvendt til kvalificerede installatører og servicepersonale.

	FORSIGTIG Fare for elektrisk stød - må ikke åbnes.	
FORSIGTIG: Med henblik på at reducere risikoen for elektrisk stød, må svæbet ikke fjernes.		
Indeholder ingen komponenter relevante for brugeren.		
Anvend autoriseret servicepersonale ved alle servicetilfælde.		

VEILIGHEIDSINFORMATIE

De woorden **WAARSCHUWING** (WARNING) en **VOORZICHTIG** (CAUTION) welke in de handleiding en op het apparaat voorkomen, waarschuwen U voor belangrijke veiligheidsinformatie. Zij hebben de volgende betekenis:

WAARSCHUWING: De betreffende informatie waarschuwt U voor omstandigheden die kunnen leiden tot defecten of beschadigingen aan apparaten als de instructies niet volledig worden opgevolgd.

VOORZICHTIG: De betreffende informatie instrueert U hoe U defecten aan apparatuur kunt voorkomen of hoe U omstandigheden kunt vermijden die kunnen resulteren in schade als de juiste stappen niet worden opgevolgd.

Produkt informatie en handleiding hanteren onderstaande internationaal erkende symbolen om veiligheidsinstructies aan te geven.



De bliksemschicht in een driehoek wordt gebruikt om de gebruiker te attenderen op ongeïsoleerde "gevaarlijke spanning" in het apparaat of bij de aansluitklemmen, die het risico van een elektrische schok kunnen geven.



Het uitroepteken in een driehoek wordt gebruikt om de gebruiker te attenderen op belangrijke installatie, gebruiks- en onderhoudsinstructies in de beschrijving die bij het apparaat hoort.

WAARSCHUWING: OM HET RISICO VAN BRAND OF EEN ELECTRICISCHE SCHOK TE VERMIJDEN DIENT U HET APPARAAT NIET AAN VOCHT BLOOT TE STELLEN.

VOORZICHTIG: Installatie van dit apparaat dient te geschieden door gekwalificeerd personeel en dient te geschieden conform de plaatselijke voorschriften.



Modificaties en aanvullende informatie waar in de handleiding naar wordt verwezen, dient alleen voor gebruik door gekwalificeerd personeel.

	VOORZICHTIG. Risiko van elektrische schok. Niet openen.	
Waarschuwing: Om het risico van een elektrische schok te verminderen het apparaat niet openen.		
Er zijn geen, door gebruiker, vervangbare onderdelen in dit apparaat.		
Service overlaten aan gekwalificeerd service personeel.		

TURVALLISUUSTIEDOTE

Sanat **VAROITUS** (WARNING) ja **HUOMIO** (CAUTION), jotka esiintyvät manuaalissa ja itse laitteessa, ilmoittavat tärkeästä turvallisuusinformaatiosta. Näillä sanoilla on seuraava merkitys:

VAROITUS: Yhteydessä oleva informaatio varoittaa olosuhteista, jotka saattavat johtaa vakaviin vammoihin tai laitteen vaurioitumiseen, mikäli ohjeita ei täysin noudateta.

HUOMIO: Yhteydessä oleva informaatio neuvoo, miten laitteen vaurioituminen voidaan ehkäistä tai miten voidaan välttää olosuhteet, jotka voivat johtaa lieviin vammoihin, mikäli ohjeita ei noudateta.

Tuotteessa tai käyttöohjeessa voidaan käyttää seuraavia alla määriteltyjä kansainvälisiä symboleja, jotka viittaavat turvallisuusinformaatioon.



Kolmion sisällä olevan nuolipäinen salama varoittaa käyttäjää laitteen sisällä tai liitännöissä olevasta eristämättömästä vaarallisesta jännitteestä, joka saattaa olla tarpeeksi suuri aiheuttaakseen sähköiskun vaaran.



Kolmion sisällä oleva huutomerkki tarkoituksena on ilmoittaa käyttäjälle tärkeistä asennusta, käyttöä tai huoltoa koskevista ohjeista laitteen mukana seuraavassa kirjallisuudessa.

VAROITUS: ÄLÄ ALTISTA LAITETTA SATEELLE TAI KOSTEUELLE TULIPALON JA SÄHKÖISKUN VAARAN VUOKSI.

HUOMIO: Laitteen asentaminen tulisi jättää ammattitaitoisen henkilön suoritettavaksi ja asennuksessa tulee noudattaa kaikkia paikallisia säännöksiä.



Tässä manuaalissa oleva informaatio, joka koskee muutostöitä ja lisälaitteita, on tarkoitettu vain ammattilaisien asennus- ja huoltohenkilöiden käyttöön.

	HUOMIO Sähköiskun vaara, älä avaa.	
HUOMIO: ÄLÄ AVAA KANTTA SÄHKÖISKUN VAARAN VUOKSI		
EI SISÄLLÄ KÄYTTÄJÄN HUOLLETTAVIA OSIA		
JÄTÄ HUOLTO AMMATTITAITOISELLE HENKILÖKUNNALLE		

SIKKERHETS INFORMASJON

Når ordene **ADVARSEL** (WARNING) og **VIKTIG** (CAUTION) blir brukt i manualen og på produktet, gjelder det informasjon som har med brukersikkerhet å gjøre. Ordene har følgende mening:

ADVARSEL: Tilhørende informasjon viser til forhold som kan resultere i alvorlige skader eller ødeleggelser hvis anvisningene ikke følges nøye.

VIKTIG: Tilhørende informasjon forteller deg hvordan du skal unngå feil på utstyret, eller unngå situasjoner som kan resultere i mindre skader.

Produkt merkingen og bruksanvisningen bruker internasjonale symboler for å merke punkter som er viktige for brukersikkerhet.



Lynet i en triangel advarer brukeren om uisolert "farlig spenning" inne i apparatet, eller tilkoblings terminaler som kan gi støt.



Etter utropsteget i en triangel følger informasjon som er viktig når det gjelder installasjon, bruk og vedlikehold (service) av apparatet.

ADVARSEL: FOR Å REDUSERE FAREN FOR BRANN ELLER STØT MÅ APPARATET IKKE UTSETTES FOR VANN ELLER FUKTIGHET.

VIKTIG: Installasjon av apparatet skal foretas av autorisert installatør etter gjeldende forskrifter.



Modifikasjoner og tilleggs informasjon som følger er kun for kvalifiserte installatører eller service personell.

	VIKTIG FARE FOR STØT, MÅ IKKE DEMONTERES.	
VIKTIG: For å unngå faren for støt, må ingen deksler fjernes Ingen interne deler skal justeres eller repareres av bruker. Overlat service til autorisert personell.		

SÄKERHETS INFORMATION

Orden **VARNING** (WARNING) och **OBSERVERA** (CAUTION) vilka används i denna manual och på apparaten, är menade att uppmärksamma viktig säkerhets information. Dessa ord har följande betydelse.

VARNING: Information som uppmärksammar på omständigheter som kan resultera i allvarig personskada eller skada på egendom om instruktionerna ej följs.

OBSERVERA: Information som uppmärksammar på instruktioner om hur skada på utrustning eller hur situationer där lättare personskador kan uppstå undviks.

Följande internationellt använda ord och symboler används i handboken och på märkningar på produkten för att uppmärksamma användare på viktiga säkerhets instruktioner.



En blixn med pil, innesluten i en triangel, menad att uppmärksamma användare på närvaron av isolerade "farliga spänningar" i apparaten eller på anslutnings kontakter vilka har tillräcklig styrka för att medföra risk för elektrisk stöt.



Ett utropstecken, innesluten i en triangel, menad att uppmärksamma användare på viktiga installations, handhavande eller underhålls-instruktioner i medföljande dokumentation.

VARNING: FÖR ATT MINSKA RISKEN FÖR BRAND ELLER ELEKTRISK STÖT, UTSÄTT EJ APPARATEN FÖR FUKT ELLER VÄTSKA.

OBSERVERA: Installation av denna apparat skall utföras av kvalificerad installatör samt enligt alla gällande lokala bestämmelser.



Eventuella modifierings instruktioner och annan information av teknisk art i denna manual är endast avsedd att användas av kvalificerad installations och service personal.

	OBSERVERA RISK FÖR ELEKTRISK STÖT FÄR EJ ÖPPNAS	
OBSERVERA: FÖR ATT MINSKA RISKEN FÖR ELEKTRISK STÖT, AVLÅGSNA EJ LOCKET. INGA AV ANVÄNDARE UTBYTBARA ELLER REPARERBARA KOMPONENTER INUTI DENNA APPARAT. ALL SERVICE PÅ DENNA APPARAT SKALL UTFÖRAS AV KVALIFICERAD PERSONAL		

ΠΛΗΡΟΦΟΡΙΕΣ ΑΣΦΑΛΕΙΑΣ

Οι λέξεις **ΚΙΝΔΥΝΟΣ** (WARNING) και **ΠΡΟΣΟΧΗ** (CAUTION) που αναφέρονται μέσα στο εγχειρίδιο και στη συσκευή, επικεντρώνουν την προσοχή σε σημαντικές πληροφορίες ασφαλείας. Οι λέξεις αυτές έχουν την παρακάτω σημασία.

ΚΙΝΔΥΝΟΣ: Η αναγραφόμενη πληροφορία επιστά την προσοχή σας σε καταστάσεις που θα μπορούσαν να έχουν σαν αποτέλεσμα σοβαρό τραυματισμό ή καταστροφής της ιδιοκτησίας αν οι οδηγίες δεν ακολουθηθούν κατάλληλα.

ΠΡΟΣΟΧΗ: Η αναγραφόμενη πληροφορία σας καθοδηγεί πώς να προλάβετε καταστροφή του εξοπλισμού ή πώς να αποφύγετε καταστάσεις που θα μπορούσαν να έχουν ως αποτέλεσμα μικροτραυματισμούς αν δεν ακολουθηθούν τα σωστά βήματα.

Στις επιγραφές των προϊόντων και στο εγχειρίδιο λειτουργίας, χρησιμοποιούνται τα συμβολικά αναγνωρισμένα σύμβολα, των οποίων ο ορισμός δίνεται παρακάτω έτσι ώστε να υπογραμμιστούν τα μηνύματα ασφαλείας.



Η φωτεινή αναλαμπή με σύμβολο το βέλος, μέσα στο τρίγωνο, έχει σκοπό να επιστήσει την προσοχή του χρήστη, στην ύπαρξη μη μονομηνής « επικίνδυνης ισχύος ρεύματος » στο εσωτερικό της συσκευής ή στις άκρες σύνδεσης οι οποίες μπορεί να έχουν αρκετό μέγεθος ώστε να περιέχουν κίνδυνο ηλεκτροπληξίας.



Το επεξηγηματικό σημείο, μέσα στο τρίγωνο, έχει σκοπό να επιστήσει την προσοχή του χρήστη στις σημαντικές οδηγίες εγκατάστασης, λειτουργίας και συντήρησης (service) που περιέχονται στα φυλλάδια που συνοδεύουν την συσκευή.

ΚΙΝΔΥΝΟΣ: Για να αποφύγετε τον κίνδυνο φωτιάς ή ηλεκτροπληξίας, μην εκθέτετε αυτή τη συσκευή σε βροχή ή σε υγρασία.

ΠΡΟΣΟΧΗ: Η εγκατάσταση αυτής της συσκευής θα πρέπει να γίνει από εξειδικευμένο άτομο και θα πρέπει να προσαρμόζεται σε όλους τους εφαρμοσμένους τοπικούς κώδικες.



Οι τροποποιήσεις και οι προληπτικές πληροφορίες για τον εξοπλισμό, που αναφέρονται σε αυτό το εγχειρίδιο, προορίζονται για χρήση μόνο από εξειδικευμένα στην εγκατάσταση και στο service, άτομα.

	ΠΡΟΣΟΧΗ ΚΙΝΔΥΝΟΣ ΗΛΕΚΤΡΟΠΛΗΞΙΑΣ. ΜΗΝ ΑΝΟΙΓΕΤΕ.	
ΠΡΟΣΟΧΗ : ΓΙΑ ΝΑ ΜΕΙΩΣΕΤΕ ΤΟΝ ΚΙΝΔΥΝΟ ΗΛΕΚΤΡΟΠΛΗΞΙΑΣ, ΜΗΝ ΜΕΤΑΚΙΝΗΣΕΤΕ ΤΟ ΚΑΛΥΜΜΑ. ΔΕΝ ΠΑΡΕΧΟΝΤΑΙ ΑΝΤΑΛΛΑΚΤΙΚΑ SERVICE ΣΤΟΝ ΧΡΗΣΤΗ ΓΙΑ SERVICE ΑΝΑΦΕΡΕΤΕ ΣΤΟ ΕΞΟΥΣΙΟΘΗΤΗΜΟ ΠΡΟΣΩΠΙΚΟ SERVICE.		

INFORMAÇÃO SOBRE SEGURANÇA

As palavras **ADVERTÊNCIA** (WARNING) e **PRECAUÇÃO** (CAUTION) neste manual, e no dispositivo, alertam para importantes informações sobre segurança. Estas palavras significam o seguinte:

ADVERTÊNCIA: Informação relacionada que alerta sobre condições que poderão resultar em lesões sérias ou prejuízo, se as instruções não forem seguidas adequadamente.

PRECAUÇÃO: Informação relacionada que instrui como prevenir danos no equipamento ou como evitar condições que poderão resultar em lesões leves, se os passos não forem seguidos adequadamente.

As etiquetas do produto e do manual de operações podem usar os símbolos internacionalmente reconhecidos definidos abaixo para advertir mensagens de segurança.



símbolo do relâmpago com uma seta, dentro de um triângulo, tem o fim de alertar o usuário a presença de "voltagem perigosa" sem isolamento dentro da caixa isolamento do aparelho ou nos terminais de ligação que podem ter a magnitude suficiente que constitui um risco de choque elétrico.



ponto de exclamação, dentro de um triângulo, tem o fim de alertar o usuário sobre instruções importantes de instalação, operação e manutenção (serviços) na literatura que acompanha o aparelho.

ADVERTÊNCIA: PARA REDUZIR O RISCO DE INCÊNDIO OU CHOQUE ELÉCTRICO, NÃO EXPONHA ESTE APARELHO A CHUVA OU HUMIDADE.

PRECAUÇÃO: A instalação deste aparelho deve ser feita por um profissional qualificado e deve obedecer a todos os códigos locais aplicáveis.



Modificação e informação sobre equipamento adicional citados neste manual são para o uso exclusivo do pessoal qualificado de instalação e manutenção.

	PRECAUÇÃO RISCO DE CHOQUE ELÉCTRICO NÃO ABRA.	
PRECAUÇÃO: PARA REDUZIR O RISCO DE CHOQUE ELÉCTRICO, NÃO REMOVA A TAMPA. PARTES INTERNAS NÃO MANTIDAS PELO USUÁRIO. ENCAMINHE A MANUTENÇÃO PARA PESSOAL DE SERVIÇOS QUALIFICADO.		

Free Manuals Download Website

<http://myh66.com>

<http://usermanuals.us>

<http://www.somanuals.com>

<http://www.4manuals.cc>

<http://www.manual-lib.com>

<http://www.404manual.com>

<http://www.luxmanual.com>

<http://aubethermostatmanual.com>

Golf course search by state

<http://golfingnear.com>

Email search by domain

<http://emailbydomain.com>

Auto manuals search

<http://auto.somanuals.com>

TV manuals search

<http://tv.somanuals.com>