



STRATEGY SERIES™

4" FULL-RANGE SYSTEM LOUDSPEAKERS

FA114 Series

ONE

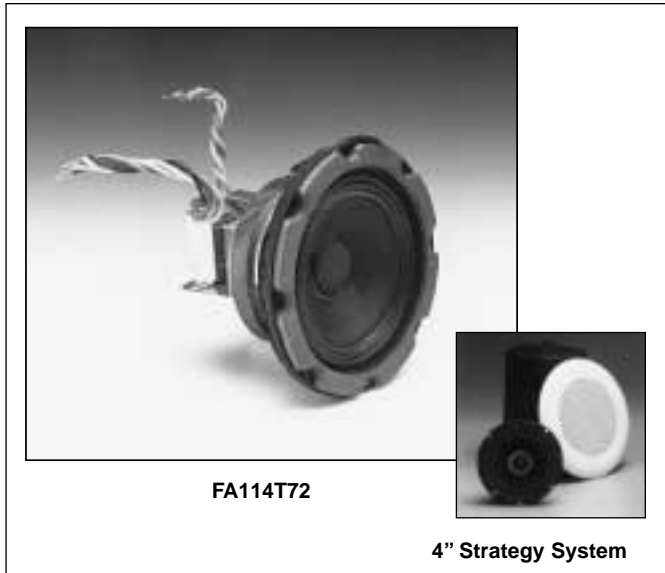

SPECIFICATIONS

- Size:** 4" (127mm)
- *Power Handling:** 10 Watts RMS
- *Sensitivity:** 94dB Peak, 89.6dB Average
- Impedance:** 8 Ohms Nominal, 6.8 Ohms Minimum
- *Frequency Response:** 150 Hz-17 kHz Nominal, 170 Hz-12.5kHz ± 5dB
- *Dispersion:** 135° (2 kHz Octave Band, -6dB Points)
- Diameter & Depth:** 5" (127mm) Dia. & 2.25" (57mm) Deep
- Mounting Dimensions:** 4.69" (119mm) Bolt Circle
- Cone Material:** Treated Paper
- Surround Material & Damping:** Damped Cloth Surround
- Flux Density:** 11,500 Gauss, 1.15 Tesla
- Magnet Weight:** Nominal, 10 oz. (260ml)
- Basket Material:** Painted Stamped 20 ga. CRS
- VC Diameter:** 1" (25mm)
- VC Material:** Copper
- VC Former Material:** Black Anodized Aluminum, Vented
- VC Winding Width:** .190"
- Top Plate Thickness:** .180"
- Weight:** 27 oz. (772g)

(*Measured in FA97-4 Enclosure)

THIELE-SMALL PARAMETERS

- | | | |
|------------------------------|------------------------------------|-----------------------------------|
| Pe: 10 watts | Qes: .62 | Sd: 8.9 (in ²) |
| Fs: 130 Hz | Qms: 3.5 | Le@1kHz: .14 mH |
| Xmax: .05" | BL: 5.3 N/A | Mms: .14 oz. |
| Resistance: 6.25 ohms | Efficiency: .59% | Cms: .06 in./lb. |
| Qts: .54 | Vas: .06 (ft ³) | |

FEATURES

- Economical, UL Listed, 4" General Purpose Loudspeaker Offers Efficient Wide-Range Frequency Response
- Patented, Easy-to-Install Loudspeaker Mounting System
- Wide-Angle Dispersion for Excellent Sound Coverage in Rooms with Low Ceilings
- Front Loads into Acoustically-Matched System Enclosures, Plaster, or Trim Ring
- Offers Choice of System Components Including: Transformers, Acoustic Enclosures, Tile Bridge, Plaster Ring, Trim Ring and Hardware-Free Grilles

APPLICATIONS

Strategy Series FA114 loudspeakers offer full-range performance, wide dispersion and easy installation. When integrated with Strategy Series hardware the patented loudspeaker system (U.S. Patent #5206464) provides clear sound reproduction in an economical, attractive and easy-to-install system. FA114 loudspeakers are ideal for voice transmission, music and signal reproduction in all types of commercial, industrial and institutional applications.

GENERAL DESCRIPTION

The general purpose Model FA114, 4" (127mm) loudspeaker is UL listed and handles 10-watts with quality, low-frequency reproduction and smooth extended response. The unit's 135° dispersion angle effectively reduces the number of loudspeakers necessary to achieve total coverage in low-level distribution systems.

For optimum application versatility, Model FA114 has been engineered as a system with matched enclosures, choice of transformer and selection of attractive grilles. Strategy Series offers both the FA97-4 Series high performance enclosures (.10ft³) with acoustic batting as well as the economy FA95-4 Series (.08ft³) backbox enclosures. Both install quickly and easily into the ceiling using only a screwdriver to adjust the clamping dogs, or to tighten conventional screws.

Loudspeakers front-load into the enclosure and include a sealing gasket on the back return of the speaker basket which seals the assembly. Loudspeakers may also be wall or ceiling mounted into areas with minimum depth by using plaster ring Model FAPR-4 instead of an enclosure.

Baffle selection includes a choice of four attractive grilles which are equipped with three serrated studs for hardware-free, push-on installation to Strategy Series enclosures. For detailed information on enclosures, grilles, hardware and other system accessories, please refer to SL1-1533.

MODEL	INCLUDES XFMR			MOUNTS★ ENCLOSURE	MOUNTS★ GRILLE	OPTIONAL ACCESSORIES
	MODEL	VOLTS	PRIMARY TAPS			
★ FA114	—	—	—	FA97-4(NK)* FA95-4(NK)* (*Without Knockouts)	FA51-4 (7 7/8" Dia. Round) FA170-4 (9 3/4" Square) FA720-4 (7 7/8" Dia. Round) FA730-4 (7 7/8" Dia. Round)	FA81-4 (Tile Bridge) FAPR-4 (Plaster Ring) FA-TR4 (Trim Ring)
★ FA114T72	LT-72	25/70.7	.5, 1, 2 & 4			
★ FA114T100	LT100	100	.5, 1, 2 & 5			

★ US General signaling (1480 non-fire) includes all speaker/transformer combinations when used with an Atlas Sound UL listed enclosure and baffle.

Specifications subject to change without notice



1601 JACK MCKAY BLVD. / ENNIS, TEXAS 75119 U.S.A. / TELEPHONE: (800) 876-3333 / FAX (800) 765-3435

ARCHITECT AND ENGINEER SPECIFICATIONS

Loudspeaker system shall be Atlas Sound Strategy Series™. It shall be UL listed and include a high-compliance, 4" loudspeaker Model FA114, matched enclosure Model ____ (FA97-4, FA97-4NK, FA95-4, FA95-4NK) and flush grille Model ____ (FA51-4, FA170-4, FA720-4, FA730-4). Strategy Series loudspeaker, enclosures and grilles shall be listed by Underwriters Laboratories (UL 1480 General Signaling) to U.S. and Canadian safety standards. Nominal frequency response of the system shall be 150 Hz to 17 kHz with a sensitivity of 94dB(peak) measured at 1W / 1M across the full bandwidth. Power rating shall be 10 watts. Unit shall be comprised of a 4" dia. low frequency driver.

Magnet shall be a minimum of 10 oz. and the voice coil diameter shall be 1" (25mm). Dispersion shall be 135° measured at -6dB, 2kHz Octave Band. Transformer-equipped models shall include factory wired ____ (25 / 70.7, or 100) volt transformer with primary taps of ____ (.5, 1, 2, 4 or .5, 1, 2 & 5). Loudspeaker shall front-load to specified enclosure model FA97-4(NK) or FA95-4(NK), or Model FAPR-4 plaster ring. Strategy Series enclosures shall use clamping dogs for ceiling mounting and stud receivers for grille mounting. The FA97 enclosure models shall be lined with high density acoustic batting.

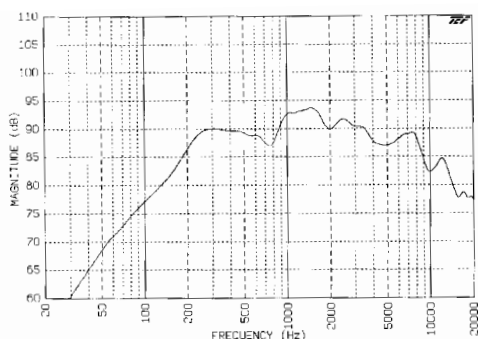

FA114 : Frequency Response (Measured in FA97-4 Enclosure)

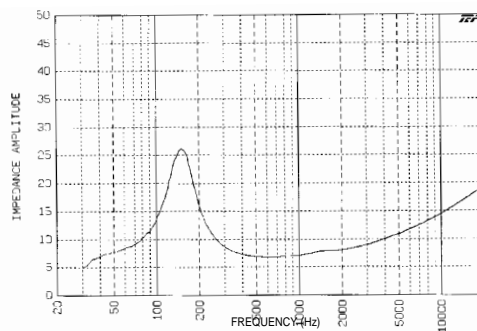

FA114: Impedance

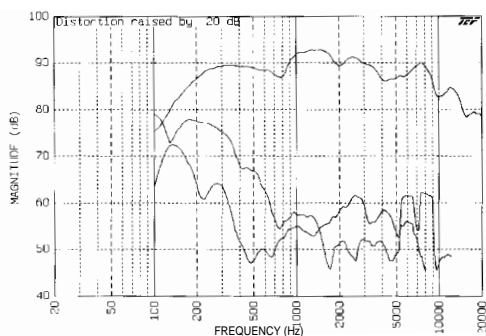

FA114 : Fundamental vs 2nd & 3rd Harmonics (Raised 20dB)@ 1 watt (Measured in FA97-4 Enclosure)

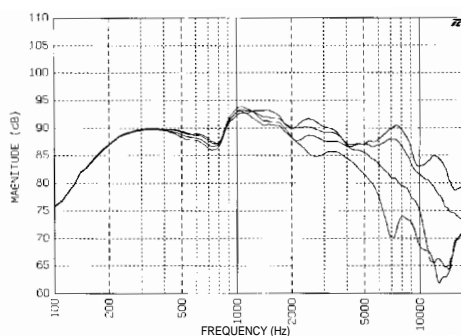

FA114: Frequency Response Overlay at 0, 15, 30 & 45 degrees (Measured in FA97-4 Enclosure)

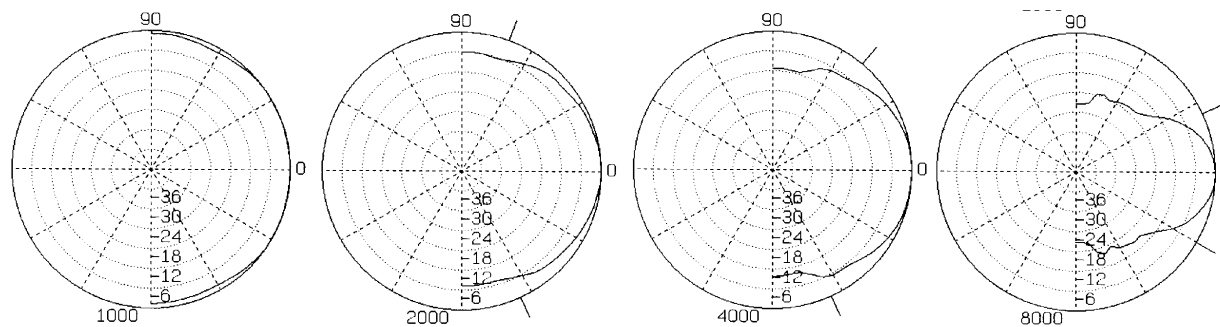

Octave Bands Normalized to Zero On Axis (Measured in FA97-4 Enclosure)

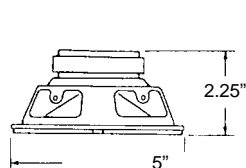

FA114T72
FA114T100

Dim. A
3.875"
3.875"

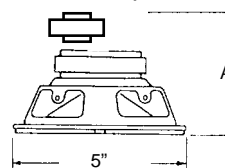

Specifications subject to change without notice



1601 JACK MCKAY BLVD. / ENNIS, TEXAS 75119 U.S.A. / TELEPHONE: (800) 876-3333 / FAX (800) 765-3435

Free Manuals Download Website

<http://myh66.com>

<http://usermanuals.us>

<http://www.somanuals.com>

<http://www.4manuals.cc>

<http://www.manual-lib.com>

<http://www.404manual.com>

<http://www.luxmanual.com>

<http://aubethermostatmanual.com>

Golf course search by state

<http://golfingnear.com>

Email search by domain

<http://emailbydomain.com>

Auto manuals search

<http://auto.somanuals.com>

TV manuals search

<http://tv.somanuals.com>