

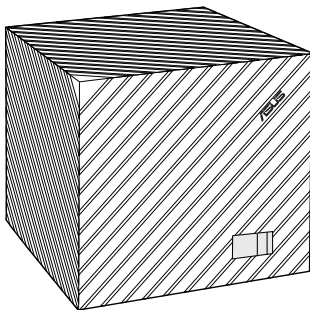

ASUS CUBE WITH GOOGLE TV MEDIA STREAMER



User Manual

Copyright © 2013 ASUSTeK COMPUTER INC. All Rights Reserved.

No part of this manual, including the products and software described in it, may be reproduced, transmitted, transcribed, stored in a retrieval system, or translated into any language in any form or by any means, except documentation kept by the purchaser for backup purposes, without the express written permission of ASUSTeK COMPUTER INC. ("ASUS").

Product warranty or service will not be extended if: (1) the product is repaired, modified or altered, unless such repair, modification or alteration is authorized in writing by ASUS; or (2) the serial number of the product is defaced or missing.

ASUS PROVIDES THIS MANUAL "AS IS" WITHOUT WARRANTY OF ANY KIND, EITHER EXPRESS OR IMPLIED, INCLUDING BUT NOT LIMITED TO THE IMPLIED WARRANTIES OR CONDITIONS OF MERCHANTABILITY OR FITNESS FOR A PARTICULAR PURPOSE. IN NO EVENT SHALL ASUS, ITS DIRECTORS, OFFICERS, EMPLOYEES OR AGENTS BE LIABLE FOR ANY INDIRECT, SPECIAL, INCIDENTAL, OR CONSEQUENTIAL DAMAGES (INCLUDING DAMAGES FOR LOSS OF PROFITS, LOSS OF BUSINESS, LOSS OF USE OR DATA, INTERRUPTION OF BUSINESS AND THE LIKE), EVEN IF ASUS HAS BEEN ADVISED OF THE POSSIBILITY OF SUCH DAMAGES ARISING FROM ANY DEFECT OR ERROR IN THIS MANUAL OR PRODUCT.

SPECIFICATIONS AND INFORMATION CONTAINED IN THIS MANUAL ARE FURNISHED FOR INFORMATIONAL USE ONLY, AND ARE SUBJECT TO CHANGE AT ANY TIME WITHOUT NOTICE, AND SHOULD NOT BE CONSTRUED AS A COMMITMENT BY ASUS. ASUS ASSUMES NO RESPONSIBILITY OR LIABILITY FOR ANY ERRORS OR INACCURACIES THAT MAY APPEAR IN THIS MANUAL, INCLUDING THE PRODUCTS AND SOFTWARE DESCRIBED IN IT.

Products and corporate names appearing in this manual may or may not be registered trademarks or copyrights of their respective companies, and are used only for identification or explanation and to the owners' benefit, without intent to infringe.

Contents

Safety information	7
Important Safety Instructions.....	7
About this user guide.....	9
How this user guide is organized	9
Typography	9
Conventions used in this manual	10

Chapter 1: Getting started

Package contents.....	11
Specifications summary.....	12
Getting to know your ASUS CUBE with Google TV	13
System requirements	13
ASUS CUBE with Google TV	13
Front view	13
Rear view	14
Right-side view.....	16
Remote control	17
Front view	17
Back and side views.....	19

Contents

Getting your ASUS CUBE with Google TV ready	20
Connecting the power adapter.....	20
Connecting devices to your ASUS CUBE with Google TV.....	21
Pairing your remote control with your ASUS CUBE with Google TV	22
Pairing your ASUS CUBE with Google TV with Bluetooth devices.....	23
Chapter 2: Using your ASUS CUBE with Google TV	
Using your ASUS CUBE with Google TV for the first time.....	24
Using the touchpad	25
Navigating the cube user interface.....	25
Home screen	26
Customizing home apps.....	26
Customizing home widgets	27
Play Store	28
Using downloaded files.....	29
Google Chrome.....	30
Browser windows	30
Browser history	31
Incognito Mode Browser	32
Bookmarking your favorite websites	32

Contents

Google Chrome security settings	33
Picture-in-Picture	34
Internet settings	34
Mobile Remote	35
Media Manager	36
AutoPlay	36
Watching Live TV	37
Music Player and Photo Gallery	37
ASUS WebStorage	38
Whiteboard	39
Task Killer	41

Chapter 3: Troubleshooting

Troubleshooting	42
Remote Control	42
Display	43
Audio.....	46
USB storage device	46
Google TV software updates	47

Contents

Wired LAN, Wi-Fi, and Internet connections.....	48
Operation/function failure.....	51
IR Blaster	51

Appendices

Notices.....	52
Supported Media Formats.....	63
ASUS contact information	64

Safety information

Important Safety Instructions

1. Read these instructions.
2. Keep these instructions.
3. Heed all warnings.
4. Follow all instructions.
5. Do not use this apparatus near water.
6. Clean only with dry cloth.
7. Do not block any ventilation openings. Install in accordance with the manufacturer's instructions.
8. Do not install near any heat sources such as radiators, heat registers, stoves, or other apparatus (including amplifiers) that produce heat.
9. Do not defeat the safety purpose of the polarized or grounding-type plug. A polarized plug has two blades with one wider than the other. A grounding type plug has two blades and a third grounding prong. The wide blade or the third prong are provided for your safety. If the provided plug does not fit into your outlet, consult an electrician for replacement of the obsolete outlet.

10. Protect the power cord from being walked on or pinched particularly at plugs, convenience receptacles, and the point where they exit from the apparatus.
11. Only use attachments/accessories specified by the manufacturer.
12. Use only with the cart, stand, tripod, bracket, or table specified by the manufacturer, or sold with the apparatus. When a cart is used, use caution when moving the cart/apparatus combination to avoid injury from tip-over.
13. Unplug this apparatus during lightning storms or when unused for long periods of time.
14. Refer all servicing to qualified service personnel. Servicing is required when the apparatus has been damaged in any way, such as power-supply cord or plug is damaged, liquid has been spilled or objects have fallen into the apparatus, the apparatus has been exposed to rain or moisture, does not operate normally, or has been dropped.
15. Apparatus shall not be exposed to dripping or splashing and no objects filled with liquids such as vases, shall be placed on the apparatus.



About this user guide

How this user guide is organized

- **Chapter 1: Getting started**
Provides the basic information about your ASUS CUBE WITH GOOGLE TV.
- **Chapter 2: Using your ASUS CUBE**
Provides information about using your ASUS CUBE WITH GOOGLE TV.
- **Chapter 3: Troubleshooting**
Provides solutions to frequently-asked questions about your ASUS CUBE WITH GOOGLE TV.

Typography

- Bold** This indicates a menu or an item that must be selected.
- Bold Italic*** This indicates sections that you can refer to in this manual.

Conventions used in this manual

To highlight key information in this manual, some text are presented as follows:







IMPORTANT! This message contains vital information that must be followed to complete a task.

NOTE: This message contains additional information and tips that can help complete tasks.

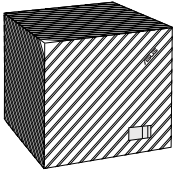
WARNING! This message contains important information that must be followed to keep you safe while performing tasks and prevent damage to your ASUS CUBE with Google TV's data and components.

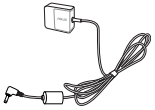
Chapter 1: Getting started

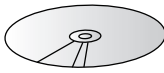
Package contents

		
ASUS CUBE WITH GOOGLE TV	Remote control with two AAA batteries	IR Blaster cable
		
Power adapter (24W)	Power plug	Support CD (User Manual/utilities)
		
		Quick Start Guide

NOTE: Contact your retailer if any of these items are damaged or missing.

Specifications summary

Bluetooth	Bluetooth 3.0 + High Speed (HS) also compliant with Bluetooth 2.1 + Enhanced Data Rate (EDR)
Wireless standard	Wi-Fi 802.11b/g/n
I/O ports	Power (DC-In) port x 1
	USB 2.0 ports x 2
	10/100 Base-T Ethernet port x 1
	HDMI Out port x 1
	HDMI In port x 1
	IR Blaster Out port (Remote signal amplifier Output port)
Dimension	125 x 125 x 125 mm (WxDxH)
Weight	520 g
Power input rating	12V DC, 2A
Power consumption	10W
Operating temperature	5°C (41°F) ~ 40°C (104°F)

NOTES:

- Specifications are subject to change without notice.
 - For supported video/music/photo format, please visit http://developers.google.com/tv/android/docs/gtv_media_formats
-

Getting to know your ASUS CUBE with Google TV

System requirements

- High-definition TV (HDTV) or HDMI monitor
- Internet connection (Wired or Wi-Fi)

NOTE: Use an HDMI cable to connect your ASUS CUBE with Google TV to an HDTV or HDMI monitor.

ASUS CUBE with Google TV

Front view

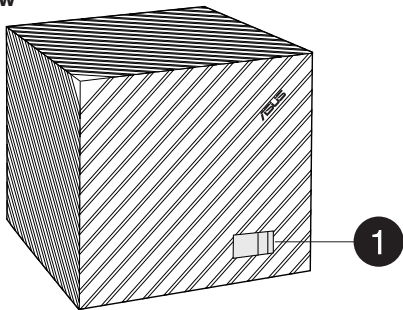

1

IR sensor

This sensor detects the signal from your ASUS CUBE with Google TV remote control.

Rear view

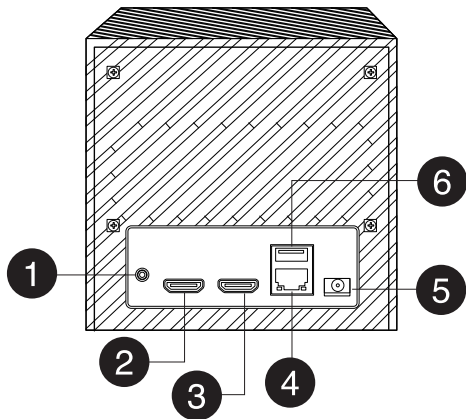

1

IR Blaster port

Connect your IR Blaster cable to this port to remotely control devices.

2

HDMI In port

Connect your audio/video source such as a cable, satellite box, DVD player, or Blu-ray player to this port.

3

HDMI Out port

Connect your external display such as HDTV to this port.

4

Ethernet/LAN (RJ-45) port

Insert a network cable to this port for network connection.

5

Power (DC-In) port

Connect the bundled power adapter into this port to supply power to your ASUS CUBE with Google TV.

6

USB 2.0 port

Connect a USB 2.0 device (such as a USB flash drive) or peripheral (such as keyboard or mouse) into this port.

Right-side view

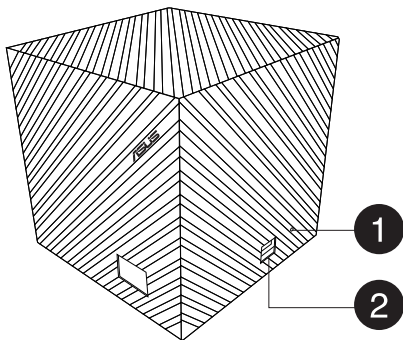

1

Manual reset hole

If the system becomes unresponsive, insert a straightened paper clip into this hole and press for about two seconds to reset your ASUS CUBE with Google TV to the factory default settings.

WARNING! Doing a factory reset will delete all your data and settings.

2

USB 2.0 port

Connect a USB 2.0 device (such as a USB flash drive) or peripheral (such as keyboard or mouse) into this port.

Remote control

Front view



TV/STB

TV/STB (TV Standby)

Press to turn TV/STB on/off.



Power

Power button

Press to turn your ASUS CUBE WITH GOOGLE TV on/off.



Touchpad

The touchpad allows you to use multi-gestures to navigate onscreen.

NOTE: Refer to section *Using the touchpad* for more details.



Directional Pad/OK buttons

Press the arrow keys to navigate through menu/submenu. Press **OK** to confirm a selection.



Return

Press to return to the previous screen.



Voice search

Press this key to activate Voice Search.



TV Program Guide

Press to view the electronic TV program guide.



Home Page

Press to return to the Home menu.



Live TV

Press to access Live TV.



Information

Press to display app or media file information.



Netflix

Press to quickly launch Netflix.

NOTE: Netflix may not be available in your country or region.



Mute

Press to disable the audio output.



Picture-in-Picture

Press to watch live TV feed while simultaneously using other apps or features.



Option

Press to view and select from a function's submenu.



Volume control

Press up or down to increase or decrease the volume.



Channel control

Press up or down to browse for channels.

Scroll up or down a webpage.



Microphone

Located at the top of the ASUS logo, use this built-in microphone for the Voice Search function.



Playback control

Press any of these keys to control media playback.

Back and side views

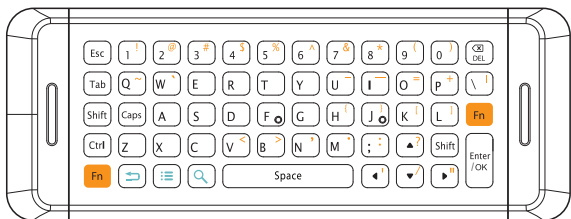

Voice Search (located at the side)

Press this key to activate Voice Search.



Cursor toggle button (located at the side)

Press once to enable the cursor, and do any of these functions:

- Move your finger on the touchpad to move the cursor.
- Tap or press anywhere on the touchpad to do the clicking function.
- Long-press this key while an item is selected to move your finger on the touchpad to do the drag and drop function.

Press again to disable the cursor.



Function key (located at the back)

Press this key with an orange-marked key to activate the function of the orange-marked key.



Qwerty keys (located at the back)

Use these keys for text and numeric input.

Getting your ASUS CUBE with Google TV ready

Connecting the power adapter

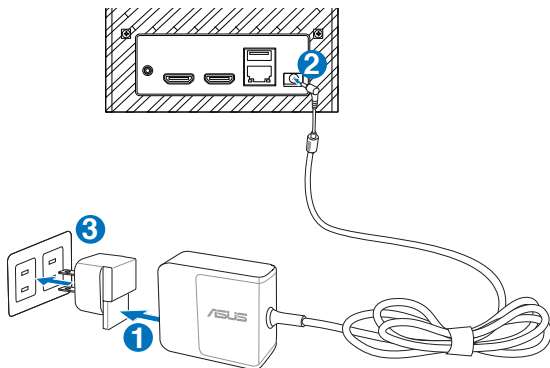

To connect the power adapter:

1. Slide the power plug into the power adapter.
2. Connect the power adapter to the DC-in port at the back of your ASUS CUBE with Google TV .
3. Plug the power plug to a power source.

Connecting devices to your ASUS CUBE with Google TV

To connect devices to your ASUS CUBE with Google TV:

1. Use an HDMI cable to directly connect your external display such as HDTV to your ASUS CUBE with Google TV's HDMI-Out port.

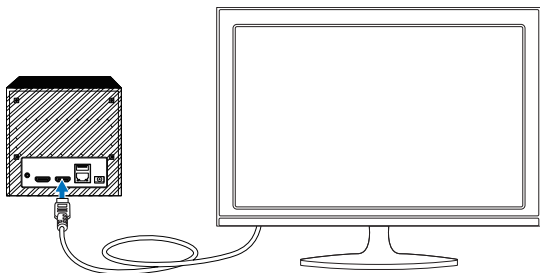

2. (Optional) Use an HDMI cable to connect your media devices such as cable or satellite box to your ASUS CUBE with Google TV's HDMI-In port.

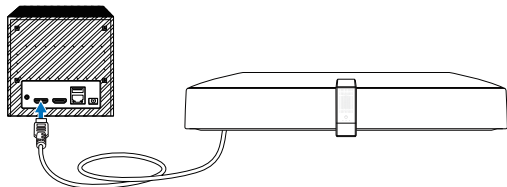

3. If you have connected a media device such as cable or satellite, ensure that you connect the bundled IR Blaster cable to the IR Blaster port at the back of your ASUS CUBE with Google TV.

Pairing your remote control with your ASUS CUBE with Google TV

You need to pair the bundled remote control with your ASUS CUBE with Google TV before using it for the first time or after replacing the batteries.

To pair the remote control with your ASUS CUBE with Google TV:

1. Press the Rewind (⏮) and Forward (⏭) buttons for more than three seconds. Take note of the following blue LED status on the remote control:
 - Quick flashing blue LED: In pairing mode
 - Slow flashing blue LED: Reconnecting mode

NOTE: Ensure that your ASUS CUBE with Google TV remote control is directly pointed to your ASUS CUBE with Google TV's IR sensor.

2. Wait until a message appears confirming that pairing is successful.

Pairing your ASUS CUBE with Google TV with Bluetooth devices

To pair your ASUS CUBE with Google TV with Bluetooth devices:

1. Press  , navigate to **All Apps > Setting > Network > Bluetooth > Find nearby devices**.
2. Select the Bluetooth device that you want to pair with your ASUS CUBE with Google TV.

Chapter 2: Using your ASUS CUBE with Google TV

Using your ASUS CUBE with Google TV for the first time

When you start your ASUS CUBE with Google TV for the first time, the setup wizard screen appears to guide you in configuring the basic settings of your ASUS CUBE with Google TV.

If you need to reset your ASUS CUBE with Google TV, navigate to **Settings > Privacy & safety > Factory data reset**.

WARNING! Doing a factory reset will delete all your data and settings.

To use your ASUS CUBE with Google TV for the first time:

1. Turn on your ASUS CUBE with Google TV and your HDTV.
2. The screen may stay dark for several seconds after the logo disappears. Wait for a while until the Initial Setup Wizard is displayed.
3. Follow the instructions to complete the process.

Using the touchpad

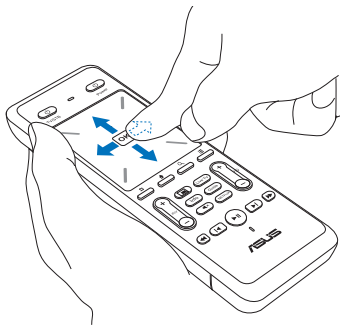

Drag and drop

Long press the cursor toggle key then drag an item to its new location.

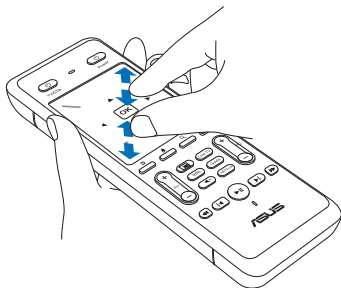

Zoom in/out

Spread apart/bring together two fingers to zoom in/out.

Navigating the cube user interface

Press the arrow keys on your remote control's directional pad to navigate through the various categories on the cube user interface.

Home screen

You can access various apps and functions such as All Apps, Notifications, Widgets, and popular websites from the Home screen.







To launch the Home Screen:

Press  .



Customizing home apps

You can add, move, or remove apps from the Home screen.

To customize home apps:

1. Press  >  > **Customize home apps**.
2. To add an app: Press  , select the app and app category, then press  .
To move or remove an app: Select the app, then press  . Select **Move** or **Remove from Home**, then press  .
3. When done, press  .







NOTES:

- When the cursor mode is enabled, the functions for  and  buttons are disabled.
 - For details about the cursor mode, refer to the section **Remote Control: Back and side views** on page 19.
-



Customizing home widgets

You can add, move, and remove widgets from the Home screen.

To customize home widgets:

1. Press  >  > **Customize home widgets**.
2. To add a widget: Press , select the widget, then press .
To move or remove a widget: Select the widget, then press . Select **Move** or **Remove from Home**, then press .
3. When done, press .

NOTES:

- When the cursor mode is enabled, the functions for  and  buttons are disabled.
 - For details about the cursor mode, refer to the section **Remote Control: Back and side views** on page 19.
-

All apps screen

The All apps screen contains these main app categories: **TV & Movies**, **Games**, **Social & Life**, **Education**, **Music**, **News**, **Sports**, **Photos**, and **Favorite**.

To launch the All Apps screen:

Press  , navigate to **All Apps**  and select your app from the app categories.

Play Store

Access and download lots of fun games and apps from the Play Store using your Google account.

To launch Play Store, navigate to  on the Home screen.

IMPORTANT! Ensure that your ASUS CUBE with Google TV is connected to the Internet. For more details, refer to the section **Internet settings**.

NOTE: You may need to purchase some of the apps.

Using downloaded files

You can download files from websites and store them in Downloads.



To download files:

Use your remote control to download from a website and store it in Downloads.

To access downloaded files:

1. Press  .
2. Select **All Apps > Downloads**.
3. Select the downloaded file that you want to access.

To delete downloaded files:

1. Press  .
2. Select **All Apps > Downloads**.
3. Select the downloaded file that you want to delete, and press  .
4. Press  > **View Option > Delete**.

Google Chrome

Use the Google Chrome web browser to access or bookmark your favorite websites.

To launch Google Chrome, navigate to  on the Home screen.



IMPORTANT! Ensure that your ASUS CUBE with Google TV is connected to the Internet. For more details, refer to the section **Internet settings**.

Browser windows

To launch a new window:

While browsing a website, press , select **Windows**, press , and select **New Window**.

To view all open windows:

While browsing a website, press , select **Windows**, and press . You can have three-opened Chrome windows at one time.

To refresh a browser window:

While browsing a website, press , select **Reload**, and press .

Browser history



To access your browsing history:

While browsing a website, press , select **History**, and press .

To clear your browsing history:

While browsing a website, press , select **History**, press , and select **Clear History**.

To clear all your browsing data such as cache and cookies:

While browsing a website, press , select **Settings**, press , and select the data you want to delete.

Incognito Mode Browser

Browse websites in incognito mode if you do not want your website visits recorded in your browser history.



To launch an incognito window:

While browsing a website, press , select **Windows**, press , and select **New incognito window**.

Bookmarking your favorite websites

Bookmark your favorite websites to easily access them the next time you surf the Internet.



To bookmark your favorite websites:

While browsing a website, press , select **Bookmarks > Add bookmark**, and press .

To access your bookmarks:

While browsing a website, press , select **Bookmarks**, and press .

To delete a bookmark:

Select the bookmark you want to delete, press and hold , select **Delete bookmark**, and press .



Google Chrome security settings

You can set a PIN code to lock and prevent others from using your ASUS CUBE with Google TV's Google Chrome browser.

To set up the PIN number:

1. Press , select **System settings** > **Privacy & safety** > **Application lock**.
2. Tick **Lock Google Chrome** and press .
3. Assign the PIN number and press .

To unlock or change the PIN number:

1. Press , select **System settings** > **Privacy & safety** > **Application lock**.
2. Tick **Unlock Google Chrome** and press .
3. Key in your old PIN number and press .

Picture-in-Picture

Your ASUS CUBE with Google TV's Picture-in-Picture feature allows you to watch a live TV feed while simultaneously using other apps or features on Google TV.





To use Picture-in-Picture:

- Press  on your ASUS CUBE with Google TV remote control to watch a live TV feed at the same time on a small window.
- To close the Picture-in-Picture function, enable the cursor mode and click **X**.

Internet settings

Configure your Internet settings from the Settings menu.

To configure your Internet settings:

1. Launch System Settings in any of these two ways:
 - Press  > **All Apps** >  > **Settings**.
 - Press  >  > **System settings**.
2. Select **Network**, and select either **Ethernet** or **Wi-Fi**.
3. Enter the necessary information for your Internet settings.

Mobile Remote

Mobile Remote allows your Android device to wirelessly access your ASUS CUBE with Google TV. It allows you to use your Android device to:

- Access all apps from your ASUS CUBE with Google TV.
- Search and access videos, movies, or photos from your ASUS CUBE with Google TV.
- Use Mobile Remote apps.

To use Mobile Remote:

1. Ensure that both your ASUS CUBE with Google TV and your Android device are on the same Wi-Fi network.
2. Download **Mobile Remote** to your Android device from the Google Play Store.

NOTE: For more details about Google Play Store, refer to the section **Play Store**.

3. Launch **Mobile Remote** on your Android device.
4. Wait for a few minutes while your Android device establishes connection with your ASUS CUBE with Google TV.

Media Manager

Media Manager allows you to manage your files by file types and file sources.

To use Media Manager:

Navigate to **All apps** > **Media Manager** > **Local Media** to play files from a connected USB storage device.

You can also select to play files from other sources such as from the ASUS WebStorage, local network, or Samba/UPnP Server.

AutoPlay

Your ASUS CUBE with Google TV's AutoPlay function allows you to automatically play your videos from a connected USB storage device.



To use AutoPlay:

1. On your USB storage device, create a folder named **AutoPlay**.
2. Copy your supported media content to the AutoPlay folder.
3. Connect your USB storage device to your ASUS CUBE with Google TV, and your media content will automatically be played.

NOTE: For ASUS CUBE with Google TV's supported media formats, refer to the section **Supported Media Formats** in Appendices.

Watching Live TV

To watch Live TV:

- While browsing the Internet, press  on your ASUS CUBE with Google TV remote control to watch a live TV feed.
- Press  on your ASUS CUBE with Google TV remote control to close the live TV feed.

Music Player and Photo Gallery

Use Music Player or Photo Gallery, which are pre-installed apps, to listen to music or view your photos.

To use Music Player or Photo Gallery:

1. Insert a USB storage device containing your media files to your ASUS CUBE with Google TV's USB port.
2. Navigate to **All apps**, then navigate to **Music Player** or **Photo Gallery**.
3. Select a file from the list and press .

NOTE: For ASUS CUBE with Google TV's supported media formats, refer to the section **Supported Media Formats** in Appendices.

ASUS WebStorage



ASUS WebStorage is a pre-installed app that allows you to quickly access your ASUS WebStorage account for saving, syncing, sharing, and accessing your files anytime and anywhere. This app also lets you create notes, take pictures, record videos and voice messages and instantly save them in your WebStorage account.

NOTE: Visit the ASUS WebStorage website at <http://www.asuswebstorage.com> for more details.

Whiteboard



Whiteboard is a pre-installed app that allows you create a group where you posts or share memos or messages to your group members. You can view and read these messages on Google TV or on your mobile devices.

To create a group:

1. Press  .
2. Select **All Apps > Whiteboard.**
3. Select Sign-in.
4. Enter your Gmail and other necessary information. When done, select **OK.**
5. As the group host, you can now add members to your group.

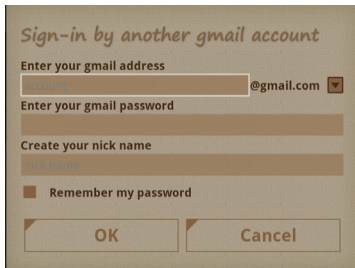

Sign-in by another gmail account

Enter your gmail address
[text field] @gmail.com ▾

Enter your gmail password
[text field]

Create your nick name
[text field]

Remember my password

OK Cancel

NOTE: Whiteboard app only works with Gmail accounts.

To add a new group member:

1. From the Whiteboard screen, select **Add member**.
2. Enter the new member's Gmail and other necessary info. When done, select **OK**.
3. You can do steps 1 and 2 to add more members to your group.

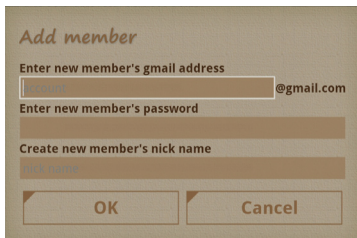

The screenshot shows a dialog box titled "Add member" with a light brown background. It contains three input fields: "Enter new member's gmail address" (with a placeholder "yorktnp@gmail.com"), "Enter new member's password" (with a placeholder "123456789"), and "Create new member's nick name" (with a placeholder "yorktnp"). At the bottom, there are two buttons: "OK" and "Cancel".

To create a new memo:

1. From the Whiteboard screen, select **Create new memo**.
2. Enter your message on the message field. When done, click the Save icon.

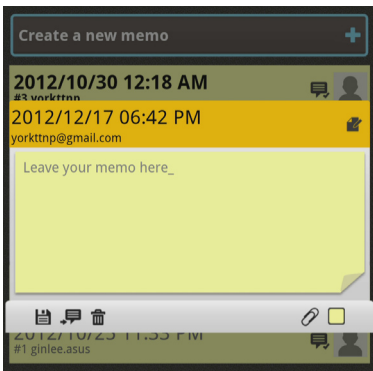

The screenshot shows a "Create a new memo" screen with a dark background. At the top, there is a header "Create a new memo" with a plus sign icon. Below the header, there are two memo entries. The first entry is dated "2012/10/30 12:18 AM" with the text "#3 yorktnp" and icons for chat and profile. The second entry is dated "2012/12/17 06:42 PM" with the text "yorktnp@gmail.com" and a save icon. Below the entries is a large yellow text area with the placeholder "Leave your memo here_". At the bottom, there is a toolbar with icons for save, chat, delete, and a plus sign.

Task Killer

Task Killer is an app that allows you to force stop running apps.

To force stop running apps:

1. Press  .
2. Select **All Apps > Task Killer**.
3. Select the running apps that you want to force stop, and click **Kill selected apps**.

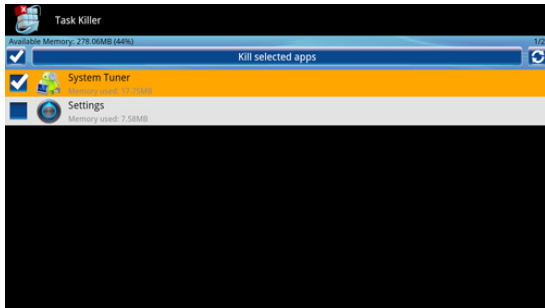

Chapter 3: Troubleshooting

Troubleshooting

This section provides answers to some common problems that you may encounter while installing or using your ASUS CUBE WITH GOOGLE TV. These problems require simple troubleshooting that you can perform by yourself. Contact ASUS Technical Support if you encounter problems not mentioned in this section.

Remote Control

Q1. The ASUS CUBE with Google TV's remote control is not working.

- Ensure that the batteries are inserted correctly.
- The batteries may already be drained out. Replace the batteries with new ones.
- Ensure that the path between the remote control and the ASUS CUBE with Google TV is not blocked. Operate the remote control closer to the ASUS CUBE with Google TV.
- Simultaneously press the Rewind (⏮) and Forward (⏭) buttons for more than three seconds to pair the remote control and the ASUS CUBE with Google TV again. The LED quickly flashes blue indicating that the ASUS CUBE with Google TV is in a pairing mode with the remote control.

Q2. I cannot get a good signal using my remote control.

- To get the best signal when using your remote control, ensure that you point your remote control directly at your ASUS CUBE with Google TV's IR sensor at an angle of less than or equal to 30 degrees and at a distance of five meters.

Display

Q1. My ASUS CUBE with Google TV does not seem to power on.

- Ensure that that power plug and power adapter are properly connected.
- The ASUS CUBE with Google TV's power adapter possibly performs the overload protection function — automatic shutdown during overload conditions, such as Over Current, Over Voltage, and Over Temperature.
- Disconnect the ASUS CUBE with Google TV's power adapter and wait for a few minutes before you replug the ASUS CUBE with Google TV's power adapter directly into an outlet. Turn the ASUS CUBE with Google TV on again.

Q2. The TV screen is blank and the ASUS CUBE with Google TV's power LED remains off.

- Ensure that the ASUS CUBE with Google TV's power is turned on.
- Ensure that the TV is turned on.
- Ensure that the ASUS CUBE with Google TV's power adapter and the power outlet are functional.
- Ensure that the ASUS CUBE with Google TV's power adapter plug is firmly attached to the rear panel of the ASUS CUBE with Google TV and to the power outlet.

Q3. I cannot see the Setup Wizard when I turn on the ASUS CUBE with Google TV for the first time. The TV screen is blank and the ASUS CUBE with Google TV's power LED is on.

- Ensure that the HDMI cable is properly connected to the ASUS CUBE with Google TV's HDMI Output (HDMI Out) port and to your TV's HDMI port. Try disconnecting and reconnecting the HDMI cable.
- Ensure that your TV is switched to the appropriate video source (AV IN or HDMI). You may need to use your TV remote control to change video sources.
- Turn off the ASUS CUBE with Google TV and wait for a few minutes before turning it on again or insert a straightened paper clip into the manual reset hole at the right-side of the ASUS CUBE with Google TV.

IMPORTANT: Resetting your ASUS CUBE with Google TV will lead to loss of data such as configuration settings.

- Ensure that the HDMI resolution of your TV supports 720p, 1080i, or 1080p.
- When you turn off the ASUS CUBE with Google TV, wait until it is completely turned off. DO NOT press the remote control repeatedly when the remote control is in the power-off process. Doing so will cause the ASUS CUBE with Google TV to malfunction. If this occurs, disconnect and then connect the power adapter to the ASUS CUBE with Google TV.
- When the ASUS CUBE with Google TV and the TV are connected with HDMI cables via a cable or satellite box, pictures may not be displayed properly due to the copyright protection feature of some set-top boxes. In this case, contact your cable/satellite TV service provider.

Q4. The TV screen is blinking and fuzzy.

- Ensure that the HDMI cable is properly connected to the correct HDMI ports on both the TV and the ASUS CUBE with Google TV.
- Ensure that the correct HDMI resolution option is selected.

Q5. Certain files cannot be played on the ASUS CUBE with Google TV.

- The ASUS CUBE with Google TV may not support the video or audio format used in the file. For ASUS CUBE with Google TV's supported media formats, refer to the section **Supported Media Formats** in Appendices.
- For information on the media formats that Google TV supports, please visit: https://developers.google.com/tv/android/gtv_media_formats

Q6. How do I change the aspect ratio of a video file during video playback?

On your remote control, press  or  and select your preferred aspect ratio from any of the four available aspect ratios.

Audio

Q1. There is no sound or poor sound.

- Ensure the volume on the TV or entertainment unit, such as cable or satellite box, is not on mute mode.
- Check the volume levels of your TV set and ASUS CUBE with Google TV.
- Ensure that the HDMI cable is connected correctly.

Q2. A few of my music files do not appear.

The ASUS CUBE with Google TV supports the most common music file formats. However, there are almost an infinite variety of bit rates and sample rates. If a file is not displayed on the screen, it most likely uses an unsupported bit rate or sample rate. Only use files with supported formats, bit rates, and sample rates.

NOTE: For ASUS CUBE with Google TV's supported media formats, refer to the section **Supported Media Formats** in Appendices.

USB storage device

Q1. I cannot find any of my music, video, or photo files on my USB storage device.

- Ensure that your USB storage device is properly plugged in.
- Ensure that your USB storage device (USB Flash/USB Hard drive) is not in standby mode.
- Ensure that the files are in supported file formats.

Q2. The ASUS CUBE with Google TV does not recognize my USB storage device.

Your USB storage device may not be detected because of problems with the USB hardware driver, USB cable, or longer system response time. Try inserting the USB storage device to the USB port again, replace a new USB cable, or use another USB storage device.

Q3. After connecting an external hard disk drive (HDD) , the correct model name is not displayed and I cannot remove the USB storage device.

- Wait for a few minutes until the HDD indexing is completed.
- If drive indexing is taking too long, you can force unmount your external HDD from **Settings > Storage**.

Google TV software updates

Every Google TV device receives an over-the-air (OTA) software update the first time it is turned on and connected to the Internet. This update ensures that you get the latest Google TV experience.

Q1. How do I know if my system is up-to-date?

Select **System updates > About > Settings**, then click **OK**. A message shows your system's version information.

Wired LAN, Wi-Fi, and Internet connections

Q1. I cannot connect to the Internet via Wi-Fi.

- Ensure that the LAN router or Wireless LAN router is on.
- Ensure that the network cable is connected correctly when using a wired network connection.
- Check the settings of the LAN router or Wireless LAN router.

Q2. I cannot connect to the Internet via LAN.

- If you cannot connect to the Internet via Wi-Fi, ensure that you have not connected a network cable to the ASUS CUBE with Google TV. The ASUS CUBE with Google TV places priority on a LAN connection over a Wi-Fi connection.

Q3. I cannot connect to the wired network.

- Please check your router setting to determine the correct setup type to properly configure and connect your ASUS CUBE with Google TV to the Internet.
- You need to select either Dynamic (AUTO IP) or Static (Fixed IP) as your setup type. If you select Dynamic (AUTO), the router's DHCP server automatically assigns an IP address for your ASUS CUBE with Google TV.
- You need to select either DHCP or Static as your setup type. If you select DHCP, the router's DHCP server automatically assigns an IP address to the ASUS CUBE with Google TV.
- If you select Static, key in the IP address, Gateway, and Network prefix length.

Q4. The LEDs on the Ethernet port do not blink and my wired connection does not work.

- Ensure that the network cable is firmly connected to the ASUS CUBE with Google TV's LAN port located at the rear panel.
- Replace the LAN cable.

Q5. I cannot connect to the Wi-Fi network.

- Ensure that you have properly configured your Wi-Fi settings.
- Check your wireless router settings to ensure that you have correctly configured your ASUS CUBE with Google TV's Wi-Fi settings.
- The network you are trying to access may be protected, secured, or encrypted. If you are trying to connect to a wireless local area network (WLAN), contact your network administrator for the security and encryption settings.

Q6. When I searched for a Wi-Fi network, I found several networks, some of which are encrypted. How do I connect to an encrypted network?

Contact your network administrator for the correct SSID (network name) and encryption key or password for the wireless network you want to connect to.

Q7. Movies streamed via the Wi-Fi network does not run smoothly.

Possible causes may be:

- Slow connection or high Internet traffic.
- Interference from several sources such as other wireless network devices, Bluetooth devices, wireless phones, or even microwave ovens.
- You may have limited bandwidth usage on your network. Contact your Internet Service Provider (ISP) to inquire about increasing your bandwidth for your network connection.

Q8. My Internet connection slows down while watching an online media.

- Slow connection or high Internet traffic may cause this problem. Try watching the online media during off-peak hours.
- You may have limited bandwidth usage on your network. Contact your Internet Service Provider (ISP) to inquire about increasing your bandwidth for your network connection.

Q9. Why do I encounter network lag when I use Internet media services?

- Depending on the streaming situation or network stability/traffic, you might need to wait for a few minutes to use the Internet media services.
- You may have limited bandwidth usage on your network. Contact your Internet Service Provider (ISP) to inquire about increasing your bandwidth for your network connection.

Q10. Can I connect to the network via both wired and wireless connections simultaneously?

Yes, you can connect to the network using both wired and wireless connections simultaneously. Ethernet will have priority over Wi-Fi.

Operation/function failure

Q1. An operation/function failed on my ASUS CUBE with Google TV. What can I do?

- Do the following to force close an app.
 - a) Go to **All apps** and select the running app that you want to force close.
 - b) Press , then select **Application info > Force close**.
- Disconnect the power adapter from the power source, then plug it in again.
- Insert a straightened paper clip into the manual reset hole located at the right side to reset the ASUS CUBE with Google TV to the factory default settings.

WARNING! Doing a factory reset will delete all your data and settings.

IR Blaster

Q1. I cannot remotely control my cable/satellite TV box or AV receiver.

IR Blaster (Infrared Blaster) allows you to remotely control your devices such as cable/satellite TV or AV receiver using your ASUS CUBE with Google TV remote control. If you encounter some problem with your ASUS CUBE's IR Blaster function, do the following:

- Ensure that all devices are turned on.
- The IR Blaster cable is firmly connected to your ASUS CUBE with Google TV's IR Blaster port and is placed at least 3 cm near your cable/satellite TV or AV receiver.
- Your ASUS CUBE with Google TV settings are correctly configured.

Appendices

Notices

ASUS Recycling/Takeback Services

ASUS recycling and takeback programs come from our commitment to the highest standards for protecting our environment. We believe in providing solutions for you to be able to responsibly recycle our products, batteries, other components, as well as the packaging materials. Please go to <http://csr.asus.com/english/Takeback.htm> for the detailed recycling information in different regions.

REACH

Complying with the REACH (Registration, Evaluation, Authorisation, and Restriction of Chemicals) regulatory framework, we published the chemical substances in our products at ASUS REACH website at <http://csr.asus.com/english/index.aspx>.

Federal Communications Commission Statement

This device complies with Part 15 of the FCC Rules. Operation is subject to the following two conditions:

- This device may not cause harmful interference.
- This device must accept any interference including interference that may cause undesired operation.

This equipment has been tested and found to comply with the limits for a Class B digital device, pursuant to Part 15 of the FCC Rules. These limits are designed to provide reasonable protection against harmful interference in a residential installation. This equipment generates, uses and can radiate radio frequency energy and, if not installed and used in accordance with manufacturer's instructions, may cause harmful interference to radio communications. However, there is no guarantee that interference will not occur in a

particular installation. If this equipment does cause harmful interference to radio or television reception, which can be determined by turning the equipment off and on, the user is encouraged to try to correct the interference by one or more of the following measures:

- Reorient or relocate the receiving antenna.
- Increase the separation between the equipment and receiver.
- Connect the equipment to an outlet on a circuit different from that to which the receiver is connected.
- Consult the dealer or an experienced radio/TV technician for help.

IMPORTANT! This device is restricted to indoor use when operating in the 5.15 ~ 5.25 GHz frequency band.

WARNING! Any changes or modifications to this unit not expressly approved by the party responsible for compliance could void the user's authority to operate this equipment.

Exposure to Radio Frequency Energy

The radiated output power of the Wi-Fi technology is below the FCC radio frequency exposure limits. Nevertheless, it is advised to use the wireless equipment in such a manner that the potential for human contact during normal operation is minimized.

Bluetooth Equipment: FCC Bluetooth Wireless Compliance

The antenna used with this transmitter must not be co-located or operated in conjunction with any other antenna or transmitter subject to the conditions of the FCC Grant.

Canadian Department of Communications Statement

This digital device does not exceed the Class B limits for radio noise emissions from digital device set out in the Radio Interference Regulations of the Canadian Department of Communications.

This class B digital device complies with Canadian ICES-003.

GNU General Public License

Licensing information

This product includes copyrighted third-party software licensed under the terms of the GNU General Public License. Please see The GNU General Public License for the exact terms and conditions of this license. We include a copy of the GPL with every CD shipped with our product. All future firmware updates will also be accompanied with their respective source code. Please visit our web site for updated information. Note that we do not offer direct support for the distribution.*-

GNU GENERAL PUBLIC LICENSE

Version 2, June 1991

Copyright (C) 1989, 1991 Free Software Foundation, Inc.
59 Temple Place, Suite 330, Boston, MA 02111-1307 USA

Everyone is permitted to copy and distribute verbatim copies of this license document, but changing it is not allowed.

Preamble

The licenses for most software are designed to take away your freedom to share and change it. By contrast, the GNU General Public License is intended to guarantee your freedom to share and change free software—to make sure the software is free for all its users. This General Public License applies to most of the Free Software Foundation's software and to any other program whose authors commit to using it. (Some other Free Software Foundation software is covered by the GNU Library General Public License instead.) You can apply it to your programs, too.

When we speak of free software, we are referring to freedom, not price. Our General Public Licenses are designed to make sure that you have the freedom to distribute copies of free software (and charge for this service if you wish), that you receive source code or can get it if you want it, that you can change the software or use pieces of it in new free programs; and that you know you can do these things.

To protect your rights, we need to make restrictions that forbid anyone to deny you these rights or to ask you to surrender the rights. These restrictions translate to certain responsibilities for you if you distribute copies of the software, or if you modify it.

For example, if you distribute copies of such a program, whether gratis or for a fee, you must give the recipients all the rights that you have. You must make sure that they, too, receive or can get the source code. And you must show them these terms so they know their rights.

We protect your rights with two steps: (1) copyright the software, and (2) offer you this license which gives you legal permission to copy, distribute and/or modify the software.

Also, for each author's protection and ours, we want to make certain that everyone understands that there is no warranty for this free software. If the software is modified by someone else and passed on, we want its recipients to know that what they have is not the original, so that any problems introduced by others will not reflect on the original authors' reputations.

Finally, any free program is threatened constantly by software patents. We wish to avoid the danger that redistributors of a free program will individually obtain patent licenses, in effect making the program proprietary. To prevent this, we have made it clear that any patent must be licensed for everyone's free use or not licensed at all.

The precise terms and conditions for copying, distribution and modification follow.

Terms & conditions for copying, distribution, & modification

0. This License applies to any program or other work which contains a notice placed by the copyright holder saying it may be distributed under the terms of this General Public License. The "Program", below, refers to any such program or work, and a "work based on the Program" means either the Program or any derivative work under copyright law: that is to say, a work containing the Program or a portion of it, either verbatim or with modifications and/or translated into another language. (Hereinafter, translation is included without limitation in the term "modification".) Each licensee is addressed as "you".

Activities other than copying, distribution and modification are not covered by this License; they are outside its scope. The act of running the Program is not restricted, and the output from the Program is covered only if its contents constitute a work based on the Program (independent of having been made by running the Program). Whether that is true depends on what the Program does.

1. You may copy and distribute verbatim copies of the Program's source code as you receive it, in any medium, provided that you conspicuously and appropriately publish on each copy an appropriate copyright notice and disclaimer of warranty; keep intact all the notices that refer to this License and to the absence of any warranty; and give any other recipients of the Program a copy of this License along with the Program.
You may charge a fee for the physical act of transferring a copy, and you may at your option offer warranty protection in exchange for a fee.
2. You may modify your copy or copies of the Program or any portion of it, thus forming a work based on the Program, and copy and distribute such modifications or work under the terms of Section 1 above, provided that you also meet all of these conditions:
 - a) You must cause the modified files to carry prominent notices stating that you changed the files and the date of any change.
 - b) You must cause any work that you distribute or publish, that in whole or in part contains or is derived from the Program or any part thereof, to be licensed as a whole at no charge to all third parties under the terms of this License.
 - c) If the modified program normally reads commands interactively when run, you must cause it, when started running for such interactive use in the most ordinary way, to print or display an announcement including an appropriate copyright notice and a notice that there is no warranty (or else, saying that you provide a warranty) and that users may redistribute the program under these conditions, and telling the user how to view a copy of this License. (Exception: if the Program itself is interactive but does not normally print such an announcement, your work based on the Program is not required to print an announcement.)

These requirements apply to the modified work as a whole. If identifiable sections of that work are not derived from the Program, and can be reasonably considered independent and separate works in themselves, then this License, and its terms, do

not apply to those sections when you distribute them as separate works. But when you distribute the same sections as part of a whole which is a work based on the Program, the distribution of the whole must be on the terms of this License, whose permissions for other licensees extend to the entire whole, and thus to each and every part regardless of who wrote it.

Thus, it is not the intent of this section to claim rights or contest your rights to work written entirely by you; rather, the intent is to exercise the right to control the distribution of derivative or collective works based on the Program.

In addition, mere aggregation of another work not based on the Program with the Program (or with a work based on the Program) on a volume of a storage or distribution medium does not bring the other work under the scope of this License.

3. You may copy and distribute the Program (or a work based on it, under Section 2) in object code or executable form under the terms of Sections 1 and 2 above provided that you also do one of the following:
 - a) Accompany it with the complete corresponding machine-readable source code, which must be distributed under the terms of Sections 1 and 2 above on a medium customarily used for software interchange; or,
 - b) Accompany it with a written offer, valid for at least three years, to give any third party, for a charge no more than your cost of physically performing source distribution, a complete machine-readable copy of the corresponding source code, to be distributed under the terms of Sections 1 and 2 above on a medium customarily used for software interchange; or,
 - c) Accompany it with the information you received as to the offer to distribute corresponding source code. (This alternative is allowed only for noncommercial distribution and only if you received the program in object code or executable form with such an offer, in accord with Subsection b above.)

The source code for a work means the preferred form of the work for making modifications to it. For an executable work, complete source code means all the source code for all modules it contains, plus any associated interface definition files, plus the scripts used to control compilation and installation of the executable. However, as a special exception, the source code distributed need not include anything that

is normally distributed (in either source or binary form) with the major components (compiler, kernel, and so on) of the operating system on which the executable runs, unless that component itself accompanies the executable.

If distribution of executable or object code is made by offering access to copy from a designated place, then offering equivalent access to copy the source code from the same place counts as distribution of the source code, even though third parties are not compelled to copy the source along with the object code.

4. You may not copy, modify, sublicense, or distribute the Program except as expressly provided under this License. Any attempt otherwise to copy, modify, sublicense or distribute the Program is void, and will automatically terminate your rights under this License. However, parties who have received copies, or rights, from you under this License will not have their licenses terminated so long as such parties remain in full compliance.
5. You are not required to accept this License, since you have not signed it. However, nothing else grants you permission to modify or distribute the Program or its derivative works. These actions are prohibited by law if you do not accept this License. Therefore, by modifying or distributing the Program (or any work based on the Program), you indicate your acceptance of this License to do so, and all its terms and conditions for copying, distributing or modifying the Program or works based on it.
6. Each time you redistribute the Program (or any work based on the Program), the recipient automatically receives a license from the original licensor to copy, distribute or modify the Program subject to these terms and conditions. You may not impose any further restrictions on the recipients' exercise of the rights granted herein. You are not responsible for enforcing compliance by third parties to this License.
7. If, as a consequence of a court judgment or allegation of patent infringement or for any other reason (not limited to patent issues), conditions are imposed on you (whether by court order, agreement or otherwise) that contradict the conditions of this License, they do not excuse you from the conditions of this License. If you cannot distribute so as to satisfy simultaneously your obligations under this License and any other pertinent obligations, then as a consequence you may not distribute the Program at all. For example, if a patent license would not permit royalty-free redistribution of the Program

by all those who receive copies directly or indirectly through you, then the only way you could satisfy both it and this License would be to refrain entirely from distribution of the Program.

If any portion of this section is held invalid or unenforceable under any particular circumstance, the balance of the section is intended to apply and the section as a whole is intended to apply in other circumstances.

It is not the purpose of this section to induce you to infringe any patents or other property right claims or to contest validity of any such claims; this section has the sole purpose of protecting the integrity of the free software distribution system, which is implemented by public license practices. Many people have made generous contributions to the wide range of software distributed through that system in reliance on consistent application of that system; it is up to the author/donor to decide if he or she is willing to distribute software through any other system and a licensee cannot impose that choice.

This section is intended to make thoroughly clear what is believed to be a consequence of the rest of this License.

8. If the distribution and/or use of the Program is restricted in certain countries either by patents or by copyrighted interfaces, the original copyright holder who places the Program under this License may add an explicit geographical distribution limitation excluding those countries, so that distribution is permitted only in or among countries not thus excluded. In such case, this License incorporates the limitation as if written in the body of this License.
9. The Free Software Foundation may publish revised and/or new versions of the General Public License from time to time. Such new versions will be similar in spirit to the present version, but may differ in detail to address new problems or concerns.

Each version is given a distinguishing version number. If the Program specifies a version number of this License which applies to it and "any later version", you have the option of following the terms and conditions either of that version or of any later version published by the Free Software Foundation. If the Program does not specify a version number of this License, you may choose any version ever published by the Free Software Foundation.

10. If you wish to incorporate parts of the Program into other free programs whose distribution conditions are different, write to the author to ask for permission. For software which is copyrighted by the Free Software Foundation, write to the Free Software Foundation; we sometimes make exceptions for this. Our decision will be guided by the two goals of preserving the free status of all derivatives of our free software and of promoting the sharing and reuse of software generally.

NO WARRANTY

11. BECAUSE THE PROGRAM IS LICENSED FREE OF CHARGE, THERE IS NO WARRANTY FOR THE PROGRAM, TO THE EXTENT PERMITTED BY APPLICABLE LAW. EXCEPT WHEN OTHERWISE STATED IN WRITING THE COPYRIGHT HOLDERS AND/OR OTHER PARTIES PROVIDE THE PROGRAM "AS IS" WITHOUT WARRANTY OF ANY KIND, EITHER EXPRESSED OR IMPLIED, INCLUDING, BUT NOT LIMITED TO, THE IMPLIED WARRANTIES OF MERCHANTABILITY AND FITNESS FOR A PARTICULAR PURPOSE. THE ENTIRE RISK AS TO THE QUALITY AND PERFORMANCE OF THE PROGRAM IS WITH YOU. SHOULD THE PROGRAM PROVE DEFECTIVE, YOU ASSUME THE COST OF ALL NECESSARY SERVICING, REPAIR OR CORRECTION.
12. IN NO EVENT UNLESS REQUIRED BY APPLICABLE LAW OR AGREED TO IN WRITING WILL ANY COPYRIGHT HOLDER, OR ANY OTHER PARTY WHO MAY MODIFY AND/OR REDISTRIBUTE THE PROGRAM AS PERMITTED ABOVE, BE LIABLE TO YOU FOR DAMAGES, INCLUDING ANY GENERAL, SPECIAL, INCIDENTAL OR CONSEQUENTIAL DAMAGES ARISING OUT OF THE USE OR INABILITY TO USE THE PROGRAM (INCLUDING BUT NOT LIMITED TO LOSS OF DATA OR DATA BEING RENDERED INACCURATE OR LOSSES SUSTAINED BY YOU OR THIRD PARTIES OR A FAILURE OF THE PROGRAM TO OPERATE WITH ANY OTHER PROGRAMS), EVEN IF SUCH HOLDER OR OTHER PARTY HAS BEEN ADVISED OF THE POSSIBILITY OF SUCH DAMAGES.

END OF TERMS AND CONDITIONS

CE Mark Warning

This is a Class B product, in a domestic environment, this product may cause radio interference, in which case the user may be required to take adequate measures.



CE marking for devices without wireless LAN/Bluetooth

The shipped version of this device complies with the requirements of the EEC directives 2004/108/EC "Electromagnetic compatibility" and 2006/95/EC "Low voltage directive".



CE marking for devices with wireless LAN/ Bluetooth

This equipment complies with the requirements of Directive 1999/5/EC of the European Parliament and Commission from 9 March, 1999 governing Radio and Telecommunications Equipment and mutual recognition of conformity.

 is for class II device.

Wireless Operation Channel for Different Domains

N. America	2.412-2.462 GHz	Ch01 through Ch11
Japan	2.412-2.484 GHz	Ch01 through Ch14
Europe ETSI	2.412-2.472 GHz	Ch01 through Ch13

This equipment may be operated in all member states of the EU. Some areas of France have a restricted frequency band. This equipment may be used indoor only.



License notice and trademark acknowledgement for Dolby Digital

Manufactured under license from Dolby Laboratories. Dolby and the double-D symbol are trademarks of Dolby Laboratories.



Supported Media Formats

Video	Audio
MPEG4 ASP, XVID, MJPEG	MP3, PCM, AC3, DDP
H.264, MPEG2	PCM, MP3, AAC, Vorbis, AC3, DDP
H.263, H.264	AAC, MP3
MPEG4 ASP, H.264 (HiP 4.1), MPEG 2	AAC, AC3, DDP
MPEG1, MPEG2	PCM, AC3, DDP
Windows Media Video 9 (WMV9), VC-1	WMA (Pro)
H.263, H.264, VP6	MP3, AAC

NOTES:

- The following formats/functions are not supported: DTS sound, Zoom feature, and FLAC sound file.
 - For HDMI-In, your ASUS CUBE supports AC3 pass-through but not DDP pass-through.
-

ASUS contact information

ASUSTeK COMPUTER INC.

Address	15 Li-Te Road, Peitou, Taipei, Taiwan 11259
Telephone	+886-2-2894-3447
Fax	+886-2-2890-7798
E-mail	info@asus.com.tw
Web site	www.asus.com.tw

Technical Support

Telephone	+86-21-38429911
Online support	support.asus.com

ASUS COMPUTER INTERNATIONAL (America)

Address	800 Corporate Way, Fremont, CA 94539, USA
Telephone	+1-510-739-3777
Fax	+1-510-608-4555
Web site	usa.asus.com

Technical Support

Telephone	+1-812-282-2787
Support fax	+1-812-284-0883
Online support	support.asus.com

ASUS COMPUTER GmbH (Germany and Austria)

Address Harkort Str. 21-23, D-40880 Ratingen, Germany
Fax +49-2102-959911
Web site www.asus.de
Online contact www.asus.de/sales

Technical Support

Component Telephone +49-1805-010923*
System/Notebook/Eee/LCD Telephone +49-1805-010920*
Support Fax +49-2102-9599-11
Online support support.asus.com

*** EUR 0.14/minute from a German fixed landline; EUR 0.42/minute from a mobile phone.**

Manufacturer:	ASUSTeK Computer Inc.
Address:	4F, No.150, LI-TE RD., PEITOU, TAIPEI 112, TAIWAN
Authorised representative in Europe:	ASUS Computer GmbH
Address:	HARKORT STR. 21-23, 40880 RATINGEN, GERMANY

DECLARATION OF CONFORMITY

Per FCC Part 2 Section 2. 1077(a)



Responsible Party Name: Asus Computer International

Address: 800 Corporate Way, Fremont, CA 94539.

Phone/Fax No: (510)739-3777/(510)608-4555

hereby declares that the product

Product Name : Media Streamer

Model Number : ASUS CUBE with Google TV

Conforms to the following specifications:

FCC Part 15, Subpart B, Unintentional Radiators

Supplementary Information:

This device complies with part 15 of the FCC Rules. Operation is subject to the following two conditions: (1) This device may not cause harmful interference, and (2) this device must accept any interference received, including interference that may cause undesired operation.

Representative Person's Name : Steve Chang / President

A handwritten signature in blue ink that reads "Steve Chang". The signature is written in a cursive style and is placed over a light blue rectangular background.

Signature :

Date : Mar. 22, 2013

Ver. 120601

Free Manuals Download Website

<http://myh66.com>

<http://usermanuals.us>

<http://www.somanuals.com>

<http://www.4manuals.cc>

<http://www.manual-lib.com>

<http://www.404manual.com>

<http://www.luxmanual.com>

<http://aubethermostatmanual.com>

Golf course search by state

<http://golfingnear.com>

Email search by domain

<http://emailbydomain.com>

Auto manuals search

<http://auto.somanuals.com>

TV manuals search

<http://tv.somanuals.com>