

All-in-one PC

User Manual

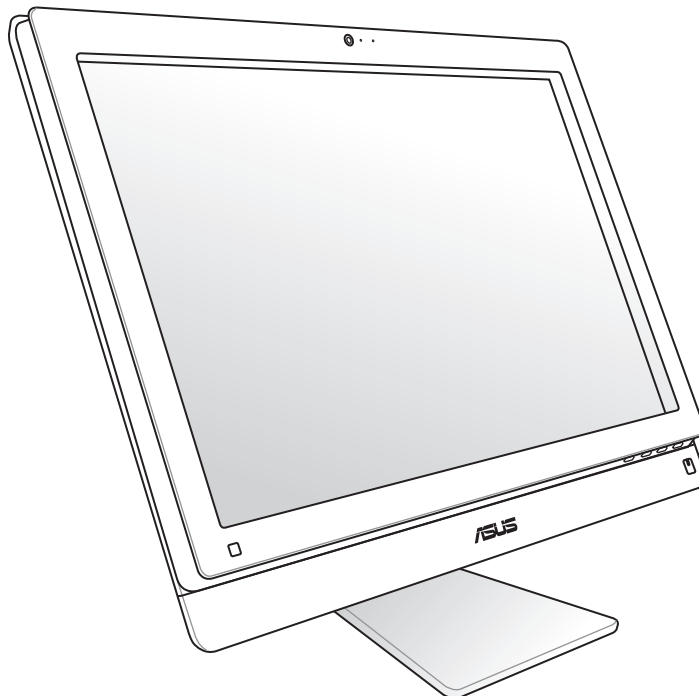

ET2411/ ET2210 Series

E7102

First Edition V1
January 2012

Copyright © 2012 ASUSTeK COMPUTER INC. All Rights Reserved.

No part of this manual, including the products and software described in it, may be reproduced, transmitted, transcribed, stored in a retrieval system, or translated into any language in any form or by any means, except documentation kept by the purchaser for backup purposes, without the express written permission of ASUSTeK COMPUTER, INC. ("ASUS").

Products and corporate names mentioned in this manual may or may not be registered trademarks or copyrights of their respective companies, and are used for identification purposes only. All trademarks are the property of their respective owners.

Every effort has been made to ensure that the contents of this manual are correct and up to date. However, the manufacturer makes no guarantee regarding the accuracy of its contents, and reserves the right to make changes without prior notice.

Contents

Contents	3
Notices.....	5
Federal Communications Commission Statement.....	5
Canadian Department of Communications Statement.....	6
IC Radiation Exposure Statement for Canada.....	6
Declaration of Conformity (R&TTE directive 1999/5/EC).....	6
CE Mark Warning.....	7
Wireless Operation Channel for Different Domains.....	7
France Restricted Wireless Frequency Bands.....	8
REACH.....	9
Global Environmental Regulation Compliance and Declaration	10
ASUS Recycling/Takeback Services.....	10
UL Safety Precaution.....	10
ENERGY STAR complied product.....	11
Notes for this manual.....	11
Safety information.....	12
Setting up your system.....	12
Care during use.....	12
Sound Pressure Warning	13
TV Tuner (on selected models).....	13
Adapter.....	13
DC Fan Warning	13
Welcome	14
Package contents	14
Getting to know your All-in-one PC	15
Front view.....	15
Rear view	17
Side views.....	19
Using the touch screen.....	21
Showing the touch pointer	21
Cleaning the touch screen.....	22

Positioning your All-in-one PC	23
Placing on the desktop.....	23
Mounting to the wall.....	24
Setting up your All-in-one PC	26
Connecting the wired keyboard and mouse.....	26
Connecting the wireless keyboard and mouse	26
Powering on the system.....	27
Powering off	27
Configuring a wireless connection	28
Configuring a wired connection	29
Using a static IP.....	29
Using a dynamic IP (PPPoE).....	31
Connecting to external audio devices	34
Configuring audio output settings	34
Recovering your system	36
Using the recovery partition.....	36
Recovering the OS to the Factory Default Partition (F9 Recovery)	36
Backing up the Factory Default Environment Data to a USB Drive (F9 Backup)	36
Using the USB storage device (USB Restore)	37

Notices

Federal Communications Commission Statement

This device complies with Part 15 of the FCC Rules. Operation is subject to the following two conditions:

- This device may not cause harmful interference, and
- This device must accept any interference received including interference that may cause undesired operation.

This equipment has been tested and found to comply with the limits for a Class B digital device, pursuant to Part 15 of the FCC Rules. These limits are designed to provide reasonable protection against harmful interference in a residential installation. This equipment generates, uses and can radiate radio frequency energy and, if not installed and used in accordance with manufacturer's instructions, may cause harmful interference to radio communications. However, there is no guarantee that interference will not occur in a particular installation. If this equipment does cause harmful interference to radio or television reception, which can be determined by turning the equipment off and on, the user is encouraged to try to correct the interference by one or more of the following measures:

- Reorient or relocate the receiving antenna.
- Increase the separation between the equipment and receiver.
- Connect the equipment to an outlet on a circuit different from that to which the receiver is connected.
- Consult the dealer or an experienced radio/TV technician for help.

CAUTION: Any changes or modifications not expressly approved by the grantee of this device could void the user's authority to operate the equipment.

RF exposure warning

This equipment must be installed and operated in accordance with provided instructions and the antenna(s) used for this transmitter must be installed to provide a separation distance of at least 20 cm from all persons and must not be co-located or operating in conjunction with any other antenna or transmitter. End-users and installers must be provide with antenna installation instructions and transmitter operating conditions for satisfying RF exposure compliance.

Canadian Department of Communications Statement

This digital apparatus does not exceed the Class B limits for radio noise emissions from digital apparatus set out in the Radio Interference Regulations of the Canadian Department of Communications.

This class B digital apparatus complies with Canadian ICES-003.

IC Radiation Exposure Statement for Canada

This equipment complies with IC radiation exposure limits set forth for an uncontrolled environment. To maintain compliance with IC RF exposure compliance requirements, please avoid direct contact to the transmitting antenna during transmitting. End users must follow the specific operating instructions for satisfying RF exposure compliance.

Operation is subject to the following two conditions:

- This device may not cause interference and
- This device must accept any interference, including interference that may cause undesired operation of the device.

Declaration of Conformity (R&TTE directive 1999/5/EC)

The following items were completed and are considered relevant and sufficient:

- Essential requirements as in [Article 3]
- Protection requirements for health and safety as in [Article 3.1a]
- Testing for electric safety according to [EN 60950]
- Protection requirements for electromagnetic compatibility in [Article 3.1b]
- Testing for electromagnetic compatibility in [EN 301 489-1] & [EN 301 489-17]
- Effective use of the radio spectrum as in [Article 3.2]
- Radio test suites according to [EN 300 328-2]

CE Mark Warning

This is a Class B product, in a domestic environment, this product may cause radio interference, in which case the user may be required to take adequate measures.



CE marking for devices without wireless LAN/Bluetooth

The shipped version of this device complies with the requirements of the EEC directives 2004/108/EC "Electromagnetic compatibility" and 2006/95/EC "Low voltage directive".



CE marking for devices with wireless LAN/ Bluetooth

This equipment complies with the requirements of Directive 1999/5/EC of the European Parliament and Commission from 9 March, 1999 governing Radio and Telecommunications Equipment and mutual recognition of conformity.

Wireless Operation Channel for Different Domains

N. America	2.412-2.462 GHz	Ch01 through CH11
Japan	2.412-2.484 GHz	Ch01 through Ch14
Europe ETSI	2.412-2.472 GHz	Ch01 through Ch13

France Restricted Wireless Frequency Bands

Some areas of France have a restricted frequency band. The worst case maximum authorized power indoors are:

- 10mW for the entire 2.4 GHz band (2400 MHz–2483.5 MHz)
- 100mW for frequencies between 2446.5 MHz and 2483.5 MHz



Channels 10 through 13 inclusive operate in the band 2446.6 MHz to 2483.5 MHz.

There are few possibilities for outdoor use: On private property or on the private property of public persons, use is subject to a preliminary authorization procedure by the Ministry of Defense, with maximum authorized power of 100mW in the 2446.5–2483.5 MHz band. Use outdoors on public property is not permitted.

In the departments listed below, for the entire 2.4 GHz band:

- Maximum authorized power indoors is 100mW
- Maximum authorized power outdoors is 10mW

Departments in which the use of the 2400–2483.5 MHz band is permitted with an EIRP of less than 100mW indoors and less than 10mW outdoors:

01 Ain	02 Aisne	03 Allier	05 Hautes Alpes	
08 Ardennes	09 Ariège	11 Aude	12 Aveyron	16 Charente
24 Dordogne	25 Doubs	26 Drôme	32 Gers	36 Indre
37 Indre et Loire	41 Loir et Cher	45 Loiret	50 Manche	55 Meuse
58 Nièvre	59 Nord	60 Oise	61 Orne	63 Puy du Dôme
64 Pyrénées Atlantique	66 Pyrénées Orientales	67 Bas Rhin	68 Haut Rhin	
70 Haute Saône	71 Saône et Loire	75 Paris	82 Tarn et Garonne	
84 Vaucluse	88 Vosges	89 Yonne		
90 Territoire de Belfort	94 Val de Marne			

This requirement is likely to change over time, allowing you to use your wireless LAN card in more areas within France. Please check with ART for the latest information (www.art-telecom.fr)



Your WLAN Card transmits less than 100mW, but more than 10mW.

NO DISASSEMBLY

The warranty does not apply to the products that have been disassembled by users

Lithium-Ion Battery Warning

CAUTION: Danger of explosion if battery is incorrectly replaced. Replace only with the same or equivalent type recommended by the manufacturer. Dispose of used batteries according to the manufacturer's instructions.

No Exposure to Liquids

DO NOT expose to or use near liquids, rain, or moisture. This product is not waterproof or oil-proof.



This symbol of the crossed out wheeled bin indicates that the product (electrical, electronic equipment, and mercury-containing button cell battery) should not be placed in municipal waste. Check local regulations for disposal of electronic products.



DO NOT throw the battery in municipal waste. The symbol of the crossed out wheeled bin indicates that the battery should not be placed in municipal waste.

REACH

Complying with the REACH (Registration, Evaluation, Authorization, and Restriction of Chemicals) regulatory framework, we publish the chemical substances in our products at ASUS REACH website at <http://csr.asus.com/english/REACH.htm>.

Global Environmental Regulation Compliance and Declaration

ASUS follows the green design concept to design and manufacture our products, and makes sure that each stage of the product life cycle of ASUS product is in line with global environmental regulations. In addition, ASUS disclose the relevant information based on regulation requirements.

Please refer to <http://csr.asus.com/english/Compliance.htm> for information disclosure based on regulation requirements ASUS is complied with:

Japan JIS-C-0950 Material Declarations

EU REACH SVHC

Korea RoHS

Swiss Energy Laws

ASUS Recycling/Takeback Services

ASUS recycling and takeback programs come from our commitment to the highest standards for protecting our environment. We believe in providing solutions for you to be able to responsibly recycle our products, batteries, other components as well as the packaging materials. Please go to <http://csr.asus.com/english/Takeback.htm> for detailed recycling information in different regions.

UL Safety Precaution

To meet safety requirements, the All-in-one PC must be mounted to a bracket which guarantees the necessary stability considering the weight of the All-in-one PC. The All-in-one PC shall only be mounted and used with UL listed mounting adapters and brackets (e.g. VESA).

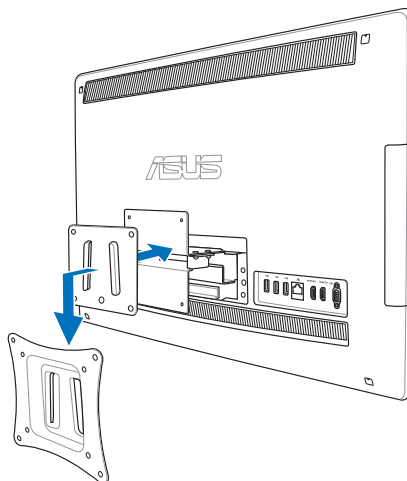

ENERGY STAR complied product



ENERGY STAR is a joint program of the U.S. Environmental Protection Agency and the U.S. Department of Energy helping us all save money and protect the environment through energy efficient products and practices.

All ASUS products with the ENERGY STAR logo comply with the ENERGY STAR standard, and the power management feature is enabled by default. The monitor and computer are automatically set to sleep after 15 and 30 minutes of user inactivity. To wake your computer, click the mouse or press any key on the keyboard.

Please visit <http://www.energy.gov/powermanagement> for detail information on power management and its benefits to the environment. In addition, please visit <http://www.energystar.gov> for detail information on the ENERGY STAR joint program.



ENERGY STAR is NOT supported on Freedos and Linux-based products.

Notes for this manual

To ensure that you perform certain tasks properly, take note of the following symbols used throughout this manual.



WARNING: Vital information that you MUST follow to prevent injury to yourself.



IMPORTANT: Instructions that you MUST follow to complete a task.



TIP: Tips and useful information that help you complete a task.



NOTE: Additional information for special situations.

All illustrations and screenshots in this manual are for reference only. Actual product specifications and software screen images may vary with territories. Visit the ASUS website at www.asus.com for the latest information.

Safety information

Your All-in-one PC ET2411/ ET2210 Series is designed and tested to meet the latest standards of safety for information technology equipment. However, to ensure your safety, it is important that you read the following safety instructions.

Setting up your system

- Read and follow all instructions in the documentation before you operate your system.
- Do not use this product near water or a heated source such as a radiator.
- Set up the system on a stable surface.
- Openings on the chassis are for ventilation. Do not block or cover these openings. Ensure that you leave plenty of space around the system for ventilation. Never insert objects of any kind into the ventilation openings.
- Use this product in environments with ambient temperatures between 0°C and 40°C.
- If you use an extension cord, ensure that the total ampere rating of the devices plugged into the extension cord does not exceed its ampere rating.

Care during use

- Do not walk on the power cord or allow anything to rest on it.
- Do not spill water or any other liquids on your system.
- When the system is turned off, a small amount of electrical current still flows. Always unplug all power, modem, and network cables from the power outlets before cleaning the system.
- The touch screen requires periodic cleaning to achieve the best touch sensitivity. Keep the screen clean from foreign objects or excessive dust accumulation. To clean the screen:
 - Turn off the system and disconnect the power cord from the wall.
 - Spray a small amount of a household glass cleaner onto the supplied cleaning cloth and gently wipe the screen surface.
 - Do not spray the cleaner directly on the screen.
 - Do not use an abrasive cleaner or a coarse cloth when cleaning the screen.
- If you encounter the following technical problems with the product, unplug the power cord and contact a qualified service technician or your retailer.
 - The power cord or plug is damaged.
 - Liquid has been spilled into the system.
 - The system does not function properly even if you follow the operating instructions.
 - The system was dropped or the cabinet is damaged.
 - The system performance changes.

Sound Pressure Warning

Excessive sound pressure from earphones or headphones can cause hearing damage or loss. Adjustment of the volume control as well as the equalizer to settings other than the center position may increase the earphones or headphones output voltage and the sound pressure level.

TV Tuner (on selected models)

Note to CATV System Installer—This reminder is provided to call the CATV systems installer's attention to Section 820-93 of the National Electric Code, which provides guidelines for proper grounding and, in particular, specify that the Coaxial cable shield be connected to the grounding system of the building as close to the point of cable entry as practical.

Adapter

1. Adapter information (varies with models)
 - a. Input voltage: 100–240Vac
Input frequency: 50–60Hz
Rating output current: 150W (19.5V, 7.7A; 19V, 7.9A)
Rating output voltage: 19Vdc
 - b. Input voltage: 100–240Vac
Input frequency: 50–60Hz
Rating output current: 135W (19V, 7.1A)
Rating output voltage: 19Vdc
 - c. Input voltage: 100–240Vac
Input frequency: 50–60Hz
Rating output current: 120W (19V, 6.32A)
Rating output voltage: 19Vdc
2. The socket outlet must be near to the unit and easily accessible.



DC Fan Warning

Please note that the DC fan is a moving part that may cause DANGER. Ensure to keep your body from the moving fan blades.

Welcome

Congratulations on your purchase of All-in-one PC ET2411/ ET2210 Series. The following illustrations display the package contents of your new product. If any of the following items is damaged or missing, contact your retailer.

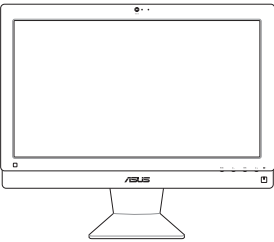
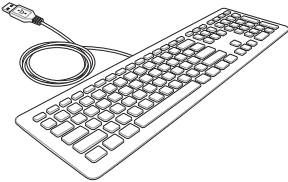
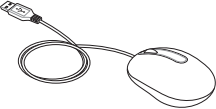
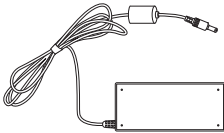
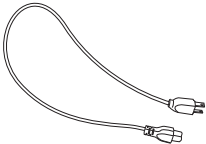
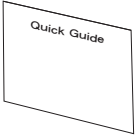
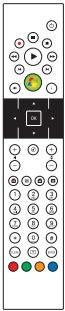
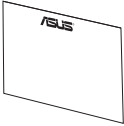
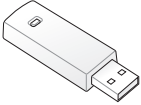
Package contents





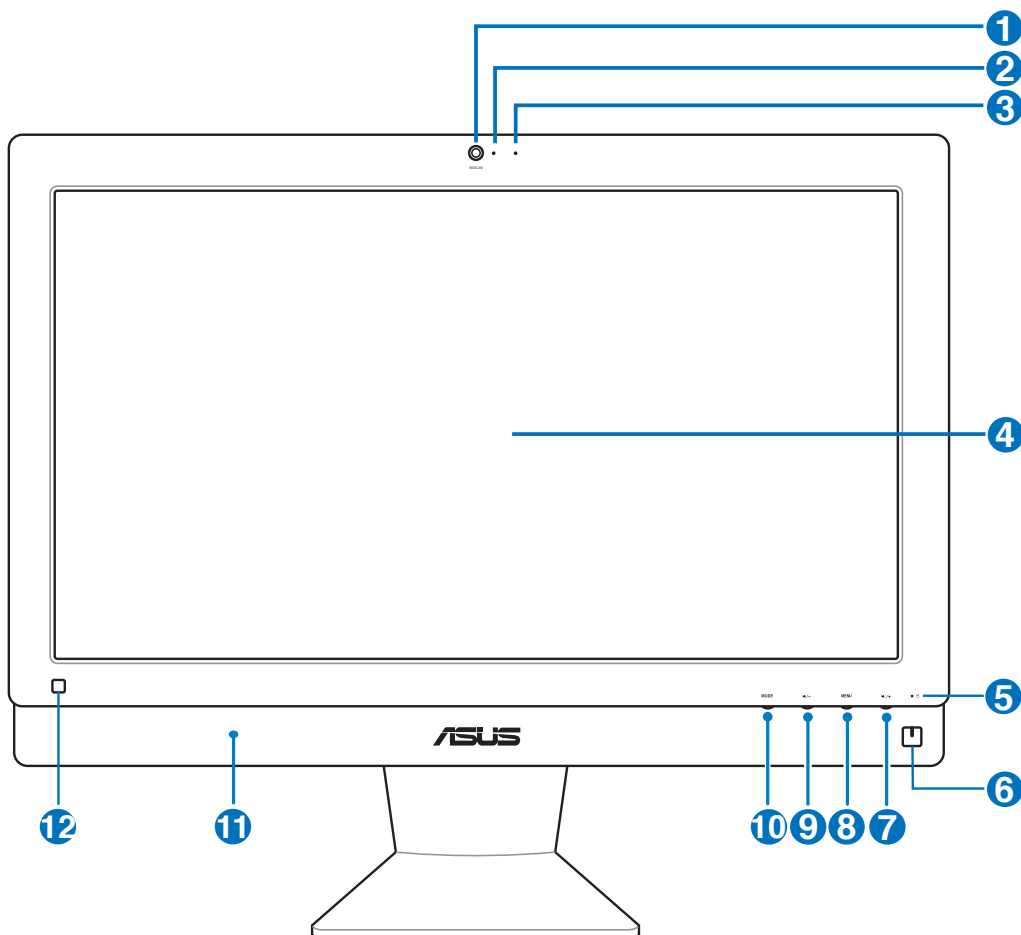

		
All-in-one PC ET2411/ ET2210 Series	Keyboard (wired or wireless)	Mouse (wired or wireless)
		
AC adapter	Power cord	Quick Start Guide
		
	Warranty Card	KBM USB receiver dongle (optional)
		Note: The keyboard, mouse, power supply, remote control, and KBM USB receiver dongle illustrations are for reference only. Actual product specifications may vary with territories.
Remote Control (optional)	Subwoofer (optional)	

Getting to know your All-in-one PC

Front view

Refer to the following diagram to identify the components on this side of the system.



- 1 Webcam**
The built-in webcam with the built-in digital microphone allows you to start video chats online.
- 2 Webcam LED**
Indicates that the built-in webcam is enabled.
- 3  Digital Microphone (Built-in)**
The built-in digital microphone can be used for video conferencing, voice narrations, audio recordings, and multimedia applications.
- 4 LCD display (Touch-enabled function on selected models)**
The LCD display features optimal resolution. Touch-enabled models bring digital life to your fingertips.
- 5  Hard Disk Drive LED**
Indicates hard disk drive activity.
- 6  Power switch**
The power switch allows you to switch the system ON/OFF.
- 7  Volume Increase Button**
Press this button to increase the volume.
- 8 MENU Button**
Press to display the menu. Press this button to enter/select the highlighted icon (function) while the OSD is activated.
- 9  Volume decrease Button**
Press this button to decrease the volume.
- 10 MODE Button**
Press to switch the display signal source. When switched to HDMI-in and VGA-in, the All-in-one PC can be used as a standard desktop LCD monitor.
- 11  Audio Speaker**
The built-in stereo speaker system allows you to hear audio without additional attachments. The multimedia sound system features an integrated digital audio controller that produces rich, vibrant sound. (Results improve with external stereo headphones or speakers.) Audio features are software controlled.
- 12 Remote Receiver**
Use the optional remote control to send infrared signals through the remote receiver to control the All-in-one PC.

Rear view

Refer to the following diagram to identify the components on this side of the system.

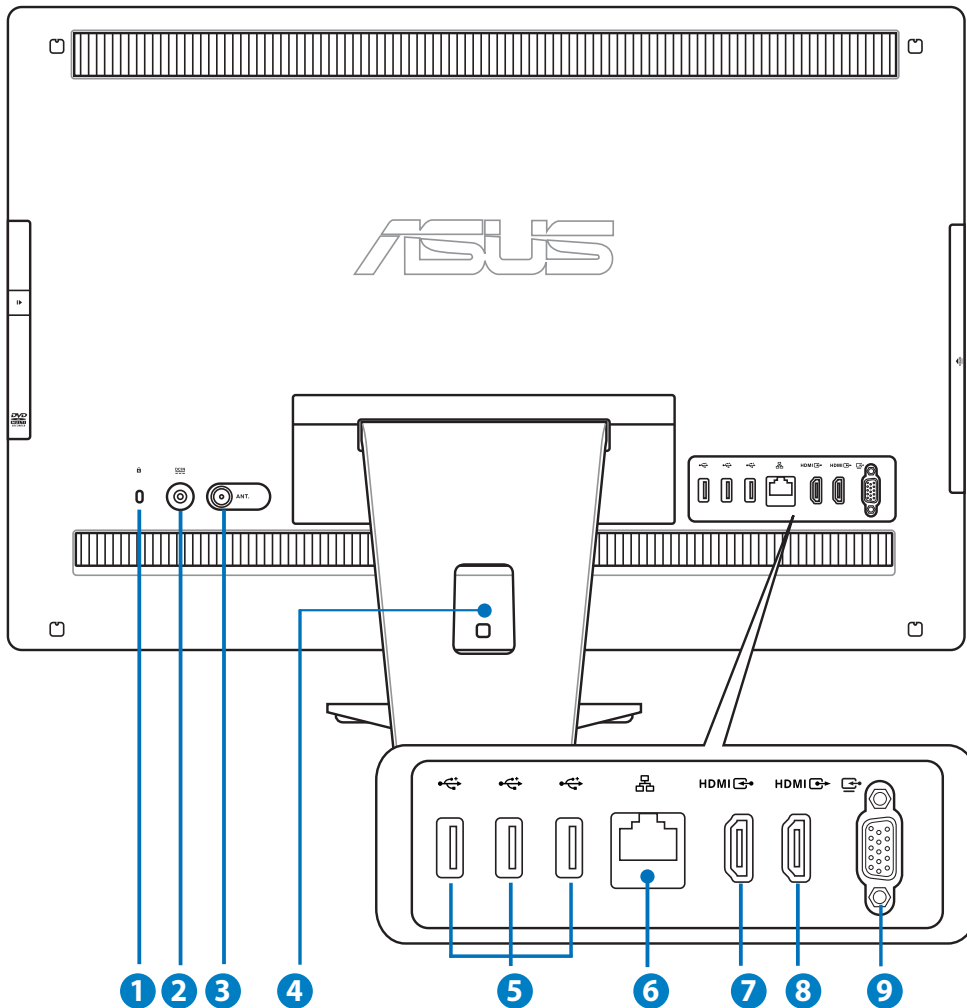

1 Kensington® Lock port

The Kensington® lock port allows the computer to be secured using Kensington® compatible security products. These security products usually include a metal cable and lock that prevent the computer to be removed from a fixed object.

2  **Power input (DC 19V/ 19.5V)**

The supplied power adapter converts AC power to DC power for use with this jack. Power supplied through this jack supplies power to the PC. To prevent damage to the PC, always use the supplied power adapter.



The power adapter may become warm or hot when in use. Do not cover the adapter and keep it away from your body.

3 **Antenna Input (on selected models)**

The antenna input is for TV frequency signal and allows for use with the digital TV antenna or input from subscription television services. The antenna can receive digital TV. Cable service connection can receive digital TV, analog TV, depending on paid services.

4 **Cable Holder**

Gather all the cables with this cable holder.

5  **USB 2.0 port**

The Universal Serial Bus (USB) port is compatible with USB devices such as keyboards, mouse devices, cameras, and hard disk drives.

6  **LAN port**

The eight-pin RJ-45 LAN port supports a standard Ethernet cable for connection to a local network.

7 **HDMI Input Port**

HDMI (High-Definition Multimedia Interface) is an uncompressed all-digital audio/video interface between any audio/video source, such as set-top box or DVD player.

8 **HDMI Output Port**

Please connect this port with devices equipped with HDMI input port, such as LCD monitor or projector.

9  **Display (Monitor) Input (on selected models)**

The display input port supports a standard VGA cable and helps turn your All-in-one PC into a larger display for your Notebook PC or other devices.

Side views

Refer to the following diagrams to identify the components on both sides of the system.

1  **USB 3.0/ 2.0 port (vary by model)**

The Universal Serial Bus (USB) port is compatible with USB devices such as keyboards, mouse devices, cameras, and hard disk drives.

2 **E-SATA + USB 2.0 Combo**

This port connects to an external Serial-ATA hard disk drive.



DO NOT insert a different connector to the external SATA port.

3  **Memory card reader**

This All-in-one PC has a built-in memory card reader that supports SD cards used in devices like digital cameras, MP3 players, mobile phones, and PDAs.

4  **Headphone jack**

The stereo headphone jack (3.5mm) is used to connect the system's audio out signal to headphones. Using this jack automatically disables the built-in speakers.

5  **Microphone jack**

The microphone jack is designed to connect to a microphone used for video conferencing, voice narrations, or simple audio recordings.

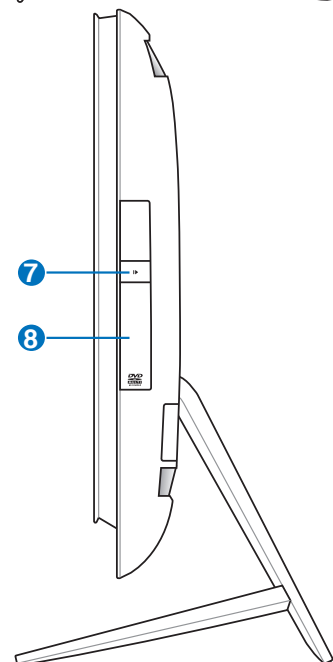
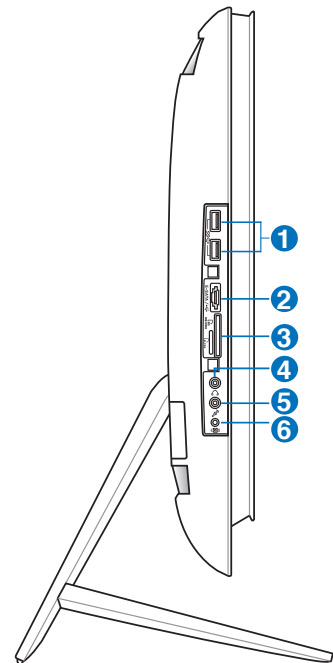

6 **Subwoofer jack (on selected models)**

The proprietary subwoofer jack is used to connect to the ASUS All-in-one PC subwoofer. The subwoofer allows you to enjoy vibrant bass (low frequency) sounds in your multimedia applications.



The subwoofer jack can ONLY be connected to All-in-one PC subwoofers or sound devices by ASUS. DO NOT connect other devices to this jack. Doing so may damage the device.

7 **Optical Drive Electronic Eject**

The optical drive eject has an electronic eject button for opening the tray. You can also eject the optical drive tray through any software player or by right clicking the optical drive in Windows "Computer" and selecting Eject.

8 **Optical Drive**

The built-in optical drive may support compact discs (CD) and/or digital video discs (DVD), and may have recordable (R) or re-writable (RW) capabilities. See the marketing specifications for details on each model.

Using the touch screen

All-in-one PC brings digital life to your fingertips. With a few touches, you can make All-in-one PC work at your command. Your touch functions like a mouse device:

- Touch = left-click on the mouse
- Touch and hold = right-click on the mouse



The touch-enabled screen is available on selected models.

Showing the touch pointer

The touch pointer, or virtual mouse, helps you use the touch-enabled screen more conveniently. To show the touch pointer

1. From the Windows® desktop, click **Start** > **Control Panel** > **View Devices and Printer**.

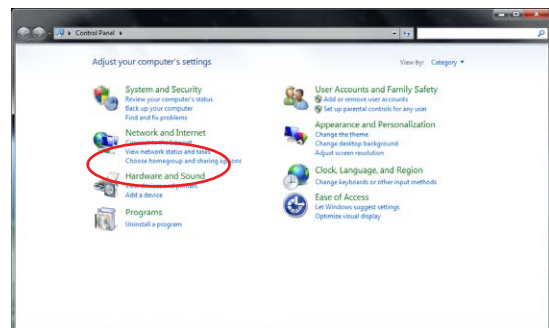

- Click **Change touch input settings**.

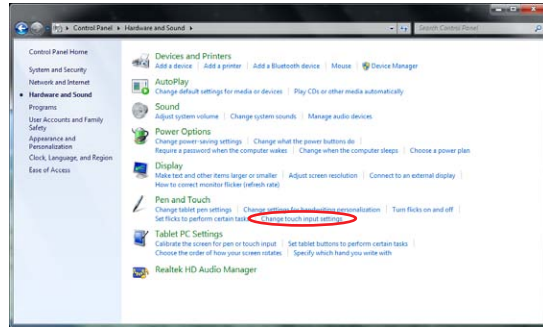

- Click the **Touch** tab on the top and click the box before **Show the touch pointer when I'm interacting with items on the screen**. Click **OK** to finish the configuration.
- You will see a virtual mouse on the screen when you touch the screen.

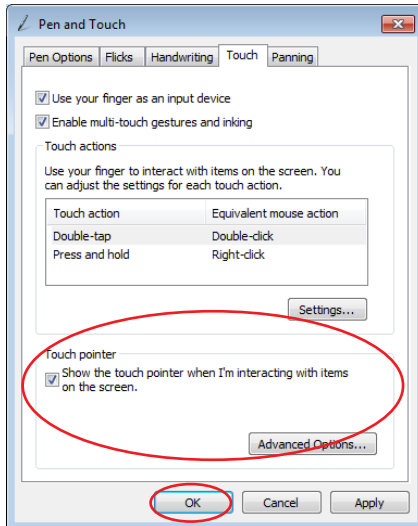

Cleaning the touch screen

The touch screen requires periodic cleaning to achieve the best touch sensitivity. Keep the screen clean from foreign objects or excessive dust accumulation. To clean the screen:

- Turn off the system and disconnect the power cord from the wall.
- Spray a small amount of a household glass cleaner onto the supplied cleaning cloth and gently wipe the screen surface.
- Do not spray the cleaner directly on the screen.
- Do not use an abrasive cleaner or a coarse cloth when cleaning the screen.

Positioning your All-in-one PC

Placing on the desktop

Place your All-in-one PC on a flat surface such as a table or desk by setting the stand on the platform. Tilt the display panel to an angle between 5 degrees forward to 20 degrees backwards from an upright position for visual comfort.



Avoid tilting hazards and potential breakage by tilting the display panel within the given range.

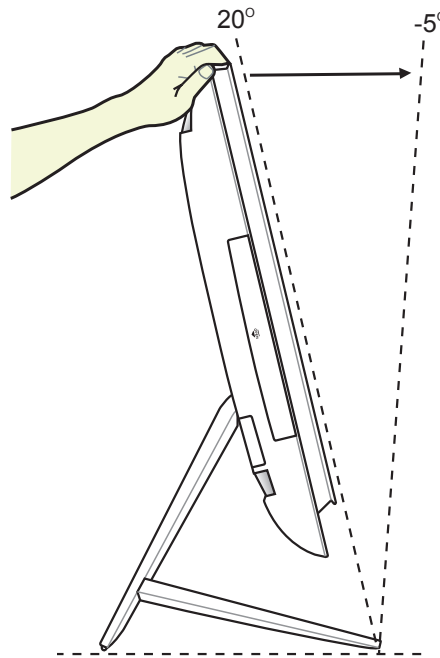

Mounting to the wall

To mount your All-in-one PC to the wall, purchase an optional wall mount adapter and a wall mount kit (VESA100 with pad and bracket). Install the wall mount components according to the following instructions.

1. To release the stand, place the All-in-one PC face-down first, resting the display panel on a flat even surface. Lift the stand upwards. Take off the back hatch by pressing and lifting the clips.

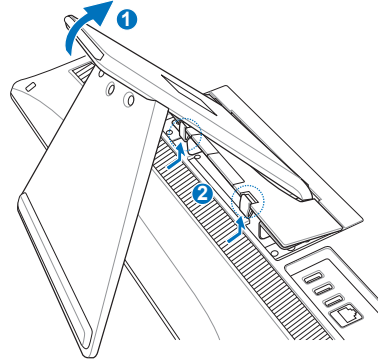

2. Moving the stand again, press it downwards. You can set the All-in-one PC near the edge of the flat surface to ensure that the stand goes all the way down. Remove the four screws on the stand and save for future reinstallation. Take out the stand and put it aside.

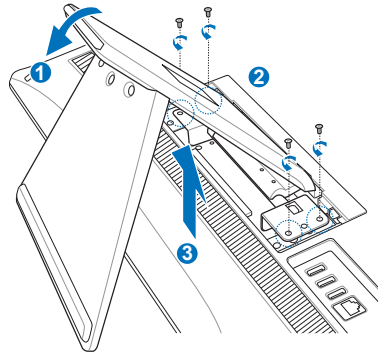

3. Align the wall mount adapter to the holes at the back of the All-in-one PC and secure it with the four screws (M4 x 7L) provided.

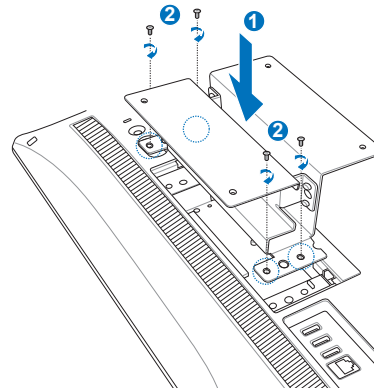
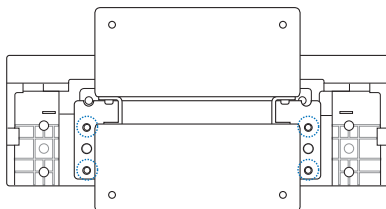

- Secure the wall mount pad to the adapter with the four screws (M3 x 8L) that came with the kit, noting the correct orientation.

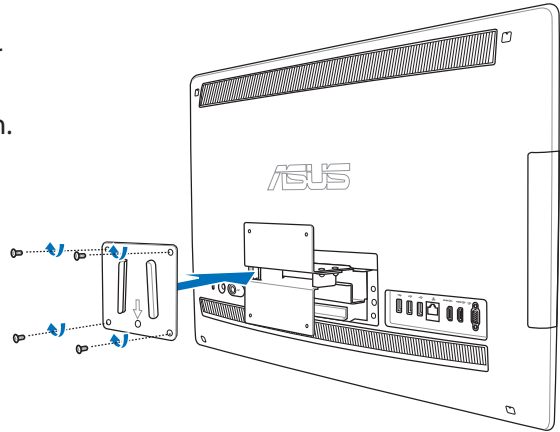

- By following the instructions in the installation manual that came with your wall mount kit (VESA100), fasten the wall mount bracket to the wall using the four screws (M4 x 10L) provided in the kit. Upright your All-in-one PC and hook it on to the wall by sliding the grooves of the wall mount pad into the bracket.



The wall mount kit in this illustration is for reference only.

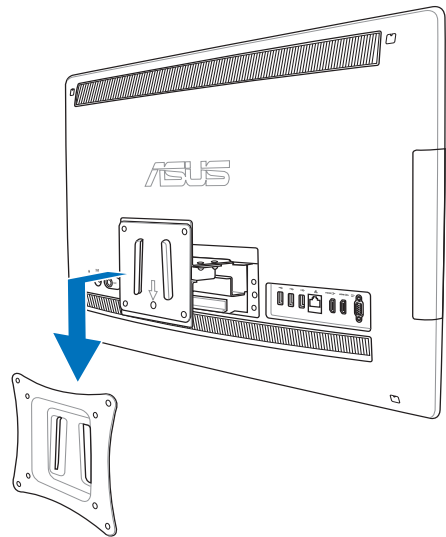

- For machine ventilation, be sure to leave a distance of at least 6cm between the All-in-one PC and the wall.
- The wall mount kit should comply with VESA standards.
- To ensure safety, please read the wall mount kit installation manual carefully before mounting your All-in-one PC to the wall.
- At least two persons are required to install or remove the All-in-one PC onto and from the wall to avoid hazard of falling objects and breakage. Qualified personnel is recommended.
- The wall should be able to sustain four times the weight of the All-in-on PC and wall mount components combined (40kg at least). The mounting location must be able to withstand earthquake or other impacts. Cement or masonry walls recommended.

Setting up your All-in-one PC

Connecting the wired keyboard and mouse

Connect the keyboard **1** and the mouse **2** to the **USB** port on the rear panel. You may also connect the keyboard and mouse to the **USB** port on the left side of the panel if the keyboard cable is not long enough.

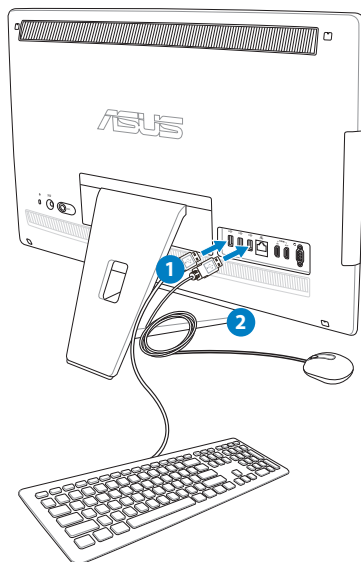

Connecting the wireless keyboard and mouse

1. Install batteries to the wireless keyboard and mouse.
2. Plug the wireless dongle for keyboard and mouse to a USB port.
3. Push the buttons at the back of both the keyboard and mouse to connect with the All-in-one PC.
4. You can begin using the wireless keyboard and mouse.

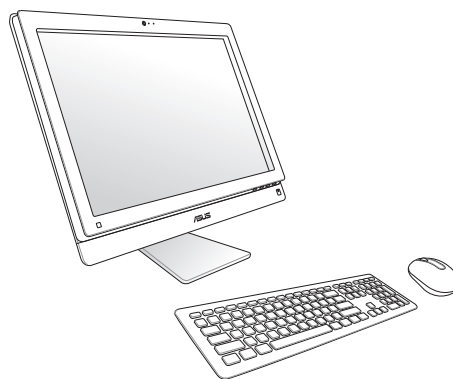

1. Simply reconnect if the wireless keyboard and mouse lose connection. Avoid other nearby WiFi devices at least 20 cm as they may interfere with the connection.
2. The illustrations above are for reference only. Actual appearances and specifications (wired or wireless) of the keyboard and mouse may vary by territory.

Powering on the system

Connect the supplied AC adapter to the **DC IN** jack on the rear panel (1 2 3) and then press the **Power switch** on the right (4) to turn on the system.

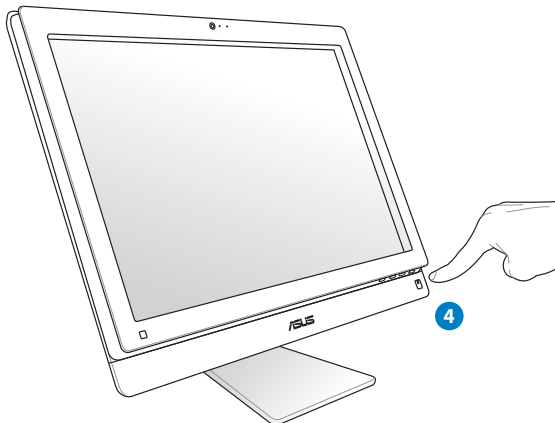
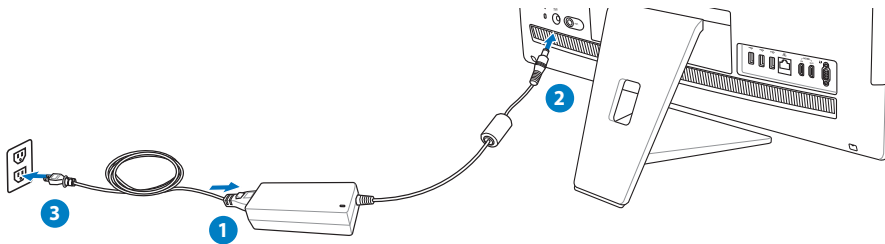

WARNING! DO NOT connect the AC power cord to an AC outlet prior to connecting the DC plug to the system. Doing so may damage the AC-DC adapter.

Powering off

- To put the system into suspend mode, press the **Power switch**  on the right. To bring the system back to the OS, press the **Power switch** again, click the mouse, touch the display or press any key on the keyboard.
- To shut down the system completely, follow the normal Windows shutdown process.

Configuring a wireless connection

1. Click the wireless network icon with an orange star  in the Windows® Notification area.
2. Select the wireless access point you want to connect to from the list and click **Connect** to build the connection.



If you cannot find the desired access point, click the **Refresh** icon  on the upper right corner to refresh and search in the list again.



Enter the network security key when connecting to a security-enabled network.

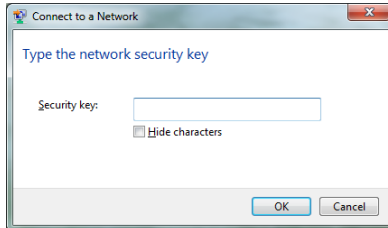

3. After a connection has been established, the connection is shown on the list.
4. You can see the wireless network icon  in the Notification area.

Configuring a wired connection

Using a static IP

1. Click the network icon with a yellow warning triangle  in the Windows® Notification area and select **Open Network and Sharing Center**.



Ensure that you have connected the LAN cable to the All-in-one PC.

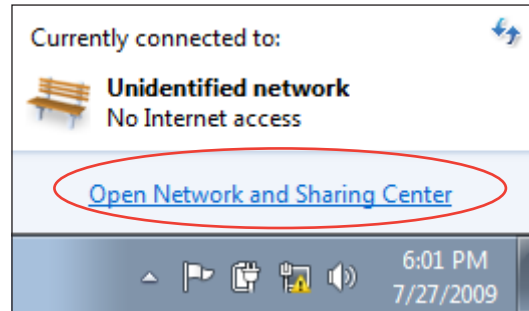

2. Click **Change adapter settings** in the left panel.

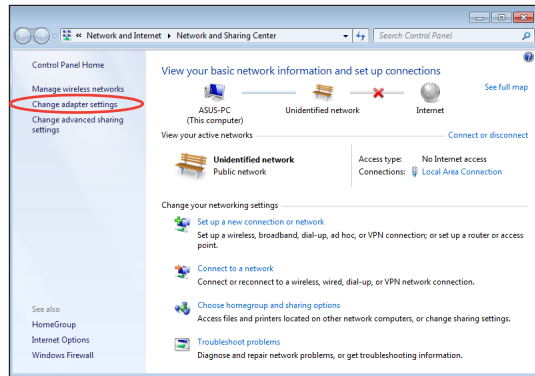

3. Right-click **Local Area Connection** and select **Properties**.

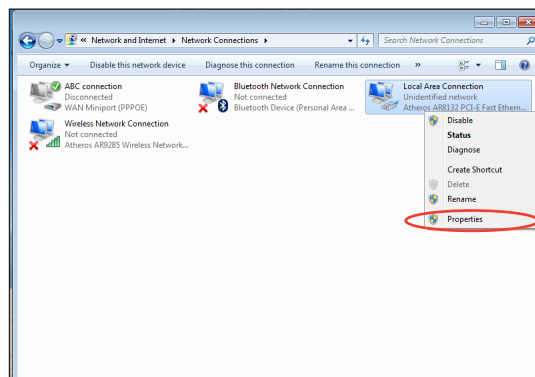

- Click **Internet Protocol Version 4(TCP/IPv4)** and click **Properties**.

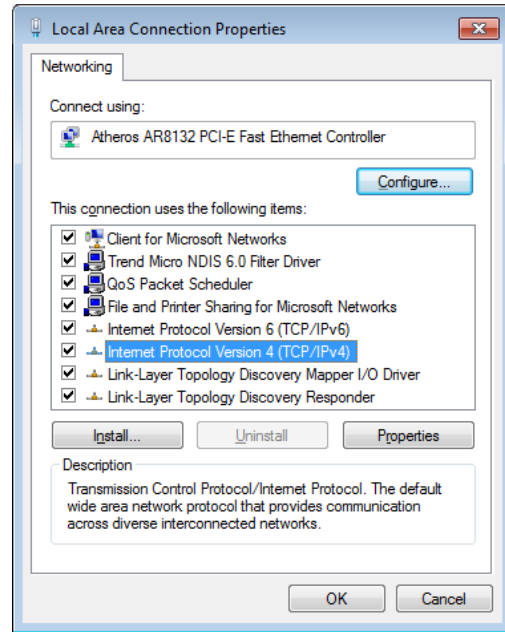

- Select **Use the following IP address**.
- Enter your **IP address**, **Subnet mask**, and **Default gateway**.
- If needed, enter the **Preferred DNS server** address.
- After entering all the related values, click **OK** to finish the configuration.

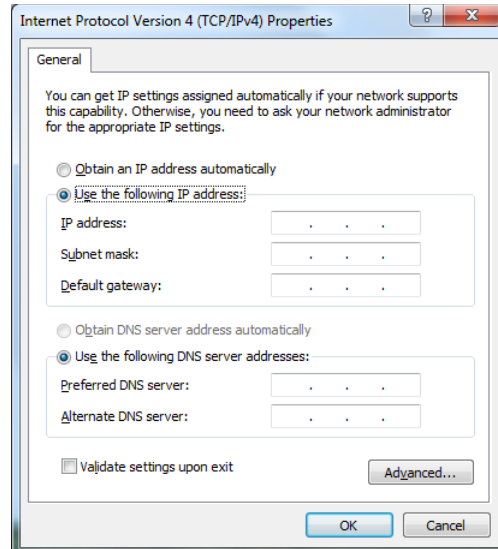

Using a dynamic IP (PPPoE)

1. Repeat steps 1–4 in the previous section.
2. Select **Obtain an IP address automatically** and click **OK**.

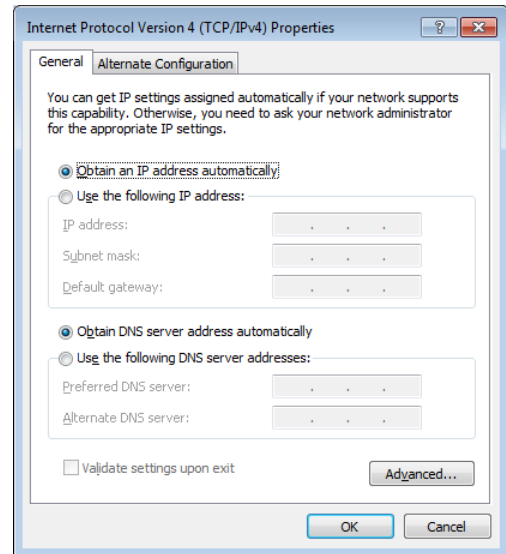

(Continue the following steps if using PPPoE)

3. Return to the **Network and Sharing Center** and then click **Set up a new connection or network**.

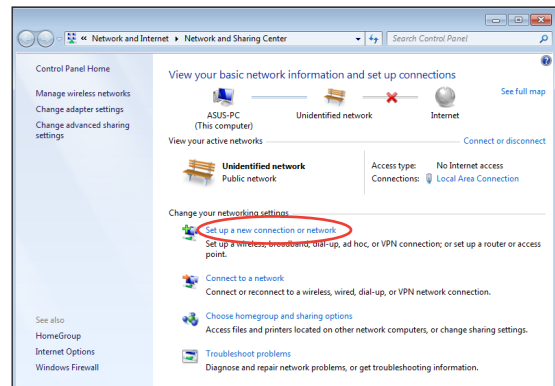

4. Select **Connect to the Internet** and click **Next**.

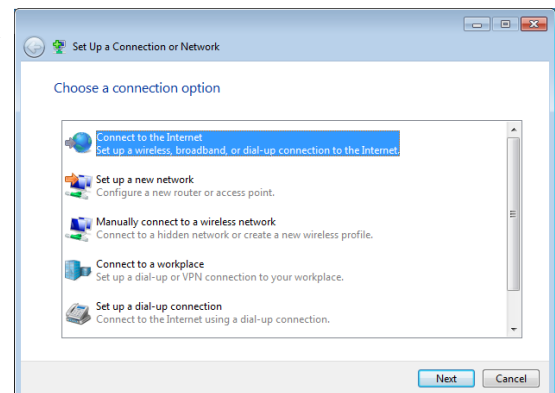

5. Select **Broadband (PPPoE)** and click **Next**.

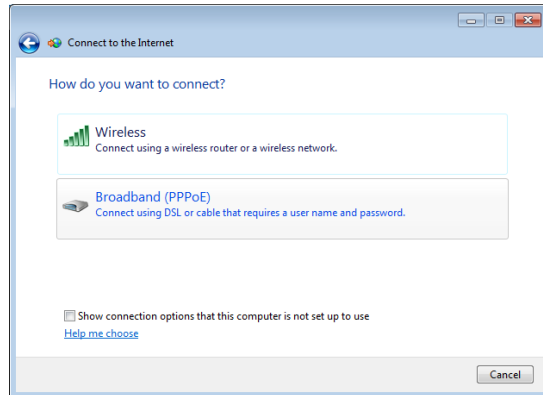

6. Enter User name, Password, and Connection name. Click **Connect**.

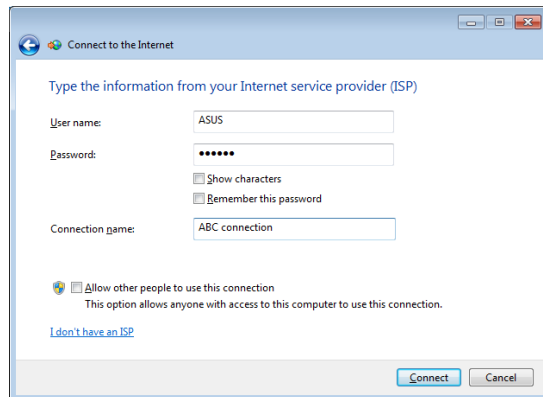

7. Click **Close** to finish the configuration.

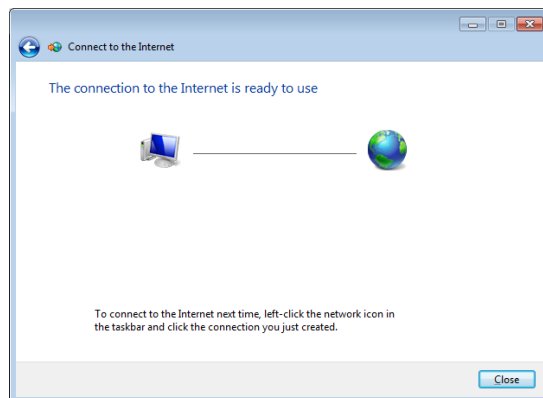

8. Click the network icon in the notification area and click the connection you just created.

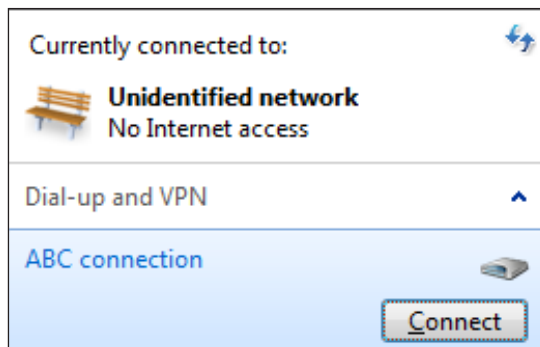

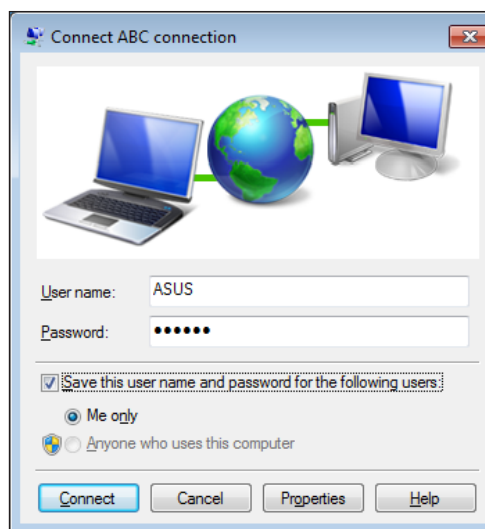

9. Enter your user name and password. Click **Connect** to connect to the Internet.



Connecting to external audio devices

In addition to built-in stereo speakers (2-channel, left-right speakers), All-in-one PC allows you to use external audio devices. Refer to the table below for the audio jacks on the left panel and their functions.

Audio jack	Description
	Audio Out; Connects to headphones.
	Mic In; Connects to microphone
	Connects to ASUS All-in-one PC subwoofer (optional)



The subwoofer jack can ONLY be connected to All-in-one PC subwoofers or sound devices by ASUS. DO NOT connect other devices to this jack. Doing so may damage the device.

Configuring audio output settings

After connecting a speaker system to your All-in-one PC, follow the steps below to configure the speaker settings:

1. Right-click the speaker icon in the Windows® notification area and click **Sounds**.

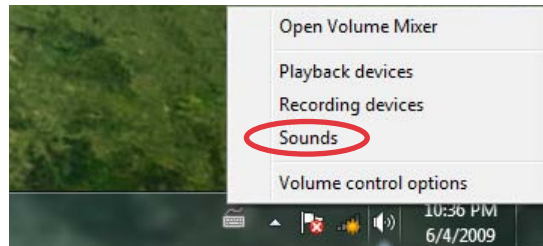

2. Select a playback device and click **Properties** to configure the settings.

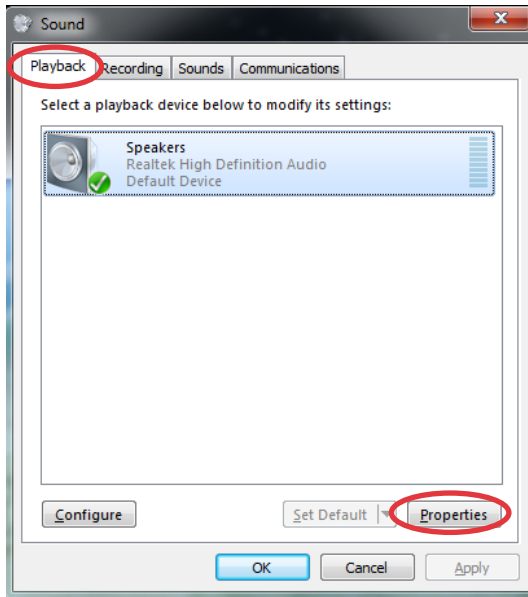

3. Do the advanced configurations, such as adjusting the speaker level and output rate. Click **OK** to finish the configurations.

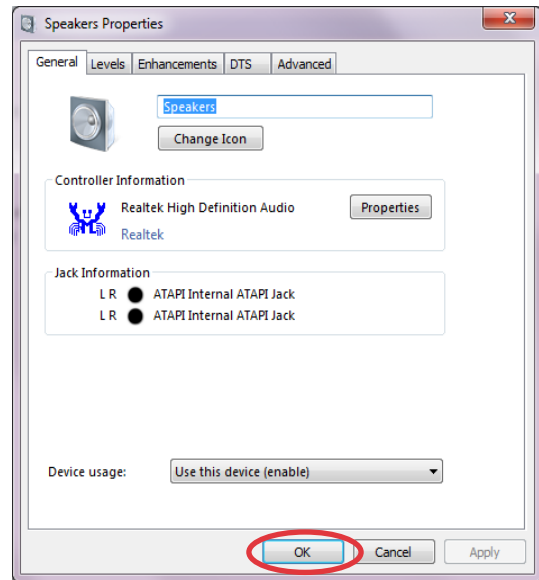

Recovering your system

Using the recovery partition

The recovery partition includes an image of the operating system, drivers, and utilities installed on your system at the factory. The recovery partition provides a comprehensive recovery solution that quickly restores your system's software to its original working state, provided that your hard disk drive is in good working order. Before using the recovery partition, copy your data files (such as Outlook PST files) to a USB device or to a network drive and make note of any customized configuration settings (such as network settings).

Recovering the OS to the Factory Default Partition (F9 Recovery)

1. Press [F9] during bootup.
2. Select **Windows setup [EMS Enabled]** when this item appears and press [Enter].
3. Select the language and click **Next**.
4. Select **Recover the OS to the Default Partition** and click **Next**.
5. The factory default partition will be displayed. Click **Next**.
6. Data on the default partition will be cleared. Click **Recover** to start the system recovery.



You will lose all your data on the selected partition. Ensure to back up your important data beforehand.

7. When the recovery is completed successfully, click **Reboot** to restart the system.

Backing up the Factory Default Environment Data to a USB Drive (F9 Backup)

1. Repeat steps 1—3 in the previous section.
2. Select **Backup the Factory Environment to a USB Drive** and click **Next**.
3. Connect a USB storage device to your PC to start the Factory Default Environment backup.



The required size of the connected USB storage device should be larger than 20GB. The actual size may vary with your PC model.

4. Select a desired USB storage device if more than one USB storage device is connected to your All-in-one PC and click **Next**.



If there is already a partition with proper size in the selected USB storage device (for example, a partition that has been used as the backup partition), the system will show this partition automatically and reuse it for backup.

- Based on the different situations in the previous step, data on the selected USB storage device or on the selected partition will be cleared. Click **Backup** to start backup.



You will lose all your data on the selected USB storage device or on the selected partition. Ensure to back up your important data beforehand.

- When backing up the factory default environment is completed successfully, click **Reboot** to restart the system.

Using the USB storage device (USB Restore)

When the Recovery Partition in your system is crashed, use the USB storage device to restore the system to the factory default partition or the factory environment data to the entire hard disk.

- Connect the USB storage device that you back up the factory environment data to.
- Press <ESC> on bootup and the **Please select boot device** screen appears. Select USB: XXXXXX to boot from the connected USB storage device.
- Select the language and click **Next**.
- Select **Restore** and click **Next**.
- Select a task and click **Next**. Task options:

- **Restore the OS to the Default Partition only**

Select this option if you simply want to restore the OS to the factory default partition. This option deletes all data on the system partition "C" and keeps the partition "D" unchanged. After you click **Next**, the factory default partition will be displayed. Click **Next** again.

- **Restore the Whole Hard Disk**

Select this option if you want to restore your All-in-one PC to the factory default state. This option deletes all data from your hard disk and creates a new system partition as drive "C", an empty partition as drive "D" and a Recovery Partition.

- Data on the factory default partition or on the whole hard disk will be cleared depending on the option you selected in the previous step. Click **Restore** to start the task.
- When the restore is completed successfully, click **Reboot** to restart the system.

Manufacturer	ASUSTek COMPUTER INC.
Address, City	No. 150, LI-TE RD., PEITOU, TAIPEI 112, TAIWAN R.O.C
Country	TAIWAN
Authorized Representative in Europe	ASUS COMPUTER GmbH
Address, City	HARKORT STR. 21-23, 40880 RATINGEN
Country	GERMANY

Free Manuals Download Website

<http://myh66.com>

<http://usermanuals.us>

<http://www.somanuals.com>

<http://www.4manuals.cc>

<http://www.manual-lib.com>

<http://www.404manual.com>

<http://www.luxmanual.com>

<http://aubethermostatmanual.com>

Golf course search by state

<http://golfingnear.com>

Email search by domain

<http://emailbydomain.com>

Auto manuals search

<http://auto.somanuals.com>

TV manuals search

<http://tv.somanuals.com>