

**ASUS® P2-99**  
Pentium® III / II / Celeron™ Motherboard

**USER'S MANUAL**

# USER'S NOTICE

---

No part of this manual, including the products and software described in it, may be reproduced, transmitted, transcribed, stored in a retrieval system, or translated into any language in any form or by any means, except documentation kept by the purchaser for backup purposes, without the express written permission of ASUSTeK COMPUTER INC. ("ASUS").

ASUS PROVIDES THIS MANUAL "AS IS" WITHOUT WARRANTY OF ANY KIND, EITHER EXPRESS OR IMPLIED, INCLUDING BUT NOT LIMITED TO THE IMPLIED WARRANTIES OR CONDITIONS OF MERCHANTABILITY OR FITNESS FOR A PARTICULAR PURPOSE. IN NO EVENT SHALL ASUS, ITS DIRECTORS, OFFICERS, EMPLOYEES OR AGENTS BE LIABLE FOR ANY INDIRECT, SPECIAL, INCIDENTAL, OR CONSEQUENTIAL DAMAGES (INCLUDING DAMAGES FOR LOSS OF PROFITS, LOSS OF BUSINESS, LOSS OF USE OR DATA, INTERRUPTION OF BUSINESS AND THE LIKE), EVEN IF ASUS HAS BEEN ADVISED OF THE POSSIBILITY OF SUCH DAMAGES ARISING FROM ANY DEFECT OR ERROR IN THIS MANUAL OR PRODUCT.

Product warranty or service will not be extended if: (1) the product is repaired, modified or altered, unless such repair, modification or alteration is authorized in writing by ASUS; or (2) the serial number of the product is defaced or missing.

Products and corporate names appearing in this manual may or may not be registered trademarks or copyrights of their respective companies, and are used only for identification or explanation and to the owners' benefit, without intent to infringe.

- Intel, LANDesk, and Pentium are registered trademarks of Intel Corporation.
- Celeron is a registered trademark of Intel Corporation.
- IBM and OS/2 are registered trademarks of International Business Machines.
- Symbios is a registered trademark of Symbios Logic Corporation.
- Windows and MS-DOS are registered trademarks of Microsoft Corporation.
- Adobe and Acrobat are registered trademarks of Adobe Systems Incorporated.

The product name and revision number are both printed on the product itself. Manual revisions are released for each product design represented by the digit before and after the period of the manual revision number. Manual updates are represented by the third digit in the manual revision number.

For previous or updated manuals, BIOS, drivers, or product release information, contact ASUS at <http://www.asus.com.tw> or through any of the means indicated on the following page.

SPECIFICATIONS AND INFORMATION CONTAINED IN THIS MANUAL ARE FURNISHED FOR INFORMATIONAL USE ONLY, AND ARE SUBJECT TO CHANGE AT ANY TIME WITHOUT NOTICE, AND SHOULD NOT BE CONSTRUED AS A COMMITMENT BY ASUS. ASUS ASSUMES NO RESPONSIBILITY OR LIABILITY FOR ANY ERRORS OR INACCURACIES THAT MAY APPEAR IN THIS MANUAL, INCLUDING THE PRODUCTS AND SOFTWARE DESCRIBED IN IT.

**Copyright ©1999 ASUSTeK COMPUTER INC. All Rights Reserved.**

Product Name:	<b>ASUS P2-99</b>
Manual Revision:	<b>1.13 E408</b>
Release Date:	<b>June 1999</b>

# ASUS CONTACT INFORMATION

---

## ASUSTeK COMPUTER INC. (Asia-Pacific)

### *Marketing*

Address: 150 Li-Te Road, Peitou, Taipei, Taiwan 112  
Telephone: +886-2-2894-3447  
Fax: +886-2-2894-3449  
Email: info@asus.com.tw

### *Technical Support*

Tel (English): +886-2-2894-3447 ext. 706  
Tel (Chinese): +886-2-2894-3447 ext. 111  
Fax: +886-2-2895-9254  
Email: tsd@asus.com.tw  
Newsgroup: news2.asus.com.tw  
WWW: www.asus.com.tw  
FTP: ftp.asus.com.tw/pub/ASUS

## ASUS COMPUTER INTERNATIONAL (America)

### *Marketing*

Address: 6737 Mowry Avenue, Mowry Business Center, Building 2  
Newark, CA 94560, USA  
Fax: +1-510-608-4555  
Email: info-usa@asus.com.tw

### *Technical Support*

Fax: +1-510-608-4555  
BBS: +1-510-739-3774  
Email: tsd-usa@asus.com.tw  
WWW: www.asus.com  
FTP: ftp.asus.com.tw/pub/ASUS

## ASUS COMPUTER GmbH (Europe)

### *Marketing*

Address: Harkort Str. 25, 40880 Ratingen, BRD, Germany  
Telephone: 49-2102-445011  
Fax: 49-2102-442066  
Email: sales@asuscom.de

### *Technical Support*

Hotline: 49-2102-499712  
BBS: 49-2102-448690  
Email: tsd@asuscom.de  
WWW: www.asuscom.de  
FTP: ftp.asuscom.de/pub/ASUSCOM

# CONTENTS

---

<b>I. INTRODUCTION</b> .....	<b>7</b>
How this Manual is Organized .....	7
Item Checklist .....	7
<b>II. FEATURES</b> .....	<b>8</b>
Features of the ASUS P2-99 Motherboard .....	8
The ASUS P2-99 Motherboard .....	11
<b>III. HARDWARE SETUP</b> .....	<b>12</b>
Layout of the ASUS P2-99 Motherboard .....	12
Hardware Setup Steps .....	14
1. Motherboard Settings .....	14
Jumpers .....	14
2. System Memory (DIMM) .....	18
DIMM Memory Installation Procedures .....	19
3. Central Processing Unit (CPU) .....	21
Universal Retention Mechanism .....	21
Heatsinks .....	21
Installing the Processor .....	22
ASUS Smart Thermal Solutions .....	24
Recommended Heatsinks for Slot 1 Processors .....	25
4. Expansion Cards .....	26
Expansion Card Installation Procedure .....	26
Assigning IRQs for Expansion Cards .....	26
Assigning DMA Channels for ISA Cards .....	27
ISA Cards and Hardware Monitor .....	27
Accelerated Graphics Port (AGP) .....	27
5. External Connectors .....	28
Power Connection Procedures .....	37
<b>IV. BIOS SETUP</b> .....	<b>38</b>
Flash Memory Writer Utility .....	38
Main Menu .....	38
Managing and Updating Your Motherboard's BIOS .....	40
6. BIOS Setup .....	41
Load Defaults .....	42
Standard CMOS Setup .....	42
Details of Standard CMOS Setup .....	42
BIOS Features Setup .....	45
Details of BIOS Features Setup .....	45

# CONTENTS

---

Chipset Features Setup .....	48
Details of Chipset Features Setup .....	48
Power Management Setup .....	51
Details of Power Management Setup .....	51
PNP and PCI Setup .....	54
Details of PNP and PCI Setup .....	54
Load BIOS Defaults .....	56
Load Setup Defaults .....	56
Supervisor Password and User Password .....	57
IDE HDD Auto Detection .....	58
Save & Exit Setup .....	60
Exit Without Saving .....	60
<b>V. SOFTWARE SETUP .....</b>	<b>63</b>
Installing ASUS PC Probe (optional) .....	63
LDCM Local Setup (optional) .....	64
LDCM Administrator Setup (optional) .....	66
Uninstalling Programs .....	66
Installing Adobe Acrobat Reader (optional) .....	68
<b>VI. SOFTWARE REFERENCE .....</b>	<b>69</b>
ASUS PC Probe (optional) .....	69
Intel LANDesk Client Manager (optional) .....	72
Desktop Management Interface (DMI) .....	78
<b>VII. APPENDIX .....</b>	<b>81</b>
ASUS CIDB Chassis Intrusion Sensor Module .....	81
The ASUS S370 CPU Card .....	83
ASUS PCI-L101 Fast Ethernet Card .....	85
Glossary .....	87

# FCC & DOC COMPLIANCE

---

## ***Federal Communications Commission Statement***

This device complies with FCC Rules Part 15. Operation is subject to the following two conditions:

- This device may not cause harmful interference, and
- This device must accept any interference received, including interference that may cause undesired operation.

This equipment has been tested and found to comply with the limits for a Class B digital device, pursuant to Part 15 of the FCC Rules. These limits are designed to provide reasonable protection against harmful interference in a residential installation. This equipment generates, uses and can radiate radio frequency energy and, if not installed and used in accordance with manufacturer's instructions, may cause harmful interference to radio communications. However, there is no guarantee that interference will not occur in a particular installation. If this equipment does cause harmful interference to radio or television reception, which can be determined by turning the equipment off and on, the user is encouraged to try to correct the interference by one or more of the following measures:

- Re-orient or relocate the receiving antenna.
- Increase the separation between the equipment and receiver.
- Connect the equipment to an outlet on a circuit different from that to which the receiver is connected.
- Consult the dealer or an experienced radio/TV technician for help.

**WARNING!** The use of shielded cables for connection of the monitor to the graphics card is required to assure compliance with FCC regulations. Changes or modifications to this unit not expressly approved by the party responsible for compliance could void the user's authority to operate this equipment.

## ***Canadian Department of Communications Statement***

This digital apparatus does not exceed the Class B limits for radio noise emissions from digital apparatus set out in the Radio Interference Regulations of the Canadian Department of Communications.

**This Class B digital apparatus complies with Canadian ICES-003.**

**Cet appareil numérique de la classe B est conforme à la norme NMB-003 du Canada.**

# I. INTRODUCTION

## How this Manual Is Organized

This manual is divided into the following sections:

- |                               |  |
|-------------------------------|--|
| <b>I. Introduction</b>        | Manual information and checklist                         |
| <b>II. Features</b>           | Information and specifications concerning this product   |
| <b>III. Hardware Setup</b>    | Instructions on setting up the motherboard and jumpers   |
| <b>IV. BIOS Setup</b>         | Instructions on setting up the BIOS software             |
| <b>V. Software Setup</b>      | Instructions on setting up the included support software |
| <b>VI. Software Reference</b> | Reference material for the included support software     |
| <b>VII. Appendix</b>          | Optional items and general reference                     |

## Item Checklist

Please check that your package is complete. If you discover damaged or missing items, please contact your retailer.

- (1) ASUS Motherboard
- (1) Universal Retention Mechanism for SECC2/SECC/SEPP processors
- (1) Ribbon cable for master and slave IDE drives
- (1) Ribbon cable for (1) 5.25" and (2) 3.5" floppy disk drives
- (1) Bag of spare jumper caps
- (1) Support CD with drivers and utilities
- (1) This Motherboard User's Manual
  
- ASUS IrDA-compliant infrared module (optional)
- ASUS CIDB chassis sensor module (optional)
- ASUS S370 CPU card (optional)
- ASUS PCI-L101 Wake-On-LAN 10/100 Ethernet Card (optional)



## II. FEATURES

---

### Features of the ASUS P2-99 Motherboard

The ASUS P2-99 is carefully designed for the demanding PC user who wants advanced features processed by the fastest CPU.

#### Specifications:

- **Multi-Speed:** Supports Intel Pentium® III (450MHz and faster), Pentium® II (233MHz to 450MHz), and Celeron™ (266MHz and faster) processors.
- **Intel AGPset:** Features Intel's 440ZX AGPset with I/O subsystems and front-side bus (FSB) platform, which boosts the traditional 66MHz internal bus speed to 100MHz.
- **Multi-Cache:** Supports processors with either 512, 256, 128, or 0KB Pipelined Burst Level 2 cache.
- **PC100 Memory Support:** Equipped with two DIMM sockets to support Intel PC100-compliant SDRAMs (8, 16, 32, 64, 128, or 256MB) up to 512MB. These new SDRAMs are necessary to meet the critical enhanced 100MHz bus speed requirement.
- **Peripheral Wake Up:** Supports modem wake up, keyboard wake up, and LAN card wake up functions from sleep or soft-off mode.
- **Thermal Sensor Connector w/Optional Sensor (only w/hardware monitor):** Accurately detects the CPU temperature with the ASUS Smart Fan or the Intel boxed processor heatsink with fan when connected to an optional ASUS P2T-Cable.
- **PC Health Monitoring (optional):** Provides an easier way to examine and manage system status information such as CPU and system voltages, temperatures, and fan status through the onboard hardware monitor ASIC and the bundled LDCM by Intel or PC Probe from ASUS.
- **AGP Slot:** Supports an Accelerated Graphics Port card for high performance, component level interconnect targeted at 3D graphical display applications using a 1X or 2X mode bus.
- **SB-Link™ Connector:** Features Creative's SB-Link™, allowing SB16 compatibility, using Intel's PC-PCI DMA and serialized IRQ protocols, to AWE64D or compatible PCI audio cards.
- **SMBus:** Features the System Management Bus interface, which is used to physically transport commands and information between SMBus devices.
- **PCI & ISA Expansion Slots:** Provides four 32-bit PCI and three 16-bit ISA slots.
- **Multi-I/O:** Provides two high-speed UART compatible serial ports and one parallel port with EPP and ECP capabilities. UART2 can also be directed from COM2 to the Infrared Module for wireless connections.
- **UltraDMA/33 Bus Master IDE:** Comes with an onboard PCI Bus Master IDE controller with two connectors that support four IDE devices in two channels, supports UltraDMA/33, PIO Modes 3 and 4 and Bus Master IDE DMA Mode 2, and supports Enhanced IDE devices, such as Tape Backup and CD-ROM, CD-R, CD-RW, and LS-120 drives.



## II. FEATURES

---

- **Universal Retention Mechanism:** Supports a Pentium® III / II processor packaged in a Single Edge Contact Cartridge (SECC/SECC2) or a Celeron™ processor packaged in a Single Edge Processor Package (SEPP).
- **Wake-On-LAN Connector:** Supports Wake-On-LAN activity through an optional ASUS PCI-L101 10/100 Fast Ethernet PCI card (See APPENDIX) or a similar ethernet card.
- **IrDA:** Supports an optional infrared port module for a wireless interface.

### Special Features:

- **Enhanced ACPI and Anti-Boot Virus BIOS:** Features a programmable BIOS, offering enhanced ACPI for Windows 98 compatibility, built-in firmware-based virus protection through Trend ChipAway Virus codes, and autodetection of most devices for virtually automatic setup.
- **Desktop Management Interface (DMI):** Supports DMI through BIOS, which allows hardware to communicate within a standard protocol creating a higher level of compatibility. (Requires DMI-enabled components.)
- **Easy Installation:** Incorporates BIOS that supports autodetection of hard disk drives, PS/2 mouse, and Plug and Play devices to make the setup of hard disk drives, expansion cards, and other devices virtually automatic.
- **PC'98 Compliant:** Both the BIOS and hardware levels of ASUS smart series of motherboards meet PC'98 compliancy. The new PC'98 requirements for systems and components are based on the following high-level goals: Support for Plug and Play compatibility and power management for configuring and managing all system components, and 32-bit device drivers and installation procedures for Windows 95/98/NT.
- **Symbios SCSI BIOS:** Supports optional ASUS SCSI controller cards through onboard SYMBIOS firmware.

### Performance Features:

- **Concurrent PCI:** Concurrent PCI allows multiple PCI transfers from PCI master busses to the memory and processor.
- **Double the IDE Transfer Speed:** ASUS smart series motherboards with Intel chipsets improves IDE transfer rate using Bus Master UltraDMA/33 IDE which can handle data transfer up to 33MB/s. The best of all is that this new technology is compatible with existing ATA-2 IDE specs so there is no need to upgrade current hard drives or cables.
- **SDRAM Optimized Performance:** Supports the new generation memory - Synchronous Dynamic Random Access Memory (SDRAM) which increases the data transfer rate to 800MB/s max using PC100 SDRAM.

## II. FEATURES

---

### Intelligent Features (only with optional hardware monitor):

- **Auto Fan Off:** The system fans will power off automatically **even in sleep mode**. This function reduces both energy consumption *and* **system noise**, and is an important feature in implementing silent PC systems.
- **Dual Function Power Button:** Pushing the power button for less than 4 seconds when the system is in the working state places the system into one of two states: sleep mode or soft-off mode, depending on the BIOS setting (see *Power Management Setup* under BIOS SETUP). When the power button is pressed for more than 4 seconds, the system enters the soft-off mode regardless of the BIOS setting.
- **Fan Status Monitoring and Alarm:** To prevent system overheat and system damage, the CPU, power supply, and system fans can be monitored for RPM and failure. All fans are set for its normal RPM range and alarm thresholds.
- **Keyboard Power Up:** Keyboard Power Up can be enabled or disabled to allow the computer to be powered on by pressing the space bar on the keyboard.
- **Message LED (requires ACPI OS support):** Turbo LEDs now act as information providers. Through the way a particular LED illuminates, the user can determine the stage the computer is in. A simple glimpse provides useful information to the user.
- **Remote Ring On (requires external modem):** This allows a computer to be turned on remotely through an external modem. With this benefit on-hand, any user can access vital information from their computer from anywhere in the world!
- **System Resources Alert:** Today's operating systems such as Windows 95/98/NT and OS/2, require much more memory and hard drive space to present enormous user interfaces and run large applications. The system resource monitor will warn the user before the system resources are used up to prevent possible application crashes. Suggestions will give the user information on managing their limited resources more efficiently.
- **Temperature Monitoring and Alert:** To prevent system overheat and system damage, there are heat sensors to monitor the CPU (the Pentium III / II processor requires a special heatsink with a thermal sensor) and system temperatures to warn of damaging temperatures.
- **Voltage Monitoring and Alert:** System voltage levels are monitored to ensure stable voltage to critical motherboard components. Voltage specifications are more critical for future processors, so monitoring is necessary to ensure proper system configuration and management.
- **Chassis Intrusion Detection:** Supports chassis-intrusion monitoring through the optional ASUS CIDB module and Intel LDCM.

# II. FEATURES

## The ASUS P2-99 Motherboard

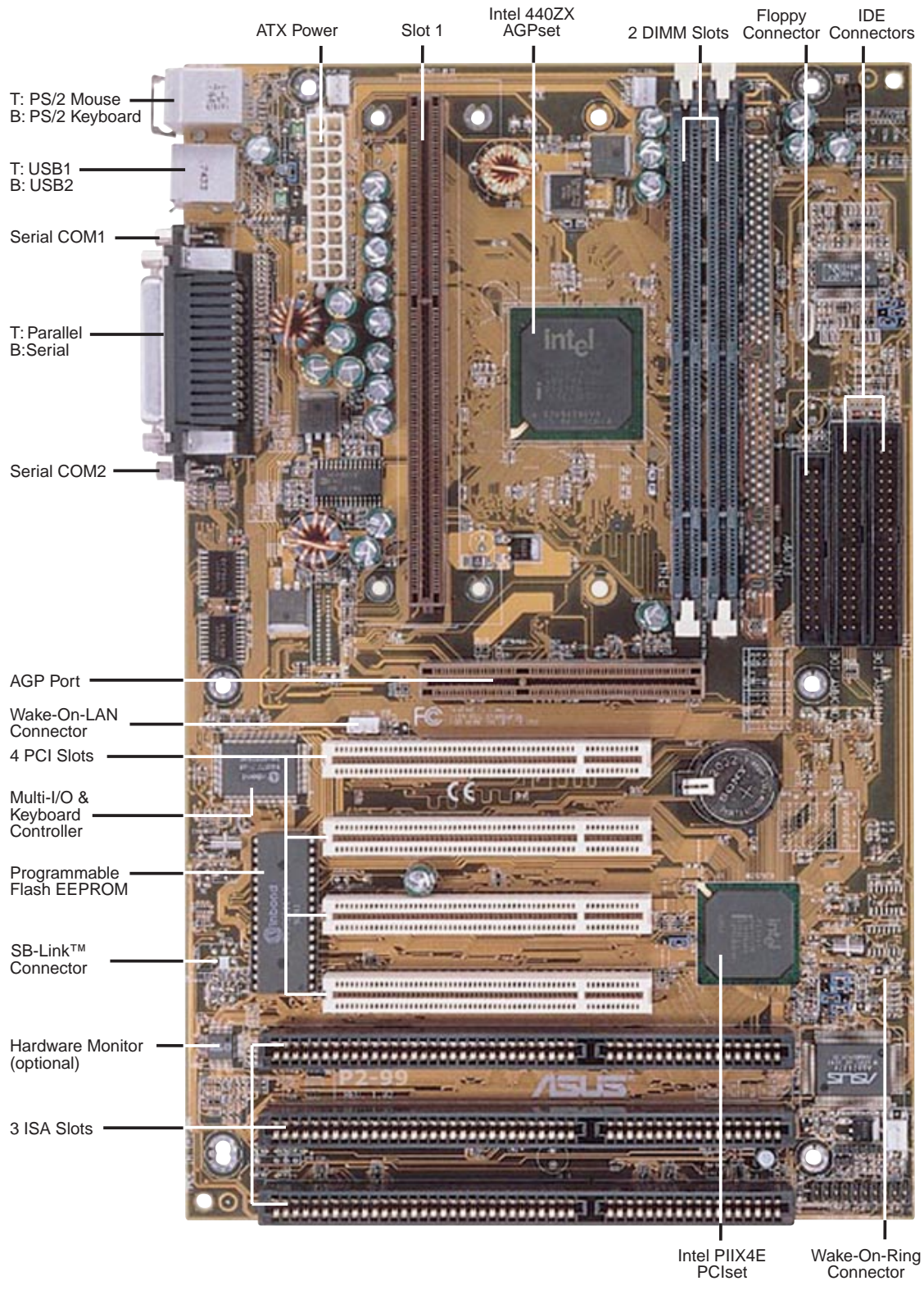

**II. FEATURES**  
Motherboard Parts



# III. HARDWARE SETUP

## Layout of the ASUS P2-99 Motherboard

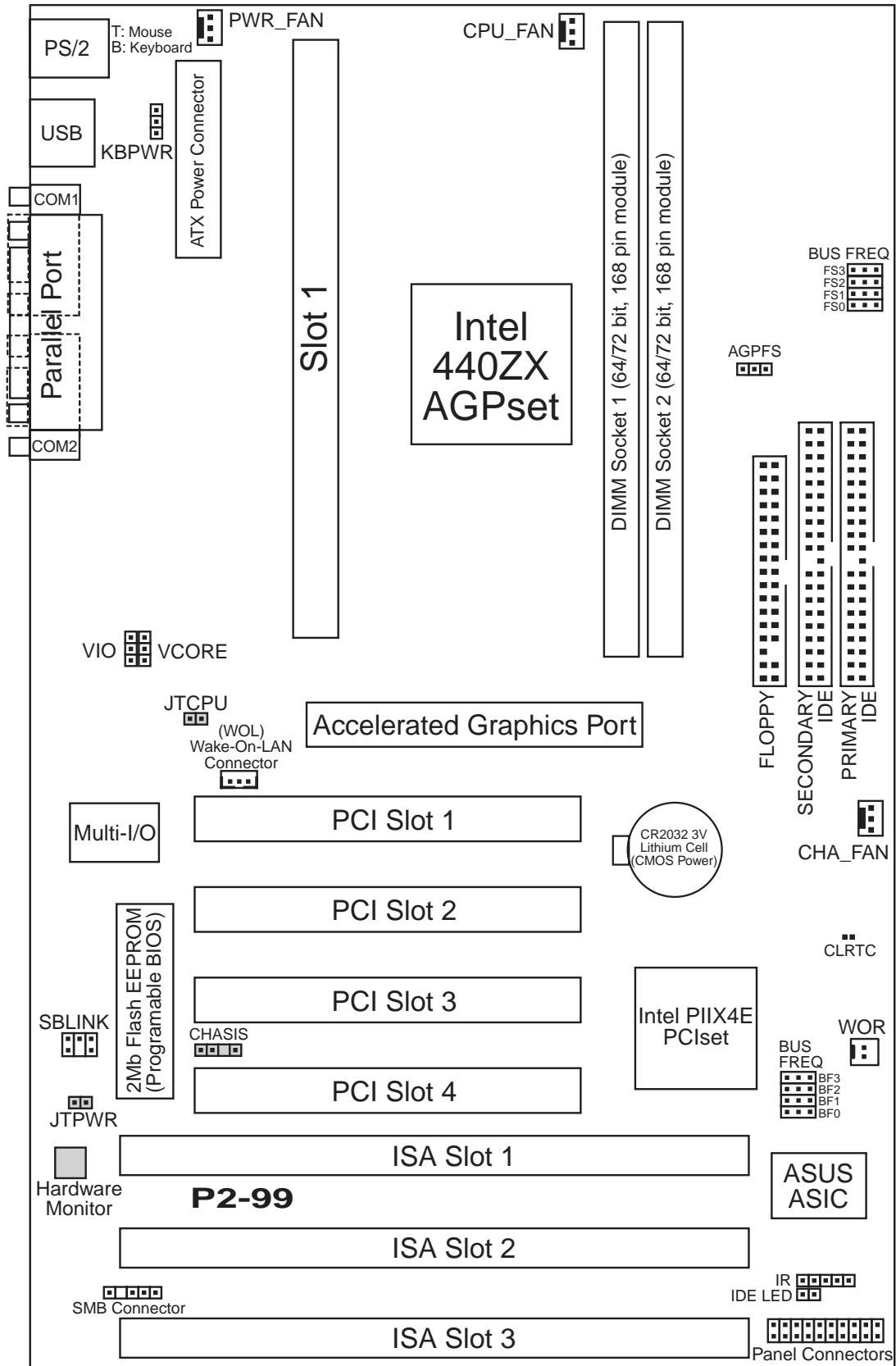

Grayed items are optional at the time of purchase.

# III. HARDWARE SETUP

---

## Motherboard Settings

- |                       |  |
|-----------------------|--|
| 1) AGPFS              | p. 14 AGP Bus Frequency Setting                    |
| 2) KBPWR              | p. 15 Keyboard Power Up Setting (Disable/Enable)   |
| 3) VIO                | p. 15 I/O Voltage Setting (Normal/Test)            |
| 4) VCORE              | p. 16 Core Voltage Setting (Normal/Test)           |
| 5) FS0, FS1, FS2, FS3 | p. 16 CPU External Clock (BUS) Frequency Selection |
| 6) BF0, BF1, BF2, BF3 | p. 17 CPU Core:BUS Frequency Multiple              |

## Expansion Slots/Sockets

- |                           |                                       |
|---------------------------|---------------------------------------|
| 1) System Memory          | p. 18 System Memory Support           |
| 2) DIMM1, DIMM2           | p. 19 DIMM Memory Module Support      |
| 3) Slot 1                 | p. 21 CPU Support                     |
| 4) SLOT1, SLOT2, SLOT3    | p. 26 16-bit ISA Bus Expansion Slots* |
| 5) PCI1, PCI2, PCI3, PCI4 | p. 26 32-bit PCI Bus Expansion Slots  |
| 6) AGP                    | p. 27 Accelerated Graphics Port       |

## Hardware Monitor (optional)

- |                 |                                 |
|-----------------|---------------------------------|
| 1) JTPWR, JTCPU | p. 25 Thermal Sensor Connectors |
|-----------------|---------------------------------|

## Connectors

- |                          |   |
|--------------------------|---|
| 1) PS2KBMS               | p. 28 PS/2 Mouse Port Connector (6 pin-female)                      |
| 2) PS2KBMS               | p. 28 PS/2 Keyboard Port Connector (6-pin female)                   |
| 3) PARALLEL              | p. 29 Parallel (Printer) Port Connector (25-pin female)             |
| 4) COM1, COM2            | p. 29 Serial Port COM1 & COM2 (two 9-pin male)                      |
| 5) USB                   | p. 29 Universal Serial BUS Port Connectors 1 & 2 (Two 4-pin female) |
| 6) Primary/Secondary IDE | p. 30 Primary/Secondary IDE Connectors (Two 40-1 pins)              |
| 7) FLOPPY                | p. 30 Floppy Drive Port Connector (34 pins)                         |
| 8) IDELED                | p. 31 IDE LED Activity Light (2 pins)                               |
| 9) WOR                   | p. 31 Wake-On-Ring Connector (2 pins)                               |
| 10) CHA_, PWR_, CPU_FAN  | p. 32 Chassis, Power Supply, CPU Fan Power Lead (3 pins)            |
| 11) WOL_CON              | p. 33 Wake-On-LAN Connector (3 pins)                                |
| 12) IR                   | p. 33 Infrared Port Module Connector (5 pins)                       |
| 13) SBLINK               | p. 34 SB-Link™ Port Connector (6-1 pins)                            |
| 14) SMB CON.             | p. 34 SMBus Connector (3 pins)                                      |
| 15) ATXPWR               | p. 35 ATX Motherboard Power Connector (20 pins)                     |
| 16) CHASIS               | p. 35 Chassis Intrusion Alarm Lead (4-1 pins)                       |
| 17) PWR.LED (PANEL)      | p. 36 System Power LED Lead (3-1 pins)                              |
| 18) KEYLOCK (PANEL)      | p. 36 Keyboard Lock Switch Lead (2 pins)                            |
| 19) SPEAKER (PANEL)      | p. 36 System Warning Speaker Connector (4 pins)                     |
| 20) MSG.LED (PANEL)      | p. 36 System Message LED (2 pins)                                   |
| 21) SMI (PANEL)          | p. 36 System Management Interrupt Lead (2 pins)                     |
| 22) PWR.SW (PANEL)       | p. 36 ATX Power / Soft-Off Switch Lead (2 pins)                     |
| 23) RESET (PANEL)        | p. 36 Reset Switch Lead (2 pins)                                    |

\*The optional onboard hardware monitor uses the address 290H-297H so legacy ISA cards must not use this address otherwise conflicts will occur.

# III. HARDWARE SETUP

## Hardware Setup Steps

Before using your computer, you must complete the following steps:

1. Check Motherboard Settings
2. Install Memory Modules
3. Install the Central Processing Unit (CPU)
4. Install Expansion Cards
5. Connect Ribbon Cables, Panel Wires, and Power Supply
6. Setup the BIOS Software

### 1. Motherboard Settings

This section explains in detail how to change your motherboard's function settings through the use of switches and/or jumpers.

**WARNING!** Computer motherboards and expansion cards contain very delicate Integrated Circuit (IC) chips. To protect them against damage from static electricity, you should follow some precautions whenever you work on your computer.

1. Unplug your computer when working on the inside.
2. Use a grounded wrist strap before handling computer components. If you do not have one, touch both of your hands to a safely grounded object or to a metal object, such as the power supply case.
3. Hold components by the edges and try not to touch the IC chips, leads or connectors, or other components.
4. Place components on a grounded antistatic pad or on the bag that came with the component whenever the components are separated from the system.

### Jumpers

#### 1. AGP Frequency Setting (AGPFS)

This option sets the frequency ratio between the AGP bus frequency and the CPU bus frequency. The default sets the AGP bus frequency to be 2/3 of the CPU bus frequency.

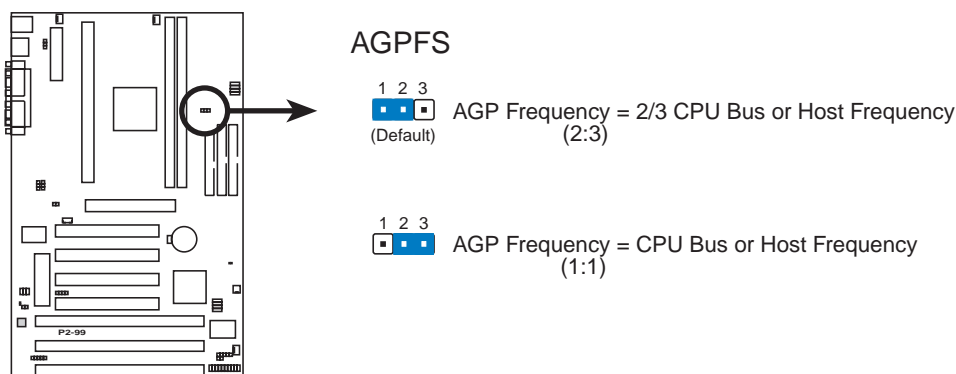

**P2-99 AGP Frequency Setting**

**WARNING!** AGP bus frequencies above 66MHz exceed the specifications for the AGP interface and are not guaranteed to be stable.

# III. HARDWARE SETUP

## 2. Keyboard Power Up Setting (KBPWR)

This allows you to disable or enable the keyboard power up function. Set to *Enable* if you want to use your keyboard (by pressing <Spacebar>) to power up your computer. This feature requires an ATX power supply that can supply at least 300mA on the +5VSB lead. The default is set to *Disable* because not all computers have the appropriate ATX power supply. Your computer will not function if you set this to *Enable* and if you do not have the right ATX power supply.

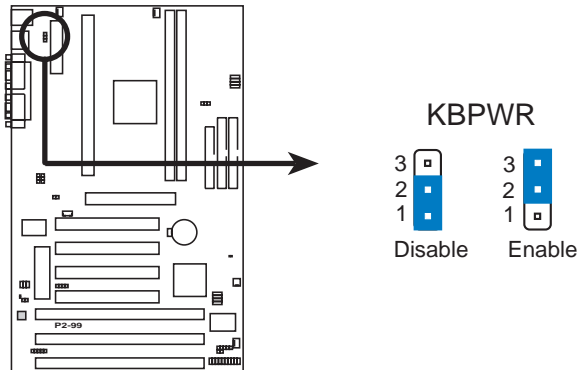

**P2-99 Keyboard Power Up Setting**

## 3. I/O Voltage Setting (VIO)

This jumper allows you to select the voltage supplied to the DRAM, chipset, AGP, and the CPU's I/O buffer. **IMPORTANT!** Setting this jumper to *Test* may reduce system life. Leave on default setting of *Normal*.

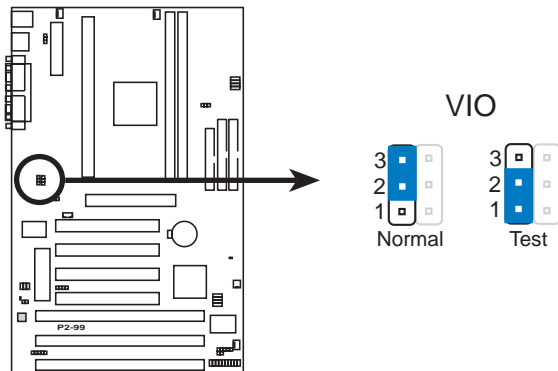

**P2-99 I/O Voltage Setting**



# III. HARDWARE SETUP

## 4. Voltage Regulator Output Setting (VCORE)

This jumper sets the core voltage supplied to the microprocessor.

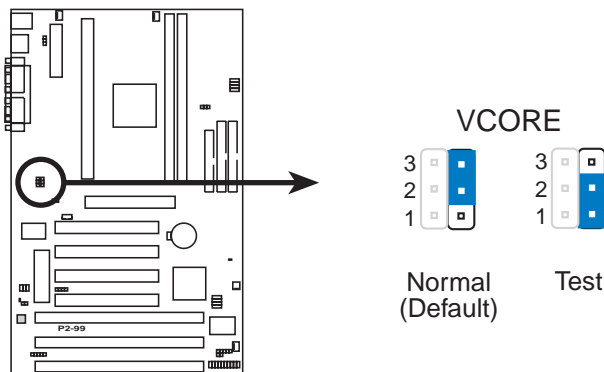

**P2-99 CPU Core Voltage Setting**

**WARNING!** Using a higher voltage *Test* may help when overclocking but may result in the shortening of your computer component's life. It is strongly recommended that you leave both the VIO and VCORE jumpers on their default settings.

## 5. CPU Bus Frequency Selection (FS0, FS1, FS2, FS3)

This option tells the clock generator what frequency to send to the CPU, DRAM, and 440ZX AGPset. This allows the selection of the CPU's *External* frequency (or *BUS Clock*). The BUS Clock multiplied by the BUS Multiple equals the CPU's *Internal* frequency (the advertised CPU speed).

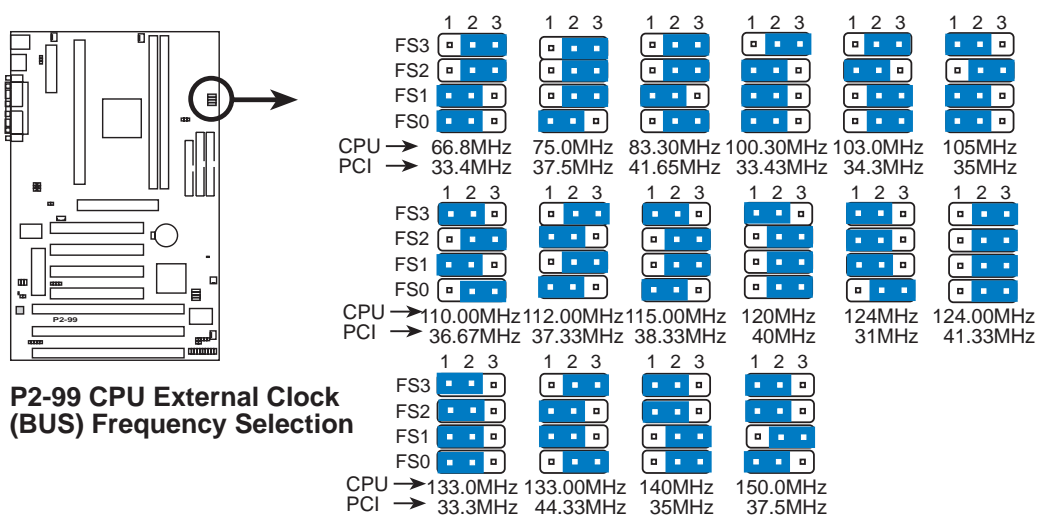

**P2-99 CPU External Clock (BUS) Frequency Selection**

# III. HARDWARE SETUP

## 6. CPU Core:BUS Frequency Multiple (BF0, BF1, BF2, BF3)

This option sets the frequency multiple between the *Internal* frequency of the CPU and the CPU's *External* frequency. These must be set in conjunction with the *CPU Bus Frequency*.

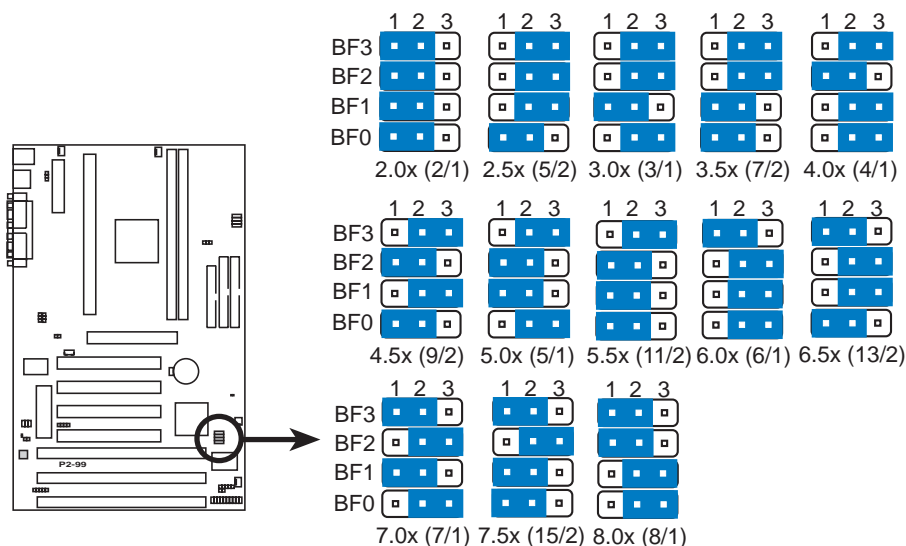

**P2-99 CPU Core:BUS Frequency Multiple**

**WARNING!** Frequencies above 100MHz exceed the specifications for the on-board Intel Chipset and are not guaranteed to be stable.

*Set the jumpers by the Internal speed of your processor as follows:*

Intel CPU Model	Freq.	Mult.	BUS F.	(CPU BUS Freq.)				(Freq. Multiple)				AGP
				FS0	FS1	FS2	FS3	BF0	BF1	BF2	BF3	
Pentium III	550MHz	5.5x	100MHz	[1-2]	[1-2]	[1-2]	[2-3]	[1-2]	[1-2]	[1-2]	[2-3]	[1-2]
Pentium III	500MHz	5.0x	100MHz	[1-2]	[1-2]	[1-2]	[2-3]	[2-3]	[1-2]	[1-2]	[2-3]	[1-2]
Pentium II/III	450MHz	4.5x	100MHz	[1-2]	[1-2]	[1-2]	[2-3]	[1-2]	[2-3]	[1-2]	[2-3]	[1-2]
Pentium II	400MHz	4.0x	100MHz	[1-2]	[1-2]	[1-2]	[2-3]	[2-3]	[2-3]	[1-2]	[2-3]	[1-2]
Pentium II	350MHz	3.5x	100MHz	[1-2]	[1-2]	[1-2]	[2-3]	[1-2]	[1-2]	[2-3]	[2-3]	[1-2]
Celeron	466MHz	7.0x	66MHz	[1-2]	[1-2]	[2-3]	[2-3]	[2-3]	[1-2]	[2-3]	[1-2]	[2-3]
Celeron	433MHz	6.5x	66MHz	[1-2]	[1-2]	[2-3]	[2-3]	[1-2]	[2-3]	[2-3]	[1-2]	[2-3]
Celeron	400MHz	6.0x	66MHz	[1-2]	[1-2]	[2-3]	[2-3]	[2-3]	[2-3]	[2-3]	[1-2]	[1-2]
Pentium II/Celeron	333MHz	5.0x	66MHz	[1-2]	[1-2]	[2-3]	[2-3]	[2-3]	[1-2]	[1-2]	[2-3]	[2-3]
Pentium II/Celeron	300MHz	4.5x	66MHz	[1-2]	[1-2]	[2-3]	[2-3]	[1-2]	[2-3]	[1-2]	[2-3]	[2-3]
Pentium II/Celeron	266MHz	4.0x	66MHz	[1-2]	[1-2]	[2-3]	[2-3]	[2-3]	[2-3]	[1-2]	[2-3]	[2-3]
Pentium II	233MHz	3.5x	66MHz	[1-2]	[1-2]	[2-3]	[2-3]	[1-2]	[1-2]	[2-3]	[2-3]	[2-3]

**NOTES:** Overclocking your processor is not recommended. It may result in a slower speed. Voltage Regulator Output Selection (VID) is not required for Pentium III/II/Celeron processors because they send VID signals directly to the onboard power regulator.

# III. HARDWARE SETUP

## 2. System Memory (DIMM)

**NOTE:** No hardware or BIOS setup is required after adding or removing memory. This motherboard uses only Dual Inline Memory Modules (DIMMs). Sockets are available for **3.3Volt** (power level) unbuffered Synchronous Dynamic Random Access Memory (SDRAM) of either 8, 16, 32, 64, 128MB, or 256MB.

The Intel 440ZX AGPset does not support ECC function. ECC memory modules may be used but the ECC function will not be available.

Memory speed setup is recommended through *SDRAM Configuration* under “Chipset Features Setup” in BIOS SETUP.

*Install memory in any combination as follows:*

DIMM Location	168-pin DIMM		Total Memory
Socket 1 (Rows 0&1)	SDRAM 8, 16, 32, 64, 128, 256MB	x1	
Socket 2 (Rows 2&3)	SDRAM 8, 16, 32, 64, 128, 256MB	x1	
	<b>Total System Memory (Max 512MB)</b>	=	

### General DIMM Notes

- **For the system CPU bus to operate at 100MHz, use only PC100-compliant DIMMs.** When this motherboard operates at 100MHz, most system will not even boot if non-compliant modules are used because of the strict timing issues involved under this speed. If your DIMMs are not PC100-compliant, set the CPU bus frequency to 66MHz RAM to ensure system stability.
- ASUS motherboards support SPD (Serial Presence Detect) DIMMs. This is the memory of choice for best performance vs. stability.
- Two possible memory chips are supported: SDRAM with and without ECC.
- SDRAM chips are generally thinner with higher pin density than EDO (Extended Data Output) chips.
- BIOS shows SDRAM memory on bootup screen.
- 8 chips/side modules do not support ECC, only 9 chips/side modules support ECC.
- Single-sided DIMMs come in 16, 32, 64,128MB; double-sided come in 32, 64, 128, 256MB.

# III. HARDWARE SETUP

## *DIMM Memory Installation Procedures*

Insert the module(s) as shown. Because the number of pins are different on either side of the breaks, the module will only fit in the orientation as shown. DRAM SIMM modules have the same pin contacts on both sides. SDRAM DIMMs have different pin contacts on each side and therefore have a higher pin density.

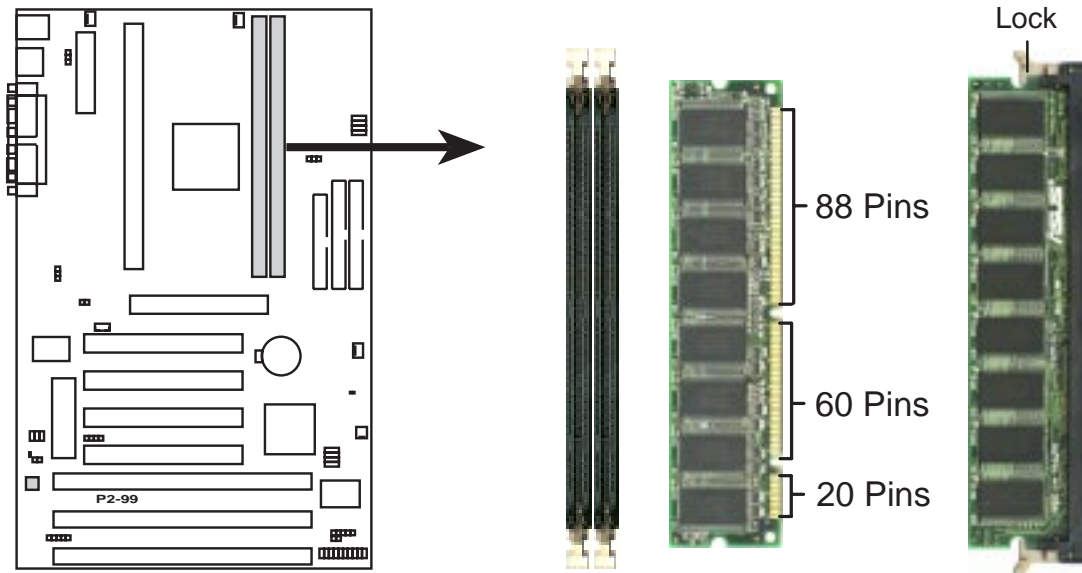

### **P2-99 168-Pin DIMM Memory Sockets**

The DIMMs must be 3.3Volt unbuffered SDRAMs. To determine the DIMM type, check the notches on the DIMMs (see figure below).

#### **168-Pin DIMM Notch Key Definitions (3.3V)**

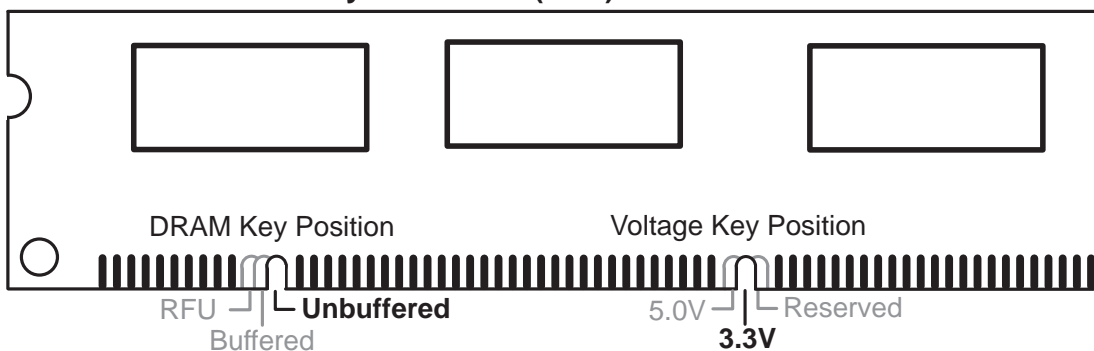

The notches on the DIMM will shift between left, center, or right to identify the type and also to prevent the wrong type from being inserted into the DIMM slot on the motherboard. You must tell your retailer the correct DIMM type before purchasing. This motherboard supports four clock signals per DIMM.

# III. HARDWARE SETUP

---

(This page was intentionally left blank.)

# III. HARDWARE SETUP

## 3. Central Processing Unit (CPU)

**NOTE:** The following pictures are provided for reference purposes only. The appearance of your retention mechanism and fan may be different from the following examples.

Your motherboard provides a Slot 1 connector for a Pentium® III processor packaged in a Single Edge Contact Cartridge (SECC2), a Pentium® II processor packaged in SECC/SECC2, or a Celeron™ processor packaged in a Single Edge Processor Package (SEPP). An ASUS S370 CPU card can allow Socket 370 processors to be used on any ASUS motherboard with the Slot 1 connector (See *ASUS S370 CPU Card* in APPENDIX for instructions on using this card).



Pentium II processor packaged in an SECC with heatsink and fan (top view)



Pentium III (in an SECC2) with heatsink and fan  
**NOTE:** The SEPP fan (for Celeron processors) is similar to SECC2 fan except that the clamping design is different.

### *Universal Retention Mechanism*

Your motherboard comes preinstalled with a Universal Retention Mechanism (URM). The URM supports Pentium III / II and Celeron processors.

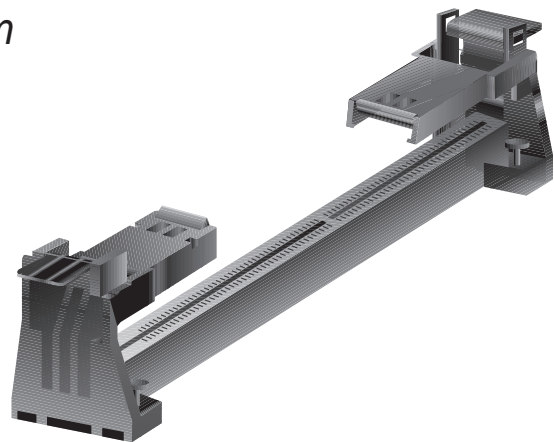

Universal Retention Mechanism (URM)

### *Heatsinks*

The recommended heatsinks (see section on recommended heatsinks for Pentium III / II processors for more information) for the boxed Pentium III / II and Celeron processors are those with three-pin fans that can be connected to the fan connectors on the motherboard.

**WARNING!** Be sure that there is sufficient air circulation across the processor's heatsink by regularly checking that your CPU fan is working. Without sufficient circulation, the processor could overheat and damage both the processor and the motherboard. You may install an auxiliary chassis fan, if necessary.

# III. HARDWARE SETUP

## Installing the Processor

### 1. Unlock the URM's Folding Support Arms:

The folding support arms of the URM are locked when shipped.

To unlock the support arms, simply flip them up to an upright position.

The URM is now ready for the installation of your processor.

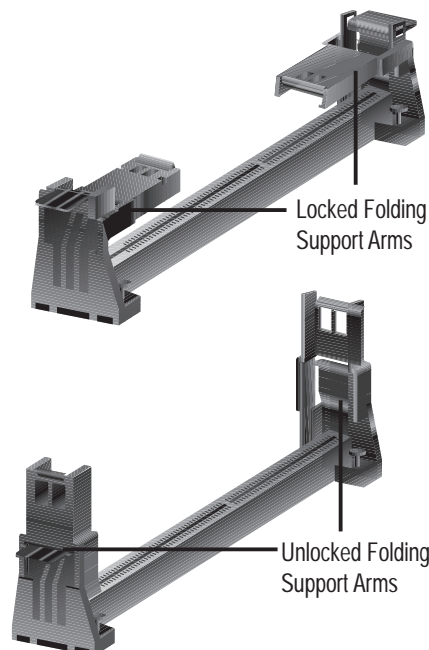

### 2. Attach the Heatsink

**NOTE:** If provided, you should follow the heatsink attachment instructions that came with your heatsink or processor. The following steps are provided only as a general guide and may not reflect those for your heatsink.

#### Using the SECC fan with the Pentium® II

Push the two lock arms one direction to clamp the heatsink onto the processor and the other direction to release.

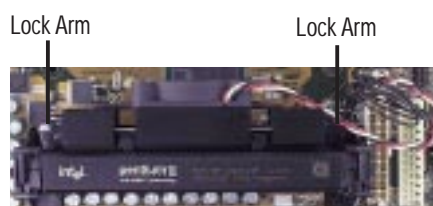

#### Using the SECC2 fan with the Pentium® III

Insert the four heatsink's pins through the holes of the SECC2. Place the metal clip on the ends of the pins and slide until it locks into place.

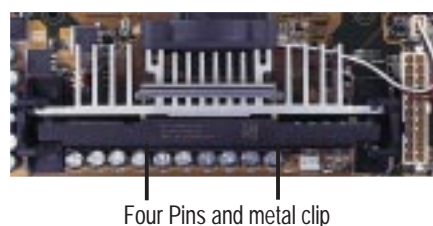

**NOTE:** The SEPP heatsink and fan (for Intel Celeron processors) is similar to the SECC2 heatsink and fan except that the clamping design is different.



# III. HARDWARE SETUP

**WARNING!** Make sure the heatsink is mounted tightly against the SECC, SECC2 or SEPP; otherwise, the CPU will overheat. You may install an auxiliary fan to provide adequate circulation across the processor's passive heatsink.

## 3. Insert the SECC/SECC2/SEPP

**SECC with Pentium® II only:** Push the SECC's two locks inward until you hear a click (the picture in step 2 shows the locks in the outward position and inward in the picture below).

With the heatsink facing the motherboard's chipset, push the SECC, SECC2, or SEPP gently but firmly into the Slot 1 connector until it is fully inserted.

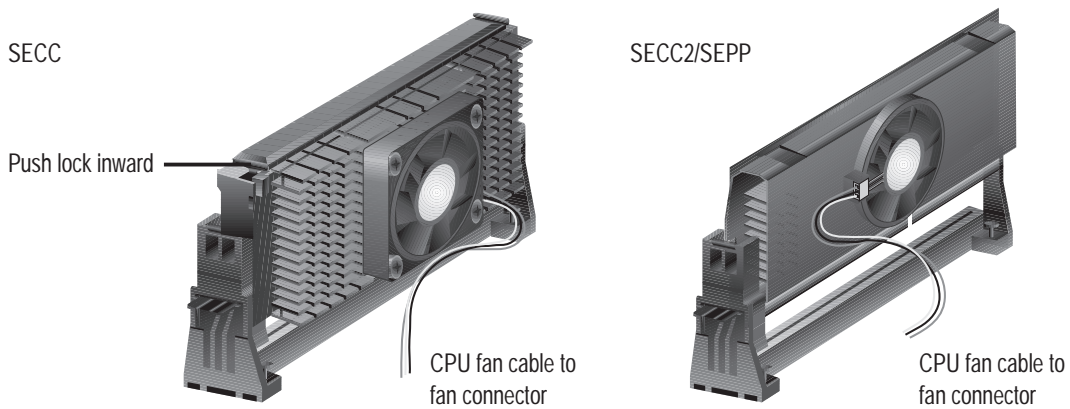

## 4. Secure the SECC/SECC2/SEPP

Secure the SECC/SECC2/SEPP in place by pushing the SECC/SECC2/SEPP until it is firmly seated on the Slot 1 connector.

**SECC with Pentium® II only:** The SECC locks should be outward when secured so that the lock shows through the retention mechanism's lock holes.

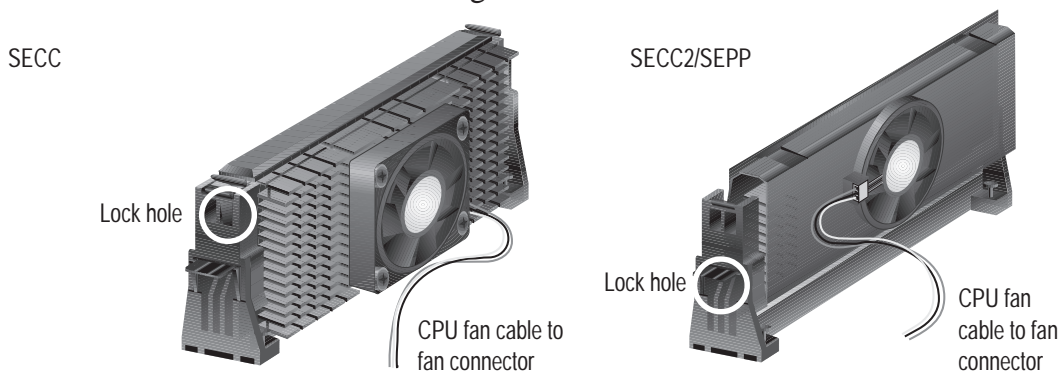

# III. HARDWARE SETUP

## ASUS Smart Thermal Solutions

(for motherboards with hardware monitor)

ASUS provides two smart solutions to Slot 1 CPU thermal problems: the **ASUS Smart Fan** or **ASUS S-P2FAN** and the **ASUS P2T-Cable**.

### ASUS S-P2FAN

The optional ASUS Smart Fan or ASUS S-P2FAN is a CPU fan for a Pentium® II processor packaged in an SECC. Unlike other CPU thermal solutions, the ASUS S-P2FAN has an integrated thermal sensor located near the center of the CPU heat source. The sensor is optimized by ASUS to give the most accurate reading of the CPU temperature, thus provides the best protection to your computer system.

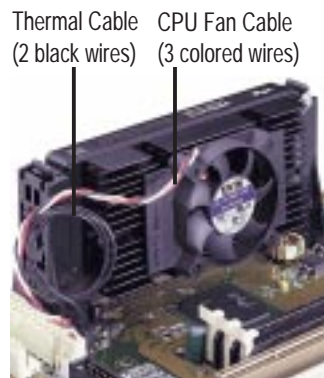

### To Use the ASUS S-P2FAN

See **2. Attach the Heatsink** on the preceding page for the relevant procedures. Note that the S-P2FAN comes with a rock arm design for easy FAN/CPU installation.

### ASUS P2T-Cable

The optional ASUS P2T-Cable can be used for a Pentium® III/II processor packaged in an SECC2/SECC or a Celeron™ processor packaged in an SEPP.

**NOTE:** The ASUS P2T-Cable can only be used in a Slot 1 motherboard with a 2-pin thermal sensor connector.

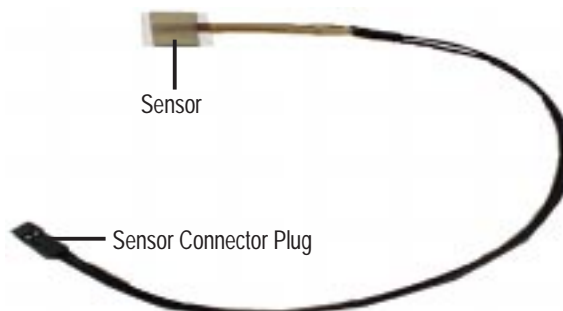

### To Use the ASUS P2T-Cable

**NOTE:** The following procedures assume that you have properly attached a heatsink onto an SECC/SECC2/SEPP.

1. Simply peel off the tab from the sensor and then stick the sensor near the middle edge of the Intel boxed processor heatsink with fan (middle) or to either the upper or lower edge of the Celeron™ heatsink (right), as indicated.



# III. HARDWARE SETUP

**WARNING!** Do not insert the sensor between the processor and heatsink, otherwise, it will cause damage to the P2T-Cable.

**IMPORTANT!** ASUS guarantees accurate readings only for the ASUS Smart Fan and the Intel boxed processor heatsink with fan because both have similar heat distribution and heatsink material.

2. Connect the P2T-Cable to the CPU thermal sensor connector (JTCPU).

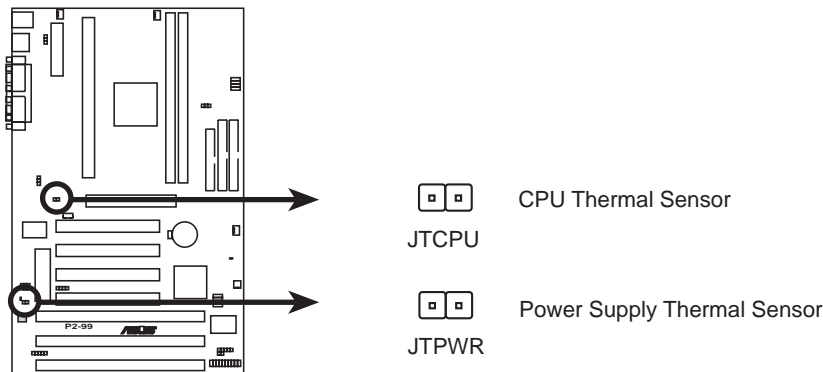

## P2-99 Thermal Sensor Connectors

**NOTE:** If you have a power supply with thermal monitoring, connect its thermal sensor cable to JTPWR.

### *Recommended Heatsinks for Slot 1 Processors*

The recommended heatsinks for the Slot 1 processors are those with three-pin fans, such as the ASUS Smart Fan, that can be connected to the motherboard's CPU fan connector. These heatsinks dissipate heat more efficiently and with an optional hardware monitor, they can monitor the fan's RPM and use the alert function with the Intel LANDesk Client Manager (LDCM) or the ASUS PC Probe software.



**SECC Heatsink & Fan**



**SECC2 Heatsink & Fan**

**NOTE:** The SEPP heatsink and fan (for Intel Celeron processors) is similar to the SECC2 heatsink and fan except that the clamping design is different.

# III. HARDWARE SETUP

---

## 4. Expansion Cards

**WARNING!** Unplug your power supply when adding or removing expansion cards or other system components. Failure to do so may cause severe damage to both your motherboard and expansion cards.

### *Expansion Card Installation Procedure*

1. Read the documentation for your expansion card and make any necessary hardware or software settings for your expansion card, such as jumpers.
2. Remove your computer system's cover and the bracket plate on the slot you intend to use. Keep the bracket for possible future use.
3. Carefully align the card's connectors and press firmly.
4. Secure the card on the slot with the screw you removed above.
5. Replace the computer system's cover.
6. Set up the BIOS if necessary  
(such as *IRQ xx Used By ISA: Yes* in PNP AND PCI SETUP)
7. Install the necessary software drivers for your expansion card.

### *Assigning IRQs for Expansion Cards*

Some expansion cards need to use an IRQ to operate. Generally, an IRQ must be exclusively assigned to one use. In a standard design, there are 16 IRQs available but most of them are already in use, leaving 6 IRQs free for expansion cards. If your motherboard has **PCI** audio onboard, an extra IRQ will be used, leaving 5 IRQs free. If your motherboard has **ISA** audio onboard, an extra 3 IRQs will be used, leaving 3 IRQs free.

Both ISA and PCI expansion cards may require to use IRQs. System IRQs are available to cards installed in the ISA expansion bus first, then any remaining IRQs are available to PCI cards. Currently, there are two types of ISA cards. The original ISA expansion card design, now referred to as legacy ISA cards, requires that you configure the card's jumpers manually and then install it in any available slot on the ISA bus. You may use the Microsoft Diagnostics (MSD.EXE) utility located in the Windows directory to see a map of your used and free IRQs. If you use Windows 95, the **Resources** tab under **Device Manager** displays the resource settings being used by a particular device (to gain access, double-click the **System** icon under the **Control Panel** program). Ensure that no two devices share the same IRQs or your computer will experience problems when those two devices are in use at the same time.

# III. HARDWARE SETUP

To simplify this process, this motherboard has complied with the Plug and Play (PNP) specification which was developed to allow automatic system configuration whenever a PNP-compliant card is added to the system. For PNP cards, IRQs are assigned automatically from those available.

If the system has both Legacy and PNP ISA cards installed, IRQs are assigned to PNP cards from those not used by Legacy cards. The PCI and PNP configuration of the BIOS setup utility can be used to indicate which IRQs are being used by Legacy cards. For older Legacy cards that do not work with the BIOS, you can contact your vendor for an ISA Configuration Utility.

An IRQ number is automatically assigned to PCI expansion cards after those used by Legacy and PNP ISA cards. In the PCI bus design, the BIOS automatically assigns an IRQ to PCI cards that require an IRQ. To install a PCI card, you need to set something called the INT (interrupt) assignment. Since all the PCI slots on this motherboard use an INTA #, be sure that the jumpers on your PCI cards are set to INT A.

## Assigning DMA Channels for ISA Cards

Some ISA cards, both legacy and PnP, may also need to use a DMA (Direct Memory Access) channel. DMA assignments for this motherboard are handled the same way as the IRQ assignment process described earlier. You can select a DMA channel in the PCI and PnP configuration section of the BIOS Setup utility.

**IMPORTANT:** To avoid conflicts, reserve the necessary IRQs and DMAs for legacy ISA cards (under PNP AND PCI SETUP of the BIOS SETUP, choose *Yes* in *IRQ xx Used By ISA* and *DMA x Used By ISA* for those IRQs and DMAs you want to reserve).

## ISA Cards and Hardware Monitor

The optional onboard hardware monitor uses the address 290H-297H, so legacy ISA cards must not use this address or else conflicts will occur.

## Accelerated Graphics Port (AGP)

This motherboard provides an accelerated graphics port (AGP) slot to support a new generation of graphics cards with ultra-high memory bandwidth, such as an ASUS 3D Hardware Accelerator.

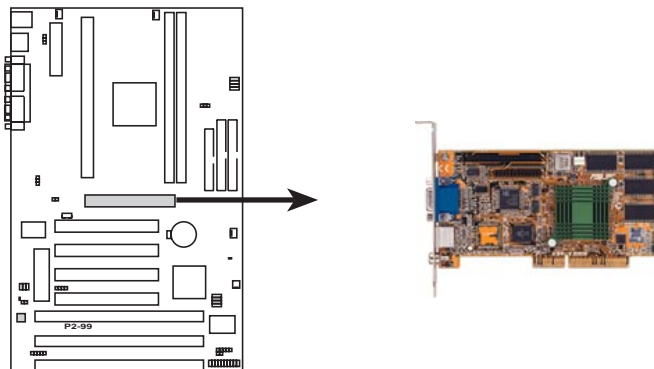

**P2-99 Accelerated Graphics Port (AGP)**



# III. HARDWARE SETUP

## 5. External Connectors

**WARNING!** Some pins are used for connectors or power sources. These are clearly distinguished from jumpers in the motherboard layout. Placing jumper caps over these connectors will cause damage to your motherboard.

**IMPORTANT:** Ribbon cables should always be connected with the red stripe on the Pin 1 side of the connector. The four corners of the connectors are labeled on the motherboard. Pin 1 is the side closest to the power connector on hard drives and floppy drives. IDE ribbon cable must be less than 46 cm (18 in), with the second drive connector no more than 15 cm (6 in) from the first connector.

### 1. PS/2 Mouse Connector (6-pin female)

The system will direct IRQ12 to the PS/2 mouse if one is detected. If not detected, expansion cards can use IRQ12. See “PS/2 Mouse Control” in *BIOS Features Setup* of BIOS SETUP.

PS/2 Mouse (6-pin Female)

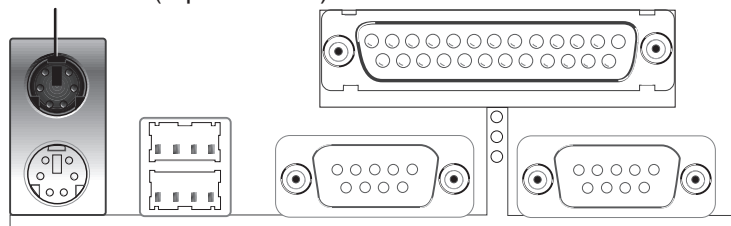

### 2. PS/2 Keyboard Connector (6-pin female)

This connection is for a standard keyboard using an PS/2 plug (mini DIN). **This connector will not allow standard AT size (large DIN) keyboard plugs. You may use a DIN to mini DIN adapter on standard AT keyboards.**

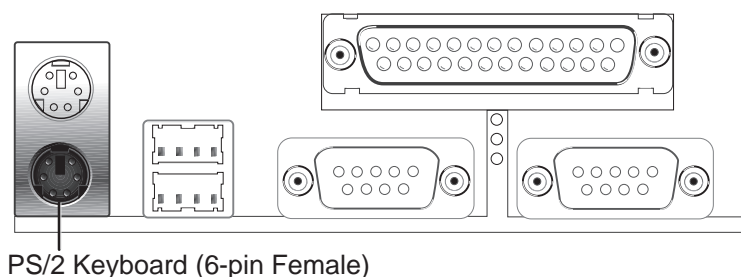

PS/2 Keyboard (6-pin Female)

# III. HARDWARE SETUP

## 3. Parallel Port Connector (25-pin female)

You can enable the parallel port and choose the IRQ through “Onboard Parallel Port” in *Chipset Features Setup* of BIOS SETUP. **NOTE:** Serial printers must be connected to the serial port.

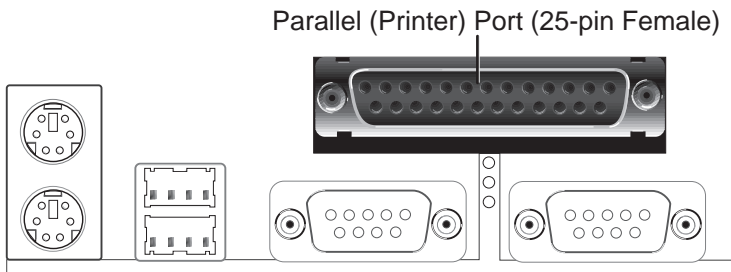

## 4. Serial Port COM1 and COM2 Connectors (Two 9-pin male)

The two serial ports can be used for pointing devices or other serial devices. See “Onboard Serial Port” in *Chipset Features Setup* of BIOS SETUP.

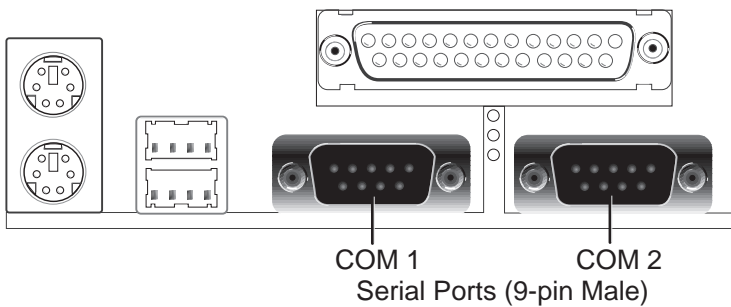

## 5. Universal Serial BUS Port Connectors 1 & 2 (Two 4-pin female)

Two USB ports are available for connecting USB devices.

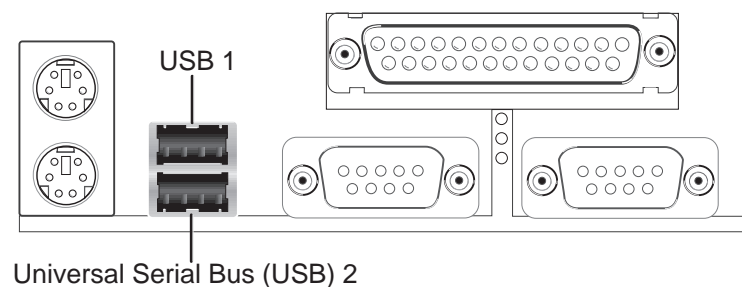



# III. HARDWARE SETUP

## 6. Primary / Secondary IDE Connectors (Two 40-1pin IDE)

These connectors support the provided IDE hard disk ribbon cable. After connecting the single end to the board, connect the two plugs at the other end to your hard disk(s). If you install two hard disks, you must configure the second drive to Slave mode by setting its jumper accordingly. Refer to the documentation of your hard disk for the jumper settings. BIOS now supports SCSI device or IDE CD-ROM bootup (see “HDD Sequence SCSI/IDE First” & “Boot Sequence” in the *BIOS Features Setup* of BIOS SETUP) **(Pin 20 is removed to prevent inserting in the wrong orientation when using ribbon cables with pin 20 plugged).**

**TIP:** You may configure two hard disks to be both Masters using one ribbon cable on the primary IDE connector and another ribbon cable on the secondary IDE connector. You may install one operating system on an IDE drive and another on a SCSI drive and select the boot disk through BIOS Features Setup.

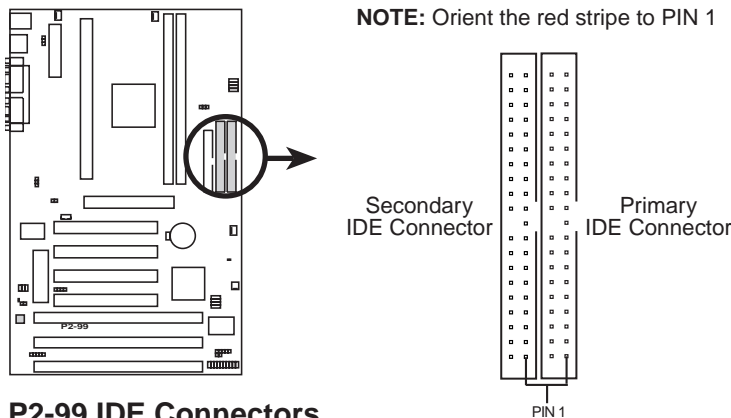

**P2-99 IDE Connectors**

## 7. Floppy Disk Drive Connector (34-1pin FLOPPY)

This connector supports the provided floppy disk drive ribbon cable. After connecting the single end to the board, connect the two plugs on the other end to the floppy drives. **(Pin 5 is removed to prevent inserting in the wrong orientation when using ribbon cables with pin 5 plugged).**

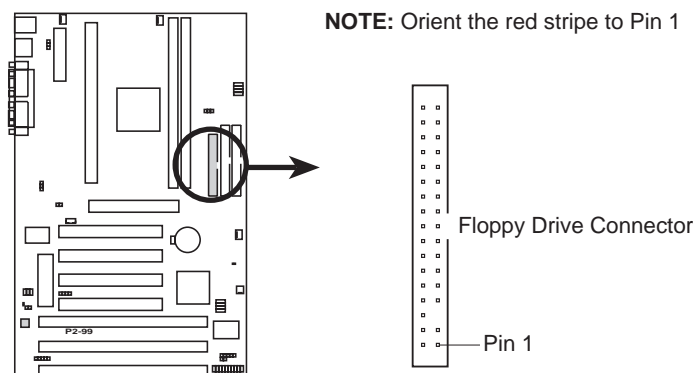

**P2-99 Floppy Disk Drive Connector**

# III. HARDWARE SETUP

## 8. IDE Device Activity LED (2-pin IDELED)

This connector supplies power to the cabinet's IDE device activity LED. Read and write activity by devices connected to the Primary or Secondary IDE connectors will cause the LED to light up.

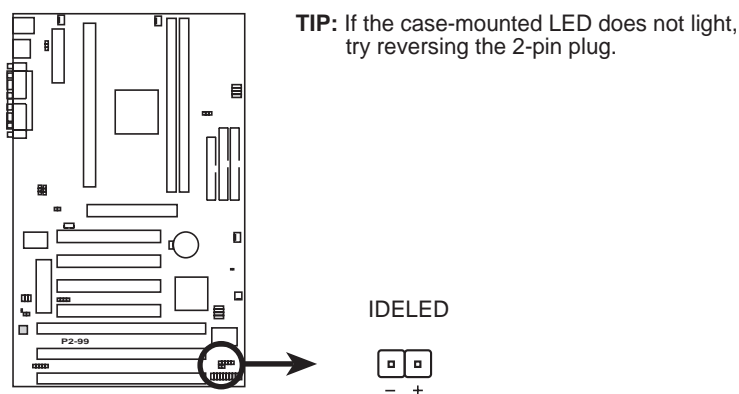

## 9. P2-99 IDE Activity LED Wake-On-Ring Connector (2-pin WOR)

This connector connects to internal modem cards with a Wake-On-Ring output. The connector powers up the system when a ringup packet or signal is received through the internal modem card. **NOTE:** For external modems, Wake-On-Ring is detected through the COM port.

**IMPORTANT:** This feature requires that the PWR UP On Modem Act Power Up Control is set to Enabled (see Power Management Setup under BIOS SETUP).

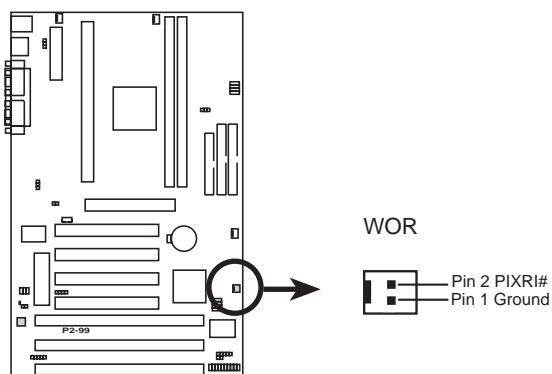

**P2-99 Wake-On-Ring Connector**

# III. HARDWARE SETUP

## 10. Chassis/CPU/Power Supply Fan Connectors (3-pin CHA\_,CPU\_,PWR\_FAN)

These connectors support cooling fans of 500mA (6W) or less. Orientate the fans so that the heat sink fins allow airflow to go across the onboard heat sink(s) instead of the expansion slots. Depending on the fan manufacturer, the wiring and plug may be different. The red wire should be positive, while the black should be ground. Connect the fan's plug to the board taking into consideration the polarity of the this connector.

**NOTES:** The "Rotation" signal is to be used only by a specially designed fan with rotation signal. The fans have been designed to power off after entering the sleep/soft-off mode. This is to reduce both energy consumption and system noise.

**WARNING!** The CPU and/or motherboard will overheat if there is no airflow across the CPU and onboard heatsinks. Damage may occur to the motherboard and/or the CPU fan if these pins are incorrectly used. **These are not jumpers, do not place jumper caps over these pins.**

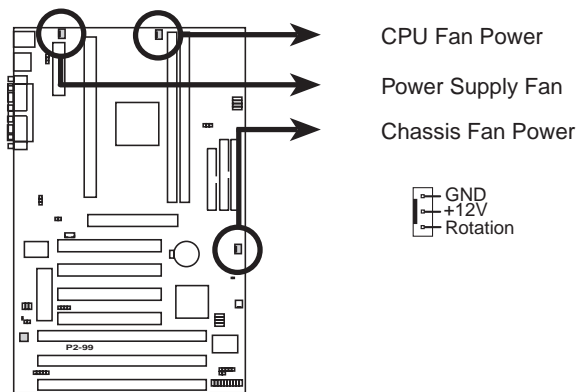

**P2-99 12Volt Cooling Fan Power**

# III. HARDWARE SETUP

## 11. Wake-On-LAN Connector (3-pin WOL\_CON)

The WOL\_CON connector powers up the system when a wake-up packet or signal is received from the network through the ASUS PCI-L101 LAN card.

**IMPORTANT:** This feature requires that the **Wake-On-LAN Power Up Control** is set to *Enabled* (see *Power Management Setup* under BIOS SETUP) and that your system has an ATX power supply with at least 720mA +5V standby power.

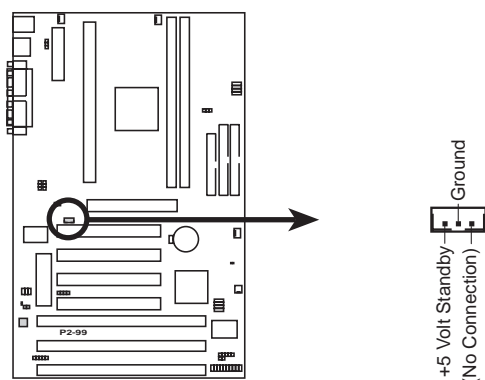

**P2-99 Wake-On-LAN Connector**

## 12. IrDA-Compliant Infrared Module Connector (5-pin IR)

This connector supports the optional wireless transmitting and receiving infrared module. This module mounts to a small opening on system cases that support this feature. You must also configure the setting through “UART2 Use Infrared” in *Chipset Features Setup* to select whether UART2 is directed for use with COM2 or IrDA. Use the five pins as shown on the Back View and connect a ribbon cable from the module to the motherboard according to the pin definitions.

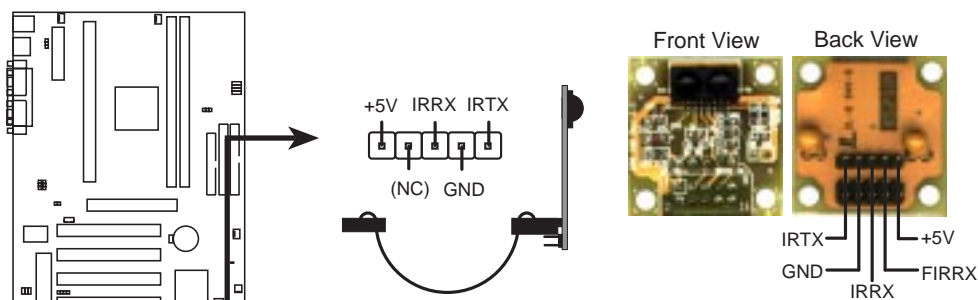

**P2-99 Infrared Module Connector**

For the infrared feature to be available, you must connect the optional Infrared (IrDA) module to the motherboard

# III. HARDWARE SETUP

## 13. SB-Link™ Connector (6-1 pin SBLINK)

If you have a Sound Blaster compatible PCI audio card, you must link it to this connector. Otherwise, you will have compatibility issues under DOS environment.

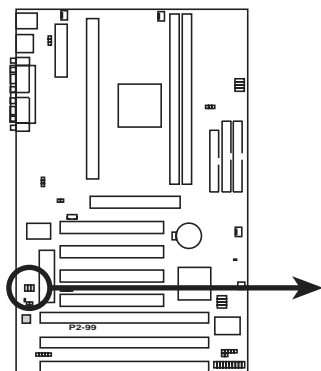

**NOTE:** Pin 3 is removed to ensure the correct orientation of the cable on it.

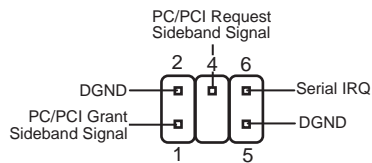

**P2-99 SB-Link™ Connector**

## 14. SMBus Connector (5-1 pin SMB)

This connector allows you to connect SMBus devices. SMBus devices communicate by means of the SMBus with an SMBus host and/or other SMBus devices. The SMBus or System Management Bus is a specific implementation of an I<sup>2</sup>C bus, which is a multi-master bus, that is, multiple chips can be connected to the same bus and each one can act as a master by initiating data transfer.

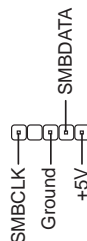
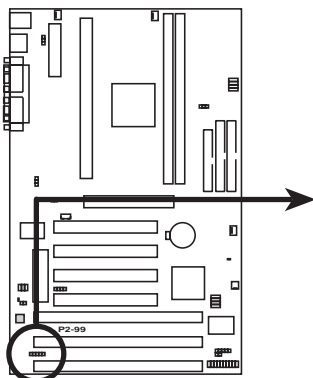

**P2-99 SMBus Connector**

# III. HARDWARE SETUP

## 15. ATX Power Supply Connector (20-pin ATXPWR)

This connector connects to an ATX power supply. The plug from the power supply will only insert in one orientation because of the different hole sizes. Find the proper orientation and push down firmly but gently making sure that the pins are aligned.

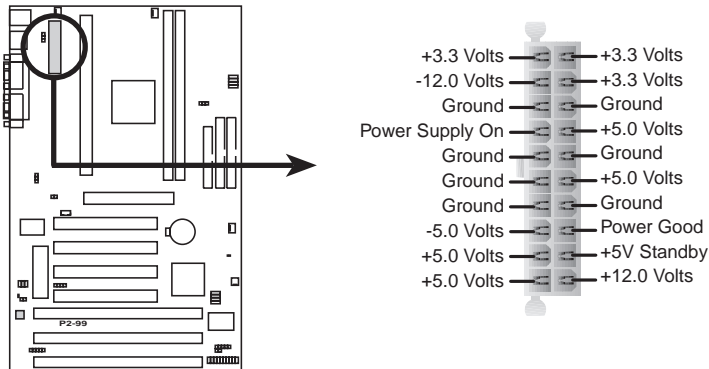

**P2-99 ATX Power Connector**

**IMPORTANT:** Make sure that your ATX power supply can supply at least 10mA on the 5-volt standby lead (5VSB). You may experience difficulty in powering on your system if your power supply cannot support the load. For Wake-On-LAN support, your ATX power supply must supply at least 720mA +5VSB.

## 16. Chassis Intrusion Alarm Lead (optional) (4-1 pin CHASIS)

This requires an external detection mechanism such as a chassis intrusion monitor/sensor or microswitch. The sensor is triggered when a high level signal is sent to the Chassis Signal lead, which occurs when a panel switch or light detector is triggered. This function requires the optional ASUS CIDB chassis sensor module to be installed (See APPENDIX).

**NOTE:** When the chassis is opened, connect/short the Chassis Signal pin to the +5VSB pin. When the chassis is closed, connect/short the Chassis Signal pin to the Ground pin.

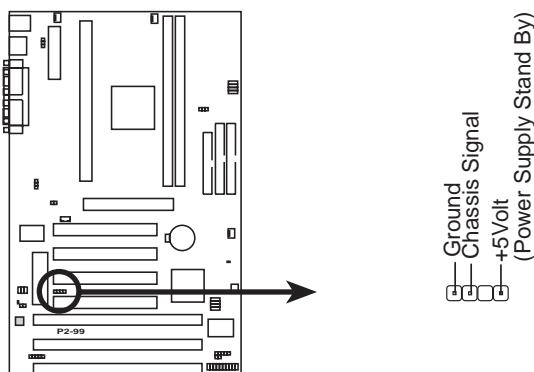

**P2-99 Chassis Open Alarm Lead**

# III. HARDWARE SETUP

## 17. System Power LED Lead (3-1 pin PWR.LED)

This 3-1 pin connector connects to the system power LED, which lights when the system is powered on and blinks when it is in sleep or soft-off mode.

## 18. Keyboard Lock Switch Lead (2-pin KEYLOCK)

This 2-pin connector connects to the case-mounted key switch to allow keyboard locking. **NOTE:** When the keyboard is locked, the mouse can still be used.

## 19. System Warning Speaker Connector (4-pin SPEAKER)

This 4-pin connector connects to the case-mounted speaker.

## 20. System Message LED Lead (2-pin MSG.LED)

This indicates whether a message has been received from a fax/modem. The LED will remain lit when there is no signal and blink when there is data received. This function requires an ACPI OS and driver support.

## 21. System Management Interrupt Lead (2-pin SMI)

This allows the user to manually place the system into a suspend mode or “Green” mode where system activity will be instantly decreased to save electricity and expand the life of certain components when the system is not in use. This 2-pin connector (see the preceding figure) connects to the case-mounted suspend switch. If you do not have a switch for the connector, you may use the “Turbo Switch” since it does not have a function. SMI is activated when it detects a *short to open* moment and therefore leaving it shorted will not cause any problems. This may require one or two pushes depending on the position of the switch.

## 22. ATX Power Switch / Soft-Off Switch Lead (2-pin PWR.SW)

The system power is controlled by a momentary switch connected to this lead. Pushing the button once will switch the system between ON and SLEEP or ON and SOFT OFF, depending on your BIOS or OS setting. Pushing the switch while in the ON mode for more than 4 seconds will turn the system off. The system power LED shows the status of the system’s power.

## 23. Reset Switch Lead (2-pin RESET)

This 2-pin connector connects to the case-mounted reset switch for rebooting your computer without having to turn off your power switch. This is a preferred method of rebooting to prolong the life of the system’s power supply.

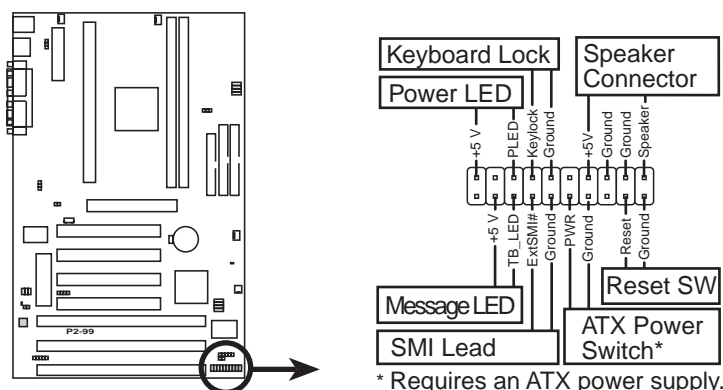

P2-99 System Panel Connections



# III. HARDWARE SETUP

---

## Power Connection Procedures

1. After all connections are made, close the system case cover.
  2. Be sure that all switches are off (in some systems, marked with ○).
  3. Connect the power supply cord into the power supply located on the back of your system case according to your system user's manual.
  4. Connect the power cord into a power outlet that is equipped with a surge protector.
  5. You may then turn on your devices in the following order:
    - a. Your monitor
    - b. External SCSI devices (starting with the last device on the chain)
    - c. Your system power. For ATX power supplies, you need to switch on the power supply if a switch is provided as well as press the ATX power switch on the front of the case.
  6. The power LED on the front panel of the system case will light. For ATX power supplies, the system LED will light when the ATX power switch is pressed. The LED on the monitor may light up or switch between orange and green after the system's if it complies with "green" standards or if it has a power standby feature. The system will then run power-on tests. While the tests are running, additional messages will appear on the screen. If you do not see anything within 30 seconds from the time you turn on the power, the system may have failed a power-on test. Recheck your jumper settings and connections or call your retailer for assistance.
  7. During power-on, hold down <Delete> to enter BIOS setup. Follow the instructions in the next section, BIOS SETUP.
- \* **Powering Off your computer:** You must first exit or shut down your operating system before switching off the power switch. For ATX power supplies, you can press the ATX power switch after exiting or shutting down your operating system. If you use Windows 95/98, click the **Start** button, click **Shut Down**, and then click **Shut down the computer?**. The power supply should turn off after Windows shuts down.

**NOTE:** The message "You can now safely turn off your computer" will not appear when shutting down with ATX power supplies.

# IV. BIOS SETUP

## Flash Memory Writer Utility

**AFLASH.EXE:** This is the Flash Memory Writer utility that updates the BIOS by uploading a new BIOS file to the programmable flash ROM chip on the motherboard. To determine the BIOS version of your motherboard, check the last four numbers of the code displayed on the upper left-hand corner of your screen during bootup. Larger numbers represent a newer BIOS file. This file works only in DOS mode.

**NOTE:** The following screen displays are provided as examples only and may not reflect the screen contents displayed on your system.

```
          ACPI BIOS
    FLASH MEMORY WRITER V1.013
    Copyright (C) 1994-99, ASUS/STAK COMPUTER, INC.

Flash Memory: Winbond W25C009 or SST 23C020

Current BIOS Version: ASUS XXX-XX ACPI BIOS Revision 100X
BIOS Model          : XXX-XX
BIOS Built Date     : 03/25/98

Choose one of the following:
1. Save Current BIOS To File
2. Update BIOS Including Boot Block and ESCD

Enter choice: [1]

Press ESC To Exit
```

**IMPORTANT!** If “unknown” is displayed after **Flash Memory:**, the memory chip is either not programmable or is not supported by the ACPI BIOS and therefore, cannot be programmed by the Flash Memory Writer utility.

## Main Menu

### 1. Save Current BIOS To File

This option allows you to save a copy of the original motherboard BIOS in case you need to reinstall it. It is recommended that you save **AFLASH.EXE** and the BIOS file to a bootable floppy disk.

To save your current BIOS, type [1] at the **Main Menu** and then press <Enter>. The **Save Current BIOS To File** screen appears.

Type a filename and the path, for example, **A:\XXX-XX.XXX** and then press <Enter>.

```
          Save Current BIOS To File

Flash Memory: Winbond W25C009 or SST 23C020

Current BIOS Version: ASUS XXX-XX ACPI BIOS Revision 100X
BIOS Model          : XXX-XX
BIOS Built Date     : 03/25/98

Please Enter File Name to Save: XXX-XX.XXX

BIOS Saved Successfully

Press ESC To Continue
```

# IV. BIOS SETUP

## 2. Update BIOS Including Boot Block and ESCD

This option updates the boot block, the baseboard BIOS, and the ACPI extended system configuration data (ESCD) parameter block from a new BIOS file. See the next page for procedures on downloading an updated BIOS file.

To update your current BIOS, type [2] at the **Main Menu** and then press <Enter>. The **Update BIOS Including Boot Block and ESCD** screen appears. Type the filename of your new BIOS and the path, for example, **A:\XXX-XX.XXX**, and then press <Enter>.

When prompted to confirm the BIOS update, press **Y** to start the update.

The utility starts to program the new BIOS information into the flash ROM. When the programming is finished, *Flashed Successfully* will be displayed.

Follow the onscreen instructions to continue.

```
Update BIOS Including Boot Block and ESCD
Flash Memory: Winbond W29C020 or SST 29E020
Current BIOS Version: ASUS X00-XX ACPI BIOS Revision 1000
BIOS Model : X00-XX
BIOS Build Date : 00/25/00
Please Enter File Name for NEW BIOS: A\X000-X0J00
```

```
Update BIOS Including Boot Block and ESCD
Flash Memory: Winbond W29C020 or SST 29E020
BIOS Version
CURRENT 3 ASUS X00-XX ACPI BIOS Revision 1000
Flash.umd3 ASUS X00-XX ACPI BIOS Revision 1000
BIOS Model
CURRENT 3 X00-XX
Flash.umd3 X00-XX
Date of BIOS Build
CURRENT 3 00/25/00
D0000.X0013 00/25/00
Check sum of X000.X000 is C370.
Are you sure (Y/N) ? Y
Press ESC To Return to Main Menu
```

```
Update BIOS Including Boot Block and ESCD
Flash Memory: Winbond W29C020 or SST 29E020
BIOS Version
CURRENT 3 ASUS X00-XX ACPI BIOS Revision 1000
Flash.umd3 ASUS X00-XX ACPI BIOS Revision 1000
BIOS Model
CURRENT 3 X00-XX
Flash.umd3 X00-XX
Date of BIOS Build
CURRENT 3 00/25/00
D0000.X0013 00/25/00
Check sum of X000.X000 is C370.
Are you sure (Y/N) ? Y
Programming -- 3FFFF
Flashed Successfully
Press ESC To Return to Main Menu
```

```
ASUS ACPI BIOS
FLASH MEMORY WRITER V1.013
Copyright (C) 1994-99, ASESTEK COMPUTER INC.
Flash Memory: Winbond W29C020 or SST 29E020
Current BIOS Version: ASUS X00-XX ACPI BIOS Revision 1000
BIOS Model : X00-XX
BIOS Build Date : 00/25/00
Choose one of the following:
1. Save Current BIOS To File
2. Update BIOS Including Boot Block and ESCD
Enter choice: 13
You have flashed the EPROM! It is recommended that you turn off
the power, enter SETUP and Load Setup Defaults to have CMOS
updated with new BIOS when exits.
Press ESC To Exit
```

IV. BIOS SETUP  
Flash Memory Writer

# IV. BIOS SETUP

---

## Managing and Updating Your Motherboard's BIOS

### Upon First Use of the Computer System

1. Create a bootable system floppy disk by typing [FORMAT A:/S] from the DOS prompt.
2. Copy AFLASH.EXE to the just created boot disk.
3. Run AFLASH.EXE from this new disk and select option **1. Save Current BIOS to File**. See **1. Save Current BIOS To File** on the previous page for more details and the rest of the steps.

### Updating BIOS Procedures (only when necessary)

1. Download an updated ASUS BIOS file from the Internet (WWW or FTP) or a BBS (Bulletin Board Service) (see ASUS CONTACT INFORMATION on page 3 for details) and save to the disk you created earlier.
2. Boot from the disk you created earlier.
3. At the "A:\>" prompt, type **AFLASH** and then press <Enter>.
4. At the **Main Menu**, type **2** and then press <Enter>. See **2. Update BIOS Including Boot Block and ESCD** on the previous page for more details and the rest of the steps.

**WARNING!** If you encounter problems while updating the new BIOS, DO NOT turn off your system since this might prevent your system from booting up. Just repeat the process, and if the problem still persists, update the original BIOS file you saved to disk above. If the Flash Memory Writer utility was not able to successfully update a complete BIOS file, your system may not be able to boot up. If this happens, your system will need service.

# IV. BIOS SETUP

## 6. BIOS Setup

The motherboard supports a 5V programmable Flash ROM chip. Either of these memory chips can be updated when BIOS upgrades are released. Use the Flash Memory Writer utility to download the new BIOS file into the ROM chip as described in detail in this section.

All computer motherboards provide a Setup utility program for specifying the system configuration and settings. If your motherboard came in a computer system, the proper configuration entries may have already been made. If so, invoke the Setup utility, as described later, and take note of the configuration settings for future reference; in particular, the hard disk specifications.

If you are installing the motherboard, reconfiguring your system or you receive a Run Setup message, you will need to enter new setup information. This section describes how to configure your system using this utility.

The BIOS ROM of the system stores the Setup utility. When you turn on the computer, the system provides you with the opportunity to run this program. This appears during the Power-On Self Test (POST). Press <Delete> to call up the Setup utility. If you are a little bit late pressing the mentioned key(s), POST will continue with its test routines, thus preventing you from calling up Setup. If you still need to call Setup, reset the system by pressing <Ctrl> + <Alt> + <Delete>, or by pressing the Reset button on the system case. You can also restart by turning the system off and then back on again. But do so only if the first two methods fail.

When you invoke Setup, the CMOS SETUP UTILITY main program screen will appear with the following options:



# IV. BIOS SETUP

## Load Defaults

The “Load BIOS Defaults” option loads the minimum settings for troubleshooting. “**Load Setup Defaults**”, on the other hand, is for loading optimized defaults for regular use. Choosing defaults at this level, will modify all applicable settings.

A section at the bottom of the above screen displays the control keys for this screen. Take note of these keys and their respective uses. Another section just below the control keys section displays information on the currently highlighted item in the list.

## Standard CMOS Setup

The “Standard CMOS Setup” option allows you to record some basic system hardware configuration and set the system clock and error handling. If the motherboard is already installed in a working system, you will not need to select this option anymore. However, if the configuration stored in the CMOS memory on the board gets lost or damaged, or if you change your system hardware configuration, you will need to re-specify the configuration values. The configuration values usually get lost or corrupted when the power of the onboard CMOS battery weakens.



The preceding screen provides you with a list of options. At the bottom of this screen are the control keys for this screen. Take note of these keys and their respective uses.

User-configurable fields appear in a different color. If you need information on the selected field, press <F1>. The help menu will then appear to provide you with the information you need. The memory display at the lower right-hand side of the screen is read-only and automatically adjusts accordingly.

## Details of Standard CMOS Setup

### Date

To set the date, highlight the “Date” field and then press either <Page Up>/<Page Down> or <+>/<-> to set the current date. Follow the month, day and year format. Valid values for month, day and year are: **Month: (1 to 12), Day: (1 to 31), Year: (up to 2079).**



# IV. BIOS SETUP

---

## Time

To set the time, highlight the “Time” field and then press either <Page Up>/<Page Down> or <+>/<-> to set the current time. Follow the hour, minute and second format. Valid values for hour, minute and second are: (**Hour: (00 to 23)**, **Minute: (00 to 59)**, **Second: (00 to 59)**).

**NOTE:** You can bypass the date and time prompts by creating an AUTOEXEC.BAT file. For information on how to create this file, please refer to the MS-DOS manual.

## Hard Disks

This field records the specifications for all non-SCSI hard disk drives installed in your system. The onboard PCI IDE connectors provide Primary and Secondary channels for connecting up to four IDE hard disks or other IDE devices. Each channel can support up to two hard disks; the first of which is the “master” and the second is the “slave”.

Specifications for SCSI hard disks need not to be entered here since they operate using device drivers and are not supported by the BIOS. If you install other SCSI controller cards, refer to their respective documentations on how to install the required SCSI drivers.

### For IDE hard disk drive setup, you can:

- Use the *Auto* setting for detection during bootup.
- Use the IDE HDD AUTO DETECTION in the main menu to automatically enter the drive specifications.
- Enter the specifications yourself manually by using the “User” option.

The entries for specifying the hard disk type include **CYLS** (number of cylinders), **HEAD** (number of read/write heads), **PRECOMP** (write precompensation), **LANDZ** (landing zone), **SECTOR** (number of sectors) and **MODE**. The **SIZE** field automatically adjusts according to the configuration you specify. The documentation that comes with your hard disk should provide you with the information regarding the drive specifications.

The **MODE** entry is for IDE hard disks only, and can be ignored for MFM and ESDI drives. This entry provides three options: *Normal*, *Large*, *LBA*, or *Auto* (see below). Set **MODE** to the *Normal* for IDE hard disk drives smaller than 528MB; set it to *LBA* for drives over 528MB that support Logical Block Addressing (LBA) to allow larger IDE hard disks; set it to *Large* for drives over 528MB that do not support LBA. *Large* type of drive can only be used with MS-DOS and is very uncommon. Most IDE drives over 528MB support the *LBA* mode.

# IV. BIOS SETUP

---

## Auto detection of hard disks on bootup

For each field: Primary Master, Primary Slave, Secondary Master, and Secondary Slave, you can select *Auto* under the TYPE and MODE fields. This will enable auto detection of your IDE hard disk during bootup. This will allow you to change your hard disks (with the power off) and then power on without having to reconfigure your hard disk type. If you use older hard disks that do not support this feature, then you must configure the hard disk in the standard method as described earlier by the “User” option.

**NOTE:** After the IDE hard disk drive information has been entered into BIOS, new IDE hard disk drives must be partitioned (such as with FDISK) and then formatted before data can be read from and write on. Primary IDE hard disk drives must have its partition set to *active* (also possible with FDISK).

**NOTE:** SETUP Defaults are noted in parenthesis next to each function heading.

## Drive A / Drive B

These fields record the types of floppy disk drives installed in your system. The available options for drives A and B are: *360K, 5.25 in.; 1.2M, 5.25 in.; 720K, 3.5 in.; 1.44M, 3.5 in.; 2.88M, 3.5 in.; None*

To enter the configuration value for a particular drive, highlight its corresponding field and then select the drive type using the <page up>/<page down> or <+>/<-> keys.

## Floppy 3 Mode Support

This is the Japanese standard floppy drive. The standard stores 1.2MB in a 3.5inch diskette. This is normally disabled but you may choose from either: *Drive A, Drive B, Both, and Disabled.*

## Video

Set this field to the type of video display card installed in your system. The options are *EGA/VGA, CGA 40, CGA 80, and MONO* (for Hercules or MDA).

If you are using a VGA or any higher resolution card, choose *EGA/VGA.*

## Halt On

This field determines which types of errors will cause the system to halt. Choose from *All Errors; No Errors; All,But Keyboard, All,But Diskette; and All,But Disk/Key.*

# IV. BIOS SETUP

## BIOS Features Setup

The “BIOS Features Setup” option consists of configuration entries that allow you to improve your system performance, or let you set up some system features according to your preference. Some entries are required by the motherboard’s design to remain in their default settings.



A section at the lower right of the screen displays the control keys you can use. Take note of these keys and their respective uses. If you need information on a particular entry, highlight it and then press <F1>. A pop-up help menu will appear to provide you with the information you need. <F5> loads the last set values, <F6> and <F7> loads the BIOS default values and Setup default values, respectively.

**NOTE:** SETUP Defaults are noted in parenthesis next to each function heading.

### Details of BIOS Features Setup

#### CPU Internal Core Speed

This function is reserved for future use and is currently disabled.

#### Boot Virus Detection (Enabled)

This field allows you to set boot virus detection, ensuring a virus-free boot sector. This new antivirus solution is unlike native BIOS tools, which offer limited virus protection typically by write-protecting the partition table. With this new solution, your computer is protected against boot virus threats earlier in the boot cycle, that is, before they have a chance to load into your system. This ensures your computer boots to a clean operating system. The system halts and displays a warning message when it detects a virus. If this occurs, you can either allow the operation to continue or use a virus-free bootable floppy disk to restart and investigate your system. Because of conflicts with new operating systems, for example, during installation of new software, you may have to set this to *Disabled* to prevent write errors.

# IV. BIOS SETUP

---

## **Processor Serial Number (Enabled)**

The Processor Serial Number is a unique electronic number that is added to every Pentium III processor to help verify the identity of the user across the Internet. Set this field to *Enabled* when you need increased security for doing business online or e-commerce. Otherwise, set it to *Disabled* for greater anonymity when surfing the Internet.

## **CPU Level 1 Cache / CPU Level 2 Cache (Enabled)**

These fields allow you to choose from the default of *Enabled* or choose *Disabled* to turn on or off the CPU's Level 1 and Level 2 built-in cache.

## **CPU Level 2 Cache ECC Check (Disabled)**

This function controls the ECC check capability in the CPU level 2 cache.

## **BIOS Update (Enabled)**

This functions as an update loader integrated into the BIOS to supply the processor with the required data. The BIOS will load the update on all processors during system bootup in the default position of *Enabled*.

## **Quick Power On Self Test (Enabled)**

This field speeds up the Power-On Self Test (POST) routine by skipping retesting a second, and third time. Setup default setting for this field is *Enabled*. A complete test of the system memory is done on each test.

## **HDD Sequence SCSI/IDE First (IDE)**

When using both SCSI and IDE hard disk drives, IDE is always the boot disk using drive letter C (default setting of *IDE*). This new feature allows a SCSI hard disk drive to be the boot disk when set to *SCSI*. This allows multiple operating systems to be used on both IDE and SCSI drives or the primary operating system to boot using a SCSI hard disk drive.

## **Boot Sequence (A,C)**

This field determines where the system looks first for an operating system. Options are *A,C*; *C,A*; *A,CDROM,C*; *CDROM,C,A*; *CDROM,A,C,D,A*; *E,A*; *F,A*; *C only*; *LS/ZIP, C*; *LAN,A,C*; and *LAN,C,A*. The setup default setting, *A, C*, is to check first the floppy disk and then the hard disk drive.

## **Boot Up Floppy Seek (Disabled)**

When enabled, the BIOS will seek drive A once.

## **Floppy Disk Access Control (R/W)**

This allows protection of files from the computer system to be copied to floppy disks by allowing the setting of *Read Only* to only allow reads from the floppy disk drive but not writes. The setup default *R/W* allows both reads and writes.

## **IDE HDD Block Mode Sectors (HDD MAX)**

This field enhances hard disk performance by making multi-sector transfers instead of one sector per transfer. Most IDE drives, except older versions, can utilize this feature. Selections are *HDD MAX*, *Disabled*, *2*, *4*, *8*, *16*, and *32*.

## **HDD S.M.A.R.T. capability (Disabled)**

This allows the enabling or disabling of the S.M.A.R.T. (Self-Monitoring, Analysis and Reporting Technology) system which utilizes internal hard disk drive monitoring technology. This feature is normally disabled because system resources used in this feature may decrease system performance.

# IV. BIOS SETUP

---

## **PS/2 Mouse Function Control (Auto)**

The default of *Auto* allows the system to detect a PS/2 mouse on bootup. If detected, IRQ12 will be used for the PS/2 mouse. IRQ12 will be reserved for expansion cards if a PS/2 mouse is not detected. *Enabled* will always reserve IRQ12, whether on bootup a PS/2 mouse is detected or not.

## **OS/2 Onboard Memory > 64M (Disabled)**

When using OS/2 operating systems with installed DRAM of greater than 64MB, you need to set this option to *Enabled* otherwise leave this on *Disabled*.

.....

## **PCI/VGA Palette Snoop (Disabled)**

Some display cards that are nonstandard VGA such as graphics accelerators or MPEG Video Cards may not show colors properly. The setting *Enabled* should correct this problem. Otherwise leave this on the setup default setting of *Disabled*.

## **Video ROM BIOS Shadow (Enabled)**

This field allows you to change the video BIOS location from ROM to RAM. Relocating to RAM enhances system performance, as information access is faster than the ROM.

## **C8000-CBFFF to DC000-DFFFF (Disabled)**

These fields are used for shadowing other expansion card ROMs. If you install other expansion cards with ROMs on them, you will need to know which addresses the ROMs use to shadow them specifically. Shadowing a ROM reduces the memory available between 640K and 1024K by the amount used for this purpose.

## **Boot Up NumLock Status (On)**

This field enables users to activate the Number Lock function upon system boot.

## **Typematic Rate Setting (Disabled)**

When enabled, you can set the two typematic controls listed next. Setup default setting is *Disabled*.

## **Typematic Rate (Chars/Sec) (6)**

This field controls the speed at which the system registers repeated keystrokes. Options range from 6 to 30 characters per second. Setup default setting is **6**; other settings are 8, 10, 12, 15, 20, 24, and 30.

## **Typematic Delay (Msec) (250)**

This field sets the time interval for displaying the first and second characters. Four delay rate options are available: 250, 500, 750, and 1000.

## **Security Option (System)**

When you specify a *Supervisor Password* and/or *User Password* (explained later in this section), the Security Option field determines when the system prompts for the password. The default setting is *System*, where the system prompts for the User Password every time you start your system. The other option is *Setup*, where the system goes through its startup routine unless the Setup utility is called, when the system prompts for the Supervisor Password.



# IV. BIOS SETUP

## Chipset Features Setup

The “Chipset Features Setup” option controls the configuration of the board’s chipset.



**NOTE:** SETUP Defaults are noted in parenthesis next to each function heading.

### Details of Chipset Features Setup

#### SDRAM Configuration (By SPD)

This sets the optimal timings of settings for items 2–5, depending on the memory modules that you are using. Default setting is *By SPD*, which configures items 2–5 by reading the contents in the SPD (Serial Presence Detect) device. This 8-pin serial EEPROM device stores critical parameter information about the module, such as memory type, size, speed, voltage interface, and module banks.

#### SDRAM CAS Latency

This controls the latency between SDRAM read command and the time that the data actually becomes available. Leave on default setting.

#### SDRAM RAS to CAS Delay

This controls the latency between SDRAM active command and the read/write command. Leave on default setting.

#### SDRAM RAS Precharge Time

This controls the idle clocks after issuing a precharge command to SDRAM. Leave on default setting.

#### DRAM Idle Timer

This controls the idle clocks before closing an opened SDRAM page. Leave on default setting.

#### SDRAM MA Wait State (Normal)

This controls the leadoff clocks for CPU read cycles. Leave on default setting.

#### Snoop Ahead (Enabled)

*Enabled* will allow PCI streaming. Leave on default setting.

#### Host Bus Fast Data Ready (Disabled)

Leave on default setting.



# IV. BIOS SETUP

---

## **16-bit I/O Recovery Time (1 BUSCLK) / 8-bit I/O Recovery Time (1 BUSCLK)**

Timing for 16-bit and 8-bit ISA cards, respectively. Leave on default setting.

## **Graphics Aperture Size (64MB)**

Memory-mapped, graphics data structures can reside in a Graphics Aperture. Leave on default setting.

## **Video Memory Cache Mode (UC)**

*USWC* (uncacheable, speculative write combining) is a new cache technology for the video memory of the processor. It can greatly improve the display speed by caching the display data. You must leave this on the default setting of *UC* (uncacheable) if your display card cannot support this feature, otherwise your system may not boot.

## **PCI 2.1 Support (Enabled)**

This function allows you to enable or disable PCI 2.1 features including passive release and delayed transaction. Leave *Enabled* (default setting) for PCI 2.1 compliancy.

## **Memory Hole At 15M–16M (Disabled)**

Enabling this feature reserves 15MB to 16MB memory address space to ISA expansion cards that specifically require this setting. This makes the memory from 15MB and up unavailable to the system. Expansion cards can only access memory up to 16MB. The default is *Disabled*.

---

## **Onboard FDC Controller (Enabled)**

When *Enabled*, this field allows you to connect your floppy disk drives to the onboard floppy disk drive connector instead of a separate controller card. If you want to use a different controller card to connect the floppy disk drives, set this field to *Disabled*.

## **Onboard FDC Swap A & B (No Swap)**

This field allows you to reverse the hardware drive letter assignments of your floppy disk drives. Two options are available: *No Swap* and *Swap AB*. If you want to switch drive letter assignments through the onboard chipset, set this field to *Swap AB*.

## **Onboard Serial Port 1 (3F8H/IRQ4)**

Settings are *3F8H/IRQ4*, *2F8H/IRQ3*, *3E8H/IRQ4*, *2E8H/IRQ10*, and *Disabled* for the onboard serial connector.

## **Onboard Serial Port 2 (2F8H/IRQ3)**

Settings are *3F8H/IRQ4*, *2F8H/IRQ3*, *3E8H/IRQ4*, *2E8H/IRQ10*, and *Disabled* for the onboard serial connector.

# IV. BIOS SETUP

---

## **Onboard Parallel Port (378H/IRQ7)**

This field sets the address of the onboard parallel port connector. You can select either: *378H / IRQ 7*, *278H / IRQ 5*, *Disabled*. If you install an I/O card with a parallel port, ensure that there is no conflict in the address assignments. The PC can support up to three parallel ports as long as there are no conflicts for each port.

## **Parallel Port Mode (ECP+EPP)**

This field allows you to set the operation mode of the parallel port. The setting *Normal*, allows normal-speed operation but in one direction only; *EPP* allows bidirectional parallel port operation at maximum speed; *ECP* allows the parallel port to operate in bidirectional mode and at a speed faster than the maximum unidirectional data transfer rate; *ECP+EPP* allows normal speed operation in a two-way mode.

## **ECP DMA Select (3)**

This selection is available only if you select *ECP* or *ECP+EPP* in the **Parallel Port Mode**. Select either DMA Channel *1*, *3*, or *Disable*.

## **UART2 Use Infrared (Disabled)**

When enabled, this field activates the onboard infrared feature and sets the second serial UART to support the infrared module connector on the motherboard. If your system already has a second serial port connected to the onboard COM2 connector, it will no longer work if you enable the infrared feature. By default, this field is set to *Disabled*, which leaves the second serial port UART to support the COM2 serial port connector. See **IrDA-compliant infrared module connector** under in **HARDWARE SETUP**.

## **Onboard PCI IDE Enable (Both)**

You can select to enable the *primary* IDE channel, *secondary* IDE channel, *both*, or *disable* both channels (for systems with only SCSI drives).

## **IDE Ultra DMA Mode (Auto)**

This field autodetects Ultra DMA capability (for improved transfer speeds and data integrity) for compatible IDE devices. Set to *Disable* to suppress Ultra DMA capability.

## **IDE 0 Master/Slave PIO/DMA Mode, IDE 1 Master/Slave PIO/DMA Mode (Auto)**

Each channel (0 and 1) has both a master and a slave making four IDE devices possible. Because each IDE device may have a different Mode timing (0, 1, 2, 3, 4), it is necessary for these to be independent. The default setting of *Auto* will allow autodetection to ensure optimal performance.

# IV. BIOS SETUP

## Power Management Setup

The “Power Management Setup” option allows you to reduce power consumption. This feature turns off the video display and shuts down the hard disk after a period of inactivity.



**NOTE:** SETUP Defaults are noted in parenthesis next to each function heading.

### Details of Power Management Setup

#### Power Management (User Define)

This field acts as the master control for the power management modes. *Max Saving* puts the system into power saving mode after a brief period of system inactivity; *Min Saving* is almost the same as *Max Saving* except that this time the system inactivity period is longer; *Disable* disables the power saving features; *User Define* allows you to set power saving options according to your preference.

**IMPORTANT:** Advanced Power Management (APM) should be installed to keep the system time updated when the computer enters suspend mode activated by the BIOS Power Management. For DOS environments, you need to add the statement, `DEVICE=C:\DOS\POWER.EXE`, in you `CONFIG.SYS`. For Windows 3.x and Windows 95, you need to install Windows with the APM feature. A battery and power cord icon labeled “Power” will appear in the “Control Panel.” Choose “Advanced” in the Power Management Field.

#### Video Off Option (Suspend -> Off)

This field determines when to activate the video off feature for monitor power management. The settings are *Always On* and *Suspend -> Off*.

## IV. BIOS SETUP

---

### **Video Off Method (DPMS OFF)**

This field defines the video off features. The following options are available: *DPMS OFF*, *DPMS Reduce ON*, *Blank Screen*, *V/H SYNC+Blank*, *DPMS Standby*, and *DPMS Suspend*. The DPMS (Display Power Management System) features allow the BIOS to control the video display card if it supports the DPMS feature. *Blank Screen* only blanks the screen (use this for monitors without power management or “green” features. If set up in your system, your screen saver will not display with *Blank Screen* selected). *V/H SYNC+Blank* blanks the screen and turns off vertical and horizontal scanning.

.....

### **PM Timers**

This section controls the time-out settings for the Power Management scheme. The fields included in this section are “HDD Power Down”, which places the hard disk into its lowest power consumption mode, and the “Suspend Mode” which suspends the CPU.

The system automatically “wakes up” from any power saving mode when there is system activity such as when a key is pressed from the keyboard, or when there is activity detected from the enabled IRQ channels.

### **HDD Power Down (Disable)**

Shuts down any IDE hard disk drives in the system after a period of inactivity. This time period is user-configurable to *1–15 Min* or *Disable*. This feature does not affect SCSI hard drives.

### **Suspend Mode (Disable)**

Sets the period of time after which the suspend mode activates: *30 sec*, *1 Min*, *2 Min*, *4 Min*, *8 Min*, *20 Min*, *30 Min*, *40 Min*, *1 Hour*, and *Disable*.

.....

### **Power Up Control**

This section determines the ways the system can be controlled when it is started or restarted, when modem activity is detected, or when power to the computer is interrupted and reapplied. The Soft-Off mode refers to powering off the system through a momentary button switch (ATX switch) or through the software as opposed to disconnecting the AC power by way of a rocker switch or other means.

### **PWR Button < 4 Secs (Soft Off)**

When set to *Soft Off*, the ATX switch can be used as a normal system power-off button when pressed for less than 4 seconds. *Suspend* allows the button to have a dual function where pressing less than 4 seconds will place the system in sleep mode. Regardless of the setting, holding the ATX switch for more than 4 seconds will power off the system.

# IV. BIOS SETUP

---

## **PWR Up On Modem Act (Enabled)**

This allows either settings of *Enabled* or *Disabled* for powering up the computer (turns the ATX power supply on) when the modem receives a call while the computer is Soft-off.

**NOTE:** The computer cannot receive or transmit data until the computer and applications are fully running, thus connection cannot be made on the first try. Turning an external modem off and then back on while the computer is off causes an initialization string that will also cause the system to power on.

## **AC PWR Loss Restart (Disabled)**

This allows you to set whether you want your system to boot up after the power has been interrupted. *Disabled* leaves your system off after reapplying power and *Enabled* boots up your system after reapplying power.

## **Wake On LAN (Disabled)**

This allows you to remotely power up your system through your network by sending a wake-up frame or signal. With this feature, you can remotely upload/download data to/from systems during off-peak hours. *Enabled* sets this feature.

**IMPORTANT:** This feature requires the optional network interface and an ATX power supply with at least 720mA +5V standby power.

## **Automatic Power Up (Disabled)**

This allows you to have an unattended or automatic power up of your system. You may configure your system to power up at a certain time of the day by selecting *Everyday*, which will allow you to set the time or at a certain time and day by selecting *By Date*.

.....

## ***Fan Monitor (xxxxRPM) – only with optional hardware monitor***

The onboard hardware monitor is able to detect the Chassis Fan Speed, CPU Fan Speed, and the Power Supply Fan Speed in Rotations Per Minute (RPM). Set to *Ignore* if one of these are not used so that error messages will not be given.

.....

## ***Thermal Monitor (xxxC/xxxF) – only with optional hardware monitor***

The onboard hardware monitor is able to detect the CPU and MB (motherboard) temperatures. Set to *Ignore* only if necessary.

.....

## ***Voltage Monitor (xx.xV) – only with optional hardware monitor***

The onboard hardware monitor is able to detect the voltages put out by the voltage regulators. Set to *Ignore* only if necessary.

**NOTE:** If any of the monitored items are out of range, an error message will appear: “Hardware Monitor found an error, enter POWER MANAGEMENT SETUP for details”. You will then be prompted to “Press **F1** to continue, **DEL** to enter SETUP”.



# IV. BIOS SETUP

## PNP and PCI Setup

The “PNP and PCI Setup” option configures the PCI bus slots. All PCI bus slots on the system use INTA#, thus all installed PCI cards must be set to this value.



**NOTE:** SETUP Defaults are noted in parenthesis next to each function heading.

### Details of PNP and PCI Setup

#### PNP OS Installed (No)

This field allows you to use a Plug-and-Play (PnP) operating system to configure the PCI bus slots instead of using the BIOS. Thus interrupts may be reassigned by the OS when *Yes* is selected. When a non-PnP OS is installed or to prevent reassigning of interrupt settings, select the default setting of *No*.

#### Slot 1 / Slot 2 / Slot 3 / Slot 4 IRQ (Auto)

These fields set how IRQ use is determined for each PCI slot. The default setting for each field is *Auto*, which uses auto-routing to determine IRQ use. The other options are manual settings of *NA*, *3*, *4*, *5*, *7*, *9*, *10*, *11*, *12*, *14* or *15* for each slot.

#### PCI Latency Timer (32 PCI Clock)

The default setting of *32 PCI Clock* enables maximum PCI performance for this motherboard.

#### IRQ xx Used By ISA (No/ICU)

These fields indicate whether or not the displayed IRQ for each field is being used by a legacy (non-PnP) ISA card. Two options are available: *No/ICU* and *Yes*. The first option, the default value, indicates either that the displayed IRQ is not used or an ISA Configuration Utility (ICU) is being used to determine if an ISA card is using that IRQ. If you install a legacy ISA card that requires a unique IRQ, and you are not using an ICU, you must set the field for that IRQ to *Yes*. For example: If you install a legacy ISA card that requires IRQ 10, then set **IRQ10 Used By ISA** to *Yes*.

.....



## IV. BIOS SETUP

---

### **DMA x Used By ISA (No/ICU)**

These fields indicate whether or not the displayed DMA channel for each field is being used by a legacy (non-PnP) ISA card. Available options include: *No/ICU* and *Yes*. The first option, the default setting, indicates either that the displayed DMA channel is not used or an ICU is being used to determine if an ISA card is using that channel. If you install a legacy ISA card that requires a unique DMA channel, and you are not using an ICU, you must set the field for that channel to *Yes*.

### **ISA MEM Block BASE (No/ICU)**

This field allows you to set the base address and block size of a legacy ISA card that uses any memory segment within the C800H and DFFFH address range. If you have such a card, and you are not using an ICU to specify its address range, select a base address from the six available options; the **ISA MEM Block SIZE** field will then appear for selecting the block size. If you have more than one legacy ISA card in your system that requires to use this address range, you can increase the block size to either 8K, 16K, 32K, or 64K. If you are using an ICU to accomplish this task, leave **ISA MEM Block BASE** to its default setting of *No/ICU*.

### **Symbios SCSI BIOS (Auto)**

*Auto* allows the BIOS to detect whether you have a Symbios SCSI card, if detected the onboard Symbios BIOS will be enabled, if not then it will be disabled. *Disabled* prevents the onboard Symbios BIOS to be enabled so that the external Symbios SCSI card's own BIOS can be used instead. **Note:** If your Symbios SCSI card does not have a BIOS, the Symbios SCSI card will not function.

### **USB IRQ (Enabled)**

*Enabled* reserves an IRQ# for the USB to work, *Disabled* does not allow the USB to have an IRQ# and therefore prevents the USB from functioning. If you are not using any USB devices, you may set this feature to *Disabled* to save an extra IRQ# for expansion cards.

### **VGA BIOS Sequence (PCI/AGP)**

You can select the search order for your VGA card(s). *PCI/AGP* will detect PCI VGA cards before AGP, and *AGP/PCI* will detect AGP cards before PCI VGA.

# IV. BIOS SETUP

## Load BIOS Defaults

The “Load BIOS Defaults” option allows you to load the troubleshooting default values permanently stored in the BIOS ROM. These default settings are non-optimal and disable all high performance features. To load these default settings, highlight “Load BIOS Defaults” on the main screen and then press <Enter>. The system displays a confirmation message on the screen. Press <Y> and then <Enter> to confirm. Press <N> and then <Enter> to abort. This feature does not affect the fields on the Standard CMOS Setup screen.

## Load Setup Defaults

The “Load Setup Defaults” option allows you to load the default values to the system configuration fields. These default values are the optimized configuration settings for the system. To load these default values, highlight “Load Setup Defaults” on the main screen and then press <Enter>. The system displays a confirmation message on the screen. Press <Y> and then <Enter> to confirm. Press <N> and then <Enter> to abort. This feature does not affect the fields on the Standard CMOS Setup screen.



# IV. BIOS SETUP

## Supervisor Password and User Password

These two options set the system passwords. “Supervisor Password” sets a password that will be used to protect the system and the Setup utility; “User Password” sets a password that will be used exclusively on the system. By default, the system comes without any passwords. To specify a password, highlight the type you want and then press <Enter>. A password prompt appears on the screen. Taking note that the password is case sensitive, and can be up to 8 alphanumeric characters long, type in your password and then press <Enter>. The system confirms your password by asking you to type it again. After setting a password, the screen automatically reverts to the main screen.



To implement password protection, specify in the “Security Option” field of the BIOS Features Setup screen when the system will prompt for the password. If you want to disable either password, press <Enter> instead of entering a new password when the “Enter Password” prompt appears. A message confirms the password has been disabled.

### Forgot the password?

If you forgot the password, you can clear the password by erasing the CMOS Real Time Clock (RTC) RAM. The RAM data containing the password information is powered by the onboard button cell battery. To erase the RTC RAM: (1) Unplug your computer, (2) Short the solder points, (3) Turn ON your computer, (4) Hold down <Delete> during bootup and enter BIOS setup to re-enter user preferences.

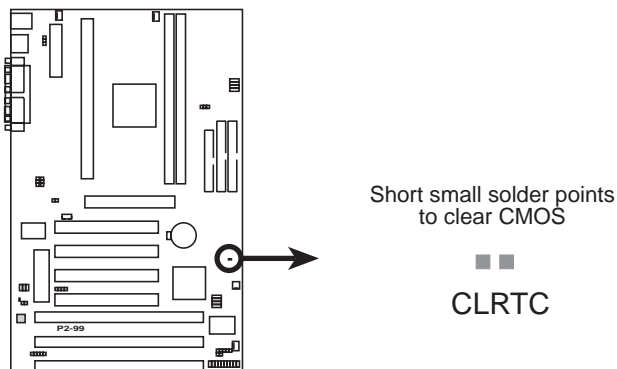

**P2-99 Clear RTC RAM**

# IV. BIOS SETUP

## IDE HDD Auto Detection

The “IDE HDD Auto Detection” option detects the parameters of an IDE hard disk drive, and automatically enters them into the Standard CMOS Setup screen.

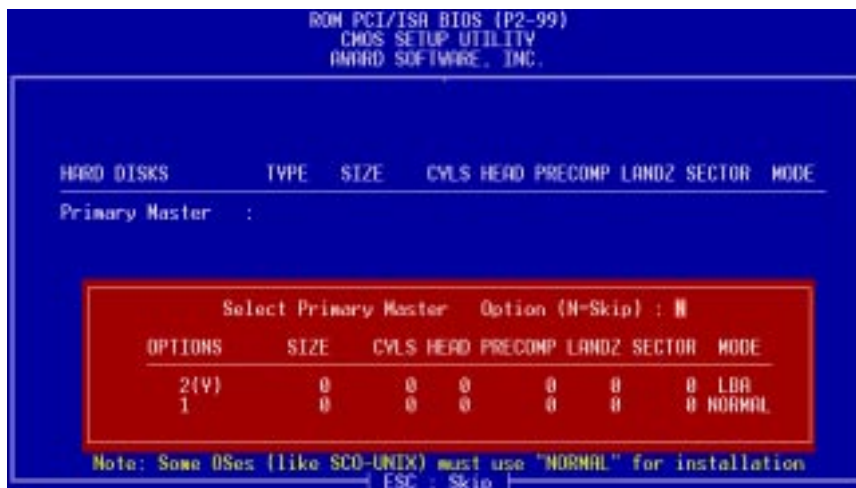

Up to four IDE drives can be detected, with parameters for each listed inside the box. To accept the optimal entries, press <Y> or else select from the numbers displayed under the OPTIONS field (2, 1, 3 in this case); to skip to the next drive, press <N>. If you accept the values, the parameters will appear listed beside the drive letter on the screen. The process then proceeds to the next drive letter. Pressing <N> to skip rather than to accept a set of parameters causes the program to enter zeros after that drive letter.

Remember that if you are using another IDE controller that does not feature Enhanced IDE support for four devices, you can only install two IDE hard disk drives. Your IDE controller must support the Enhanced IDE features in order to use Drive E and Drive F. The onboard PCI IDE controller supports Enhanced IDE, with two connectors for connecting up to four IDE devices. If you want to use another controller that supports four drives, you must disable the onboard IDE controller in the Chipset Features Setup screen.

When auto-detection is completed, the program automatically enters all entries you accepted on the field for that drive in the Standard CMOS Setup screen. Skipped entries are ignored and are not entered in the screen.

If you are auto-detecting a hard disk that supports the LBA mode, three lines will appear in the parameter box. Choose the line that lists LBA for an LBA drive. Do not select Large or Normal.

The auto-detection feature can only detect one set of parameters for a particular IDE hard drive. Some IDE drives can use more than one set. This is not a problem if the drive is new and empty.

## IV. BIOS SETUP

---

**IMPORTANT:** If your hard disk was already formatted on an older previous system, incorrect parameters may be detected. You will need to enter the correct parameters manually or use low-level format if you do not need the data stored on the hard disk.

If the parameters listed differ from the ones used when the disk was formatted, the disk will not be readable. If the auto-detected parameters do not match the ones that should be used for your disk, do not accept them. Press <N> to reject the presented settings and enter the correct ones manually from the Standard CMOS Setup screen.

# IV. BIOS SETUP

## Save & Exit Setup

Select this option to save into the CMOS memory all modifications you specified during the current session. To save the configuration changes, highlight the “Save & Exit Setup” option on the main screen, type “Y”, and then press <Enter>.

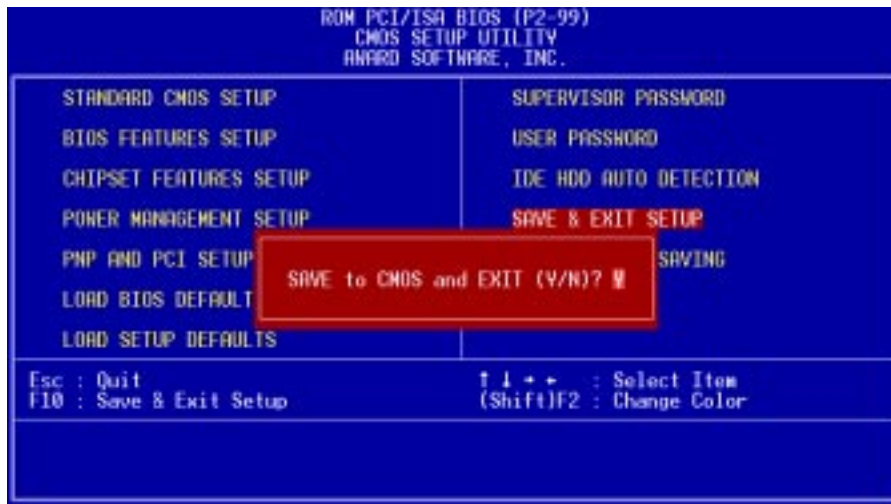

## Exit Without Saving

Select this option to exit the Setup utility without saving the modifications you specify during the current session. To exit without saving, highlight the “Exit Without Saving” option on the main screen and then press <Enter>.





# SOFTWARE CONTENTS

---

<b>V. SOFTWARE SETUP .....</b>	<b>63</b>
Installing ASUS PC Probe (optional) .....	63
LDCM Local Setup (optional) .....	64
LDCM Administrator Setup (optional) .....	66
Uninstalling Programs .....	66
Installing Adobe Acrobat Reader (optional) .....	68
<b>VI. SOFTWARE REFERENCE .....</b>	<b>69</b>
ASUS PC Probe (optional) .....	69
Starting ASUS PC Probe .....	69
Using the ASUS PC Probe .....	70
Intel LANDesk Client Manager (optional) .....	72
Main Client Manager Window .....	72
Using the Taskbar icons .....	73
Using the Select Computer Dialog Box .....	74
To select a computer .....	75
To discover new computers .....	75
To refresh PC health .....	75
To remove a computer from the list .....	75
To wake up a computer .....	75
Displaying the Properties of a Client Computer .....	76
Understanding the Computer Status Icons .....	77
Desktop Management Interface (DMI) .....	78

# V. SOFTWARE SETUP

## Installing ASUS PC Probe (optional)

Insert the Support CD that came with your motherboard into your CD-ROM drive or double-click the CD drive icon in **My Computer** to bring up the setup screen.

**NOTE:** ASUS PC Probe will not run if Intel's LDCM utility is installed. To uninstall Intel's LDCM utility, see section on *Uninstalling Programs*.

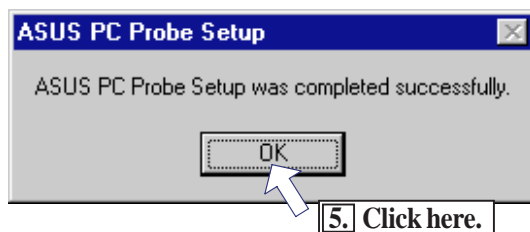
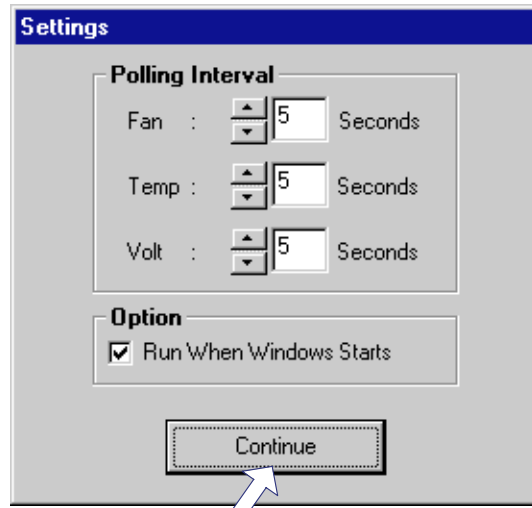
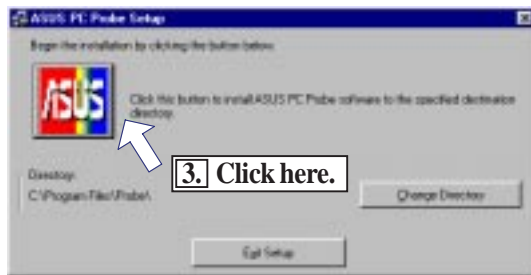
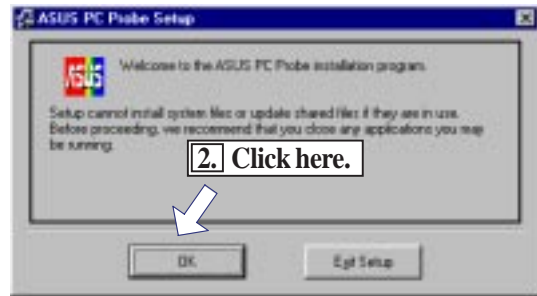

# V. SOFTWARE SETUP

## LDCM Local Setup (optional)

Insert the Support CD that came with your motherboard into your CD-ROM drive or double-click the CD drive icon in **My Computer** to bring up the setup screen.

**NOTE:** LDCM will not run if ASUS' PC Probe utility is installed. To uninstall PC Probe, see section on *Uninstalling Programs*.

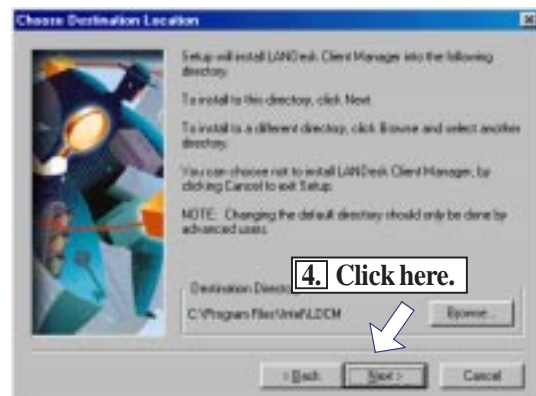

# V. SOFTWARE SETUP

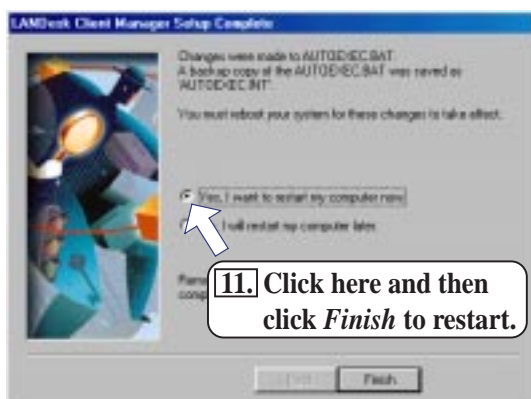
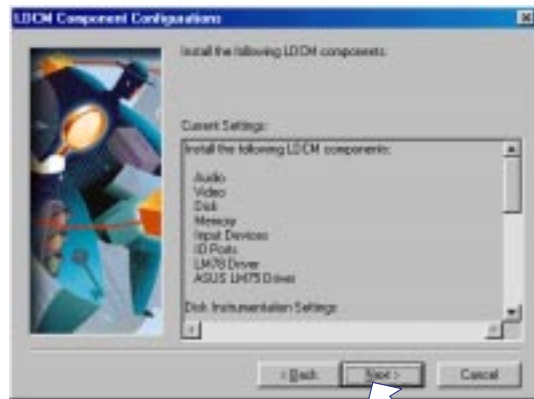

# V. SOFTWARE SETUP

## LDCM Administrator Setup (optional)

Insert the Support CD that came with your motherboard into your CD-ROM drive or double-click the CD drive icon in **My Computer** to bring up the setup screen.

**NOTE:** LDCM will not run if ASUS' PC Probe utility is installed. To uninstall PC Probe, see section on *Uninstalling Programs*.

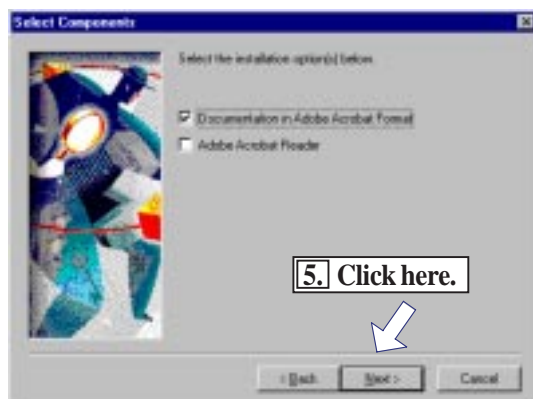
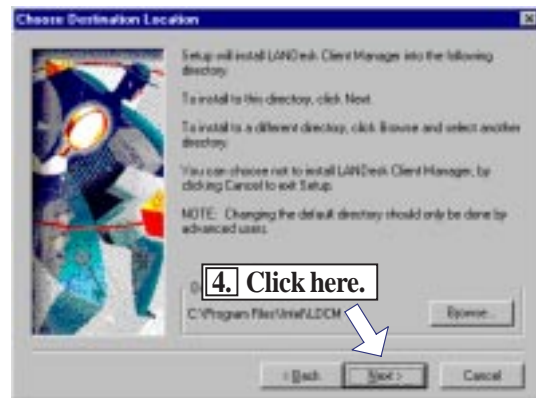
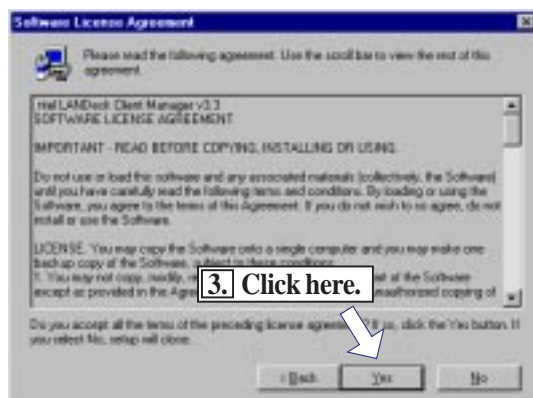



# V. SOFTWARE SETUP

## Uninstalling Programs

Add/Remove Programs is a basic component within Windows. You may use this function if a program does not provide its own uninstallation program.

**1. Double-click here to open the Add/Remove Programs Properties dialog box.**

**2. Select the program you wish to remove and click here.**

**3. Click here.**

# V. SOFTWARE SETUP

## Installing Adobe Acrobat Reader (optional)

Insert the Support CD that came with your motherboard into your CD-ROM drive or double-click the CD drive icon in **My Computer** to bring up the setup screen.

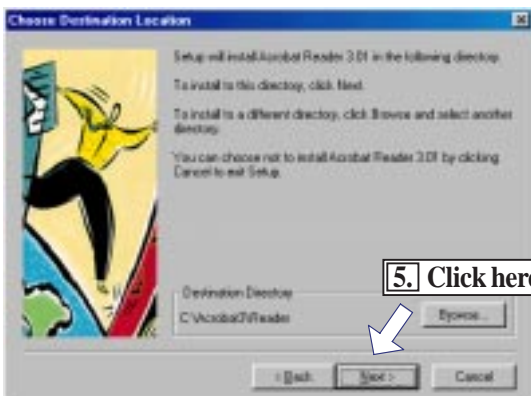
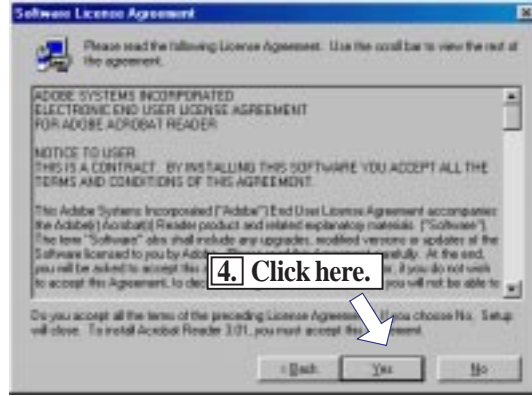
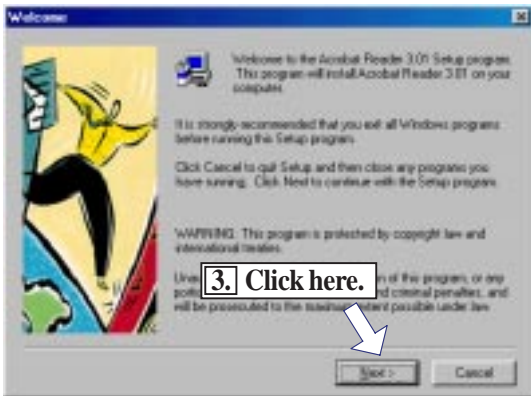
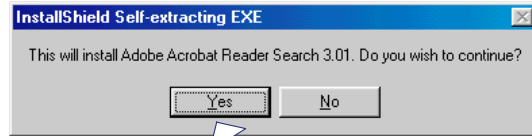

# VI. SOFTWARE REFERENCE

## ASUS PC Probe (optional)

ASUS PC Probe is a convenient utility to monitor the computer system's vital components: fan rotations, voltages, and temperatures.

### Starting ASUS PC Probe

When ASUS PC Probe starts, a splash screen appears allowing you to “Show Monitor” or “Hide”. You can select whether you want the splash screen to show the next time it opens.

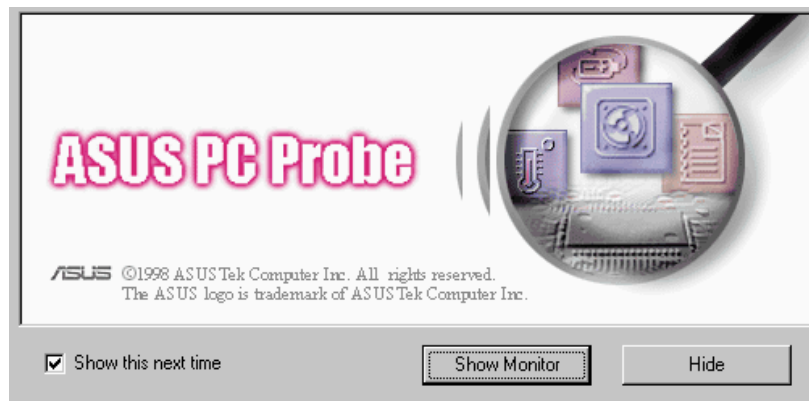

Click **ASUS PC Probe** from the **Start** button to run the utility if you exit the utility or did not set it to “Run when Windows Starts.”

The PC Probe icon  will appear on the taskbar's system tray indicating that ASUS PC Probe is running. Left-clicking the icon will allow you to see your PC status.



# VI. SOFTWARE REFERENCE

## Using the ASUS PC Probe

### Fan Rotation Status

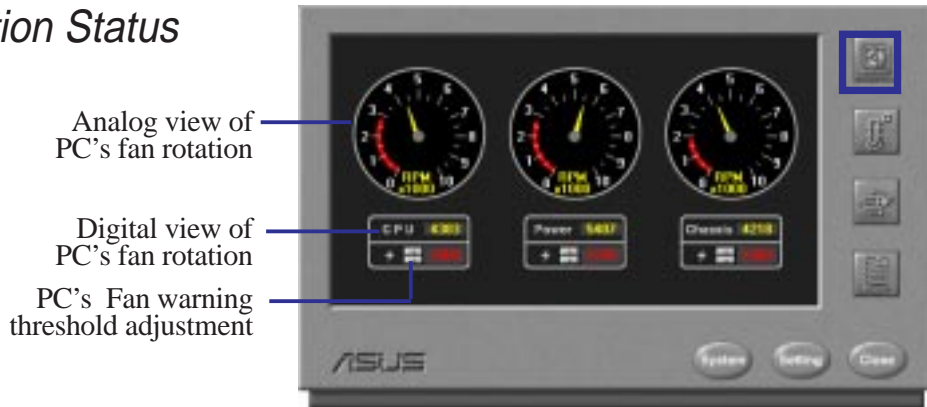

### PC Temperature Status

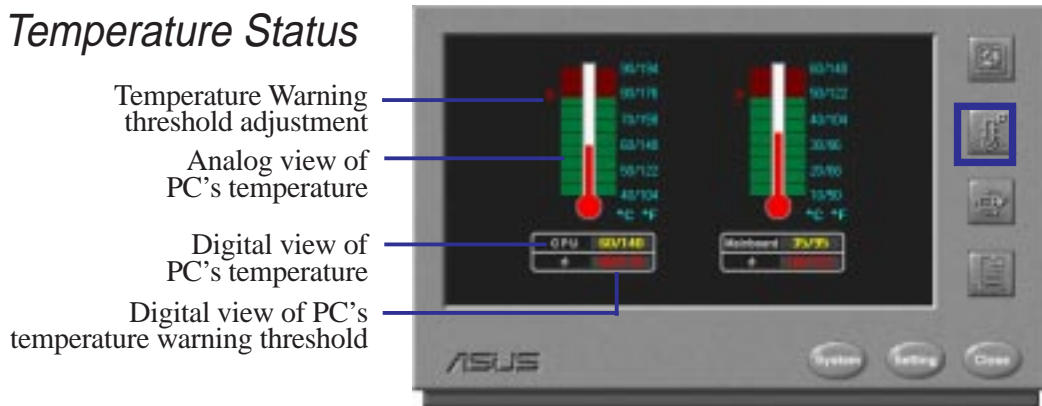

### PC Voltage Status

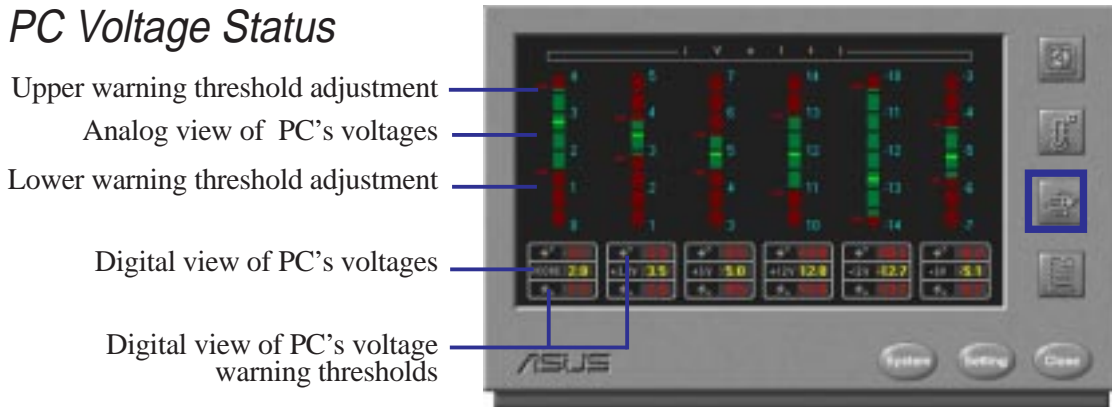

### PC Status Summary

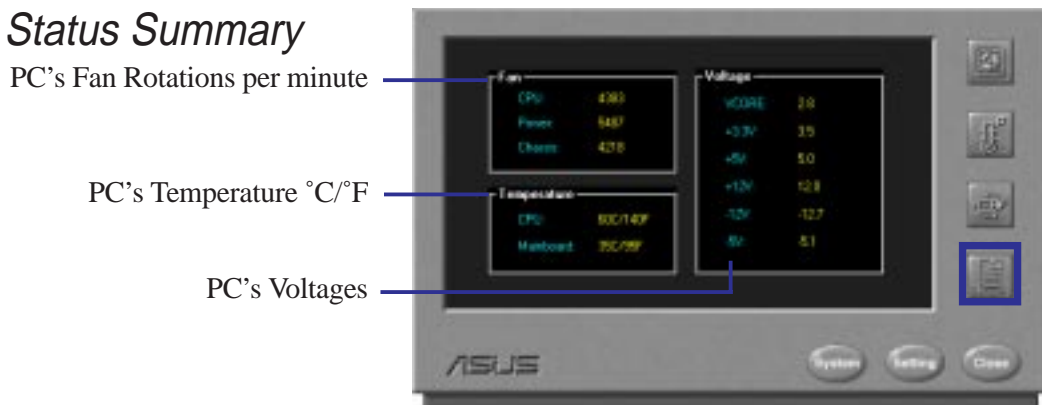

# VI. SOFTWARE REFERENCE

## Using the ASUS PC Probe

### PC Probe System Info.



Get information on your mainboard and BIOS from this screen.



### PC Probe Settings



Change PC Probe refresh times here

Click here to start PC Probe each time you enter Windows.



Click the items you wish to reset to its default values and click this button.

### PC Probe Task Bar Icon

Right clicking the PC Probe icon will bring up a menu to turn on, off, or exit ASUS PC Probe.



The icon appears dimmed when off or unavailable.



When there is a problem, the icon's head mirror flashes red, the PC speaker beeps, and the ASUS PC Probe monitor is displayed.



# VI. SOFTWARE REFERENCE

## Intel LANDesk Client Manager (optional)

With the growth of the computer industry, computer systems have become more complex and difficult to manage. Intel LANDesk Client Manager is a computer management application that simplifies many aspects of managing a computer and assists in troubleshooting common computer problems.

Use Client Manager to:

- Review system inventory
- View DMI-compliant component information
- Backup and restore system files
- Troubleshoot
- Monitor your computer's health
- Receive notifications for system events

Client Manager has been implemented in two different ways:

The client version enables you to view information and manage alerts for a local computer. This version does not permit you to select remote computers, transfer files, or reboot other computers.

The first time you run Client Manager, it searches your network for other computers running Client Manager. Client Manager creates a list of the computers it finds and saves the list to the Windows registry. From this point on, when you run Client Manager or open the Select Computer dialog box, Client Manager checks to see if these computers (listed in the registry) are available and healthy.

## Main Client Manager Window

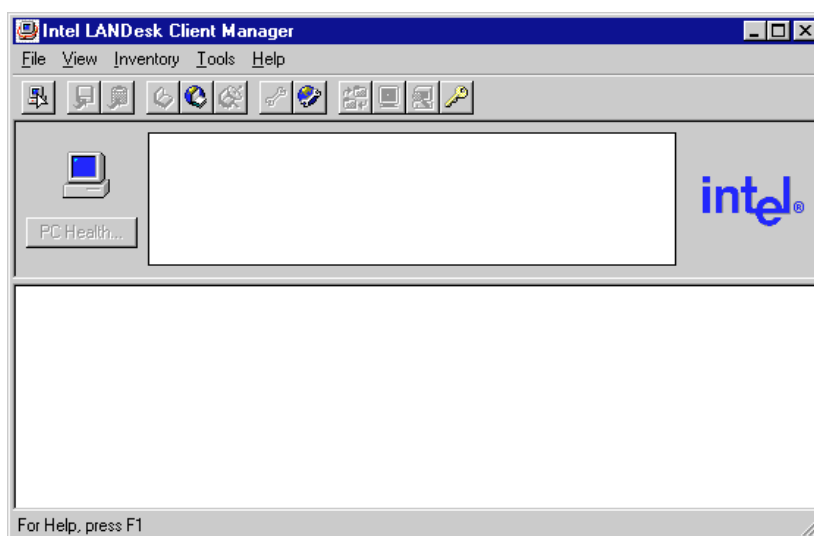







# VI. SOFTWARE REFERENCE

## Using the Taskbar icons

### *Toolbar Descriptions*

	Opens the Select Computer dialog box	File   Select Computer
	Opens the Export dialog box to export the inventory to a file	File   Export
	Exports the inventory to the clipboard	File   Export to clipboard
	Opens the notification log	View   Notification Log
	Opens the global notification log	View   Global Notification Log
	Opens the remote access log	View   Remote Access Log
	Opens the Configure Notifications dialog box	Tools   Configure Notifications
	Opens the Configure Global Notifications dialog box	Tools   Configure Global
	Opens the File Transfer dialog box	Tools   Transfer Files
	Reboots the computer	Tools   Reboot
	Opens the DMI Explorer	Tools   DMI Explorer
	Opens the Set Access Rights dialog box	Tools   Set Access Rights

# VI. SOFTWARE REFERENCE

## Using the Select Computer Dialog Box

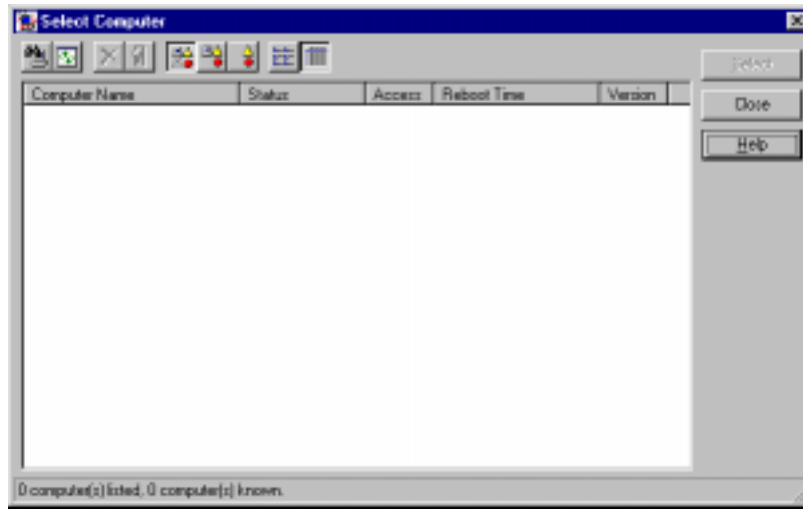

Discovers new computers on the network



Refreshes the health of known computers



Removes a computer from the list of discovered computers



Wakes up a sleeping computer



Shows all discovered computers



Shows only available computers



Shows only unhealthy computers



Shows a simple list view



Shows a detailed list view

# VI. SOFTWARE REFERENCE

---

## To select a computer

1. From the main Client Manager window, click **File | Select Computer**.
2. In the *Select Computer* dialog box, click the computer you want to view.
3. Click the **Select** button.

## To discover new computers

- In the *Select Computer* dialog box, click the **Discover** button on the toolbar or press <Shift>+<F5>.

**TIP:** Use the **Discover** button each time you add a computer to the network, change a computer's network adapter, or upgrade a computer to a newer version Client Manager.

## To refresh PC health

- In the *Select Computer* dialog box, click the **Refresh Known Computers** button on the toolbar or press <F5>.

**TIP:** PC health does not automatically update as changes occur. For example, if a computer's health changes while you are displaying the *Select Computer* dialog box, you need to refresh the list in order to view the correct PC health.

## To remove a computer from the list

1. In the *Select Computer* dialog box, click the computer name you want to remove.
2. Click the **Remove Computer** button on the toolbar or press Delete.
3. At the prompt, click the **Yes** button.

**TIP:** Perform this task each time you remove a computer from the network, since the name of that computer is not automatically removed from this list.

## To wake up a computer

1. In the *Select Computer* dialog box, click the computer name you want to wake up. You can also <Shift>+click to select a continuous group of computers or <Ctrl>+click to select individual computers in the list.

**TIP:** You can only attempt to wake up computers that have a status of Unavailable or Wakeable. If the *Select Computer* dialog box does not display any computers with a status of Unavailable or Wakeable and you suspect it should, the list view may be filtered to display only unhealthy or available computers. You may need to change your list view to display all computers.

2. Click the **Wake Up Computer** button on the toolbar to wake up the selected computer(s) or press <Alt>+<W>.

# VI. SOFTWARE REFERENCE

---

After you attempt to wake up a computer, the status of that computer changes in the list view to a Wake Pending status. If the attempt to wake up a computer is successful, the Wake Pending status changes to a status reflecting the computer's health (such as Normal, Warning, or Critical). If the computer does not wake up after five minutes, a message box appears stating possible reasons why the computer did not respond. (For example, the computer may be disabled or may not support Wake-On-LAN.) After clicking OK, the Wake Pending status reverts to its original status of Unavailable or Wakeable.

**NOTE:** Your computer must have a Wake-On-LAN network adapter to support this feature. Some computers that support the Wake-On-LAN technology may have remote wakeup disabled in the BIOS by default. Before Client Manager can wake up a remote computer, you will need to enable this option in the BIOS configuration of each remote computer.









## Displaying the Properties of a Client Computer

You can display the properties of any discovered client computer even if you cannot otherwise access the computer because of access limitations or Unavailable status. If you display the properties of an unavailable computer, the properties are read from a database in the Windows registry on your computer. Since the Operating System information is not stored in this same database, that information is not available for a computer with a status of Unavailable. Remember that some items may not be current if the properties have changed while the computer was off the network.

# VI. SOFTWARE REFERENCE

## Understanding the Computer Status Icons

When you open the Select Computer dialog box, each computer in the list displays an icon indicating the current status of that computer. The table below describes the seven states a computer may be in.

	<b>Unavailable</b>	The computer is currently in a powered-down state.
	<b>Wakeable</b>	The computer is currently in a powered-down state but supports Remote Wakeup technology.
	<b>Wake Pending</b>	A temporary status (not to exceed five minutes) while Client Manager attempts to wake up a computer. (A computer that is in the process of booting without having received a wakeup instruction is listed as <i>Unavailable</i> , not <i>Wake Pending</i> .)
	<b>Normal</b>	The computer is operating within normal tolerances.
	<b>Warning</b>	A computer that has exceeded a warning tolerance level. For example, the PC Health indicator can be configured to display a warning icon if a hard disk is running low on space.
	<b>Critical</b>	A computer that has exceeded a critical tolerance level. For example, if the hard disk is running critically low on available space, the PC Health indicator displays a critical icon.
	<b>Unknown</b>	A computer that is powered on, but the health status (Normal, Warning, or Critical) is not known.
	<b>Normal (Mobile)</b>	A computer that includes support for mobile PC features, such as mobile battery. Mobile computers display the same array of health icons (above) used for non-mobile computers.

# VI. SOFTWARE REFERENCE

---

## Desktop Management Interface (DMI)

### *Introducing the ASUS DMI Configuration Utility*

This motherboard supports DMI within the BIOS level and provides a DMI Configuration Utility to maintain the Management Information Format Database (MIFD). DMI is able to auto-detect and record information pertinent to a computer's system such as the CPU type, CPU speed, and internal/external frequencies, and memory size. The onboard BIOS will detect as many system information as possible and store those collected information in a 4KB block in the motherboard's Flash EEPROM and allow the DMI to retrieve data from this database. Unlike other BIOS software, the BIOS on this motherboard uses the same technology implemented for Plug and Play to allow dynamic real-time updating of DMI information versus creating a new BIOS image file and requiring the user to update the whole BIOS. This DMI Configuration Utility also allows the system integrator or end user to add additional information into the MIFD such as serial numbers, housing configurations, and vendor information. Those information not detected by the motherboard BIOS and has to be manually entered through the DMI Configuration Utility and updated into the MIFD. This DMI Configuration Utility provides the same reliability as PnP updating and will prevent the refreshing failures associated with updating the entire BIOS.

### *Starting the ASUS DMI Configuration Utility*

The DMI Configuration Utility (DMICFG2.EXE) must be used in real mode in order for the program to run, the base memory must be at least 180K. Memory managers like HIMEM.SYS (required by windows) must not be installed. You can boot up from a system diskette without AUTOEXEC.BAT and CONFIG.SYS files, "REM" HIMEM.SYS in the CONFIG.SYS, or press <Shift>+<F5> during bootup to bypass your AUTOEXEC.BAT and CONFIG.SYS files.

1. In Windows, copy DMICFG2.EXE to your hard disk drive.
2. Restart your computer and press <Shift>+<F5> during bootup to enter safe mode command prompt.
3. Go to the directory containing DMICFG2.EXE.
4. Type DMICFG2 and press <Enter> to run.



# VI. SOFTWARE REFERENCE

## Using the ASUS DMI Configuration Utility

**NOTE:** The following screen displays are provided as examples only and may not reflect the screen contents on your system.

### Edit DMI (or delete)



Use the ←→ (left-right) cursors to move the top menu items and the ↑↓ (up-down) cursor to move between the left hand menu items. The bottom of the screen will show the available keys for each screen. Press enter at the menu item to enter the right hand screen for editing. “Edit component” appears on top. The reversed color field is the current cursor position and the blue text are available for editing. The orange text shows auto-detected information and are not available for editing. The blue text “Press [ENTER] for detail” contains a second pop-up menu is available, use the + - (plus-minus) keys to change the settings. Enter to exit *and save*, ESC to exit *and not save*.

If the user has made changes, ESC will prompt you to answer Y or N. Enter Y to go back to the left-hand screen *and save*, enter N to go back to left-hand screen and *not save*. If editing has not been made, ESC will send you back to the left hand menu without any messages.

### Notes

A heading, \*\*\* BIOS Auto Detect \*\*\*, appears on the right for each menu item on the left side that has been auto detected by the system BIOS.

A heading, \*\*\* User Modified \*\*\*, will appear on the right for menu items that have been modified by the user.



# VI. SOFTWARE REFERENCE

## Save MIFD



You can save the MIFD (normally only saved to flash ROM) to a file by entering the drive and path here. If you want to cancel save, you may press ESC and a message “Bad File Name” appears here to show it was not saved.

## Load MIFD



You can load the disk file to memory by entering a drive and path and file name here.

## Load BIOS Defaults



You can load the BIOS defaults from a MIFD file and can clear all user modified and added data. You must reboot your computer in order for the defaults to be saved back into the Flash BIOS.

# VII. APPENDIX

## ASUS CIDB Chassis Intrusion Sensor Module

The optional ASUS CIDB is a module for providing audio alarm and logging when there is an intrusion into the chassis of a computer system. The module detects a chassis intrusion by either light striking its photo sensor or by contact when its switch connectors are shorted by chassis-mounted momentary toggle switches. An intrusion memory function allows detection by BIOS and LDCM on the next bootup.

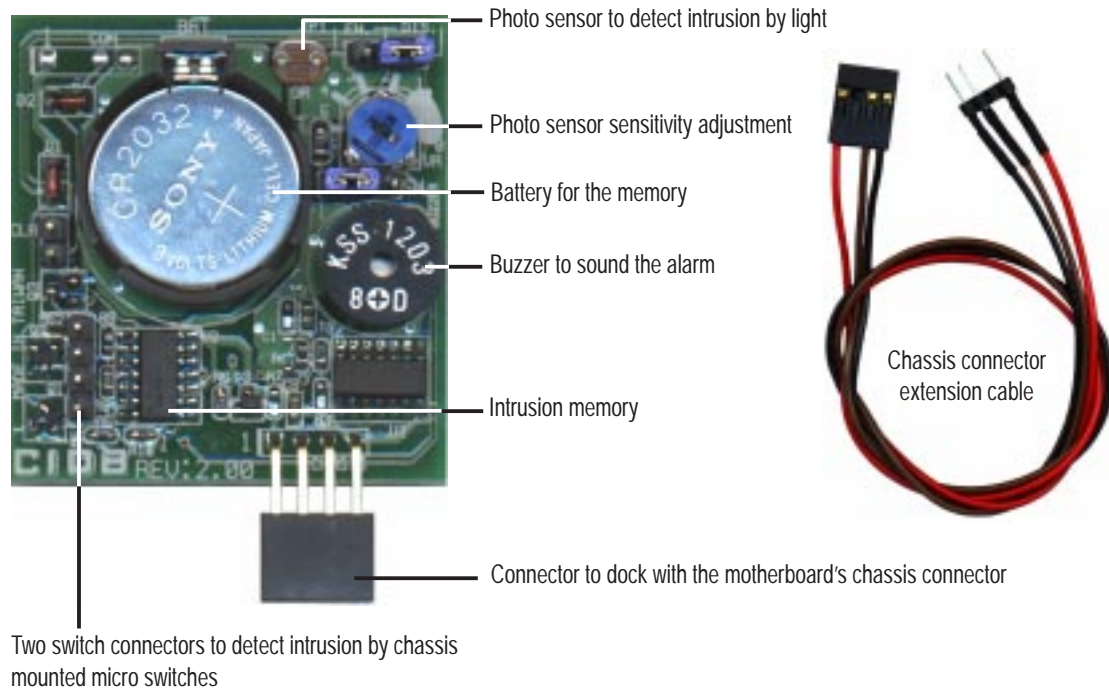

### Using the ASUS CIDB

1. You must have an ASUS motherboard with a chassis connector.
2. Connect the CIDB directly to the chassis connector or use the provided extension cable and mount the CIDB to the chassis using a double-sided foam adhesive tape.

**CAUTION!** The CIDB component pins and metallic points must not come in contact with another metallic surface or else shorting will occur!

3. Check the hardware settings:
  - JP1 jumper should be enabled to use the photo sensor
  - MS1 and MS2 connectors should be connected to momentary toggle switches mounted on the chassis to use the contact method for triggering alarms.
  - SW jumper should be enabled to allow the hardware monitoring components to receive signals from the CIDB.
4. To stop the alarm from sounding, use the LDCM software or place a jumper on (or short manually) the CLR jumper momentarily.
5. If you have an updated BIOS with intrusion support, booting the computer after an intrusion will require a password which is configured through BIOS.

# VII. APPENDIX

## Setting up the ASUS CIDB

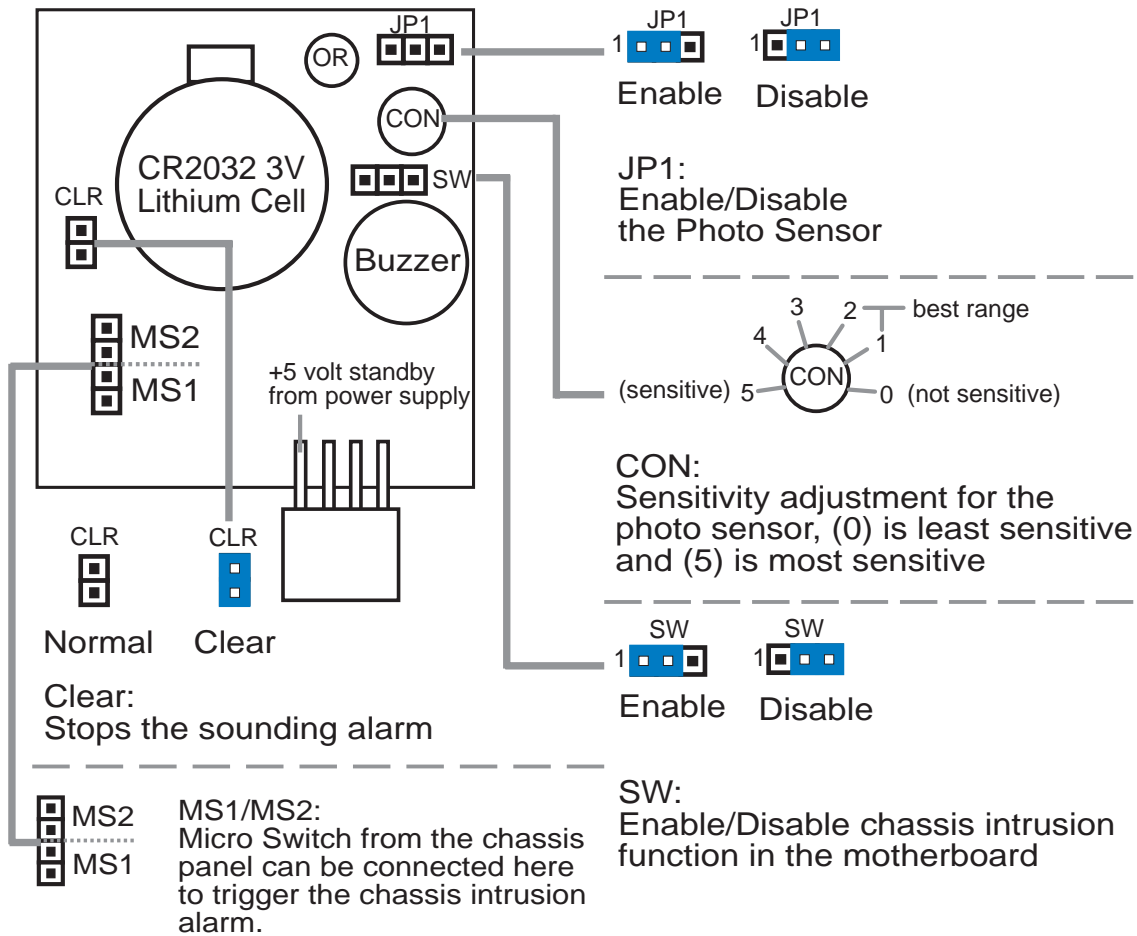

### ASUS CIDB Additional Considerations

1. All motherboards with CIDB: If there is no power to the motherboard (i.e. removing the power cord or turning the power supply's switch off) the alarm will not sound but the CIDB will still remember an intrusion event which BIOS and LDCM will detect on the next bootup.
2. Motherboard with chassis intrusion components: Photo sensor, switch, and memory will not operate with power removed. Power is required to send a signal to the motherboard's intrusion memory and buzzer. When using the CIDB on these motherboards, all the CIDB functions will be disabled, the motherboard's intrusion components must still be used. The CIDB can benefit these motherboards by providing a chassis switch which will operate even when the power is removed. Pins [2-3] of the SW jumper can be used for a momentary toggle switch and the CIDB's battery will be used to send an intrusion signal to the motherboard's intrusion memory.

# VII. APPENDIX

## The ASUS S370 CPU Card

The optional ASUS S370 CPU card allows Slot 1 motherboards to accept socket 370 processors. The ASUS S370 CPU card gives Slot 1 motherboard owners an inexpensive way to upgrade their Pentium II computers using lower costing socket 370 processors. Since socket 370 processors are based on the Pentium II design, the only difference is the connector and the amount of internal cache within the processor.

The following picture shows the ASUS S370 CPU card with a plastic retainer attached to the edge. The retainer is used to hold the ASUS S370 CPU card in place using the motherboard's Slot 1 retention mechanism.

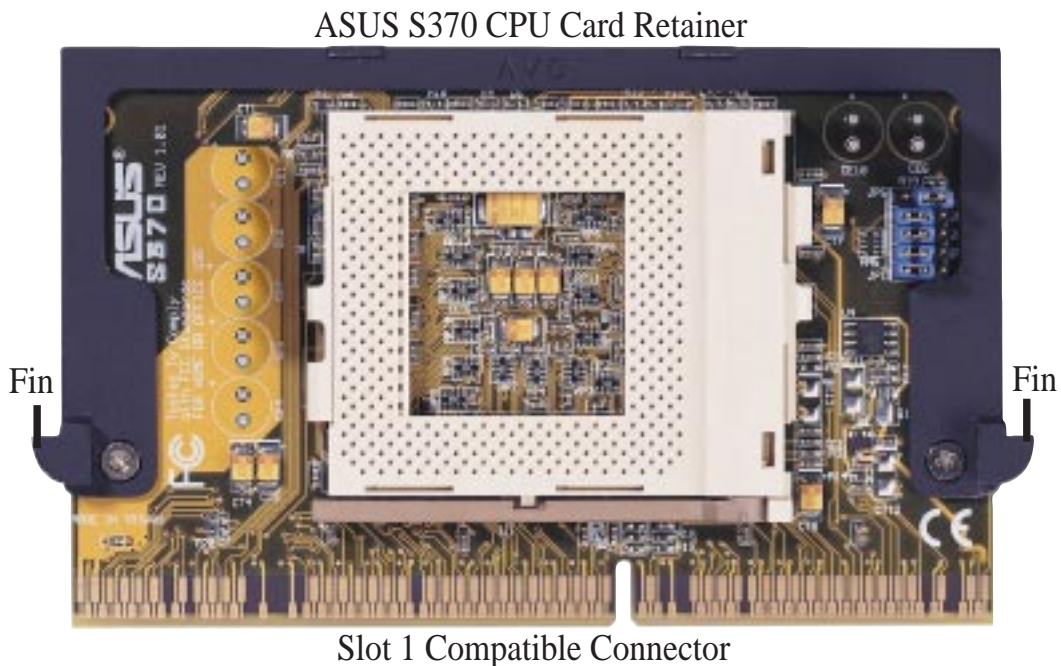

## Using the ASUS S370

The general procedure for using the ASUS S370 CPU card:

1. Check the voltage setting for your socket 370 processor using the jumpers on the card if necessary. For current socket 370 processors, the default setting should be used. See the reverse side of the ASUS S370 CPU card or the next page for voltage settings.
2. Install the socket 370 processor. Installation of socket 370 processors is exactly like socket 7 processors. Lift the brown lever to 90° to install the processor and lower the brown lever to lock the processor.
3. Insert the ASUS S370 CPU card into Slot 1 on the motherboard. The two fins on the sides of the ASUS S370 CPU card must catch on the retention mechanism so that it locks in place.
4. Connect the socket 370 processor's fan connector to the motherboard.
5. Make sure that no wires or objects come in contact with the fan.



# VII. APPENDIX

## Setting up the ASUS S370

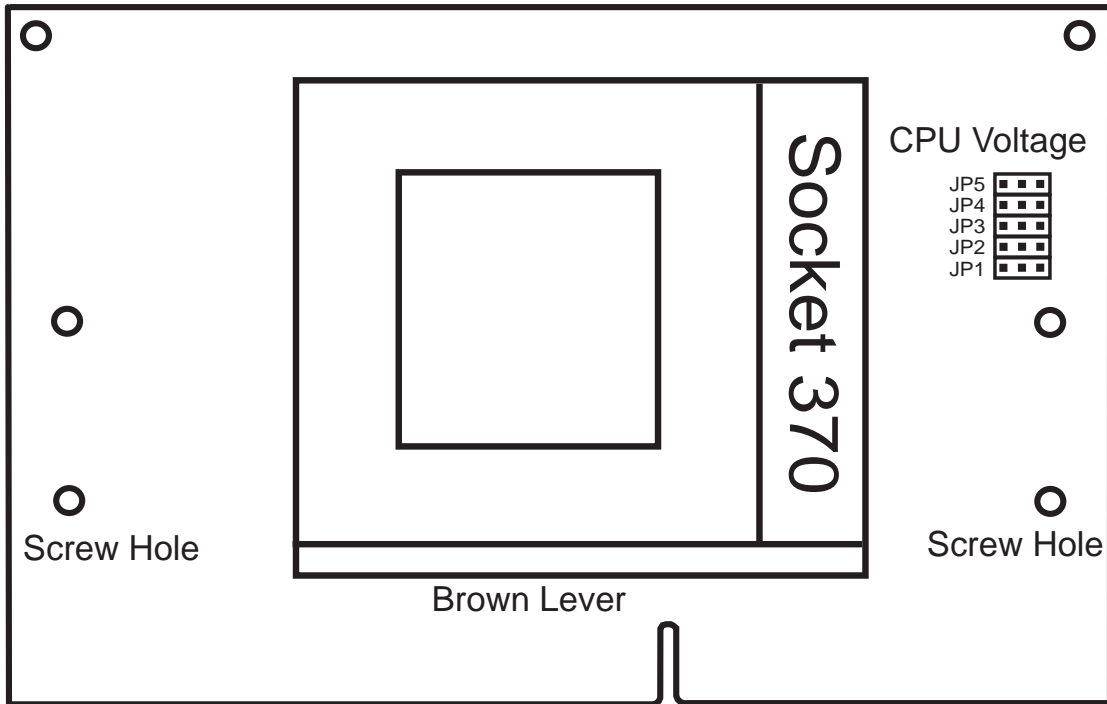

### ASUS S370 Jumper Settings

Setting the CPU voltage is *not* necessary for current socket 370 processors. If required, your socket 370 processor should have its voltage requirement printed on its surface or documentation. If no voltage is indicated or you are not sure, use the “CPU Def.” setting as shown below.

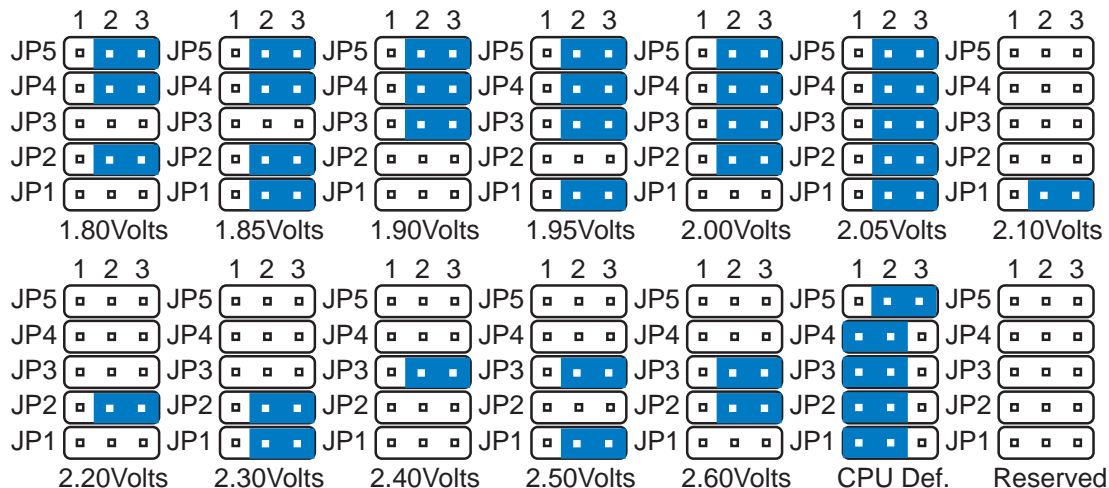

#### Socket 370 CPU Voltage

**WARNING!** Exceeding your socket 370 processor’s required voltage can damage your processor permanently! Make sure that the jumpers are as shown for “CPU Def.” unless otherwise specified before powering on your motherboard.



# VII. APPENDIX

## ASUS PCI-L101 Fast Ethernet Card

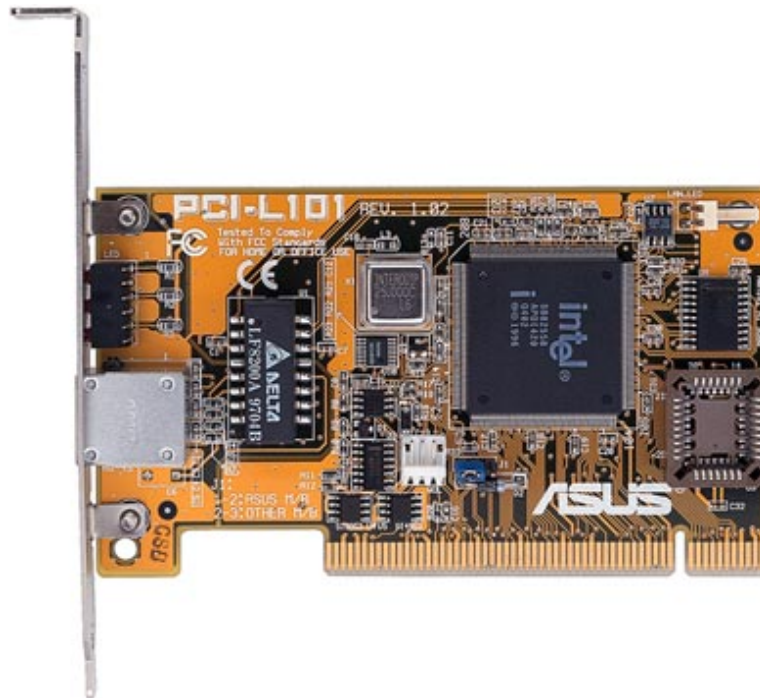

VII. APPENDIX  
ASUS LAN Card

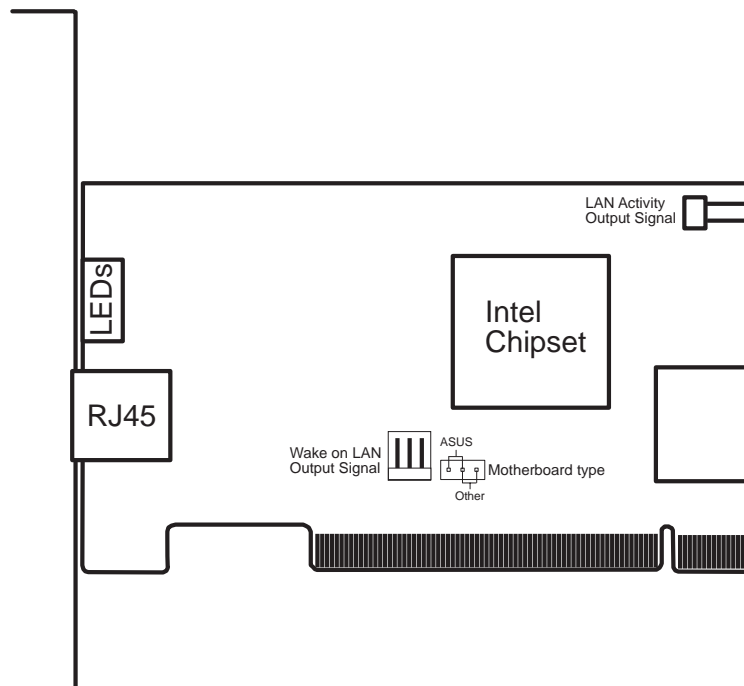

If you are using the ASUS PCI-L101 on an ASUS motherboard, leave the jumper on its default setting of “ASUS.” If you are using another brand of motherboard, set the jumper to “Other.” Connect the Wake on LAN (WOL) output signal to the motherboard’s WOL\_CON in order to utilize the wake on LAN feature of the motherboard. Connect the LAN activity output signal (LAN\_LED) to the system cabinet’s front panel LAN\_LED in order to display the LAN data activity.

# VII. APPENDIX

---

## Features

- Intel 82558 Ethernet LAN Controller (Fully integrated 10BASE-T/100BASE-TX)
- Wake-On-LAN Remote Control Function Supported
- PCI Bus Master Complies to PCI Local Bus Rev. 2.1 specifications
- Consists of MAC & PHY (10/100Mbps) interfaces
- Complies to IEEE 802.3 10BASE-T and IEEE 802.3u 100BASE-TX interfaces
- Fully supports 10BASE-T & 100BASE-TX operations through a single RJ45 port
- Supports 32-bit Bus Master Technology / PCI Rev. 2.1
- Enhancements on ACPI & APM
- Adheres to PCI Bus Power Management Interface Rev. 1.0, ACPI Rev. 1.0, and Device Class Power Management Rev. 1.0
- IEEE 802.3u auto-negotiation for 10Mbps/100Mbps Network Data Transfer Rates.
- Provides LED indicators for monitoring network conditions
- Plug and Play

## Software Driver Support

- **NetWare ODI Drivers** - Novell Netware 3.x, 4.x, DOS, OS/2 Client
- **NDIS 2.01 Drivers** - Microsoft LAN Manager, Microsoft Windows 3.11, IBM LAN Server
- **NDIS 3.0 Drivers** - Microsoft Windows NT, Microsoft Windows 95, Microsoft Windows 3.11

## Question and Answer

Q: What is Wake-On-LAN ?

A: The Wake-On-LAN feature provides the capability to remotely power on systems supporting Wake-On-LAN by simply sending a wake-up frame. With this feature, remotely uploading/downloading data to/from systems during off-peak hours will be feasible.

Q: What can Wake-On-LAN do for you ?

A: Wake-On-LAN is a remote management tool with advantages that can reduce system management workload, provide flexibility to the system administrator's job, and then of course save you time-consuming efforts and costs.

Q: What components does Wake-On-LAN require to be enable?

A: To enable Wake-On-LAN function, your system requires Ethernet LAN adapter card that can activate Wake-On-LAN function, a client with Wake-On-LAN capability, and software such as LDCM Rev. 3.10 or up that can trigger wake-up frame.

# VII. APPENDIX

## Glossary

### **AGP (Accelerated Graphics Port)**

An interface specification that enables high-performance 3D graphics on mainstream PCs. AGP offers a higher throughput than PCI by providing the graphics controller with direct access to system memory.

Bus	Bus Frequency	Bus Speed
PCI	33MHz	133MB/s
AGP 1X	66MHz	200-300MB/s
AGP 2X	133MHz	528MB/s
AGP 4X	266MHz	1 GB/s

### **AUTOEXEC.BAT**

AUTOEXEC.BAT is a special-purpose file that is automatically executed by DOS whenever the computer is turned ON or restarted. This file contains important commands that help configure the system to work with certain software and devices. Windows 95 and later has its own startup files and may not use or may ignore parts of the AUTOEXEC.BAT file.

### **BIOS (Basic Input/Output System)**

BIOS is a set of routines that affect how the computer transfers data between computer components, such as memory, disks, and the display adapter. The BIOS instructions are built into the computer's read-only memory. BIOS parameters can be configured by the user through the BIOS Setup program. The BIOS can be updated using the provided utility to copy a new BIOS file into the EEPROM.

### **Bit (Binary Digit)**

Represents the smallest unit of data used by the computer. A bit can have one of two values: 0 or 1.

### **Boot**

Boot means to start the computer operating system by loading it into system memory. When the manual instructs you to "boot" your system (or computer), it means to turn ON your computer. "Reboot" means to restart your computer. When using Windows 95 or later, selecting "Restart" from "Start | Shut Down..." will reboot your computer.

### **Bus Master IDE**

PIO (Programmable I/O) IDE requires that the CPU be involved in IDE access and waiting for mechanical events. Bus master IDE transfers data to/from the memory without interrupting the CPU. Bus master IDE driver and bus master IDE hard disk drives are required to support bus master IDE mode.

# VII. APPENDIX

---

## **Byte (Binary Term)**

One byte is a group of eight contiguous bits. A byte is used to represent a single alphanumeric character, punctuation mark, or other symbol.

## **COM Port**

COM is a logical device name used by to designate the computer serial ports. Pointing devices, modems, and infrared modules can be connected to COM ports. Each COM port is configured to use a different IRQ and address assignment.

## **CPU (Central Processing Unit)**

The CPU, sometimes called “Processor,” actually functions as the “brain” of the computer. It interprets and executes program commands and processes data stored in memory. Currently, there are socket 370 (for Pentium Celeron-PPGA), socket 7 (for Pentium, AMD, Cyrix, IBM), slot 1 (for Pentium II and III), and slot 2 (for Xeon) processors.

## **Device Driver**

A device driver is a special set of instructions that allows the computer’s operating system to communicate with devices such as VGA, audio, ethernet, printer, or modem.

## **DOS (Disk Operating System)**

DOS is the foundation on which all other programs and software applications operate, including Windows. DOS is responsible for allocating system resources such as memory, CPU time, disk space, and access to peripheral devices. For this reason, DOS constitutes the basic interface between you and your computer.

## **Hardware**

Hardware is a general term referring to the physical components of a computer system, including peripherals such as printers, modems, and pointing devices.

## **IDE (Integrated Drive Electronics)**

IDE devices integrate the drive control circuitry directly on the drive itself, eliminating the need for a separate adapter card (in the case for SCSI devices). UltraDMA/33 IDE devices can achieve up to 33MB/Sec transfer.

## **LPT Port (Line Printer Port)**

Logical device name reserved by DOS for the computer parallel ports. Each LPT port is configured to use a different IRQ and address assignment.

## **MMX**

A set of 57 new instructions based on a technique called Single Instruction, Multiple Data (SIMD), which is built into the new Intel Pentium PP/MT (P55C) and Pentium II (Klamath) CPU as well as other x86-compatible microprocessors. The MMX instructions are designed to accelerate multimedia and communications applications, such as 3D video, 3D sound, video conference.

# VII. APPENDIX

---

## **PCI Bus (Peripheral Component Interconnect Local Bus)**

PCI bus is a specification that defines a 32-bit data bus interface. PCI is a standard widely used by expansion card manufacturers.

## **Peripherals**

Peripherals are devices attached to the computer via I/O ports. Peripheral devices allow your computer to perform an almost limitless variety of specialized tasks.

## **POST (Power On Self Test)**

When you turn on the computer, it will first run through the POST, a series of software-controlled diagnostic tests. The POST checks system memory, the motherboard circuitry, the display, the keyboard, the diskette drive, and other I/O devices.

## **PS/2 Port**

PS/2 ports are based on IBM Micro Channel Architecture. This type of architecture transfers data through a 16-bit or 32-bit bus. A PS/2 mouse and/or keyboard may be used on ATX motherboards.

## **RAID (Redundant Array of Independent Disks)**

RAID can be set up to provide mirroring (for fault tolerance), parity (for data guarding), or striping (for data distribution over several drives for increased performance). A RAID card is required to setup a RAID system.

## **RAM (Random Access Memory)**

There are several different types of RAM such as DRAM (Dynamic RAM), EDO DRAM (Extended Data Output DRAM), SDRAM (Synchronous DRAM).

## **ROM (Read Only Memory)**

ROM is nonvolatile memory used to store permanent programs (called firmware) used in certain computer components. Flash ROM (or EEPROM) can be reprogrammed with new programs (or BIOS).

## **SCSI (Small Computer System Interface)**

High speed parallel interface defined by the X3T9.2 committee of the American National Standards Institute (ANSI) for connecting many peripheral devices.

## **System Disk**

A system disk contains the core file of an operating system and is used to boot up the operating system.

## **UltraDMA/33**

UltraDMA/33 is a new specification to improve IDE transfer rates. Unlike traditional PIO mode, which only uses the rising edge of IDE command signal to transfer data, the DMA/33 uses both rising edge and falling edge. Hence, the data transfer rate is double of the PIO mode 4 or DMA mode 2. (16.6MB/s x2 = 33MB/s).

# VII. APPENDIX

---

## **USB (Universal Serial Bus)**

A new 4-pin serial peripheral bus that allows plug and play computer peripherals such as keyboard, mouse, joystick, scanner, printer and modem/ISDN to be automatically configured when they are attached physically without having to install drivers or reboot. With USB, the traditional complex cables from back panel of your PC can be eliminated.



---

(This page was intentionally left blank.)

---

(This page was intentionally left blank.)

---

(This page was intentionally left blank.)

---

(This page was intentionally left blank.)

---

(This page was intentionally left blank.)

---

(This page was intentionally left blank.)



## Free Manuals Download Website

<http://myh66.com>

<http://usermanuals.us>

<http://www.somanuals.com>

<http://www.4manuals.cc>

<http://www.manual-lib.com>

<http://www.404manual.com>

<http://www.luxmanual.com>

<http://aubethermostatmanual.com>

Golf course search by state

<http://golfingnear.com>

Email search by domain

<http://emailbydomain.com>

Auto manuals search

<http://auto.somanuals.com>

TV manuals search

<http://tv.somanuals.com>