

A7V400-MX SE

ASUS[®]

Motherboard

E1942

First edition V1

February 2005

Copyright © 2005 ASUSTeK COMPUTER INC. All Rights Reserved.

No part of this manual, including the products and software described in it, may be reproduced, transmitted, transcribed, stored in a retrieval system, or translated into any language in any form or by any means, except documentation kept by the purchaser for backup purposes, without the express written permission of ASUSTeK COMPUTER INC. ("ASUS").

Product warranty or service will not be extended if: (1) the product is repaired, modified or altered, unless such repair, modification or alteration is authorized in writing by ASUS; or (2) the serial number of the product is defaced or missing.

ASUS PROVIDES THIS MANUAL "AS IS" WITHOUT WARRANTY OF ANY KIND, EITHER EXPRESS OR IMPLIED, INCLUDING BUT NOT LIMITED TO THE IMPLIED WARRANTIES OR CONDITIONS OF MERCHANTABILITY OR FITNESS FOR A PARTICULAR PURPOSE. IN NO EVENT SHALL ASUS, ITS DIRECTORS, OFFICERS, EMPLOYEES OR AGENTS BE LIABLE FOR ANY INDIRECT, SPECIAL, INCIDENTAL, OR CONSEQUENTIAL DAMAGES (INCLUDING DAMAGES FOR LOSS OF PROFITS, LOSS OF BUSINESS, LOSS OF USE OR DATA, INTERRUPTION OF BUSINESS AND THE LIKE), EVEN IF ASUS HAS BEEN ADVISED OF THE POSSIBILITY OF SUCH DAMAGES ARISING FROM ANY DEFECT OR ERROR IN THIS MANUAL OR PRODUCT.

SPECIFICATIONS AND INFORMATION CONTAINED IN THIS MANUAL ARE FURNISHED FOR INFORMATIONAL USE ONLY, AND ARE SUBJECT TO CHANGE AT ANY TIME WITHOUT NOTICE, AND SHOULD NOT BE CONSTRUED AS A COMMITMENT BY ASUS. ASUS ASSUMES NO RESPONSIBILITY OR LIABILITY FOR ANY ERRORS OR INACCURACIES THAT MAY APPEAR IN THIS MANUAL, INCLUDING THE PRODUCTS AND SOFTWARE DESCRIBED IN IT.

Products and corporate names appearing in this manual may or may not be registered trademarks or copyrights of their respective companies, and are used only for identification or explanation and to the owners' benefit, without intent to infringe.

Contents

Notices	v
Safety information	vi
About this guide	vii
A7V400-MX SE specifications summary	viii

Chapter 1: Product introduction

1.1	Welcome!	1-2
1.2	Package contents	1-2
1.3	Special features	1-2
	1.3.1 Product highlights	1-2
	1.3.2 Innovative ASUS features	1-4
1.4	Before you proceed	1-5
1.5	Motherboard overview	1-6
	1.5.1 Motherboard layout	1-6
	1.5.2 Placement direction	1-7
	1.5.3 Screw holes	1-7
1.6	Central Processing Unit (CPU)	1-8
	1.6.1 Overview	1-8
	1.6.2 Installing the CPU	1-8
1.7	System memory	1-9
	1.7.1 Overview	1-9
	1.7.2 Memory configurations	1-9
	1.7.3 Installing a DIMM	1-13
	1.7.4 Removing a DIMM	1-13
1.8	Expansion slots	1-14
	1.8.1 Installing an expansion card	1-14
	1.8.2 Configuring an expansion card	1-14
	1.8.3 AGP slot	1-16
	1.8.4 PCI slots	1-16
1.9	Switch and jumpers	1-17
1.10	Connectors	1-20
	1.10.1 Rear panel connectors	1-20
	1.10.2 Internal connectors	1-21

Contents

Chapter 2: BIOS setup

2.1	Managing and updating your BIOS	2-2
2.1.1	Creating a bootable floppy disk	2-2
2.1.2	AwardBIOS Flash Utility	2-3
2.1.3	ASUS CrashFree BIOS utility	2-4
2.1.4	ASUS EZ Flash utility	2-4
2.1.5	ASUS Update utility	2-5
2.2	BIOS beep codes	2-7
2.3	BIOS setup program	2-7
2.3.1	BIOS menu bar	2-8
2.3.2	Legend bar	2-8
2.4	Main menu	2-10
2.5	Advanced menu	2-15
2.5.1	CPU Configuration	2-15
2.5.2	Memory Configuration	2-16
2.5.3	Chipset	2-17
2.5.4	PCI/PnP	2-19
2.5.5	Onboard Devices Configuration	2-20
2.5.6	USB Configuration	2-22
2.6	Power menu	2-23
2.6.1	APM Configuration	2-24
2.6.2	Hardware Monitor	2-26
2.7	Boot menu	2-27
2.7.1	Boot Device Priority	2-27
2.7.2	Removable Drives	2-28
2.7.3	Hard Disk Drives	2-28
2.7.4	CDROM Drives	2-29
2.7.5	Boot Settings Configuration	2-29
2.7.6	Security	2-30
2.8	Exit menu	2-32

Chapter 3: Software support

3.1	Installing an operating system	3-2
3.2	Support CD information	3-2
3.2.1	Running the support CD	3-2
3.2.2	Drivers menu	3-3
3.2.3	Utilities menu	3-3
3.2.4	Contacts menu	3-4

Notices

Federal Communications Commission Statement

This device complies with FCC Rules Part 15. Operation is subject to the following two conditions:

- This device may not cause harmful interference, and
- This device must accept any interference received including interference that may cause undesired operation.

This equipment has been tested and found to comply with the limits for a Class B digital device, pursuant to Part 15 of the FCC Rules. These limits are designed to provide reasonable protection against harmful interference in a residential installation. This equipment generates, uses and can radiate radio frequency energy and, if not installed and used in accordance with manufacturer's instructions, may cause harmful interference to radio communications. However, there is no guarantee that interference will not occur in a particular installation. If this equipment does cause harmful interference to radio or television reception, which can be determined by turning the equipment off and on, the user is encouraged to try to correct the interference by one or more of the following measures:

- Reorient or relocate the receiving antenna.
- Increase the separation between the equipment and receiver.
- Connect the equipment to an outlet on a circuit different from that to which the receiver is connected.
- Consult the dealer or an experienced radio/TV technician for help.



The use of shielded cables for connection of the monitor to the graphics card is required to assure compliance with FCC regulations. Changes or modifications to this unit not expressly approved by the party responsible for compliance could void the user's authority to operate this equipment.

Canadian Department of Communications Statement

This digital apparatus does not exceed the Class B limits for radio noise emissions from digital apparatus set out in the Radio Interference Regulations of the Canadian Department of Communications.

This class B digital apparatus complies with Canadian ICES-003.

Safety information

Electrical safety

- To prevent electrical shock hazard, disconnect the power cable from the electrical outlet before relocating the system.
- When adding or removing devices to or from the system, ensure that the power cables for the devices are unplugged before the signal cables are connected. If possible, disconnect all power cables from the existing system before you add a device.
- Before connecting or removing signal cables from the motherboard, ensure that all power cables are unplugged.
- Seek professional assistance before using an adapter or extension cord. These devices could interrupt the grounding circuit.
- Make sure that your power supply is set to the correct voltage in your area. If you are not sure about the voltage of the electrical outlet you are using, contact your local power company.
- If the power supply is broken, do not try to fix it by yourself. Contact a qualified service technician or your retailer.

Operation safety

- Before installing the motherboard and adding devices on it, carefully read all the manuals that came with the package.
- Before using the product, make sure all cables are correctly connected and the power cables are not damaged. If you detect any damage, contact your dealer immediately.
- To avoid short circuits, keep paper clips, screws, and staples away from connectors, slots, sockets and circuitry.
- Avoid dust, humidity, and temperature extremes. Do not place the product in any area where it may become wet.
- Place the product on a stable surface.
- If you encounter technical problems with the product, contact a qualified service technician or your retailer.

About this guide

Conventions used in this guide

To make sure that you perform certain tasks properly, take note of the following symbols used throughout this guide.



WARNING. Information to prevent injury to yourself when trying to complete a task.



CAUTION. Information to prevent damage to the components when trying to complete a task.



IMPORTANT. Information that you **MUST** follow to complete a task.



NOTE. Tips and additional information to aid in completing a task.

Where to find more information

Refer to the following sources for additional information and for product and software updates.

1. **ASUS websites**

The ASUS websites worldwide provide updated information on ASUS hardware and software products. Refer to the ASUS contact information.

2. **Optional documentation**

Your product package may include optional documentation, such as warranty flyers, that may have been added by your dealer. These documents are not part of the standard package.

A7V400-MX SE specifications summary

CPU	Socket A for AMD Athlon™ XP/Sempron™ processors Thoroughbred/Barton core support
Chipset	VIA KM400A VIA VT8237 (no RAID support)
Front Side Bus (FSB)	400/333/266/200 MHz
Memory	2 x 184-pin DDR DIMM sockets support up to maximum 2 GB unbuffered DDR400*/333/266/200 non-ECC DDR SDRAM memory <i>*may run only at 333 MHz (DDR333)</i>
Expansion slots	3 x PCI 1 x AGP 8X/4X (1.5V only)
Storage	<ul style="list-style-type: none"> • 2 x IDE connectors support up to four UltraATA133/100/66 hard disk drives • 2 x Serial ATA connectors support up to two Serial ATA hard disk drives
Graphics	Integrated VIA UniChrome™ 3D/2D graphics and video controller
Audio	AD1888 SoundMAX 6-channel audio CODEC S/PDIF out interface
LAN	VIA VT6103 10/100 Mbps Ethernet LAN PHY
USB	Supports up to eight USB 2.0 ports
Hardware monitoring	Super I/O integrated monitoring of CPU/chassis fan and MB/CPU temperature
Rear panel I/O ports	1 x Parallel port 1 x Serial (COM1) port 1 x VGA port 1 x PS/2 keyboard port (purple) 1 x PS/2 mouse port (green) 1 x LAN (RJ-45) port 4 x USB 2.0/1.1 ports 6-channel audio ports
Internal connectors	1 x Floppy disk drive connectors 2 x IDE connectors 2 x Serial ATA connectors 2 x USB connectors 1 x S/PDIF out connector 1 x GAME connector 1 x CD connector

(continued next page)

A7V400-MX SE specifications summary

Internal connectors (continuation)	1 x AUX connector 1 x Front panel audio connector CPU/chassis fan connectors ATX power connector Panel connector
BIOS features	2 Mb Flash ROM, Phoenix Award BIOS, PnP, DMI2.0, WfM2.0, SM BIOS 2.3, ASUS EZ Flash, ASUS CrashFree BIOS, ASUS C.O.P. (CPU Overheating Protection)
Industry standard	PCI 2.2, USB 2.0/1.1
Manageability	Wake on Ring (WOR), Wake on LAN (WOL)
Support CD contents	Drivers ASUS PC Probe ASUS Live Update Utility Award BIOS Flash Utility Adobe Acrobat Reader Anti-virus Utility (OEM version) Microsoft® DirectX 9.0c
Form factor	Micro-ATX form factor: 9.6 in x 9.6 in

* Specifications are subject to change without notice.

This chapter describes the motherboard features and the new technologies it supports.

Product introduction



1.1 Welcome!

Thank you for buying an ASUS® A7V400-MX SE motherboard!

The motherboard delivers a host of new features and latest technologies, making it another standout in the long line of ASUS quality motherboards!

Before you start installing the motherboard, and hardware devices on it, check the items in your package with the list below.

1.2 Package contents

Check your motherboard package for the following items.

Motherboard	ASUS A7V400-MX SE motherboard
Cables	Serial ATA signal cable and Serial ATA power cable Ultra DMA 133/100/66 cable Floppy disk drive cable
Accessories	I/O shield
Application CDs	ASUS motherboard support CD
Documentation	User guide



If any of the above items is damaged or missing, contact your retailer.

1.3 Special features

1.3.1 Product highlights

400 MHz FSB support



The motherboard comes with a Socket A that supports Athlon™ XP/Sempron™ processor with up to 400 MHz front side bus frequency for increased application productivity and enhanced digital multimedia experience. See page 1-8.

VIA KM400A and VT8237



The VIA KM400A Northbridge and the VIA VT8237 Southbridge chipset provides support for vital motherboard interfaces. The Northridge chip features an integrated VIA Unichrome™ 2D/3D graphics core allowing efficient execution of multimedia applications and playback support for DVD video. The chipsets communicate at speeds of up to 533 MB/s using the fast 8X V-Link connection.

The VT8237 chip provides native support for Serial ATA, USB, Parallel ATA, LAN, and audio interfaces.

DDR memory support

Employing the Double Data Rate (DDR) memory technology, the motherboard supports up to 2 GB of system memory using DDR 333/266/200 DIMMs. The fast 333 MHz memory bus delivers the required bandwidth for the latest 3D graphics, multimedia, and Internet applications. See page 1-9 for details.

Serial ATA technology



The motherboard supports the Serial ATA technology through the Serial ATA connectors and the VIA VT8237R. The SATA specification allows for thinner, more flexible cables with lower pin count, reduced voltage requirement, and up to 150 MB/s data transfer rate. See page 1-22 for details.

Integrated Ethernet LAN controller



A 10/100Mbps Fast Ethernet controller is embedded in this motherboard to give you a fast and reliable connection to a local area network (LAN) and the Internet. See page 1-20.

SoundMax 6-channel audio **SOUNDMAX**

Onboard is the ADI SoundMax 5.1-channel audio CODEC. The SoundMAX Digital Audio System is the industry's highest performance and most reliable audio solution for business professionals, audiophiles, musicians, and gamers. SoundMAX Digital Audio System can output 5.1 channel surround sound and features state-of-the-art DLS2 MIDI synthesizer and supports all major game audio technologies. See page 1-20.

S/PDIF digital sound ready



The motherboard supports the S/PDIF Out function through the S/PDIF connector at midboard. The S/PDIF technology turns your computer into a high-end entertainment system with digital connectivity to powerful audio and speaker systems. See page 1-25 for details.

USB 2.0 technology



The motherboard implements the Universal Serial Bus (USB) 2.0 specification, dramatically increasing the connection speed from the 12 Mbps bandwidth on USB 1.1 to a fast 480 Mbps on USB 2.0. USB 2.0 is backward compatible with USB 1.1. See pages 1-20 and 1-23 for details.

1.3.2 Innovative ASUS features

CrashFree BIOS

This feature allows you to restore the original BIOS data from a floppy disk (with the original BIOS file and the AwardBIOS Flash Utility) in case the BIOS file gets corrupted. This utility eliminates the need to buy a replacement ROM chip. See page 2-4 for details.

ASUS EZ Flash BIOS

With the ASUS EZ Flash, you can easily update the system BIOS even before loading the operating system. No need to use a DOS-based utility or boot from a floppy disk. See page 2-4 for details.

ASUS C.O.P. (CPU Overheating Protection)

The ASUS C.O.P. (CPU Overheating Protection) is a hardware protection circuit that automatically shuts down the system power before temperatures go high enough to permanently damage the CPU. See page 2-26 for details.

1.4 Before you proceed

Take note of the following precautions before you install motherboard components or change any motherboard settings.



- Unplug the power cord from the wall socket before touching any component.
- Use a grounded wrist strap or touch a safely grounded object or a metal object, such as the power supply case, before handling components to avoid damaging them due to static electricity
- Hold components by the edges to avoid touching the ICs on them.
- Whenever you uninstall any component, place it on a grounded antistatic pad or in the bag that came with the component.
- **Before you install or remove any component, ensure that the ATX power supply is switched off or the power cord is detached from the power supply.** Failure to do so may cause severe damage to the motherboard, peripherals, and/or components.

Onboard LED

The motherboard comes with a standby power LED that lights up to indicate that the system is ON, in sleep mode, or in soft-off mode. This is a reminder that you should shut down the system and unplug the power cable before removing or plugging in any motherboard component. The illustration below shows the location of the onboard LED.

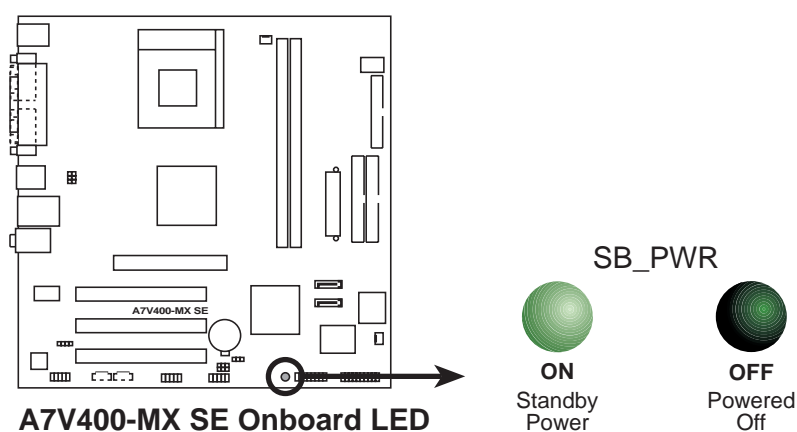

1.5 Motherboard overview

1.5.1 Motherboard layout

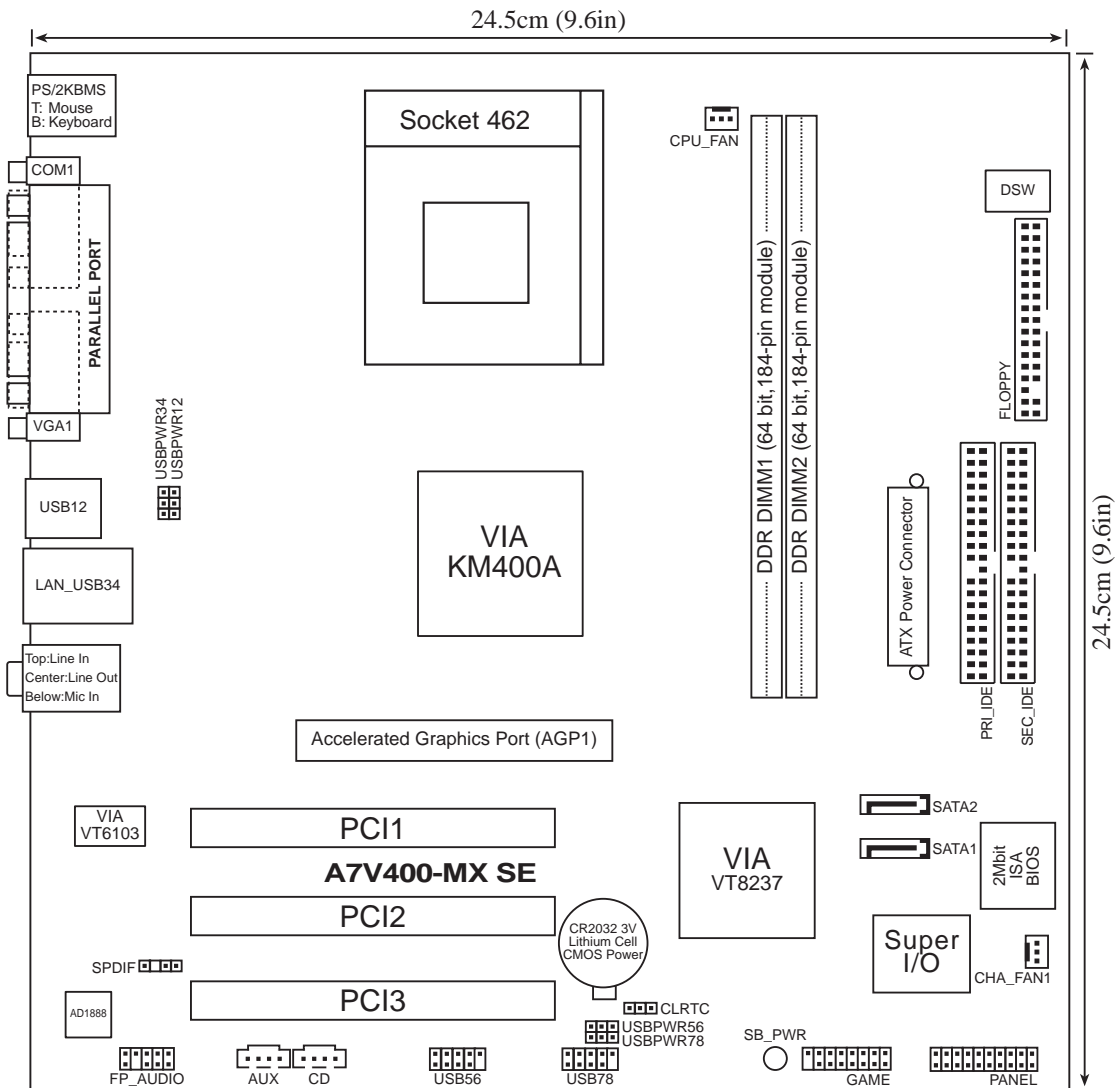

1.5.2 Placement direction

When installing the motherboard, make sure that you place it into the chassis in the correct orientation. The edge with external ports goes to the rear part of the chassis as indicated in the image below.

1.5.3 Screw holes

Place eight (8) screws into the holes indicated by circles to secure the motherboard to the chassis.



Do not overtighten the screws! Doing so can damage the motherboard.

Place this side towards
the rear of the chassis —

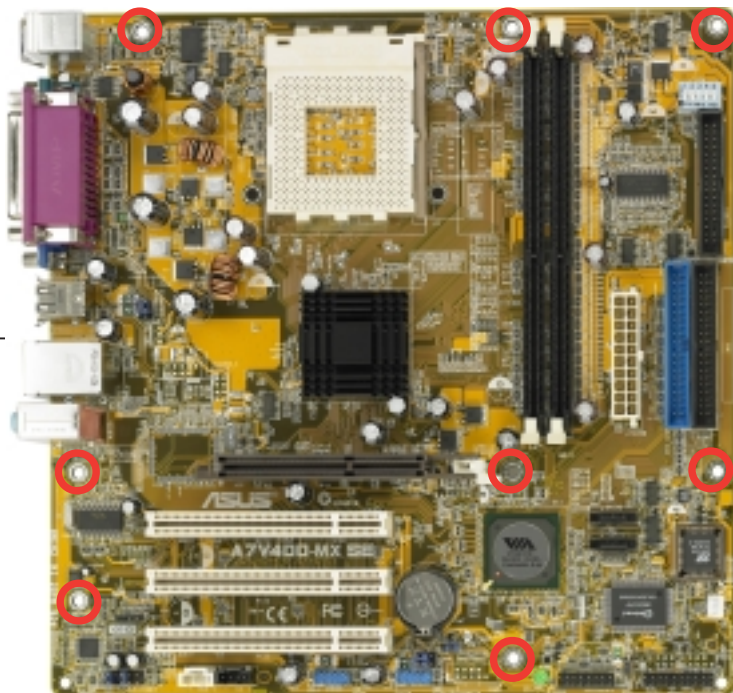

1.6 Central Processing Unit (CPU)

1.6.1 Overview

The motherboard has a Socket A for installation. The Athlon™/Sempron™ CPU has a “marked” corner. This corner is usually indicated with a notch, and/or a golden square or triangle. Refer to this indicator when orienting the CPU. A fan and heatsink should be installed on top of the CPU to prevent overheating.



This motherboard does not support AMD processors with less than 1 GHz core speed.

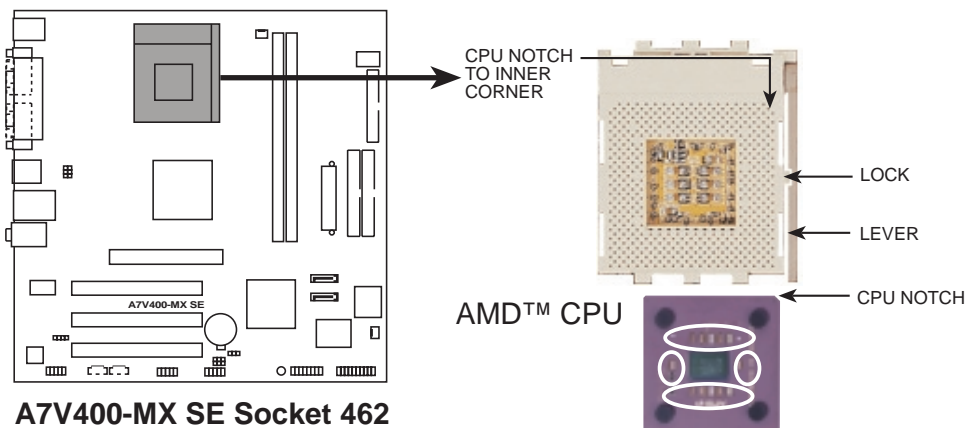

1.6.2 Installing the CPU

Follow these steps to install a CPU:

1. Locate the CPU socket. Open the socket by pulling the lever gently sideways away from the socket, then lift the lever upwards to a 90 to 100-degree angle.
2. Insert the CPU with the correct orientation. The notched or golden corner of the CPU must be oriented toward the inner corner of the socket base nearest to the lever hinge.

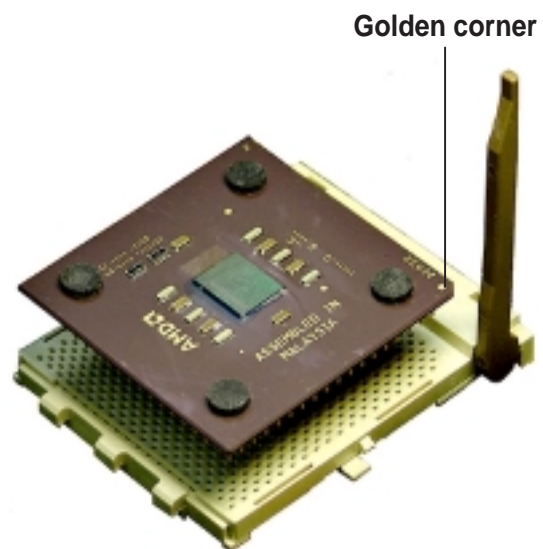

The CPU should drop easily into place. Do not force the CPU into the socket to avoid bending the pins. If the CPU does not fit, check its alignment and look for bent pins.

1.7 System memory

1.7.1 Overview

The motherboard has two Double Data Rate (DDR) DIMM sockets that support up to 2 GB unbuffered non-ECC DDR400*/333/266/200 DDR SDRAM DIMMs. Each DIMM socket is double-sided.

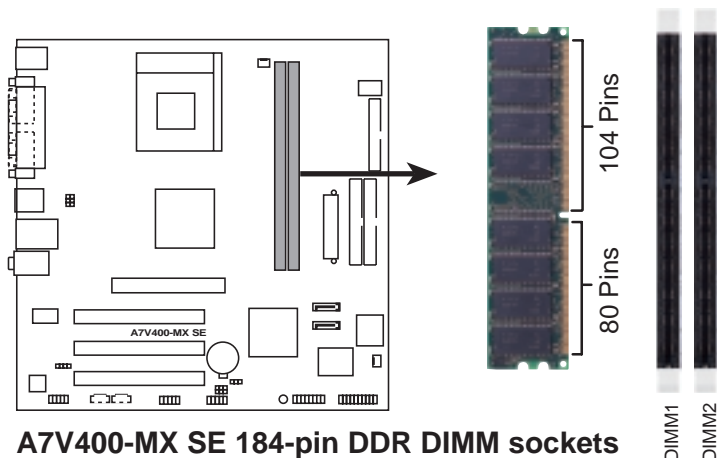

* You can install a DDR400 DIMM(s) on the slot(s). However, a DDR400 DIMM may only run at speeds of up to 333 MHz (DDR333).

1.7.2 Memory configurations

You may install single or double-sided 64 MB, 128 MB, 256 MB, 512 MB, and 1 GB DDR DIMMs to the sockets.



For optimum compatibility, it is recommended that you obtain memory modules from qualified vendors. See the next page for a list of qualified DDR400 and DDR333 DIMM vendors.

DDR400 Qualified Vendors List

Size	Vendor	Model	CL	Brand	Side(s)	Component
256 MB	KINGSTON	KVR400X64C3A/256	N/A	Hynix	SS	HY5DU56822BT-D43
512 MB	KINGSTON	KVR400X64C3A/512	N/A	Hynix	DS	HY5DU56822BT-D43
256 MB	KINGSTON	KVR400X72C3A/256	N/A	Mosel	SS	V58C2256804SAT5(ECC)
512 MB	KINGSTON	KVR400X72C3A/512	N/A	Mosel	DS	V58C2256804SAT5(ECC)
256 MB	KINGSTON	KVR400X64C3A/256	N/A	Infineon	SS	HYB25D256800BT-5B
512 MB	KINGSTON	KVR400X64C3A/512	N/A	Infineon	DS	HYB25D256809BT-5B
256 MB	KINGSTON	KVR400X64C3A/256	N/A	KINGSTON	SS	D3208DL2T-5
512 MB	KINGSTON	KHX3200A/512	N/A	N/A	DS	N/A
1024 MB	KINGSTON	KVR400X64C3A/1G	3	N/A	DS	HYB25D512800BE-5B
1024 MB	KINGSTON	KHX3200ULK2/1G	2	N/A	DS	N/A
256 MB	SAMSUNG	M381L3223ETM-CCC	3ECC	SAMSUNG	SS	K4H560838E-TCCC(ECC)
512 MB	SAMSUNG	M381L6423ETM-CCC	N/A	SAMSUNG	DS	K4H560838E-TCCC(ECC)
256 MB	SAMSUNG	M368L3223ETM-CCC	N/A	SAMSUNG	SS	K4H560838E-TCCC
256 MB	SAMSUNG	M368L3223FTN-CCC	3	SAMSUNG	SS	K4H560838F-TCCC
512 MB	SAMSUNG	M368L6423FTN-CCC	3	SAMSUNG	DS	K4H560838F-TCCC
512 MB	SAMSUNG	M368L6523BTM-CCC	3	SAMSUNG	SS	K4H510838B-TCCC
256 MB	MICRON	MT8VDDT3264AG-40BCB	N/A	MICRON	SS	MT46V32M8TG-5BC
512 MB	MICRON	MT16VDDT6464AG-40BCB	N/A	MICRON	DS	MT46V32M8TG-5BC
256 MB	Infineon	HYS64D32300HU-5-C	3	Infineon	SS	HYB25D256800CE-5C
512 MB	Infineon	HYS64D64320HU-5-C	N/A	Infineon	DS	HYB25D256800CE-5C
256 MB	CORSAIR	CMX256A-3200C2PT	2	Winbond	SS	W942508BH-5
512 MB	CORSAIR	CMX512-3200C2	2	Winbond	DS	N/A
512 MB	CORSAIR	VS512MB400	2.5	VALUE seLecT	DS	VS32M8-5
1024 MB	CORSAIR	TWINX2048-3200C2	3	N/A	DS	N/A
256 MB	Hynix	HYMD232645D8J-D43	3	Hynix	SS	HY5DU56822DT-D43
512 MB	Hynix	HYMD264646D8J-D43	3	Hynix	DS	HY5DU56822DT-D43
256 MB	TwinMOS	M2G9I08AIATT9F081AADT	2.5	TwinMOS	SS	TMD7608F8E50D
512 MB	TwinMOS	M2G9J16AJATT9F081AADT	2.5	TwinMOS	DS	TMD7608F8E50D
256 MB	TwinMOS	M2G9I08A8ATT9F081AADT	2.5	TwinMOS	SS	TMD7608F8E50D
512 MB	TwinMOS	M2G9J16A8ATT9F081AADT	2.5	TwinMOS	DS	TMD7608F8E50D
256 MB	Transcend	TS32MLD64V4F3	3	SAMSUNG	SS	K4H560838F-TCCC
512 MB	Transcend	TS64MLD64V4F3	3	SAMSUNG	DS	K4H560838F-TCCC
1024 MB	Transcend	TS128MLD64V4J	3	SAMSUNG	DS	K4H510838B-TCCC
256 MB	Apacer	77.10636.33G	3	Infineon	SS	HYB25D256800CE-5C
512 MB	Apacer	77.10736.33G	3	Infineon	DS	HYB25D256800CE-5C
256 MB	Apacer	77.10639.60G	2.5	ProMOS	SS	V58C2256804SCT5B
512 MB	Apacer	77.10739.60G	2.5	ProMOS	DS	V58C2256804SCT5B
256 MB	A DATA	MDOSS6F3G31Y0K1E0Z	3	SAMSUNG	SS	K4H560838E-TCCC
512 MB	A DATA	MDOSS6F3H41Y0N1E0Z	3	SAMSUNG	DS	K4H560838F-TCCC
256 MB	A DATA	MDOHY6F3G31Y0N1E0Z	3	Hynix	SS	HY5DU56822CT-D43
512 MB	A DATA	MDOHY6F3H41Y0N1E0Z	3	Hynix	DS	HY5DU56822CT-D43
256 MB	A DATA	MDOAD5F3G31Y0D1E02	2.5	N/A	SS	ADD8608A8A-5B
512 MB	A DATA	MDOAD5F3H41Y0D1E02	2.5	N/A	DS	ADD8608A8A-5B
256 MB	Winbond	W9425GCDB-5	3	Winbond	SS	W942508CH-5
512 MB	Winbond	W9451GCDB-5	N/A	Winbond	DS	W942508CH-5
256 MB	PSC	AL5D8B53T-5B1K	2.5	PSC	SS	A2S56D30BTP
512 MB	PSC	AL6D8B53T-5B1K	2.5	PSC	DS	A2S56D30BTP
256 MB	KINGMAX	MPXB62D-38KT3R	N/A	N/A	SS	KDL388P4LA-50
512 MB	KINGMAX	MPXC22D-38KT3R	N/A	N/A	DS	KDL388P4LA-50
512 MB	SAMSUNG	M378T6553BG0-CD5	N/A	N/A	SS	K4T51083QB-GCD5

DDR400 Qualified Vendors List (continuation)

Size	Vendor	Model	CL	Brand	Side(s)	Component
256 MB	NANYA	NT256D64S88COG-5T	3	N/A	SS	NT5DS32M8CT-5T
512 MB	NANYA	NT512D64S88COG-5T	3	N/A	DS	NT5DS32M8CT-5T
256 MB	BRAIN POWER	B6U808-256M-SAM-400	N/A	SAMSUNG	SS	K4H560838D-TCC4
512 MB	BRAIN POWER	B6U808-512M-SAM-400	N/A	SAMSUNG	DS	K4H560838D-TCC4
256 MB	CENTURY	DXV6S8SSCCE3K27E	N/A	SAMSUNG	SS	K4H560838E-TCCC
512 MB	CENTURY	DXV2S8SSCCE3K27E	N/A	SAMSUNG	DS	K4H560838E-TCCC
256 MB	CENTURY	DXV6S8EL5BM3T27C	N/A	N/A	SS	DD2508AMTA
512 MB	CENTURY	DXV2S8EL5BM3T27C	N/A	N/A	DS	DD2508AMTA
256 MB	elixir	M2U25664DS88C3G-5T	3	elixir	SS	N2DS25680CT-5T
512 MB	elixir	M2U51264DS88C1G-5T	3	elixir	DS	N2DS25680CT-5T
256 MB	Kreton	N/A	N/A	VT	SS	VT3225804T-5
512 MB	Kreton	N/A	N/A	VT	DS	VT3225804T-5
256 MB	Veritech	VT400FMV/2561103	3	VT	SS	VT56DD32M8PC-5
512 MB	Veritech	VT400FMV/5121003	3	VT	DS	VT56DD32M8PC-5
256 MB	Pmi	MD44256VIT3208GMHA01	2.5	MOSEL	SS	V58C2256804SAT5B
512 MB	Pmi	MD44512VIT3208GATA03	2.5	MOSEL	DS	V58C2256804SAT5B
256 MB	ProMOS	V826632K24SCTG-D0	2.5	N/A	SS	V58C2256804SCT5B
512 MB	ProMOS	V826664K24SCTG-D0	2.5	N/A	DS	V58C2256804SCT5B
256 MB	Deutron	AL5D8C53T-5B1T	2.5	PSC	SS	A2S56D30CTP
512 MB	Deutron	AL6D8C53T-5B1T	2.5	PSC	DS	A2S56D30CTP
256 MB	GEIL	GL5123200DC	N/A	N/A	SS	GL3LC32G88TG-35
512 MB	GEIL	GL1GB3200DC	N/A	N/A	DS	GL3LC32G88TG-35
256 MB	GEIL	GLX2563200UP	N/A	N/A	SS	GL3LC32G88TG-5A
256 MB	GEIL	GD3200-512DC	N/A	N/A	SS	WLCSP Package
256 MB	crucial	BL3264Z402.8TG	2	Ballistix	SS	N/A
512 MB	crucial	BL6464Z402.16TG	2	Ballistix	DS	N/A
256 MB	Novax	96M425653CE-40TB6	2.5	CEON	SS	C2S56D30TP-5
512 MB	Novax	96M451253CE-40TB6	2.5	CEON	DS	C2S56D30TP-5

Side(s): **SS** - Single-sided **DS** - Double-sided
CL - CAS Latency



Visit the [ASUS website](#) for the latest DDR400 Qualified Vendors List.

DDR333 Qualified Vendors List

Size	Vendor	Model	CL	Brand	Side(s)	Component
256 MB	NANYA	NT256D64S88C0G-5T	3	N/A	SS	NT5DS32M8CT-5T
256 MB	SAMSUNG	M368L3223ETN-CB3	N/A	SAMSUNG	SS	K4H560838E-TCB3
512 MB	SAMSUNG	M368L6423ETN-CB3	2.5	SAMSUNG	DS	K4H560838E-TCB3
256 MB	SAMSUNG	M381L3223ETM-CB3	2.5ECC	SAMSUNG	SS	K4H560838E-TCB3(ECC)
512 MB	SAMSUNG	M381L6423ETM-CB3	2.5ECC	SAMSUNG	DS	K4H560838E-TCB3(ECC)
256 MB	SAMSUNG	M368L3223FTN-CB3	2.5	SAMSUNG	SS	K4H560838F-TCB3
256 MB	MICRON	MT8VDDT3264AG-335CA	2.5	MICRON	SS	MT46V32M8TG-6TC
512 MB	MICRON	MT16VDDT6464AG-335CA	2.5	MICRON	DS	MT46V32M8TG-6TC
256 MB	CORSAIR	VS256MB333	2.5	VALUE seLecT	SS	VS32M8-6
512 MB	CORSAIR	VS512MB333	N/A	VALUE seLecT	DS	VS32M8-6
256 MB	KINGSTON	KVR333X64C25/256	2.5	KINGSTON	SS	D3208DH1T-6
512 MB	KINGSTON	KVR333X64C25/512	2.5	KINGSTON	DS	D3208DH1T-6
256 MB	PQI	MD3456UPS	N/A	PQI	SS	PQ3D328S6-0246
512 MB	TwinMos	M2G5J16AJATT5F081AA4T	2.5	TwinMos	DS	TMD7608F8E60D
512 MB	MOSEL	MPMC225-383	N/A	MOSEL	DS	V58C2256804SAT6
256 MB	Transcend	TS32MLD64V3F5	N/A	SAMSUNG	SS	K4H560838F-TCCC
256 MB	elixir	M2U25664DS88C3G-6K	2.5	elixir	SS	N2DS25680CT-6K
512 MB	elixir	M2U51264DS8HC1G-6K	2.5	elixir	DS	N2DS25680CT-6K
256 MB	Veritech	VT333FMV/2561103	2.5	VT	SS	VT56DD32M8PC-6
512 MB	Veritech	VT333FMV/5121103	2.5	VT	DS	VT56DD32M8PC-6
256 MB	NANYA	NT256D64S88C0G-6K	2.5	N/A	SS	NT5DS32M8CT-6K
512 MB	NANYA	NT512D64S8HC0G-6K	2.5	N/ A	DS	NT5DS32M8CT-6K
1024 MB	NANYA	NT1GD64S8HA0F-6K	2.5-3-3	HANYA	DS	NT5DS64M8AF-6K

Side(s): **SS** - Single-sided **DS** - Double-sided
CL - CAS Latency



Visit the ASUS website for the latest DDR333 Qualified Vendors List.

1.7.3 Installing a DIMM



Make sure to unplug the power supply before adding or removing DIMMs or other system components. Failure to do so may cause severe damage to both the motherboard and the components.

Follow these steps to install a DIMM.

1. Locate the DIMM sockets in the motherboard.
2. Unlock a DIMM socket by pressing the retaining clips outward.
3. Align a DIMM on the socket such that the notch on the DIMM matches the break on the socket.

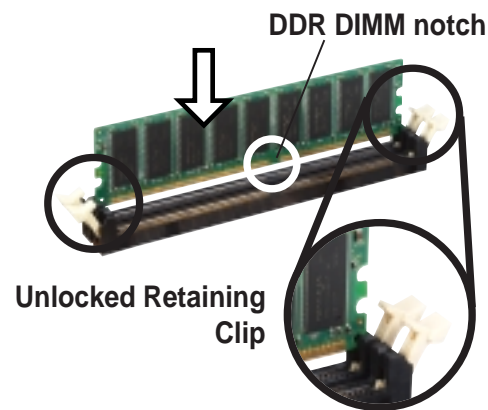

A DDR DIMM is keyed with a notch so that it fits in only one direction. DO NOT force a DIMM into a socket to avoid damaging the DIMM.

4. Firmly insert the DIMM into the socket until the retaining clips snap back in place and the DIMM is properly seated.

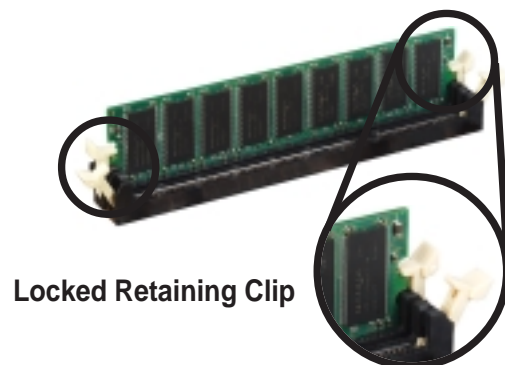

1.7.4 Removing a DIMM

Follow these steps to remove a DIMM.

1. Simultaneously press the retaining clips outward to unlock the DIMM.

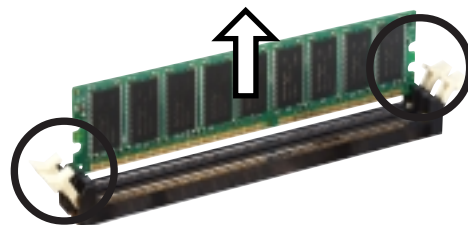

Support the DIMM lightly with your fingers when pressing the retaining clips. The DIMM might get damaged when it flips out with extra force.

2. Remove the DIMM from the socket.

1.8 Expansion slots

In the future, you may need to install expansion cards. The following sub-sections describe the slots and the expansion cards that they support.



Make sure to unplug the power cord before adding or removing expansion cards. Failure to do so may cause you physical injury and damage motherboard components.

1.8.1 Installing an expansion card

To install an expansion card:

1. Before installing the expansion card, read the documentation that came with it and make the necessary hardware settings for the card.
2. Remove the system unit cover (if your motherboard is already installed in a chassis).
3. Remove the bracket opposite the slot that you intend to use. Keep the screw for later use.
4. Align the card connector with the slot and press firmly until the card is completely seated on the slot.
5. Secure the card to the chassis with the screw you removed earlier.
6. Replace the system cover.

1.8.2 Configuring an expansion card

After installing the expansion card, configure the it by adjusting the software settings.

1. Turn on the system and change the necessary BIOS settings, if any. See Chapter 2 for information on BIOS setup.
2. Assign an IRQ to the card. Refer to the tables on the next page.
3. Install the software drivers for the expansion card.

Standard interrupt assignments

IRQ	Priority	Standard Function
0	1	System Timer
1	2	Keyboard Controller
2	-	Re-direct to IRQ#9
4	12	Communications Port (COM1)*
5	13	IRQ holder for PCI steering*
6	14	Floppy Disk Controller
7	15	Printer Port (LPT1)*
8	3	System CMOS/Real Time Clock
9	4	IRQ holder for PCI steering*
10	5	IRQ holder for PCI steering*
11	6	IRQ holder for PCI steering*
12	7	PS/2 Compatible Mouse Port*
13	8	Numeric Data Processor
14	9	Primary IDE Channel
15	10	Secondary IDE Channel

* These IRQs are usually available for ISA or PCI devices.

IRQ assignments for this motherboard

	A	B	C	D
PCI slot 1	—	—	used	—
PCI slot 2	—	—	—	used
PCI slot 3	shared	—	—	—
AGP slot	—	shared	—	—



When using PCI cards on shared slots, ensure that the drivers support “Share IRQ” or that the cards do not need IRQ assignments; otherwise, conflicts will arise between the two PCI groups, making the system unstable and the card inoperable.

1.8.3 AGP slot

The motherboard has an Accelerated Graphics Port (AGP) slot that supports +1.5 V 8X/4X AGP graphics card. Note the notches on the card golden fingers to ensure that they fit into the AGP slot.

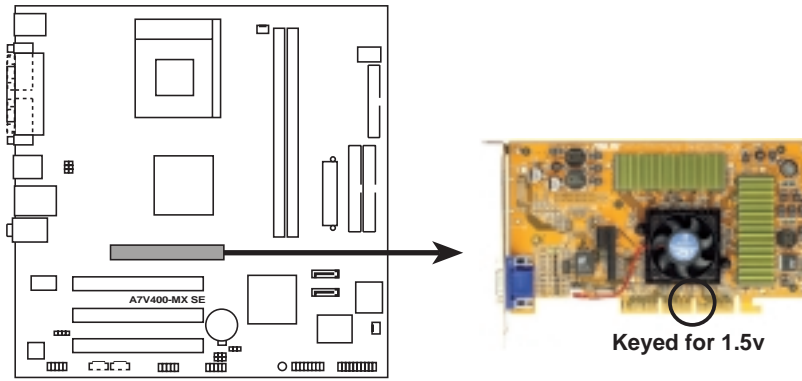

A7V400-MX SE Accelerated Graphics Port (AGP)

1.8.4 PCI slots

The PCI slots support cards such as a LAN card, SCSI card, USB card, and other cards that comply with PCI specifications. The figure shows a LAN card installed on a PCI slot.

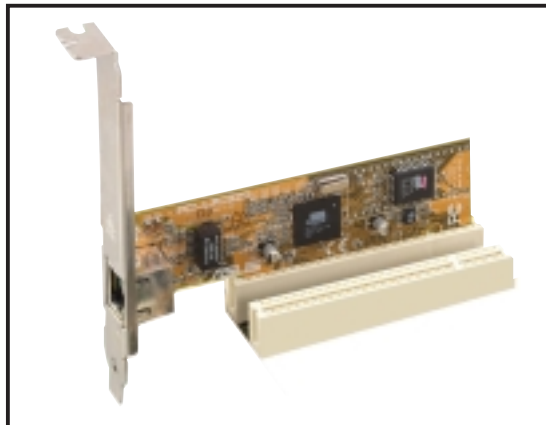

1.9 Switch and jumpers

1. CPU external frequency selection (DSW Switches 1-5)

The motherboard frequency is adjusted through the DIP switches. The white block represents the switch position. The illustration below shows the ON and OFF positions of the switches.

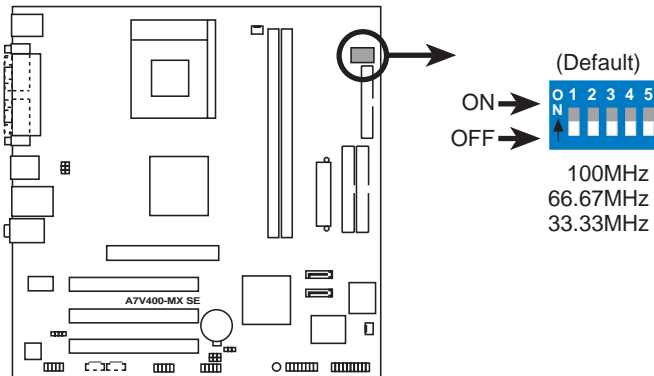

A7V400-MX SE DIP switches



The option to set the CPU core bus frequency multiple is available only on unlocked CPUs. If you are using a locked CPU, setting the switches does not produce any effect.

The DSW switch tells the clock generator what frequency to send the CPU. This allows the selection of the CPU's external frequency (or bus clock). The bus clock multiplied by the frequency multiple equals the CPU's internal frequency (the advertised CPU speed).



The default CPU external frequency is 100 MHz. If your CPU supports 200/166/133 MHz external frequency, adjust the DSW settings before installing the motherboard to the chassis.

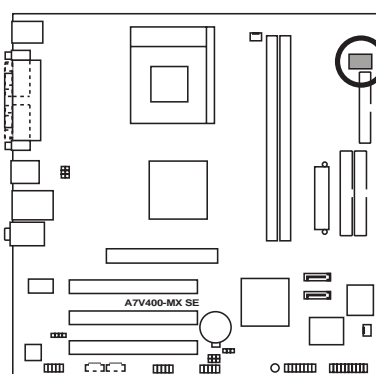

A7V400-MX SE CPU external frequency selection

	DSW				(Default)
	0 1 2 3 4 5	0 1 2 3 4 5	0 1 2 3 4 5	0 1 2 3 4 5	
CPU	200MHz	166.67MHz	133.33MHz	100MHz	
AGP	66.67MHz	66.67MHz	66.67MHz	66.67MHz	
PCI	33.33MHz	33.33MHz	33.33MHz	33.33MHz	

FSB	CPU External Frequency
400	200 MHz
333	166 MHz
266	133 MHz
200	100 MHz



Set the CPU frequency only to the recommended settings. Frequencies other than the recommended CPU bus frequencies are not guaranteed to be stable.

2. Clear RTC RAM (CLRTC)

This jumper allows you to clear the Real Time Clock (RTC) RAM in CMOS. You can clear the CMOS memory of date, time, and system setup parameters by erasing the CMOS RTC RAM data. The onboard button cell battery powers the RAM data in CMOS, which include system setup information such as system passwords.

To erase the RTC RAM:

1. Turn OFF the computer and unplug the power cord.
2. Remove the onboard battery.
3. Move the jumper cap from pins 2-3 (default) to pins 1-2. Keep the cap on pins 1-2 for about 5~10 seconds, then move the cap back to pins 2-3.
4. Reinstall the battery.
5. Plug the power cord and turn ON the computer.
6. Hold down the key during the boot process and enter BIOS setup to re-enter data.



Except when clearing the RTC RAM, never remove the cap on CLRTC jumper default position. Removing the cap will cause system boot failure!

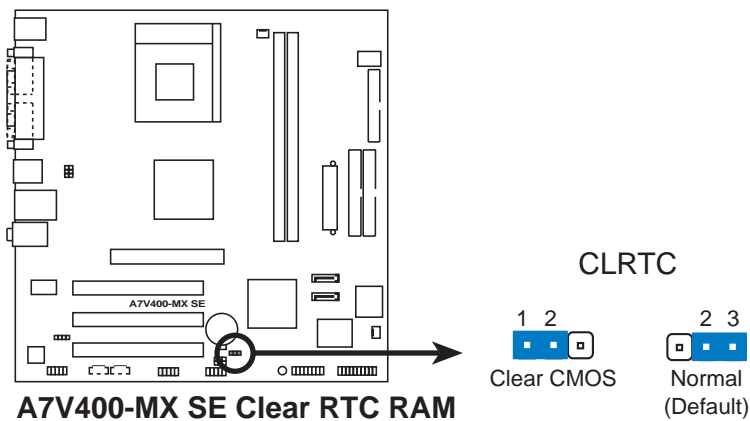

3. USB device wake-up (3-pin USBPWR12, USBPWR34, USBPWR56, USBPWR78)

Set these jumpers to +5V to wake up the computer from S1 sleep mode (CPU stopped, DRAM refreshed, system running in low power mode) using the connected USB devices. Set to +5VSB to wake up from S3 and S4 sleep modes (no power to CPU, DRAM in slow refresh, power supply in reduced power mode).

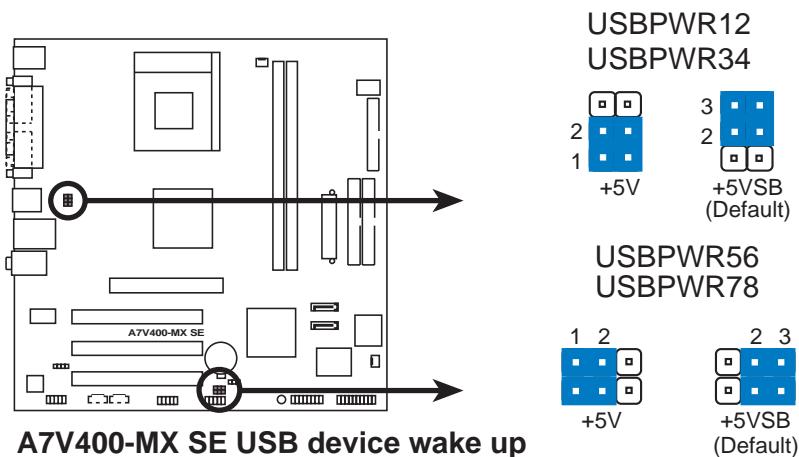

A7V400-MX SE USB device wake up



- The USB device wake-up feature requires a power supply that can provide 500mA on the +5VSB lead for each USB port; otherwise, the system will not power up.
- The total current consumed must NOT exceed the power supply capability (+5VSB) whether under normal condition or in sleep mode.

1.10 Connectors

1.10.1 Rear panel connectors

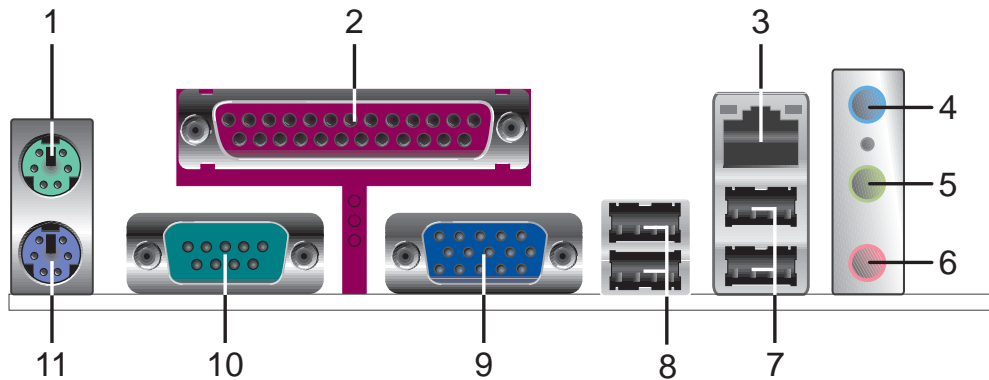

1. **PS/2 mouse port (green).** This port is for a PS/2 mouse.
2. **Parallel port.** This 25-pin port connects a parallel printer, a scanner, or other devices.
3. **LAN (RJ-45) port.** This port allows 10/100 Mbps connection to a Local Area Network (LAN) through a network hub.
4. **Line In port (light blue).** This port connects a tape, CD, DVD player or other audio sources. In 6-channel mode, the function of this port becomes Bass/Center.
5. **Line Out port (lime).** This port connects a headphone or a speaker. In 4/6-channel mode, the function of this port becomes Front Speaker Out.
6. **Microphone port (pink).** This port connects a microphone. In 4/6-channel mode, the function of this port becomes Rear Speaker Out.



The functions of the Line Out, Line In, and Microphone ports change when you select the 4 or 6-channel audio configuration as shown in the following table.

Audio 2, 4, or 6-channel configuration

Port	Headset/2-channel	4-channel	6-channel
Light Blue	Line In	Line In	Bass/Center
Lime	Line Out	Front Speaker Out	Front Speaker Out
Pink	Mic In	Rear Speaker Out	Rear Speaker Out

7. **USB 2.0 ports 3 and 4.** These two 4-pin Universal Serial Bus (USB) ports are available for connecting USB 2.0 devices.
8. **USB 2.0 ports 1 and 2.** These two 4-pin Universal Serial Bus (USB) ports are available for connecting USB 2.0 devices.
9. **Video Graphics Adapter port.** This 15-pin port is for a VGA monitor or other VGA-compatible devices.
10. **Serial port.** This 9-pin COM1 port is for pointing devices or other serial devices.
11. **PS/2 keyboard port (purple).** This port is for a PS/2 keyboard.

1.10.2 Internal connectors

1. Floppy disk drive connector (34-1 pin FLOPPY)

This connector is for the provided floppy disk drive (FDD) signal cable. Insert one end of the cable to this connector, then connect the other end to the signal connector at the back of the floppy disk drive.



Pin 5 on the connector is removed to prevent incorrect cable connection when using a FDD cable with a covered Pin 5.

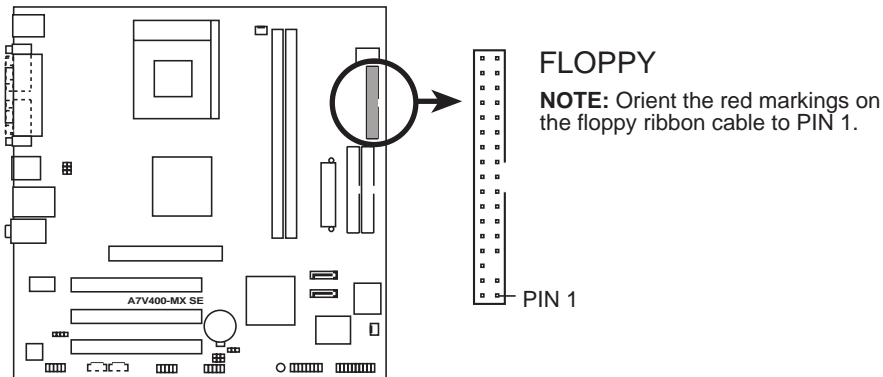

A7V400-MX SE Floppy disk drive connector

2. IDE connectors (40-1 pin PRI_IDE, SEC_IDE)

This connector is for an Ultra DMA 133 signal cable. The Ultra DMA 133 signal cable has three connectors: a blue connector for the IDE connector on the motherboard, a black connector for an Ultra DMA 133/100/66 IDE slave device (optical drive/hard disk drive), and a gray connector for an Ultra DMA 133/100/66 IDE master device (hard disk drive). If you install two hard disk drives, you must configure the second drive as a slave device by setting its jumper accordingly. Refer to the hard disk documentation for the jumper settings.



- Pin 20 on the IDE connector is removed to match the covered hole on the Ultra DMA cable connector. This prevents incorrect insertion when you connect the IDE cable.
- Use the 80-conductor IDE cable for Ultra DMA 133/100/66 IDE devices.

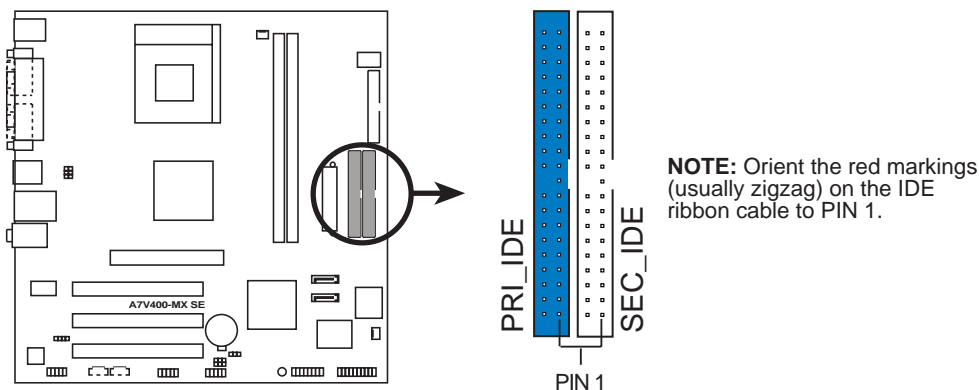

A7V400-MX SE IDE connectors

3. Serial ATA connectors (7-pin SATA1, SATA2)

These connectors are for the Serial ATA signal cables for Serial ATA hard disk drives.

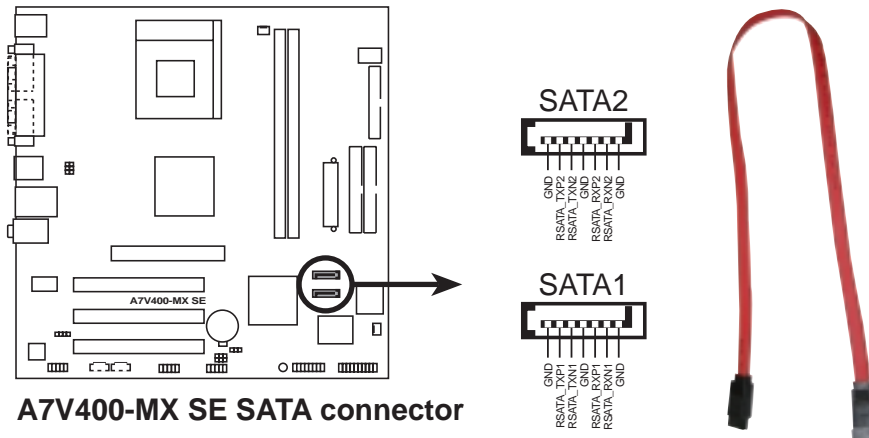

A7V400-MX SE SATA connector



Important notes on Serial ATA

- You must install Windows® 2000 SP4, Windows® XP SP1, Windows® 2003, or newer OS versions before using Serial ATA hard disk drives.
- The Serial ATA interface is not supported when using Windows® 98SE/Me operating system.

4. CPU and chassis fan connectors (3-pin CPU_FAN, CHA_FAN)

The fan connectors support cooling fans of 350 mA~740 mA (8.88 W max.) or a total of 1 A~2.22 A (26.64 W max.) at +12V. Connect the fan cables to the fan connectors on the motherboard, making sure that the black wire of each cable matches the ground pin of the connector.



Do not forget to connect the fan cables to the fan connectors. Insufficient air flow inside the system may damage the motherboard components. These are not jumpers! Do not place jumper caps on the fan connectors!

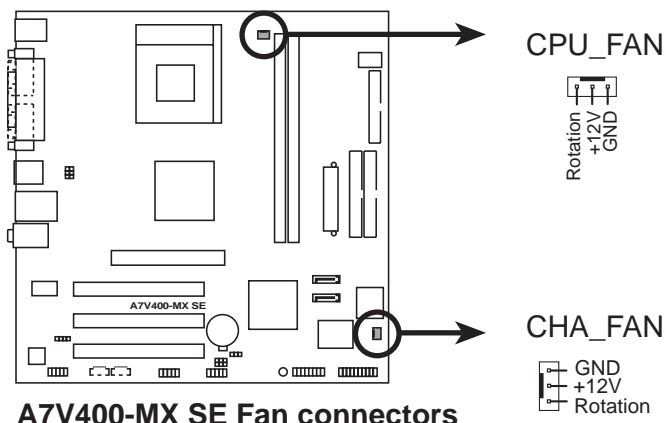

A7V400-MX SE Fan connectors

5. USB connectors (10-1 pin USB56, USB78)

These connectors are for USB 2.0 ports. Connect the USB module cable to any of these connectors, then install the module to a slot opening at the back of the system chassis.



The USB module is purchased separately.

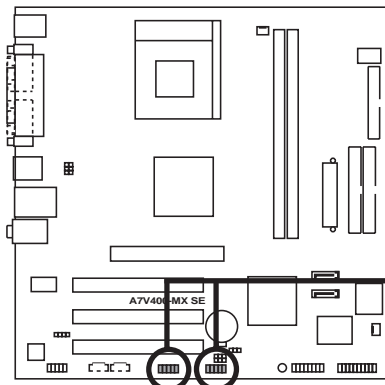

A7V400-MX SE USB connectors

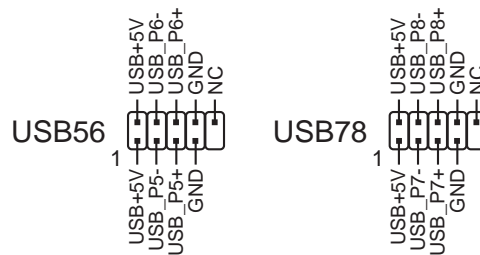

Never connect a **1394 cable** to the USB connectors. Doing so will damage the motherboard!

6. GAME/MIDI connector (16-1 pin GAME)

This connector is for a GAME/MIDI port. Connect the GAME/MIDI module cable to this connector, then install the module to a slot opening at the back of the system chassis. The GAME/MIDI port on the module connects a joystick or a game pad for playing games, and MIDI devices for playing or editing audio files.



The GAME/MIDI module is purchased separately.

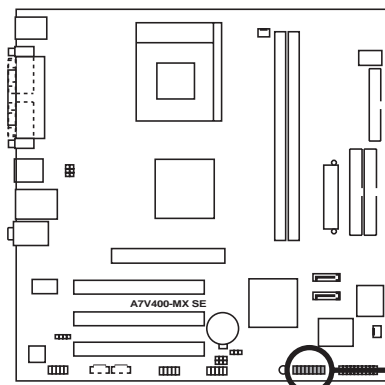

A7V400-MX SE Game connector

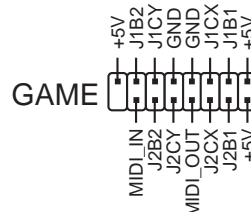

7. Internal audio connectors (4-pin CD, AUX)

These connectors allow you to receive stereo audio input from sound sources such as a CD-ROM, TV tuner, or MPEG card.

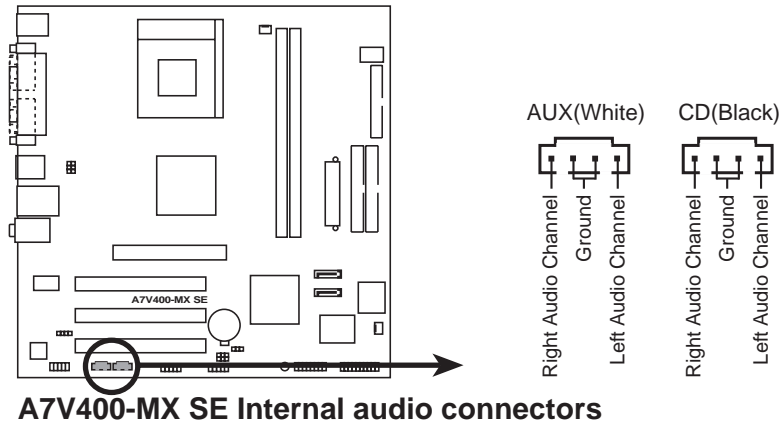

8. Front panel audio connectors (10-1 pin FP_AUDIO)

This connector is for the front panel audio daughterboard cable. This connector supports the front panel audio I/O ports.

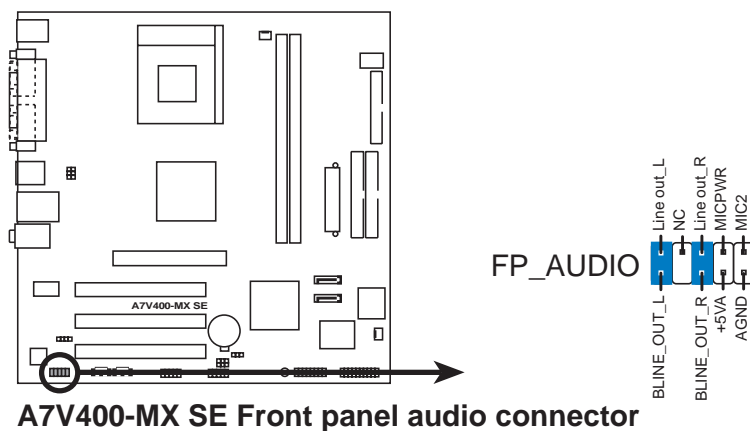

By default, the pins labeled LINE_OUT_R/BLINE_OUT_R and the pins LINE_OUT_L/BLINE_OUT_L are shorted with jumper caps. Remove the caps only when you are connecting the front panel audio cable.

9. Digital audio connector (4-1 pin SPDIF)

This connector is for an additional Sony/Philips Digital Interface (S/PDIF) port(s). Connect the S/PDIF out module cable to this connector, then install the module to a slot opening at the back of the system chassis.



The S/PDIF module is purchased separately.

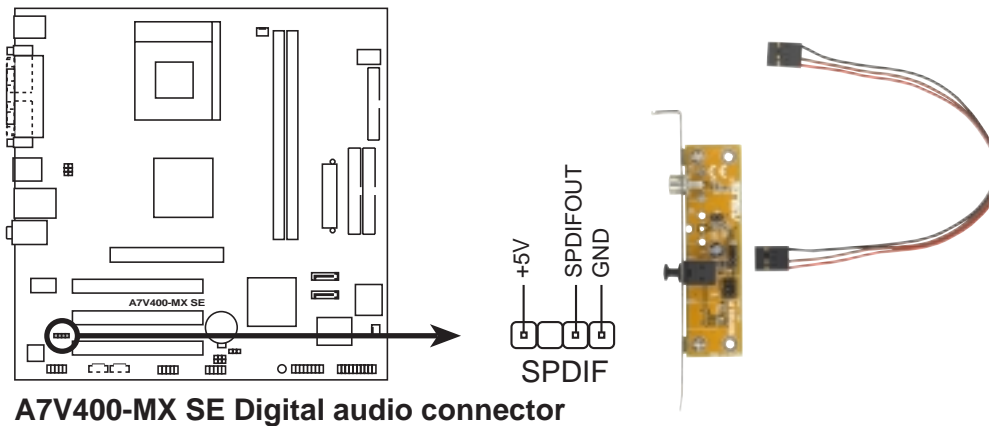

A7V400-MX SE Digital audio connector

10. ATX power connector (20-pin ATXPWR)

This connector is for the 20-pin ATX power supply plug. The plug from the power supply is designed to fit this connector in only one orientation. Find the proper orientation and push down firmly until the connector completely fit.

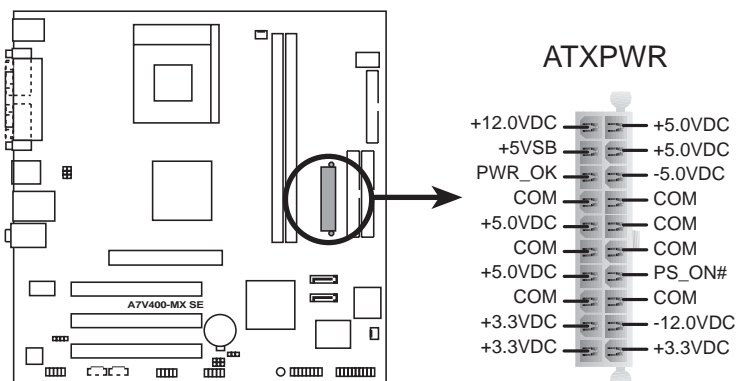

A7V400-MX SE ATX power connector



If you will need to replace the power supply in the future, make sure that your new ATX 12V power supply can provide 8 A on the +12 V lead and at least 1 A on the +5 V standby lead (+5VSB). The minimum recommended wattage is 230W, or 300W for a fully configured system. The system may become unstable and may experience difficulty powering up if the power supply is inadequate.

11. System panel connector (20-pin PANEL)

This connector supports several chassis-mounted functions.

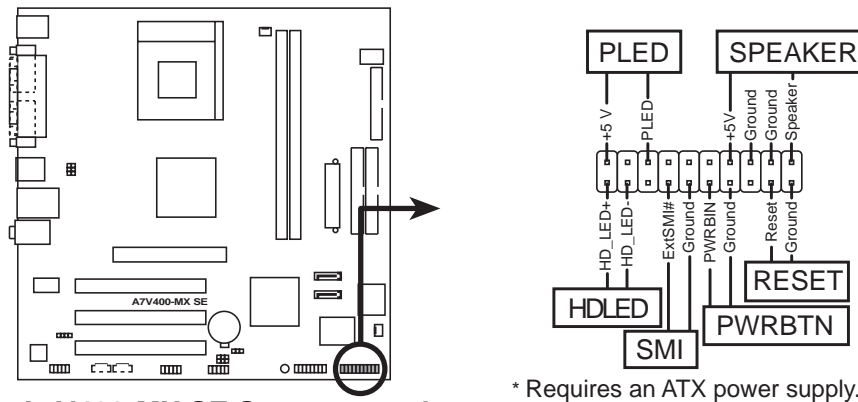

A7V400-MX SE System panel connector

- **System power LED (3-pin PLED)**
This connector is for the system power LED. Connect the chassis power LED cable to this connector. The system power LED lights up when you turn on the system power, and blinks when the system is in sleep mode.
- **System warning speaker (4-pin SPEAKER)**
This connector is for the chassis-mounted system warning speaker. The speaker allows you to hear system beeps and warnings.
- **Reset button (2-pin RESET)**
This connector is for the chassis-mounted reset button for system reboot without turning off the system power.
- **ATX power button/soft-off button (2-pin PWRBTN)**
This connector is for the system power button. Pressing the power button turns the system on or puts the system in sleep or soft-off mode depending on the BIOS settings. Pressing the power switch for more than four seconds while the system is ON turns the system OFF.
- **System Management Interrupt (2-pin SMI)**
This connector is for the chassis-mounted suspend switch that allows you to manually place the system into a suspend mode, or “green” mode. When in suspend mode, the system activity is instantly decreased to save power and to expand the life of certain system components.
- **Hard disk drive activity LED (2-pin HDLED)**
This connector is for the HDD Activity LED. Connect the HDD Activity LED cable to this connector. The IDE LED lights up or flashes when data is read from or written to the HDD.

This chapter tells how to change the system settings through the BIOS Setup menus. Detailed descriptions of the BIOS parameters are also provided.

BIOS setup

2.1 Managing and updating your BIOS

The following utilities allow you to manage and update the motherboard Basic Input/Output System (BIOS) setup.

1. **AwardBIOS Flash Utility** (Updates the BIOS in DOS mode using a bootable floppy disk.)
2. **ASUS CrashFree BIOS** (Updates the BIOS using a floppy disk when the BIOS file fails or gets corrupted.)
3. **ASUS EZ Flash** (Updates the BIOS in DOS mode using a floppy disk.)
4. **ASUS Update** (Updates the BIOS in Windows® environment.)

Refer to the corresponding sections for details on these utilities.



Save a copy of the original motherboard BIOS file to a floppy disk in case you need to restore the BIOS in the future. Copy the original motherboard BIOS using the ASUS Update or AwardBIOS Flash utilities.

2.1.1 Creating a bootable floppy disk

1. Do either one of the following to create a bootable floppy disk.

DOS environment

- a. Insert a 1.44MB floppy disk into the drive.
- b. At the DOS prompt, type `format a: /s` then press <Enter>.

Windows® XP environment

- a. Insert a 1.44 MB floppy disk to the floppy disk drive.
- b. Click **Start** from the Windows® desktop, then select **My Computer**.
- c. Select the 3 1/2 Floppy Drive icon.
- d. Click **File** from the menu, then select **Format. A Format 3 1/2 Floppy Disk** window appears.
- e. Select **Create an MS-DOS startup disk** from the format options field, then click **Start**.

Windows® 2000 environment

To create a set of boot disks for Windows® 2000:

- a. Insert a formatted, high density 1.44 MB floppy disk into the drive.
 - b. Insert the Windows® 2000 CD to the optical drive.
 - c. Click **Start**, then select **Run**.
 - d. From the Open field, type
`D:\bootdisk\makeboot a:`
assuming that D: is your optical drive.
 - e. Press <Enter>, then follow screen instructions to continue.
2. Copy the original or the latest motherboard BIOS file to the bootable floppy disk.

2.1.2 AwardBIOS Flash Utility

You may update the Basic Input/Output System (BIOS) using a bootable floppy disk with the executable AwardBIOS Flash utility (AWDFLASH.EXE).

To update the BIOS using the AwardBIOS Flash Utility:

1. Download the latest BIOS file from the ASUS website. Rename the file to *.BIN, then save it to the bootable floppy disk you created earlier.



Save only the updated BIOS file in the floppy disk to avoid loading a wrong BIOS file.

2. Copy the AWDFLASH.EXE utility from the support CD to the floppy disk.
3. Boot the computer from the floppy disk drive.
4. When the prompt (A:) appears, type **awdflash.exe**, then press <Enter> to display the AwardBIOS Flash Utility screen. The utility automatically checks the new BIOS file on the floppy disk.

```
AwardBIOS Flash Utility for ASUS V1.09
(C) Phoenix Technologies Ltd. All Rights Reserved

For KM400-8237-A7V400SE-00      DATE: 01/06/2005
Flash Type - SST 39SF020 /5V

File Name to Program      : a7v4se02.bin

Message: Please Wait!
```

5. After verification, the utility updates the BIOS file. Do not shut down the computer during the updating process. The computer returns to POST after updating the BIOS file.

```
AwardBIOS Flash Utility for ASUS V1.09
(C) Phoenix Technologies Ltd. All Rights Reserved

For KM400-8237-A7V400SE-00      DATE: 01/06/2005
Flash Type - SST 39SF020 /5V

File Name to Program      : a7v4se02.bin
Program Flashing Memory - 0FE00 OK

Write OK      No Update      Write Fail

Warning: Don't Turn OFF Power Or Reset System!
```

2.1.3 ASUS CrashFree BIOS utility

The ASUS CrashFree BIOS allows you to update the BIOS file when it fails or gets corrupted. You can update a corrupted BIOS file using a floppy disk that contains the updated BIOS file and the AWDFLASH utility.



Before using this utility, prepare the bootable floppy disk containing the updated motherboard BIOS and the AWDFLASH.EXE utility. The AWDFLASH.EXE utility is available from the support CD.

To update the BIOS using CrashFree BIOS:

1. Turn on the system.
2. When prompted, place the floppy disk with the updated BIOS file and the AWDFLASH.EXE utility to the floppy disk drive.
3. The AwardBIOS Flash Utility window appears. Follow the instructions in the previous section to update the BIOS.



Before using the ASUS CrashFree BIOS feature on this motherboard, you must install an AGP or PCI VGA card to one of the expansion slots before you turn on the computer. Motherboards with onboard VGA (such as A7V400-MX SE) do not display the screen when the BIOS crashes even after you reboot the computer.

2.1.4 ASUS EZ Flash utility

The ASUS EZ Flash feature allows you to update the BIOS without having to go through the long process of booting from a floppy disk and using a DOS-based utility. The EZ Flash utility is built-in the BIOS chip so it is accessible by pressing <Alt> + <F2> during the Power-On Self Tests (POST).



Before using this utility, prepare the floppy disk containing the updated motherboard BIOS.

To update the BIOS using EZ Flash:

1. Insert the floppy disk with the updated BIOS file to the floppy disk drive, then turn on the system.
2. Press <Alt> + <F2> during POST to display the AwardBIOS Flash Utility screen.
3. Follow the instructions in section “2.1.2 Award BIOS Flash Utility” to update the BIOS.



After updating the BIOS file using the AwardBIOS Flash Utility, ASUS CrashFree BIOS, or ASUS EZ Flash, enter the BIOS Setup and load the default values using the Exit Menu. See section “2.7 Exit menu” for details.

2.1.5 ASUS Update utility

The ASUS Update is a utility that allows you to manage, save, and update the motherboard BIOS in Windows® environment. The ASUS Update utility allows you to:

- Save the current BIOS file
- Download the latest BIOS file from the Internet
- Update the BIOS from an updated BIOS file
- Update the BIOS directly from the Internet, and
- View the BIOS version information.

This utility is available in the support CD that comes with the motherboard package.

Installing ASUS Update

To install ASUS Update:

1. Place the support CD in the optical drive. The **Drivers** menu appears.
2. Click the **Utilities** tab, then click **ASUS Update**. See page 3-3 for the **Utilities** screen menu.
3. The ASUS Update utility is copied to your system.



- ASUS Update requires an Internet connection either through a network or an Internet Service Provider (ISP).
- Quit all Windows® applications before you update the BIOS using this utility.

Updating the BIOS through the Internet

To update the BIOS through the Internet:

1. Launch the ASUS Update utility from the Windows® desktop by clicking **Start > Programs > ASUS > ASUSUpdate > ASUSUpdate**. The ASUS Update main window appears.
2. Select **Update BIOS from the Internet** option from the drop-down menu, then click **Next**.
3. Select the ASUS FTP site nearest you to avoid network traffic, or click **Auto Select**. Click **Next**.



- From the FTP site, select the BIOS version that you wish to download. Click Next.
- Follow the screen instructions to complete the update process.



The ASUS Update utility is capable of updating itself through the Internet. Always update the utility to avail all its features.



Updating the BIOS through a BIOS file

To update the BIOS through a BIOS file:

- Launch the ASUS Update utility from the Windows® desktop by clicking **Start > Programs > ASUS > ASUSUpdate > ASUSUpdate**. The ASUS Update main window appears.
- Select **Update BIOS from a file** option from the drop-down menu, then click **Next**.



- Locate the BIOS file from the **Open** window, then click **Save**.
- Follow the screen instructions to complete the update process.

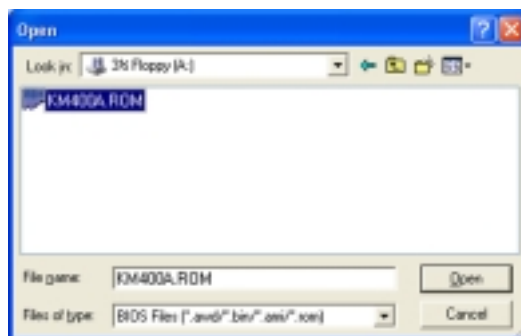

2.2 BIOS beep codes

When you turn the power on and the system runs POST (Power On Self Tests), you will hear BIOS beeps. Refer to the following table for the meaning of the beeps.

Award BIOS beep codes

Beep	Meaning
One short beep when displaying logo	No error during POST
Long beeps in an endless loop	No DRAM installed or detected
One long beep followed by three short beeps	Video card not found or video card memory bad
High frequency beeps when system is working	CPU overheated; System running at a lower frequency

2.3 BIOS setup program

This motherboard supports a programmable low pin count (LPC) chip that you can update using the provided utility described in section “2.1 Managing and updating your BIOS.”

Use the BIOS Setup program when you are installing a motherboard, reconfiguring your system, or prompted to “Run Setup.” This section explains how to configure your system using this utility.

Even if you are not prompted to use the Setup program, you can change the configuration of your computer in the future. For example, you can enable the security password feature or change the power management settings. This requires you to reconfigure your system using the BIOS Setup program so that the computer can recognize these changes and record them in the CMOS RAM of the firmware hub.

The firmware hub on the motherboard stores the Setup utility. When you start up the computer, the system provides you with the opportunity to run this program. Press during the Power-On-Self-Test (POST) to enter the Setup utility; otherwise, POST continues with its test routines.

If you wish to enter Setup after POST, restart the system by pressing <Ctrl+Alt+Delete>, or by pressing the reset button on the system chassis. You can also restart by turning the system off and then back on. Do this last option only if the first two failed.

The Setup program is designed to make it as easy to use as possible. Being a menu-driven program, it lets you scroll through the various sub-menus and make your selections from the available options using the navigation keys.



- The default BIOS settings for this motherboard apply for most conditions to ensure optimum performance. If the system becomes unstable after changing any BIOS settings, load the default settings to ensure system compatibility and stability. Select the **Load Default Settings** item under the Exit Menu. See section “2.7 Exit Menu.”
- The BIOS setup screens shown in this section are for reference purposes only, and may not exactly match what you see on your screen.
- Visit the ASUS website (www.asus.com) to download the latest BIOS file for this motherboard.

2.3.1 BIOS menu bar

The top of the screen has a menu bar with the following selections:

- MAIN** Use this menu to make changes to the basic system configuration.
- ADVANCED** Use this menu to enable and make changes to the advanced features.
- POWER** Use this menu to configure and enable Power Management features.
- BOOT** Use this menu to configure the default system device used to locate and load the Operating System.
- EXIT** Use this menu to exit the current menu or to exit the Setup program.

To access the menu bar items, press the right or left arrow key on the keyboard until the desired item is highlighted.

2.3.2 Legend bar

At the bottom of the Setup screen is a legend bar. The keys in the legend bar allow you to navigate through the various setup menus. The following table lists the legend bar keys and their corresponding functions.

Navigation Key	Function
<F1>	Displays the General Help screen
<F2>	Navigates the Item Specific Help screen
<F5>	Loads previous values
<Esc>	Jumps to the Exit menu or returns to the main menu from a sub-menu
Left or Right arrow	Selects the menu item to the left or right
Up or Down arrow	Moves the highlight up or down between fields
Page Down or - (minus)	Scrolls backward through the values for the highlighted field
Page Up or + (plus)	Scrolls forward through the values for the highlighted field
<Enter>	Brings up a selection menu for the highlighted field
<F10>	Saves changes and exit

General help

In addition to the Item Help window, the BIOS setup program also provides a General Help screen. You may launch this screen from any menu by simply pressing <F1>. The General Help screen lists the legend keys and their corresponding functions.

Scroll bar

When a scroll bar appears to the right of a help window, it indicates that there is more information to be displayed that will not fit in the window. Use <PgUp> and <PgDn> or the up and down arrow keys to scroll through the entire help document. Press <Home> to display the first page, press <End> to go to the last page. To exit the help window, press <Enter> or <Esc>.

Sub-menu

The right pointer symbol that appears at the left of certain parameters indicates that a sub-menu exists for this field. A sub-menu offers additional parameter options. To display a sub-menu, move the highlight to the field and press <Enter>. The sub-menu appears. Use the legend keys to navigate and enter values within each sub-menu as you would within a menu. Use the <Esc> key to return to the main menu. Take some time to familiarize yourself with the legend keys and their corresponding functions. Practice navigating through the various menus and sub-menus. While moving around through the Setup program, note that explanations appear in the Item Help window located to the right of each menu. This window displays the help text for the highlighted field.

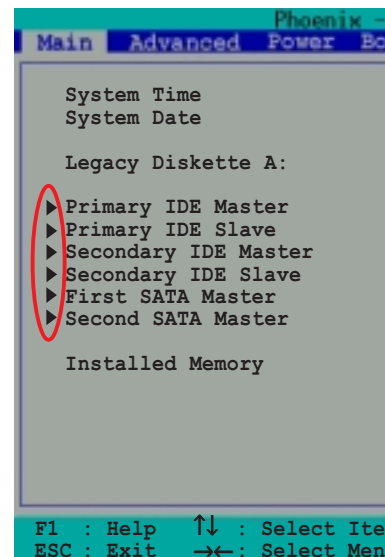

Saving changes and exiting the Setup program

See “2.8 Exit menu” for detailed information on saving changes and exiting the setup program.

2.4 Main menu

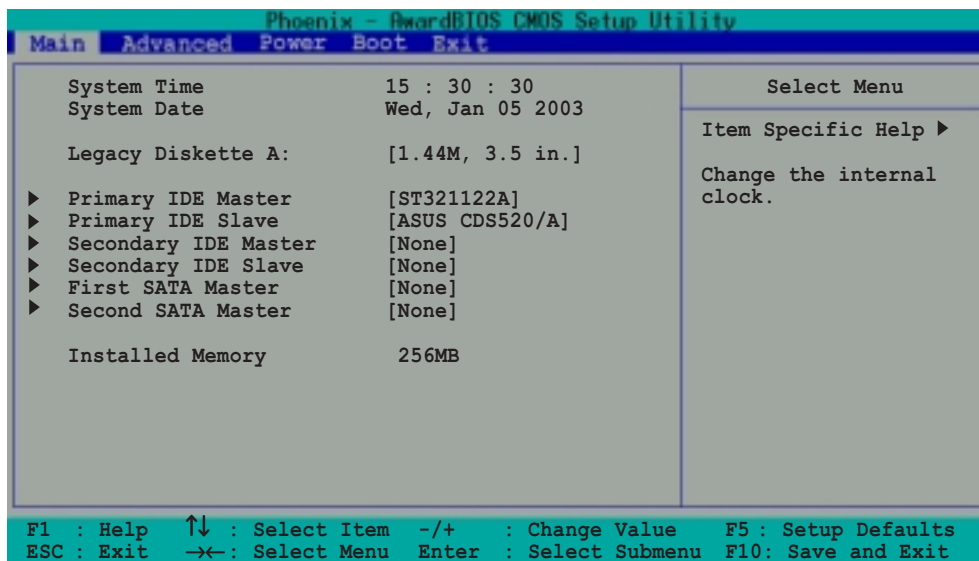

System Time [hh:mm:ss]

Sets the system to the time that you specify (usually the current time). The format is hour, minute, second. Valid values for hour, minute and second are Hour: (00 to 23), Minute: (00 to 59), Second: (00 to 59). Use the <Tab> key to move between the hour, minute, and second fields.

System Date [day, mm dd yyyy]

Sets the system to the date that you specify (usually the current date). The format is month, day, year. Valid values for month, day, and year are Month: (1 to 12), Day: (1 to 31), Year: (1999 to 2099). Use the <Tab> key to move between the month, day, and year fields.

Legacy Diskette A [1.44M, 3.5 in.]

Sets the type of floppy drive installed. Configuration options: [None] [360K, 5.25 in.] [1.2M, 5.25 in.] [720K, 3.5 in.] [1.44M, 3.5 in.] [2.88M, 3.5 in.]

Installed Memory [XXX MB]

This field automatically displays the amount of conventional memory detected by the system during the boot process.

Primary/Secondary IDE Master/Slave

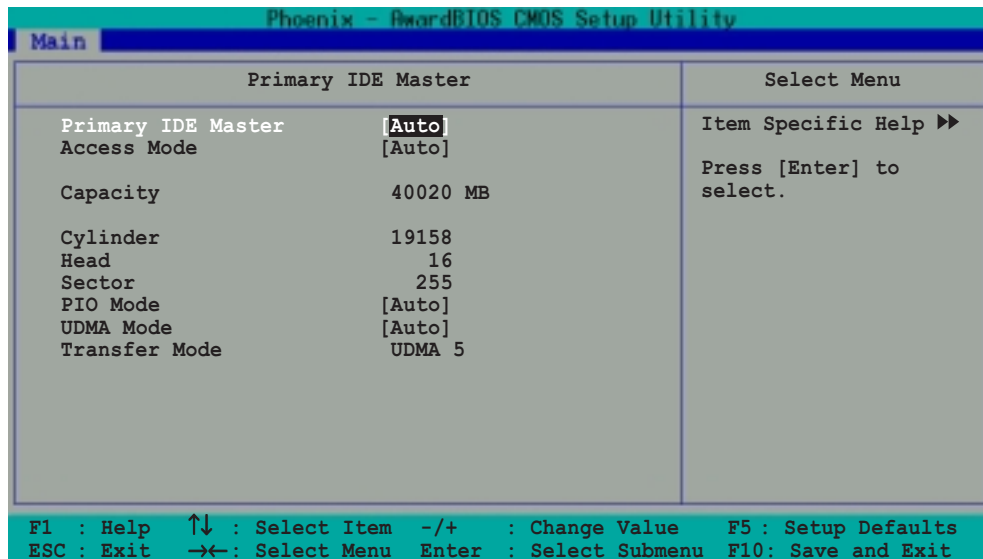

Primary IDE Master/Slave [Auto] Secondary IDE Master/Slave [Auto]

Select [Auto] to automatically detect an IDE hard disk drive. If automatic detection is successful, the setup BIOS automatically fills in the correct values for the remaining fields on this sub-menu. If automatic detection fails, this may be because the hard disk drive is too old or too new. If the hard disk was already formatted on a previous system, the setup BIOS may detect incorrect parameters. In these cases, select [Manual] to manually enter the IDE hard disk drive parameters. If no drive is installed or if you are removing a drive and not replacing it, select [None].

Configuration options: [None] [Auto] [Manual]

Access Mode [Auto]

The default [Auto] automatically detects an IDE hard disk drive. Select [CHS] in coordination with the [Manual] setting of the Primary IDE Master in to manually enter the hard disk drive values.



Before attempting to configure a hard disk drive, make sure you have the correct configuration information supplied by the drive manufacturer. Incorrect settings may cause the system to fail to recognize the installed hard disk.

[Manual] and [CHS] Settings

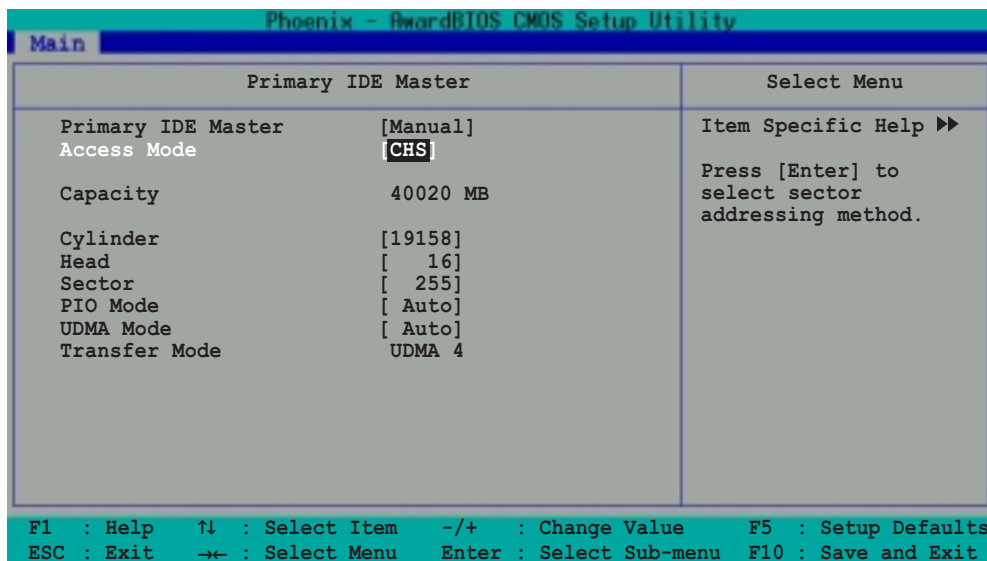

Manually enter the number of cylinders, heads and sectors per track for the drive. Refer to the drive documentation or the drive label for this information.



After entering the IDE hard disk drive information into BIOS, use a disk utility, such as FDISK, to partition and format new IDE hard disk drives. This is necessary so that you can write or read data from the hard disk. Make sure to set the partition of the Primary IDE hard disk drives to active.

After making your selections on this sub-menu, press the <Esc> key to return to the Main menu. The Main menu displays the hard disk drive field with your configuration.

Access Mode [Auto]

Select the hard disk drive type from this field. When Logical Block Addressing (LBA) is enabled, the 28-bit addressing of the hard drive is used without regard for cylinders, heads, or sectors. Note that LBA Mode is necessary for drives with more than 504 MB storage capacity. Select [CHS] to make manual entries for configuring the fields below.

Configuration options: [CHS] [LBA] [Large] [Auto]

Capacity

Displays the hard disk drive capacity in MB or GB. This item is non-configurable.

Cylinder

Configures the number of cylinders. Refer to the drive documentation to determine the correct value.

Head

Configures the number of read/write heads. Refer to the drive documentation to determine the correct value. To make changes to this field, set the IDE Primary Master field to [Manual] and the Access Mode to [CHS].

Sector

Configures the number of sectors per track. Refer to the drive documentation to determine the correct value.

PIO Mode

Sets the PIO mode. Configuration options: [Auto] [Mode 0] [Mode 1] [Mode 2] [Mode 3] [Mode 4]

UDMA Mode

Sets the UDMA transfer mode. Configuration options: [Disabled] [Auto]

Transfer Mode

Sets the transfer mode. Configuration options: [Auto] [UDMA0] [UDMA1] [UDMA2] [UDMA3] [UDMA4] [UDMA5]

First/Second SATA Master

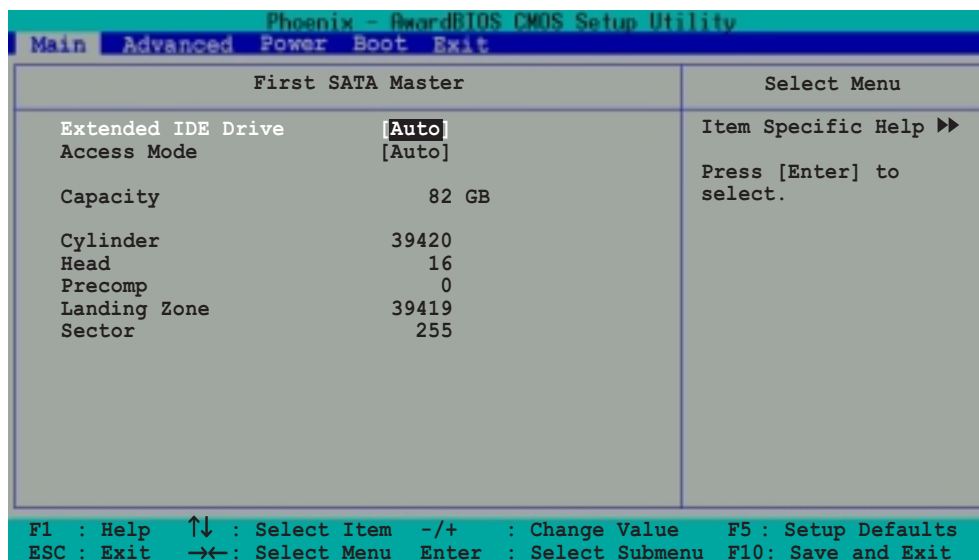

Extended IDE Drive [Auto]

Sets the installed SATA hard disk drive as an extended IDE drive. Configuration options: [Auto] [None]

Access Mode [Auto]

The default [Auto] enables or disables the LBA mode for the SATA hard disk drive. Configuration options: [Auto] [Large]

Capacity

Refer to the previous section.

Cylinder

Refer to the previous section.

Head

Refer to the previous section.

Precomp

Displays the precompressed volumes on the hard disk drive (in MB), if any.

Landing Zone

Displays the drive's maximum useable capacity as calculated by the BIOS based on the drive information you entered.

Sector

Refer to the previous section.

2.5 Advanced menu

The Advanced menu items allow you to change the settings for the CPU and other system devices.

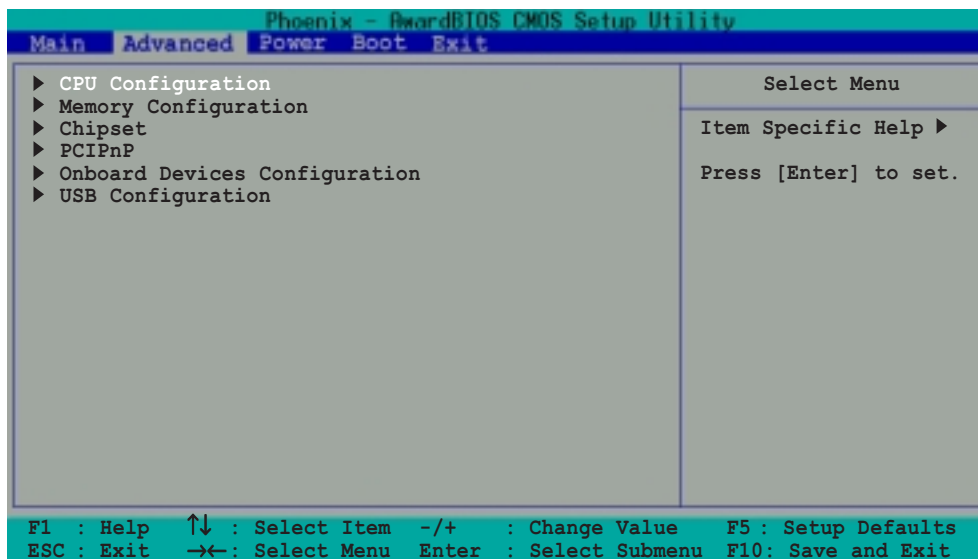

2.5.1 CPU Configuration

This menu displays the CPU type, speed, cache RAM, and current front side bus frequency auto-detected by the BIOS.

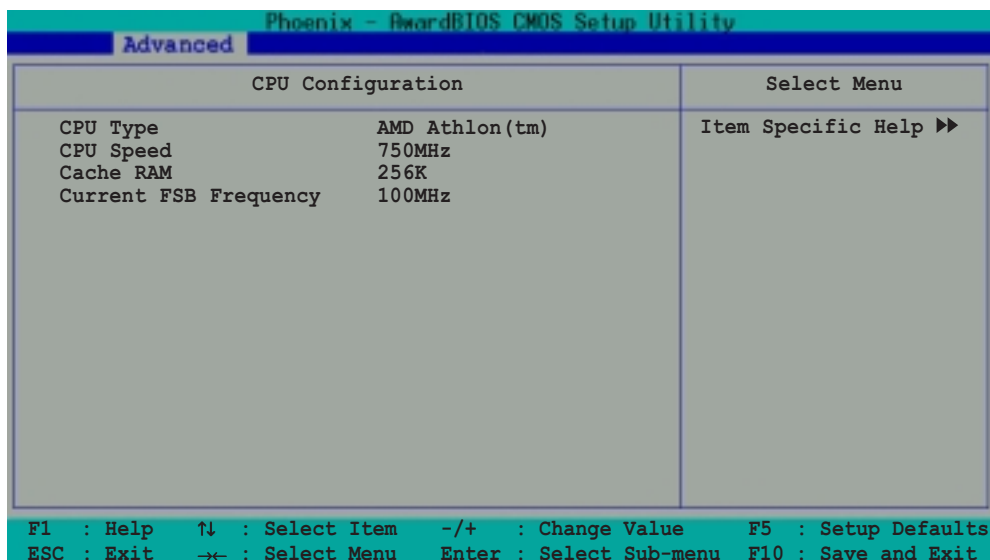

2.5.2 Memory Configuration

This menu allows you to change the system memory settings.

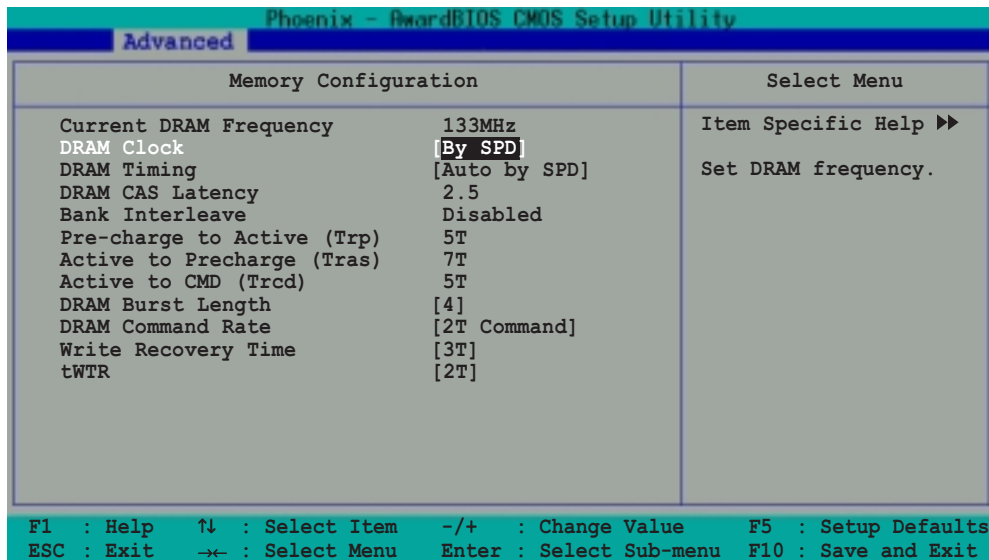

Current DRAM Frequency [XXX MHz]

Displays the current memory frequency as auto-detected by the BIOS.

DRAM Clock [By SPD]

The DRAM clock are set according to the DRAM SPD (Serial Presence Detect). You can manually set the DRAM clock parameters.

Configuration options: [By SPD] [133 MHz] [166 MHz]

DRAM Timing [Auto by SPD]

It is recommended that you set this parameter to [Auto by SPD]. Setting to [Auto by SPD] synchronizes the DRAM timing with the DRAM clock.

Setting to [Manual] allows you to set the values for DRAM CAS Latency, Bank Interleave, Pre-charge to Active (TRP) and Active to CMD (Trcd) parameters. Configuration options: [Manual] [Auto By SPD] [Safe]

DRAM CAS Latency [2.5]

Sets the override clock cycle for the latency time between the DRAM read command and the moment that the data actually becomes available.

Normally, the system determines the rate automatically by default.

Configuration options: [1.5] [2] [2.5] [3]

Bank Interleave [Disabled]

Sets the memory bank interleave. Configuration options: [Disabled]

[2 Bank] [4 Bank]

Precharge to Active (Trp) [5T]

Configuration options: [2T] [3T] [4T] [5T]

Active to Precharge (Tras) [7T]

Configuration options: [6T] [7T] [8T] [9T]

Active to CMD (Trcd) [5T]

Configuration options: [2T] [3T] [4T] [5T]

DRAM Burst Length [4]

Configuration options: [4] [8]

DRAM Command Rate [2T Command]

Configuration options: [2T Command] [1T Command]

Write Recovery Time [3T]

Configuration options: [2T] [3T]

tWTR [2T]

Configuration options: [1T] [2T]

2.5.3 Chipset

The Chipset menu allows you to change the advanced chipset settings. Select an item then press <Enter> to display the sub-menu.

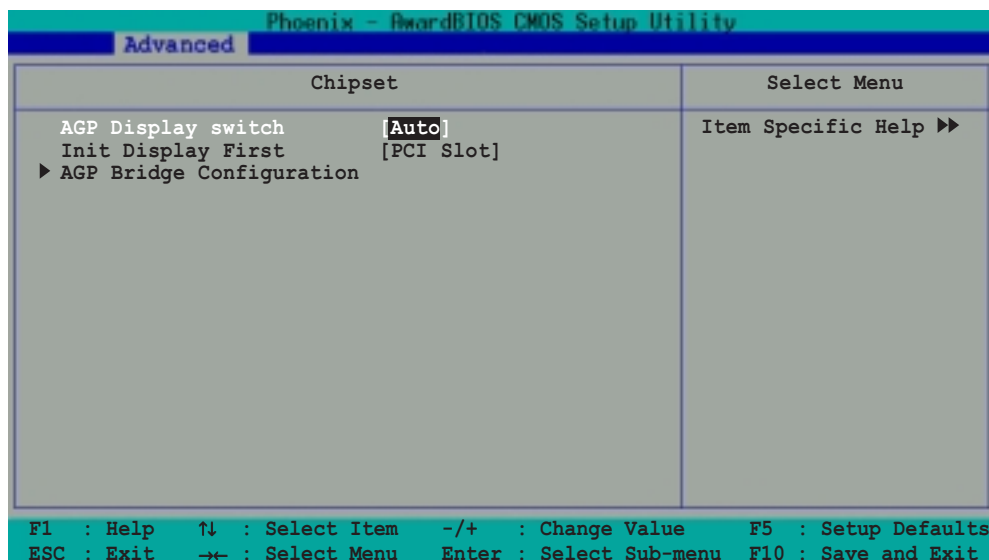

AGP Display switch [Auto]

Allows you to set the AGP display control to [Auto] or through the onboard AGP controller. Configuration options: [Auto] [Onchip AGP]

Init Display First [PCI Slot]

Allows you to select the primary VGA type if your system has multiple video controllers. Configuration options: [PCI Slot] [AGP]

AGP Bridge Configuration

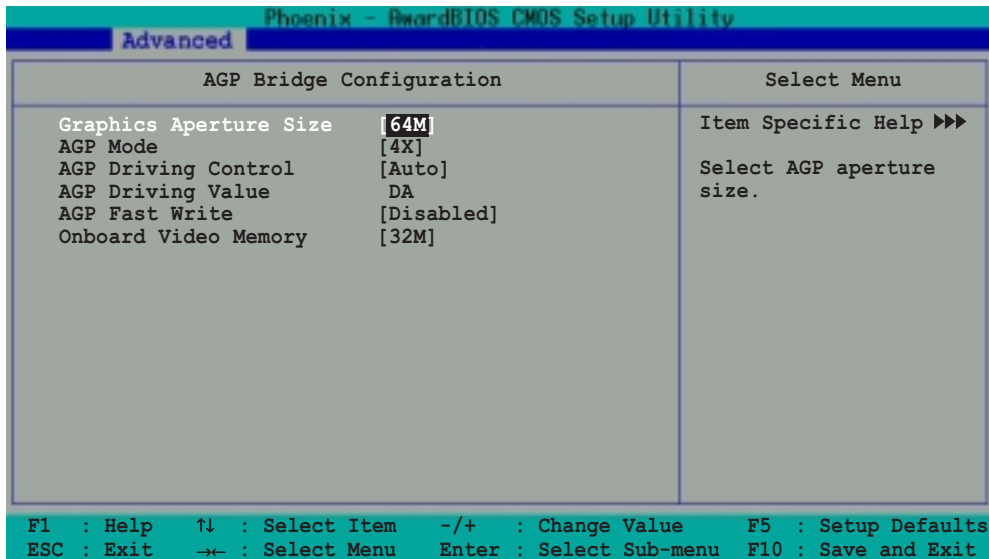

Graphics Aperture Size [64MB]

Sets the size of mapped memory for AGP graphic data. Configuration options: [256M] [128M] [64M] [32M] [16M] [8M] [4M] [1G] [512M]

AGP Mode

Sets the AGP transfer mode. AGP 4X transfers video data at 1066 MB/s and is backward compatible with AGP 1X and 2X AGP cards. When set to [1X], the AGP interface only provides a peak data throughput of 266 MB/s, even if you are using an AGP 4X card. Configuration options: [1X] [2X] [4X]



The AGP Mode automatically adjusts to 8X when you install an AGP 8X card.

AGP Driving Control [Auto]

Allows you to automatically select or manually assign the AGP Driving Value. Configuration options: [Auto] [Manual]

AGP Driving Value [DA]

This item is enabled when you set the AGP Driving Control to [Manual]. Press <Enter> to assign a hexadecimal AGP Driving Value. Configuration options: [Min = 0000, Max = 00FF]

AGP Fast Write [Disabled]

Enables or disables the AGP Fastwrite function. Configuration options: [Disable] [Enabled]

Onboard Video Memory [32M]

Allows you to set the share memory size for the onboard VGA. Configuration options: [16M] [32M] [64M]

2.5.4 PCIPnP

The PCIPnP menu allows you to change the settings for installed PCI devices. Select an item then press <Enter> to display the sub-menu.

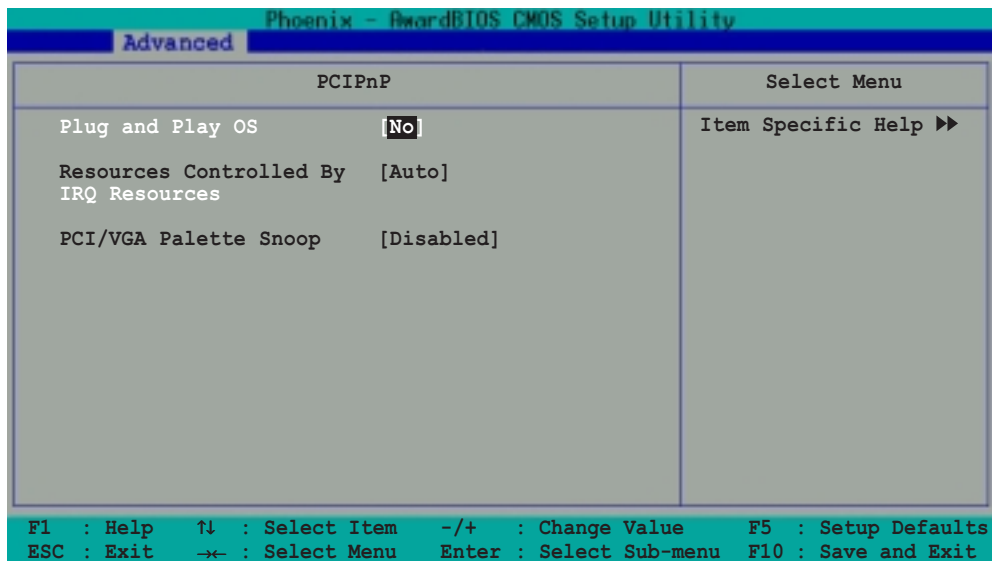

Plug and Play OS [No]

When set to [No], BIOS configures all devices in the system. When set to [Yes], and if you installed a Plug and Play operating system, the operating system configures the Plug and Play devices not required for boot. Configuration options: [No] [Yes]

Resources Controlled by [Auto]

When set to [Auto], BIOS automatically configures all Plug and Play devices. Setting this item to [Manual], allows manual assignment of IRQ addresses to Plug and Play devices using the IRQ Resources sub-menu (Refer to the next item). Configuration options: [Auto] [Manual]

IRQ Resources

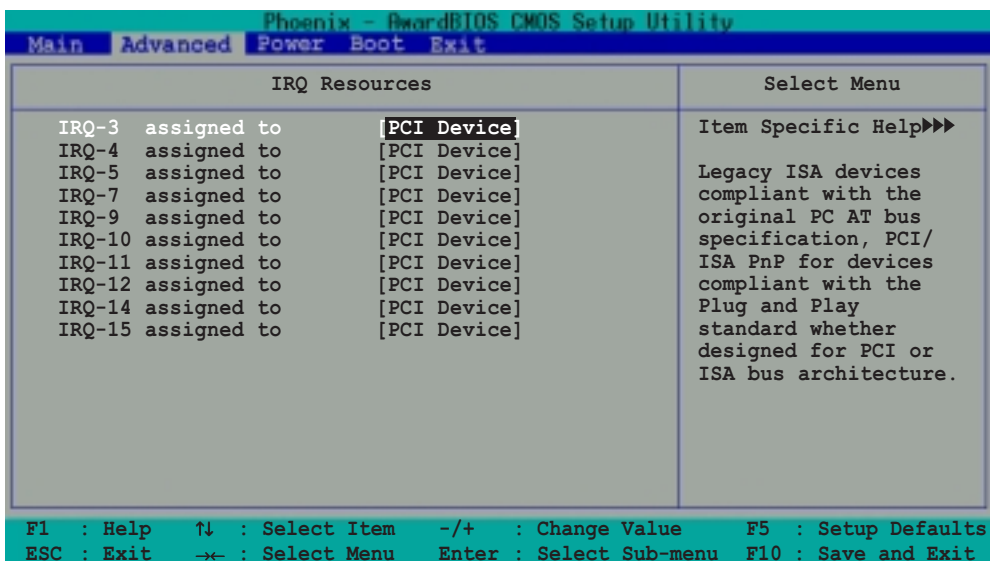

IRQ 3, 4, 5, 7, 9, 10, 11, 12, 14, 15 assigned to

The IRQ Resources sub-menu is activated when the **Resources Controlled by** item is set to [Manual]. Select [PCI Device] to assign an IRQ address to a Plug and Play device. Setting to [Reserved] reserves the IRQ address. Configuration options: [PCI Device] [Reserved]

PCI/VGA Palette Snoop [Disabled]

Some non-standard VGA cards, like graphics accelerators or MPEG video cards, may not show colors properly. Setting this field to [Enabled] corrects this problem. If you are using a standard VGA card, leave this field to the default setting [Disabled]. Configuration options: [Disabled] [Enabled]

2.5.5 Onboard Devices Configuration

The Onboard Devices Configuration menu allows you to adjust the settings for onboard devices. Select an item then press <Enter> to display the sub-menu.

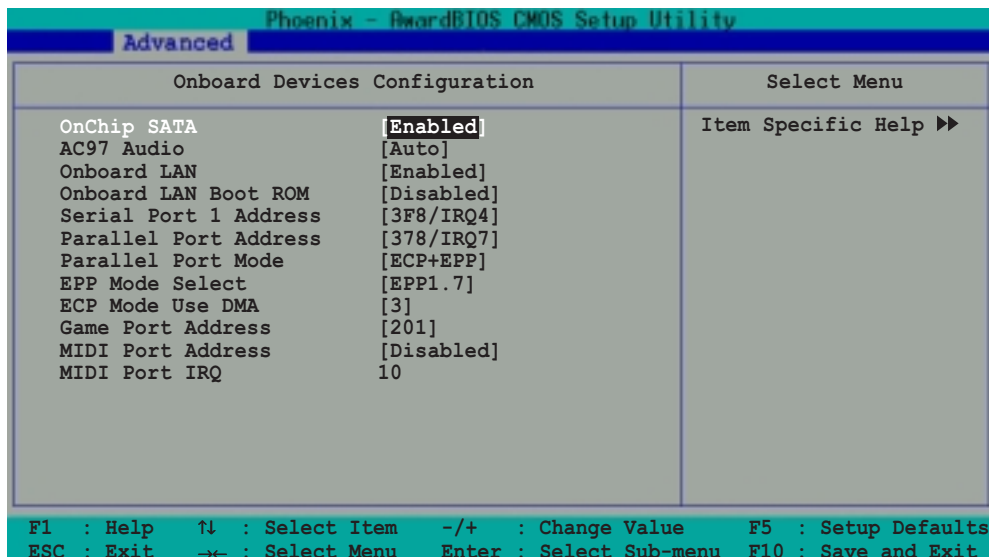

OnChip SATA [Enabled]

Allows you to enable or disable the integrated SATA controller. Configuration options: [Disabled] [Enabled]



Disable the **OnChip SATA** item when installing Windows® 98/Me operating system.

AC97 Audio [Auto]

This field allows you to enable or disable the onboard AC97 audio controller. Configuration options: [Auto] [Disabled]

Onboard LAN [Enabled]

This field allows you to enable or disable the onboard LAN controller. Configuration options: [Enabled] [Disabled]

Onboard LAN Boot ROM [Disabled]

Allows you to turn on or off the onboard LAN boot ROM. This item appears only when onboard LAN is enabled. Configuration options: [Enabled] [Disabled]

Serial Port1 Address [3F8/IRQ4]

Allows you to set the interrupt address of the serial port. Configuration options: [Disabled] [3F8/IRQ4] [2F8/1RQ3] [3E8/IRQ4] [2E8/IRQ3] [Auto]

Parallel Port Address [378/IRQ7]

Set the address of the onboard parallel port connector. Configuration options: [Disabled] [378/IRQ7] [278/IRQ5] [3BC/1RQ7]

Parallel Port Mode [ECP+EPP]

Sets the parallel port operation mode. Setting to [SPP] allows normal speed operation but in one direction only. [EPP] allows bi-directional parallel port operation. [ECP] allows bi-directional DMA mode operation, while [ECP+EPP] allows normal speed operation in a two-way mode. Configuration options: [SPP] [EPP] [ECP] [ECP+EPP]

EPP Mode Select [EPP1.7]

This field sets the EPP mode. The default setting is EPP1.7. This selection is available when you set the Parallel Port Mode to [EPP] or [ECP+EPP]. Configuration options: [EPP1.9] [EPP1.7]

ECP Mode Use DMA [3]

This field sets the parallel port DMA channel for the selected ECP mode. The default setting is 3. This selection is available only if you select [ECP] or [ECP+EPP] in the Parallel Port Mode item. Configuration options: [1] [3]

Game Port Address [201]

This field allows you to select the onboard Game port address. Configuration options: [Disabled] [201] [209]

MIDI Port Address [Disabled]

This field allows you to select the onboard MIDI port address. Configuration options: [Disabled] [330] [300] [290]

MIDI Port IRQ [10]

This field allows you to set the IRQ assignment for the onboard MIDI port. Configuration options: [5] [10]

2.5.6 USB Configuration

The USB Configuration menu allows you to adjust the settings for the onboard USB controllers. Select an item then press <Enter> to display the sub-menu.

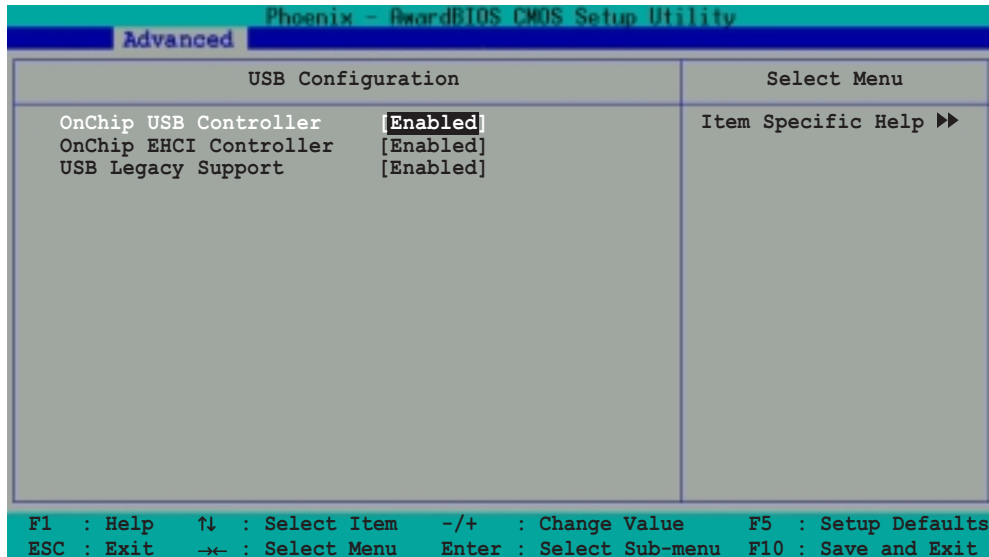

OnChip USB Controller [Enabled]

Allows you to enable or disable the integrated USB controller.
Configuration options: [Enabled] [Disabled]

OnChip EHCI Controller [Enabled]

Allows you to enable or disable the USB EHCI controller.
Configuration options: [Enabled] [Disabled]

USB Legacy Support [Enabled]

Allows you to enable or disable support for legacy USB devices.
Configuration options: [Enabled] [Disabled]

2.6 Power menu

The Power menu items allow you to change the settings for the Advanced Power Management (APM). Select an item, then press <Enter> to display the configuration options.

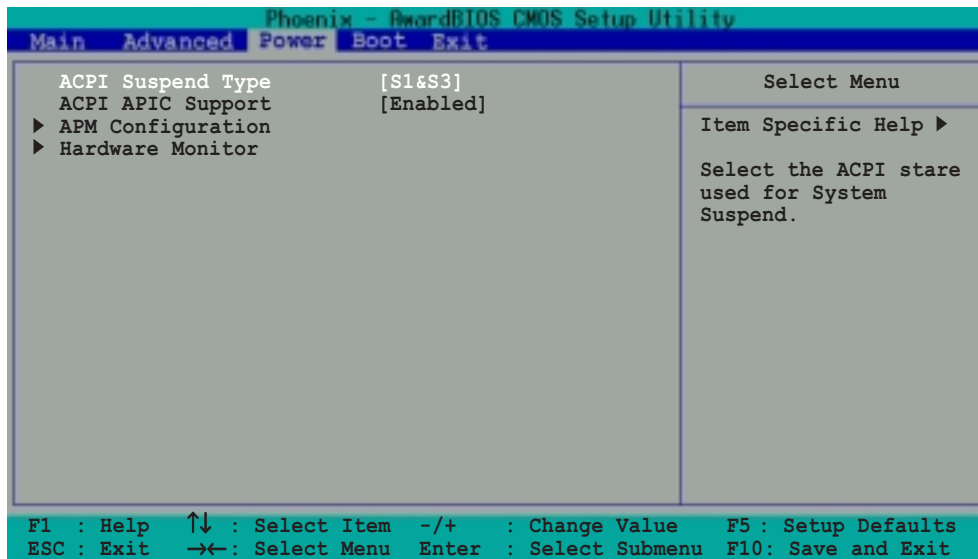

ACPI Suspend Mode [S1&S3]

Allows you to select the ACPI state to used for system suspend.

Configuration options: [S1 (POS)] [S3 (STR)] [S1&S3]

ACPI APIC Support [Enabled]

Allows you to enable or disable the ACPI support in the ASIC. When set to [Enabled], the ACPI APIC table pointer is included in the RSDT pointer list.

Configuration options: [Disabled] [Enabled]

2.6.1 APM Configuration

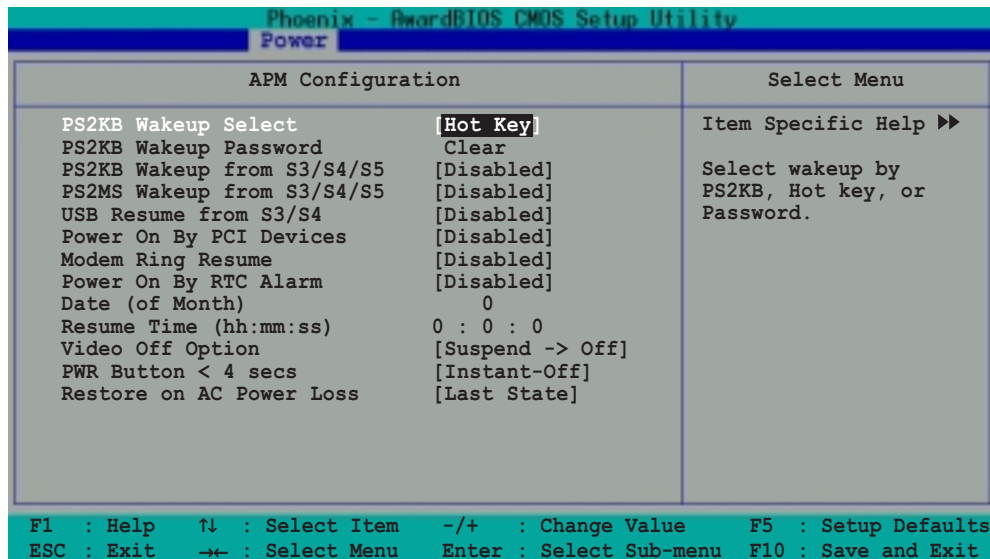

PS2KB Wakeup Select [Hot Key]

Allows you to use specific keys on the keyboard to turn on the system. This feature requires an ATX power supply that provides at least 1 A on the +5VSB lead. Configuration options: [Hot key] [Password]

PS2KB Wakeup Password [Clear]

Appears when you select password as the wakeup method for the PS/2 keyboard. Highlight this item then press <Enter> to enter an 8-digit password. When the password is activated, the system wakes up from a keyboard stroke only after you enter the correct password. To disable the password, highlight this item again, then press <Enter> twice. A PASSWORD DISABLED! message appears indicating that you have successfully disabled the password.



The PS2KB Wakeup from S3/S4/S5 and the PS2MS Wakeup from S3/S4/S5 are not configurable if you set the PS2KB Wakeup Select item to password mode.

PS2KB Wakeup from S3/S4/S5 [Disabled]

When set to [Enabled], this parameter allows you to use the PS/2 keyboard to turn on the system. Configuration options: [Disabled] [Ctrl+F1] [Ctrl+F2] [Ctrl+F3] [Ctrl+F4] [Ctrl+F5] [Ctrl+F6] [Ctrl+F7] [Ctrl+F8] [Ctrl+F9] [Ctrl+F10] [Ctrl+F11] [Ctrl+F12] [Power] [Wake] [Any Key]

PS2MS Wakeup from S3/S4/S5 [Disabled]

When set to [Enabled], this parameter allows you to use the PS/2 mouse to turn on the system. This requires an ATX power supply that provides at least 1A on the +5VSB lead. Configuration options: [Disabled] [Enabled]

USB Resume from S3/S4 [Disabled]

Configuration options: [Disabled] [Enabled]

Power On By PCI Devices [Disabled]

When set to [Enabled], this parameter allows you to turn on the system through a PCI LAN or modem card. This feature requires an ATX power supply that provides at least 1 A on the +5VSB lead.

Configuration options: [Disabled] [Enabled]

Modem Ring Resume [Disabled]

When [Enabled] the computer powers up when the external modem receives a call while the computer is in soft-off mode.

Configuration options: [Disabled] [Enabled]

Power On By RTC Alarm [Disabled]

Allows you to enable or disable RTC to generate a wake event. When this item is enabled, the Date and Resume Time fields are activated for manual setup. Configuration options: [Disabled] [Enabled]

Video Off Option [Suspend -> Off]

Determines when to activate the video off feature for monitor power management. Configuration options: [Always On] [Suspend -> Off]

PWR Button < 4 Sec [Instant-Off]

When set to [Instant-off], the ATX power button can be used as a normal system power-off button when pressed for less than 4 seconds. [Suspend] allows the button to have a dual function where pressing less than 4 seconds puts the system in sleep mode. Regardless of the setting, pressing the ATX power button for more than 4 seconds powers off the system.

Configuration options: [Suspend] [Instant-off]

Restore on AC Power Loss [Last State]

Allows you to set whether or not to power the system after an AC power loss. [Off] leaves your system off, while [On] powers up the system.

Setting to [Last State] puts the system back to the state it was before the AC power interruption. Configuration options: [Last State] [Power On] [Power Off]

2.6.2 Hardware Monitor

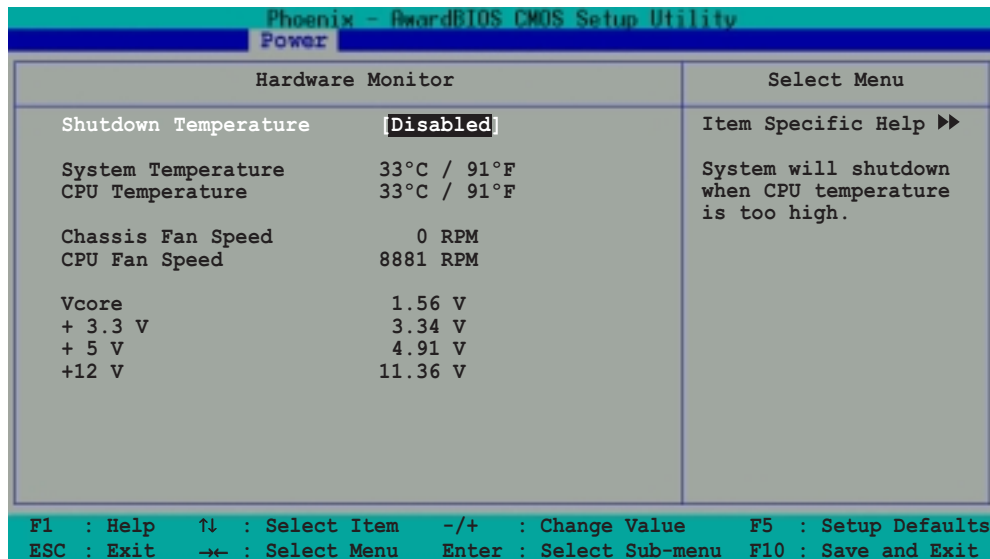

Shutdown Temperature [Disabled]

Allows BIOS to set a threshold value for the CPU temperature. The system shuts down when the CPU temperature reaches the threshold value.

Configuration options: [Disabled] [60°C/140°F] [65°C/149°F] [70°C/158°F] [75°C/167°F]

System Temperature [xxx°C/xxx°F]

CPU Temperature [xxx°C/xxx°F]

The onboard hardware monitor automatically detects and displays the system and CPU temperatures.

Chassis Fan Speed [xxxxRPM] or [ORPM]

CPU Fan Speed [xxxxRPM] or [ORPM]

The onboard hardware monitor automatically detects and displays the CPU and chassis fan speeds in rotations per minute (RPM). If any of the fans is not connected to the motherboard, that field shows ORPM.

Vcore [XX.XX V]

+ 3.3V [XX.XX V]

+ 5 V [XX.XX V]

+ 12 V [XX.XX V]

The onboard hardware monitor automatically detects the voltage output through the onboard voltage regulators.

2.7 Boot menu

The Boot menu items allow you to change the system boot settings. Select a sub-menu, then press <Enter> to display the configuration options.

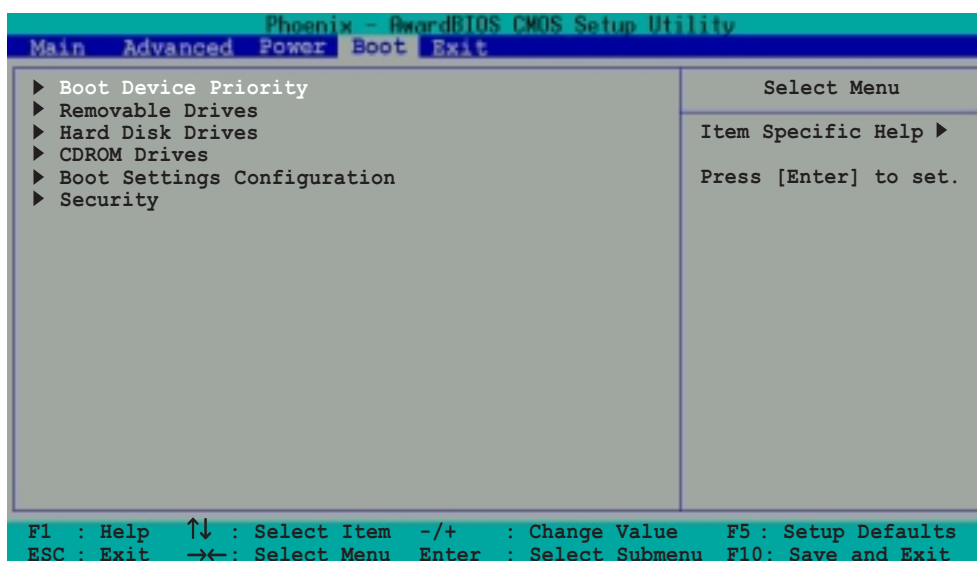

2.7.1 Boot Device Priority

This menu allows you to arrange the boot device priority.

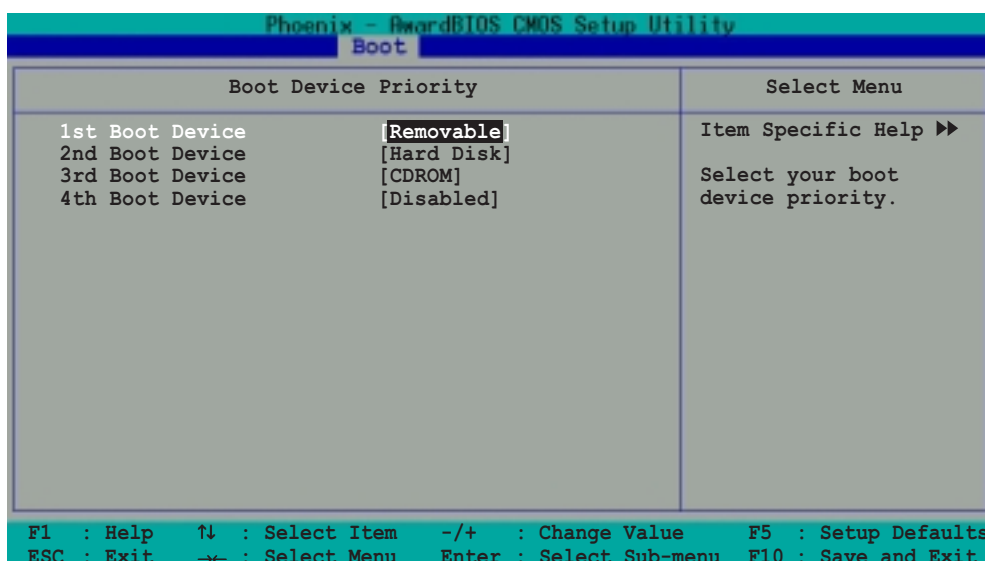

1st~4th Boot Device [Removable]

Allows you to specify the boot device priority sequence from the available devices. The number of device items that appear on the screen depends on the number of devices installed in the system.

Configuration options: [Removable] [Hard Disk] [CDROM] [Legacy LAN] [Disabled]

2.7.2 Removable Drives

This menu allows you to arrange the removable drive sequence. The screen shows the removable drive(s) installed in the system. When more than one removable drives are detected, use the arrow up or down keys to arrange the devices according to your boot priority.

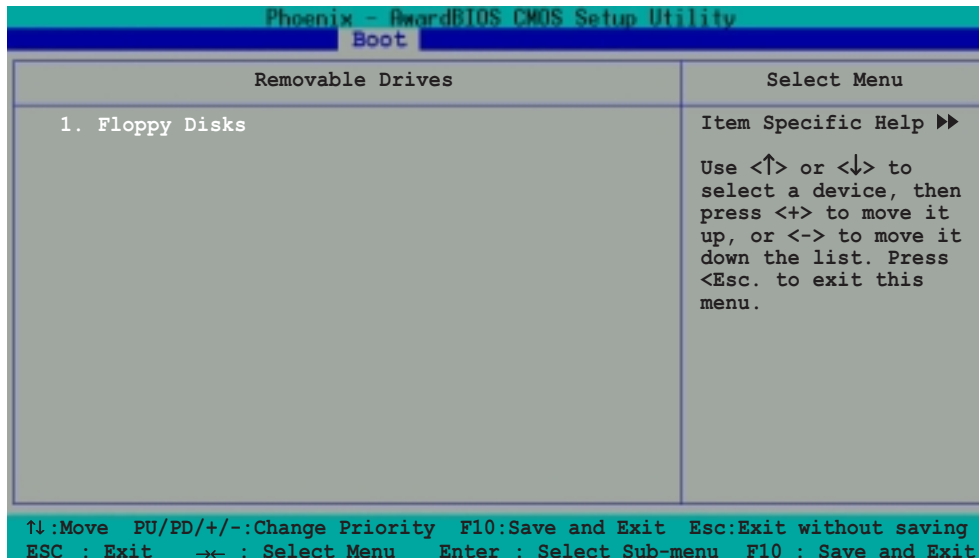

2.7.3 Hard Disk Drives

This menu allows you to arrange the hard disk drive sequence. The screen shows the hard disk drive(s) installed in the system. When more than one hard disk drives are detected, use the arrow up or down keys to arrange the devices according to your boot priority.

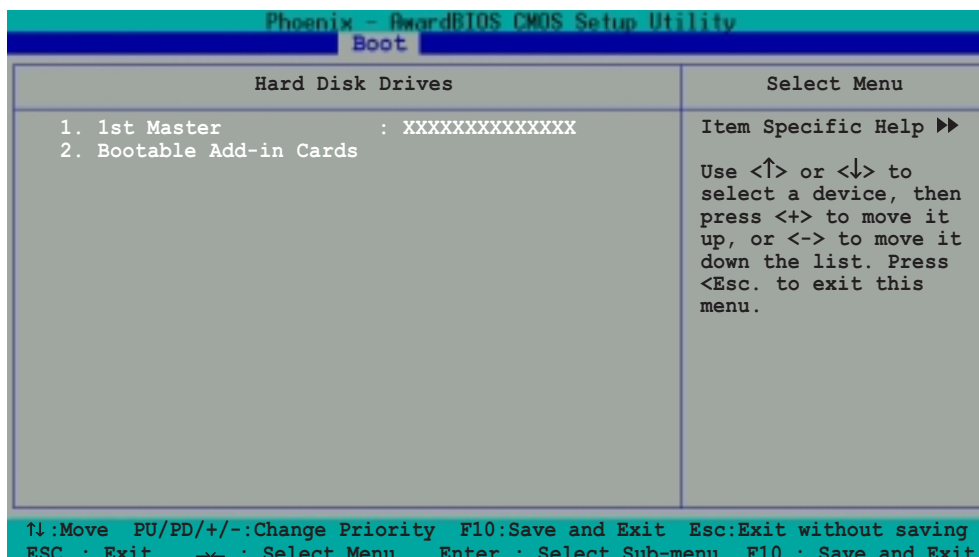

2.7.4 CDROM Drives

This menu allows you to arrange the optical drive sequence. The screen shows the optical drive(s) installed in the system. When more than one optical drives are detected, use the arrow up or down keys to arrange the devices according to your boot priority.

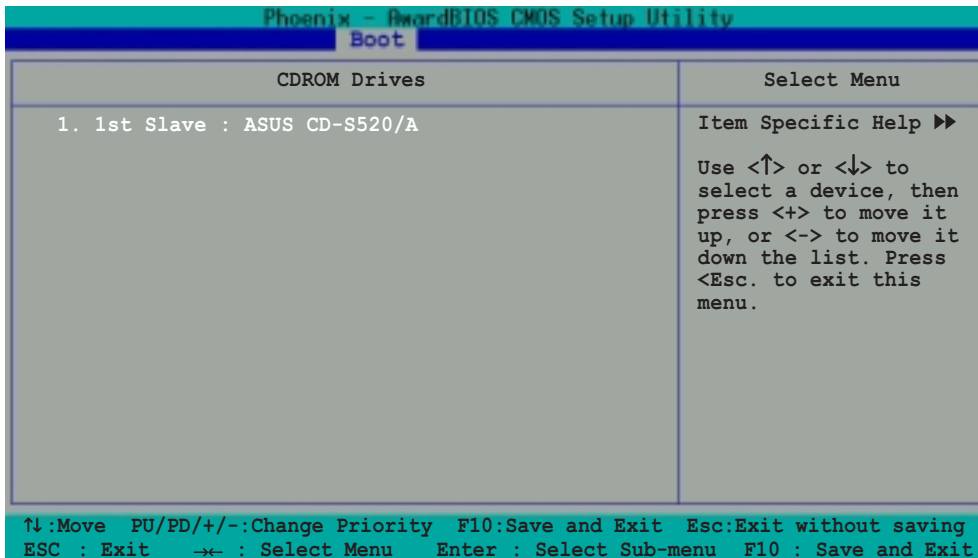

2.7.5 Boot Settings Configuration

This menu allows you to adjust the system boot settings.

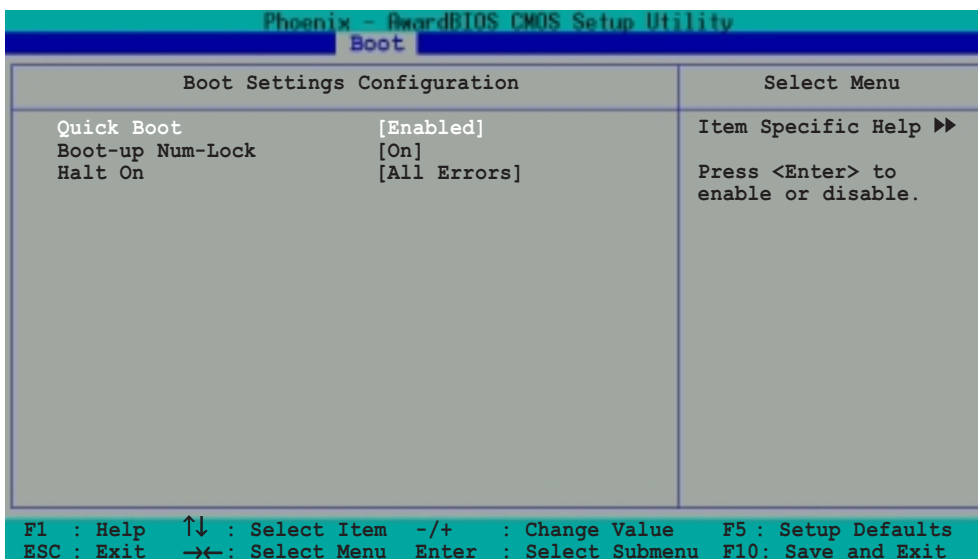

Quick Boot [Enabled]

Allows you to enable or disable the system quick boot feature. When enabled, the system skips certain tests while booting.

Configuration options: [Disabled] [Enabled]

Bootup Num-lock [On]

Allows you to select the power-on state for the keyboard NumLock key.
Configuration options: [Off] [On]

Halt On [All Errors]

Sets the system to halt on errors according to the system functions specified in each option. Configuration options: [All Errors] [No Errors] [All, But Keyboard] [All, But Diskette] [All, But Disk/Key]

2.7.6 Security

This menu allows you to adjust the system security settings.

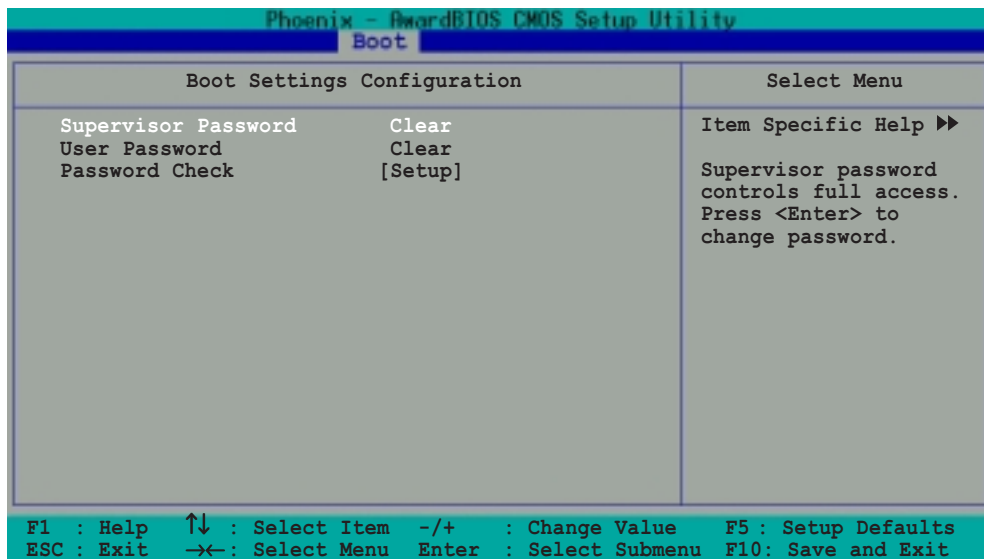

Supervisor Password User Password

Allows you to set the supervisor or user password.

To set a password:

1. Select **Supervisor Password** or **User Password**, then press <Enter>.
2. Enter the password using a combination of eight (8) alpha-numeric characters, then press <Enter>.
3. When prompted, re-type the same password, then press <Enter> to confirm. When the password is activated, the password item value now shows **Set**.

To clear the password:

1. Select either the **Supervisor Password** or **User Password**, then press <Enter> twice. A **Password Disabled!** message appears on screen to indicate that the password has been cleared.
2. Press any key to continue. The password item value now shows **Clear**.

A note about passwords

The BIOS Setup program allows you to specify passwords in the Boot menu. These passwords control access to the BIOS during system startup. The BIOS Setup program allows you to specify two different passwords: a **Supervisor Password** and a **User Password**. If you did not set a Supervisor Password, anyone can access the BIOS Setup. If you did, the Supervisor Password is required before entering the BIOS Setup and gain full access to the configuration fields.

Forgot the password?

If you forget your password, you can clear it by erasing the CMOS Real Time Clock (RTC) RAM. The RAM data containing the password information is powered by the onboard button cell battery. If you need to erase the CMOS RAM, refer to section “1.11 Switch and Jumpers” for instructions.

Password Check [Setup]

Requires users to enter the password before entering the BIOS setup or the operating system. Select [Setup] to require the password before entering the BIOS Setup. Select [System] to require the password before entering the operating system. Configuration options: [Setup] [System]

2.8 Exit menu

The Exit menu items allow you to save or discard your changes to, and/or load the optimal or failsafe default values for the BIOS items.

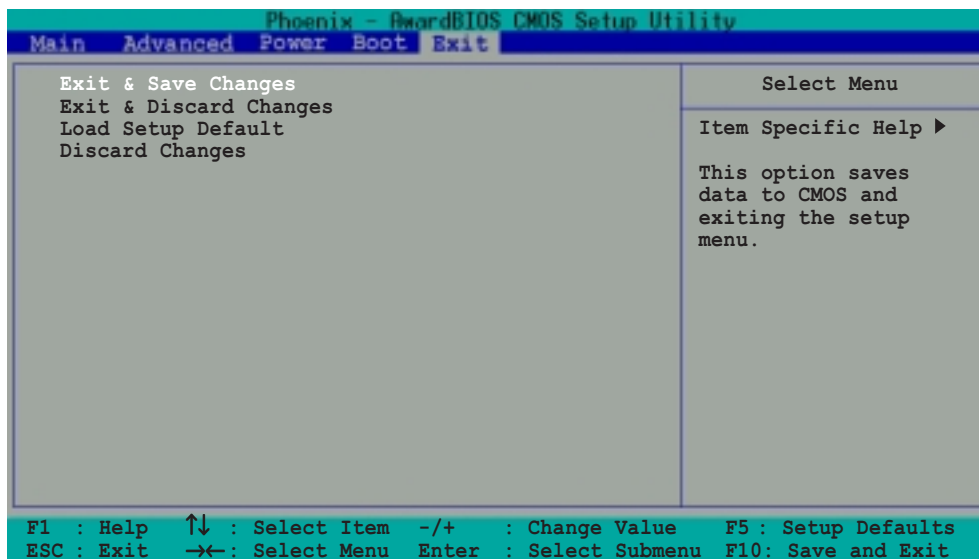

Pressing <Esc> does not immediately exit this menu. Select one of the options from this menu, or press <F10> to exit.

Exit & Save Changes

Once you are finished making your selections, choose this option to ensure the values you selected are saved to the CMOS RAM. An onboard backup battery sustains the CMOS RAM so it stays on even when the system is turned off. When you select this option, a confirmation window appears. Select **Yes** to save changes and exit the BIOS Setup.

Exit & Discard Changes

Select this option only if you do not want to save the changes that you made to the BIOS Setup. If you made changes to fields other than the system date, system time, and password, the BIOS asks for a confirmation before exiting.

Load Setup Defaults

This option allows you to load the default values for each of the parameters on the BIOS Setup menus. When you select this option, or if you press <F5>, a confirmation window appears. Select **Yes** to load the default values. Select **Exit & Save Changes** or make other changes before saving the values to the non-volatile RAM.

Discard Changes

This option allows you to discard the selections you made and restore the previously saved values. After selecting this option, a confirmation appears. Select **Yes** to discard any changes and load the previously saved values.

This chapter describes the contents of the support CD that comes with the motherboard package.

Software support



3.1 Installing an operating system

This motherboard supports Windows® 2000/XP operating systems (OS). Always install the latest OS version and corresponding updates to maximize the features of your hardware.



Motherboard settings and hardware options vary. Use the setup procedures presented in this chapter for reference only. Refer to your OS documentation for detailed information.

3.2 Support CD information

The support CD that came with the motherboard package contains the drivers, software applications, and utilities that you can install to avail all motherboard features.



The contents of the support CD are subject to change at any time without notice. Visit the ASUS website(www.asus.com) for updates.

3.2.1 Running the support CD

Place the support CD to the optical drive. The CD automatically displays the **Drivers** menu if Autorun is enabled in your computer.

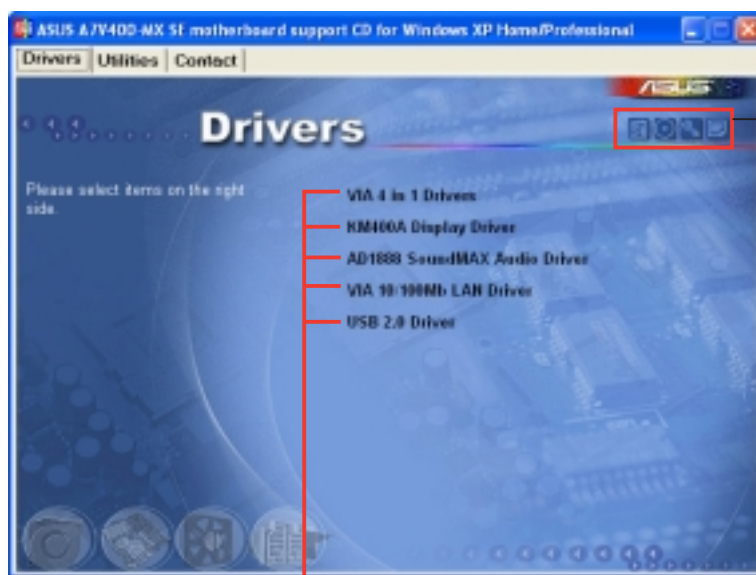

Click an icon to display support CD/motherboard information

Click an item to install



If **Autorun** is NOT enabled in your computer, browse the contents of the support CD to locate the file **ASSETUP.EXE** from the BIN folder. Double-click the **ASSETUP.EXE** to run the CD.

3.2.2 Drivers menu

The drivers menu shows the available device drivers if the system detects installed devices. Install the necessary drivers to activate the devices.

VIA 4 in 1 Drivers

Installs the VIA 4-in-1 drivers.

KM400A Display Driver

Installs the KM400A display driver for the onboard VGA.

ADI SoundMAX Audio Driver

Installs the ADI SoundMAX audio driver and applications.

VIA 10/100Mb LAN Driver

Installs the driver for the VIA 10/100Mb Fast Ethernet controller.

USB 2.0 Driver

Installs the USB 2.0 driver.



The screen display and drivers option may not be the same for different operating system versions.

3.2.3 Utilities menu

The Utilities menu shows the applications and other software that the motherboard supports.



ASUS PC Probe

This smart utility monitors the fan speed, CPU temperature, and system voltages, and alerts you of any detected problems. This utility helps you keep your computer in healthy operating condition.

ASUS Update

The ASUS Update utility allows you to update the motherboard BIOS in a Windows® environment. This utility requires an Internet connection either through a network or an Internet Service Provider (ISP). See pages 2-5 to 2-6 for details.

Anti-Virus Utility

The anti-virus application scans, identifies, and removes computer viruses. View the online help for detailed information.

ADOBE Acrobat Reader

The Adobe Acrobat® Reader V5.0 is for opening, viewing, and printing documents in Portable Document Format (PDF).

ASUS Screen Saver

Bring life to your idle screen by installing the ASUS screen saver.

Microsoft DirectX 9.0c Driver

The Microsoft DirectX® 9.0c is a multimedia technology that enhances computer graphics and sounds. DirectX® improves the multimedia features of your computer so you can enjoy watching TV and movies, capturing videos, or playing games in your computer.

3.2.4 Contacts menu

Click the **Contact** tab to display the ASUS contact information. You can also find this information on the inside front cover of this user guide.



Free Manuals Download Website

<http://myh66.com>

<http://usermanuals.us>

<http://www.somanuals.com>

<http://www.4manuals.cc>

<http://www.manual-lib.com>

<http://www.404manual.com>

<http://www.luxmanual.com>

<http://aubethermostatmanual.com>

Golf course search by state

<http://golfingnear.com>

Email search by domain

<http://emailbydomain.com>

Auto manuals search

<http://auto.somanuals.com>

TV manuals search

<http://tv.somanuals.com>