

ASUS® A7M266-D

Dual Socket A Motherboard

USER'S MANUAL

USER'S NOTICE

No part of this manual, including the products and software described in it, may be reproduced, transmitted, transcribed, stored in a retrieval system, or translated into any language in any form or by any means, except documentation kept by the purchaser for backup purposes, without the express written permission of ASUSTeK COMPUTER INC. ("ASUS").

ASUS PROVIDES THIS MANUAL "AS IS" WITHOUT WARRANTY OF ANY KIND, EITHER EXPRESS OR IMPLIED, INCLUDING BUT NOT LIMITED TO THE IMPLIED WARRANTIES OR CONDITIONS OF MERCHANTABILITY OR FITNESS FOR A PARTICULAR PURPOSE. IN NO EVENT SHALL ASUS, ITS DIRECTORS, OFFICERS, EMPLOYEES OR AGENTS BE LIABLE FOR ANY INDIRECT, SPECIAL, INCIDENTAL, OR CONSEQUENTIAL DAMAGES (INCLUDING DAMAGES FOR LOSS OF PROFITS, LOSS OF BUSINESS, LOSS OF USE OR DATA, INTERRUPTION OF BUSINESS AND THE LIKE), EVEN IF ASUS HAS BEEN ADVISED OF THE POSSIBILITY OF SUCH DAMAGES ARISING FROM ANY DEFECT OR ERROR IN THIS MANUAL OR PRODUCT.

Product warranty or service will not be extended if: (1) the product is repaired, modified or altered, unless such repair, modification or alteration is authorized in writing by ASUS; or (2) the serial number of the product is defaced or missing.

Products and corporate names appearing in this manual may or may not be registered trademarks or copyrights of their respective companies, and are used only for identification or explanation and to the owners' benefit, without intent to infringe.

- AMD, Athlon™ are trademarks of Advanced Micro Devices, Inc.
- VIA is a trademark of VIA Technologies, Inc.
- Windows and MS-DOS are registered trademarks of Microsoft Corporation.
- Adobe and Acrobat are registered trademarks of Adobe Systems Incorporated.
- Trend and ChipAwayVirus are trademarks of Trend Micro, Inc.
- Other company and product names may be trademarks or registered trademarks of the respective companies with which they are associated.

The product name and revision number are both printed on the product itself. Manual revisions are released for each product design represented by the digit before and after the period of the manual revision number. Manual updates are represented by the third digit in the manual revision number.

For previous or updated manuals, BIOS, drivers, or product release information, contact ASUS at <http://www.asus.com.tw> or through any of the means indicated on the following page.

SPECIFICATIONS AND INFORMATION CONTAINED IN THIS MANUAL ARE FURNISHED FOR INFORMATIONAL USE ONLY, AND ARE SUBJECT TO CHANGE AT ANY TIME WITHOUT NOTICE, AND SHOULD NOT BE CONSTRUED AS A COMMITMENT BY ASUS. ASUS ASSUMES NO RESPONSIBILITY OR LIABILITY FOR ANY ERRORS OR INACCURACIES THAT MAY APPEAR IN THIS MANUAL, INCLUDING THE PRODUCTS AND SOFTWARE DESCRIBED IN IT.

Copyright © 2001 ASUSTeK COMPUTER INC. All Rights Reserved.

Product Name: **ASUS A7M266-D**
Manual Revision: **1.03 E1026**
Release Date: **May 2002**

ASUS CONTACT INFORMATION

ASUSTeK COMPUTER INC. (Asia-Pacific)

Marketing

Address: 150 Li-Te Road, Peitou, Taipei, Taiwan 112
Telephone: +886-2-2894-3447
Fax: +886-2-2894-3449
Email: info@asus.com.tw

Technical Support

MB/Others (Tel): +886-2-2890-7121 (English)
Notebook (Tel): +886-2-2890-7122 (English)
Desktop/Server (Tel): +886-2-2890-7123 (English)
Fax: +886-2-2980-7698
Email: tsd@asus.com.tw
WWW: www.asus.com.tw
Newsgroup: csnews.asus.com.tw

ASUS COMPUTER INTERNATIONAL (America)

Marketing

Address: 6737 Mowry Avenue, Mowry Business Center, Building 2
Newark, CA 94560, USA
Fax: +1-510-608-4555
Email: tmd1@asus.com

Technical Support

Fax: +1-510-608-4555
Support: +1-502-995-0883
Notebook Support: +1-877-918-ASUS (2787)
Email: tsd@asus.com
WWW: www.asus.com

ASUS COMPUTER GmbH (Europe)

Marketing

Address: Harkortstr. 25, 40880 Ratingen, BRD, Germany
Fax: +49-2102-442066
Email: sales@asuscom.de (for marketing requests only)

Technical Support

Hotline: MB/Others: +49-2102-9599-0 Notebook: +49-2102-9599-10
Fax: +49-2102-9599-11
Support (Email): www.asuscom.de/de/support (for online support)
WWW: www.asuscom.de

CONTENTS

1. INTRODUCTION	7
1.1 How This Manual Is Organized	7
1.2 Item Checklist	7
2. FEATURES	8
2.1 The ASUS A7M266-D	8
2.1.1 Core Specifications	8
2.1.2 Connections	9
2.1.3 Performance and Intelligence	10
2.1.4 Specifications – Optional Components	11
2.2 Motherboard Components	12
2.2.1 Component Locations	13
3. HARDWARE SETUP	14
3.1 Motherboard Layout	14
3.2 Layout Contents	15
3.3 Getting Started	16
3.4 Motherboard Settings	16
3.5 System Memory (DDR DIMM)	21
3.5.1 Memory Installation	22
3.5.2 General DIMM Memo	22
3.6 Central Processing Unit (CPU)	23
3.7 Expansion Cards	24
3.7.1 Expansion Card Installation Procedure	24
3.7.2 Assigning IRQs for Expansion Cards	25
3.7.3 Accelerated Graphics Port Pro (AGP Pro)	26
3.8 External Connectors	27
3.9 Starting Up the First Time	39
4. BIOS SETUP	41
4.1 Managing and Updating Your BIOS	41
4.1.1 Upon First Use of the Computer System	41
4.1.2 Updating BIOS Procedures	42
4.2 BIOS Setup Program	45
4.2.1 BIOS Menu Bar	46
4.2.2 Legend Bar	46
4.3 Main Menu	48
4.3.1 Primary & Secondary Master/Slave	49

CONTENTS

4.3.2 Keyboard Features	52
4.4 Advanced Menu	54
4.4.1 Chip Configuration	57
4.4.2 I/O Device Configuration	59
4.4.3 PCI Configuration	60
4.4.4 Shadow Configuration	64
4.5 Power Menu	65
4.5.1 Power Up Control	67
4.5.2 Hardware Monitor	69
4.6 Boot Menu	70
4.7 Exit Menu	72
5. SOFTWARE SETUP	75
5.1 Install Operating System	75
5.2 Start Windows	75
5.3 A7M266-D Series Support CD	75
6. SOFTWARE REFERENCE	77
6.1 ASUS PC Probe	77
6.2 CyberLink PowerPlayer SE	83
6.3 CyberLink VideoLive Mail	83
6.4 ASUS Live Update	85
6.5 Multi-Channel Audio Feature Setup	86
6.6 3Deep Color Tuner	88
7. APPENDIX	91
7.1 Qualified Vendors List	91
7.2 Glossary	93
INDEX	97

FCC & DOC COMPLIANCE

Federal Communications Commission Statement

This device complies with FCC Rules Part 15. Operation is subject to the following two conditions:

- This device may not cause harmful interference, and
- This device must accept any interference received, including interference that may cause undesired operation.

This equipment has been tested and found to comply with the limits for a Class B digital device, pursuant to Part 15 of the FCC Rules. These limits are designed to provide reasonable protection against harmful interference in a residential installation. This equipment generates, uses and can radiate radio frequency energy and, if not installed and used in accordance with manufacturer's instructions, may cause harmful interference to radio communications. However, there is no guarantee that interference will not occur in a particular installation. If this equipment does cause harmful interference to radio or television reception, which can be determined by turning the equipment off and on, the user is encouraged to try to correct the interference by one or more of the following measures:

- Re-orient or relocate the receiving antenna.
- Increase the separation between the equipment and receiver.
- Connect the equipment to an outlet on a circuit different from that to which the receiver is connected.
- Consult the dealer or an experienced radio/TV technician for help.

WARNING! Any changes or modifications to this product not expressly approved by the manufacturer could void any assurances of safety or performance and could result in violation of Part 15 of the FCC Rules.

Reprinted from the Code of Federal Regulations #47, part 15.193, 1993. Washington DC: Office of the Federal Register, National Archives and Records Administration, U.S. Government Printing Office.

Canadian Department of Communications Statement

This digital apparatus does not exceed the Class B limits for radio noise emissions from digital apparatus set out in the Radio Interference Regulations of the Canadian Department of Communications.

This Class B digital apparatus complies with Canadian ICES-003.

Cet appareil numérique de la classe B est conforme à la norme NMB-003 du Canada.

1. INTRODUCTION

1.1 How This Manual Is Organized

This manual is divided into the following sections:

- | | |
|-----------------------|--|
| 1. INTRODUCTION | Manual information and checklist |
| 2. FEATURES | Production information and specifications |
| 3. HARDWARE SETUP | Instructions on setting up the motherboard. |
| 4. BIOS SETUP | Instructions on setting up the BIOS |
| 5. SOFTWARE SETUP | Instructions on setting up the included software |
| 6. SOFTWARE REFERENCE | Reference material for the included software |
| 7. APPENDIX | Optional items and general reference |

1.2 Item Checklist

Check that your package is complete. If you discover damaged or missing items, contact your retailer.

Package Contents

- (1) ASUS Motherboard
- (1) 40-pin 80-conductor ribbon cable for internal UltraDMA/100 / UltraDMA/66 (also compatible with UltraDMA/33 IDE drives/devices)
- (1) Ribbon cable for internal UltraDMA/33 IDE drives
- (1) Ribbon cable for one 5.25" and two 3.5" floppy disk drives
- (1) ASUS 2-port USB Connector Set
- (1) Bag of spare jumper caps
- (1) ASUS Support CD with drivers and utilities
- (1) This Motherboard User's Manual
- (1) ASUS PCI-USB2 Card

Optional Items

- ASUS CIDB chassis intrusion detection module
- ASUS IrDA-compliant infrared module
- ASUS iPanel

NOTE: Before setting up the system components, refer to **Appendix 7.1** for a Qualified Vendor's list. All the components on the list have been tested and are compatible with the A7M266-D motherboard.

2. FEATURES

2.1 The ASUS A7M266-D

The ASUS A7M266-D motherboard is carefully designed for the value-conscious PC user who needs an entry-level server with the most advanced features processed by the fastest available processors.

2.1.1 Core Specifications

- **Dual AMD Athlon™ MP Duron™ MP Processor Support:** Features the latest AMDs, 1.6 GHz and higher.
- **North Bridge System Chipset:** AMD-762™ chipset with AGP / primary 64 bit PCI / Memory controller supports a 266MHz Front Side Bus (FSB), supports DDR SDRAM DIMM, complies with AGP 2.0 specifications for 4X, 2X and 1X AGP modes and PCI 2.2. bus interface with support for two 66MHz PCI masters. It is optimized to deliver enhanced performance with the new AMD Athlon MP™.
- **South Bridge System Chipset:** AMD-768™ PCI set with a secondary PCI bridge using a 33MHz, 32-bit interface, PCI 2.2 compliant; PCI Super-I/O Integrated Peripheral Controller (PSIPC) with support for UltraDMA/100, which allows burst mode data transfer rates of up to 100MB/sec; USB 1.1 controller with root hub and four function ports.
- **PC2100 / PC1600 DDR SDRAM Support:** Equipped with four Double Data Rate Dual Inline Memory Module (DDR DIMM) sockets to support up to 3.5GB of registered DDR SDRAM, or up to 2GB of unbuffered. DDR SDRAM supplies the highest bandwidth and offers the lowest latency currently available, improving the memory system's ability to service multimedia requirements.
- **UltraDMA/100 Support:** Comes with an onboard PCI Bus Master IDE controller with two connectors that support four IDE devices on two channels. Supports UltraDMA/100, UltraDMA/66, UltraDMA/33, PIO Modes 3 & 4 and Bus Master IDE DMA Mode 2, and Enhanced IDE devices, such as DVD-ROM, CD-ROM, CD-R/RW, LS-120, and Tape Backup drives.
- **Super Multi-I/O:** The multi-I/O chipset offers complete support for a variety of I/O functions. Provides two high-speed UART compatible serial ports and one parallel port with EPP and ECP capabilities. UART2 can also be directed from COM2 to the Infrared Module for wireless connections. The Super I/O controller also supports a floppy disk drive, PS/2 keyboard, and PS/2 mouse.
- **Smart BIOS:** 2Mb firmware enables CPU/DDR SDRAM frequency adjustments, boot block write protection, and HD/SCSI/MO/ZIP/CD/Floppy boot selection.

2. FEATURES

2.1.2 Connections

- **Two CPU Sockets:** Socket A (462) for **dual** AMD Athlon™ MP / Duron™ MP processors.
- **PCI Expansion Slots:** Provides five Legacy Free PCI slots: *three* PCI-32bit/33MHz and *two* PCI-64bit/66MHz, (PCI 2.2 compliant. With no ISA, bottlenecks and system memory management issues are eliminated. All PCI slots can support Bus Master PCI cards, such as SCSI or LAN cards. (PCI supports up to 133MB/s maximum throughput.) The MB supports Concurrent PCI, which allows multiple PCI transfers from PCI master bus to the memory and processor.
- **IDE Connectors:** Dual-channel bus master IDE connectors support up to four Ultra DMA/100/66, PIO Modes 3 & 4 IDE devices like two HDDs, one DVD and an R/W CD.
- **AGP Pro Slot:** Comes with an Accelerated Graphics Port Pro slot that supports AGP cards for high performance, component level interconnect targeted at 3D graphical applications using a 4X mode bus.
- **Floppy Disk Connector:** Supports the floppy disk drive.
- **USB Ports:** Two Universal Serial Bus (USB) ports and one header for two more ports are available for connecting USB devices: mice, PDAs and scanners.
- **Serial Ports:** Two 9-pin COM1/COM2 ports are for all serial devices.
- **IrDA:** Supports an optional infrared port module for a wireless interface.
- **Parallel Port:** 25-pin port connects a parallel printer or other devices.
- **PS/2 mouse Port:** Green 6-pin connector is for a PS/2 mouse.
- **PS/2 keyboard Port:** Purple 6-pin connector is for a PS/2 keyboard.
- **Microphone jack:** Pink jack connects a microphone. In 6-channel mode, the function of this jack enables Bass/Center audio output.
- **Line In jack:** Light blue jack connects a tape player or other audio sources. In 6-channel mode, this jack enables rear speaker audio output.
- **Line Out jack:** Lime jack connects a headphone or speakers. In 6-channel mode, this jack enables front speaker audio output.
- **Three power Connectors:** Standard ATX power supply: +5V/3.3V-180W; the power supply must put out at least 1 Amp on the +5V standby lead (+5VSB); ATX 12V/15 Amp power; and one auxiliary power connector.

2. FEATURES

2.1.3 Performance and Intelligence

- **DDR SDRAM Optimized Performance:** This motherboard supports Double Data Rate (DDR) Dynamic Random Access Memory (DDR SDRAM). This new memory technology increases performance by executing two actions per clock cycle, resulting in data transfer rates of up to 2.1 GB/s for 266MHz DDR SDRAM and 1.6GB/s for 200MHz DDR SDRAM.
- **Onboard Audio:** Audio models come with the six-channel C-Media CMI8738 PCI audio controller that supplies HRTF 3D positional audio functions. A software package helps setup the multi-channel PC sound system.
- **PCI USB2 Card:** One 4-port USB PCI card is bundled with the A7M266-D.
- **ACPI Ready:** Advanced Configuration Power Interface (ACPI) provides more Energy Saving Features for operating systems that support OS Direct Power Management (OSPM) functionality. With these features employed in the OS, PCs can be ready around the clock but comply with energy saving standards. To fully utilize the ACPI benefits, use an ACPI-supported OS such as Windows 98.
- **Onboard LED:** A *green* LED lights up to indicate that power is available on-board. It reminds users that standby power is available. The LED also serves as a reminder to disconnect the power supply when making any change to the configuration.
- **Remote Ring-On (requires modem):** This allows a computer to be turned on remotely through an internal or external modem. With this benefit on-hand, users can access vital information from their computers anywhere.
- **SMBus:** Features the System Management Bus interface used to physically transport commands and information between SMBus devices.
- **Desktop Management Interface (DMI):** Supports DMI through BIOS that allows hardware to communicate within a standard protocol and create a higher level of compatibility. (Requires DMI-enabled components.)
- **ASUS C.O.P. (CPU Overheating Protection):** With AMD® Athlon™ MP / XP processors installed, the motherboard offers users ASUS C.O.P. automatic CPU Overheating Protection to prolong the life of the entire system. If the CPU temperature becomes excessive, the PC shuts down automatically.

2. FEATURES

- **Auto Fan Off:** The system fans powers off automatically even in sleep mode. This function reduces both energy consumption and system noise, and is an important feature in implementing silent PC systems. Note: the user must change the default setting in BIOS to take advantage of this feature.
- **Enhanced ACPI and Anti-Boot Virus Protection:** Programmable BIOS (Flash EEPROM) that offers enhanced ACPI for Windows 98/2000/ME compatibility, built-in firmware-based virus protection, and autodetection of most devices for a virtual automatic setup.
- **Chassis Intrusion Detection:** Supports chassis-intrusion monitoring through the ASUS ASIC. A chassis intrusion event is kept in memory on battery power for more protection.
- **Easy Connectivity and System Information Access:** Supports an optional ASUS iPanel, an easy-to-access box with system diagnostic display area, system status LEDs, USB ports, and hot keys. The AFPANEL connector on the motherboard accommodates the ASUS iPanel.
- **PC Health Monitoring:** Provides an easy way to test and manage system status information, such as CPU and system voltages, temperatures, and fan status through the onboard hardware ASUS ASIC and the bundled ASUS PC Probe.
- **Dual Function Power Button:** Pushing the power button for less than 4 seconds when the system is in the working state places the system into one of two states: sleep mode or soft-off mode, depending on the BIOS or OS setting (*See PWR Button < 4 Secs in 4.5 Power Menu*). When the power button is pressed for more than 4 seconds, the system enters the soft-off mode regardless of the BIOS setting.

2. FEATURES

2.2 Motherboard Components

See opposite page for locations.

	Location
Processor Support	
Dual Socket A (462) for AMD Athlon MP™/Duron MP™	4
DSW switches	8
Chipsets	
AMD 762 System Controller	5
AMD 768 PCI Set	11
2Mbit Programmable Flash EEPROM	15
LPC Multi-IO Controller Chipset	16
Main Memory	
Maximum 3.5GB Support	
4 DIMM Sockets	6
PC2100 / PC1600 DDR memory support	
Expansion Slots	
2 64/32bit 66/33MHz PCI Slots	19
3 32bit 33MHz PCI Slots	13
1 Accelerated Graphics Port (AGP) Pro Slot	20
System I/O	
1 Floppy Disk Drive Connector	7
2 IDE Connectors (UltraDMA/100 Support)	10
1 Front Audio Panel Connector	14
1 Parallel Port Connector	(Top) 25
1 Serial COM1 Port Connector	(Bottom) 26
1 Serial COM2 Port Connector	(Bottom) 24
USB Connectors (Port 0 & Port 1)	27
USB Headers (Port 2 & Port 3)	12
1 PS/2 Mouse Connector	(Top) 28
1 PS/2 Keyboard Connector	(Bottom) 28
Audio	
PCI 6-Channel Audio Controller (<i>optional</i>)	18
1 Line Out Connector (<i>audio model only</i>)	(Lime) 23
1 Line In Connector (<i>audio model only</i>)	(Light blue) 22
1 Microphone Connector (<i>audio model only</i>)	(Pink) 21
Network Features	
Hardware Monitoring	
ASUS ASIC	9
Power	
Auxillary Power Connector	1
12V ATX Power Supply Connector	2
ATX Power Supply Connector	3
Special Feature	
Onboard LED	17
Form Factor	
ATX	

2. FEATURES

2.2.1 Component Locations

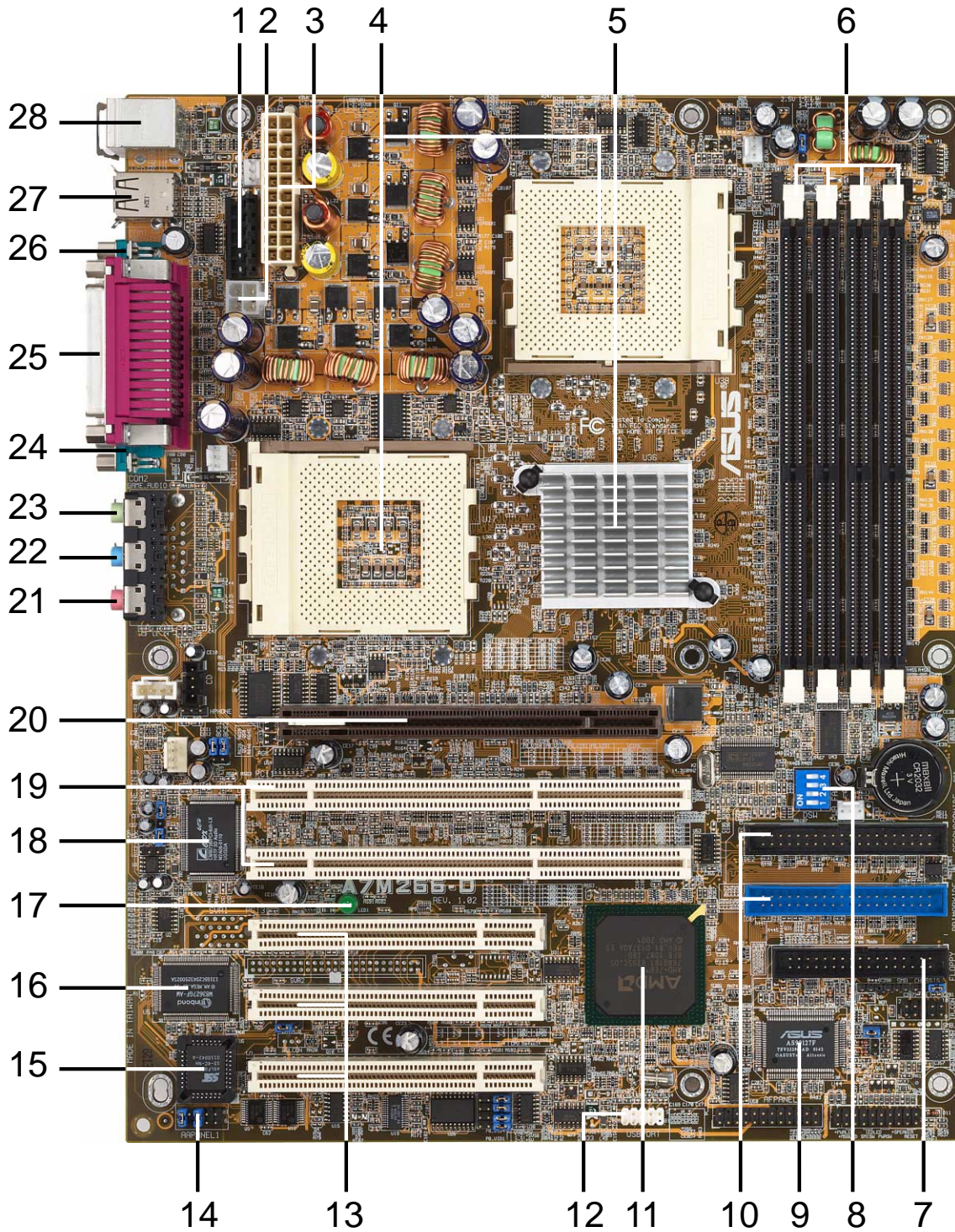

2. FEATURES
Motherboard Parts

3. HARDWARE SETUP

3.1 Motherboard Layout

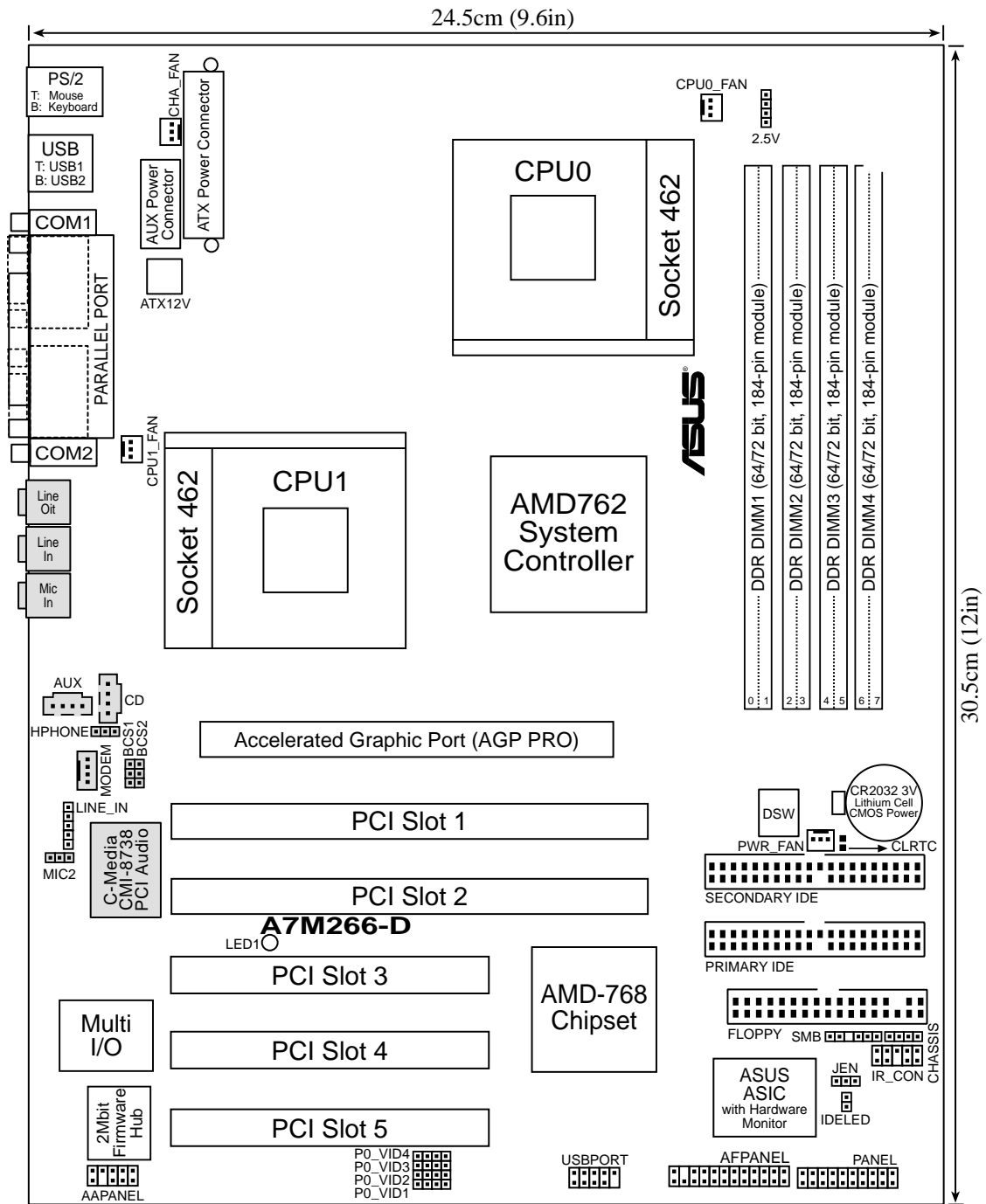

Grayed components are available only on certain models at the time of purchase.

3. HARDWARE SETUP

3.2 Layout Contents

Motherboard Settings

- | | |
|--------------|--|
| 1) JEN | p. 17 JumperFree Mode (JumperFree / Jumper Mode) |
| 2) VDDR | p. 18 DDR Memory Voltage Setting (2.5 / 2.6 / 2.7) |
| 3) BCS1/2 | p. 18 Bass Center Setting (CENTER/BASS, BASS/CENTER) |
| 4) DSW 1-4 | p. 19 CPU External Frequency Setting (Switches 1-4) |
| 6) PO_VID1-4 | p. 20 CPU Voltage Regulator Output Setting |

Expansion Slots/Sockets

- | | |
|--------------------------|---|
| 1) DDR System Memory | p. 21 System Memory Support |
| 2) DIMM1/2/3/4 | p. 22 DDR DIMM Memory Installation |
| 3) Socket 462 (Socket A) | p. 23 CPU Support |
| 4) PCI1/2/3/4/5 | p. 24 Two 64-bit and three 32-bit PCI Bus Expansion Slots |
| 5) AGP PRO | p. 26 Accelerated Graphics Port (AGP) Pro |

Connectors

- | | |
|------------------------------|---|
| 1) PS2KBMS | p. 27 PS/2 Mouse Port Connector (6 pin female) |
| 2) PS2KBMS | p. 27 PS/2 Keyboard Port Connector (6 pin female) |
| 3) USB | p. 28 Universal Serial Bus Connectors 0 & 1 (Two 4 pin female) |
| 4) COM1/COM2 | p. 28 Serial Port Connector (9 pin male) |
| 5) PRINTER | p. 28 Parallel Port Connector (25 pin female) |
| 6) Line_In, Line_Out, Mic | p. 29 Audio Port Connectors (Three 1/8") (optional) |
| 7) FLOPPY | p. 29 Floppy Disk Drive Connector (34 pins) |
| 8) PRIM. / SECOND. IDE | p. 30 IDE Connectors (Two 40-1 pins) |
| 9) CHASSIS | p. 31 Chassis Intrusion Lead (4-1 pins) |
| 10) IR_CON | p. 31 Infrared Module Connector (5 pins) |
| 11) CHA, PWR, CPU0, CPU1_FAN | p. 32 Chassis, Power Supply, CPU0 & 1 Fan Connectors (3 pins) |
| 12) USBPORT | p. 33 USB Header (10-1 pins) |
| 13) SMB | p. 33 SMBus Connector (5-1 pins) |
| 14) AFPANEL | p. 34 ASUS iPanel Connector (24-1 pins) |
| 15) MIC2 | p. 34 Internal Microphone Connector (3-pin) |
| 16) HPHONE | p. 35 Headphone True-level Line Out Header (3-pin) |
| 17) LINE_IN | p. 35 Audio Input Line In Header (5-pin) (optional) |
| 18) AAPANEL | p. 35 ASUS iPanel Audio Connector (10-1 pin) (optional) |
| 19) IDELED | p. 36 IDE Activity LED (2 pins) |
| 20) ATXPWR | p. 37 ATX Power Supply Connectors (20 pin block ATXPWR, 12 pin EAUXPWR, 4 pin ATX12V) |
| 21) PWR.LED (PANEL) | p. 38 System Power LED Lead (3 pins) |
| 22) KEYLOCK (PANEL) | p. 38 Keylock Lock Switch Lead (2-pin) |
| 23) SPEAKER (PANEL) | p. 38 System Warning Speaker Connector (4 pins) |
| 24) MSGLED (PANEL) | p. 38 System Message LED (2 pins) |
| 25) SMISW (PANEL) | p. 38 System Management Interrupt Lead (2 pins) |
| 26) PWRSW (PANEL) | p. 38 ATX / Soft-Off Switch Lead (2 pins) |
| 27) RESET (PANEL) | p. 38 Reset Switch Lead (2 pins) |

3. HARDWARE SETUP

3.3 Getting Started

Before using your computer, you must complete the following steps:

1. Check Motherboard Settings
2. Install Memory Modules
3. Install the Central Processing Unit (CPU)
4. Install Expansion Cards
5. Connect Ribbon Cables, Panel Wires, and Power Supply
6. Setup the BIOS Software

3.4 Motherboard Settings

This section explains in detail how to change your motherboard's function settings through the use of switches and/or jumpers.

WARNING! Computer motherboards and expansion cards contain very delicate Integrated Circuit (IC) chips. To protect them against damage from static electricity, you should follow some precautions whenever you work on your computer.

1. Unplug your computer when working on the inside.
2. Use a grounded wrist strap before handling computer components. If you do not have one, touch both of your hands to a safely grounded object or to a metal object, such as the power supply case.
3. Hold components by the edges and try not to touch the IC chips, leads or connectors, or other components.
4. Place components on a grounded antistatic pad or on the bag that came with the component whenever the components are separated from the system.
5. Ensure that the ATX power supply is switched off before you plug in or remove the ATX power connector on the motherboard.

WARNING! Make sure that you unplug your power supply when adding or removing system components. Failure to do so may cause severe damage to your motherboard, peripherals, and/or components. The onboard LED when lit acts as a reminder that the system is in suspend or soft-off mode and not powered OFF.

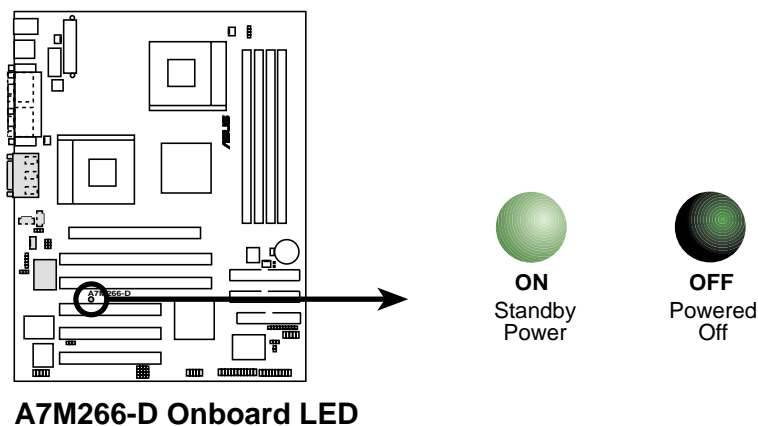

3. HARDWARE SETUP

Motherboard Features Settings (DIP Switches - DSW)

The motherboard's onboard functions are adjusted through the DIP switches. The white block represents the switch's position. The example below shows all the switches in the OFF position.

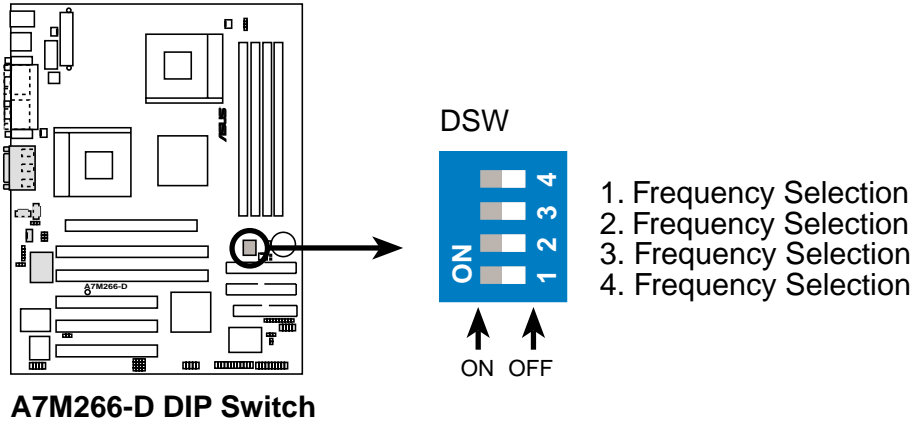

1) JumperFree™ Mode (JEN)

This jumper allows you to enable or disable the JumperFree™ mode. The JumperFree™ mode allows processor settings to be made through the BIOS setup (see **4.4 Advanced Menu**). **NOTE:** In JumperFree™ mode, all VID1-4 must be set to [3-4].

Setting	JEN
JumperFree	[2-3]
Jumper Mode	[1-2] (default)

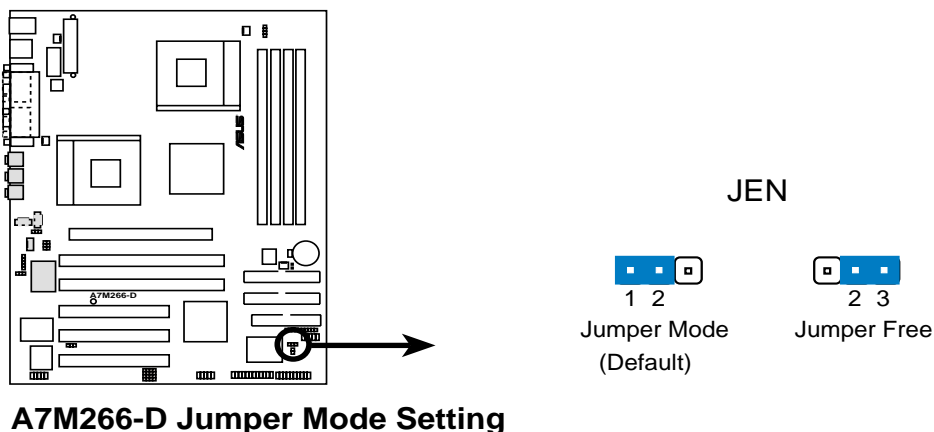

3. HARDWARE SETUP

2) DDR Voltage Setting (VDDR)

This jumper controls the voltage output to the DDR memory DRAMS. Less strain is placed on components at lower voltage settings.

<u>Setting</u>	<u>VDDR</u>
2.5V	[1-2]
2.6V	[2-3] (default)
2.7V	[3-4]

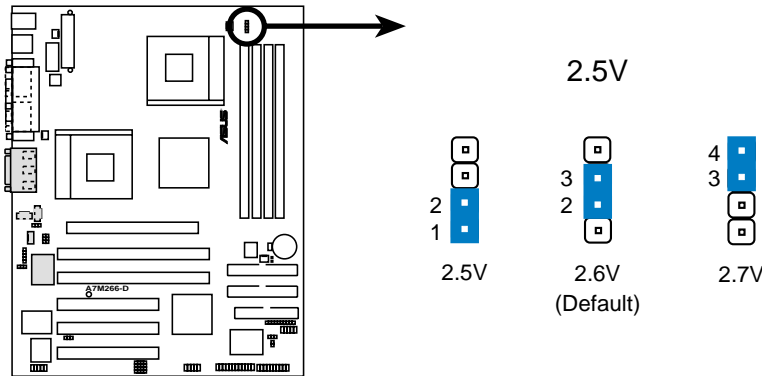

A7M266-D 2.5V Setting

3) Bass Center Setting (CENTER/BASS, BASS/CENTER)

Use these jumpers in conjunction with the C-Media PCI Audio Driver and to adjust output for 6 speaker audio. No audio standard exists for the three pick-up surfaces on male audio jacks, therefore it may be necessary to switch jumpers from the default position, [2-3] to [1-2] in order to reroute signals among the internal leads in the Line-In, Line-Out, Mic female sockets. Make sure a test is made using the C-Media Audio Driver software setup available on the Support CD.

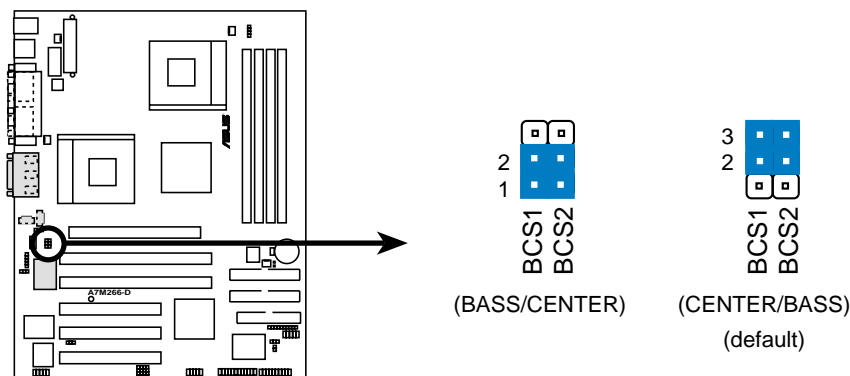

A7M266-D Bass Center Setting

3. HARDWARE SETUP

4) CPU External Frequency Setting (DSW Switches 1–4)

This option tells the clock generator what frequency to send to the CPU, SDRAM, and the chipset. This allows the selection of the CPU's *External* frequency. The CPU External Frequency multiplied by the Frequency Multiple equals the CPU's *Internal* frequency (the advertised CPU speed).

IMPORTANT:

- To use this feature, check the JEN and PO_VID jumper settings: (see *JumperFree™ Mode (JEN)* on the previous pages).

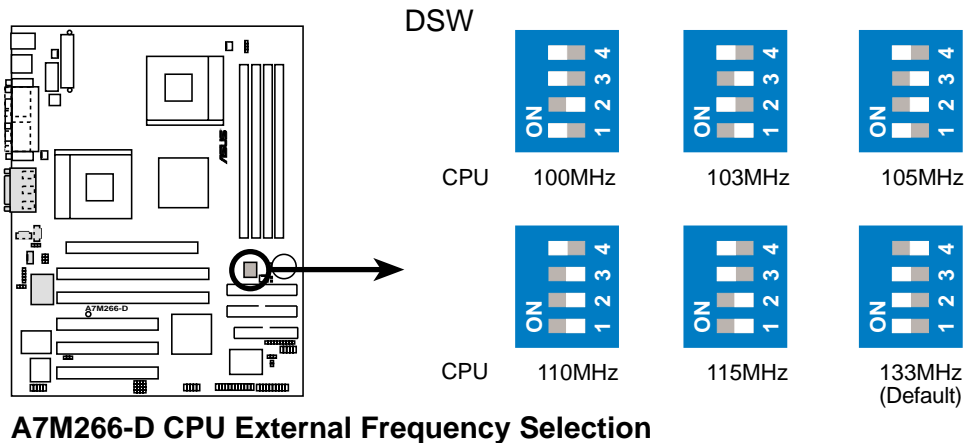

Frequency Table

(MHz)	DSW			
CPU	1	2	3	4
100	[ON]	[OFF]	[ON]	[ON]
103	[OFF]	[ON]	[OFF]	[ON]
105	[ON]	[OFF]	[OFF]	[ON]
110	[OFF]	[OFF]	[OFF]	[ON]
115	[OFF]	[OFF]	[ON]	[ON]
133	[ON]	[ON]	[ON]	[OFF]

WARNING! Frequencies other than the recommended CPU bus frequencies are not guaranteed to be stable. Overclocking your processor is not recommended. It may result in a slower speed and premature wearing of the processor.

3. HARDWARE SETUP

5) Voltage Regulator Output Setting (PO_VID1 - 4)

This jumpers allow you to manually adjust the CPU0 core voltage. It is recommended to use **CPU Default** (all jumpers [3-4]) as the setting for CPU core voltage. **CPU Default** means that the Vcore is generated according to the CPU-VID design configuration. For each jumper setting, there are two voltage options, depending on which CPU is used.

NOTE! The PO_VID jumpers simultaneously adjust voltages for both CPU0 and CPU1.

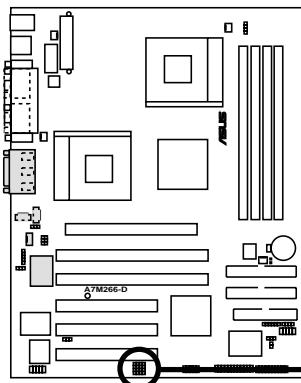

A7M266-D CPU0 Core Voltage Selection

	1	2	3	4		1	2	3	4		1	2	3	4	
PO_VID4	■	■	□	□	1.85/1.825Volts	■	■	□	□	1.8/1.775Volts	■	■	□	□	1.75/1.725Volts
PO_VID3	■	■	□	□		■	■	□	□		■	■	□	□	
PO_VID2	■	■	□	□		■	■	□	□		■	■	□	□	
PO_VID1	■	■	□	□		■	■	□	□		■	■	□	□	
PO_VID4	■	■	□	□	1.7/1.675Volts	■	■	□	□	1.65/1.625Volts	■	■	□	□	1.6/1.575Volts
PO_VID3	■	■	□	□		■	■	□	□		■	■	□	□	
PO_VID2	■	■	□	□		■	■	□	□		■	■	□	□	
PO_VID1	■	■	□	□		■	■	□	□		■	■	□	□	
PO_VID4	■	■	□	□	1.55/1.525Volts	■	■	□	□	1.50/1.475Volts	■	■	□	□	1.45/1.425Volts
PO_VID3	■	■	□	□		■	■	□	□		■	■	□	□	
PO_VID2	■	■	□	□		■	■	□	□		■	■	□	□	
PO_VID1	■	■	□	□		■	■	□	□		■	■	□	□	
PO_VID4	■	■	□	□	1.40/1.375Volts	■	■	□	□	1.35/1.325Volts	■	■	□	□	1.30/1.275Volts
PO_VID3	■	■	□	□		■	■	□	□		■	■	□	□	
PO_VID2	■	■	□	□		■	■	□	□		■	■	□	□	
PO_VID1	■	■	□	□		■	■	□	□		■	■	□	□	
PO_VID4	■	■	□	□	1.25/1.225Volts	■	■	□	□	1.20/1.175Volts	■	■	□	□	1.15/1.125Volts
PO_VID3	■	■	□	□		■	■	□	□		■	■	□	□	
PO_VID2	■	■	□	□		■	■	□	□		■	■	□	□	
PO_VID1	■	■	□	□		■	■	□	□		■	■	□	□	
PO_VID4	■	■	□	□	1.10/1.075Volts	■	■	□	□		■	■	□	□	
PO_VID3	■	■	□	□		■	■	□	□		■	■	□	□	
PO_VID2	■	■	□	□		■	■	□	□		■	■	□	□	
PO_VID1	■	■	□	□		■	■	□	□		■	■	□	□	
															CPU Default/ JumperMode (Default)

3. HARDWARE SETUP

3.5 System Memory (DDR DIMM)

This motherboard uses only **Double Data Rate** (DDR) Synchronous Dynamic Random Access Memory (SDRAM) Dual Inline Memory Modules (DIMMs).

DIMMs come in combinations of single or double-sided types ranging through 64MB, 128MB, 256MB, 512MB and 1GB to form a total memory size of *64MB to 3.5GB*.

Each DIMM socket/module is two-sided: each side defines one “row” of memory. DDR DIMMs support *ECC* and *non-ECC* modules; both types are available in registered (for servers) and unbuffered (for PCs) versions:

- ~ **Four (4)** sockets are available for both 266MHz-PC2100 *or* 200MHz-PC1600 **registered** DDR DIMMs to form a memory size of *64MB to 3.5GB*.
- ~ **Two (2)** sockets are available for 266MHz-PC2100 **unbuffered** DDR DIMMs: to form a memory size of *64MB to 2GB*.

NOTE: The DDR memory bus runs at the same frequency as the CPU front side bus.

DIMM Location	184-pin DIMM	Total Memory
Socket 1 (Rows 0&1)	64MB, 128MB, 256MB, 512MB, 1GB	x1
Socket 2 (Rows 2&3)	64MB, 128MB, 256MB, 512MB, 1GB	x1
Socket 3 (Rows 4&5)	64MB, 128MB, 256MB, 512MB, 1GB	x1
Socket 4 (Rows 6&7)	64MB, 128MB, 256MB, 512MB, 1GB	x1
Total System Memory (Max 3.5 GB)		=

3. HW SETUP
System Memory

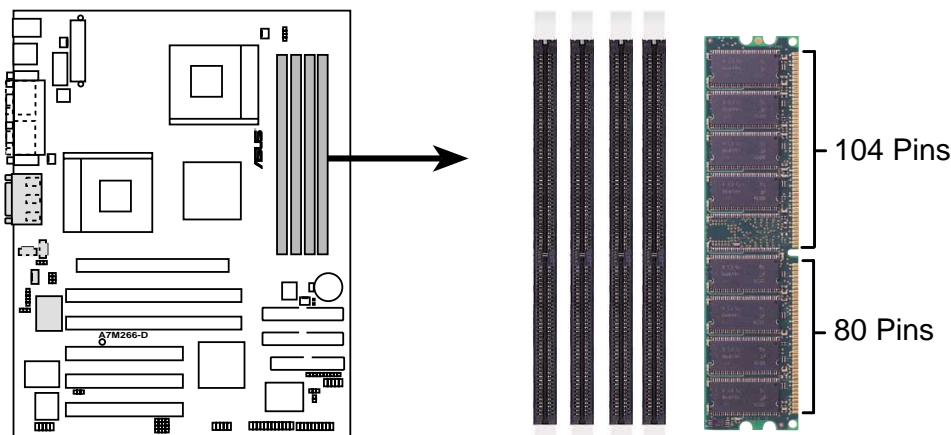

A7M266-D 184-Pin DDR DIMM Sockets

3. HARDWARE SETUP

3.5.1 Memory Installation

WARNING! Make sure that you unplug your power supply when adding or removing memory modules or other system components. Failure to do so may cause severe damage to both your motherboard and expansion cards

Insert the module(s) as shown. Because the number of pins are different on either side of the breaks, the module will only fit in the orientation shown. A 184-pin DDR SDRAM DIMM has a single notch slightly to the right of center. This motherboard supports three pairs of differential clock signals per DIMM.

Installing a DIMM:

1. Unlock a DIMM socket by pressing the retaining clips outward.
2. Align a DIMM on the socket such that the notches on the DIMM exactly match the notches in the socket.
3. Firmly insert the DIMM into the socket until the retaining clips snap back in place.
4. Populate the DIMM sockets in the following order: DIMM 1, 2, 3 then 4 to ensure system stability.

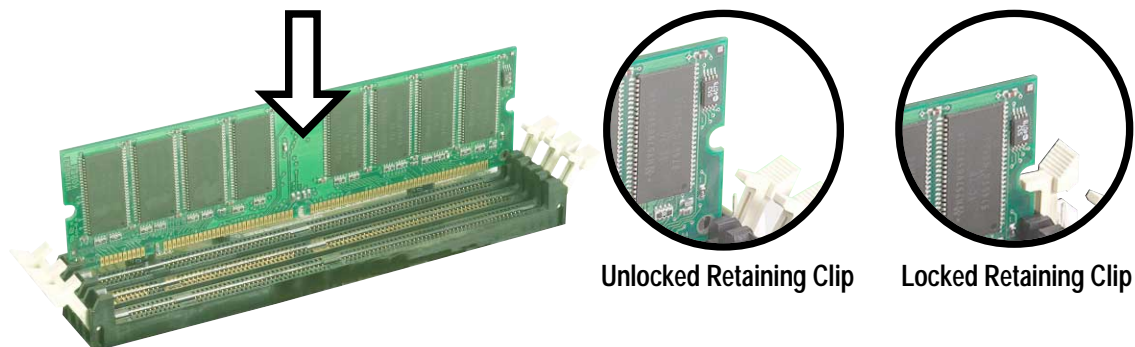

3.5.2 General DIMM Memo

- DIMMs that have more than 18 chips are not supported on this motherboard.
- For the system CPU bus to operate at 200MHz/266MHz, use only PC1600-/PC2100-compliant DIMMs.
- ASUS motherboards support SPD (Serial Presence Detect) DIMMs. This is the memory of choice for best performance vs. stability.
- Single-sided DDR DIMMs come in 64, 128, 256 and 512MB; double-sided come in 128, 256, 512MB and 1GB.
- Please refer to **Appendix 7.1** for a list of *Qualified Vendors* for DIMMs that have been tested for use with the A7M266-D motherboard.

WARNING! Be sure that the DIMMs you use can handle the specified DDR SDRAM MHz or else bootup will not be possible.

3. HARDWARE SETUP

3.6 Central Processing Unit (CPU)

The motherboard supports **two** A-type sockets (462 for dual CPU installation). Only AMD® Athlon™ **MP** processors may be installed; each CPU should be rated for the same FSB speed, but the rated speed for each CPU need not be the same. For single processor operation, use any type of AMD® Athlon™/Duron™ processor. Attach a fan and heatsink onto the CPU to prevent overheating.

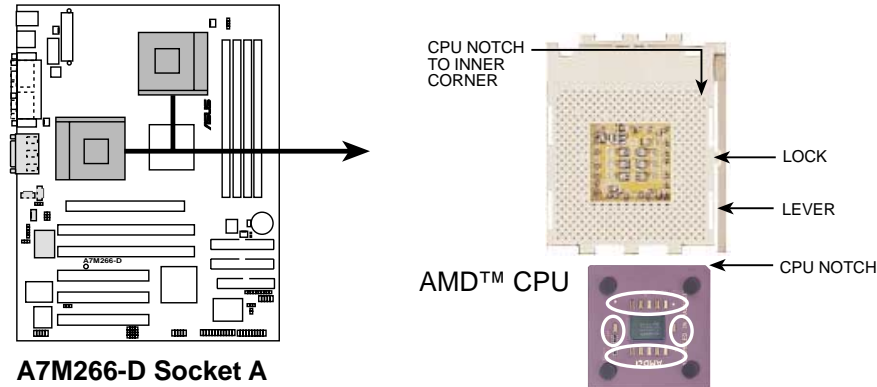

1. Locate the CPU socket. Open it by pulling the lever gently sideways away from the socket. Then lift the lever upwards. The socket lever must be fully opened (90 to 100 degrees).
2. Insert the CPU with the correct orientation: the **notched corner** of the CPU must be oriented toward the inner corner of the socket base nearest to the lever hinge.

CAUTION! The CPU fits in one orientation and should drop easily into place. **Do not force the CPU** into the socket to avoid bending the pins. If the CPU does not fit, check its alignment and look for bent pins.

3. Once completely inserted, press the CPU firmly and close the socket lever until it snaps into its locked position.
4. Place a CPU fan and heatsink over the CPU. The heatsink should entirely cover the CPU. Carefully attach the heatsink locking brace to the plastic clips on the socket base. No extra force is required to keep the CPU in place.

CAUTION! Take care not to scrape the motherboard surface when mounting a clamp-style processor fan, or damage may occur. When mounting a heatsink onto your CPU, ensure that exposed CPU capacitors do not touch the heatsink, or else damage may occur! Refer to heatsink/CPU documentation.

NOTE! To avoid start-up problems, adjust the correct Bus Frequency and Multiples. (See: 3.4 Motherboard Settings and, 4.4.Advanced BIOS.)

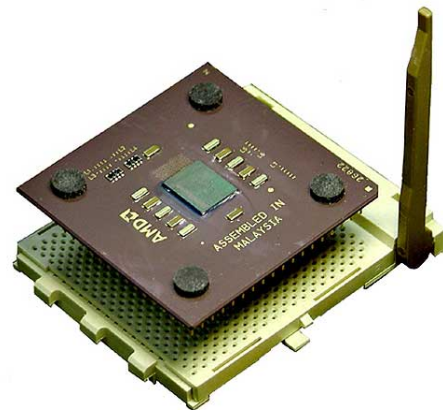

3. HARDWARE SETUP

3.7 Expansion Cards

WARNING! Unplug your power supply when adding or removing expansion cards or other system components. Failure to do so may cause severe damage to both your motherboard and expansion cards.

3.7.1 Expansion Card Installation Procedure

1. Read the documentation for your expansion card and make any necessary hardware or software settings for your expansion card, such as jumpers.
2. Remove your computer system's cover and the bracket plate on the slot you intend to use. Keep the bracket for possible future use.
3. Carefully align the card's connectors and press firmly.
4. Secure the card on the slot with the screw you removed above.
5. Replace the computer system's cover.
6. Set up the BIOS if necessary
(such as *IRQ.xx Used By ISA: Yes* in **4.4.3 PCI Configuration**)
7. Install the necessary software drivers for your expansion card.

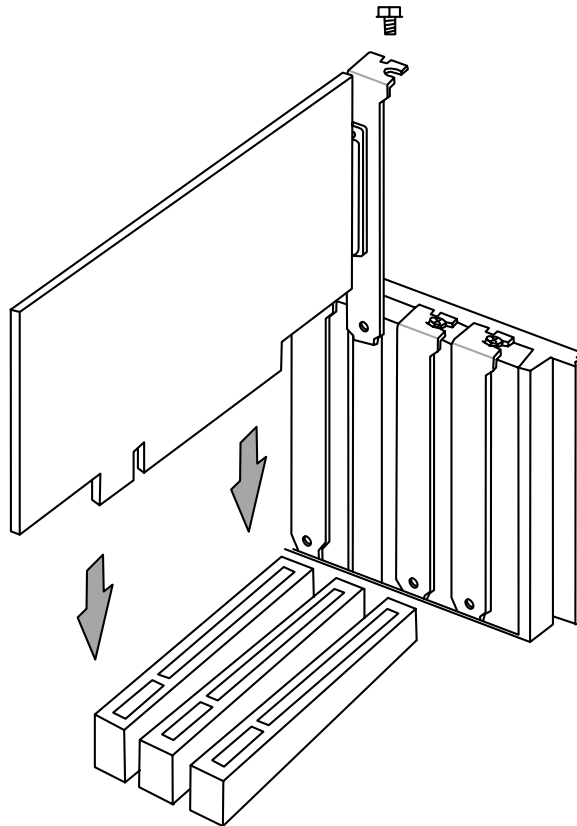

3. HARDWARE SETUP

3.7.2 Assigning IRQs for Expansion Cards

Some expansion cards need an IRQ to operate. Generally, an IRQ must be exclusively assigned to one use. In a standard design, there are 16 IRQs available but most of them are already in use, leaving 6 IRQs free for expansion cards. If your motherboard has **PCI** audio onboard, an additional IRQ will be used. If your motherboard also has **MIDI** enabled, another IRQ will be used, leaving 4 IRQs free.

IMPORTANT: If using PCI cards on shared slots, make sure that the drivers support “Share IRQ” or that the cards do not need IRQ assignments. Conflicts will arise between the two PCI groups that will make the system unstable or cards inoperable.

The following table lists the default IRQ assignments for standard PC devices. Use this table when configuring your system and for resolving IRQ conflicts.

Standard Interrupt Assignments

IRQ	Priority	Standard Function
0	1	System Timer
1	2	Keyboard Controller
2	N/A	Programmable Interrupt
3*	11	Communications Port (COM2)
4*	12	Communications Port (COM1)
5*	13	Sound Card (sometimes LPT2)
6	14	Floppy Disk Controller
7*	15	Printer Port (LPT1)
8	3	System CMOS/Real Time Clock
9*	4	ACPI Mode when used
10*	5	IRQ Holder for PCI Steering
11*	6	IRQ Holder for PCI Steering
12*	7	PS/2 Compatible Mouse Port
13	8	Numeric Data Processor
14*	9	Primary IDE Channel
15*	10	Secondary IDE Channel

*These IRQs are usually available for PCI devices.

Interrupt Request Table for this Motherboard

	INT-A	INT-B	INT-C	INT-D
PCI slot 3	—	shared	—	—
PCI slot 4	—	—	used	—
PCI slot 5	—	—	—	shared
AGP Pro slot	shared	shared	—	—
Onboard PCI audio	—	shared	—	—
Onboard USB Controller	—	—	—	shared

3. HARDWARE SETUP

3.7.3 Accelerated Graphics Port Pro (AGP Pro)

This motherboard provides an Accelerated Graphics Port Pro (AGP Pro) slot to support AGP/AGP Pro graphics cards, such as an ASUS AGP-V6800DDR/64M.

CAUTION! To avoid damaging your AGP/AGP Pro graphics card, your computer's power supply should be unplugged before inserting your graphics card into the slot.

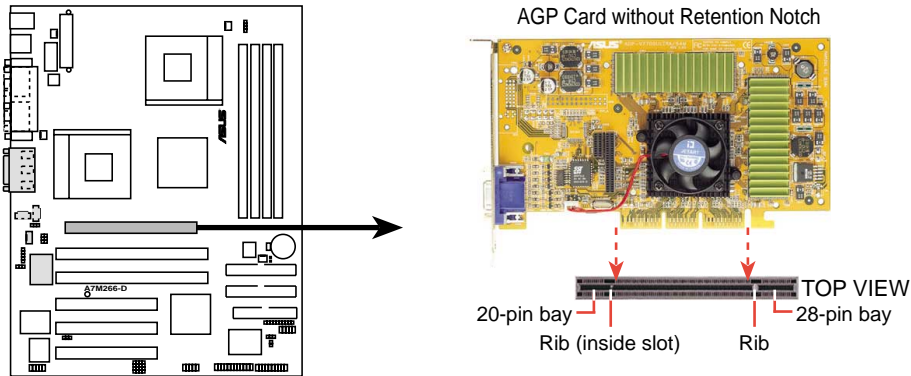

A7M266-D Accelerated Graphics Port (AGP PRO)

CAUTION! The AGP Pro slot is shipped with a safety tab on the 20-pin bay for use with AGP cards *without* a retention notch. **DO NOT** remove this tab if you will be using such cards. Remove the tab **ONLY** when you will be using an *AGP Pro* card. Use a rigid tip, such as a pen tip, to dislodge and remove the tab from the bay.

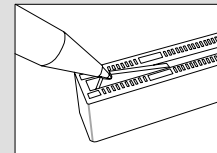

3.7.4 ASUS™ PCI-USB2 Card

The A7M266-D motherboard is supplied with the USB 1.1 and 2.0 compliant *PCI-USB2* card and driver software. To install the *PCI-USB2* card, power off the computer, plug in the PCI card and restart the system. Enter the *Windows Control Panel* menu and use the *Install New Hardware* and *Software* wizards to install hardware and drivers.

NOTE! With multi-processor systems, do not use more than 2 USB 2.0 devices if operating with the Windows 2000 OS.

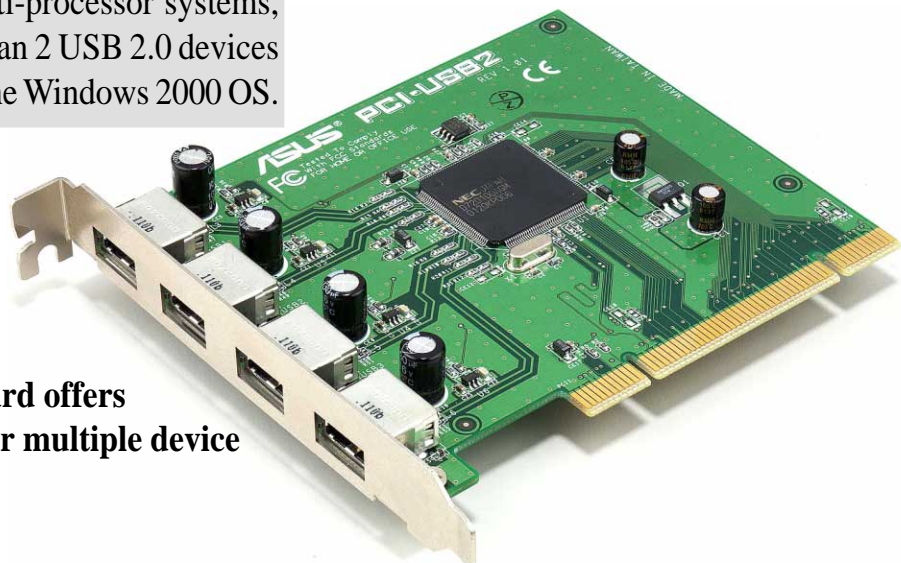

The **PCI-USB2** card offers **four USB ports** for multiple device connectivity.

3. HARDWARE SETUP

3.8 External Connectors

WARNING! Some pins are used for connectors or power sources. These are clearly distinguished from jumpers in the Motherboard Layout. Placing jumper caps over these connector pins will cause damage to your motherboard.

IMPORTANT: Ribbon cables should always be connected with the red stripe to Pin 1 on the connectors. Pin 1 is usually on the side closest to the power connector on hard drives and CD-ROM drives, but may be on the opposite side on floppy disk drives. Check the connectors before installation because there may be exceptions. IDE ribbon cable must be less than 46 cm (18 in.), with the second drive connector no more than 15 cm (6 in.) from the first connector.

1) PS/2 Mouse Connector (Green 6-pin PS2KBMS)

The system will direct IRQ12 to the PS/2 mouse if one is detected. If one is not detected, expansion cards can use IRQ12. See **PS/2 Mouse Function Control** in *4.4 Advanced Menu*.

PS/2 Mouse (6-pin Female)

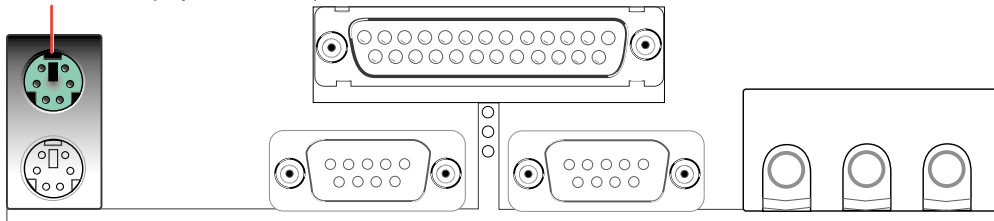

2) PS/2 Keyboard Connector (Purple 6-pin PS2KBMS)

This connection is for a standard keyboard using an PS/2 plug (mini DIN). **This connector will not allow standard AT size (large DIN) keyboard plugs. You may use a DIN to mini DIN adapter on standard AT keyboards.**

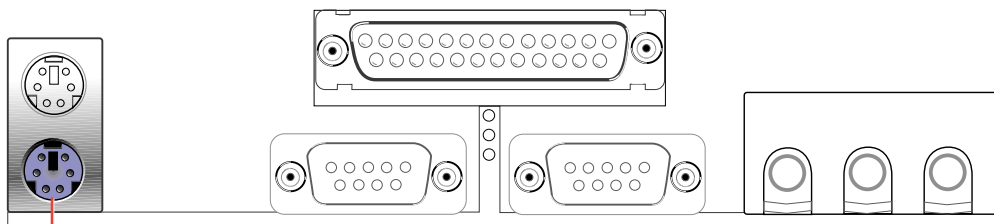

PS/2 Keyboard (6-pin Female)

3. HARDWARE SETUP

3) Universal Serial Bus Ports 0 & 1 (Black two 4-pin USB)

Two USB ports are available for connecting USB devices. An optional USB header is available if you need more USB ports.

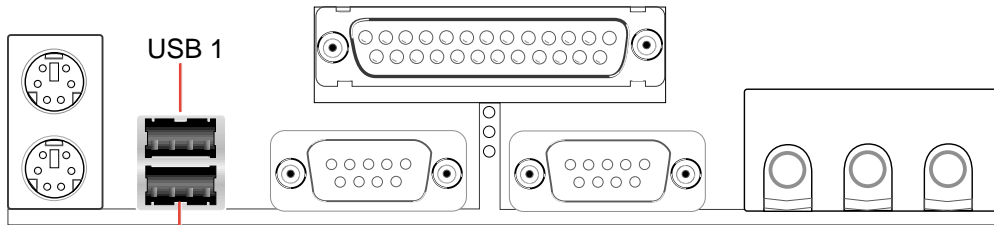

Universal Serial Bus (USB) 2

4) Serial Port Connectors (Teal/Turquoise 9-pin COM1 / COM2)

Two serial ports can be used for pointing devices or other serial devices. For setting up these ports, see **Onboard Serial Port 1** in *4.4.2 I/O Device Configuration* for settings.

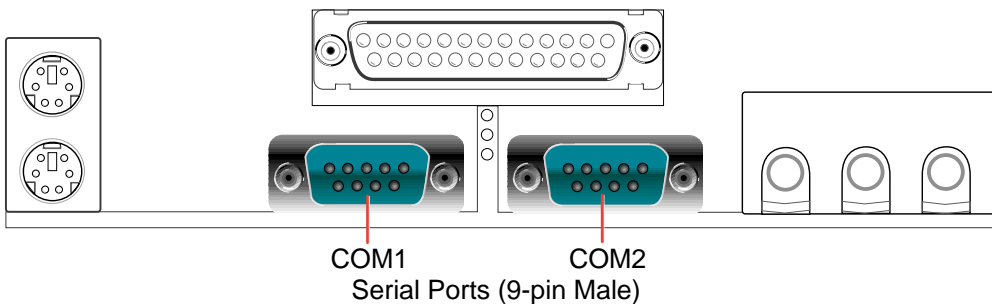

COM1
COM2
Serial Ports (9-pin Male)

5) Parallel Port Connector (Burgundy 25-pin PRINTER)

You can enable the parallel port and choose the IRQ through **Onboard Parallel Port** (see *4.4.2 I/O Device Configuration*).

NOTE: Serial printers must be connected to the serial port.

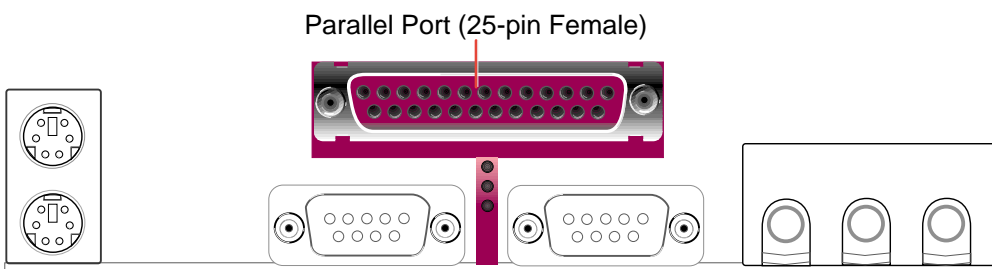

Parallel Port (25-pin Female)

3. HARDWARE SETUP

6) Audio Port Connectors (Three 1/8" GAME_AUDIO) (optional)

Line Out (lime) can be connected to headphones or preferably powered speakers. **Line In** (light blue) allows tape players or other audio sources to be recorded by your computer or played through the **Line Out** (lime). **Mic** (pink) allows microphones to be connected for inputting voice.

NOTE: (Only on model with onboard PCI audio) To set up a four speaker system, connect rear side speakers to the **Line In** connector and enable the C-Media 4-speaker function (see **6.4.2 Enabling 4-Speaker Function**).

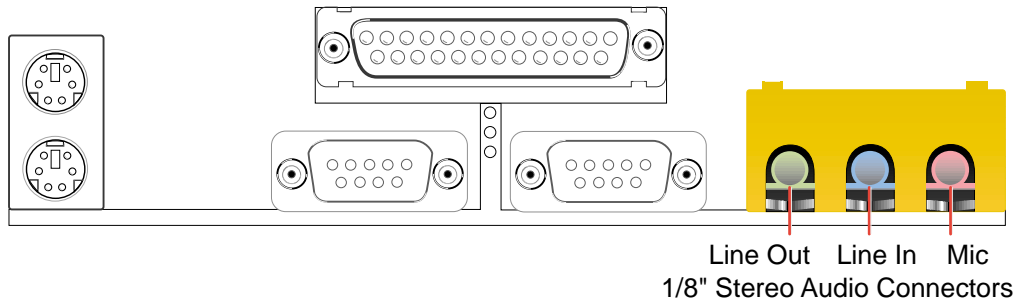

7) Floppy Disk Drive Connector (34-1 pin FLOPPY)

This connector supports the provided floppy drive ribbon cable. After connecting the single end to the board, connect the two plugs on the other end to the floppy drives. (**Pin 5 is removed to prevent inserting in the wrong orientation when using ribbon cables with pin 5 plugged**).

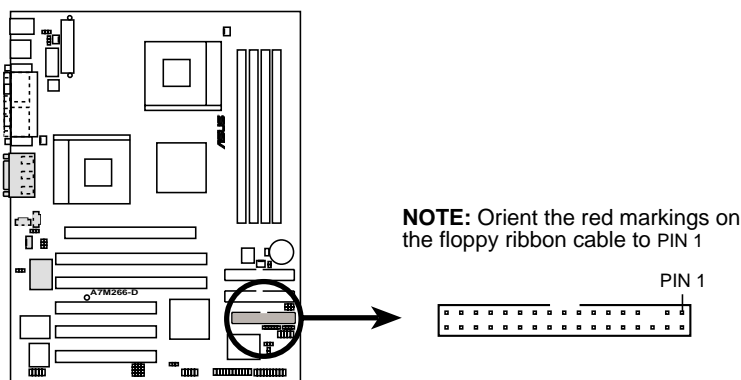

A7M266-D Floppy Disk Drive Connector

3. HARDWARE SETUP

8) Primary (Blue) / Secondary IDE Connectors (Two 40-1pin IDE)

These connectors support the provided UltraDMA/100 IDE hard disk ribbon cable. Connect the cable's blue connector to the motherboard's primary (recommended) or secondary IDE connector, and then connect the gray connector to your UltraDMA/100 slave device (hard disk drive) and the black connector to your UltraDMA/100 master device. It is recommended that non-UltraDMA/100 devices be connected to the secondary IDE connector. If you install two hard disks, you must configure the second drive to Slave mode by setting its jumper accordingly. Please refer to your hard disk documentation for the jumper settings. BIOS now supports specific device bootup (see **4.6 Boot Menu**). **(Pin 20 is removed to prevent inserting in the wrong orientation when using ribbon cables with pin 20 plugged).**

TIP: You may configure two hard disks to be both Masters with two ribbon cables – one for the primary IDE connector and another for the secondary IDE connector. You may install one operating system on an IDE drive and another on a SCSI drive and select the boot disk through the BIOS.

IMPORTANT: UltraDMA100/66 IDE devices must use a 40-pin 80-conductor IDE cable for 100MB/s transfer rates.

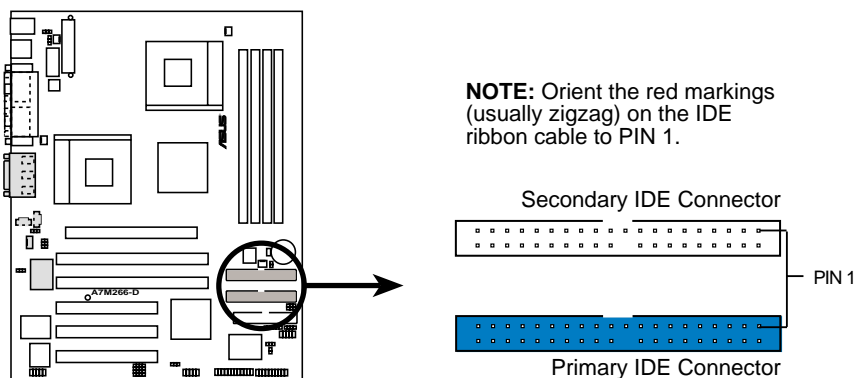

A7M266-D IDE Connectors

3. HARDWARE SETUP

9) Chassis Intrusion Lead (4-1 pin CHASSIS)

This requires an external detection mechanism such as a chassis intrusion monitor/sensor or microswitch. The sensor is triggered when a high level signal is sent to the Chassis Signal lead, which occurs when a panel switch or light detector is triggered. This function works with an optional ASUS CIDB chassis intrusion module (see your vendor for more details). If the chassis intrusion lead is not used, a jumper cap must be placed over the pins to close the circuit.

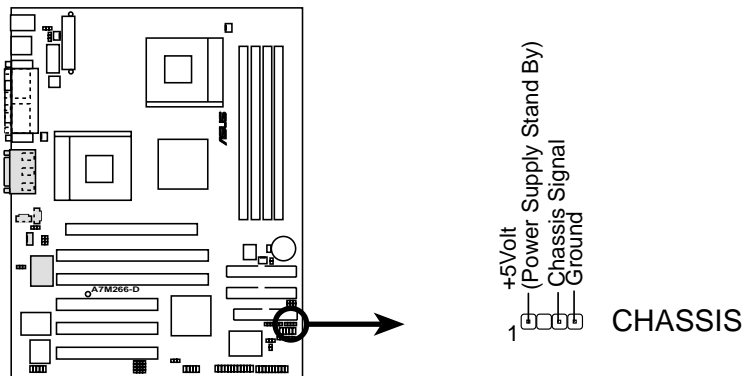

A7M266-D Chassis Open Alarm Lead

10) Standard Infrared Module Connector (5-1 pin IR)

This connector supports an optional wireless transmitting and receiving infrared module. This module mounts to a small opening on system cases that support this feature. You must also configure the setting through **UART2 Use Infrared** (see **4.4.2 I/O Device Configuration**) to select whether UART2 is directed for use with COM2 or IrDA. Use the five pins as shown in Back View and connect a ribbon cable from the module to the motherboard's SIR connector according to the pin definitions.

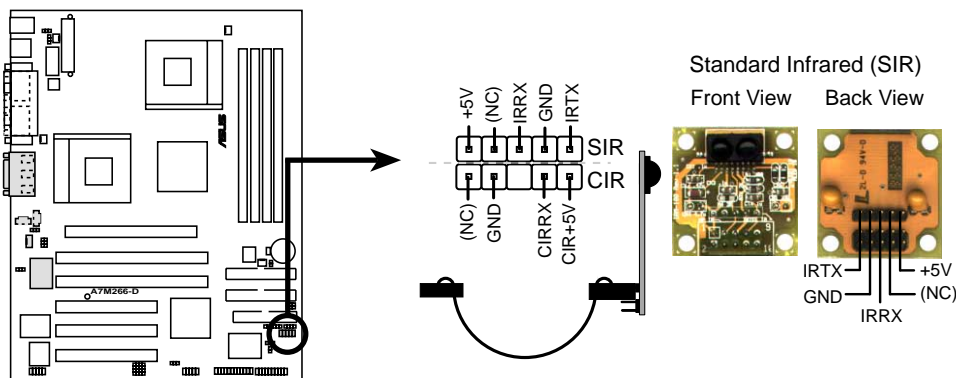

A7M266-D Infrared Module Connector

3. HARDWARE SETUP

11) Chassis, Power Supply, CPU, and Chipset Fan Connectors (3-pin CHA_FAN, PWR_FAN, CPU0_FAN, CPU1_FAN)

These connectors support cooling fans of 350mA (4.2 Watts) or less. Orientate the fans so that the heat sink fins allow airflow to go across the onboard heat sink(s) instead of the expansion slots. Depending on the fan manufacturer, the wiring and plug may be different. The red wire should be positive, while the black should be ground. Connect the fan's plug to the board taking into consideration the polarity of the connector.

NOTE: The "Rotation" signal is to be used only by a specially designed fan with rotation signal. The Rotations per Minute (RPM) can be monitored using ASUS PC Probe (see **6. SOFTWARE REFERENCE**).

WARNING! The CPU and/or motherboard will overheat if there is no airflow across the CPU and onboard heatsinks. Damage may occur to the motherboard and/or the CPU fan if these pins are incorrectly used. **These are not jumpers, do not place jumper caps over these pins.**

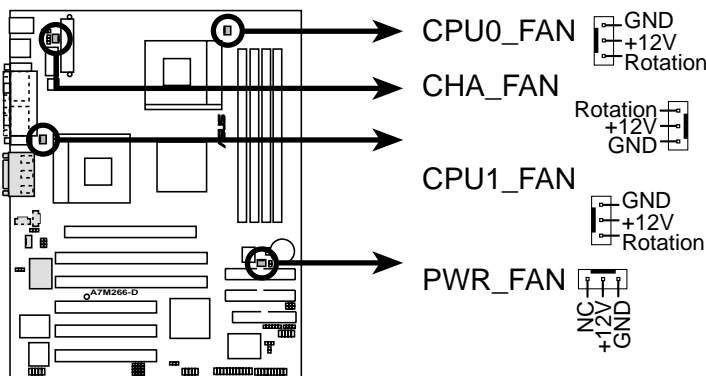

A7M266-D 12-Volt Cooling Fan Power

3. HARDWARE SETUP

12) USB Headers (10-1 pin USBPORT)

If the USB port connectors on the back panel are inadequate, two USB headers are available for two additional USB port connectors. Connect the USB headers to an optional 2-port USB connector set and mount the bracket to an open slot on your chassis.

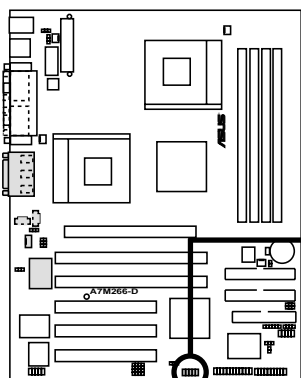

A7M266-D USB Port

USBPORT

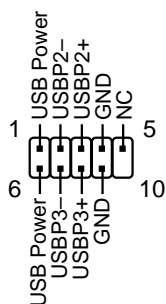

Recommended Setup: Use USBPORT with the bundled 2-port connector set.

13) SMBus Connector (5-1 pin SMB)

This connector allows you to connect SMBus (System Management Bus) devices. SMBus devices communicate by means of the SMBus with an SMBus host and/or other SMBus devices. SMBus is a specific implementation of an I²C bus, which is a multi-device bus; that is, multiple chips can be connected to the same bus and each one can act as a master by initiating data transfer.

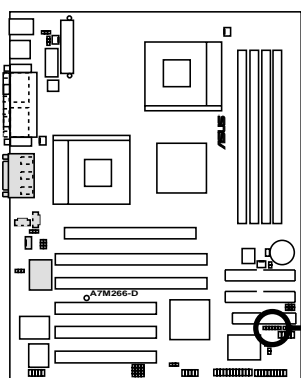

A7M266-D SMBus Connector

SMB

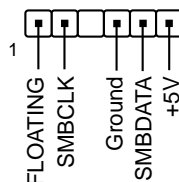

3. HARDWARE SETUP

14) ASUS iPanel Connector (24-1 pin AFPANEL)

This connector allows you to connect an optional ASUS iPanel, an easy to access drive bay with front I/O ports, status LEDs, and space reserved for a hard disk drive. If you are not using an ASUS iPanel, you can connect an optional wireless transmitting and receiving infrared module to the SIR connector or an optional consumer infrared connector set to the CIR and SIR connectors for both wireless transmitting and remote control functions through one external infrared module.

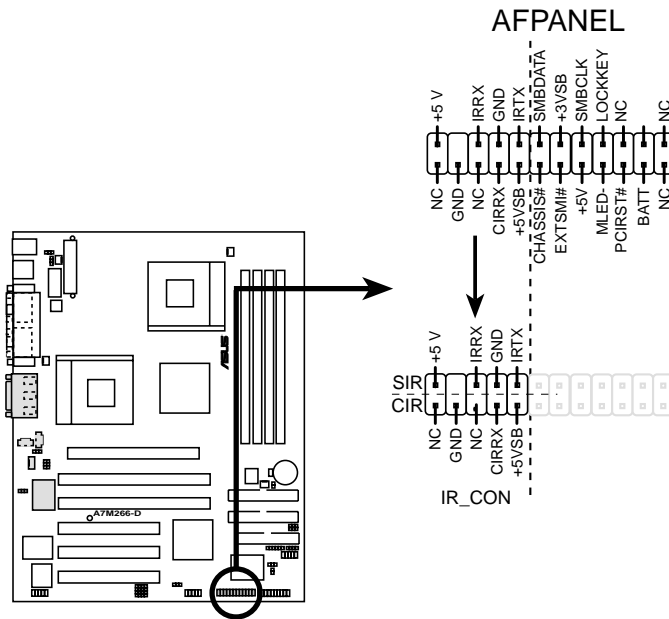

A7M266-D Front Panel Connector

15) Internal Microphone Connector (3-pin MIC2) (optional)

This connector supports the chassis-mounted microphone to the motherboard instead of connecting an external microphone to the ATX connector.

NOTE: The internal microphone does not work if there is an external microphone connected to the external Mic (pink) jack. You may only use one microphone at a time.

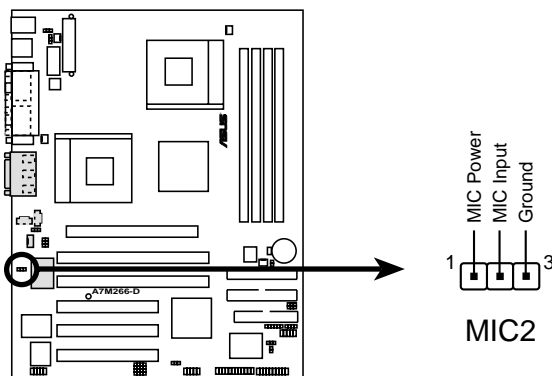

A7M266-D Internal Microphone Connector

3. HARDWARE SETUP

16) Headphone True-level Line Out Header (3-pin HPHONE) (optional)

This connector supports the chassis-mounted headphone instead of connecting an external headphone to the rear panel connector.

NOTE: The internal microphone does not work if there is an external microphone connected to the external Mic (pink) jack. You may only use one microphone at a time.

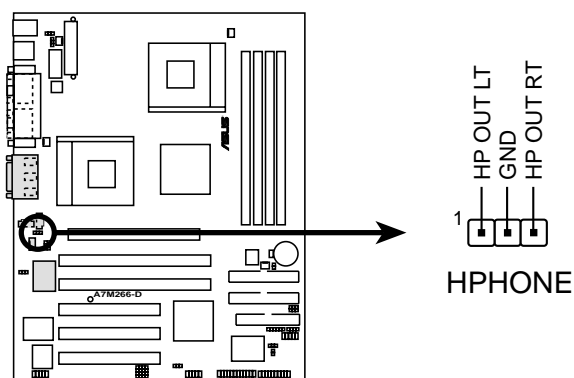

A7M266-D True-Level Line Out Header

17) Audio Input Line In Header (5-pin LINE_IN) (optional)

This connector supports audio input on left and right stereo audio channels.

NOTE: The motherboard ships with Jumper caps over pins 1-2 and 4-5. Remove them **only** when making audio input connections.

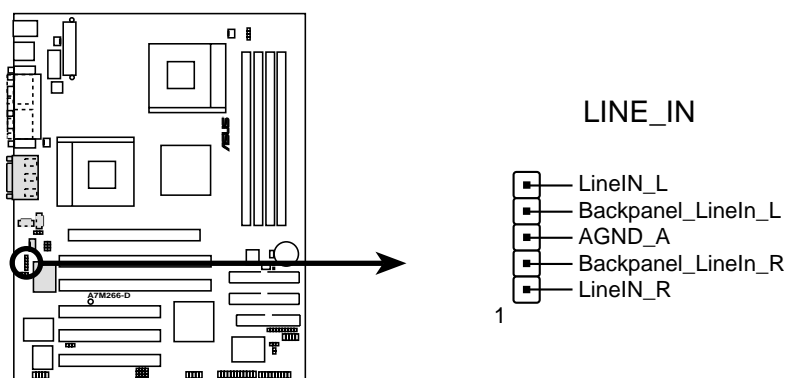

A7M266-D LINE_IN Connector

3. HARDWARE SETUP

18) Front Panel Audio Connector (10-1 pin IAPANEL)

Attach the Front Panel audio cable to the IAPANEL connector for audio control.

NOTE: The motherboard ships with Jumper caps over pins 1-2 and 5-6. Remove them **only** when making connections to a Front Panel.

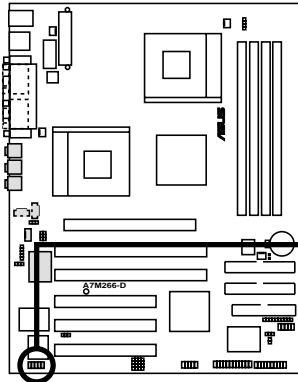

A7M266-D Intel Panel Connector

IAPANEL

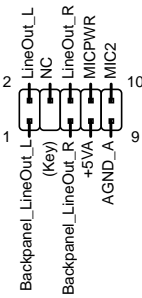

19) IDE Activity LED (2-pin IDELED)

This connector supplies power to the cabinet's IDE activity LED. Read and write activity by devices connected to the Primary/Secondary IDE connectors will cause the LED to light up.

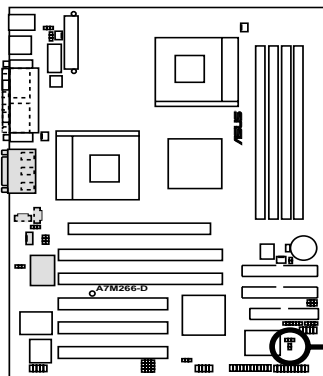

A7M266-D IDE Activity LED

TIP: If the case-mounted LED does not light, try reversing the 2-pin plug.

IDELED



3. HARDWARE SETUP

20) ATX Power Supply Connector (20-pin block ATXPWR, 6-pin EAUXPWR, 4-pin ATX12V)

These connectors supply power from ATX and auxiliary power supplies. Each type of connector socket requires a special plug from its type of power supply. Care must be exercised to select the appropriate connector for each power source. See the specifications for each power source below. When plugging the connectors, push down firmly to make sure that the pins are aligned.

Important Specifications: The minimum requirement for full-power loading is a 400 Watt ATX 12V power supply; minimum requirement for +5v/3.3.V is 180 Watts; +12 Volts requires 15 Amps; 5VSB requires 1 Amp. Also ensure that the ATX power supply can put out at least 10mA on the +5-volt standby lead (+5VSB). You may experience difficulty powering ON the system if the power supply cannot support the load. For Wake-On-LAN support, your ATX power supply must supply at least 720mA +5VSB.

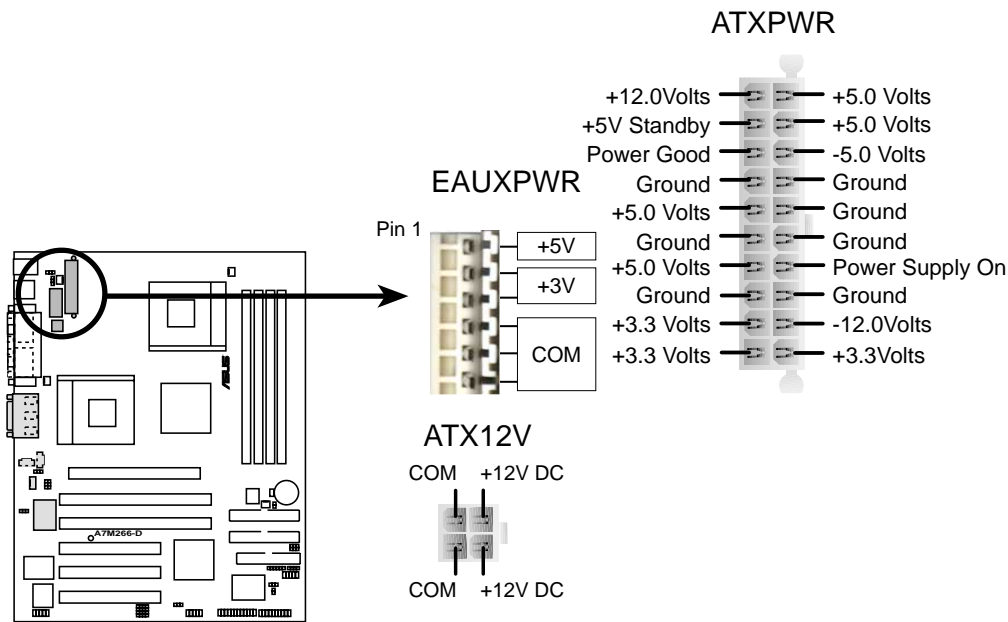

A7M266-D ATX & Auxiliary Power Connectors

The following PANEL illustration is used for items 21–27:

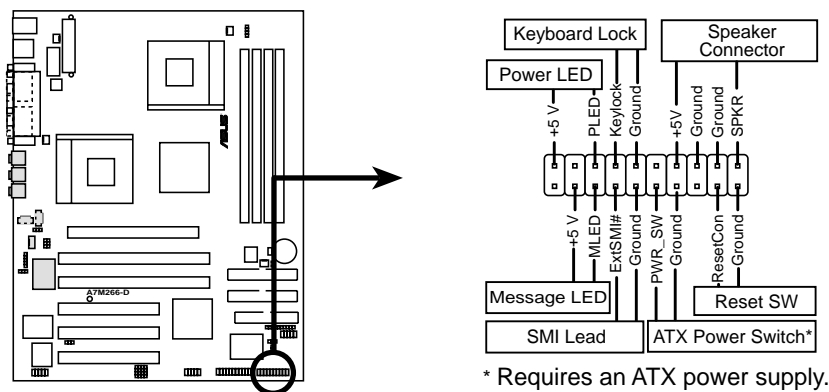

A7M266-D System Panel Connectors

21) System Power LED Lead (3-1 pin PWRLED)

This 3-1 pin connector connects to the system power LED, which lights when the system is powered on and blinks when it is in sleep or soft-off mode.

22) Keyboard Lock Switch Lead (2-pin KEYLOCK)

This 2-pin connector supports a case-mounted key switch for keyboard locking.

23) System Warning Speaker Connector (4-pin SPEAKER)

This 4-pin connector connects to the case-mounted speaker.

24) System Message LED Lead (2-pin MSGLED)

This indicates whether a message has been received from a fax/modem. The LED will remain lit when there is no signal and blink when there is data received. This function requires an ACPI OS and driver support.

25) System Management Interrupt Lead (2-pin SMISW)

This allows the user to manually place the system into a suspend mode or “Green” mode where system activity will be instantly decreased to save electricity and expand the life of certain components when the system is not in use. This 2-pin connector (see the preceding figure) connects to the case-mounted suspend switch.

26) ATX Power Switch / Soft-Off Switch Lead (2-pin PWRSW)

The system power is controlled by a momentary switch connected to this lead. Pushing the button once will switch the system between ON and SLEEP or ON and SOFT OFF, depending on your BIOS or OS setting. Pushing the switch while in the ON mode for more than 4 seconds will turn the system off. The system power LED shows the status of the system’s power.

27) Reset Switch Lead (2-pin RESET)

This 2-pin connector connects to the case-mounted reset switch for rebooting your computer without having to turn off your power switch. This is a preferred method of rebooting to prolong the life of the system’s power supply.

3. HARDWARE SETUP

3.9 Starting Up the First Time

1. After all connections are made, close the system case cover.
2. Be sure that all switches are off (in some systems, marked with ○).
3. Connect the power supply cord into the power supply located on the back of your system case according to your system user's manual.
4. Connect the power cord into a power outlet that is equipped with a surge protector.
5. You may then turn on your devices in the following order:
 - a. Your monitor
 - b. External SCSI devices (starting with the last device on the chain)
 - c. Your system power. For ATX power supplies, you need to switch on the power supply as well as press the ATX power switch on the front of the case.
6. The power LED on the front panel of the system case will light. For ATX power supplies, the system LED will light when the ATX power switch is pressed. The LED on the monitor may light up or switch between orange and green after the system's if it complies with "green" standards or if it has a power standby feature. The system will then run power-on tests. While the tests are running, the BIOS will alarm beeps or additional messages will appear on the screen. If you do not see anything within 30 seconds from the time you turn on the power, the system may have failed a power-on test. Recheck your jumper settings and connections or call your retailer for assistance.

Award BIOS Beep Codes

Beep	Meaning
One short beep when displaying logo	No error during POST
Long beeps in an endless loop	No DRAM installed or detected
One long beep followed by three short beeps	Video card not found or video card memory bad
High frequency beeps when system is working	CPU overheated System running at a lower frequency

3. HARDWARE SETUP

7. During power-on, hold down <Delete> to enter BIOS setup. Follow the instructions in **4. BIOS SETUP**.

- * **Powering Off your computer:** You must first exit or shut down your operating system before switching off the power switch. For ATX power supplies, you can press the ATX power switch after exiting or shutting down your operating system. If you use Windows 9X, click the **Start** button, click **Shut Down**, and then click **Shut down the computer?** The power supply should turn off after Windows shuts down.

NOTE: The message “You can now safely turn off your computer” will not appear when shutting down with ATX power supplies.

4. BIOS SETUP

4.1 Managing and Updating Your BIOS

4.1.1 Upon First Use of the Computer System

It is recommended that you save a copy of the original motherboard BIOS along with a Flash Memory Writer utility (AFLASH.EXE) to a bootable floppy disk in case you need to reinstall the BIOS later. **AFLASH.EXE** is a Flash Memory Writer utility that updates the BIOS by uploading a new BIOS file to the programmable flash ROM on the motherboard. This file works only in DOS mode. To determine the BIOS version of your motherboard, check the last four numbers of the code displayed on the upper left-hand corner of your screen during bootup. Larger numbers represent a newer BIOS file.

1. Type **FORMAT A:/S** at the DOS prompt to create a bootable system floppy disk. **DO NOT** copy AUTOEXEC.BAT & CONFIG.SYS to the disk.
2. Type **COPY D:\AFLASH\AFLASH.EXE A:** (assuming D is your CD-ROM drive) to copy AFLASH.EXE to the just created boot disk.

NOTE: AFLASH works only in DOS mode. It will not work with DOS prompt in Windows and will not work with certain memory drivers that may be loaded when you boot from your hard drive. It is recommended that you reboot using a floppy.

3. Reboot your computer from the floppy disk. **NOTE:** BIOS setup must specify “Floppy” as the first item in the boot sequence.
4. In DOS mode, type **A:\AFLASH <Enter>** to run AFLASH.

```
ASUS ACPI BIOS
FLASH MEMORY WRITER V1.24
Copyright (C) 1994-99, ASUSTeK COMPUTER INC.

Flash Memory: Winbond W29C020 or SST 29EE020 or Intel 82802AB

Current BIOS Version: ASUS XXX-XX ACPI BIOS Revision 100X
BIOS Model          : XXX-XX
BIOS Built Date     : 09/25/99

Choose one of the followings:

1. Save Current BIOS To File
2. Update BIOS Including Boot Block and ESCD

Enter choice: [1]

Press ESC To Exit
```

IMPORTANT! If “unknown” is displayed after **Flash Memory:**, the memory chip is either not programmable or is not supported by the ACPI BIOS and therefore, cannot be programmed by the Flash Memory Writer utility.

4. BIOS SETUP

5. Select **1. Save Current BIOS to File** from the Main menu and press <Enter>. The **Save Current BIOS To File** screen appears.

```
Save Current BIOS To File
Flash Memory: Winbond W29C020 or SST 29EE020 or Intel 82802AB
Current BIOS Version: ASUS XXX-XX ACPI BIOS Revision 100X
BIOS Model          : XXX-XX
BIOS Built Date     : 09/25/99
Please Enter File Name to Save: XXX-XX.XXX

BIOS Saved Successfully
Press ESC To Continue
```

6. Type a filename and the path, for example, **A:\XXX-XX.XXX** and then press <Enter>.

4.1.2 Updating BIOS Procedures

WARNING! Only update your BIOS if you have problems with your motherboard and you know that the new BIOS revision will solve your problems. Careless updating can result in your motherboard having more problems!

1. Download an updated ASUS BIOS file from the Internet (WWW or FTP) (see ASUS CONTACT INFORMATION on page 3 for details) and save to the disk you created earlier.
2. Boot from the disk you created earlier.
3. At the “A:\” prompt, type **AFLASH** and then press <Enter>.
4. At the **Main Menu**, type **2** and then press <Enter>. The **Update BIOS Including Boot Block and ESCD** screen appears.
5. Type the filename of your new BIOS and the path, for example, **A:\XXX-XX.XXX**, and then press <Enter>.

NOTE: To cancel this operation, press <Enter>.

```
Update BIOS Including Boot Block and ESCD
Flash Memory: Winbond W29C020 or SST 29EE020 or Intel 82802AB
Current BIOS Version: ASUS XXX-XX ACPI BIOS Revision 100X
BIOS Model          : XXX-XX
BIOS Built Date     : 09/25/99
Please Enter File Name for NEW BIOS: A:\XXX-XX.XXX
```

4. BIOS SETUP

6. When prompted to confirm the BIOS update, press **Y** to start the update.

```
Update BIOS Including Boot Block and ESCD

Flash Memory: Winbond W29C020 or SST 29EE020 or Intel 82802AB

BIOS Version
[CURRENT ] ASUS XXX-XX ACPI BIOS Revision 100X
[test.awd] ASUS XXX-XX ACPI BIOS Revision 100X

BIOS Model
[CURRENT ] XXX-XX
[test.awd] XXX-XX

Date of BIOS Built
[CURRENT ] 09/25/99
[XXXX.XXXX] 05/29/00

Check sum of 1001.010 is F266.

Are you sure (Y/N) ? [Y]

Press ESC To Return to Main Menu
```

7. The utility starts to program the new BIOS information into the flash ROM. The boot block will be updated automatically only when necessary. This will minimize the chance that a failed update will prevent your system from booting up. When the programming is finished, *Flashed Successfully* will be displayed.

```
Update BIOS Including Boot Block and ESCD

Flash Memory: Winbond W29C020 or SST 29EE020 or Intel 82802AB

BIOS Version
[CURRENT ] ASUS XXX-XX ACPI BIOS Revision 100X
[test.awd] ASUS XXX-XX ACPI BIOS Revision 100X

BIOS Model
[CURRENT ] XXX-XX
[test.awd] XXX-XX

Date of BIOS Built
[CURRENT ] 09/25/99
[XXXX.XXXX] 05/29/00

Check sum of 1001.010 is F266.

Are you sure (Y/N) ? [Y]
Block Erasing -- Done
Programming -- 3FFFF
Flashed Successfully

Press ESC To Continue
```

8. Follow the onscreen instructions to continue.

```
ASUS ACPI BIOS
FLASH MEMORY WRITER V1.20
Copyright (C) 1994-99, ASUSTeK COMPUTER INC.

Flash Memory: Winbond W29C020 or SST 29EE020 or Intel 82802AB

Current BIOS Version: ASUS XXX-XX ACPI BIOS Revision 100X
BIOS Model : XXX-XX
BIOS Built Date : 05/29/99

Choose one of the followings:

1. Save Current BIOS To File
2. Update BIOS Including Boot Block and ESCD

Enter choice: [1]

You have flashed the EPROM:It is recommended that you turn off
the power, enter SETUP and LOAD Setup Defaults to have CMOS
updated with new BIOS when exits.

Press ESC To Exit
```

WARNING! If you encounter problems while updating the new BIOS, DO NOT turn off your system since this might prevent your system from booting up. Just repeat the process, and if the problem still persists, update the original BIOS file you saved to disk above. If the Flash Memory Writer utility was not able to successfully update a complete BIOS file, your system may not be able to boot up. If this happens, your system will need servicing.

4. BIOS SETUP

(This page was intentionally left blank.)

4. BIOS SETUP

4.2 BIOS Setup Program

This motherboard supports a programmable EEPROM that can be updated using the provided utility as described in *4.1 Managing and Updating Your BIOS*.

The utility is used if you are installing a motherboard, reconfiguring your system, or prompted to “**Run Setup**”. This section describes how to configure your system using this utility.

Even if you are not prompted to use the Setup program, at some time in the future you may want to change the configuration of your computer. For example, you may want to enable the Security Password Feature or make changes to the power management settings. It will then be necessary to reconfigure your system using the BIOS Setup program so that the computer can recognize these changes and record them in the CMOS RAM of the EEPROM.

The EEPROM on the motherboard stores the Setup utility. When you start up the computer, the system provides you with the opportunity to run this program. This appears during the Power-On Self Test (POST). Press <Delete> to call up the Setup utility. If you are a little bit late in pressing the mentioned key, POST will continue with its test routines, thus preventing you from calling up Setup. If you still need to call Setup, restart the system by pressing <Ctrl> + <Alt> + <Delete>, or by pressing the Reset button on the system chassis. You can also restart by turning the system off and then back on again. But do so only if the first two methods fail.

The Setup program has been designed to make it as easy to use as possible. It is a menu-driven program, which means you can scroll through the various sub-menus and make your selections among the predetermined choices.

To access the BIOS Setup program, press the <Delete> key after the computer has run through its POST.

NOTE: Because the BIOS software is constantly being updated, the following BIOS screens and descriptions are for reference purposes only and may not reflect your BIOS screens exactly.

4. BIOS SETUP

4.2.1 BIOS Menu Bar

The top of the screen has a menu bar with the following selections:

- MAIN** Use this menu to make changes to the basic system configuration.
- ADVANCED** Use this menu to enable and make changes to the advanced features.
- POWER** Use this menu to configure and enable Power Management features.
- BOOT** Use this menu to configure the default system device used to locate and load the Operating System.
- EXIT** Use this menu to exit the current menu or specify how to exit the Setup program.

To access the menu bar items, press the right or left arrow key on the keyboard until the desired item is highlighted.

4.2.2 Legend Bar

At the bottom of the Setup screen you will notice a legend bar. The keys in the legend bar allow you to navigate through the various setup menus. The following table lists the keys found in the legend bar with their corresponding alternates and functions.

Navigation Key(s)	Function Description
<F1> or <Alt + H>	Displays the General Help screen from anywhere in the BIOS Setup
<Esc>	Jumps to the Exit menu or returns to the main menu from a sub-menu
← or → (keypad arrow)	Selects the menu item to the left or right
↑ or ↓ (keypad arrow)	Moves the highlight up or down between fields
- (minus key)	Scrolls backward through the values for the highlighted field
+ (plus key) or spacebar	Scrolls forward through the values for the highlighted field
<Enter>	Brings up a selection menu for the highlighted field
<Home> or <PgUp>	Moves the cursor to the first field
<End> or <PgDn>	Moves the cursor to the last field
<F5>	Resets the current screen to its Setup Defaults
<F10>	Saves changes and exits Setup

4. BIOS SETUP

General Help

In addition to the Item Specific Help window, the BIOS setup program also provides a General Help screen. This screen can be called up from any menu by simply pressing <F1> or the <Alt> + <H> combination. The General Help screen lists the legend keys with their corresponding alternates and functions.

Saving Changes and Exiting the Setup Program

See *4.7 Exit Menu* for detailed information on saving changes and exiting the setup program.

Scroll Bar

When a scroll bar appears to the right of a help window, it indicates that there is more information to be displayed that will not fit in the window. Use <PgUp> and <PgDn> or the up and down arrow keys to scroll through the entire help document. Press <Home> to display the first page, press <End> to go to the last page. To exit the help window, press <Enter> or <Esc>.

Sub-Menu

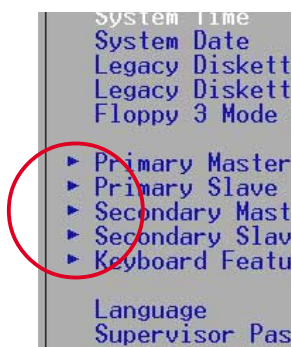

Note that a right pointer symbol (as shown in the left view) appears to the left of certain fields. This pointer indicates that a sub-menu can be launched from this field. A sub-menu contains additional options for a field parameter. To call up a sub-menu, simply move the highlight to the field and press <Enter>. The sub-menu will then immediately appear. Use the legend keys to enter values and move from field to field within a sub-menu just as you would within a menu. Use the <Esc> key to return to the main menu.

Take some time to familiarize yourself with each of the legend keys and their corresponding functions. Practice navigating through the various menus and sub-menus. If you accidentally make unwanted changes to any of the fields, use the set default hot key <F5>. While moving around through the Setup program, note that explanations appear in the Item Specific Help window located to the right of each menu. This window displays the help text for the currently highlighted field.

NOTE: The item heading in square brackets represents the default setting for that field.

4. BIOS SETUP

4.3 Main Menu

When the Setup program is accessed, the following screen appears:

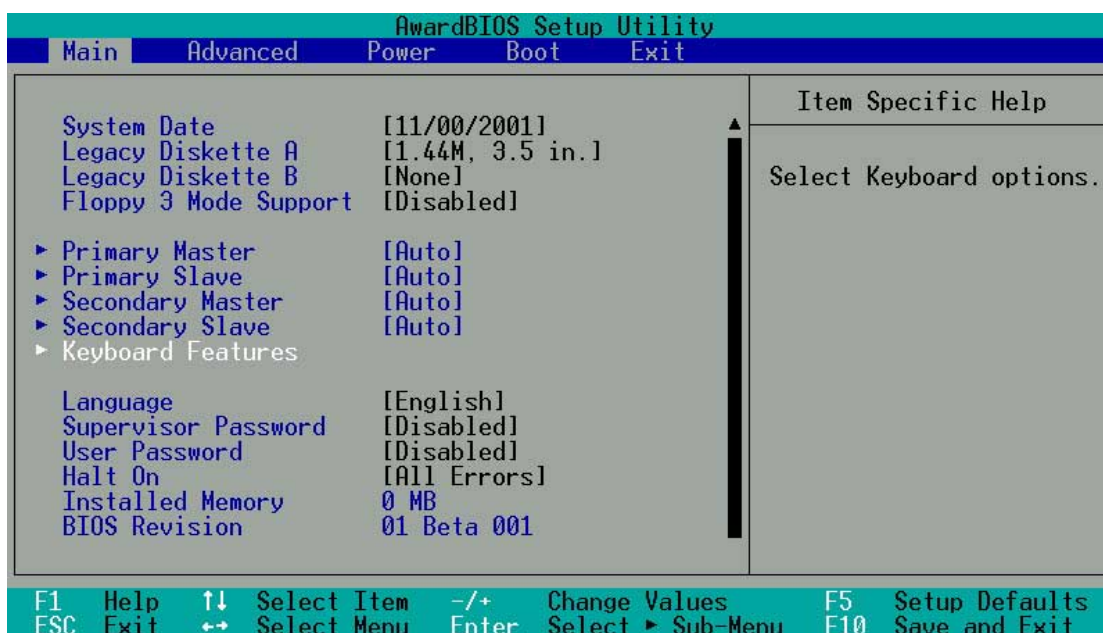

System Time [XX:XX:XX]

Sets your system to the time that you specify (usually the current time). The format is hour, minute, second. Valid values for hour, minute and second are **Hour: (00 to 23)**, **Minute: (00 to 59)**, **Second: (00 to 59)**. Use the <Tab> or <Shift> + <Tab> keys to move between the hour, minute, and second fields.

System Date [XX/XX/XXXX]

Sets your system to the date that you specify (usually the current date). The format is month, day, year. Valid values for month, day, and year are **Month: (1 to 12)**, **Day: (1 to 31)**, **Year: (100 year range)**. Use the <Tab> or <Shift> + <Tab> keys to move between the month, day, and year fields.

Legacy Diskette A [1.44M, 3.5 in.], Legacy Diskette B [None]

Sets the type of floppy drives installed. Configuration options: [None] [360K, 5.25 in.] [1.2M , 5.25 in.] [720K , 3.5 in.] [1.44M, 3.5 in.] [2.88M, 3.5 in.]

Floppy 3 Mode Support [Disabled]

This is required to support older Japanese floppy drives. Floppy 3 Mode support will allow reading and writing of 1.2MB (as opposed to 1.44MB) on a 3.5-inch diskette. Configuration options: [Disabled] [Drive A] [Drive B] [Both]

4. BIOS SETUP

4.3.1 Primary & Secondary Master/Slave

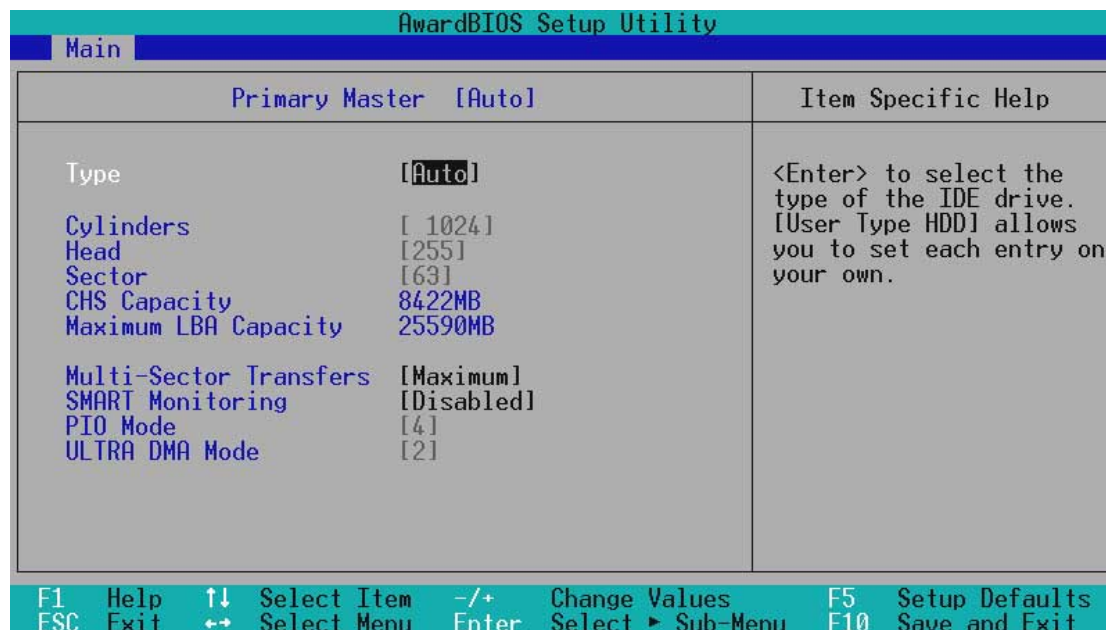

NOTE: Before attempting to configure a hard disk drive, make sure you have the configuration information supplied by the manufacturer of the drive. Incorrect settings may cause your system to not recognize the installed hard disk. To allow the BIOS to detect the drive type automatically, select [Auto].

Type [Auto]

Select [Auto] to automatically detect an IDE hard disk drive. If automatic detection is successful, the correct values will be filled in for the remaining fields on this sub-menu. If automatic detection fails, your hard disk drive may be too old or too new. You can try updating your BIOS or enter the IDE hard disk drive parameters manually.

NOTE: After the IDE hard disk drive information has been entered into BIOS, new IDE hard disk drives must be partitioned (such as with FDISK) and then formatted before data can be read from and write on. Primary IDE hard disk drives must have its partition set to *active* (also possible with FDISK).

Other options for the **Type** field are:

[None] - to disable IDE devices

4. BIOS SETUP

IMPORTANT: If your hard disk was already formatted on an older previous system, incorrect parameters may be detected. You will need to enter the correct parameters manually or use low-level format if you do not need the data stored on the hard disk. If the parameters listed differ from the ones used when the disk was formatted, the disk will not be readable. If the auto-detected parameters do not match the ones that should be used for your disk, you should enter the correct ones manually by setting [User Type HDD].

[User Type HDD]

AwardBIOS Setup Utility		
Main		
Primary Master	[User Type HDD]	Item Specific Help
Type	[User Type HDD]	<Enter> to select the type of the IDE drive. [User Type HDD] allows you to set each entry on your own.
Translation Method	[LBA]	
Cylinders	[1024]	
Head	[255]	
Sector	[63]	
CHS Capacity	8422MB	
Maximum LBA Capacity	25590MB	
Multi-Sector Transfers	[Maximum]	
SMART Monitoring	[Disabled]	
PIO Mode	[4]	
ULTRA DMA Mode	[2]	

F1 Help ↑↓ Select Item -/+ Change Values F5 Setup Defaults
ESC Exit ↔ Select Menu Enter Select ► Sub-Menu F10 Save and Exit

Manually enter the number of cylinders, heads and sectors per track for your drive. Refer to your drive documentation or look on the drive for this information. If no drive is installed or if you are removing a drive and not replacing it, select [None].

Translation Method [LBA]

Select the hard disk drive type in this field. When Logical Block Addressing is enabled, 28-bit addressing of the hard drive is used without regard for cylinders, heads, or sectors. Note that LBA Mode is necessary for drives with greater than 504MB in storage capacity. Configuration options: [LBA] [LARGE] [Normal] [Match Partition Table] [Manual]

Cylinders

This field configures the number of cylinders. Refer to your drive documentation to determine the correct value to enter into this field. **NOTE:** To make changes to this field, the **Type** field must be set to [User Type HDD] and the **Translation Method** field must be set to [Manual].

4. BIOS SETUP

Head

This field configures the number of read/write heads. Refer to your drive documentation to determine the correct value to enter into this field. **NOTE:** To make changes to this field, the **Type** field must be set to [User Type HDD] and the **Translation Method** field must be set to [Manual].

Sector

This field configures the number of sectors per track. Refer to your drive documentation to determine the correct value to enter into this field. **NOTE:** To make changes to this field, the **Type** field must be set to [User Type HDD] and the **Translation Method** field must be set to [Manual].

CHS Capacity

This field shows the drive's maximum CHS capacity calculated automatically by the BIOS from the drive information you entered.

Maximum LBA Capacity

This field shows the drive's maximum LBA capacity calculated automatically by the BIOS from the drive information you entered.

Multi-Sector Transfers [Maximum]

This option automatically sets the number of sectors per block to the highest number supported by the drive. This field can also be configured manually. Note that when this field is automatically configured, the set value may not always be the fastest value for the drive. Refer to the documentation that came with your hard drive to determine the optimal value and set it manually. **NOTE:** To make changes to this field, the **Type** field must be set to [User Type HDD]. Configuration options: [Disabled] [2 Sectors] [4 Sectors] [8 Sectors] [16 Sectors] [32 Sectors] [Maximum]

SMART Monitoring [Disabled]

This allows the enabling or disabling of the S.M.A.R.T. (Self-Monitoring, Analysis and Reporting Technology) system which utilizes internal hard disk drive monitoring technology. This feature is normally disabled because system resources used in this feature may decrease system performance. Configuration options: [Disabled] [Enabled]

PIO Mode [4]

This option lets you set a PIO (Programmed Input/Output) mode for the IDE device. Modes 0 through 4 provide successively increased performance. Configuration options: [0] [1] [2] [3] [4]

Ultra DMA Mode [Disabled]

Ultra DMA capability allows improved transfer speeds and data integrity for compatible IDE devices. Set to [Disabled] to suppress Ultra DMA capability. **NOTE:** To make changes to this field, the **Type** field must be set to [User Type HDD]. Configuration options: [0] [1] [2] [3] [4] [Disabled]

4. BIOS SETUP

Other options for “Type:” are:

[CD-ROM] - for IDE CD-ROM drives

[LS-120] - for LS-120 compatible floppy disk drives

[ZIP-100] - for ZIP-100 compatible disk drives

[MO] - for IDE magneto optical disk drives

[Other ATAPI Device] - for IDE devices not listed here

After using the legend keys to make your selections on this sub-menu, press the <Esc> key to exit back to the Main menu. When the Main menu appears, you will notice that the drive size appear in the field for the hard disk drive that you just configured.

4.3.2 Keyboard Features

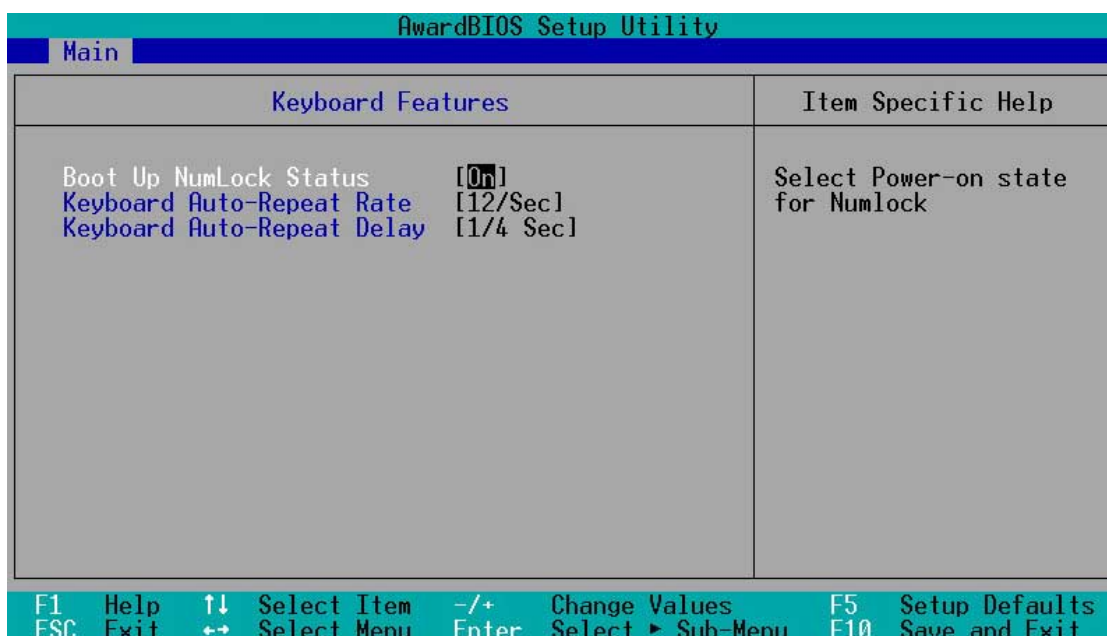

Boot Up NumLock Status [On]

This field enables users to activate the Number Lock function upon system boot. Configuration options: [Off] [On]

Keyboard Auto-Repeat Rate [12/Sec]

This controls the speed at which the system registers repeated keystrokes. Options range from 6 to 30 characters per second. Configuration options: [6/Sec] [8/Sec] [10/Sec] [12/Sec] [15/Sec] [20/Sec] [24/Sec] [30/Sec]

Keyboard Auto-Repeat Delay [1/4 Sec]

This field sets the time interval for displaying the first and second characters. Configuration options: [1/4 Sec] [1/2 Sec] [3/4 Sec] [1 Sec]

4. BIOS SETUP

Language [English]

This allows selection of the BIOS' displayed language. Currently only English is available.

Supervisor Password [Disabled] / User Password [Disabled]

These fields allow you to set the passwords. To set the password, highlight the appropriate field and press <Enter>. Type in a password and press <Enter>. You can type up to eight alphanumeric characters. Symbols and other keys are ignored. To confirm the password, type the password again and press the <Enter>. The password is now set to [Enabled]. This password allows full access to the BIOS Setup menus. To clear the password, highlight this field and press <Enter>. The same dialog box as above will appear. Press <Enter> and the password will be set to [Disabled].

A Note about Passwords

The BIOS Setup program allows you to specify passwords in the Main menu. The passwords control access to the BIOS during system startup. The passwords are not case sensitive. In other words, it makes no difference whether you enter a password using upper or lowercase letters. The BIOS Setup program allows you to specify two separate passwords: a Supervisor password and a User password. When disabled, anyone may access all BIOS Setup program functions. When enabled, the Supervisor password is required for entering the BIOS Setup program and having full access to all configuration fields.

Forgot the Password?

If you forgot the password, you can clear the password by erasing the CMOS Real Time Clock (RTC) RAM. The RAM data containing the password information is powered by the onboard button cell battery. To erase the RTC RAM: (1) Unplug your computer, (2) Short the solder points, (3) Turn ON your computer, (4) Hold down <Delete> during bootup and enter BIOS setup to re-enter user preferences.

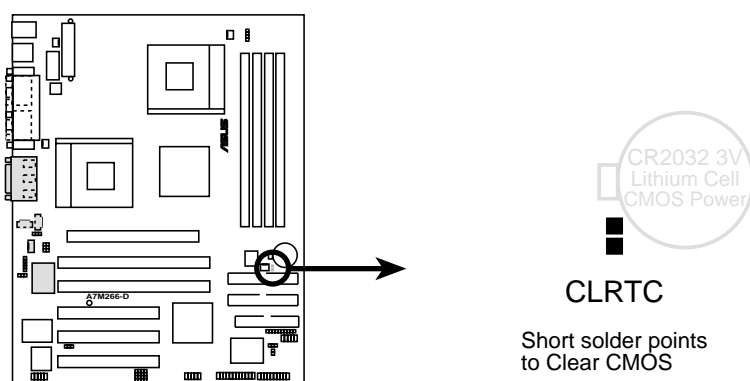

A7M266-D Clear RTC RAM

Halt On [All Errors]

This field determines which types of errors will cause the system to halt. Configuration options: [All Errors] [No Error] [All but Keyboard] [All but Disk] [All but Disk/Keyboard]

Installed Memory [XXX MB]

This display-only field displays the amount of conventional memory detected by the system during bootup. You do not need to make changes to this field.

4. BIOS SETUP

4.4 Advanced Menu

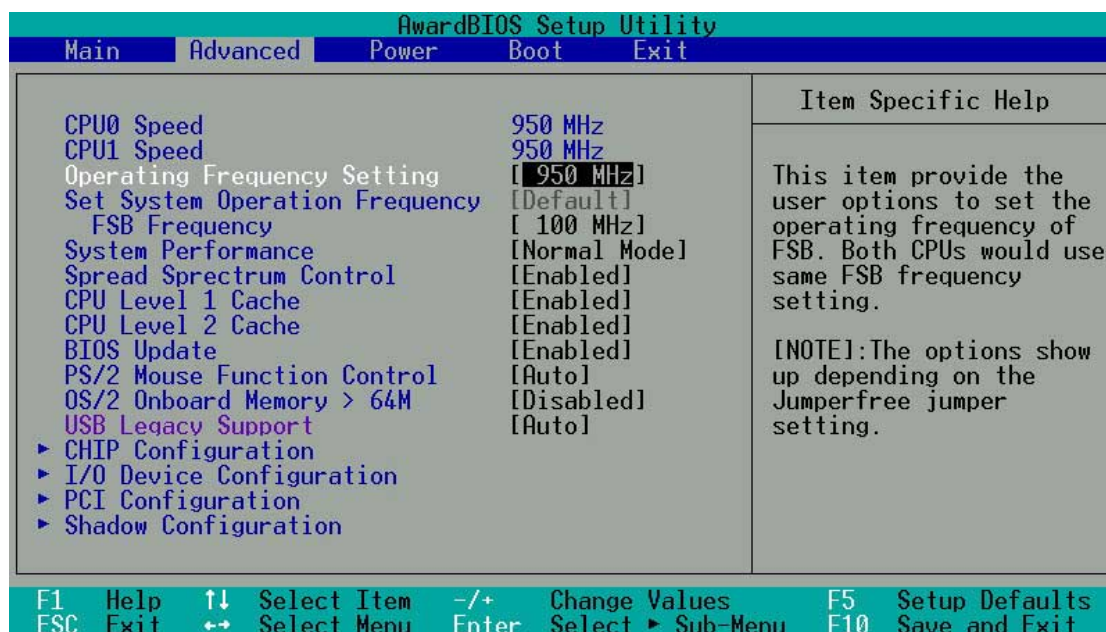

CPU0 / CPU1 Speed

This field displays the frequency of the central processors, CPU0 and CPU1.

Operating Frequency Setting [Manually]

This motherboard is preset for making frequency configurations “By Jumper,” ie.: using DSW switches and jumpers. When the motherboard JEN jumper is reset to enable JumperFree™ mode, then this field allows you to configure the speed of the central processor. The default, [Manually], allows for jumper/DSW FSB frequency settings; if two unlocked CPUs are installed, changing the setting sets the external frequency of *both* CPUs. Configuration options: [Manually] [Various MHz]

Set System Operation Frequency (when Operating Frequency Setting is set to [Default])

When the Operating Frequency Setting is set to [Manually], this field configures the external frequency of the CPU. Select [Manually] to make changes to the **CPU Frequency** field. If [950 MHz] is selected, the **FSB Frequency** will be fixed at 100MHz, and if [1266 MHz] is selected, then the **FSB Frequency** will be fixed at 133MHz. Configuration options: [Default] [-1 MHz] [+1 MHz]

FSB Frequency [100MHz] (Display only)

This field displays the frequency to send to the system bus and PCI bus. The bus frequency (external frequency) multiplied by the bus multiple equals the CPU speed (the CPU’s internal frequency). If a faster Operating Frequency is selected, the FSB automatically increases. Selecting frequencies higher than recommended for the processor may cause the system to hang or crash. Display options: [100 MHz] [133 MHz]

4. BIOS SETUP

System Performance [Normal Mode]

The default setting, [Normal Mode], seeks to balance optimal performance with system stability. To optimize the performance of motherboard circuits and the CPU, changing the setting to [Turbo Mode] tells the clock generator to increase the frequency to the DDR RAM memory system. Configuration options: [Normal Mode] [Turbo Mode]

Spread Spectrum Control [Enabled]

Leave on default setting. Spread spectrum typically reduces system electromagnetic interference (EMI) by 8dB to 10dB.

CPU Level 1 Cache, CPU Level 2 Cache [Enabled]

These fields allow you to choose from the default of [Enabled] or choose [Disabled] to turn on or off the CPU's Level 1 and Level 2 built-in cache. Configuration options: [Disabled] [Enabled]

BIOS Update [Enabled]

This functions as an update loader integrated into the BIOS to supply the processor with the required data. In the default position of [Enabled], the BIOS will load the update on all processors during system bootup. Configuration options: [Disabled] [Enabled]

PS/2 Mouse Function Control [Auto]

The default of [Auto] allows the system to detect a PS/2 mouse on startup. If detected, IRQ12 will be used for the PS/2 mouse. IRQ12 will be reserved for expansion cards only if a PS/2 mouse is not detected. [Enabled] will always reserve IRQ12, whether on startup a PS/2 mouse is detected or not. Configuration options: [Enabled] [Auto]

USB Legacy Support [Auto]

This motherboard supports Universal Serial Bus (USB) devices. The default of [Auto] allows the system to detect a USB device at startup. If detected, the USB controller legacy mode is enabled. If not detected, the USB controller legacy mode is disabled. When you set this field to [Disabled], the USB controller legacy mode is disabled whether or not you are using a USB device. Configuration options: [Disabled] [Enabled] [Auto]

OS/2 Onboard Memory > 64M [Disabled]

When using OS/2 operating systems with installed DRAM of greater than 64MB, you need to set this option to [Enabled]; otherwise, leave this on [Disabled]. Configuration options: [Disabled] [Enabled]

4. BIOS SETUP

Notes for JumperFree Mode System Hangup

If your system crashes or hangs due to improper frequency settings, power OFF your system and restart. The system will start up in safe mode running at a bus speed of 100MHz. You will then be led to BIOS setup to adjust the configurations.

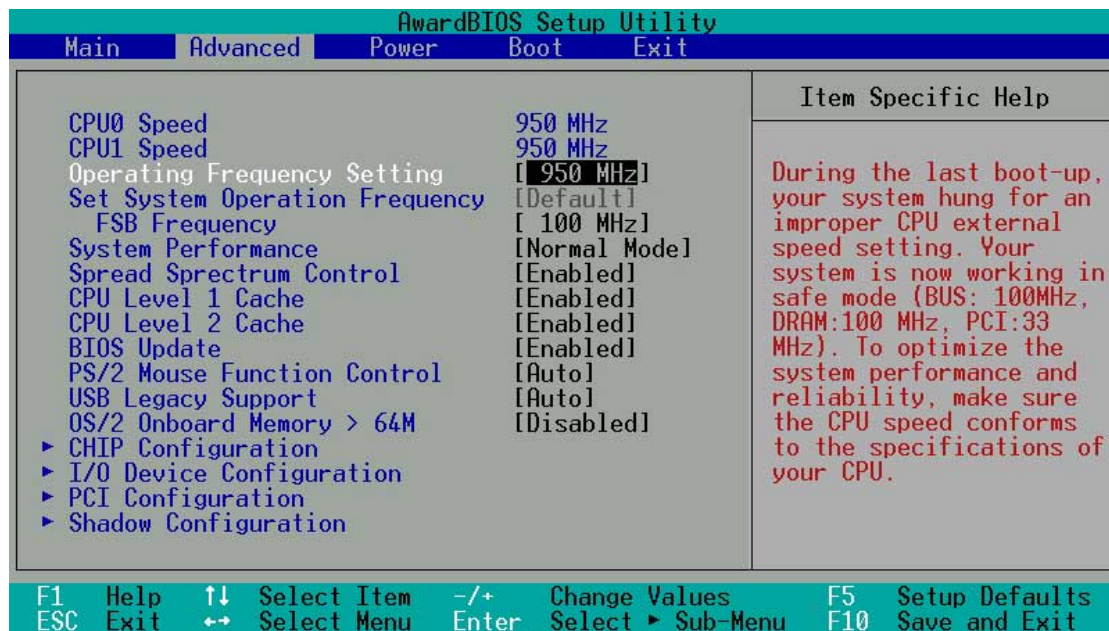

NOTE: To achieve more stable performance and precise frequencies, *JumperFree Mode* should not be selected with this version of the A7M266-D.

4. BIOS SETUP

4.4.1 Chip Configuration



SDRAM Configuration [By SPD]

This sets the optimal timings for SDRAM related fields, depending on the memory modules that you are using. Default setting is [By SPD], which configures the subsequent 3 items by reading the contents in the SPD (Serial Presence Detect) device. The EEPROM on the memory module stores critical parameter information about the module, such as memory type, size, speed, voltage interface, and module banks. Configuration options: [By SPD][User Define]

SDRAM CAS Latency

This controls the latency between the SDRAM read command and the time that the data actually becomes available. **NOTE:** This field will only be adjustable when **SDRAM Configuration** is set to [User Define].

SDRAM RAS Precharge Time

This controls the idle clocks after issuing a precharge command to the SDRAM. **NOTE:** This field will only be adjustable when **SDRAM Configuration** is set to [User Define].

SDRAM RAS to CAS Delay

This controls the latency between the SDRAM active command and the read/write command. **NOTE:** This field will only be adjustable when **SDRAM Configuration** is set to [User Define].

AGP 4X Supported [Enabled]

This feature allows the CPU to write directly to the AGP card for up to 30% performance gain over standard AGP 4X mode. Configuration options: [Enabled] [Disabled]

4. BIOS SETUP

AGP Fast Write [Disabled]

Configuration options: [Enabled] [Disabled]

AGP Compensation [Bypass]

Configuration options: [Bypass] [Auto]

AGP Signal Driving [Auto]

Configuration options: [Auto] [Manual]

Graphics Aperture Size [32MB]

This feature allows you to select the size of mapped memory for AGP graphic data. Configuration options: [32MB] [64MB] [128MB] [256MB] [512MB]

Video Memory Cache Mode [UC]

USWC (uncacheable, speculative write combining) is a new cache technology for the video memory of the processor. It can greatly improve the display speed by caching the display data. You must set this to UC (uncacheable) if your display card cannot support this feature; otherwise your system may not boot. Configuration options: [UC] [USWC]

Software DDR PDL Delay [Auto]

Configuration options: [Auto] [Manual]

Delayed Transaction [Disabled]

Leave on default setting. [Enabled] frees the PCI Bus when the CPU is accessing 8-bit ISA devices that normally consume about 50-60 PCI Clocks without PCI delayed transaction. Select [Disabled] for ISA devices that are not PCI 2.1 compliant. Configuration options: [Disabled] [Enabled]

PCI to DRAM Prefetch [Disabled]

Configuration options: [Disabled] [Enabled]

AGP to DRAM Prefetch [Enabled]

Configuration options: [Disabled] [Enabled]

S2K Slew Rate Control [3]

Configuration options: [0, 1, 2, 3, 4, 5, 6, 7]

Onboard PCI IDE Enable [Both]

You can select to enable the primary IDE channel, secondary IDE channel, both, or disable both channels. Configuration options: [Both] [Primary] [Secondary] [Disabled]

4. BIOS SETUP

4.4.2 I/O Device Configuration

AwardBIOS Setup Utility		
Advanced		
I/O Device Configuration	Item Specific Help	
Onboard FDC Swap A & B: [No Swap] Floppy Disk Access Control [R/W]	<Enter> to select if switch drive letter assignments or not.	
Onboard Serial Port 1: [3F8H/IRQ4] Onboard Serial Port 2: [2F8H/IRQ3] UART2 Use Infrared: [Disabled]		
Onboard Parallel Port: [378H/IRQ7] Parallel Port Mode: [ECP+EPP] ECP DMA Select: [3]		
I-Panel Hot Key Mapping [Group 1] I-Panel Update Timer [Disable]		
F1 Help ↑↓ Select Item -/+ Change Values F5 Setup Defaults ESC Exit ↔ Select Menu Enter Select ▶ Sub-Menu F10 Save and Exit		

Onboard FDC Swap A & B [No Swap]

This field allows you to reverse the hardware drive letter assignments of your floppy disk drives. Configuration options: [No Swap] [Swap AB]

Floppy Disk Access Control [R/W]

Set this field to read and write the floppy disk (R/W). Change to [Read Only] for reading disks.

Onboard Serial Port 1 [3F8H/IRQ4]

Onboard Serial Port 2 [2F8H/IRQ3]

These fields allow you to set the addresses for the onboard serial connectors. Serial Port 1 and Serial Port 2 must have different addresses. Configuration options: [3F8H/IRQ4] [2F8H/IRQ3] [3E8H/IRQ4] [2E8H/IRQ10] [Disabled]

UART2 Use Infrared [Disabled]

When enabled, this field activates the onboard standard infrared feature and sets the second serial UART to support the infrared module connector on the motherboard. If your system already has a second serial port connected to the onboard COM2 connector, it will no longer work if you enable the infrared feature. See **Standard and Consumer Infrared Module Connector** in *3.8 External Connectors*. Configuration options: [Disabled] [Enabled]

Onboard Parallel Port [378H/IRQ7]

This field sets the address of the onboard parallel port connector. If you disable this feature, **Parallel Port Mode** and **ECP DMA Select** configurations will not be available. Configuration options: [Disabled] [378H/IRQ7] [278H/IRQ5]

4. BIOS SETUP

Parallel Port Mode [ECP+EPP]

This field allows you to set the operation mode of the parallel port. [Normal] allows normal-speed operation but in one direction only; [EPP] allows bidirectional parallel port operation; [ECP] allows the parallel port to operate in bidirectional DMA mode; [ECP+EPP] allows normal speed operation in a two-way mode. Configuration options: [Normal] [ECP] [EPP] [ECP+EPP]

ECP DMA Select [3]

This field allows you to configure the parallel port DMA channel for the selected **ECP** mode. This selection is available only if you select [ECP] or [ECP+EPP] in **Parallel Port Mode** above. Configuration options: [1] [3]

I-Panel Hot Key Mapping [Group 1]

If installing an optional I-Panel, then you must install Configuration options: [Group 1] [Group 2] [Group 3] [Group 4]

I-Panel Update Timer [Disabled]

Configuration options: [Disabled] [8 seconds] [16 Seconds] [32 Seconds]

4.4.3 PCI Configuration

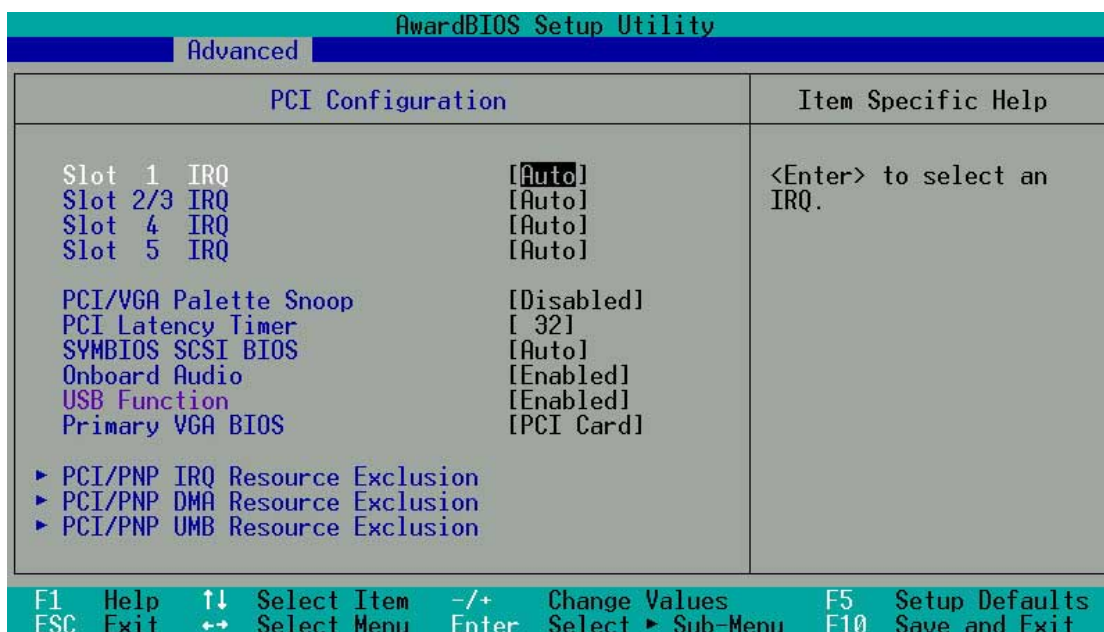

Slot 1, Slot 2/3, Slot 4, Slot 5 IRQ [Auto]

These fields set how IRQ use is determined for each PCI slot. The default setting for each field is [Auto], which utilizes auto-routing to determine IRQ use. Configuration options: [Auto] [NA] [3] [4] [5] [7] [9] [10] [11] [12] [14] [15]

4. BIOS SETUP

PCI/VGA Palette Snoop [Disabled]

Some nonstandard VGA cards, such as graphics accelerators or MPEG video cards, may not show colors properly. The setting [Enabled] should correct this problem. Otherwise, leave this on the default setting of [Disabled]. Configuration options: [Disabled] [Enabled]

PCI Latency Timer [32]

Leave on default setting for best performance vs. stability.

SYMBIOS SCSI BIOS [Auto]

[Auto] allows the motherboard's BIOS to detect whether you have a Symbios SCSI card. If the Symbios SCSI card is detected, the motherboard's Symbios BIOS will be enabled; if no Symbios SCSI card is detected, the onboard Symbios SCSI BIOS will be disabled.

[Disabled] will disable the motherboard's Symbios SCSI BIOS so that the BIOS on an add-on Symbios SCSI card can be used. If your Symbios SCSI card does not have a BIOS, the Symbios SCSI card will not function. Configuration options: [Auto] [Disabled]

Onboard Audio [Enabled]

This control enables or disables the onboard audio function. Configuration options: [Enabled] [Disabled]

USB Function [Enabled]

This motherboard supports Universal Serial Bus (USB) devices. Keep the default setting [Enabled] to connect USB devices. Select the setting [Disabled] if you do not wish to use the USB feature. Configuration options: [Enabled] [Disabled]

Primary VGA BIOS [PCI Card]

If your computer has both PCI and AGP VGA cards, this field allows you to select which of the cards will act as your primary graphics card. [AGP Card] uses the AGP card as your primary card. The default, [PCI Card], allows your PCI graphics card to take precedence when detected. Configuration options: [PCI Card] [AGP Card]

4. BIOS SETUP

PCI/PNP IRQ Resource Exclusion

AwardBIOS Setup Utility	
Advanced	
PCI/PNP IRQ Resource Exclusion	Item Specific Help
IRQ 3 Reserved for Legacy Device [No/ICU]	Select [Yes] if this IRQ is required by a legacy add-on card and you are not using ICU; otherwise, select [No/ICU].
IRQ 4 Reserved for Legacy Device [No/ICU]	
IRQ 5 Reserved for Legacy Device [No/ICU]	
IRQ 7 Reserved for Legacy Device [No/ICU]	
IRQ 9 Reserved for Legacy Device [No/ICU]	
IRQ 10 Reserved for Legacy Device [No/ICU]	
IRQ 11 Reserved for Legacy Device [No/ICU]	
IRQ 12 Reserved for Legacy Device [No/ICU]	
IRQ 14 Reserved for Legacy Device [No/ICU]	
IRQ 15 Reserved for Legacy Device [No/ICU]	

IRQ XX Reserved for Legacy Device [No/ICU]

These fields indicate whether or not the displayed IRQ for each field is being used by an onboard legacy (non-PnP) ISA device. The default value indicates either that the displayed IRQ is not used or that ISA Configuration Utility (ICU) is being used to determine if an ISA device is using that IRQ. Configuration options: [No/ICU] [Yes]

PCI/PNP DMA Resource Exclusion

AwardBIOS Setup Utility	
Advanced	
PCI/PNP DMA Resource Exclusion	Item Specific Help
DMA 1 Reserved for Legacy Device [No/ICU]	Select [Yes] if this DMA channel is required by a legacy add-on card and you are not using ICU; otherwise, select [No/ICU].
DMA 3 Reserved for Legacy Device [No/ICU]	
DMA 5 Reserved for Legacy Device [No/ICU]	

DMA x Reserved for Legacy Device [No/ICU]

These fields indicate whether or not the displayed DMA channel for each field is being used by an onboard legacy (non-PnP) ISA device. The default setting indicates either that the displayed DMA channel is not used or an ICU is being used to determine if an ISA device is using that channel. Configuration options: [No/ICU] [Yes]

4. BIOS SETUP

PCI/PNP UMB Resource Exclusion

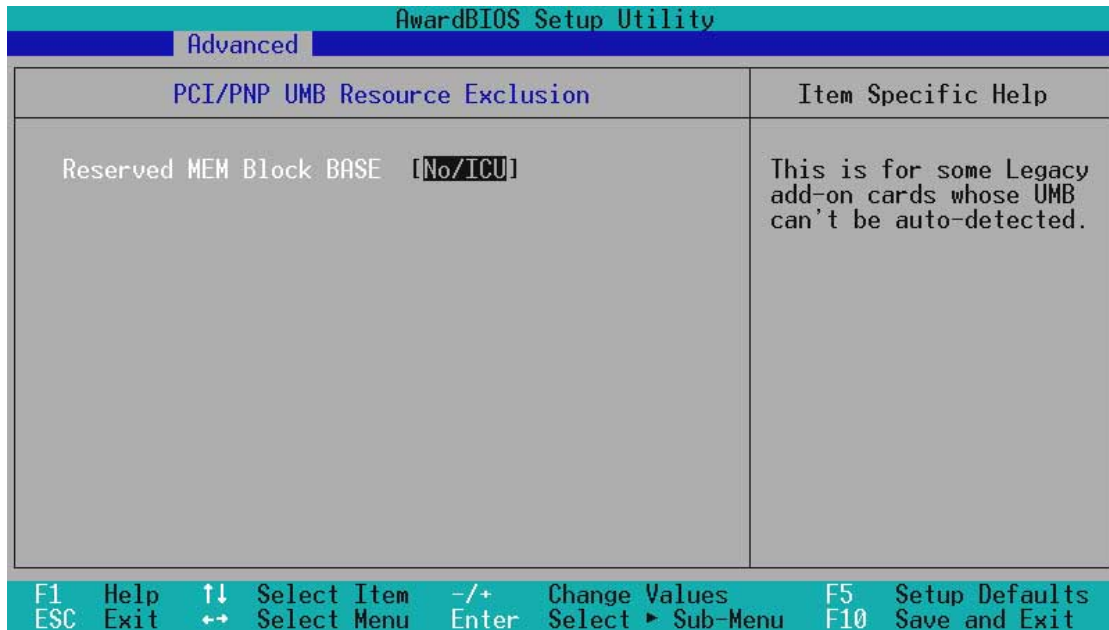

Reserved MEM Block BASE [No/ICU]

This field allows you to set the base address and block size of an onboard legacy ISA device that uses any memory segment within the C800 and DFFF address range. If you have such a device and you are not using an ICU to specify its address range, select a base address from the six available options; the **Reserved MEM Block SIZE** field will then appear for selecting the block size. If you have more than one legacy ISA device onboard that requires the use of this address range, you can increase the block size to 8K, 16K, 32K, or 64K. If you are using an ICU to accomplish this task, leave **Reserved MEM Block BASE** to its default setting of [No/ICU]. Configuration options: [No/ICU] [C800] [CC00] [D000] [D400] [D800] [DC00]

4. BIOS SETUP

4.4.4 Shadow Configuration

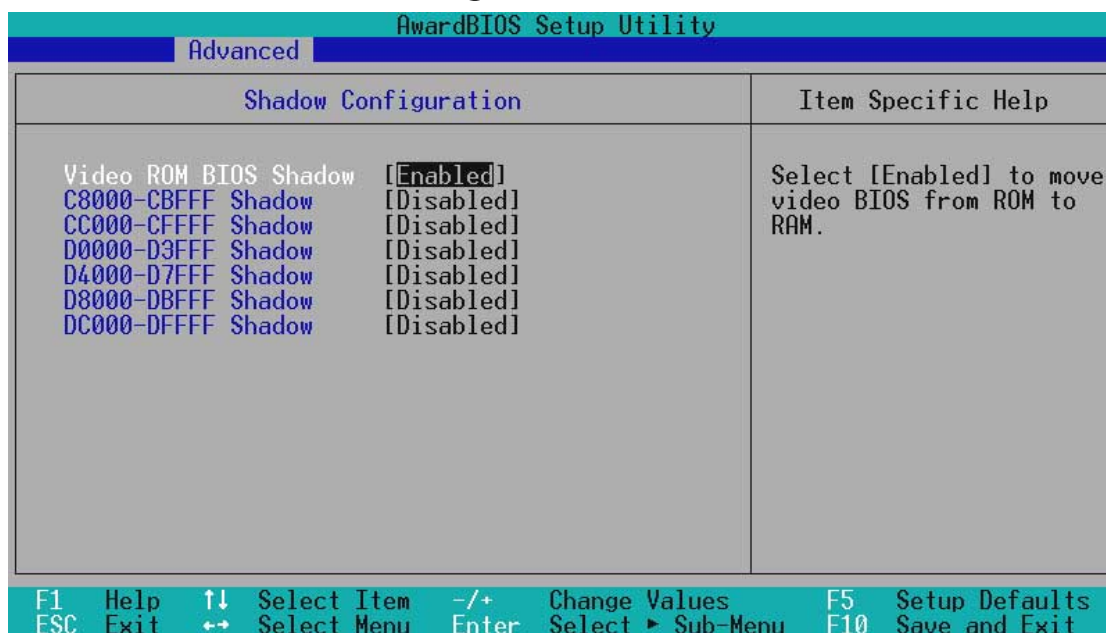

Video ROM BIOS Shadow [Enabled]

This field allows you to change the video BIOS location from ROM to RAM. Relocating to RAM enhances system performance, as information access is faster than the ROM. Configuration options: [Disabled] [Enabled]

C8000-DFFFF Shadow [Disabled]

These fields are used for shadowing other expansion card ROMs. If you install other expansion cards with ROMs on them, you will need to know which addresses the ROMs use to shadow them specifically. Shadowing a ROM reduces the memory available between 640K and 1024K by the amount used for this purpose. Configuration options: [Disabled] [Enabled]

4. BIOS SETUP

4.5 Power Menu

The Power menu allows you to reduce power consumption. This feature turns off the video display and shuts down the hard disk after a period of inactivity.

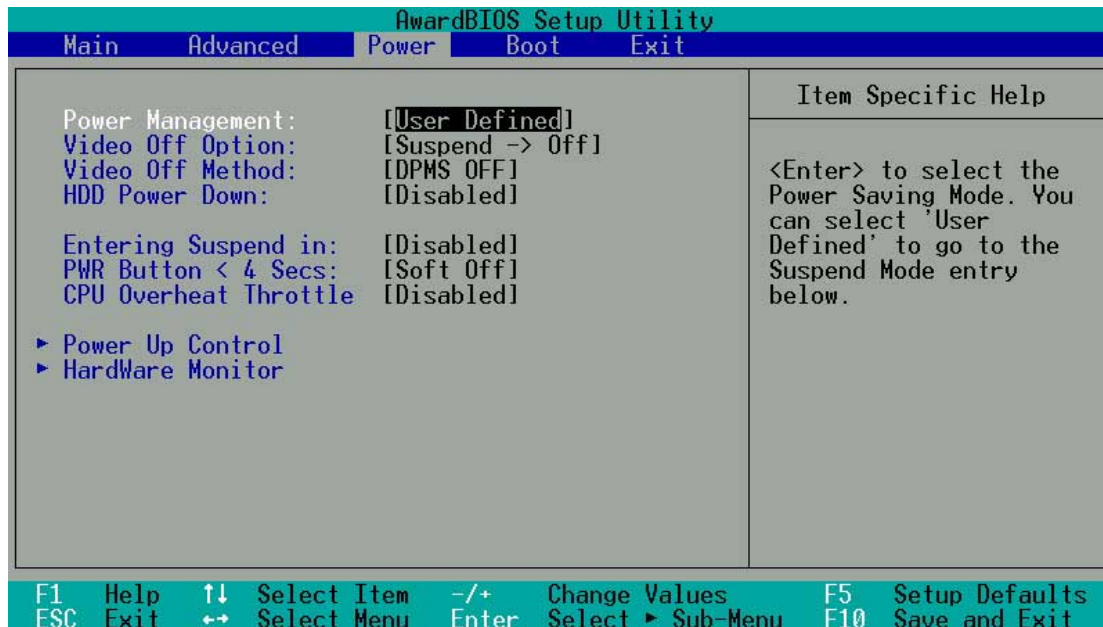

Power Management [User Define]

This option must be enabled to use any of the automatic power saving features. If this menu item is set to [Disabled], power management features will not function regardless of other field settings on this menu. The [User Define] option allows you to make your own selections in the Power menu. When set to [Max Saving], system power will be conserved to its greatest amount. The **Suspend Mode** field will then be set to predefined value that ensures maximum power savings.

This field acts as the master control for the power management modes. [Max Saving] puts the system into power saving mode after a brief period of system inactivity; [Min Saving] is almost the same as [Max Saving] except that the system inactivity period is longer; [Disabled] disables the power saving features; [User Define] allows you to set power saving options according to your preference. Configuration options: [User Define] [Disabled] [Min Saving] [Max Saving]

IMPORTANT: Advanced Power Management (APM) should be installed to keep the system time updated when the computer enters suspend mode activated by the BIOS Power Management. For DOS environments, you need to add the statement, DEVICE=C:\DOS\POWER.EXE, to your CONFIG.SYS file. For Windows 3.x and Windows 95, you need to install Windows with the APM feature. For Windows 98 and later, APM is automatically installed. A battery and power cord icon labeled “Power Management” will appear in the “Control Panel.” Choose “Advanced” in the Power Management Properties dialog box.

4. BIOS SETUP

Video Off Option [Suspend -> Off]

This field determines when to activate the video off feature for monitor power management. Configuration options: [Always On] [Suspend -> Off]

Video Off Method [DPMS OFF]

This field defines the video off features. The DPMS (Display Power Management System) feature allows the BIOS to control the video display card if it supports the DPMS feature. [Blank Screen] only blanks the screen (use this for monitors without power management or “green” features. If set up in your system, your screen saver will not display with [Blank Screen] selected). [V/H SYNC+Blank] blanks the screen and turns off vertical and horizontal scanning. Configuration options: [Blank Screen] [V/H SYNC+Blank] [DPMS Standby] [DPMS Suspend] [DPMS OFF] [DPMS Reduce ON]

HDD Power Down [Disabled]

Shuts down any IDE hard disk drives in the system after a period of inactivity as set in this user-configurable field. This feature does not affect SCSI hard drives. Configuration options: [Disabled] [1 Min] [2 Min] [3 Min]...[15 Min]

Entering Suspend in [Disabled]

Sets the time period before the system goes into suspend mode. Configuration options: [Disabled] [30 Sec] [1 Min]... [1 Hour]

PWR Button < 4 Secs [Soft Off]

When set to [Soft off], the ATX switch can be used as a normal system power-off button when pressed for less than 4 seconds. [Suspend] allows the button to have a dual function where pressing less than 4 seconds will place the system in sleep mode. Regardless of the setting, holding the ATX switch for more than 4 seconds will power off the system. Configuration options: [Soft off] [Suspend]

CPU Overheat Throttle [Disabled]

This feature helps to prolong the life of the CPU and motherboard by monitoring the temperature of the CPU; if overheating occurs, the CPU is throttle down or shuts off completely. Configuration options: [Enabled] [Disabled]

4. BIOS SETUP

4.5.1 Power Up Control

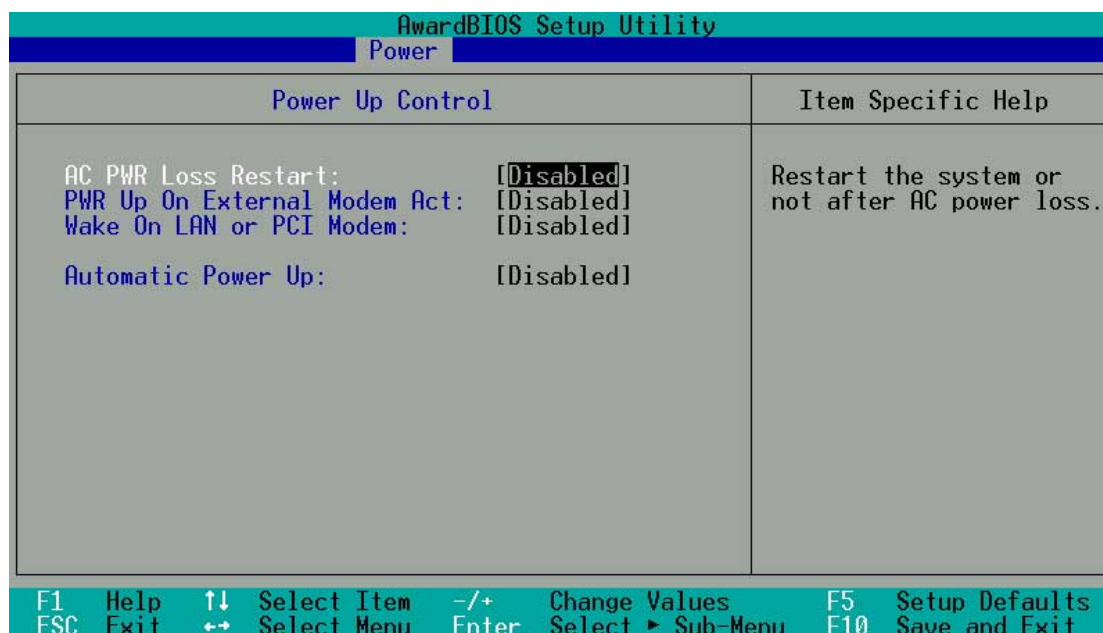

AC PWR Loss Restart [Disabled]

This allows you to set whether you want your system to reboot after the power has been interrupted. [Disabled] leaves your system off and [Enabled] reboots your system. [Previous State] sets your system back to the state it is before the power interruption. Configuration options: [Disabled] [Enabled] [Previous State]

PWR Up On External Modem Act [Disabled]

This allows either settings of [Enabled] or [Disabled] for powering up the computer when the external modem receives a call while the computer is in Soft-off mode. **NOTE:** The computer cannot receive or transmit data until the computer and applications are fully running. Thus connection cannot be made on the first try. Turning an external modem off and then back on while the computer is off causes an initialization string that will also cause the system to power on. Configuration options: [Disabled] [Enabled]

Wake On LAN or PCI Modem [Disabled]

Wake-On-LAN/PCI Modem allows your computer to be booted from another computer via a network by sending a wake-up frame or signal. Configuration options: [Disabled] [Enabled]

IMPORTANT: This feature requires an optional network interface card with Wake-On-LAN and an ATX power supply with at least 720mA +5V standby power.

4. BIOS SETUP

Automatic Power Up [Disabled]

This allows an unattended or automatic system power up. You may configure your system to power up at a certain time of the day by selecting [Everyday] or at a certain time and day by selecting [By Date]. **NOTE:** *Automatic Power Up* will not work if the system is powered down by operating systems, such as Windows 98, that have ACPI support enabled. Configuration options: [Disabled] [Everyday] [By Date]

4. BIOS SETUP

4.5.2 Hardware Monitor

AwardBIOS Setup Utility		
Power		
Hardware Monitor	Item Specific Help	
MB Temperature: 33°C/91°F	<Enter> to switch between Monitoring or Ignore.	
CPU0 Temperature: 51°C/123°F		
CPU1 Temperature: 51°C/123°F		
CPU0 Fan Speed 7500RPM		
CPU1 Fan Speed 7670RPM		
Chassis Fan Speed N/A		
VCORE 0 Voltage: 1.52V		
VCORE 1 Voltage: 1.52V		
+3.3V Voltage: 3.33V		
+5V Voltage: 5.00V		
+12V Voltage: 12.00V		
F1 Help ↑↓ Select Item -/+ Change Values F5 Setup Defaults		
ESC Exit ↔ Select Menu Enter Select ► Sub-Menu F10 Save and Exit		

MB Temperature [xxx°C/xxxF]

CPU0 Temperature [xxx°C/xxxF]

CPU1 Temperature [xxx°C/xxxF]

The onboard hardware monitor is able to detect the MB (motherboard), CPU and power supply temperatures. Set to [Ignore] only if necessary.

CPU0 Fan Speed [xxxxRPM]

CPU1 Fan Speed [xxxxRPM]

Chassis Fan Speed [xxxxRPM]

The onboard hardware monitor is able to detect the CPU fan speed, power supply fan speed, and the chassis fan speed in rotations per minute (RPM). The presence of the fans is automatically detected. Set to [Ignore] only if necessary.

VCORE0 Voltage, VCORE1 Voltage, +3.3V Voltage, +5V Voltage, +12V Voltage

The onboard hardware monitor is able to detect the voltage output by the onboard voltage regulators. Set to [Ignore] only if necessary.

NOTE: If any of the monitored items is out of range, an error message will appear: “Hardware Monitor found an error. Enter Power setup menu for details”. You will then be prompted to “Press **F1** to continue, **DEL** to enter SETUP”.

4. BIOS SETUP

4.6 Boot Menu

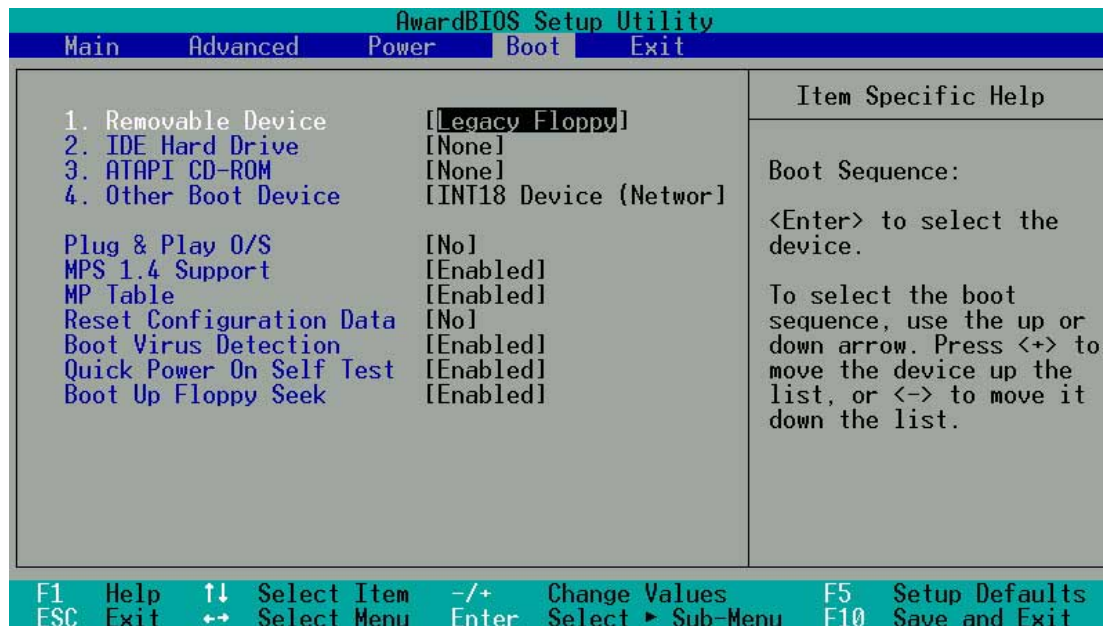

Boot Sequence

The Boot menu allows you to select among the four possible types of boot devices listed using the up and down arrow keys. By using the <+> or <Space> key, you can promote devices and by using the <-> key, you can demote devices. Promotion or demotion of devices alters the priority which the system uses to search for a boot device on system power up. Configuration fields include **Removable Devices**, **IDE Hard Drive**, **ATAPI CD-ROM**, and **Other Boot Device**.

Removable Device [Legacy Floppy]

Configuration options: [Disabled] [Legacy Floppy] [LS120] [ZIP-100] [ATAPI MO] [USB FDD] [USB ZIP]

IDE Hard Drive

This field allows you to select which IDE hard disk drive to use in the boot sequence. Pressing [Enter] will show the product IDs of all connected IDE hard disk drives.

ATAPI CD-ROM

This field allows you to select which ATAPI CD-ROM drive to use in the boot sequence. Pressing [Enter] will show the product IDs of all your connected ATAPI CD-ROM drives.

4. BIOS SETUP

Other Boot Device Select [INT18 Device (Network)]

Configuration options: [Disabled] [SCSI/Onboard ATA Boot Device] [INT18 Device (Network)] [LANDesk (R) Service Agent]

Plug & Play O/S [No]

This field allows you to use a Plug-and-Play (PnP) operating system to configure the PCI bus slots instead of using the BIOS. When [Yes] is selected, interrupts may be reassigned by the OS. When a non-PnP OS is installed or you want to prevent reassigning of interrupt settings, select the default setting of [No]. Configuration options: [No] [Yes]

MPS 1.4 Support [Enabled]

Configuration options: [Disabled] [Enabled]

MP Table [Enabled]

Configuration options: [Disabled] [Enabled]

Reset Configuration Data [No]

The Extended System Configuration Data (ESCD) contain information about non-PnP devices. It can also hold the complete record of how the system was configured the last time it was booted. Select [Yes] only if you want to clear these data during the Power-On Self Test (POST). Configuration options: [No] [Yes]

Boot Virus Detection [Enabled]

This field allows you to set boot virus detection, ensuring a virus-free boot sector. The system halts and displays a warning message when it detects a virus. If this occurs, you can either allow the operation to continue or use a virus-free bootable floppy disk to restart and investigate your system. Configuration options: [Disabled] [Enabled]

Quick Power On Self Test [Enabled]

This field speeds up the Power-On-Self Test (POST) routine by skipping retesting a second, third, and fourth time. Configuration options: [Disabled] [Enabled]

Boot Up Floppy Seek [Enabled]

When enabled, the BIOS will seek the floppy disk drive to determine whether the drive has 40 or 80 tracks. Configuration options: [Disabled] [Enabled]

4. BIOS SETUP

4.7 Exit Menu

Once you have made all of your selections from the various menus in the Setup program, you should save your changes and exit Setup. Select **Exit** from the menu bar to display the following menu:

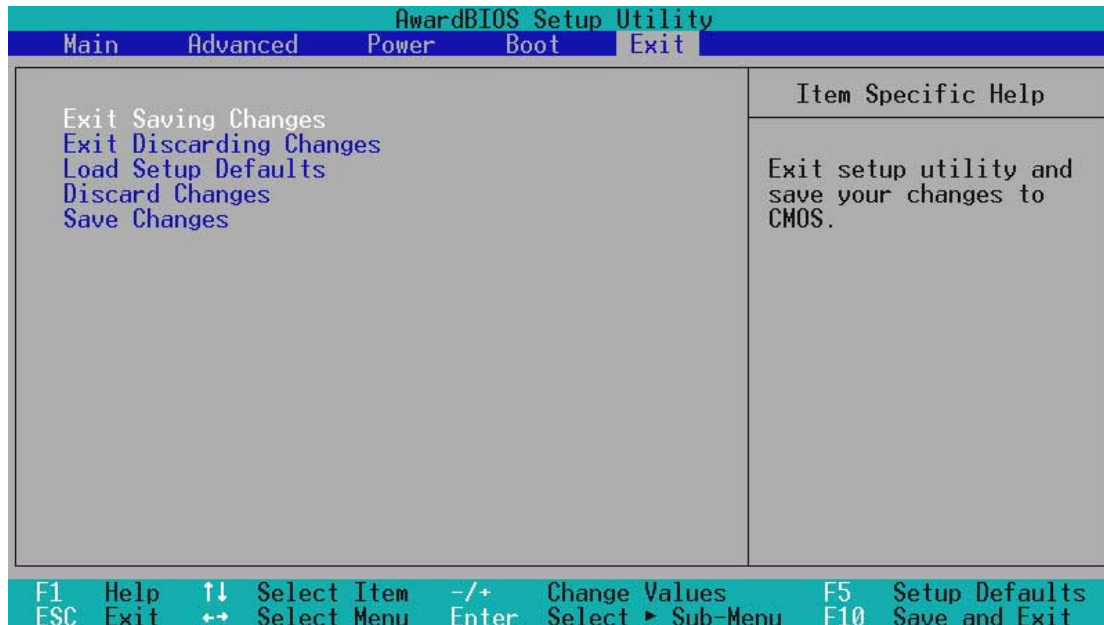

NOTE: Pressing <Esc> does not exit this menu. You must select one of the options from this menu or <F10> from the legend bar to exit this menu.

Exit Saving Changes

Once you are finished making your selections, choose this option from the Exit menu to ensure the values you selected are saved to the CMOS RAM. The CMOS RAM is sustained by an onboard backup battery and stays on even when the PC is turned off. Once this option is selected, a confirmation is asked. Select [Yes] to save changes and exit.

NOTE: If you attempt to exit the Setup program without saving your changes, the program will prompt you with a message asking if you want to save your changes before exiting. Pressing <Enter> will then save changes while exiting.

Exit Discarding Changes

This option should only be used if you do not want to save the changes you have made to the Setup program. If you have made changes to fields other than system date, system time, and password, the system will ask for confirmation before exiting.

4. BIOS SETUP

Load Setup Defaults

This option allows you to load the default values for each of the parameters on the Setup menus. When this option is selected or if <F5> is pressed, a confirmation is requested. Select [Yes] to load default values. You can now select **Exit Saving Changes** or make other changes before saving the values to the non-volatile RAM.

Discard Changes

This option allows you to discard the selections you made and restore the values you previously saved. After selecting this option, a confirmation is requested. Select [Yes] to discard any changes and load the previously saved values.

Save Changes

This option saves your selections without exiting the Setup program. You can then return to other menus and make changes. After selecting this option, all selections are saved and a confirmation is requested. Select [Yes] to save any changes to the non-volatile RAM.

(This page was intentionally left blank.)

5. SOFTWARE SETUP

5.1 Install Operating System

You should always use the latest operating system and updates when using new hardware to ensure full compliancy. You may use any version of Windows 98/2000/Millennium, but for Windows 95, you must use OSR 2.0 or later. For Windows NT 4.0, you must use Service Pack 3.0 or later.

5.2 Start Windows

When you start Windows 98 for the first time after installing your motherboard, Windows will detect all plug-and-play devices. Follow the Add New Hardware Wizard to install all necessary device drivers. When prompted to restart, select **No** and then follow the setup procedures in this section.

NOTE: Because there are various motherboard settings, options, and expansion cards, the following can only be used as a general reference and may not reflect exactly the screen contents displayed on your screen.

5.3 A7M266-D Series Support CD

NOTE: The support CD contents are subject to change at any time without notice.

To begin using your support CD disc, just insert it into your CD-ROM drive and the support CD installation menu should appear. If the menu does not appear, double-click or run **D:\ASSETUP.EXE** (assuming that your CD-ROM drive is drive **D:**).

5.3.1 Installation Menu



- **AMD Bus Master IDE Driver:** Installs Bus Master PCI IDE Driver.
- **AMD IRQ Driver:** Installs the necessary IRQ drivers.
- **AMD Windows Power Management INF Driver:** Installs the INF driver for managing PC system resources.
- **C-Media PCI Audio Driver and Application:** Installs drivers and software applications for the multi-channel PC sound system to support the C-Media Audio Chip and 3D Audio circuitry.
- **AMD Miniport Driver:** Installs the necessary AGP miniport drivers to resolve AGP problems.
- **ASUS PC Probe:** Installs a smart utility to monitor your computer's fan, temperature, and voltages.
- **ASUS Update:** Installs the ASUS BIOS flash utility.
- **Microsoft DirectX Driver:** Installs basic drivers to enable compatibility with audi, visual and other special functions.
- **PC-CILLIN 2000:** Installs the latest anti-virus protection application.
- **ADOBE Acrobat Reader:** Installs the Adobe Acrobat Reader software necessary to view user's manuals saved in PDF format.

(CLICK THE RIGHT ARROW)

- **Install Cyberlink Video and Audio Applications:** Installs Cyberlink PowerPlayer SE and Cyberlink VideoLive Mail.
- **ASUS Screen Saver:** Installs the ASUS screen saver.
- **Show Motherboard Information:** Allows you to view information about your motherboard, such as product name, BIOS version, and CPU.
- **Browse Support CD:** Allows you to view the contents of the CD.
- **ReadMe:** Allows you to view the support CD file list and contact information.
- **Exit:** Exits the CD installation menu.

(TO RETURN CLICK THE LEFT ARROW.)

Additional CD Content: Flash BIOS writer in the **AFLASH** folder

6. SOFTWARE REFERENCE

6.1 ASUS PC Probe

ASUS PC Probe is a convenient utility to continuously monitor your computer system's vital components, such as fan rotations, voltages, and temperatures. It also has a utility that lets you review useful information about your computer, such as hard disk space, memory usage, and CPU type, CPU speed, and internal/external frequencies through the DMI Explorer.

6.1.1 Starting ASUS PC Probe

When ASUS PC Probe starts, a splash screen appears allowing you to select whether to show the screen again when you open PC Probe or not. To bypass this startup screen, clear the **Show up in next execution** check box.

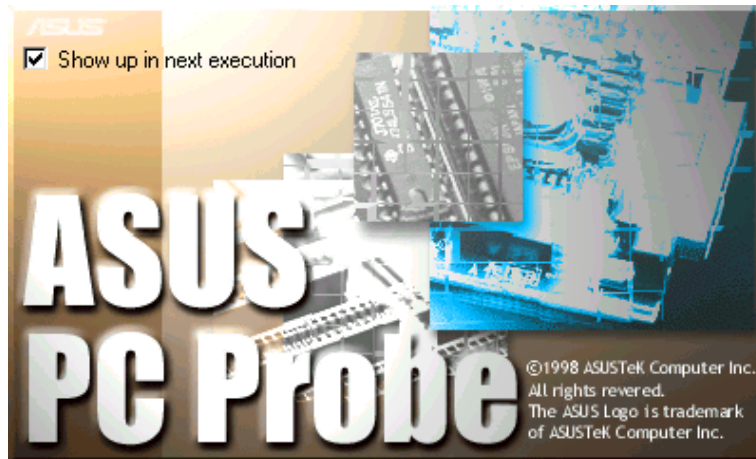

To open **ASUS PC Probe**, click the Windows **Start** button, point to **Programs**, and then **ASUS Utility**, and then click **Probe Vx.xx**.

The PC Probe icon  will appear on the taskbar's system tray indicating that ASUS PC Probe is running. Clicking the icon will allow you to see the status of your PC.

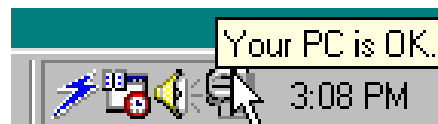

6. SOFTWARE REFERENCE

6.1.2 Using ASUS PC Probe

Monitoring

Monitor Summary

Shows a summary of the items being monitored.

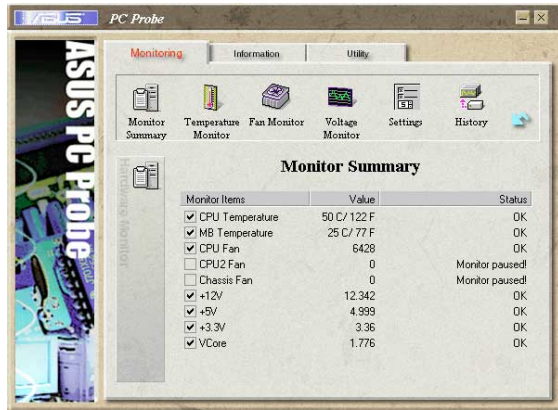

Temperature Monitor

Shows the PC's temperature (for supported processors only).

Temperature Warning threshold adjustment
(Move the slider up to increase the threshold level or down to decrease the threshold level)

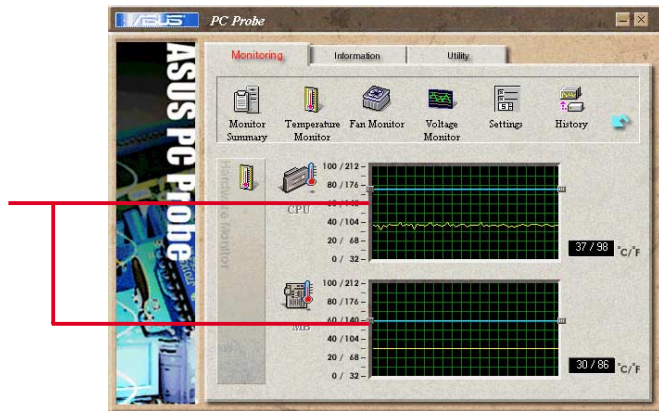

Fan Monitor

Shows the PC's fan rotation.

Fan Warning threshold adjustment
(Move the slider up to increase the threshold level or down to decrease the threshold level)

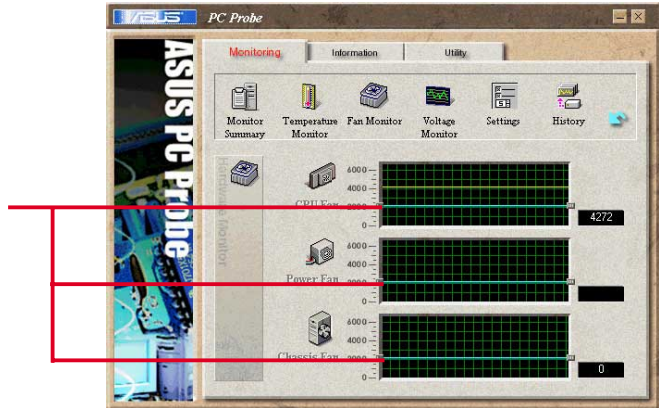

Voltage Monitor

Shows the PC's voltages.

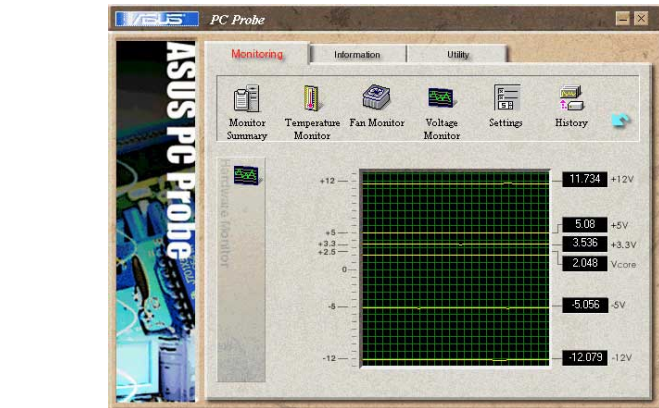

6. SOFTWARE REFERENCE

Settings

Lets you set threshold levels and polling intervals or refresh times of the PC's temperature, fan rotation, and voltages.

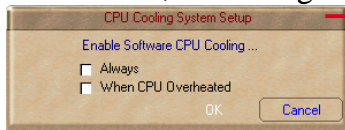

CPU Cooling System Setup

Lets you select when to enable software CPU cooling. When **When CPU Overheated** is selected, the CPU cooling system is enabled whenever the CPU temperature reaches the threshold value.

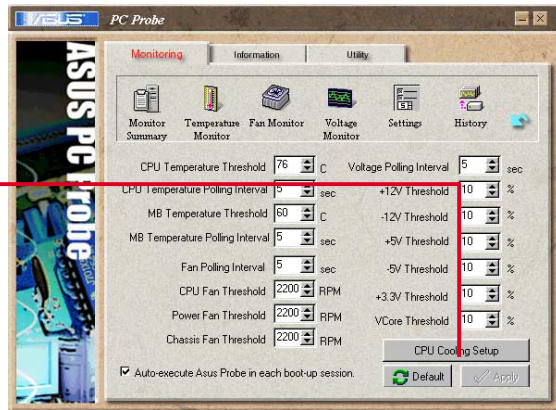

History

Lets you record the monitoring activity of a certain component of your PC for future reference.

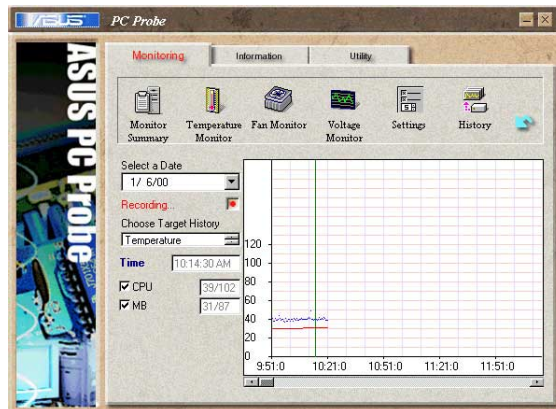

Fan Control

Lets you enable/disable Smart Fan Control. Smart Fan Control adjusts the fan speed automatically based on the current CPU temperature and pre-defined threshold.

NOTE: This feature is not available on ASUS Probe version 2.12.01/2.12.02



Information

Hard Drives

Shows the used and free space of the PC's hard disk drives and the file allocation table or file system used.

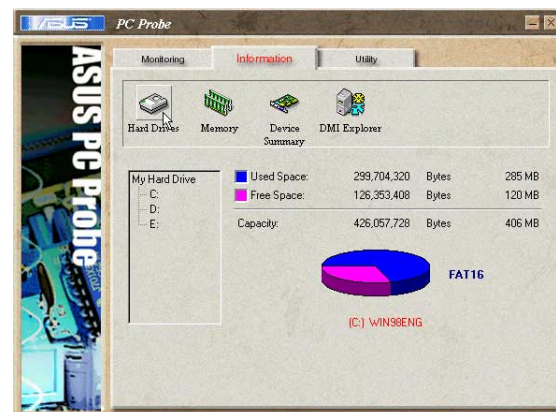

6. SOFTWARE REFERENCE

Memory

Shows the PC's memory load, memory usage, and paging file usage.

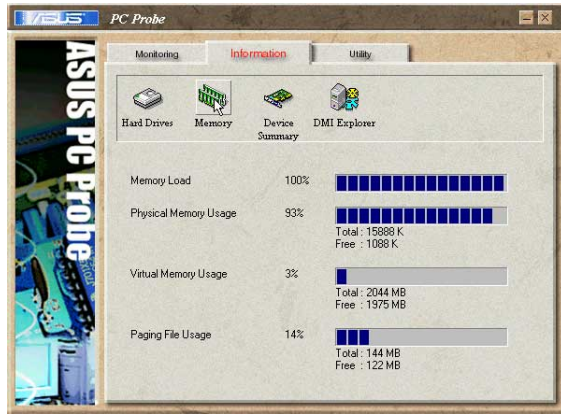

Device Summary

Shows a summary of devices in your PC.



DMI Explorer

Shows information pertinent to the PC, such as CPU type, CPU speed, and internal/external frequencies, and memory size.



Utility

Lets you run programs outside of the ASUS Probe modules. To run a program, click **Execute Program**. **NOTE:** This feature is currently unavailable.

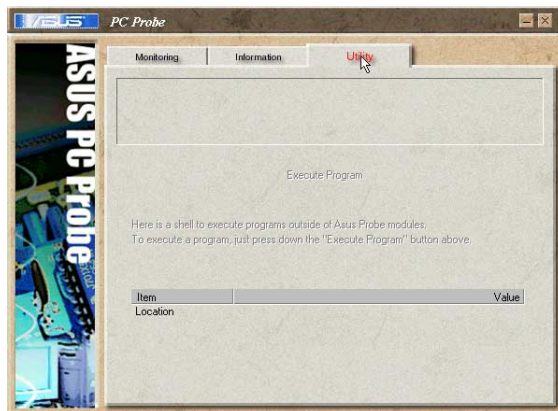

6. SOFTWARE REFERENCE

6.1.3 ASUS PC Probe Task Bar Icon

Right clicking the PC Probe icon will bring up a menu to open or exit ASUS PC Probe and pause or resume all system monitoring.

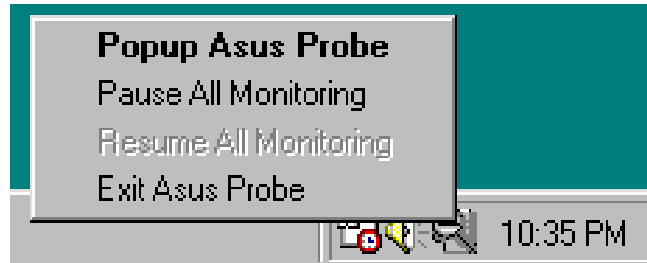

When the ASUS PC Probe senses a problem with your PC, portions of the ASUS PC Probe icon changes to red, the PC speaker beeps, and the ASUS PC Probe monitor is displayed.

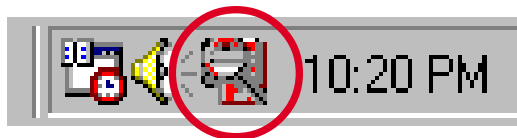

6. SOFTWARE REFERENCE

6.2 CyberLink PowerPlayer SE

CyberLink PowerPlayer SE is an intelligent software player that can automatically detect and playback all kinds of video/audio files, CD and MP3 files as well. This is the only software you need for all types of video and audio files. No need to waste time identifying your file types.

6.2.1 Starting CyberLink PowerPlayer SE

To start **CyberLink Power Player**, click the Windows **Start** button, point to **Programs**, and then **CyberLink PowerPlayer SE**, and then click **PowerPlayer**.

6.2.2 CyberLink PowerPlayer Control Panel

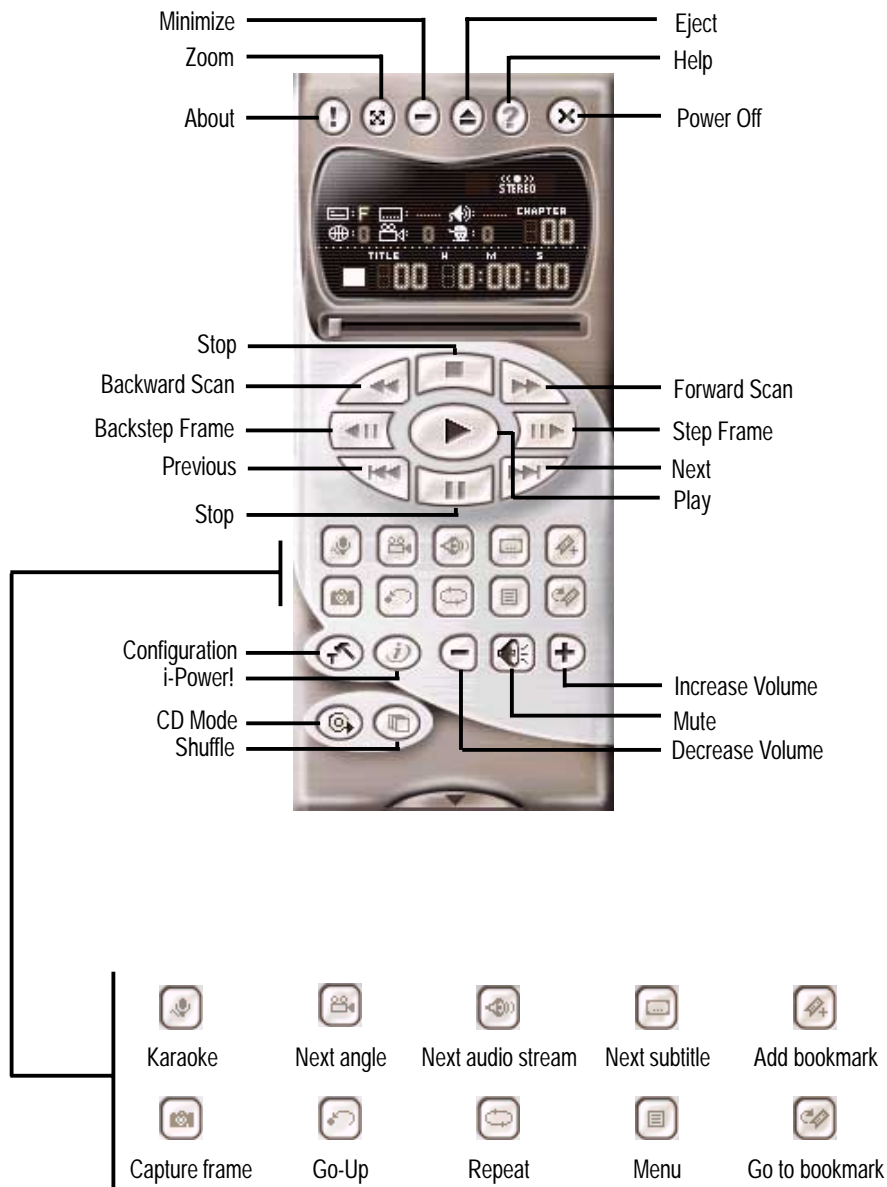

6. SOFTWARE REFERENCE

6.3 CyberLink VideoLive Mail

CyberLink's VideoLive Mail Plus Ver 3.0 (a.k.a. VLM 3) is a convenient and excellent way to create professional quality video mails from PC video/audio input devices and to send the mails to any recipients via VLM 3's built-in e-mail system through the Internet. VLM 3's mails comprise video, sound, or snapshot information; and thus may convey the most profound information to target audiences. It is very convenient for mail recipients who do not need to install additional software component in order to view VLM 3 mails.

VLM 3 works as a very applicant sales tool. It efficiently delivers profound and live product information to your target customers without costing a fortune. VLM 3 also helps corporate managers easily give vivid speeches and broadcast through corporate E-mail system. For personal or home users, VLM 3 easily records live video clips allowing users to send them to friends or family members across the Internet.

VLM 3 loads video messages from PC cameras, digital camcorders, analog camcorder via video capture cards, or from an existing AVI video clips, and captures audio messages from PC microphones. Video and audio messages are encoded at a very high compressed rate in a real-time mode. From data input, data conversion, to sending video mails via Internet, or saving data to disks, the whole procedure is done in an easy and continuous process.

VLM 3's video clip compression rate is up to 1:900, and its playback rate is up to 30 frame per second. VLM 3 provides CIF (352 x 288 pixel) display resolution, and support true color configuration. A one-minute video mail with QCIF (176 x 144) resolution takes up less than 500KB of memory, making it easy to transmit and save mail. Users may always adjust resolution and recording parameters for different purpose.

VLM 3 supports all the hardware devices that are compliant with Video for Windows standard. Video for Windows is a well-accepted and well-tested standard. Thus, users do not have to worry about compatibility issues.

6. SOFTWARE REFERENCE

6.3.1 Starting VideoLive Mail

To start **VideoLive Mail**, click the Windows **Start** button, point to **Programs**, and then **CyberLink VideoLive Mail**, and then click **VideoLive Mail x.x**. VLM 3's Setup Wizard will start and guide you through configuring the video and audio input peripherals and to setup the e-mail environment.

1. Setup Wizard first will prompt a dialog to confirm that you want to configure the hardware and E-mail setting. Click **Yes** to continue the system parameter configuration.
2. The e-mail configuration screen appears. You will need to enter your name and the e-mail address. Click **Next** to continue.
3. The Internet e-mail configuration screen appears. You may choose to use the VLM 3 built-in E-mail functionality (SMTP mail), or use MAPI compliant e-mail system. Consult your ISP or MIS staff for the E-mail server IP address if you are not sure. Click **Next** to continue.
4. Then the Video Configuration screen shows up. You may have to specify the video driver for VLM 3, if there are several video-input devices installed. Then configure the number of video frames to be captured per second. Note that the more frames you choose, the bigger the file size will be. Click **Next** to continue.
5. Then the Setup Wizard will then search for the GSM CODECS module for audio compression, and prompt you with the result. Click **Next** to continue.
6. Setup Wizard then tests the audio volume during playing and recording. Click **Next** when ready.
7. Configuration done. Click **Finish** to complete the environmental setting procedure.

6.3.2 CyberLink VideoLive Mail User Interface



6. SOFTWARE REFERENCE

6.4 ASUS Live Update

ASUS LiveUpdate is a utility that allows you to update your motherboard's BIOS and drivers. The use of this utility requires that you are properly connected to the Internet through an Internet Service Provider (ISP).

1. Start ASUS Update

Launch the utility from your Windows Start menu: **Programs/AsusUpdate**

2. Select an update method.

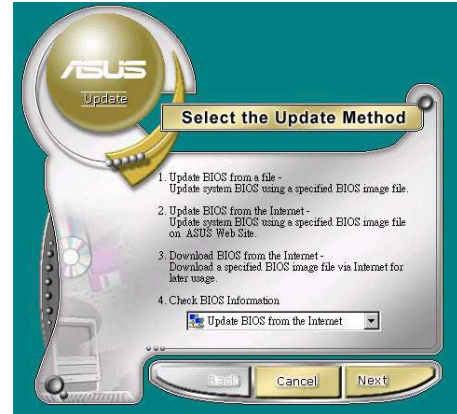

3. If you selected updating/downloading from the Internet, you will need to select an Internet site. Choose the site that is closest to you or click **Auto Select**.



4. From the FTP site, select the BIOS version that you wish to download. Click **Next**.

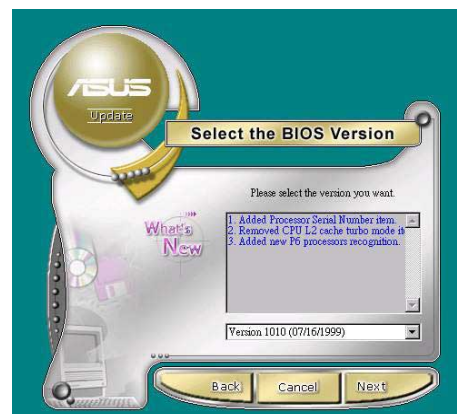

5. Follow the instructions on the succeeding screens to complete the update process. If you selected the option to update the BIOS from a file, a window pops up prompting you to locate the file. Select the file, click **Save**, then follow the screen instructions to complete the update process.

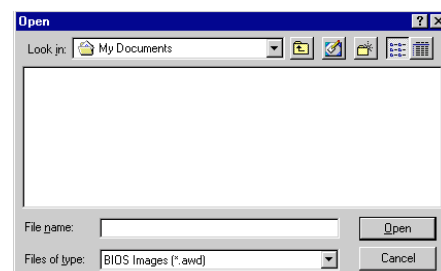

6. SOFTWARE REFERENCE

6.5 Multi-Channel Audio Feature Setup

The C-Media PCI Audio Driver and Applications are located on the Support CD. Installing the programs enables the multi-channel audio feature. **Note:** You must use 4 or 6 channel speakers for this setup.

6.5.1 The C-Media Audio Mixer

1. The C-Media Mixer

Icon appears on the bottom right of the screen, or the **Mixer** may be turned on from the **PCI Audio Applications & Audio Rack** groups on the **Main Program** menu using the Windows **Start** button:  Click on the **icon** to display the C-Media **Audio Mixer**:

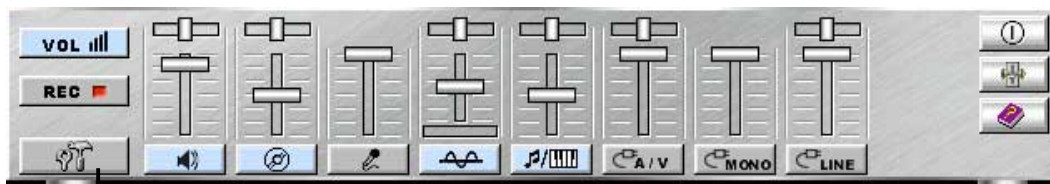
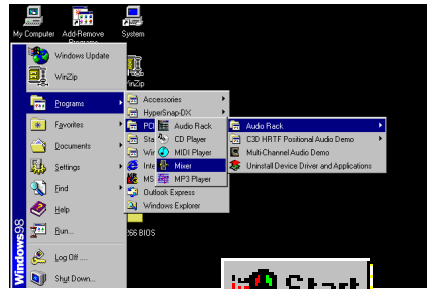

2. The **Tools** button activates the **S/PDIF, Speaker, Volume, Sound Effects** and **Options** menus. The **Speaker** menu offers various configurations for your speaker system. This menu enables the **Line-In** and **Mic-In** audio jacks on the back panel to setup additional speakers for 4 and 6-Channel Audio.



6.5.2 The C-Media Applications

1. Activate the **Multi-Channel Audio Demo** program from the **PCI Audio Applications** group on the **Main Program** menu. Access various applications: **the AudioRack, CD Player, MIDI Player, Mixer, and MP3 Player.**

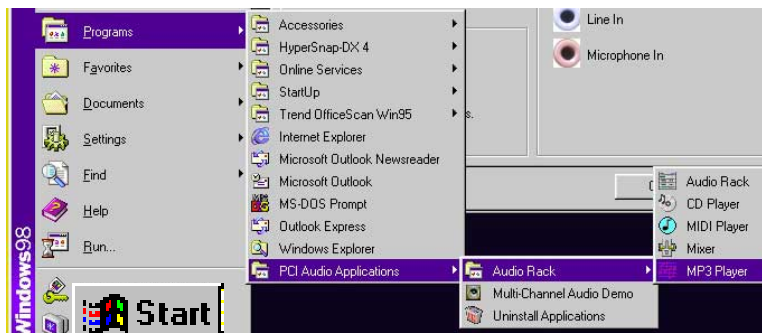

6. SOFTWARE REFERENCE

2. The **PCI Multi-Channel Audio Demo** has several **Demos** to help fine tune your PC speaker system. The **Help** menu features several pages of instructions and hardware diagrams to help configure and test the system. To activate the **Speaker Channel Configuration Menu**, point your mouse arrow and click on the **TV box**.

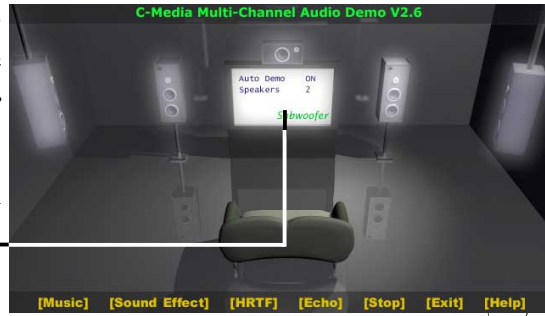

3. The **Speaker Channel Configuration Menu** displays all the options available to help tune the multi-channel audio system even more precisely.

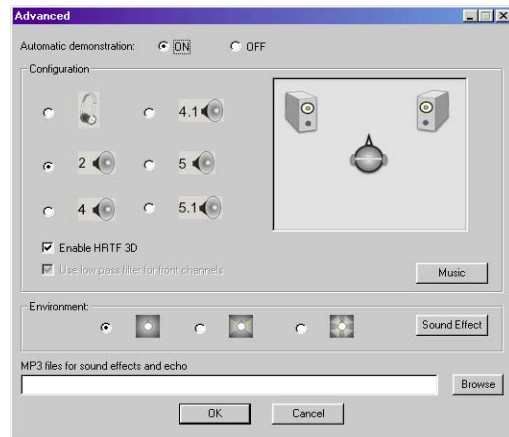

6.2.3 Connector Configuration

The **chart** below displays the configurations for the line connectors on the yellow MIDI/Game/Audio connector port located on the back panel. The three female connectors are available for use in the 6-Channel audio system.

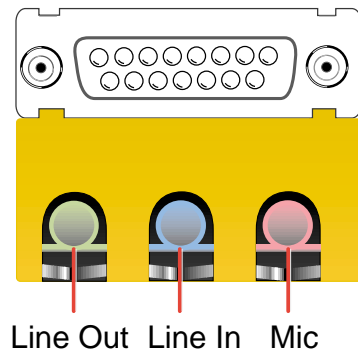

Connector Settings and Functions

	Headphone/ 2-Speaker	4-Speaker	6-Speaker
Lime	Line Out/ Front Spkr Out	Line Out/ Front Spkr Out	Line Out/ Front Spkr Out
Light Blue	Line In	Rear Speaker Out	Rear Speaker Out
Pink	Mic In	Mic In	Center Speaker Out, Sub-woofer

Note: See 6 in Section 3, *Motherboard settings* for the Bass/Center Jumper settings to fine tune the output signals.

6. SOFTWARE REFERENCE

6.6 3Deep Color Tuner

The 3-Deep color tuner is designed to match your CRT or LCD color monitor to maximize the color quality of all graphical applications. Users may also tune their internet applications to match “true” internet source colors with the color displayed on the monitor.

Simply run the setup program from the start menu and follow the instructions on the various setup/test screens.

6.6.1 3Deep Color Tuning

1. Select the type of monitor connected to the computer, either **CRT** or **LCD**.

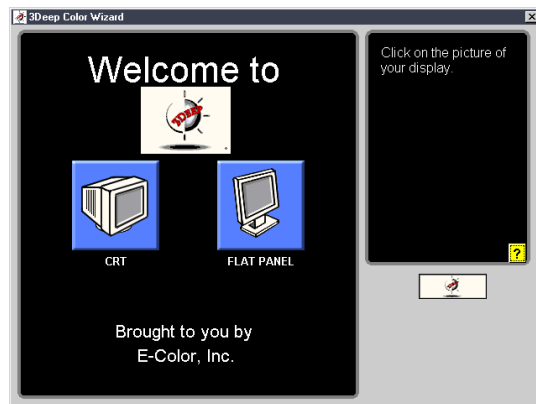

2. Follow the instructions to manually adjust the **brightness** level of the monitor.

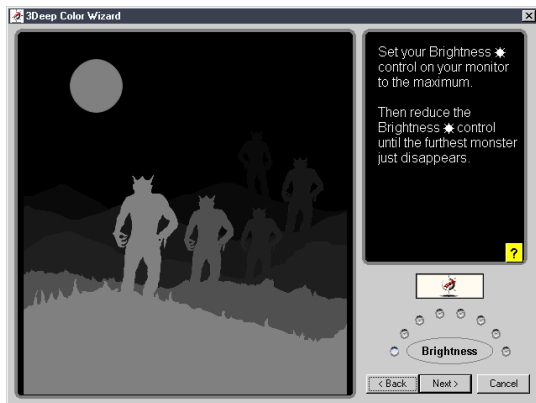

3. Select the faintest of the three colors: **blue**, **red** and **green**.

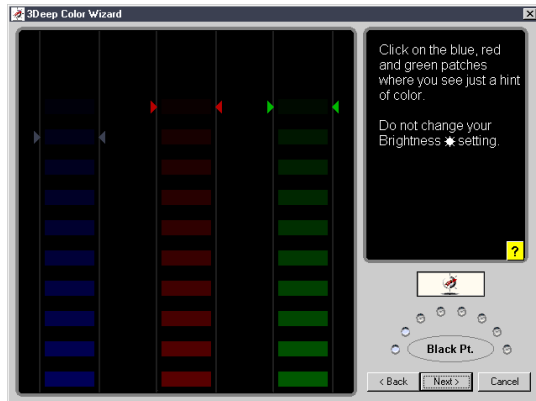

6. SOFTWARE REFERENCE

4. Select the color squares which most closely blend and match with the background.

5. The next step repeats the color matching process to achieve full color quality.

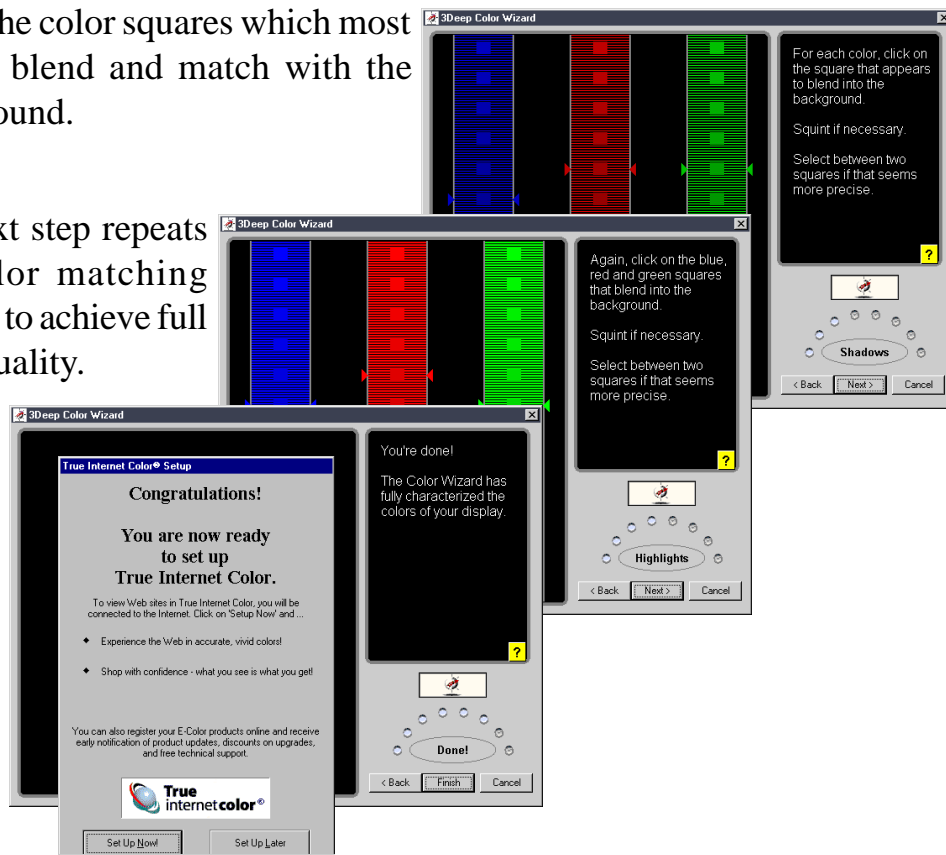

6. The tuning process is complete. Click on the bottom left button to connect to the internet and follow the instructions.

6.5.2 The 3Deep Control Panel

Using the Windows **Start** button, activate the **3Deep Control Panel** program from the **3Deep Applications** group on the **Main Program** menu. The control panel offers access to the **Color Wizard** tuning program, a **Game Gamma** setting and a **Tweak** slider for brightness adjustment.

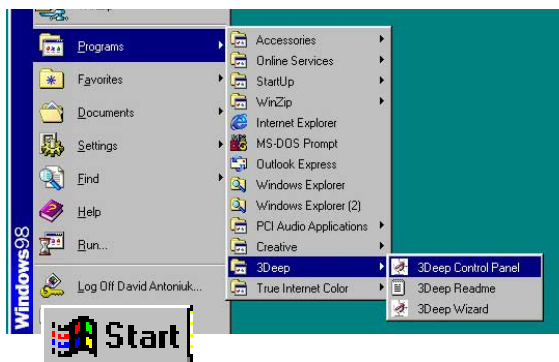

6. SOFTWARE REFERENCE

(This page was intentionally left blank.)

7. APPENDIX

7.1 Qualified Vendors List

This chart shows available power supplies, expansion cards and registered DIMMs on the market that are suitable for use with the A7M266-D. Visit the ASUS website for new updates: <http://www.asus.com>

VGA Card Vendors:

- ASUS AGP-V3800M
- ASUS AGP-V6600 Pro
- ASUS AGP-V6600MX
- ASUS AGP-V7100 Pro
- ASUS AGP-V7100Magic
- ASUS AGP-V7700 Pro
- ASUS AGP-V7700
- ASUS AGP-V8200
- ATI Radeon 64MB DDR
- Creative Geforce 2
- ELSA Gladiac 311
- ELSA Gladiac 511TV-out
- ELSA Gladiac Geforce 2 Ultra
- Leadtek WinFast Geforce 3
- Leadtek WinFast Geforce 2MX DH Pro
- Matrox Millennium G550
- MSI MS 8817 Geforce 2MX

PCI VGA Card Vendors:

- ASUS PCI-V3800

SCSI Controller Card Vendors:

Adaptec ASC-29160N	64Bit
Adaptec AHA-3950U2B	64Bit
Adaptec AHA-2940U2W	64Bit
Adaptec ASC-39160	64Bit
ASUS PCI-DA2200	32Bit
ASUS PCI-SC896	32Bit
ASUS PCI-SC896	64Bit

7. APPENDIX

LAN Card Vendors:

3COM 3C900C	32Bit
3COM 3C905B-TX	32Bit
3COM 3C905C-TXM	32Bit
Acton EN1207D-TX	32Bit
Adaptec ANA-26044	64Bit
ASUS PCI-DEC100TX	32Bit
ASUS PCI-L101	32Bit
Compaq NETFLEX-3/P	32Bit
D-Link DFE-530TX	32Bit
D-Link DFE-500TX	32Bit
HP J3171A	32Bit
Intel 82559	32Bit
Intel 82550	32Bit
Realtek RTL8139	32Bit
SMC 9332DTS	32Bit
Soho Ethernet	32Bit
SMC 9432TX	32Bit
ASUS PCI-13C920	32Bit

Other Card Type Vendors:

ASUS PCI-1394C (device connection)	32Bit	
PHILIPS PSC 703 (audio)		N/A
PHILIPS PSC 706 (audio)		N/A

Power Supply Vendors:

Herolchi HEC-450CR-AT

A7M266-D Registered DIMM Vendors:

Vendor	MB	Memory Chip	Chip Part Number
Apacer	128	SAMSUNG	K4H280838B-TCB0
Apacer	256	SAMSUNG	K4H280838B-TCB0
Apacer	512	SAMSUNG	K4H560838B-TCB0
ATP	128	SAMSUNG	K4H280838C-TCB0
ATP	256	SAMSUNG	K4H280838C-TCB0
ATP	512	SAMSUNG	K4H560838B-TCB0
Infineon	256	Infineon	HYB25D256800AT-7
Infineon	1024	Infineon	17004-00
Kingston	128	SAMSUNG	NT5DS16M8AT-75B
Kingston	256	SAMSUNG	K4H280838C-TCB0
Kingston	512	SAMSUNG	NT5DS64M4AT-7K
Kingston	1024	Infineon	17004-00
Samsung	256	SAMSUNG	K4H280838B-TCB0
TwinMOS	256	SAMSUNG	K4H280838B-TCB0
TwinMOS	256	NANYA	NT5DS16M8AT-7K
Winbond	256	Winbond	W942508AH-7
Winbond	512	Winbond	W942504AH-7

7. APPENDIX

7.2 Glossary

1394

1394 is the IEEE designation for a high performance serial bus that offers data transfers at 100/200/400 Mbps. This serial bus defines both a back plane physical layer and a point-to-point cable-connected virtual bus. The primary application of the cable version is the integration of I/O connectivity at the back panel of personal computers using a low-cost, scalable, high-speed serial interface. The 1394 standard also provides new services such as live connect/disconnect capability for external devices including disk drives, printers and hand-held peripherals such as scanners and cameras. This is a new standard to complement the slower USB interface and to compete with the more expensive SCSI interface.

AC97 (Audio Codec '97)

AC '97 is the next step in enabling PCs with audio quality comparable to consumer electronics devices. The specification defines new cost-effective options to help integrate the components necessary to support next-generation audio-intensive PC applications such as DVD, 3-D multiplayer gaming and interactive music. The specification also defines new extensions supporting modem and docking to help both desktop and mobile manufacturers adopt these new technologies more quickly and cost-effectively. This specification uses software emulation to compete with the PCI SoundBlaster specification.

ACPI (Advanced Configuration and Power Interface)

The ACPI specification defines a cross-platform interface designed to support many operating systems. ACPI defines a flexible and abstract hardware interface that provides a standard way to integrate power management features throughout a PC system, including hardware, operating system and application software. This enables the system to automatically turn ON and OFF peripherals such as CD-ROMs, network cards, hard disk drives, and printers, as well as consumer devices connected to the PC such as VCRs, TVs, phones, and stereos. With this technology, peripherals will also be able to activate the PC. For example, inserting a tape into a VCR can turn on the PC, which could then activate a large-screen TV and high-fidelity sound system.

AGP (Accelerated Graphics Port)

An interface specification that enables high-performance 3D graphics on mainstream PCs. AGP was designed to offer the necessary bandwidth and latency to perform texture mapping directly from system memory.

Bus	Bus Frequency	Bandwidth	Data Transfer Rate
PCI	33MHz	33MHz	133MByte/sec
AGP 1X	66MHz	66MHz	266MByte/sec
AGP 2X	66MHz	133MHz	512MByte/sec
AGP 4X	66MHz	266MHz	1024MByte/sec

Backup. A copy of a file, directory, or volume on a separate storage device from the original. This copy is for the purpose of data retrieval in case the original is accidentally erased, damaged, or destroyed.

BIOS (Basic Input/Output System)

BIOS is a set of routines that affect how the computer transfers data between computer components, such as memory, disks, and the display adapter. The BIOS instructions are built into the computer's read-only memory. BIOS parameters can be configured by the user through the BIOS Setup program. The BIOS can be updated using the provided utility to copy a new BIOS file into the EEPROM.

Bit (Binary Digit)

Represents the smallest unit of data used by the computer. A bit can have one of two values: 0 or 1.

7. APPENDIX

Boot

Boot means to start the computer operating system by loading it into system memory. When the manual instructs you to “boot” your system (or computer), it means to turn ON your computer. “Reboot” means to restart your computer. When using Windows 95 or later, selecting “Restart” from “Start | Shut Down...” will reboot your computer.

Bus Master IDE

PIO (Programmable I/O) IDE requires that the CPU be involved in IDE access and waiting for mechanical events. Bus master IDE transfers data to/from the memory without interrupting the CPU. Bus master IDE driver and bus master IDE hard disk drives are required to support bus master IDE mode.

Byte (Binary Term)

One byte is a group of eight contiguous bits. A byte is used to represent a single alphanumeric character, punctuation mark, or other symbol.

Cache Memory. A type of RAM that allows a faster from the CPU than a regular RAM. The cache memory eliminates the CPU wait state. When the CPU reads data from the main memory, a copy of this data is stored in the cache memory. The next time the same address, the data is transferred from the cache memory instead of from the main memory.

CODEC (Compressor/Decompressor). A software component that translates video or audio between its uncompressed form and the compressed form in which it is stored.

COM Port

COM is a logical device name used by to designate the computer serial ports. Pointing devices, modems, and infrared modules can be connected to COM ports. Each COM port is configured to use a different IRQ and address assignment.

Concurrent PCI

Concurrent PCI maximizes system performance with simultaneous CPU, PCI and ISA bus activities. It includes multi-transaction timing, enhanced write performance, a passive release mechanism and support for PCI 2.1 compliant delayed transactions. Concurrent PCI provides increased bandwidth, reduced system latencies, improves video and audio performance, and improves processing of host based applications.

CPU (Central Processing Unit)

The CPU, sometimes called “Processor,” actually functions as the “brain” of the computer. It interprets and executes program commands and processes data stored in memory. Currently, there are socket 370 (for Pentium III FC-PGA and Celeron-PPGA), socket 7 (for Pentium, AMD, Cyrix, IBM), slot 1 (for Pentium II and III), slot 2 (for Xeon), and slot A (for AMD) processors.

Device Driver

A device driver is a special set of instructions that allows the computer’s operating system to communicate with devices such as VGA, audio, printer, or modem.

DOS (Disk Operating System)

DOS is the foundation on which all other programs and software applications operate, including Windows. DOS is responsible for allocating system resources such as memory, CPU time, disk space, and access to peripheral devices. For this reason, DOS constitutes the basic interface between you and your computer.

DRAM (Dynamic Random Access Memory)

A type of RAM that requires refresh cycles to prevent the loss of the data stored in it. There are several different types of DRAM such as, EDO DRAM (Extended Data Output DRAM), SDRAM (Synchronous DRAM), and RDRAM (Rambus DRAM) and DDR DRAM, (Double-Data Rate DRAM).

Flash ROM

non-volatile memory device that retains its data even when power is removed. This device is similar to EPROM, but unlike EPROM which can be erased only using an ultra-violet light, flash ROM can be electrically erased. Flash ROM is normally used for system BIOS, which initiates hardware devices and sets up necessary parameters for the OS. Since the flash ROM contents can be modified, users can easily update the BIOS..

7. APPENDIX

IDE (Integrated Drive Electronics)

IDE devices integrate the drive control circuitry directly on the drive itself, eliminating the need for a separate adapter card (in the case for SCSI devices). UltraDMA/33 IDE devices can achieve up to 33MB/Sec transfer.

I/O (Input/Output)

The data transfers from the input devices like a keyboard, mouse, or scanner, to the output devices like a printer or the monitor screen.

I/O Address

The specific memory location for a particular device. Two devices cannot share the same I/O address space.

IrDA (Infrared Data Association)

An international organization that creates and promotes inter-operable, low cost, infrared data interconnection standards that support a walk-up, point-to-point model. The IrDA protocol is designed to support transmission of data between two devices over short-range point-to-point infrared at speeds between 9.6Kbps and 4Mbps.

ISP (Internet Service Provider)

A company that provides customer access to the Internet and the World Wide Web for a fee. The ISP also provides Internet utilities and services like e-mail, newsgroup, weather reports, and a host of others. The user can connect to the ISP using a modem installed in the computer and connected to a phone line.

LPT Port (Line Printer Port)

Logical device name reserved by DOS for the computer parallel ports. Each LPT port is configured to use a different IRQ and address assignment.

MMX

A set of 57 new instructions designed to accelerate multimedia and communications applications, such as 3D video, 3D sound, video conference.

Modem

A device that allows a computer to talk to another computer through the phone system.

Network

An interconnected computer system linked by telephone wires, or other means.

OnNow

The OnNow design initiative is a comprehensive, system-wide approach to system and device power control. OnNow is a term for PC that is always ON but appears OFF and responds immediately to user or other requests. The OnNow design initiative involves changes that will occur in the Microsoft Windows operating system, device drivers, hardware, and applications, and also relies on the changes defined in the Advanced Configuration and Power Interface (ACPI) specification.

PC100/133

This is an industry-standard designation for memory capacity as a measure of the speed of the memory bus. New platform requirements ensure that memory does not become a bottleneck to system performance.

PCI Bus (Peripheral Component Interconnect Local Bus)

PCI bus is a standard specification that defines a 32-bit data bus interface.

PCI Bus Master

The PCI Bus Master can perform data transfer without local CPU help and the CPU can be treated as one of the Bus Masters. PCI 2.1 supports concurrent PCI operation to allow the local CPU and bus master to work simultaneously.

POST (Power On Self Test)

Powering on the computer initiates the POST, a series of software-controlled diagnostic tests. The POST checks system memory, the motherboard circuitry, the display, the keyboard, the diskette drive, and other I/O devices

7. APPENDIX

PS/2 Port

PS/2 ports are based on IBM Micro Channel Architecture. This type of architecture transfers data through a 16-bit or 32-bit bus. A PS/2 mouse and/or keyboard may be used on ATX motherboards.

RDRAM (Rambus DRAM)

Developed by Rambus, Inc., this type of memory can deliver up to 1.6GB of data per second. RDRAM is the first interface standard that can be directly implemented on high performance VLSI components such as, CMOS DRAMs, memory controllers, and graphics/video ICs.

RAM (Random Access Memory). The computer's primary storage area used to write, store, and retrieve information and program instructions which are passed to the CPU for processing. The information in RAM can be repeatedly re-written with new data. Compared to other storage media like magnetic tape, floppy disk, and hard disk, RAM has an extraordinarily fast access rate. RAM, however, is volatile, which means that the data stored in it are lost when the system power is turned off, or if power glitches occur. See also DRAM and SDRAM.

ROM (Read Only Memory)

ROM is nonvolatile memory used to store permanent programs (called firmware) used in certain computer components. Flash ROM (or EEPROM) can be reprogrammed with new programs (or BIOS).

SCSI (Small Computer System Interface)

High speed multi-threaded I/O interface defined by the X3T9.2 committee of the American National Standards Institute (ANSI) for connecting many peripheral devices. The standard started from 10MBytes/sec to 160MBytes/sec available today.

SDRAM (Synchronous DRAM)

A type of DRAM with access signals that are synchronized with the CPU clock, eliminating the delay associated with data transfers between the CPU and memory. SDRAM takes memory access away from the CPU control; internal registers in the memory accept the request, and lets the CPU do something else while the data requested is assembled for the next time the CPU talks to the memory.

SPD for SDRAM module

Serial Presence Detect (SPD) is most like an ID detect for SDRAM module, it using a EEPROM component on DIMM module for storing module configuration information inside. The Serial Presence Detect function is implemented using a 2048 bit EEPROM component. This nonvolatile storage device contains data programmed by the DIMM manufacturer that identifies the module type and various SDRAM organization and timing parameters.

System Disk

A system disk contains the core file of an operating system that boots up the operating system.

TCP/IP (Transmission Control Protocol/Internet Protocol). The communications protocol used by the UNIX system and the Internet. TCP checks for lost packets, puts the data from multiple packets into the correct order, and requests that missing or damaged packets be resent.

USB (Universal Serial Bus)

A 4-pin serial cable bus that allows up to 127 plug and play computer peripherals such as keyboard, mouse, joystick, scanner, printer, modem, and monitor to share a bandwidth through a host scheduled token based protocol. This allows attaching or detaching while the host and other peripherals are in operation. Supports synchronous and asynchronous transfer types over the same set of wires up to 12Mbit/sec. USB 2.0 provides twice the transfer rate compared to USB 1.0 and competes with the 1394 standard.

Wake-On-LAN

Computer will automatically wake-up upon receiving a wake-up packet through a Network interface when it is under power soft-off, suspend or sleep mode.

INDEX

Symbols

3Deep Color Tuner
Using 88

A

AC PWR Loss Restart 67
ASUS PC Probe
Using 77
ASUS Update
Using 85
ATAPI CD-ROM 70
ATX Power Supply Connector 37
Audio Port Connectors 29

B

BIOS
Beep Code 39
Smart BIOS 8
BIOS Beep Codes 39
Boot Sequence 70
Boot Up Floppy Seek 71
Boot Up NumLock Status 52
Boot Virus Detection 71

C

C-Media Audio Setup 86
Central Processing Unit 23
Central Processing Unit (CPU)
CPU socket 9
Chassis Fan Speed 69
Chassis Intrusion Lead 31
CHS Capacity 51

Connectors

ASUS EZ Plug 9
ATX power 9
ATX Power Supply 37
Audio Port 29
Floppy disk 9
Floppy Disk Drive 29, 34
IDE 9
Internal Audio 15, 34
Keyboard 27
Parallel Port 28
PS/2 Keyboard 27
PS/2 Mouse 27
Serial Port 28
SMBus 32
USB 28

CPU Fan Speed 69

CPU Temperature 69

CyberLink

PowerPlayer SE 83
VideoLive Mail 83

CyberLink PowerPlayer SE
Using 83

CyberLink VideoLive Mail
Using 83

Cylinders 50

D

Discard Changes 73
DMA x Used By ISA 62

E

ECP DMA Select 60
Exit Discarding Changes 72
Exit Saving Changes 72
Expansion Cards
Assigning IRQs 25

F

Floppy 3 Mode Support 48
Floppy Disk Drive Connector 29, 34

G

Glossary 91, 93

H

Halt On 53
Hardware Setup
CPU Installation 23
Memory Installation 22
HDD Power Down 66
Head 51
Headers
USB 32

I

IDE Activity LED Lead 36, 38
IDE Hard Drive 70
Installation
CPU 23
Installed Memory 53
Interrupts
Standard Assignments 25
IRQ XX Used By ISA 62
ISA MEM Block BASE 63

K

Keyboard Connector 27

L

Language 53
Leads
Chassis Intrusion 31
IDE Activity LED 36, 38
Reset Switch 38
System Message LED 38
System Power LED 38
Legacy Diskette A 48
Legacy Diskette B 48

INDEX

- LiveUpdate 88
 - Using 88
- Load Setup Defaults 73
- M**
- Maximum LBA Capacity 51
- MB Temperature 69
- Memory Hole At 15M-16M 55
- Memory Installation 22
- Motherboard
 - Specifications 9
- Mouse Connector 27
- Multi-Channel Audio 86
 - Using 86
- Multi-Sector Transfers 51
- O**
- Onboard Parallel Port 59
- Onboard Serial Port 2 59
- OS/2 Onboard Memory > 64M 55
- P**
- Parallel Port Connector 28
- Parallel Port Mode 60
- PCI Latency Timer 61
- PCI/VGA Palette Snoop 61
- PIO Mode 51
- Plug & Play O/S 71
- Power Fan Speed 69
- Power Management 65
- PowerPlayer SE
 - Using 83
- Procedure
 - CPU Installation 23
- Procedures
 - Updating BIOS 42
- PS/2 Keyboard Connector 27
- PS/2 Keyboard Port 9
- PS/2 Mouse Connector 27
- PS/2 Mouse Port 9
- PWR Up On Modem Act 67
- Q**
- Quick Power On Self Test 71
- R**
- Removable Device 70
- Reset Switch Lead 38
- S**
- Save Changes 73
- SDRAM CAS Latency 57
- SDRAM Configuration 55
- SDRAM RAS Precharge Time 57
- Sector 51
- Serial Port Connectors 28
- Serial ports 9
- SMART Monitoring 51
- SMBus Connector 32
- Starting Up 39
- Supervisor Password 53
- SYMBIOS SCSI BIOS 61
- System Date 48
- System Message LED Lead 38
- System Power LED Lead 38
- System Time 48
- T**
- Translation Method 50
- Type 49
- U**
- UART2 Use Standard Infrared 59
- Ultra DMA Mode 51
- Updating Your BIOS 41
- USB Function 61
- USB Headers 32
- USB Legacy Support 55
- USB Ports 28
- USB ports 9
- Using
 - 3Deep Color Tuner 88
 - ASUS PC Probe 77
 - ASUS Update 85
 - LiveUpdate 88
 - PowerPlayer SE 83
- V**
- VCORE Voltage 69
- Video Off Method 66
- Video Off Option 66
- Video ROM BIOS Shadow 64
- VideoLive Mail 83
 - Using 83
- Voltage
 - +12 69
 - +3.3 69
 - +5 69
 - 12 69
 - 5 69
 - VCORE 69
- W**
- Wake On LAN 67, 68

Free Manuals Download Website

<http://myh66.com>

<http://usermanuals.us>

<http://www.somanuals.com>

<http://www.4manuals.cc>

<http://www.manual-lib.com>

<http://www.404manual.com>

<http://www.luxmanual.com>

<http://aubethermostatmanual.com>

Golf course search by state

<http://golfingnear.com>

Email search by domain

<http://emailbydomain.com>

Auto manuals search

<http://auto.somanuals.com>

TV manuals search

<http://tv.somanuals.com>