

P8Q77-M



Motherboard

E7977

Second Edition (V2)

December 2012

Copyright © 2012 ASUSTeK Computer Inc. All Rights Reserved.

No part of this manual, including the products and software described in it, may be reproduced, transmitted, transcribed, stored in a retrieval system, or translated into any language in any form or by any means, except documentation kept by the purchaser for backup purposes, without the express written permission of ASUSTeK Computer Inc. ("ASUS").

Product warranty or service will not be extended if: (1) the product is repaired, modified or altered, unless such repair, modification or alteration is authorized in writing by ASUS; or (2) the serial number of the product is defaced or missing.

ASUS PROVIDES THIS MANUAL "AS IS" WITHOUT WARRANTY OF ANY KIND, EITHER EXPRESS OR IMPLIED, INCLUDING BUT NOT LIMITED TO THE IMPLIED WARRANTIES OR CONDITIONS OF MERCHANTABILITY OR FITNESS FOR A PARTICULAR PURPOSE. IN NO EVENT SHALL ASUS, ITS DIRECTORS, OFFICERS, EMPLOYEES OR AGENTS BE LIABLE FOR ANY INDIRECT, SPECIAL, INCIDENTAL, OR CONSEQUENTIAL DAMAGES (INCLUDING DAMAGES FOR LOSS OF PROFITS, LOSS OF BUSINESS, LOSS OF USE OR DATA, INTERRUPTION OF BUSINESS AND THE LIKE), EVEN IF ASUS HAS BEEN ADVISED OF THE POSSIBILITY OF SUCH DAMAGES ARISING FROM ANY DEFECT OR ERROR IN THIS MANUAL OR PRODUCT.

SPECIFICATIONS AND INFORMATION CONTAINED IN THIS MANUAL ARE FURNISHED FOR INFORMATIONAL USE ONLY, AND ARE SUBJECT TO CHANGE AT ANY TIME WITHOUT NOTICE, AND SHOULD NOT BE CONSTRUED AS A COMMITMENT BY ASUS. ASUS ASSUMES NO RESPONSIBILITY OR LIABILITY FOR ANY ERRORS OR INACCURACIES THAT MAY APPEAR IN THIS MANUAL, INCLUDING THE PRODUCTS AND SOFTWARE DESCRIBED IN IT.

Products and corporate names appearing in this manual may or may not be registered trademarks or copyrights of their respective companies, and are used only for identification or explanation and to the owners' benefit, without intent to infringe.

Offer to Provide Source Code of Certain Software

This product may contain copyrighted software that is licensed under the General Public License ("GPL") and under the Lesser General Public License Version ("LGPL"). The GPL and LGPL licensed code in this product is distributed without any warranty. Copies of these licenses are included in this product.

You may obtain the complete corresponding source code (as defined in the GPL) for the GPL Software, and/or the complete corresponding source code of the LGPL Software (with the complete machine-readable "work that uses the Library") for a period of three years after our last shipment of the product including the GPL Software and/or LGPL Software, which will be no earlier than December 1, 2011, either

(1) for free by downloading it from <http://support.asus.com/download>;

or

(2) for the cost of reproduction and shipment, which is dependent on the preferred carrier and the location where you want to have it shipped to, by sending a request to:

ASUSTeK Computer Inc.
Legal Compliance Dept.
15 Li Te Rd.,
Beitou, Taipei 112
Taiwan

In your request please provide the name, model number and version, as stated in the About Box of the product for which you wish to obtain the corresponding source code and your contact details so that we can coordinate the terms and cost of shipment with you.

The source code will be distributed WITHOUT ANY WARRANTY and licensed under the same license as the corresponding binary/object code.

This offer is valid to anyone in receipt of this information.

ASUSTeK is eager to duly provide complete source code as required under various Free Open Source Software licenses. If however you encounter any problems in obtaining the full corresponding source code we would be much obliged if you give us a notification to the email address gpl@asus.com, stating the product and describing the problem (please do NOT send large attachments such as source code archives etc to this email address).

Contents

Safety information	vi
About this guide	vi
P8Q77-M specifications summary	viii

Chapter 1: Product introduction

1.1	Welcome!	1-1
1.2	Package contents	1-1
1.3	Special features	1-1
1.3.1	Product highlights	1-1
1.3.2	Innovative ASUS features	1-3
1.4	Before you proceed	1-5
1.5	Motherboard overview	1-6
1.5.1	Placement direction	1-6
1.5.2	Screw holes	1-6
1.5.3	Motherboard layout	1-7
1.5.4	Layout contents.....	1-7
1.6	Central Processing Unit (CPU)	1-8
1.6.1	Installing the CPU	1-9
1.6.2	CPU heatsink and fan assembly installation.....	1-11
1.7	System memory	1-13
1.7.1	Overview	1-13
1.7.2	Memory configurations.....	1-13
1.7.3	Installing a DIMM	1-18
1.7.4	Removing a DIMM	1-18
1.8	Expansion slots	1-19
1.8.1	Installing an expansion card	1-19
1.8.2	Configuring an expansion card	1-19
1.8.3	PCI slot	1-19
1.8.4	PCI Express x4 slot.....	1-19
1.8.5	PCI Express x16 slot.....	1-19
1.9	Jumpers	1-20
1.10	Connectors	1-21
1.10.1	Rear panel connectors.....	1-21
1.10.2	Internal connectors	1-23
1.11	Onboard switches	1-30
1.12	Onboard LEDs	1-31

Contents

1.13	Software support	1-32
1.13.1	Installing an operating system	1-32
1.13.2	Support DVD information	1-32
1.13.3	Intel® SBA support.....	1-33

Chapter 2: BIOS information

2.1	Managing and updating your BIOS	2-1
2.1.1	ASUS Update utility	2-1
2.1.2	ASUS EZ Flash 2.....	2-2
2.1.3	ASUS CrashFree BIOS 3 utility	2-3
2.1.4	ASUS BIOS Updater.....	2-4
2.2	BIOS setup program	2-6
2.3	Main menu	2-9
2.3.1	System Language [English]	2-10
2.3.2	System Date [Day xx/xx/xxxx].....	2-10
2.3.3	System Time [xx:xx:xx]	2-10
2.3.4	Security	2-10
2.4	Ai Tweaker menu	2-11
2.4.1	CPU bus speed : DRAM speed ratio mode [Auto].....	2-12
2.4.2	Memory Frequency [Auto].....	2-12
2.4.3	EPU Power Saving Mode [Disabled]	2-12
2.4.4	GPU Boost [OK].....	2-12
2.4.5	DRAM Timing Control	2-12
2.4.6	CPU Power Management	2-12
2.4.7	CPU Voltage [Offset Mode].....	2-13
2.4.8	DRAM Voltage [Auto].....	2-14
2.4.9	VCCIO Voltage [Auto].....	2-14
2.4.10	VCCSA Voltage [Auto]	2-14
2.4.11	CPU PLL Voltage [Auto].....	2-14
2.4.12	PCH Voltage [Auto].....	2-14
2.4.13	Load-Line Calibration [Auto]	2-14
2.5	Advanced menu	2-15
2.5.1	Trusted Computing.....	2-15
2.5.2	CPU Configuration	2-16
2.5.3	PCH Configuration	2-17
2.5.4	SATA Configuration	2-17

Contents

2.5.5	System Agent Configuration	2-18
2.5.6	Intel TXT(LT) Configuration.....	2-19
2.5.7	AMT Configuration	2-19
2.5.8	USB Configuration	2-20
2.5.9	Onboard Devices Configuration.....	2-20
2.5.10	APM	2-22
2.5.11	Serial Port Console Redirection	2-22
2.5.12	Network Stack.....	2-23
2.6	Monitor menu	2-23
2.6.1	CPU Temperature / MB Temperature [xxx°C/xxx°F].....	2-24
2.6.2	CPU / Chassis Fan Speed	2-24
2.6.3	CPU Q-Fan Control [Enabled]	2-24
2.6.4	Chassis Q-Fan Control [Enabled]	2-25
2.6.5	CPU Voltage, 3.3V Voltage, 5V Voltage, 12V Voltage ..	2-25
2.6.6	Anti Surge Support [Enabled]	2-25
2.7	Boot menu	2-26
2.7.1	Bootup NumLock State [On]	2-26
2.7.2	Full Screen Logo [Enabled].....	2-26
2.7.3	Wait for 'F1' If Error [Enabled].....	2-26
2.7.4	Option ROM Messages [Force BIOS].....	2-27
2.7.5	Setup Mode [EZ Mode]	2-27
2.7.6	UEFI/Legacy Boot [Enabled both UEFI and Legacy]....	2-27
2.7.7	PCI ROM Priority [Legacy ROM]	2-27
2.7.8	Boot Option Priorities	2-27
2.7.9	Boot Override.....	2-27
2.8	Tools menu	2-28
2.8.1	ASUS EZ Flash 2 Utility	2-28
2.8.2	ASUS O.C. Profile.....	2-28
2.8.3	ASUS SPD Information	2-28
2.9	Exit menu	2-29

Appendices

Notices.....	A-1
--------------	-----

Safety information

Electrical safety

- To prevent electric shock hazard, disconnect the power cable from the electric outlet before relocating the system.
- When adding or removing devices to or from the system, ensure that the power cables for the devices are unplugged before the signal cables are connected. If possible, disconnect all power cables from the existing system before you add a device.
- Before connecting or removing signal cables from the motherboard, ensure that all power cables are unplugged.
- Seek professional assistance before using an adapter or extension cord. These devices could interrupt the grounding circuit.
- Ensure that your power supply is set to the correct voltage in your area. If you are not sure about the voltage of the electrical outlet you are using, contact your local power company.
- If the power supply is broken, do not try to fix it by yourself. Contact a qualified service technician or your retailer.

Operation safety

- Before installing the motherboard and adding devices on it, carefully read all the manuals that came with the package.
- Before using the product, ensure that all cables are correctly connected and the power cables are not damaged. If you detect any damage, contact your dealer immediately.
- To avoid short circuits, keep paper clips, screws, and staples away from connectors, slots, sockets and circuitry.
- Avoid dust, humidity, and temperature extremes. Do not place the product in any area where it may become wet.
- Place the product on a stable surface.
- If you encounter technical problems with the product, contact a qualified service technician or your retailer.

About this guide

This user guide contains the information you need when installing and configuring the motherboard.

How this guide is organized

This guide contains the following parts:

- **Chapter 1: Product introduction**
This chapter describes the features of the motherboard and the new technology it supports.
- **Chapter 2: BIOS information**
This chapter tells how to change system settings through the BIOS Setup menus. Detailed descriptions of the BIOS parameters are also provided.

Conventions used in this guide

To ensure that you perform certain tasks properly, take note of the following symbols used throughout this manual.



DANGER/WARNING: Information to prevent injury to yourself when trying to complete a task.



CAUTION: Information to prevent damage to the components when trying to complete a task.



IMPORTANT: Instructions that you **MUST** follow to complete a task.



NOTE: Tips and additional information to help you complete a task.

Where to find more information

Refer to the following sources for additional information and for product and software updates.

1. ASUS websites

The ASUS website provides updated information on ASUS hardware and software products. Refer to the ASUS contact information.

2. Optional documentation

Your product package may include optional documentation, such as warranty flyers, that may have been added by your dealer. These documents are not part of the standard package.

Typography

Bold text

Indicates a menu or an item to select.

Italics

Used to emphasize a word or a phrase.

<Key>

Keys enclosed in the less-than and greater-than sign means that you must press the enclosed key.

Example: <Enter> means that you must press the Enter or Return key.

<Key1>+<Key2>+<Key3>

If you must press two or more keys simultaneously, the key names are linked with a plus sign (+).

Example: <Ctrl>+<Alt>+<D>

P8Q77-M specifications summary

CPU	<p>LGA1155 socket for Intel® 3rd/2nd Generation Core™ i7 / Core™ i5 / Core™ i3 / Pentium® / Celeron® processors</p> <p>Supports Intel 22/32nm CPU</p> <p>Supports Intel® Turbo Boost Technology 2.0</p> <p>* The Intel® Turbo Boost Technology 2.0 support depends on the CPU types.</p> <p>** Refer to www.asus.com for Intel® CPU support list.</p>
Chipset	Intel® Q77 Express Chipset
Memory	<p>4 x DIMM, maximum 32GB, DDR3 1600/1333/1066 MHz, non-ECC, un-buffered memory</p> <p>Dual-channel memory architecture</p> <p>* Refer to www.asus.com for the latest Memory QVL (Qualified Vendors List).</p> <p>** When you install a total memory of 4GB capacity or more, Windows® 32-bit operating system may only recognize less than 3GB. We recommend a maximum of 3GB system memory if you are using a Windows® 32-bit operating system.</p>
Expansion slots	<p>1 x PCI Express 3.0*/2.0 x16 slot</p> <p>1 x PCI Express 2.0 x4 slot</p> <p>2 x PCI slots</p> <p>* PCIe 3.0 speed is supported by Intel® 3rd generation Core™ processors.</p>
Graphics	<p>Integrated graphics processor</p> <p>Multi-VGA output support: Display port, DVI-D, and D-Sub ports</p> <p>Supports D-Sub with max. resolution up to 2048 x 1536 @75Hz</p> <p>Supports DVI-D with max. resolution up to 1920 x 1200 @60Hz</p> <p>Supports Display Port with max. resolution up to 2560 x 1600 @60Hz</p>
Storage	<p>Intel® Q77 Express Chipset:</p> <ul style="list-style-type: none"> - 2 x Serial ATA 6.0 Gb/s connectors (gray) - 4 x Serial ATA 3.0 Gb/s connectors (blue) - Intel® Matrix Storage technology supports RAID 0, 1, 0+1(10), and 5 configurations - Supports Intel® Smart Response Technology, Intel® Rapid Start Technology, Intel® Smart Connect Technology* <p>* Supports on Intel® Core™ processor family with Windows® 7 operating systems.</p>
LAN	Intel® 82579 Gigabit LAN controller
Audio	<p>VIA® VT1708S 8-channel* High Definition Audio CODEC</p> <ul style="list-style-type: none"> - Supports Jack-Detection, Multi-streaming, and Anti-pop function <p>* Use a chassis with HD audio module in the front panel to support an 8-channel audio output.</p>
USB	<p>Intel® Q77 Express Chipset:</p> <ul style="list-style-type: none"> - 4 x USB 3.0 ports (2 ports at the mid-board, 2 ports at the back panel [blue]) - 10 x USB 2.0 ports (6 ports at the mid-board, 4 ports at the back panel)

(continued on the next page)

P8Q77-M specifications summary

ASUS unique features	ASUS Exclusive Features: <ul style="list-style-type: none"> - ASUS EPU - GPU Boost - ASUS USB 3.0 Boost - MemOK! - ASUS AI Suite II - Ai Charger - ASUS Anti-Surge Protection - ASUS UEFI BIOS featuring graphics user interface ASUS Quiet Thermal Solution: <ul style="list-style-type: none"> - ASUS Q-Fan 2 - ASUS Fan Xpert ASUS EZ DIY: <ul style="list-style-type: none"> - ASUS CrashFree BIOS 3 - ASUS EZ Flash 2 - ASUS MyLogo 2™
Back panel I/O ports	<ul style="list-style-type: none"> 1 x PS/2 Mouse port (green) 1 x PS/2 Keyboard port (purple) 1 x Display Port 1 x DVI-D port 1 x VGA port 1 x LAN (RJ-45) port 4 x USB 2.0/1.1 ports 2 x USB 3.0/2.0 ports (blue) 3 x Audio jacks
Internal connectors / buttons / switches	<ul style="list-style-type: none"> 1 x USB 3.0/2.0 connector supports additional 2 USB 3.0/2.0 ports 3 x USB 2.0/1.1 connectors support additional 6 USB 2.0/1.1 ports 2 x SATA 6.0Gb/s connectors (gray) 4 x SATA 3.0Gb/s connectors (blue) 1 x CPU fan connector 2 x Chassis fan connectors 1 x LPT connector 1 x Front panel audio connector 1 x COM connector 1 x S/PDIF output connector 1 x Speaker connector 1 x Chassis intrusion connector 1 x 24-pin EATX power connector 1 x 8-pin EATX 12V power connector 1 x System panel connector 1 x TPM IC onboard 1 x MemOK! button 1 x Clear CMOS jumper 1 x DIS_ME jumper

(continued on the next page)

P8Q77-M specifications summary

BIOS	128 Mb Flash ROM, UEFI AMI BIOS, PnP, DMI 2.0, WfM 2.0, ACPI 2.0a, SM BIOS 2.7, Multi-language BIOS, ASUS CrashFree BIOS 3, ASUS EZ Flash 2
Manageability	WfM 2.0, DMI 2.0, WOL by PME, WOR by PME, PXE
Accessories	2 x Serial ATA 6.0Gb/s cables 1 x I/O shield 1 x User Manual 1 x Support DVD
Support DVD	Drivers ASUS utilities ASUS Update Anti-virus software (OEM version)
Form factor	MicroATX form factor: 9.6 in x 9.0 in (24.4 cm x 22.8 cm)

* Specifications are subject to change without notice.

Chapter 1

Product introduction

1.1 Welcome!

Thank you for buying an ASUS® P8Q77-M motherboard!

The motherboard delivers a host of new features and latest technologies, making it another standout in the long line of ASUS quality motherboards!

Before you start installing the motherboard, and hardware devices on it, check the items in your package with the list below.

1.2 Package contents

Check your motherboard package for the following items.

Motherboard	ASUS P8Q77-M motherboard
Cables	2 x Serial ATA 6.0Gb/s cables
Accessories	1 x I/O shield
Application DVD	ASUS motherboard support DVD
Documentation	User Manual



If any of the above items is damaged or missing, contact your retailer.

1.3 Special features

1.3.1 Product highlights



LGA1155 socket for Intel® 3rd/2nd Generation Core™ i7 / Core™ i5 / Core™ i3 / Pentium® / Celeron® Processors

This motherboard supports the Intel® 3rd/2nd generation Core™ i7/i5/i3/Pentium®/Celeron® processors in the LGA1155 package, with iGPU, memory, and PCI Express controllers integrated to support onboard graphics out with dedicated chipsets, 2-channel (4 DIMMs) DDR3 memory, and 16 PCI Express 3.0/2.0 lanes. This provides great graphics performance. Intel® 3rd/2nd generation Core™ i7 / i5 / i3 / Pentium® / Celeron® processors are among the most powerful and energy efficient CPUs in the world.

Intel® Q77 Express Chipset

The Intel® Q77 Express Chipset is a single-chipset designed to support the 1155 socket Intel® 3rd/2nd generation Core™ i7 / i5 / i3 / Pentium® / Celeron® processors. It provides improved performance by utilizing serial point-to-point links, allowing increased bandwidth and stability. Additionally, Q77 chipset provides 4 USB 3.0 ports for 10 times faster data retrieval speed.



Dual-Channel DDR3 1600 / 1333 / 1066MHz support

The motherboard supports DDR3 memory that features data transfer rates of 1600 / 1333 / 1066 MHz to meet the higher bandwidth requirements of the latest 3D graphics, multimedia, and Internet applications. The dual-channel DDR3 architecture enlarges the bandwidth of your system memory to boost system performance.



Native SATA 6.0 Gb/s support

The Intel® Q77 Express Chipset natively supports next-generation Serial ATA (SATA) storage interface. This motherboard delivers up to 6.0 Gb/s data transfer rates. Additionally, get enhanced scalability, faster data retrieval, double the bandwidth of current bus systems.



Complete USB 3.0 Integration

ASUS facilitates strategic USB 3.0 accessibility for both the front and rear panel – 4 USB 3.0 ports in total. Experience the latest plug & play connectivity at speeds up to 10 times faster than USB 2.0. This motherboard affords greater convenience to high speed connectivity.



Intel® Smart Response Technology

SSD Speed with HDD Capacity

Intel® Smart Response Technology boosts overall system performance by using an installed fast SSD (min 18.6GB available capacity required) as a cache for frequently accessed data. Key benefits include reduced load and wait times, and lower power consumption through the elimination of unnecessary hard drive spin. This technology combines SSD performance with hard drive capacity, operating up to 6X faster than a hard drive-only system.

* Intel® Smart Response Technology is supported by 3rd/2nd generation Intel® Core™ processor family on Windows® 7™ operating systems.

** Operating systems must be installed on the HDD to launch Intel® Smart Response Technology.

The capacity of the SSD is reserved for caching function.

Intel® Smart Connect Technology

Your computer could receive web updates with fresh content for selected applications, even when setting the system to sleep. This means less time waiting for applications to start, update and sync with the cloud, providing a more efficient way.

Intel® Rapid Start Technology

Allows your computer to quickly resume from a low-power hibernate state in seconds. Saving system memory to the designed SSD, provides your computer a faster wake-up response time, while keeping the energy use low.



PCI Express® 3.0

PCI Express® 3.0 (PCIe 3.0) is the latest PCI Express bus standard with improved encoding schemes that provide twice the performance of the current PCIe 2.0. The total bandwidth for a x16 link reaches a maximum of 32Gb/s, double the 16 Gb/s of PCIe 2.0 (in x16 mode). As such, PCIe 3.0 provides users an unprecedented data speeds, combined with the convenience and seamless transition offered by complete backward compatibility with PCIe 1.0 and PCIe 2.0 devices. PCIe 3.0 will become a must-have feature for users who wish to improve and optimize graphic performance, as well as have the latest technology available to them.

* PCI 3.0 speed is supported by Intel® 3rd generation Core™ processors.

1.3.2 Innovative ASUS features



ASUS UEFI BIOS

Flexible and Easy BIOS Interface

ASUS UEFI BIOS offers the first mouse-controlled graphical BIOS designed with selectable modes, providing a user-friendly interface that goes beyond the traditional keyboard-only controls. It also natively supports fully-utilized hard drives larger than 2.2TB in 64-bit operating systems.

ASUS exclusive interface

EZ Mode displays frequently-accessed info. Users can choose system performance settings, and drag and drop boot priorities. Advanced Mode for performance enthusiasts includes detailed DRAM settings via a dedicated memory info page for complete insight.

New upgrade! Quick and easy information for enhanced system control

- F12 BIOS snapshot hotkey for sharing UEFI information and troubleshooting
- New F3 Shortcut for most accessed information
- ASUS DRAM SPD (Serial Presence Detect) information for accessing memory information, detecting faulty DIMMs, and helping with difficult POST situations.



USB 3.0 Boost

With USB 3.0 Boost technology, a USB device's transmission speed is significantly increased, adding to an already impressive fast USB 3.0 transfer speed. ASUS software automatically accelerates data speeds for compatible USB 3.0 peripherals without the need for any user interaction.



GPU Boost

Go to the Limit with iGPU Level Up!

GPU Boost accelerates the integrated GPU for extreme graphics performance. The user-friendly interface facilitates flexible frequency adjustments. It easily delivers stable system-level upgrades for every use.



MemOK!

MemOK! quickly ensures memory boot compatibility. This remarkable memory rescue tool requires a mere push of the button to patch memory issues. MemOK! determines failsafe settings and dramatically improves your system boot success. Get your system up and running in no time.



AI Suite II

With its fast user-friendly interface, ASUS AI Suite II consolidates all the exclusive ASUS features into one simple to use software package. It allows you to supervise overclocking, energy management, fan speed control, and voltage and sensor readings. This all-in-one software offers diverse and ease to use functions, with no need to switch back and forth between different utilities.



ASUS Anti-Surge Protection

This special design prevents expensive devices and the motherboard from damage caused by power surges from switching power supply (PSU).



ASUS Q-Fan 2

The ASUS Q-Fan 2 technology intelligently adjusts both CPU and chassis fan speeds according to system loading to ensure quiet, cool and efficient operation.



ASUS EPU

Tap into the world's first real-time PC power saving chip through the AI Suite II utility. Get total system-wide energy optimization by automatically detecting current PC loadings and intelligently moderating power consumption. This also reduces fan noise and extends component longevity.



ASUS MyLogo2™

This feature allows you to convert your favorite photo into a 256-color boot logo for a more colorful and vivid image on your screen.



ASUS CrashFree BIOS 3

ASUS CrashFree BIOS 3 is an auto-recovery tool that allows you to restore a corrupted BIOS file using the bundled support DVD or USB flash disk that contains the latest BIOS file.



ASUS EZ Flash 2

ASUS EZ Flash 2 is a utility that allows you to update the BIOS without using an OS-based utility.



C.P.R. (CPU Parameter Recall)

The BIOS C.P.R. feature automatically restores the CPU default settings when the system hangs due to overclocking failure. C.P.R. eliminates the need to open the system chassis and clear the RTC data. Simply shut down and reboot the system, and the BIOS automatically restores the CPU parameters to their default settings.



ErP ready

The motherboard is European Union's Energy-related Products (ErP) ready, and ErP requires products to meet certain energy efficiency requirements in regards to energy consumptions. This is in line with ASUS vision of creating environment-friendly and energy-efficient products through product design and innovation to reduce carbon footprint of the product and thus mitigate environmental impacts.

1.4 Before you proceed

Take note of the following precautions before you install motherboard components or change any motherboard settings.



-
- Unplug the power cord from the wall socket before touching any component.
 - Before handling components, use a grounded wrist strap or touch a safely grounded object or a metal object, such as the power supply case, to avoid damaging them due to static electricity.
 - Hold components by the edges to avoid touching the ICs on them.
 - Whenever you uninstall any component, place it on a grounded antistatic pad or in the bag that came with the component.
 - Before you install or remove any component, ensure that the ATX power supply is switched off or the power cord is detached from the power supply. Failure to do so may cause severe damage to the motherboard, peripherals, or components.
-

1.5 Motherboard overview

Before you install the motherboard, study the configuration of your chassis to ensure that the motherboard fits into it.



Ensure that you unplug the power cord before installing or removing the motherboard. Failure to do so can cause you physical injury and damage motherboard components.

1.5.1 Placement direction

When installing the motherboard, ensure that you place it into the chassis in the correct orientation. The edge with external ports goes to the rear part of the chassis as indicated in the image below.

1.5.2 Screw holes

Place six screws into the holes indicated by circles to secure the motherboard to the chassis.



Do not overtighten the screws! Doing so can damage the motherboard.

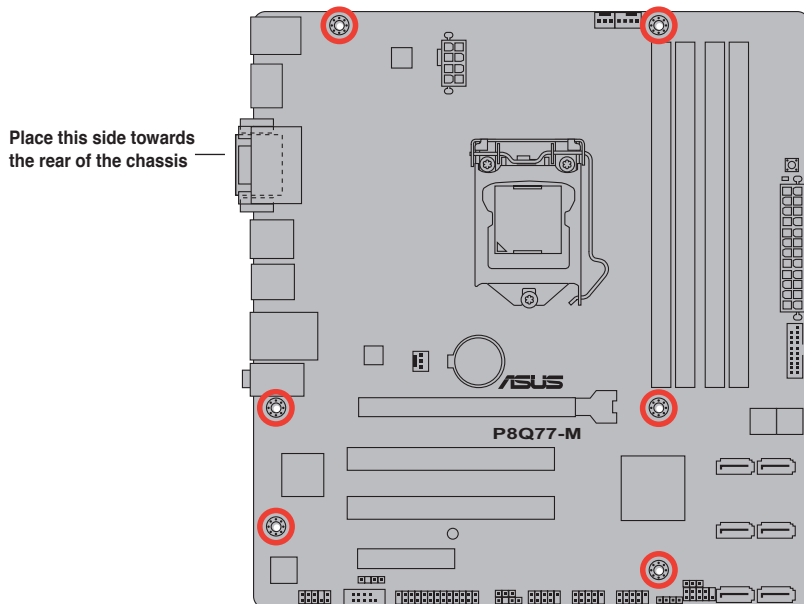

1.5.3 Motherboard layout

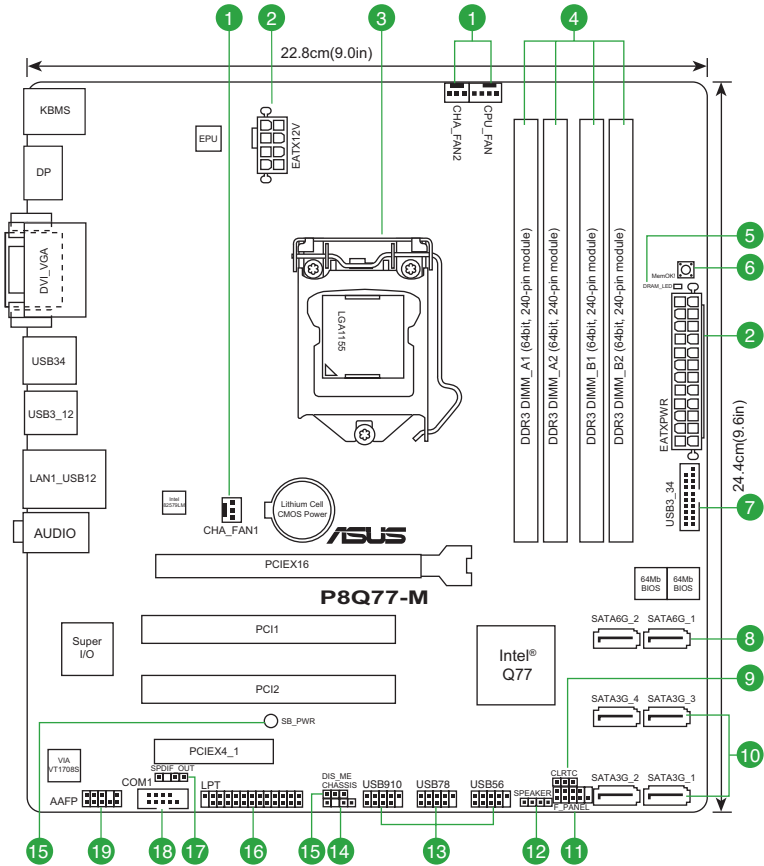

1.5.4 Layout contents

Connectors/Jumpers/Slots/LED	Page	Connectors/Jumpers/Slots/LED	Page
1. CPU and chassis fan connectors (4-pin CPU_FAN, 3-pin CHA_FAN1/2)	1-24	11. System panel connector (10-1 pin F_PANEL)	1-28
2. ATX power connectors (24-pin EATXPWR, 8-pin EATX12V)	1-25	12. Speaker connector (4-pin SPEAKER)	1-27
3. Intel® LGA1155 CPU socket	1-8	13. USB 2.0 connectors (10-1 pin USB5~10)	1-29
4. DDR3 DIMM slots	1-13	14. Chassis intrusion connector (4-1 pin CHASSIS)	1-24
5. DRAM LED (DRAM_LED)	1-31	15. Intel® ME jumper (3-pin DIS_ME)	1-21
6. MemOK! switch	1-30	16. LPT connector (26-1 pin LPT)	1-28
7. USB 3.0 connector (20-1 pin USB3_34)	1-29	17. Digital audio connector (4-1 pin SPDIF_OUT)	1-25
8. Intel® Q77 Serial ATA 6.0Gb/s connectors (7-pin SATA6G_1/2 [gray])	1-26	18. Serial port connector (10-1 pin COM1)	1-23
9. Clear RTC RAM (3-pin CLRRTC)	1-20	19. Front panel audio connector (10-1 pin AAFP)	1-23
10. Intel® Q77 Serial ATA 3.0Gb/s connectors (7-pin SATA3G_1~4 [blue])	1-27	20. Standby power LED (SB_PWR)	1-31

1.6 Central Processing Unit (CPU)

The motherboard comes with a surface mount LGA1155 socket designed for the Intel® 3rd/2nd Generation Core™ i7 / Core™ i5 / Core™ i3 / Pentium® / Celeron® processors.

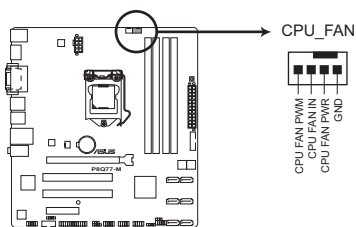

P8Q77-M CPU fan connector



Unplug all power cables before installing the CPU.



- Upon purchase of the motherboard, ensure that the PnP cap is on the socket and the socket contacts are not bent. Contact your retailer immediately if the PnP cap is missing, or if you see any damage to the PnP cap/socket contacts/motherboard components. ASUS will shoulder the cost of repair only if the damage is shipment/transit-related.
 - Keep the cap after installing the motherboard. ASUS will process Return Merchandise Authorization (RMA) requests only if the motherboard comes with the cap on the LGA1155 socket.
 - The product warranty does not cover damage to the socket contacts resulting from incorrect CPU installation/removal, or misplacement/loss/incorrect removal of the PnP cap.
-

1.6.1 Installing the CPU



The LGA1156 CPU is incompatible with the LGA1155 socket. DO NOT install a LGA1156 CPU on the LGA1155 socket.

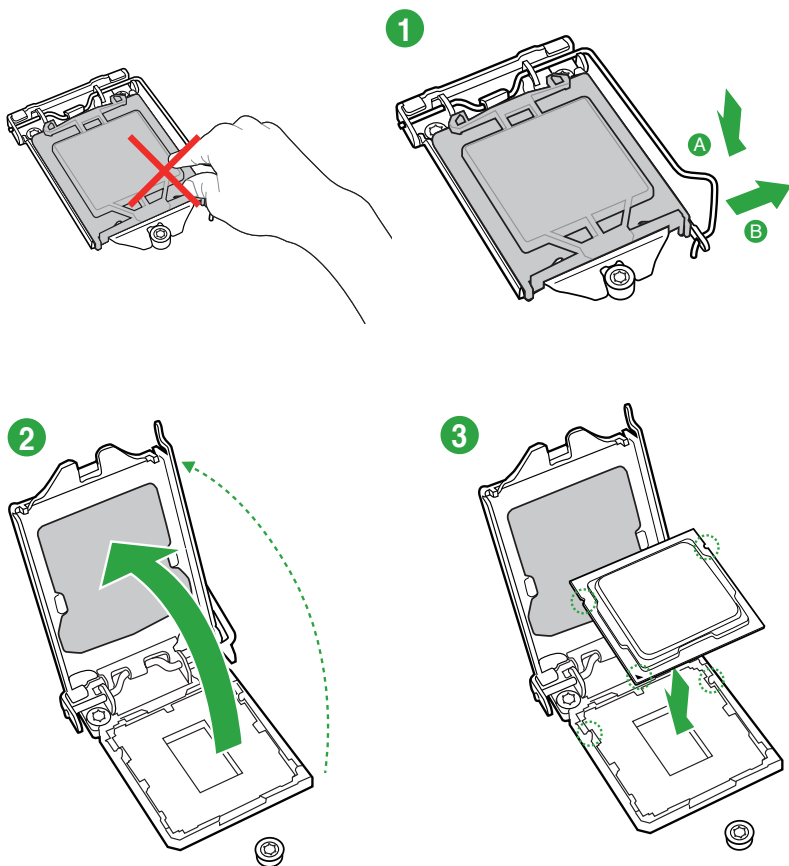

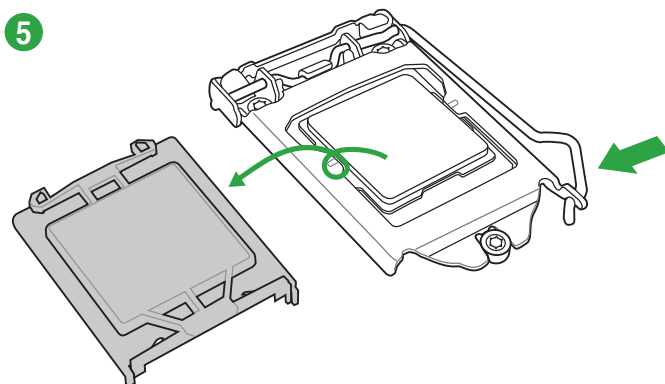
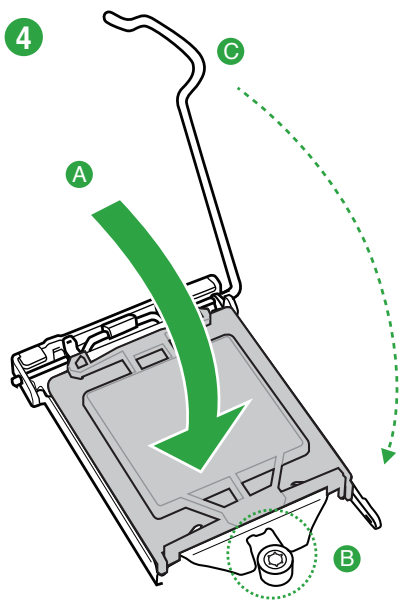

1.6.2 CPU heatsink and fan assembly installation

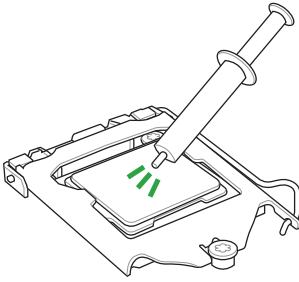

Apply the Thermal Interface Material to the CPU heatsink and CPU before you install the heatsink and fan if necessary.

To install the CPU heatsink and fan assembly

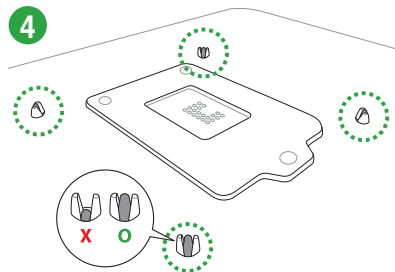
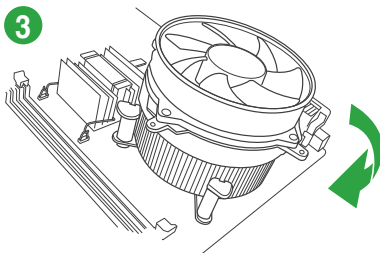
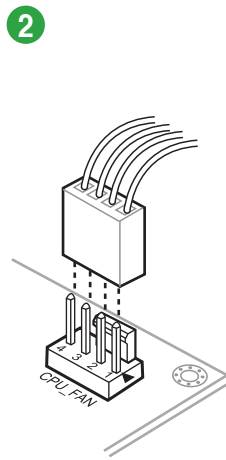
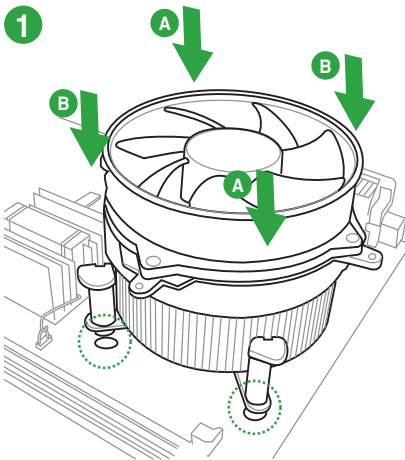

To uninstall the CPU heatsink and fan assembly

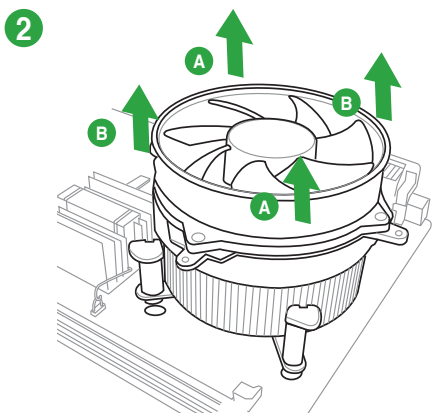
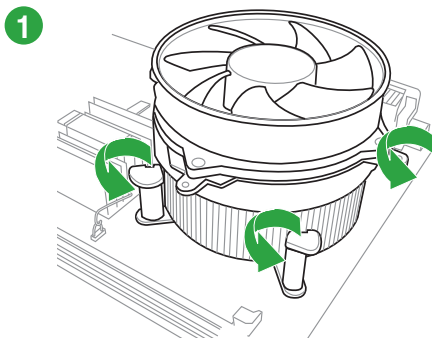

1.7 System memory

1.7.1 Overview

The motherboard comes with four Double Data Rate 3 (DDR3) Dual Inline Memory Modules (DIMM) sockets. A DDR3 module has the same physical dimensions as a DDR2 DIMM but is notched differently to prevent installation on a DDR2 DIMM socket. DDR3 modules are developed for better performance with less power consumption.

The figure illustrates the location of the DDR3 DIMM sockets:

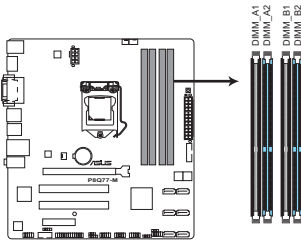

P8Q77-M 240-pin DDR3 DIMM sockets

Channel	Sockets
Channel A	DIMM_A1 and DIMM_A2
Channel B	DIMM_B1 and DIMM_B2

1.7.2 Memory configurations

You may install 1GB, 2GB, 4GB, and 8GB unbuffered non-ECC DDR3 DIMMs into the DIMM sockets.



- You may install varying memory sizes in Channel A and Channel B. The system maps the total size of the lower-sized channel for the dual-channel configuration. Any excess memory from the higher-sized channel is then mapped for single-channel operation.
- Always install DIMMs with the same CAS latency. For optimum compatibility, we recommend that you obtain memory modules from the same vendor.
- Due to the memory address limitation on 32-bit Windows® OS, when you install 4GB or more memory on the motherboard, the actual usable memory for the OS can be about 3GB or less. For effective use of memory, we recommend that you do any of the following:
 - Use a maximum of 3GB system memory if you are using a 32-bit Windows® OS.
 - Install a 64-bit Windows® OS when you want to install 4GB or more on the motherboard.
- This motherboard does not support DIMMs made up of 512Mb (64MB) chips or less.



- The default memory operation frequency is dependent on its Serial Presence Detect (SPD), which is the standard way of accessing information from a memory module. Under the default state, some memory modules for overclocking may operate at a lower frequency than the vendor-marked value. To operate at the vendor-marked or at a higher frequency, refer to section **2.4 Ai Tweaker menu** for manual memory frequency adjustment.
- For system stability, use a more efficient memory cooling system to support a full memory load (4 DIMMs) or overclocking condition.

P8Q77-M Motherboard Qualified Vendors Lists (QVL)

DDR3-1600 MHz capability

Vendors	Part No.	Size	SS/DS	Chip Brand	Chip NO.	Timing	Voltage	DIMM socket support (Optional)		
								1 DIMM	2 DIMM	4 DIMM
A-DATA	AM2U16BC2P1	2GB	SS	A-DATA	3CCD-1509A EL1126T	-	-	*	*	*
A-DATA	AD31600E001GM(O)U3K	3GB(3 x 1GB)	SS	-	-	8-8-8-24	1.65V-1.85V	*	*	*
A-DATA	AX3U1600XB2G79-2X(XMP)	4GB(2 x 2GB)	DS	-	-	7-9-7-21	1.55V-1.75V	*	*	*
A-DATA	AM2U16BC4P2	4GB	DS	A-DATA	3CCD-1509A EL1126T	-	-	*	*	*
A-DATA	AX3U1600GC4G9-2G(XMP)	8GB(2 x 4GB)	DS	-	-	9-9-9-24	1.55V-1.75V	*	*	*
A-DATA	AX3U1600XC4G79-2X(XMP)	8GB(2 x 4GB)	DS	-	-	7-9-7-21	1.55V-1.75V	*	*	*
Corsair	TR3X3G1600C8D(XMP)	3GB(3 x 1GB)	SS	-	-	8-8-8-24	1.65V	*	*	*
Corsair	CMD12GX3M6A1600C8(XMP)	12GB(6x2GB)	DS	-	-	8-8-8-24	1.65V	*	*	*
Corsair	CMP4GX3M2A1600C8(XMP)	4GB(2 x 2GB)	DS	-	-	8-8-8-24	1.65V	*	*	*
Corsair	CMP4GX3M2A1600C9(XMP)	4GB(2 x 2GB)	DS	-	-	9-9-9-24	1.65V	*	*	*
Corsair	CMP4GX3M2C1600C7(XMP)	4GB(2 x 2GB)	DS	-	-	7-8-7-20	1.65V	*	*	*
Corsair	CMX4GX3M2A1600C9(XMP)	4GB(2 x 2GB)	DS	-	-	9-9-9-24	1.65V	*	*	*
Corsair	CMX4GX3M2A1600C9(XMP)	4GB(2 x 2GB)	DS	-	-	9-9-9-24	1.65V	*	*	*
Corsair	TR3X6G1600C8 G(XMP)	6GB(3 x 2GB)	DS	-	-	8-8-8-24	1.65V	*	*	*
Corsair	TR3X6G1600C8D G(XMP)	6GB(3 x 2GB)	DS	-	-	8-8-8-24	1.65V	*	*	*
Corsair	TR3X6G1600C9 G(XMP)	6GB(3 x 2GB)	DS	-	-	9-9-9-24	1.65V	*	*	*
Corsair	CMP8GX3M2A1600C9(XMP)	8GB(2 x 4GB)	DS	-	-	9-9-9-24	1.65V	*	*	*
Corsair	CMX8GX3M4A1600C9(XMP)	8GB(4 x 2GB)	DS	-	-	9-9-9-24	1.65V	*	*	*
Crucial	BL25664BN1608.16FF(XMP)	6GB(3 x 2GB)	DS	-	-	-	-	*	*	*
G.SKILL	F3-12800CL9D-2GBNQ(XMP)	2GB(2 x 1GB)	SS	-	-	9-9-9-24	1.5V	*	*	*
G.SKILL	F3-12800CL7D-4GBRH(XMP)	4GB(2 x 2GB)	SS	-	-	7-7-7-24	1.6V	*	*	*
G.SKILL	F3-12800CL7D-4GBECO(XMP)	4GB(2 x 2GB)	DS	-	-	7-7-8-24	XMP 1.35V	*	*	*
G.SKILL	F3-12800CL7D-4GBRM(XMP)	4GB(2 x 2GB)	DS	-	-	7-8-7-24	1.6V	*	*	*
G.SKILL	F3-12800CL8D-4GBRM(XMP)	4GB(2 x 2GB)	DS	-	-	8-8-8-24	1.60V	*	*	*
G.SKILL	F3-12800CL9D-4GBECO(XMP)	4GB(2 x 2GB)	DS	-	-	9-9-9-24	XMP 1.35V	*	*	*
G.SKILL	F3-12800CL9D-4GBRL(XMP)	4GB(2 x 2GB)	DS	-	-	9-9-9-24	1.5V	*	*	*
G.SKILL	F3-12800CL9T-6GBNQ(XMP)	6GB(3 x 2GB)	DS	-	-	9-9-9-24	1.5V~1.6V	*	*	*
G.SKILL	F3-12800CL7D-8GBRH(XMP)	8GB(2 x 4GB)	DS	-	-	7-8-7-24	1.6V	*	*	*
G.SKILL	F3-12800CL8D-8GBECO(XMP)	8GB(2 x 4GB)	DS	-	-	8-8-8-24	XMP 1.35V	*	*	*
G.SKILL	F3-12800CL9D-8GBRL(XMP)	8GB(2 x 4GB)	DS	-	-	9-9-9-24	1.5V	*	*	*
GEIL	GET316GB1600C9QC(XMP)	16GB(4 x 4GB)	DS	-	-	9-9-9-28	1.6V	*	*	*
GEIL	GV34GB1600C8DC(XMP)	2GB	DS	-	-	8-8-8-28	1.6V	*	*	*
Kingmax	FLGD45F-B8MF7 MAEH(XMP)	1GB	SS	-	-	7	-	*	*	*
Kingmax	FLGE85F-B8MF7 MEEH(XMP)	2GB	DS	-	-	7	-	*	*	*
Kingston	KHX1600C9D3P1K2/4G	4GB(2 x 2GB)	SS	-	-	-	1.5V	*	*	*
Kingston	KHX1600C9D3K3/12GX(XMP)	12GB(3x4GB)	DS	-	-	9-9-9-27	1.65V	*	*	*
Kingston	KHX1600C9D3T1BK3/12GX(XMP)	12GB(3x4GB)	DS	-	-	9-9-9-27	1.65V	*	*	*
Kingston	KHX1600C9AD3/2G	2GB	DS	-	-	-	1.65V	*	*	*
Kingston	KVR1600D3N11/2G-ES	2GB	DS	KTC	D1288JPNPD PLD9U	11-11-11-28	1.35V-1.5V	*	*	*
Kingston	KHX1600C7D3K2/4GX(XMP)	4GB(2 x 2GB)	DS	-	-	-	1.65V	*	*	*
Kingston	KHX1600C8D3K2/4GX(XMP)	4GB(2 x 2GB)	DS	-	-	8	1.65V	*	*	*
Kingston	KHX1600C8D3T1K2/4GX(XMP)	4GB(2 x 2GB)	DS	-	-	8	1.65V	*	*	*
Kingston	KHX1600C9D3K2/4GX(XMP)	4GB(2 x 2GB)	DS	-	-	9	1.65V	*	*	*
Kingston	KHX1600C9D3L2/4GX(XMP)	4GB(2 x 2GB)	DS	-	-	9	XMP 1.35V	*	*	*
Kingston	KHX1600C9D3X2K2/4GX(XMP)	4GB(2 x 2GB)	DS	-	-	9-9-9-27	1.65V	*	*	*
Kingston	KHX1600C9D3T1K3/6GX(XMP)	6GB(3 x 2GB)	DS	-	-	-	1.65V	*	*	*
Kingston	KHX1600C9D3K3/6GX(XMP)	6GB(3 x 2GB)	DS	-	-	9	1.65V	*	*	*
Kingston	KHX1600C9D3T1BK3/6GX(XMP)	6GB(3 x 2GB)	DS	-	-	9-9-9-27	1.65V	*	*	*
Kingston	KHX1600C9D3K2/8GX(XMP)	8GB(2 x 4GB)	DS	-	-	9-9-9-27	1.65V	*	*	*
Kingston	KHX1600C9D3P1K2/8G	8GB(2 x 4GB)	DS	-	-	-	1.5V	*	*	*
Super Talent	WA1600UX6G9	6GB(3 x 2GB)	DS	-	-	9	-	*	*	*
Transcend	JM1600KLN-8GK	8GB(4GBx2)	DS	Transcend	TK483PCW3	-	-	*	*	*
Asint	SLZ3128M8-EGJ1D(XMP)	2GB	DS	Asint	3128M8-GJ1D	9-9-9-24	1.6V	*	*	*
Elixir	M2P2G64C8BHC9N-DG(XMP)	2GB	DS	-	-	-	-	*	*	*
Kingtiger	KTG2G1600P3	2GB	DS	-	-	-	-	*	*	*
Mushkin	998659(XMP)	6GB(3 x 2GB)	DS	-	-	9-9-9-24	-	*	*	*
Mushkin	998659(XMP)	6GB(3 x 2GB)	DS	-	-	9-9-9-24	1.5~1.6V	*	*	*
PATRIOT	PGSS4G1600LLKA	4GB(2 x 2GB)	DS	-	-	7-7-7-20	1.7V	*	*	*

DDR3-1333 MHz capability

Vendors	Part No.	Size	SS/ DS	Chip Brand	Chip NO.	Timing	Voltage	DIMM socket support (Optional)		
								1 DIMM	2 DIMM	4 DIMM
A-DATA	AD31333001GOU	1GB	SS	A-Data	AD30908C8D-151C E0906	-	-	*	*	*
A-DATA	AD3U1333C2G9	2GB	SS	A-DATA	3CCD-1509HNA1126L	-	-	*	*	*
A-DATA	AD6311B0823EV	2GB	SS	A-Data	3CCA-1509A	-	-	*	*	*
A-DATA	AM2U139C2P1	2GB	SS	ADATA	3CCD-1509A EL1127T	-	-	*	*	*
A-DATA	AX3U1333C2G9-BP	2GB	SS	-	-	-	-	*	*	*
A-DATA	AD31333G001GOU	3GB(3 x 1GB)	SS	-	-	8-8-8-24	1.65-1.85V	*	*	*
A-DATA	AXDU1333G2G9-2G(XMP)	4GB(2 x 2GB)	SS	-	-	9-9-9-24	1.25V- 1.35V(low voltage)	*	*	*
A-DATA	AD31333G002GMU	2GB	DS	-	-	8-8-8-24	1.65-1.85V	*	*	*
A-DATA	AD6311C1624EV	4GB	DS	A-Data	3CCA-1509A	-	-	*	*	*
A-DATA	AM2U139C4P2	4GB	DS	ADATA	3CCD-1509A EL1127T	-	-	*	*	*
A-DATA	SU3U1333W8G9-B	8GB	DS	ELPIDA	J4208BASE-DJ-F	-	-	*	*	*
Apacer	78.A1GC6.9L1	2GB	DS	Apacer	AM5D5808DEW5BG	-	-	*	*	*
Apacer	78.A1GC6.9L1	2GB	DS	Apacer	AM5D5808FEQ5BG	9	-	*	*	*
Apacer	AU02GFA33C9NBGC	2GB	DS	Apacer	AM5D5808APQ5BG	-	-	*	*	*
Apacer	78.B1GDE.9L10C	4GB	DS	Apacer	AM5D5908CEHSBG	-	-	*	*	*
Corsair	CM3X1024-1333C9	1GB	SS	-	-	9-9-9-24	1.60V	*	*	*
Corsair	TR3X3G1333C9 G	3GB(3 x 1GB)	SS	-	-	9-9-9-24	1.50V	*	*	*
Corsair	TR3X6G1333C9 G	6GB(3x 2GB)	SS	-	-	9-9-9-24	1.50V	*	*	*
Corsair	CMD24GX3M6A1333C9(XMP)	24GB(6x4GB)	DS	-	-	9-9-9-24	1.60V	*	*	*
Corsair	TW3X4G1333C9D G	4GB(2 x 2GB)	DS	-	-	9-9-9-24	1.50V	*	*	*
Corsair	CM3X4GA1333C9N2	4GB	DS	Corsair	256MBDCJGELC 0401136	9-9-9-24	-	*	*	*
Corsair	CMX4GX3M1A1333C9	4GB	DS	-	-	9-9-9-24	1.50V	*	*	*
Corsair	CM08GX3M4A1333C7	8GB(4 x 2GB)	DS	-	-	7-7-7-20	1.60V	*	*	*
Crucial	CT12864BA1339.8FF	1GB	SS	Micron	9FF22D9KPT	9	-	*	*	*
Crucial	CT25664BA1339.16FF	2GB	DS	Micron	9KF27D9KPT	9	-	*	*	*
Crucial	BL25664BN1337.16FF (XMP)	6GB(3 x 2GB)	DS	-	-	7-7-7-24	1.65V	*	*	*
ELPIDA	EBJ10UE8EDF0-DJ-F	1GB	SS	ELPIDA	J1108EDSE-DJ-F	-	1.35V(low voltage)	*	*	*
ELPIDA	EBJ21UE8EDF0-DJ-F	2GB	SS	ELPIDA	J1108EDSE-DJ-F	-	1.35V(low voltage)	*	*	*
G.SKILL	F3-10600CL8D-2GBHK(XMP)	1GB	SS	G.SKILL	-	-	-	*	*	*
G.SKILL	F3-10600CL9D-2GBNQ	2GB(2 x 1GB)	SS	-	-	9-9-9-24	1.5V	*	*	*
G.SKILL	F3-10666CL7T-3GBPK(XMP)	3GB(3 x 1GB)	SS	-	-	7-7-7-18	1.5-1.6V	*	*	*
G.SKILL	F3-10666CL8D-4GBECO(XMP)	4GB(2 x 2GB)	DS	-	-	8-8-8-24	XMP 1.35V	*	*	*
G.SKILL	F3-10666CL7T-6GBPK(XMP)	6GB(3 x 2GB)	DS	-	-	7-7-7-18	1.5-1.6V	*	*	*
G.SKILL	F3-10666CL7D-8GBRH(XMP)	8GB(2 x 4GB)	DS	-	-	7-7-7-21	1.5V	*	*	*
GEIL	GET316GB1333C9QC	16GB(4x4GB)	DS	-	-	9-9-9-24	1.5V	*	*	*
GEIL	GV32GB1333C9DC	2GB(2 x 1GB)	DS	-	-	9-9-9-24	1.5V	*	*	*
GEIL	GG34GB1333C9DC	4GB(2 x 2GB)	DS	GEIL	GL1L128M88BA12N	9-9-9-24	1.3V(low voltage)	*	*	*
GEIL	GV34GB1333C9DC	4GB(2 x 2GB)	DS	-	-	9-9-9-24	1.5V	*	*	*
GEIL	GVP34GB1333C7DC	4GB(2 x 2GB)	DS	-	-	7-7-7-24	1.5V	*	*	*
Hynix	HMT112U6TFR8A-H9	1GB	SS	Hynix	H5TC1G83TFRH9A	-	1.35V(low voltage)	*	*	*
Hynix	HMT325U6BFR8C-H9	2GB	SS	Hynix	H5TQ2G83BFRH9C	-	-	*	*	*
Hynix	HMT125U6TFR8A-H9	2GB	DS	Hynix	H5TC1G83TFRH9A	-	1.35V(low voltage)	*	*	*
Hynix	HMT351U6BFR8C-H9	4GB	DS	Hynix	H5TQ2G83BFRH9C	-	-	*	*	*
Kingmax	FLFD45F-B8KL9 NAES	1GB	SS	Kingmax	KKB8FNWBFGNX-27A	-	-	*	*	*
Kingmax	FLFE85F-C8K9 CAES	2GB	SS	Kingmax	KFC8FNMXF-BXX-15A	-	-	*	*	*
Kingmax	FLFE85F-C8KL9 NAES	2GB	SS	Kingmax	KFC8FNLXF-DXX-15A	-	-	*	*	*
Kingmax	FLFE85F-C8KM9 NAES	2GB	SS	Kingmax	KFC8FNMXF-BXX-15A	-	-	*	*	*
Kingmax	FLFE85F-B8KL9 NEES	2GB	DS	Kingmax	KKB8FNWBFGNX-26A	-	-	*	*	*
Kingmax	FLFF65F-C8KL9 NEES	4GB	DS	Kingmax	KFC8FNLXF-DXX-15A	-	-	*	*	*
Kingmax	FLFF65F-C8KM9 NEES	4GB	DS	Kingmax	KFC8FNMXF-BXX-15A	-	-	*	*	*
Kingston	KVR1333D3N9/1G(low profile)	1GB	SS	ELPIDA	J1108DBDG-DJ-F	9	1.5V	*	*	*
Kingston	KVR1333D3N9/2G(low profile)	2GB	SS	Hynix	H5TQ2G83AFRH9C	9	-	*	*	*
Kingston	KVR1333D3S8N9/2G-SP(low profile)	2GB	SS	ELPIDA	J2108BCSE-DJ-F	-	1.5V	*	*	*
Kingston	KVR1333D3N9/2G	2GB	DS	KTC	D1288JPNPLD9U	9	1.5V	*	*	*
Kingston	KVR1333D3N9/2G	2GB	DS	ELPIDA	J1108BDSE-DJ-F	9	1.5V	*	*	*
Kingston	KVR1333D3N9/2G-SP(low profile)	2GB	DS	KTC	D1288JEMFNGD9U	-	1.5V	*	*	*

(continued on the next page)

DDR3-1333 MHz capability

Vendors	Part No.	Size	SS/DS	Chip Brand	Chip NO.	Timing	Voltage	DIMM socket support (Optional)		
								1 DIMM	2 DIMM	4 DIMM
Kingston	KVR1333D3N9/2G-SP(low profile)	2GB	DS	Kingston	D128BJPSFPGD9U	-	1.5V	*	*	*
Kingston	KHX1333C7D3K2/4GX(XMP)	4GB(2 x 2GB)	DS	-	-	7	1.65V	*	*	*
Kingston	KHX1333C9D3UK2/4GX(XMP)	4GB(2 x 2GB)	DS	-	-	9	XMP 1.25V	*	*	*
Kingston	KVR1333D3N9/4G(low profile)	4GB	DS	ELPIDA	J2108BCSE-DJ-F	9	1.5V	*	*	*
Kingston	KVR1333D3N9/4G(low profile)	4GB	DS	ELPIDA	J2108BCSE-DJ-F	-	1.5V	*	*	*
Kingston	KVR1333D3N9/4G	4GB	DS	KTC	D2568JENCNGD9U	-	1.5V	*	*	*
Kingston	KVR1333D3N9/4G	4GB	DS	Hynix	H5TQ2G83AFR	-	-	*	*	*
Kingston	KVR1333D3N9/4G-SP(low profile)	4GB	DS	Kingston	D2568JENCPGD9U	-	1.5V	*	*	*
Micron	MT4JTF12864AZ-1G4D1	1GB	SS	Micron	QJD12D9LGG	-	-	*	*	*
Micron	MT8JTF12864AZ-1G4F1	1GB	SS	Micron	9FF22D9KPT	9	-	*	*	*
Micron	MT8JTF25664AZ-1G4D1	2GB	SS	Micron	QJD12D9LGG	-	-	*	*	*
Micron	MT8JTF25664AZ-1G4M1	2GB	SS	MICRON	IJM22 D9PFJ	-	-	*	*	*
Micron	MT16JTF25664AZ-1G4F1	2GB	DS	Micron	9KF27D9KPT	9	-	*	*	*
Micron	MT16JTF51264AZ-1G4D1	4GB	DS	Micron	OLD22D9LGG	-	-	*	*	*
NANYA	NT4GC64B8HG0NF-CG	4GB	DS	NANYA	NT5CB25M8MGN-CG	-	-	*	*	*
PSC	ALF7F8G73F-DJ2	1GB	SS	PSC	A3P1GF3FGF	-	-	*	*	*
PSC	ALF8F8G73F-DJ2	2GB	DS	PSC	A3P1GF3FGF	-	-	*	*	*
Samsung	M378B2873FHS-CH9	1GB	SS	Samsung	K4B1G0846F	-	-	*	*	*
Samsung	M378B5773DHO-CH9	2GB	SS	Samsung	K4B2G0846D	-	-	*	*	*
Samsung	M378B5673FH0-CH9	2GB	DS	Samsung	K4B1G0846F	-	-	*	*	*
Samsung	M378B5273CHO-CH9	4GB	DS	Samsung	K4B2G0846C	-	-	*	*	*
Samsung	M378B1G73AHO-CH9	8GB	DS	Samsung	K4B4G0846A-HCH9	-	-	*	*	*
Super Talent	W1333UA1GH	1GB	SS	Hynix	H5TQ1G83TFR	9	-	*	*	*
Super Talent	W1333UX2G8(XMP)	2GB(2x 1GB)	SS	-	-	8	-	*	*	*
Super Talent	W1333UB2GS	2GB	DS	Samsung	K4B1G0846F	9	-	*	*	*
Super Talent	W1333UB4GS	4GB	DS	Samsung	K4B2G0846C	-	-	*	*	*
Super Talent	W1333UX6GM	6GB(3x 2GB)	DS	Micron	0BF27D9KPT	9-9-9-24	1.5V	*	*	*
Transcend	JM1333KLN-2G	2GB	SS	Micron	0YD77D9LGG	-	-	*	*	*
Transcend	JM1333KLN-2G	2GB	SS	Hynix	H5TQ2G83BZRH9C	-	-	*	*	*
Transcend	JM1333KLU-2G	2GB	DS	Transcend	TK243PDF3	-	-	*	*	*
Transcend	TS256MLK64V3U	2GB	DS	Micron	9GF27D9KPT	-	-	*	*	*
Century	PC3-10600 DDR3-1333 9-9-9	1GB	SS	NANYA	NT5CB128M8DN-CF	-	-	*	*	*
Elixir	M2F2G64CB88B7N-CG	2GB	SS	Elixir	N2CB2G80BN-CG	-	-	*	*	*
Elixir	M2F2G64CB88D7N-CG	2GB	SS	Elixir	N2CB2G80DN-CG	-	-	*	*	*
Elixir	M2F2G64CB88G7N-CG	2GB	SS	Elixir	N2CB2G80GN-CG	-	-	*	*	*
Elixir	M2F4G64CB8H5N-CG	4GB	DS	Elixir	N2CB2G80BN-CG	-	-	*	*	*
Elixir	M2F4G64CB8H5DN-CG	4GB	DS	Elixir	N2CB2G80DN-CG	-	-	*	*	*
KINGSHARE	KSRPCD313332G	2GB	DS	PATRIOT	PM128M8D385-15	-	-	*	*	*
KINGSTEK	KSTD3PC-10600	2GB	SS	MICRON	PE911-125E	-	-	*	*	*
Kingtiger	2GB DIMM PC3-10666	2GB	DS	Samsung	SEC 904 HCH9 K4B1G0846D	-	-	*	*	*
Kingtiger	KTG2G1333PG3	2GB	DS	-	-	-	-	*	*	*
Markvision	BMD32048M1333C9-1123	2GB	DS	Markvision	M3D1288P-13	-	-	*	*	*
Markvision	BMD34096M1333C9-1124	4GB	DS	Markvision	M3D2568E-13	-	-	*	*	*
PATRIOT	PSD31G13332H	1GB	DS	-	-	9	-	*	*	*
PATRIOT	PSD31G13332	1GB	DS	PATRIOT	PM64M8D38U-15	-	-	*	*	*
PATRIOT	PSD32G13332H	2GB	DS	-	-	-	-	*	*	*
PATRIOT	PG38G1333EL(XMP)	8GB	DS	-	-	9-9-9-24	1.5V	*	*	*
RAMAXEL	RMR1870ED48E8F-1333	2GB	DS	ELPIDA	J1108BDBG-DJ-F	-	-	*	*	*
RAMAXEL	RMR1870EC58E9F-1333	4GB	DS	ELPIDA	J2108BCSE-DJ-F	-	-	*	*	*
RiDATA	C304627CB1AG22Fe	2GB	DS	RiDATA	N/A	9	-	*	*	*
RiDATA	E304459CB1AG32Cf	4GB	DS	RiDATA	N/A	9	-	*	*	*
Silicon Power	SP001GBLTU133S01	1GB	SS	NANYA	NT5CB128M8AN-CG	9	-	*	*	*
Silicon Power	SP001GBLTU133S02	1GB	SS	Elixir	N2CB1680AN-C6	9	-	*	*	*
Silicon Power	SP002GBLTU133S02	2GB	DS	Elixir	N2CB1680AN-C6	9	-	*	*	*
TAKEMS	TMS1GB364D081-107EY	1GB	SS	-	-	7-7-7-20	1.5V	*	*	*
TAKEMS	TMS2GB364D081-107EY	2GB	DS	-	-	7-7-7-20	1.5V	*	*	*
TAKEMS	TMS2GB364D081-138EY	2GB	DS	-	-	8-8-8-24	1.5V	*	*	*
TAKEMS	TMS2GB364D082-138EW	2GB	DS	-	-	8-8-8-24	1.5V	*	*	*
UMAX	E41302GP0-73BDB	2GB	DS	UMAX	U2S24D30TP-13	-	-	*	*	*
WINTEC	3WVS31333-2G-CNR	2GB	DS	AMPO	AM3420803-13H	-	-	*	*	*

DDR3-1066 MHz capability

Vendors	Part No.	Size	SS/DS	Chip Brand	Chip NO.	Timing	Voltage	DIMM socket support (Optional)		
								1 DIMM	2 DIMM	4 DIMM
Crucial	CT12864BA1067.8FF	1GB	SS	Micron	9GF22D9KPT	7	-	•	•	•
Crucial	CT25664BA1067.16FF	2GB	DS	Micron	9HF22D9KPT	7	-	•	•	•
ELPIDA	EBJ10UE8EDF0-AE-F	1GB	SS	ELPIDA	J1108EDSE-DJ-F	-	1.35V(low voltage)	•	•	•
ELPIDA	EBJ21UE8EDF0-AE-F	2GB	DS	ELPIDA	J1108EDSE-DJ-F	-	1.35V(low voltage)	•	•	•
Kingston	KVR1066D3N7/1G(low profile)	1GB	SS	ELPIDA	J1108BFSE-DJ-F	7	1.5V	•	•	•
Kingston	KVR1066D3N7/2G	2GB	DS	ELPIDA	J1108BDSE-DJ-F	7	1.5V	•	•	•
Kingston	KVR1066D3N7/4G	4GB	DS	Hynix	H5TQ2G83AFR	7	1.5V	•	•	•
Micron	MT8JTF12864AZ-1G1F1	1GB	SS	Micron	9GF22D9KPT	7	-	•	•	•
Micron	MT16JTF25664AZ-1G1F1	2GB	DS	Micron	9HF22D9KPT	7	-	•	•	•
Kingtiger	2GB DIMM PC3-8500	2GB	DS	Hynix	H5TQ1G83AFP G7C	-	-	•	•	•



Side(s): SS - Single-sided DS - Double-sided
DIMM support:

- **1 DIMM:** Supports one (1) module inserted into any slot as Single-channel memory configuration. **We suggest that you install the module into A2 slot.**
- **2 DIMMs:** Supports two (2) modules inserted into either the blue slots or the black slots as one pair of Dual-channel memory configuration. **We suggest that you install the modules into slots A2 and B2 for better compatibility.**
- **4 DIMMs:** Supports four (4) modules inserted into both the blue and black slots as two pairs of Dual-channel memory configuration.



Visit the ASUS website at www.asus.com for the latest QVL.

1.7.3 Installing a DIMM



Unplug the power supply before adding or removing DIMMs or other system components. Failure to do so can cause severe damage to both the motherboard and the components.

1. Press the retaining clips outward to unlock a DIMM socket.
2. Align a DIMM on the socket such that the notch on the DIMM matches the DIMM slot key on the socket.

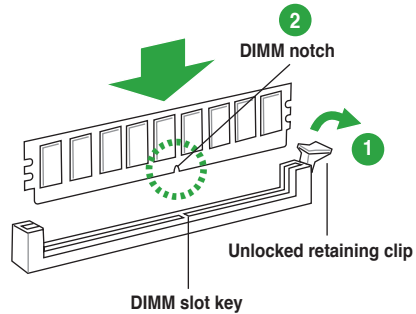

A DIMM is keyed with a notch so that it fits in only one direction. DO NOT force a DIMM into a socket in the wrong direction to avoid damaging the DIMM.

3. Firmly insert the DIMM into the socket until the retaining clips snap back in place and the DIMM is properly seated.

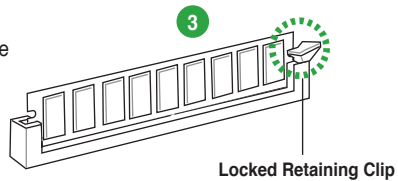

1.7.4 Removing a DIMM

To remove a DIMM:

1. Simultaneously press the retaining clips outward to unlock the DIMM.



Support the DIMM lightly with your fingers when pressing the retaining clips. The DIMM might get damaged when it flips out with extra force.

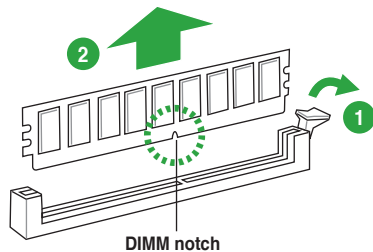

2. Remove the DIMM from the socket.

1.8 Expansion slots

In the future, you may need to install expansion cards. The following sub-sections describe the slots and the expansion cards that they support.



Unplug the power cord before adding or removing expansion cards. Failure to do so may cause you physical injury and damage motherboard components.

1.8.1 Installing an expansion card

To install an expansion card:

1. Before installing the expansion card, read the documentation that came with it and make the necessary hardware settings for the card.
2. Remove the system unit cover (if your motherboard is already installed in a chassis).
3. Remove the bracket opposite the slot that you intend to use. Keep the screw for later use.
4. Align the card connector with the slot and press firmly until the card is completely seated on the slot.
5. Secure the card to the chassis with the screw you removed earlier.
6. Replace the system cover.

1.8.2 Configuring an expansion card

After installing the expansion card, configure it by adjusting the software settings.

1. Turn on the system and change the necessary BIOS settings, if any. See Chapter 2 for information on BIOS setup.
2. Assign an IRQ to the card.
3. Install the software drivers for the expansion card.



When using PCI cards on shared slots, ensure that the drivers support “Share IRQ” or that the cards do not need IRQ assignments. Otherwise, conflicts will arise between the two PCI groups, making the system unstable and the card inoperable.

1.8.3 PCI slot

The PCI slots support cards such as a LAN card, SCSI card, USB card, and other cards that comply with PCI specifications.

1.8.4 PCI Express x4 slot

This motherboard supports PCI Express x4 network cards, SCSI cards, and other cards that comply with the PCI Express specifications.

1.8.5 PCI Express x16 slot

This motherboard has a PCI Express 3.0 x16 slot that supports PCI Express x16 3.0/2.0 graphic cards complying with the PCI Express specifications.

IRQ assignments for this motherboard

	A	B	C	D	E	F	G	H
Intel PCH SATA controller #0	-	-	-	shared	-	-	-	-
Intel PCH SATA controller #1	-	-	-	shared	-	-	-	-
Realtek 8111F controller	-	shared	-	-	-	-	-	-

1.9 Jumpers

1. Clear RTC RAM (3-pin CLRTC)

This jumper allows you to clear the Real Time Clock (RTC) RAM in CMOS. You can clear the CMOS memory of date, time, and system setup parameters by erasing the CMOS RTC RAM data. The onboard button cell battery powers the RAM data in CMOS, which include system setup information such as system passwords.

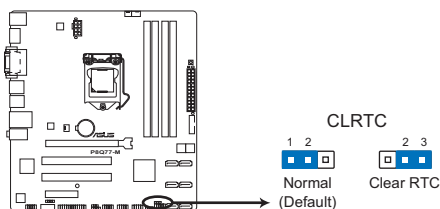

P8Q77-M Clear RTC RAM

To erase the RTC RAM:

1. Turn OFF the computer and unplug the power cord.
2. Move the jumper cap from pins 1-2 (default) to pins 2-3. Keep the cap on pins 2-3 for about 5-10 seconds, then move the cap back to pins 1-2.
3. Plug the power cord and turn ON the computer.
4. Hold down the key during the boot process and enter BIOS setup to re-enter data.



Except when clearing the RTC RAM, never remove the cap on CLRTC jumper default position. Removing the cap will cause system boot failure!



- If the steps above do not help, remove the onboard battery and move the jumper again to clear the CMOS RTC RAM data. After clearing the CMOS, reinstall the battery.
- You do not need to clear the RTC when the system hangs due to overclocking. For system failure due to overclocking, use the CPU Parameter Recall (C.P.R.) feature. Shut down and reboot the system, then the BIOS automatically resets parameter settings to default values.

2. Intel® ME jumper (3-pin DIS_ME)

This jumper allows you to enable or disable the Intel® ME function. Set this jumper to pins 1-2 to enable (default) the Intel® ME function and to pins 2-3 to disable it.

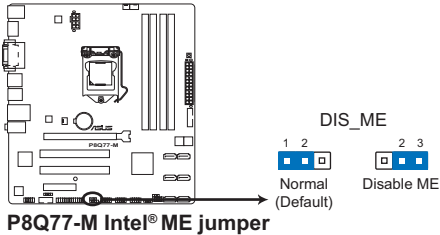

Disable the Intel® ME function only when you want to update it.

1.10 Connectors

1.10.1 Rear panel connectors

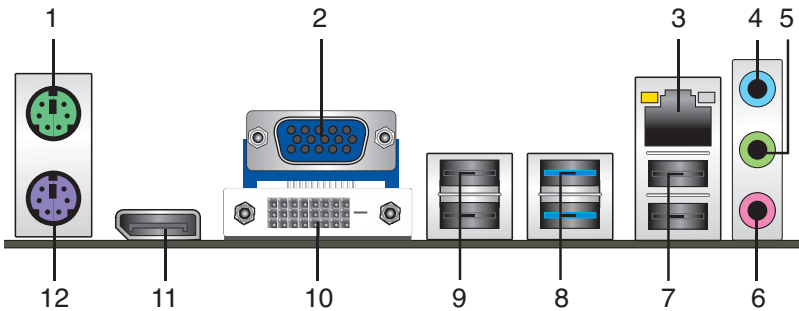

1. **PS/2 Mouse port (green).** This port is for a PS/2 mouse.
2. **Video Graphics Adapter (VGA) port.** This 15-pin port is for a VGA monitor or other VGA-compatible devices.
3. **LAN (RJ-45) port.** This port allows Gigabit connection to a Local Area Network (LAN) through a network hub. Refer to the table below for the LAN port LED indications.

LAN port LED indications

ACT/LINK LED		SPEED LED	
Status	Description	Status	Description
OFF	No link	OFF	10 Mbps connection
ORANGE	Linked	ORANGE	100 Mbps connection
BLINKING	Data activity	GREEN	1 Gbps connection

Activity Link LED Speed LED



LAN port

4. **Line In port (light blue).** This port connects the tape, CD, DVD player, or other audio sources.
5. **Line Out port (lime).** This port connects to a headphone or a speaker. In 4-channel, 6-channel, and 8-channel configurations, the function of this port becomes Front Speaker Out.
6. **Microphone port (pink).** This port connects a microphone.



Refer to the audio configuration table below for the function of the audio ports in the 2, 4, 6, or 8-channel configuration.

Audio 2, 4, 6, 8-channel configuration

Port	Headset 2-channel	4-channel	6-channel	8-channel
Light Blue (Rear panel)	Line In	Rear Speaker Out	Rear Speaker Out	Rear Speaker Out
Lime (Rear panel)	Line Out	Front Speaker Out	Front Speaker Out	Front Speaker Out
Pink (Rear panel)	Mic In	Mic In	Bass/Center	Bass/Center
Lime (Front panel)	-	-	-	Side Speaker Out



To configure an 8-channel audio output:

Use a chassis with HD audio module in the front panel to support an 8-channel audio output.

7. **USB 2.0 ports 1 and 2.** These two 4-pin Universal Serial Bus (USB) ports are available for connecting USB 2.0/1.1 devices.
8. **USB 3.0 ports 1 and 2.** These two 9-pin Universal Serial Bus (USB) ports connect to USB 3.0/2.0 devices.



- DO NOT connect a keyboard / mouse to any USB 3.0 port when installing Windows® operating system.
- Due to USB 3.0 controller limitation, USB 3.0 devices can only be used under Windows® OS environment and after the USB 3.0 driver installation.
- USB 3.0 devices can only be used as data storage only.
- We strongly recommend that you connect USB 3.0 devices to USB 3.0 ports for faster and better performance for your USB 3.0 devices.

9. **USB 2.0 ports 3 and 4.** These two 4-pin Universal Serial Bus (USB) ports are available for connecting USB 2.0/1.1 devices.
10. **DVI-D port.** This port is for any DVI-D compatible device. DVI-D can't be converted to output RGB Signal to CRT and isn't compatible with DVI-I.
11. **DisplayPort.** This port connects a display monitor or a home-theater system.
12. **PS/2 Keyboard port (purple).** This port is for a PS/2 keyboard.

1.10.2 Internal connectors

1. Front panel audio connector (10-1 pin AAFP)

This connector is for a chassis-mounted front panel audio I/O module that supports either HD Audio or legacy AC'97 audio standard. Connect one end of the front panel audio I/O module cable to this connector.

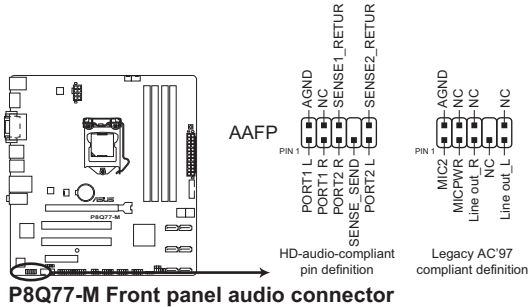

P8Q77-M Front panel audio connector



- We recommend that you connect a high-definition front panel audio module to this connector to avail of the motherboard's high-definition audio capability.
- If you want to connect a high-definition front panel audio module to this connector, set the **Front Panel Type** item in the BIOS setup to **[HD]**. If you want to connect an AC'97 front panel audio module to this connector, set the item to **[AC97]**. By default, this connector is set to **[HD]**. See section **2.5.10 Onboard Devices Configuration** for details.

2. Serial port connector (10-1 pin COM1)

This connector is for a serial (COM) port. Connect the serial port module cable to this connector, then install the module to a slot opening at the back of the system chassis.

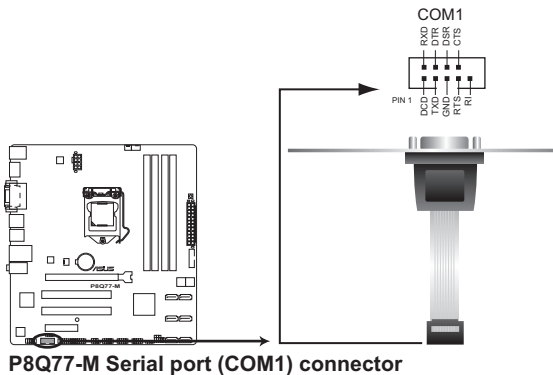

P8Q77-M Serial port (COM1) connector



The COM module is purchased separately.

3. CPU and chassis fan connectors (4-pin CPU_FAN, 3-pin CHA_FAN1/2)

Connect the fan cables to the fan connectors on the motherboard, ensuring that the black wire of each cable matches the ground pin of the connector.

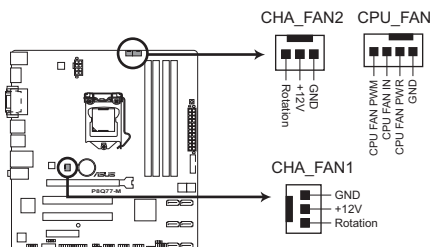

P8Q77-M Fan connectors



Do not forget to connect the fan cables to the fan connectors. Insufficient air flow inside the system may damage the motherboard components. These are not jumpers! Do not place jumper caps on the fan connectors!



- The CPU_FAN connector supports a CPU fan of maximum 2A (24 W) fan power.
- Only the 4-pin CPU fan supports the ASUS FanXpert and Q-Fan 2 feature.

4. Chassis intrusion connector (4-1 pin CHASSIS)

This connector is for a chassis-mounted intrusion detection sensor or switch. Connect one end of the chassis intrusion sensor or switch cable to this connector. The chassis intrusion sensor or switch sends a high-level signal to this connector when a chassis component is removed or replaced. The signal is then generated as a chassis intrusion event.

By default, the pin labeled “Chassis Signal” and “Ground” are shorted with a jumper cap. Remove the jumper caps only when you intend to use the chassis intrusion detection feature.

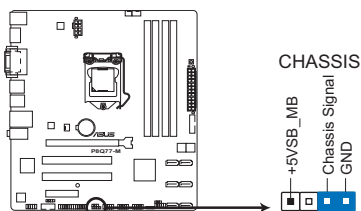

P8Q77-M Chassis intrusion connector

5. ATX power connectors (24-pin EATXPWR, 8-pin EATX12V)

These connectors are for ATX power supply plugs. The power supply plugs are designed to fit these connectors in only one orientation. Find the proper orientation and push down firmly until the connectors completely fit.

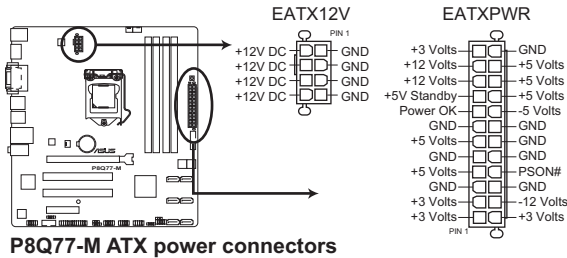

- For a fully configured system, we recommend that you use a power supply unit (PSU) that complies with ATX 12 V Specification 2.0 (or later version) and provides a minimum power of 350 W.
- DO NOT forget to connect the 4-pin / 8-pin ATX +12V power plug. Otherwise, the system will not boot up.
- We recommend that you use a PSU with higher power output when configuring a system with more power-consuming devices. The system may become unstable or may not boot up if the power is inadequate.
- If you are uncertain about the minimum power supply requirement for your system, refer to the Recommended Power Supply Wattage Calculator at <http://support.asus.com/PowerSupplyCalculator/PSCalculator.aspx?SLanguage=en-us> for details.

6. Digital audio connector (4-1 pin SPDIF_OUT)

This connector is for an additional Sony/Philips Digital Interface (S/PDIF) port. Connect the S/PDIF Out module cable to this connector, then install the module to a slot opening at the back of the system chassis.

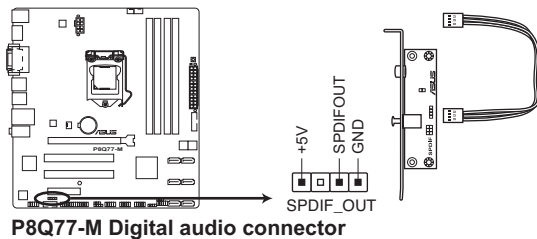

The S/PDIF module is purchased separately.

7. Intel® Q77 Serial ATA 6.0Gb/s connectors (7-pin SATA6G_1/2 [gray])

These connectors connect to Serial ATA 6.0 Gb/s hard disk drives via Serial ATA 6.0 Gb/s signal cables.

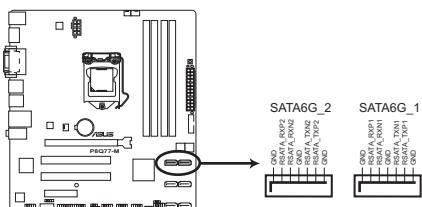

P8Q77-M Intel® SATA 6.0Gb/s connectors



- These connectors are set to [AHCI] by default. If you intend to create a Serial ATA RAID set using these connectors, set the **SATA Mode Selection** item in the BIOS to [RAID]. See section **2.5.5 SATA Configuration** for details.
- Before creating a RAID set, refer to the RAID Supplementary Guide included in the folder named Manual in the support DVD.
- You must install Windows® XP Service Pack 3 or later version before using Serial ATA hard disk drives. The Serial ATA RAID feature (RAID 0, 1, 5, and 10) is available only if you are using Windows® XP SP3 or later version.
- When using hot-plug and NCQ, set the **SATA Mode Selection** item in the BIOS to [AHCI]. See section **2.5.4 SATA Configuration** for details.

8. Intel® Q77 Serial ATA 3.0Gb/s connectors (7-pin SATA3G_1~4 [blue])

These connectors connect to Serial ATA 3.0 Gb/s hard disk drives and optical drives via Serial ATA 3.0 Gb/s signal cables.

If you installed Serial ATA hard disk drives, you can create a RAID 0, 1, 5, and 0+1(10) configurations with the Intel® Matrix Storage Technology through the onboard Intel® Q77 chipset.

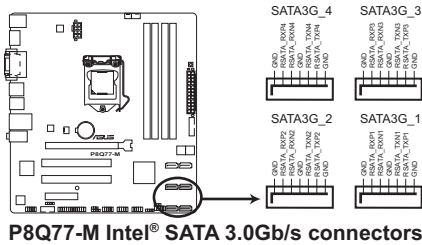

P8Q77-M Intel® SATA 3.0Gb/s connectors



- These connectors are set to [AHCI] by default. If you intend to create a Serial ATA RAID set using these connectors, set the **SATA Mode Selection** item in the BIOS to [RAID]. See section **2.5.5 SATA Configuration** for details.
- Before creating a RAID set, refer to the RAID Supplementary Guide included in the folder named Manual in the support DVD.
- You must install Windows® XP Service Pack 3 or later version before using Serial ATA hard disk drives. The Serial ATA RAID feature (RAID 0, 1, 5, and 10) is available only if you are using Windows® XP SP3 or later version.
- When using hot-plug and NCQ, set the **SATA Mode Selection** item in the BIOS to [AHCI]. See section **2.5.4 SATA Configuration** for details.

9. Speaker connector (4-pin SPEAKER)

The 4-pin connector is for the chassis-mounted system warning speaker. The speaker allows you to hear system beeps and warnings.

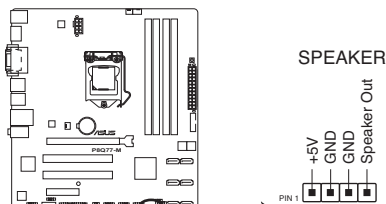

P8Q77-M Speaker out connector

10. System panel connector (10-1 pin F_PANEL)

This connector supports several chassis-mounted functions.

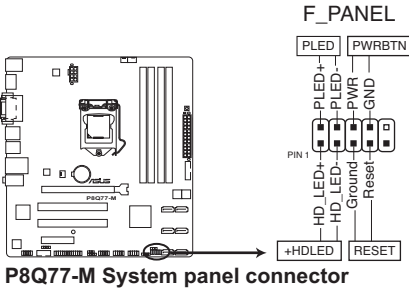

- **System power LED (2-pin PLED)**

This 2-pin connector is for the system power LED. Connect the chassis power LED cable to this connector. The system power LED lights up when you turn on the system power, and blinks when the system is in sleep mode.

- **Hard disk drive activity LED (2-pin +HDLED)**

This 2-pin connector is for the HDD Activity LED. Connect the HDD Activity LED cable to this connector. The IDE LED lights up or flashes when data is read from or written to the HDD.

- **Power/Soft-off button (2-pin PWRBTN)**

This 2-pin connector is for the system power button.

- **Reset button (2-pin RESET)**

This 2-pin connector is for the chassis-mounted reset button for system reboot without turning off the system power.

11. LPT connector (26-1 pin LPT)

The LPT (Line Printing Terminal) connector supports devices such as a printer. LPT is standardized as IEEE 1284, which is the parallel port interface on IBM PC-compatible computers.

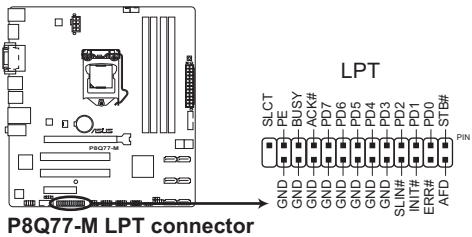

12. USB connectors (10-1 pin USB56, USB78, USB910)

These connectors are for USB 2.0 ports. Connect the USB module cable to any of these connectors, then install the module to a slot opening at the back of the system chassis. These USB connectors comply with USB 2.0 specification that supports up to 480 Mbps connection speed.

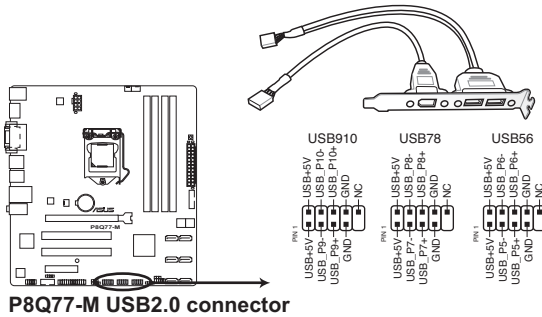

Never connect a 1394 cable to the USB connectors. Doing so will damage the motherboard!



The USB module cable is purchased separately.

13. USB 3.0 connector (20-1 pin USB3_34)

This connector is for the additional USB 3.0 ports. Connect the USB 3.0 bracket cable to this connector, then install the USB 3.0 bracket to the rear side of the chassis. If your chassis support customized front panel installation, with ASUS USB 3.0 header, you can have a front panel USB 3.0 solution.

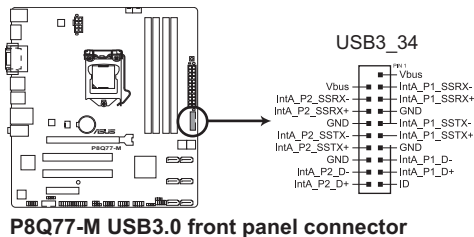

- The USB 3.0 module is purchased separately.
- Due to Intel® limitations, the USB3_34 only supports Windows® 7 operating system.

1.11 Onboard switches

Onboard switches allow you to fine-tune performance when working on a bare or open-case system. This is ideal for overclockers and gamers who continually change settings to enhance system performance.

MemOK! switch

Installing DIMMs that are incompatible with the motherboard may cause system boot failure, and the DRAM_LED near the MemOK! switch lights continuously. Press and hold the MemOK! switch until the DRAM_LED starts blinking to begin automatic memory compatibility tuning for successful boot.

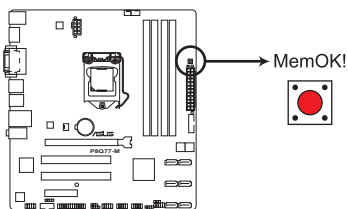

P8Q77-M MemOK! switch



- Refer to section **1.12 Onboard LEDs** for the exact location of the DRAM_LED.
- The DRAM_LED also lights when the DIMM is not properly installed. Turn off the system and reinstall the DIMM before using the MemOK! function.
- The MemOK! switch does not function under Windows® OS environment.
- During the tuning process, the system loads and tests failsafe memory settings. It takes about 30 seconds for the system to test one set of failsafe settings. If the test fails, the system reboots and test the next set of failsafe settings. The blinking speed of the DRAM_LED increases, indicating different test processes.
- Due to memory tuning requirement, the system automatically reboots when each timing set is tested. If the installed DIMMs still fail to boot after the whole tuning process, the DRAM_LED lights continuously. Replace the DIMMs with ones recommended in the Memory QVL (Qualified Vendors Lists) in this user manual or on the ASUS website at www.asus.com.
- If you turn off the computer and replace DIMMs during the tuning process, the system continues memory tuning after turning on the computer. To stop memory tuning, turn off the computer and unplug the power cord for about 5–10 seconds.
- If your system fail to boot due to BIOS overclocking, press the MemOK! switch to boot and load BIOS default settings. A message will appear during POST reminding you that the BIOS has been restored to its default settings.
- We recommend that you download and update to the latest BIOS version from the ASUS website at www.asus.com after using the MemOK! function.

1.12 Onboard LEDs

1. Standby Power LED

The motherboard comes with a standby power LED that lights up to indicate that the system is ON, in sleep mode, or in soft-off mode. This is a reminder that you should shut down the system and unplug the power cable before removing or plugging in any motherboard component. The illustration below shows the location of the onboard LED.

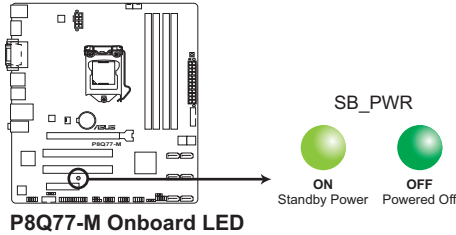

2. DRAM LED

DRAM LED checks the DRAM in sequence during motherboard booting process. If an error is found, the LED next to the error device will continue lighting until the problem is solved. This user-friendly design provides an intuitional way to locate the root problem within a second.

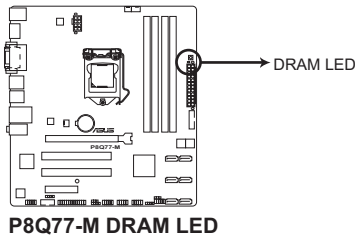

1.13 Software support

1.13.1 Installing an operating system

This motherboard supports Windows® XP / 7 Operating Systems (OS). Always install the latest OS version and corresponding updates to maximize the features of your hardware.



- Motherboard settings and hardware options vary. Refer to your OS documentation for detailed information.
- Ensure that you install Windows® XP Service Pack 3 or later versions before installing the drivers for better compatibility and system stability.

1.13.2 Support DVD information

The Support DVD that comes with the motherboard package contains the drivers, software applications, and utilities that you can install to avail all motherboard features.



The contents of the Support DVD are subject to change at any time without notice. Visit the ASUS website at www.asus.com for updates.

To run the Support DVD

Place the Support DVD to the optical drive. If Autorun is enabled in your computer, the DVD automatically displays the Specials screen. Click Drivers, Utilities, Manual, Contact, and Specials tabs to display their respective menus.



The following screen is for reference only.

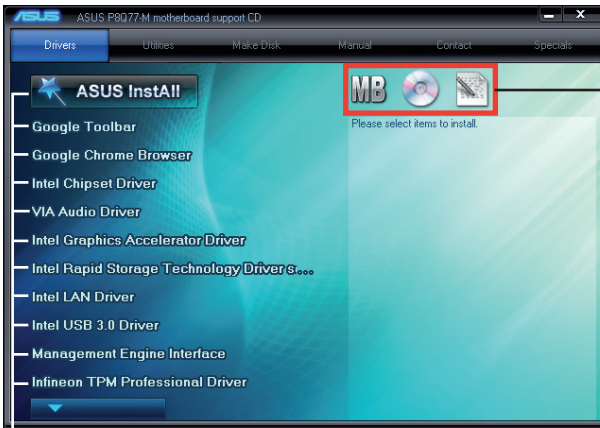

Click an item to install



If Autorun is NOT enabled in your computer, browse the contents of the Support DVD to locate the file ASSETUP.EXE from the BIN folder. Double-click the ASSETUP.EXE to run the DVD.

1.13.3 Intel® SBA support

Intel® SBA (Small Business Advantage) is a combination of hardware and software that provides unique security and productivity capabilities designed for small businesses.



Intel® SBA requires MEI driver (AMT host software kit) installed.

Platform requirements:

- Windows® 7 (32/64bit)
- Panther Point PCH with Core™ Ivy Bridge CPU or Sandy Bridge CPU (Chief River/ Maho Bay platforms) with SMB vPro ME 8.0 firmware load

CPU and chipset requirements:

- * Intel® Core™ i3 with B75 Express Chipset
- * Intel® Core™ i5 with B75 Express Chipset
- * Intel® Core™ i7 with B75 Express Chipset
- * Intel® Core™ i5 vPro™ with one of these chipsets: B75, Q77
- * Intel® Core™ i7 vPro™ with one of these chipsets: B75, Q77
- The Intel® Management Engine software kit must be installed (The Local Manageability Service and the Intel® Management Engine Interface must be installed and running.)
- Local Administrator rights on the target machine



-
- Intel® SBA does not support the 800 x 600 screen resolution.
 - Visit the ASUS website at www.asus.com for the latest CPU QVL (Qualified Vendors List).
-



Chapter 2

BIOS information

2.1 Managing and updating your BIOS



Save a copy of the original motherboard BIOS file to a USB flash disk in case you need to restore the BIOS in the future. Copy the original motherboard BIOS using the ASUS Update utility.

2.1.1 ASUS Update utility

The ASUS Update is a utility that allows you to manage, save, and update the motherboard BIOS in Windows® environment.



- ASUS Update requires an Internet connection either through a network or an Internet Service Provider (ISP).
 - This utility is available in the support DVD that comes with the motherboard package.
-

Installing ASUS Update

To install ASUS Update:

1. Place the support DVD in the optical drive. The **Specials** menu appears.
2. Click the **Utilities** tab, then click **AI Suite II**.
3. Follow the onscreen instructions to complete the installation.



Quit all Windows® applications before you update the BIOS using this utility.

Updating the BIOS

To update the BIOS:

1. From the Windows® desktop, click **Start > Programs > ASUS > AI Suite II > AI Suite II X.XX.XX** to launch the AI Suite II utility. The AI Suite II Quick Bar appears.
2. Click **Update** button from the Quick Bar, and then click **ASUS Update** from the popup menu. The **ASUS Update** main screen appears. From the list, select either of the following methods:
Updating from the Internet
 - a. Select **Update BIOS from the Internet**, then click **Next**.
 - b. Select the ASUS FTP site nearest you to avoid network traffic, then click **Next**.
 - c. From the FTP site, select the BIOS version that you wish to download then click **Next**.



The ASUS Update utility is capable of updating itself through the Internet. Always update the utility to avail all its features.

Updating from a BIOS file

- a. Select **Update BIOS from file**, then click **Next**.
 - b. Locate the BIOS file from the **Open** window, then click **Open**.
3. Follow the onscreen instructions to complete the updating process.

2.1.2 ASUS EZ Flash 2

The ASUS EZ Flash 2 feature allows you to update the BIOS without using an OS-based utility.



Before you start using this utility, download the latest BIOS file from the ASUS website at www.asus.com.

To update the BIOS using EZ Flash 2:

1. Insert the USB flash disk that contains the latest BIOS file to the USB port.
2. Enter the **Advanced Mode** of the BIOS setup program. Go to the **Tool** menu to select **ASUS EZ Flash 2 Utility** and press <Enter> to enable it.

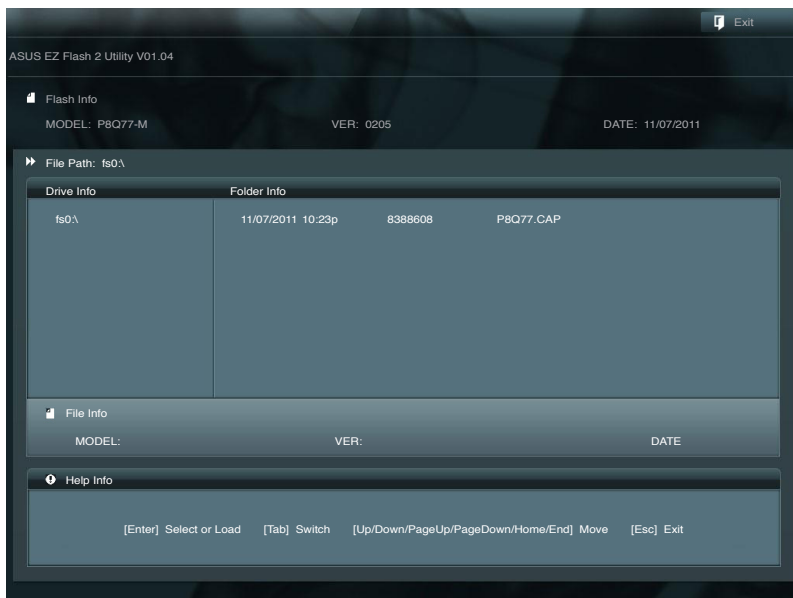

3. Press <Tab> to switch to the **Drive** field.
4. Press the Up/Down arrow keys to find the USB flash disk that contains the latest BIOS, and then press <Enter>.
5. Press <Tab> to switch to the **Folder Info** field.
6. Press the Up/Down arrow keys to find the BIOS file, and then press <Enter> to perform the BIOS update process. Reboot the system when the update process is done.



-
- This function supports USB flash disks with **FAT 32/16** format and single partition only.
 - **DO NOT** shut down or reset the system while updating the BIOS to prevent system boot failure!
-

2.1.3 ASUS CrashFree BIOS 3 utility

The ASUS CrashFree BIOS 3 is an auto recovery tool that allows you to restore the BIOS file when it fails or gets corrupted during the updating process. You can restore a corrupted BIOS file using the motherboard support DVD or a USB flash drive that contains the updated BIOS file.



-
- Before using this utility, rename the BIOS file in the removable device into **P8Q77.CAP**.
 - The BIOS file in the support DVD may not be the latest version. Download the latest BIOS file from the ASUS website at www.asus.com.
-

Recovering the BIOS

To recover the BIOS:

1. Turn on the system.
2. Insert the support DVD to the optical drive or the USB flash drive that contains the BIOS file to the USB port.
3. The utility automatically checks the devices for the BIOS file. When found, the utility reads the BIOS file and enters ASUS EZ Flash 2 utility automatically.
4. The system requires you to enter BIOS Setup to recover BIOS setting. To ensure system compatibility and stability, we recommend that you press <F5> to load default BIOS values.



DO NOT shut down or reset the system while updating the BIOS! Doing so can cause system boot failure!

2.1.4 ASUS BIOS Updater

The ASUS BIOS Updater allows you to update BIOS in DOS environment. This utility also allows you to copy the current BIOS file that you can use as a backup when the BIOS fails or gets corrupted during the updating process.



The succeeding utility screens are for reference only. The actual utility screen displays may not be same as shown.

Before updating BIOS

1. Prepare the motherboard support DVD and a USB flash drive in FAT32/16 format and single partition.
2. Download the latest BIOS file and BIOS Updater from the ASUS website at <http://support.asus.com> and save them on the USB flash drive.



NTFS is not supported under DOS environment. Do not save the BIOS file and BIOS Updater to a hard disk drive or USB flash drive in NTFS format.

3. Turn off the computer and disconnect all SATA hard disk drives (optional).

Booting the system in DOS environment

1. Insert the USB flash drive with the latest BIOS file and BIOS Updater to the USB port.
2. Boot your computer. When the ASUS Logo appears, press <F8> to show the **BIOS Boot Device Select Menu**. Insert the support DVD into the optical drive and select the optical drive as the boot device.

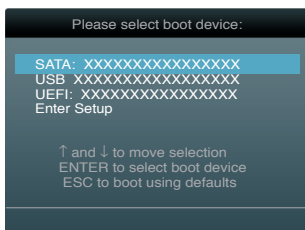

3. When the **Make Disk** menu appears, select the **FreeDOS command prompt** item by pressing the item number.
4. At the FreeDOS prompt, type `d:` and press <Enter> to switch the disk from Drive C (optical drive) to Drive D (USB flash drive).

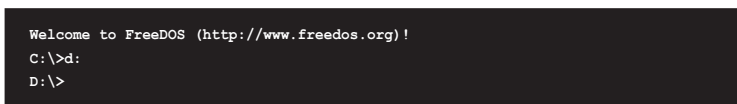

Updating the BIOS file

To update the BIOS file using BIOS Updater

1. At the FreeDOS prompt, type `bupdater /pc /g` and press <Enter>.

```
D:\>bupdater /pc /g
```

2. The BIOS Updater screen appears as below.

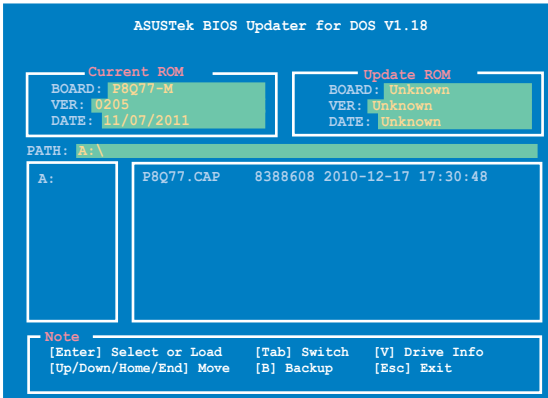

3. Press <Tab> to switch between screen fields and use the <Up/Down/Home/End> keys to select the BIOS file and press <Enter>. BIOS Updater checks the selected BIOS file and prompts you to confirm BIOS update.



4. Select Yes and press <Enter>. When BIOS update is done, press <ESC> to exit BIOS Updater. Restart your computer.



DO NOT shut down or reset the system while updating the BIOS to prevent system boot failure!



- For BIOS Updater version 1.04 or later, the utility automatically exits to the DOS prompt after updating BIOS.
- Ensure to load the BIOS default settings to ensure system compatibility and stability. Select the **Load Optimized Defaults** item under the Exit menu. Refer to section **2.9 Exit menu** for details.
- Ensure to connect all SATA hard disk drives after updating the BIOS file if you have disconnected them.

2.2 BIOS setup program

Use the BIOS Setup program to update the BIOS or configure its parameters. The BIOS screens include navigation keys and brief online help to guide you in using the BIOS Setup program.

Entering BIOS Setup at startup

To enter BIOS Setup at startup:

- Press <Delete> during the Power-On Self Test (POST). If you do not press <Delete>, POST continues with its routines.

Entering BIOS Setup after POST

To enter BIOS Setup after POST:

- Press <Ctrl>+<Alt>+ simultaneously.
- Press the reset button on the system chassis.
- Press the power button to turn the system off then back on. Do this option only if you failed to enter BIOS Setup using the first two options.



Using the **power button**, **reset button**, or the <Ctrl>+<Alt>+ keys to force reset from a running operating system can cause damage to your data or system. We recommend to always shut down the system properly from the operating system.



- The BIOS setup screens shown in this section are for reference purposes only, and may not exactly match what you see on your screen.
 - Visit the ASUS website at www.asus.com to download the latest BIOS file for this motherboard.
 - Ensure that a USB mouse is connected to your motherboard if you want to use the mouse to control the BIOS setup program.
 - If the system becomes unstable after changing any BIOS setting, load the default settings to ensure system compatibility and stability. Select the **Load Optimized Defaults** item under the **Exit** menu. See section **2.9 Exit Menu** for details.
 - If the system fails to boot after changing any BIOS setting, try to clear the CMOS and reset the motherboard to the default value. See section **1.6 Jumpers** for information on how to erase the RTC RAM.
-

BIOS menu screen

The BIOS setup program can be used under two modes: **EZ Mode** and **Advanced Mode**. You can change modes from the **Exit** menu or from the **Exit/Advanced Mode** button in the **EZ Mode/Advanced Mode** screen.

EZ Mode

By default, the **EZ Mode** screen appears when you enter the BIOS setup program. The **EZ Mode** provides you an overview of the basic system information, and allows you to select the display language, system performance mode and boot device priority. To access the **Advanced Mode**, click **Exit/Advanced Mode**, then select **Advanced Mode** or press F7 hot key for the advanced BIOS settings.



The default screen for entering the BIOS setup program can be changed. Refer to the **Setup Mode** item in **section 2.7 Boot menu** for details.

Selects the display language of the BIOS setup program

Displays the CPU/motherboard temperature, CPU/5V/3.3V/12V voltage output, CPU/chassis fan speed

Exits the BIOS setup program without saving the changes, saves the changes and resets the system, or enters the Advanced Mode

Selects the Advanced mode functions

Selects the boot device priority

Displays the system properties of the selected mode on the right hand side

Power Saving mode

Normal mode

ASUS Optimal mode

Loads optimized default

Selects the boot device priority

Displays the Advanced mode menus



- The boot device options vary depending on the devices you installed to the system.
- The **Boot Menu(F8)** button is available only when the boot device is installed to the system.

Advanced Mode

The **Advanced Mode** provides advanced options for experienced end-users to configure the BIOS settings. The figure below shows an example of the **Advanced Mode**. Refer to the following sections for the detailed configurations.



To access the EZ Mode, click **Exit**, then select **ASUS EZ Mode**.

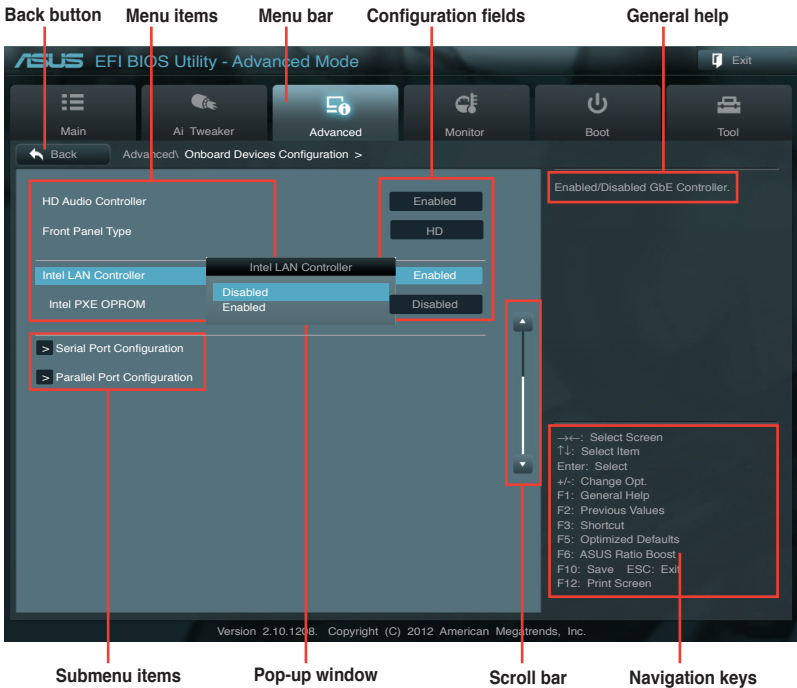

Menu items

The highlighted item on the menu bar displays the specific items for that menu. For example, selecting **Main** shows the Main menu items.

The other items (AI Tweaker, Advanced, Monitor, Boot, Tool, and Exit) on the menu bar have their respective menu items.

Back button

This button appears when entering a submenu. Press <Esc> or use the USB mouse to click this button to return to the previous menu screen.

Submenu items

A greater than sign (>) before each item on any menu screen means that the item has a submenu. To display the submenu, select the item and press <Enter>.

Pop-up window

Select a menu item and press <Enter> to display a pop-up window with the configuration options for that item.

Scroll bar

A scroll bar appears on the right side of a menu screen when there are items that do not fit on the screen. Press the Up/Down arrow keys or <Page Up> / <Page Down> keys to display the other items on the screen.

Navigation keys

At the bottom right corner of the menu screen are the navigation keys for the BIOS setup program. Use the navigation keys to select items in the menu and change the settings.

General help

At the top right corner of the menu screen is a brief description of the selected item.

Configuration fields

These fields show the values for the menu items. If an item is user-configurable, you can change the value of the field opposite the item. You cannot select an item that is not user-configurable.

A configurable field is highlighted when selected. To change the value of a field, select it and press <Enter> to display a list of options.

2.3 Main menu

The Main menu screen appears when you enter the Advanced Mode of the BIOS Setup program. The Main menu provides you an overview of the basic system information, and allows you to set the system date, time, language, and security settings.

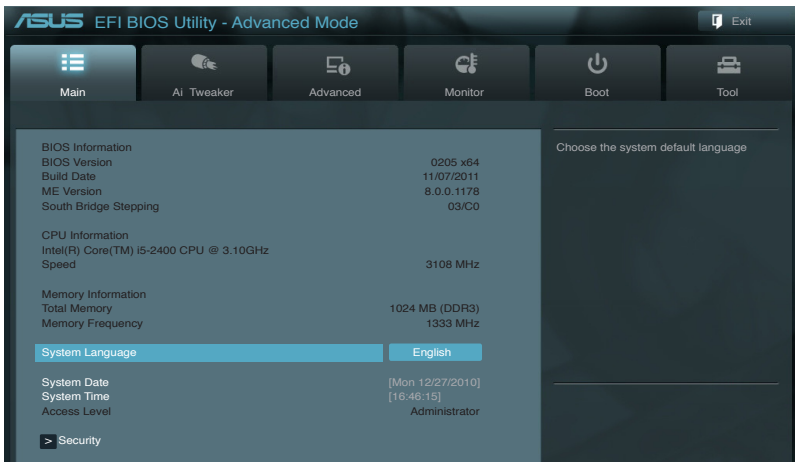

2.3.1 System Language [English]

Allows you to choose the BIOS language version from the options. Configuration options: [English] [Français] [Deutsch] [简体中文] [繁體中文] [日本語] [Español] [Русский]

2.3.2 System Date [Day xx/xx/xxxx]

Allows you to set the system date.

2.3.3 System Time [xx:xx:xx]

Allows you to set the system time.

2.3.4 Security

The Security menu items allow you to change the system security settings.



-
- If you have forgotten your BIOS password, erase the CMOS Real Time Clock (RTC) RAM to clear the BIOS password. See section 1.9 **Jumpers** for information on how to erase the RTC RAM.
 - The **Administrator** or **User Password** items on top of the screen show the default **Not Installed**. After you set a password, these items show **Installed**.
-

Administrator Password

If you have set an administrator password, we recommend that you enter the administrator password for accessing the system. Otherwise, you might be able to see or change only selected fields in the BIOS setup program.

To set an administrator password:

1. Select the **Administrator Password** item and press <Enter>.
2. From the **Create New Password** box, key in a password, then press <Enter>.
3. Confirm the password when prompted.

To change an administrator password:

1. Select the **Administrator Password** item and press <Enter>.
2. From the **Enter Current Password** box, key in the current password, then press <Enter>.
3. From the **Create New Password** box, key in a new password, then press <Enter>.
4. Confirm the password when prompted.

To clear the administrator password, follow the same steps as in changing an administrator password, but press <Enter> when prompted to create/confirm the password. After you clear the password, the **Administrator Password** item on top of the screen shows **Not Installed**.

User Password

If you have set a user password, you must enter the user password for accessing the system. The **User Password** item on top of the screen shows the default **Not Installed**. After you set a password, this item shows **Installed**.

To set a user password:

1. Select the **User Password** item and press <Enter>.

2. From the **Create New Password** box, key in a password, then press <Enter>.
3. Confirm the password when prompted.

To change a user password:

1. Select the **User Password** item and press <Enter>.
2. From the **Enter Current Password** box, key in the current password, then press <Enter>.
3. From the **Create New Password** box, key in a new password, then press <Enter>.
4. Confirm the password when prompted.

To clear the user password, follow the same steps as in changing a user password, but press <Enter> when prompted to create/confirm the password. After you clear the password, the **User Password** item on top of the screen shows **Not Installed**.

2.4 Ai Tweaker menu

The Ai Tweaker menu items allow you to configure overclocking-related items.



Be cautious when changing the settings of the Ai Tweaker menu items. Incorrect field values can cause the system to malfunction.



The configuration options for this section vary depending on the CPU and DIMM model you installed on the motherboard.

ASUS EFI BIOS Utility - Advanced Mode Exit

Main | **Ai Tweaker** | Advanced | Monitor | Boot | Tool

Target DRAM Speed : 1333MHz

CPU Bus speed : DRAM speed ratio mode Auto

Memory Frequency Auto

EPU Power Saving MODE Disabled

> GPU Boost

> DRAM Timing Control

> CPU Power Management

CPU Voltage 1.128V Offset Mode

Offset Mode Sign +

CPU Offset Voltage Auto

DRAM Voltage 1.610V Auto

VCCIO Voltage Auto

VCCSA Voltage Auto

CPU PLL Voltage Auto

PCH Voltage 1.050V Auto

Load-Line Calibration Auto

Forces a DDR3 frequency slower than the common ICK detected via SPD.

←→: Select Screen
↑↓: Select Item
Enter: Select
+/-: Change Opt.
F1: General Help
F2: Previous Values
F3: Shortcut
F5: Optimized Defaults
F6: ASUS Ratio Boost
F10: Save ESC: Exit
F12: Print Screen

Version 2.10.1208. Copyright (C) 2012 American Megatrends, Inc.

2.4.1 CPU bus speed : DRAM speed ratio mode [Auto]

Allows you to set the CPU bus speed to DRAM speed ratio mode.

- [Auto] DRAM speed is set to the optimized settings.
[100:133] The CPU bus speed to DRAM speed ratio is set to 100:133.
[100:100] The CPU bus speed to DRAM speed ratio is set to 100:100.

2.4.2 Memory Frequency [Auto]

Allows you to set the memory operating frequency. Configuration options: [DDR3-800MHz] [DDR3-1066MHz] [DDR3-1333MHz] [DDR3-1600MHz] [DDR3-1866MHz] [DDR3-2133MHz] [DDR3-2400MHz]



Selecting a very high memory frequency may cause the system to become unstable! If this happens, revert to the default setting.

2.4.3 EPU Power Saving Mode [Disabled]

Allows you to enable or disable the EPU power saving function.

Configuration options: [Disabled] [Enabled]

EPU Setting [Auto]

This item appears only when you set the **EPU Power Saving Mode** item to [Enabled] and allows you to select the EPU power saving mode. Configuration options: [Auto] [Light Power Saving Mode] [Medium Power Saving Mode] [Max Power Saving Mode]

2.4.4 GPU Boost [OK]

- [OK] Select [OK] to automatically optimize the iGPU frequency.
[Cancel] Select [Cancel] to use a fixed iGPU frequency.

2.4.5 DRAM Timing Control

The sub-items in this menu allow you to set the DRAM timing control features. Use the <+> and <-> keys to adjust the value. To restore the default setting, type [auto] using the keyboard and press <Enter>.



Changing the values in this menu may cause the system to become unstable! If this happens, revert to the default settings.

2.4.6 CPU Power Management

The sub-items in this menu allow you to set the CPU ratio and features.

CPU Ratio [Auto]

Allows you to manually adjust the maximum non-turbo CPU ratio. Use <+> and <-> keys or the numeric keypad to adjust the value. The valid value ranges vary according to your CPU model.

Enhanced Intel SpeedStep Technology [Enabled]

Allows you to enable or disable the Enhanced Intel® SpeedStep Technology (EIST).

[Disabled] Disables this function.

[Enabled] The operating system dynamically adjusts the processor voltage and core frequency which may result in decreased average consumption and decreased average heat production.

Turbo Mode [Enabled]

This item appears only when you set the previous item to [Enabled].

[Enabled] Allows processor cores to run faster than marked frequency in specific conditions.

[Disabled] Disables this function.



The following three items appear only when you set both the **Enhanced Intel SpeedStep Technology** and **Turbo Mode** items to [Enabled].

Long Duration Power Limit [Auto]

Allows you to limit the turbo ratio's long duration power.

Use the <+> and <-> keys to adjust the value.

Long Duration Maintained [Auto]

Allows you to maintain the turbo ratio's long duration power.

Use the <+> and <-> keys to adjust the value.

Short Duration Power Limit [Auto]

Allows you to limit the turbo ratio's long duration power.

Use the <+> and <-> keys to adjust the value.

Primary Plane Current Limit [Auto]

Maximum instantaneous current allowed at any given time for CPU cores

Use <+> and <-> key to adjust the value at 0.125A increment. .

Secondary Plane Current Limit [Auto]

Maximum instantaneous current allowed at any given time for Internal Graphics cores.

Use <+> and <-> key to adjust the value at 0.125A increment.

2.4.7 CPU Voltage [Offset Mode]

[Offset Mode] To offset the voltage by a positive or negative value.

Offset Mode Sign [+]

[+] To offset the voltage by a positive value.

[-] To offset the voltage by a negative value.

CPU Offset Voltage [Auto]

Allows you to set the CPU Offset voltage. The values range from 0.005V to 0.635V with a 0.005V interval.



Refer to the CPU documentation before setting the CPU voltage. Setting a high voltage may damage the CPU permanently, and setting a low voltage may make the system unstable.

2.4.8 DRAM Voltage [Auto]

Allows you to set the DRAM voltage. The values range from 1.20V to 2.20V with a 0.00625V interval.



According to Intel CPU specification, DIMMs with voltage requirement over 1.65V may damage the CPU permanently. We recommend you install the DIMMs with the voltage requirement below 1.65V.

2.4.9 VCCIO Voltage [Auto]

Allows you to set the VCCIO voltage. Configuration options: [Auto] [+0.10V]

2.4.10 VCCSA Voltage [Auto]

Allows you to set the VCCSA voltage. Configuration options: [Auto] [+0.05V]

2.4.11 CPU PLL Voltage [Auto]

Allows you to set the CPU and PCH PLL voltage. Configuration options: [Auto] [+0.10V]

2.4.12 PCH Voltage [Auto]

Allows you to set the Platform Controller Hub voltage. The values range from 0.7350V to 1.6850V with a 0.0050V interval.



- The values of the **CPU Offset Voltage**, **DRAM Voltage**, and **PCH Voltage** items are labeled in different color, indicating the risk levels of high voltage settings.
- The system may need better cooling system to work stably under high voltage settings.

2.4.13 Load-Line Calibration [Auto]

Load-line is defined by Intel VRM specification and affects CPU voltage. The CPU working voltage will decrease proportionally to CPU loading. Higher load-line calibration would get higher voltage and better overclocking performance, but increase the CPU and VRM thermal. This item allows you to set this function for better system performance. Configuration options: [Auto] [Enabled] [Disabled]



The actual performance boost may vary depending on your CPU specification.

2.5 Advanced menu

The Advanced menu items allow you to change the settings for the CPU and other system devices.



Be cautious when changing the settings of the Advanced menu items. Incorrect field values can cause the system to malfunction.



2.5.1 Trusted Computing

The items in this menu allow you to set the TPM (Trusted Platform Module) feature.



The following items function only when a TPM module is installed in this motherboard.

TPM Support [Enabled]

Allows you to enable or disable the TPM support. Configuration options: [Disabled] [Enabled]

TPM State [Disabled]

This item appears only when you set the **TPM Support** item to [Enabled] and allows you to enable or disable the TPM after POST. Reboot your system for the changes to take effect. Configuration options: [Disabled] [Enabled]

2.5.2 CPU Configuration

The items in this menu show the CPU-related information that the BIOS automatically detects.



The items shown in submenu may be different due to the CPU you installed.

CPU Ratio [Auto]

Allows you to set the ratio between the CPU Core Clock and the BCLK Frequency. Use <+> and <-> keys or the numeric keypad to adjust the ratio. The valid value ranges vary according to your CPU model.

Intel Adaptive Thermal Monitor [Enabled]

[Enabled] Enables the overheated CPU to throttle its clock speed to cool down.

[Disabled] Disables the CPU thermal monitor function.

Active Processor Cores [All]

Allows you to choose the number of CPU cores to activate in each processor package. Configuration options: [All] [1] [2] [3]

Limit CPUID Maximum [Disabled]

[Enabled] Allows legacy operating systems to boot even without support for CPUs with extended CPUID functions.

[Disabled] Disables this function.

Execute Disable Bit [Enabled]

[Enabled] Enables the No-Execution Page Protection Technology.

[Disabled] Forces the XD feature flag to always return to zero (0).

Enhanced Intel SpeedStep Technology [Enabled]

Allows you to enable or disable the Enhanced Intel® SpeedStep Technology (EIST).

[Disabled] The CPU runs at its default speed.

[Enabled] The operating system controls the CPU speed.

Turbo Mode [Enabled]

This item appears only when you set the **Enhanced Intel SpeedStep Technology** item to [Enabled] and allows you to enable or disable the Intel® Turbo Mode Technology.

[Enabled] Allows processor cores to run faster than marked frequency in specific condition.

[Disabled] Disables this function.

CPU C1E [Auto]

Enables or disables the C1E support function. This item should be enabled in order to enable the Enhanced Halt State. Configuration options: [Auto] [Enabled] [Disabled]

CPU C3 Report [Auto]

Allows you to disable or enable the CPU C3 report to the operating system. Configuration options: [Auto] [Enabled] [Disabled]

CPU C6 Report [Auto]

Allows you to disable or enable the CPU C6 report to the operating system. Configuration options: [Auto] [Enabled] [Disabled]

Intel Virtualization Technology [Disabled]

[Enabled] Allows a hardware platform to run multiple operating systems separately and simultaneously, enabling one system to virtually function as several systems.

[Disabled] Disables this function.

Hardware Prefetcher [Enabled]

[Enabled] Turns on the Mid Level Cache (L2) streamer prefetcher.

[Disabled] Turns off the Mid Level Cache (L2) streamer prefetcher.

Adjacent Cache Line Prefetch [Enabled]

[Enabled] Turns on prefetching of adjacent cache lines.

[Disabled] Turns off prefetching of adjacent cache lines.

2.5.3 PCH Configuration

High Precision Timer [Enabled]

Allows you to enable or disable the High Precision Event Timer.

Configuration options: [Enabled] [Disabled]

Intel® Rapid Start Technology [Disabled]

Allows you to enable or disable the Intel(R) Rapid Start Technology.

Configuration options: [Enabled] [Disabled]

Intel® Smart Connect Technology [Disabled]

ISCT Configuration [Disabled]

Allows you to enable or disable the ISCT configuration. Configuration options: [Enabled] [Disabled]

2.5.4 SATA Configuration

While entering Setup, the BIOS automatically detects the presence of SATA devices. The SATA Port items show **Not Present** if no SATA device is installed to the corresponding SATA port.

SATA Mode Selection [AHCI]

Allows you to set the SATA configuration.

[Disabled] Disables the SATA function.

[IDE] Set to [IDE] when you want to use the Serial ATA hard disk drives as Parallel ATA physical storage devices.

[AHCI] Set to [AHCI] when you want the SATA hard disk drives to use the AHCI (Advanced Host Controller Interface). The AHCI allows the onboard storage driver to enable advanced Serial ATA features that increases storage performance on random workloads by allowing the drive to internally optimize the order of commands.

[RAID] Set to [RAID] when you want to create a RAID configuration from the SATA hard disk drives.

S.M.A.R.T. Status Check [Enabled]

S.M.A.R.T. (Self-Monitoring, Analysis and Reporting Technology) is a monitor system. When read/write of your hard disk errors occur, this feature allows the hard disk to report warning messages during the POST. Configuration options: [Enabled] [Disabled]

Hot Plug [Disabled]

This item only appears when you set the SATA Mode Selection item to [AHCI] or [RAID] and allows you to enable or disable the hot-plug support for each SATA port. Configuration options: [Enabled] [Disabled]

2.5.5 System Agent Configuration

Memory Remap Feature [Enabled]

Enables or disables the memory remap feature. Configuration options: [Enabled] [Disabled]

Graphics Configuration

Primary Display [Auto]

Allows you to decide which graphics controller to use as the primary boot device. Configuration options: [Auto] [iGFX] [PEG]

iGPU Memory [64M]

Allows you to set the iGPU memory size. Configuration options: [32M] [64M] [96M] [128M] ~ [448M] [480M] [512M] [1024M]

Render Standby [Enabled]

Allows you to enable or disable Render Standby by internal graphics devices. Configuration options: [Disabled] [Enabled]

NB PCIe Configuration

PEG0

PEG0 - Gen X [Auto]

Sets PEG0 B0:D1:F0 Gen1~Gen3. Configuration options: [Auto] [Gen1] [Gen2] [Gen3]

PEG0 ASPM [Disabled]

Sets the ASPM support for the PEG: Device 1 Function 0. This function does not take effect if PEG is not the currently active device. Configuration options: [Disabled] [Auto] [ASPM L0s] [ASPM L1] [ASPM L0sL1]

PEG2 - Gen X [Auto]

Sets PEG2 B0:D1:F0 Gen1~Gen3. Configuration options: [Auto] [Gen1] [Gen2] [Gen3]

PEG0 ASPM [Disabled]

Sets the ASPM support for the PEG: Device 1 Function 2. This function does not take effect if PEG is not the currently active device. Configuration options: [Disabled] [Auto] [ASPM L0s] [ASPM L1] [ASPM L0sL1]

Enable PEG [Enabled]

Allows you to enable or disable the PEG (PCI Express Graphics). Configuration options: [Disabled] [Enabled] [Auto]

De-emphasis Control [-3.5 dB]

Sets the De-emphasis control on the PEG. Configuration options: [-6 dB] [-3.5 dB]

PEG Sampler Calibrate [Auto]

Enables or disables the PEG Sampler calibration. Setting this item to [Auto] can disable SNB MB/DT and enable IVB A0 B0. Configuration options: [Disabled] [Enabled] [Auto]

Swing Control [Reduced]

Sets the execution of the PEG Swing Control on IVB C0 and later. Configuration options: [Reduced] [Half] [Full]

Gen3 Equalization [Enabled]

Enables or disables the execution of PEG Gen3 Equalization steps. Configuration options: [Disabled] [Enabled]

Gen3 Eq Phase 2 [Auto]

Sets the execution of the PEG Gen3 Equalization Phase 2. Configuration options: [Disabled] [Enabled] [Auto]

PEG Gen3 Root Port Preset Value for each Lane

Sets the Root Port Preset Value per lane for Gen3 Equalization.

Lane 0~15 [8]

Sets the value for each lane. Use the <+> and <-> keys to adjust the value.

PEG Gen3 Endpoint Preset Value for each Lane

Sets the Endpoint Preset Value per lane for Gen3 Equalization.

Lane 0~15 [8]

Sets the value for each lane. Use the <+> and <-> keys to adjust the value.

2.5.6 Intel TXT(LT) Configuration

Secure Mode Extensions (SMX) [Enabled]

Allows you to enable or disable the Intel Secure Mode Extensions (SMX) technology. Configuration options: [Disabled] [Enabled]

Intel TXT(LT) Support [Disabled]

This item can be configured only when the Intel SMX, Intel Virtualization Technology (VT), and Intel Virtualization Technology for Directed I/O (VT-d) technologies are all enabled. Allows you to enable or disable the Intel Trusted Execution Technology. Configuration options: [Disabled] [Enabled]

2.5.7 AMT Configuration

The items in this menu allow you to change the Intel® Active Management Technology (AMT) feature.

Intel AMT [Enabled]

Allow you to enable or disable the Intel® Active Management Technology (AMT) in the BIOS extension. Configuration options: [Enabled] [Disabled]



iAMT H/W is always enabled. This option just controls the BIOS extension execution. If enabled, this requires additional firmware in the SPI device.

Invoke MEBx [Disabled]

[Enabled] Execute MEBx automatically.

[Disabled] Press <Ctrl+P> to invoke MEBx.

Un-Configure ME [Disabled]

Sets this item to [Disabled] to unconfigure AMT/ME without using a password or set it to [Enabled] to use a password. Configuration options: [Enabled] [Disabled]

WatchDog [Disabled]

When set to [Enabled], the WatchDog Timer will monitor the time taken for each task performed by a software or hardware. Configuration options: [Enabled] [Disabled]



The following two items become configurable only when you set the **WatchDog Timer** item to [Enabled].

OS Timer [0]

Use the <+> and <-> keys to adjust the value or key in a number directly.

BIOS Timer [0]

Use the <+> and <-> keys to adjust the value or key in a number directly.

2.5.8 USB Configuration

The items in this menu allow you to change the USB-related features.



The **USB Devices** item shows the auto-detected values. If no USB device is detected, the item shows **None**.

Legacy USB Support [Enabled]

- [Enabled] Enables the support for USB devices on legacy operating systems (OS).
- [Disabled] The USB devices can be used only for the BIOS setup program.
- [Auto] Allows the system to detect the presence of USB devices at startup. If detected, the USB controller legacy mode is enabled. If no USB device is detected, the legacy USB support is disabled.

Legacy USB3.0 Support [Enabled]

- [Enabled] Enables the support for USB 3.0 devices on legacy operating systems (OS).
- [Disabled] Disables the function.

Intel xHCI Mode [Enabled]

Allows you to select an operation mode for the Intel xHCI controller. Configuration options: [Smart Auto] [Auto] [Enabled] [Disabled]

EHCI Hand-off [Disabled]

- [Enabled] Enables the support for operating systems without an EHCI hand-off feature.
- [Disabled] Disables the function.

2.5.9 Onboard Devices Configuration

HD Audio Controller [Enabled]

- [Enabled] Enables the High Definition Audio Controller.
- [Disabled] Disables the controller.



The following item appears only when you set the **HD Audio Controller** item to [Enabled].

Front Panel Type [HD]

Allows you to set the front panel audio connector (AAFP) mode to legacy AC'97 or high-definition audio depending on the audio standard that the front panel audio module supports.

[HD] Sets the front panel audio connector (AAFP) mode to high definition audio.

[AC97] Sets the front panel audio connector (AAFP) mode to legacy AC'97

Intel LAN Controller [Enabled]

[Enabled] Enables the Intel LAN controller.

[Disabled] Disables the controller.



Disable ME subsystem before you disable the LAN controller.

Intel PXE OPROM [Disabled]

This item appears only when you set the previous item to [Enabled] and allows you to enable or disable the PXE OptionRom of the Intel LAN controller. Configuration options: [Enabled] [Disabled]

Serial Port Configuration

The sub-items in this menu allow you to set the serial port configuration.



This item functions only if there is a serial port (COM1) connector on the motherboard.

Serial Port [Enabled]

Allows you to enable or disable the serial port (COM).

Configuration options: [Enabled] [Disabled]

Change Settings [IO=3F8h; IRQ=4]

Allows you to select the Serial Port base address. Configuration options: [IO=3F8h; IRQ=4] [IO=2F8h; IRQ=3] [IO=3E8h; IRQ=4] [IO=2E8h; IRQ=3]

Parallel Port Configuration

The sub-items in this menu allow you to set the parallel port configuration.

Parallel Port [Enabled]

Allows you to enable or disable the parallel port (LPT/LPTE).

Configuration options: [Enabled] [Disabled]

Change Settings [Auto]

Allows you to select an optimal setting for Super I/O devices. Configuration options: [Auto]

[IO=378h; IRQ=5;] [IO=378h; IRQ=5,6,7,9,10,11,12;] [IO=278h; IRQ=5,6,7,9,10,11,12;] [IO=3BCh; IRQ=5,6,7,9,10,11,12;]

Device Mode [STD Printer Mode]

Allows you to select the Printer Port mode. Configuration options: [STD Printer Mode] [SPP Mode] [EPP-1.9 and SPP Mode] [EPP-1.7 and SPP Mode] [ECP Mode] [ECP and EPP 1.9 Mode] [ECP and EPP 1.7 Mode]

2.5.10 APM

ErP Ready [Disabled]

This item allows user to switch off some power at S5 to get the system ready for ErP requirement. When set to Enabled, all other PME options will be switched off.
Configuration options: [Disabled] [Enabled]

Restore AC Power Loss [Power Off]

[Power On] The system goes into on state after an AC power loss.
[Power Off] The system goes into off state after an AC power loss.
[Last State] The system goes into either off or on state, whatever the system state was before the AC power loss.

Power On By PS/2 Keyboard [Disabled]

[Disabled] Disables the Power On by a PS/2 keyboard.
[Space Bar] Sets the Space Bar on the PS/2 keyboard to turn on the system.
[Ctrl-Esc] Sets the Ctrl+Esc key on the PS/2 keyboard to turn on the system.
[Power Key] Sets Power key on the PS/2 keyboard to turn on the system. This feature requires an ATX power supply that provides at least 1A on the +5VSB lead.

Power On By PCIE/PCI [Disabled]

[Disabled] Disables the PCIE/PCI devices to generate a wake event.
[Enabled] Enables the PCIE/PCI devices to generate a wake event.

Power On By Ring [Disabled]

[Disabled] Disables Ring to generate a wake event.
[Enabled] Enables Ring to generate a wake event.

Power On By RTC [Disabled]

[Disabled] Disables RTC to generate a wake event.
[Enabled] When set to [Enabled], the items **RTC Alarm Date (Days)** and **Hour/Minute/Second** will become user-configurable with set values.

2.5.11 Serial Port Console Redirection

Console Redirection [Enabled]

Enables or disables the console redirection feature. When enabled, it allows you to maintain a system from a remote location by redirecting keyboard input and text output through the serial port. Configuration options: [Enabled] [Disabled]

Terminal Type [VT-UTF8]

VT-UTF8 is the preferred terminal type for out-of-band management. The next best choice is VT100+ and then VT100. Configuration options: [VT100] [VT100+] [VT-UTF8] [ANSI]

2.5.12 Network Stack

Network Stack [Disable Link]

This item allows user to disable or enable the UEFI network stack. Configuration options: [Disable Link] [Enable]

Ipv4 PXE Support [Enabled]

This item appears only when you set the Network Stack item to [Enabled]. When this item is disabled, the IPV4 PXE boot option will not be created. Configuration options: [Disable Link] [Enabled]

Ipv6 PXE Support [Enabled]

This item appears only when you set the Network Stack item to [Enabled]. When this item is disabled, the IPV6 PXE boot option will not be created. Configuration options: [Disable Link] [Enabled]

2.6 Monitor menu

The Monitor menu displays the system temperature/power status, and allows you to change the fan settings.



Scroll down to display the following items:

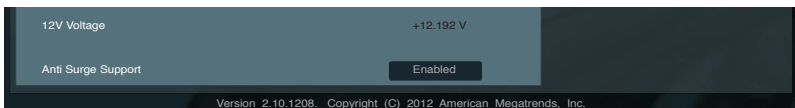

2.6.1 CPU Temperature / MB Temperature [xxx°C/xxx°F]

The onboard hardware monitor automatically detects and displays the CPU and motherboard temperatures. Select **Ignore** if you do not wish to display the detected temperatures.

2.6.2 CPU / Chassis Fan Speed [xxxx RPM] or [Ignore] / [N/A]

The onboard hardware monitor automatically detects and displays the CPU and chassis fan speeds in rotations per minute (RPM). If the fan is not connected to the motherboard, the field shows **N/A**. Select **Ignore** if you do not wish to display the detected speed.

2.6.3 CPU Q-Fan Control [Enabled]

[Disabled] Disables the CPU Q-Fan control feature.

[Enabled] Enables the CPU Q-Fan control feature.

CPU Fan Speed Low Limit [600 RPM]

This item appears only when you enable the **CPU Q-Fan Control** feature and allows you to disable or set the CPU fan warning speed.

Configuration options: [Ignore] [200 RPM] [300 RPM] [400 RPM] [500 RPM] [600 RPM]

CPU Fan Profile [Standard]

This item appears only when you enable the **CPU Q-Fan Control** feature and allows you to set the appropriate performance level of the CPU fan.

[Standard] Sets to [Standard] to make the CPU fan automatically adjust depending on the CPU temperature.

[Silent] Sets to [Silent] to minimize the fan speed for quiet CPU fan operation.

[Turbo] Sets to [Turbo] to achieve maximum CPU fan speed.

[Manual] Sets to [Manual] to assign detailed fan speed control parameters.



The following four items appear only when you set **CPU Fan Profile** to [Manual].

CPU Upper Temperature [70]

Use the <+> and <-> keys to adjust the upper limit of the CPU temperature. The values range from 20°C to 75°C.

CPU Fan Max. Duty Cycle(%) [100]

Use the <+> and <-> keys to adjust the maximum CPU fan duty cycle. The values range from 20% to 100%. When the CPU temperature reaches the upper limit, the CPU fan will operate at the maximum duty cycle.

CPU Lower Temperature [20]

Use the <+> and <-> keys to adjust the lower limit of the CPU temperature. The values range from 20°C to 75°C.

CPU Fan Min. Duty Cycle(%) [20]

Use the <+> and <-> keys to adjust the minimum CPU fan duty cycle. The values range from 0% to 100%. When the CPU temperature is under 40°C, the CPU fan will operate at the minimum duty cycle.

2.6.4 Chassis Q-Fan Control [Enabled]

[Disabled] Disables the Chassis Q-Fan control feature.

[Enabled] Enables the Chassis Q-Fan control feature.

Chassis Fan Speed Low Limit [600 RPM]

This item appears only when you enable the **Chassis Q-Fan Control** feature and allows you to disable or set the chassis fan warning speed.

Configuration options: [Ignore] [200 RPM] [300 RPM] [400 RPM] [500 RPM] [600 RPM]

Chassis Fan Profile [Standard]

This item appears only when you enable the **Chassis Q-Fan Control** feature and allows you to set the appropriate performance level of the chassis fan.

[Standard] Sets to [Standard] to make the chassis fan automatically adjust depending on the chassis temperature.

[Silent] Sets to [Silent] to minimize the fan speed for quiet chassis fan operation.

[Turbo] Sets to [Turbo] to achieve maximum chassis fan speed.

[Manual] Sets to [Manual] to assign detailed fan speed control parameters.



The following four items appear only when you set **Chassis Fan Profile** to [Manual].

Chassis Upper Temperature [70]

Use the <+> and <-> keys to adjust the upper limit of the CPU temperature. The values range from 40°C to 90°C.

Chassis Fan Max. Duty Cycle(%) [100]

Use the <+> and <-> keys to adjust the maximum chassis fan duty cycle. The values range from 60% to 100%. When the chassis temperature reaches the upper limit, the chassis fan will operate at the maximum duty cycle.

Chassis Lower Temperature [40]

Displays the lower limit of the chassis temperature.

CPU Fan Min. Duty Cycle(%) [60]

Use the <+> and <-> keys to adjust the minimum chassis fan duty cycle. The values range from 60% to 100%. When the chassis temperature is under 40°C, the chassis fan will operate at the minimum duty cycle.

2.6.5 CPU Voltage, 3.3V Voltage, 5V Voltage, 12V Voltage

The onboard hardware monitor automatically detects the voltage output through the onboard voltage regulators. Select **Ignore** if you do not want to detect this item.

2.6.6 Anti Surge Support [Enabled]

This item allows you to enable or disable the Anti Surge function.

Configuration options: [Disabled] [Enabled]

2.7 Boot menu

The Boot menu items allow you to change the system boot options.



2.7.1 Bootup NumLock State [On]

[On] Sets the power-on state of the NumLock to [On].

[Off] Sets the power-on state of the NumLock to [Off].

2.7.2 Full Screen Logo [Enabled]

[Enabled] Enables the full screen logo display feature.

[Disabled] Disables the full screen logo display feature.



Set this item to [Enabled] to use the ASUS MyLogo 2™ feature.

Post Report [5 sec]

This item appears only when the Full Screen Logo item is set to [Disabled] and allows you to set the waiting time for the system to display the post report. Configuration options: [1 sec] [2 sec] [3 sec] [4 sec] [5 sec] [6 sec] [7 sec] [8 sec] [9 sec] [10 sec] [Until Press ESC]

2.7.3 Wait for 'F1' If Error [Enabled]

When this item is set to [Enabled], the system waits for the F1 key to be pressed when error occurs. Configuration options: [Disabled] [Enabled]

2.7.4 Option ROM Messages [Force BIOS]

- [Force BIOS] The third-party ROM messages will be forced to display during the boot sequence.
- [Keep Current] The third-party ROM messages will be displayed only if the third-party manufacturer had set the add-on device to do so.

2.7.5 Setup Mode [EZ Mode]

- [Advanced Mode] Sets Advanced Mode as the default screen for entering the BIOS setup program.
- [EZ Mode] Sets EZ Mode as the default screen for entering the BIOS setup program.

2.7.6 UEFI/Legacy Boot [Enabled both UEFI and Legacy]

- [Enable both UEFI and Legacy] Enables both UEFI and Legacy boot.
- [Disable UEFI] Enables the Legacy boot, and disables the UEFI boot.
- [Disable Legacy] Enables the UEFI boot, and disables the Legacy boot.

2.7.7 PCI ROM Priority [Legacy ROM]

- [Legacy ROM] Launch Legacy ROM
- [EFI Compatibe ROM] Launch UEFI Compatible ROM

2.7.8 Boot Option Priorities

These items specify the boot device priority sequence from the available devices. The number of device items that appears on the screen depends on the number of devices installed in the system.



-
- To select the boot device during system startup, press <F8> when ASUS Logo appears.
 - To access Windows OS in Safe Mode, press <F8> after POST.
-

2.7.9 Boot Override

These items displays the available devices. The number of device items that appears on the screen depends on the number of devices installed in the system. Click an item to start booting from the selected device.

2.8 Tools menu

The Tools menu items allow you to configure options for special functions. Select an item then press <Enter> to display the submenu.

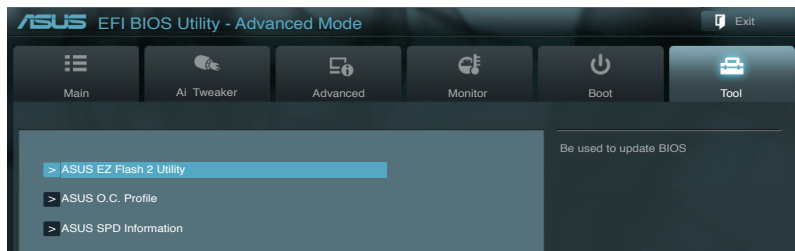

2.8.1 ASUS EZ Flash 2 Utility

Allows you to run ASUS EZ Flash 2. Press [Enter] to launch the ASUS EZ Flash 2 screen.



For more details, see section 2.1.2 **ASUS EZ Flash 2**.

2.8.2 ASUS O.C. Profile

This item allows you to store or load multiple BIOS settings.



The **Setup Profile Status** items show **Not Installed** if no profile is created.

Label

Allows you to input the label of the setup profile.

Save to Profile

Allows you to save the current BIOS settings to the BIOS Flash, and create a profile. Key in a profile number from one to eight, press <Enter>, and then select **Yes**.

Load from Profile

Allows you to load the previous BIOS settings saved in the BIOS Flash. Key in the profile number that saved your CMOS settings, press <Enter>, and then select **Yes**.



-
- DO NOT shut down or reset the system while updating the BIOS to prevent the system boot failure!
 - We recommend that you update the BIOS file only coming from the same memory/CPU configuration and BIOS version.
-

2.8.3 ASUS SPD Information

DIMM Slot # [Slot 1]

Displays the Serial Presence Detect (SPD) information of the DIMM module installed on the selected slot. Configuration options: [Slot 1] [Slot 2] [Slot 3] [Slot 4]

2.9 Exit menu

The Exit menu items allow you to load the optimal default values for the BIOS items, and save or discard your changes to the BIOS items. You can access the **EZ Mode** from the Exit menu.

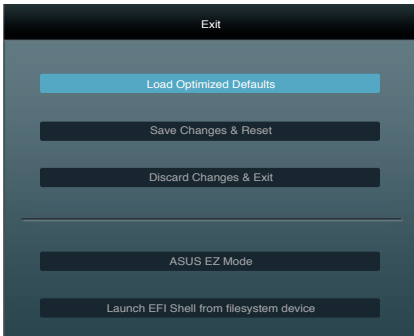

Load Optimized Defaults

This option allows you to load the default values for each of the parameters on the Setup menus. When you select this option or if you press <F5>, a confirmation window appears. Select **Yes** to load the default values.

Save Changes & Reset

Once you are finished making your selections, choose this option from the Exit menu to ensure the values you selected are saved. When you select this option or if you press <F10>, a confirmation window appears. Select **Yes** to save changes and exit.

Discard Changes & Exit

This option allows you to exit the Setup program without saving your changes. When you select this option or if you press <Esc>, a confirmation window appears. Select **Yes** to discard changes and exit.

ASUS EZ Mode

This option allows you to enter the EZ Mode screen.

Launch EFI Shell from filesystem device

This option allows you to attempt to launch the EFI Shell application (shellx64.efi) from one of the available devices that have a filesystem.

Appendices

Notices

Federal Communications Commission Statement

This device complies with Part 15 of the FCC Rules. Operation is subject to the following two conditions:

- This device may not cause harmful interference.
- This device must accept any interference received including interference that may cause undesired operation.

This equipment has been tested and found to comply with the limits for a Class B digital device, pursuant to Part 15 of the FCC Rules. These limits are designed to provide reasonable protection against harmful interference in a residential installation. This equipment generates, uses and can radiate radio frequency energy and, if not installed and used in accordance with manufacturer's instructions, may cause harmful interference to radio communications. However, there is no guarantee that interference will not occur in a particular installation. If this equipment does cause harmful interference to radio or television reception, which can be determined by turning the equipment off and on, the user is encouraged to try to correct the interference by one or more of the following measures:

- Reorient or relocate the receiving antenna.
- Increase the separation between the equipment and receiver.
- Connect the equipment to an outlet on a circuit different from that to which the receiver is connected.
- Consult the dealer or an experienced radio/TV technician for help.



The use of shielded cables for connection of the monitor to the graphics card is required to assure compliance with FCC regulations. Changes or modifications to this unit not expressly approved by the party responsible for compliance could void the user's authority to operate this equipment.

IC: Canadian Compliance Statement

Complies with the Canadian ICES-003 Class B specifications. This device complies with RSS 210 of Industry Canada. This Class B device meets all the requirements of the Canadian interference-causing equipment regulations.

This device complies with Industry Canada license exempt RSS standard(s). Operation is subject to the following two conditions: (1) this device may not cause interference, and (2) this device must accept any interference, including interference that may cause undesired operation of the device.

Cet appareil numérique de la Classe B est conforme à la norme NMB-003 du Canada.

Cet appareil numérique de la Classe B respecte toutes les exigences du Règlement sur le matériel brouilleur du Canada.

Cet appareil est conforme aux normes CNR exemptes de licence d'Industrie Canada. Le fonctionnement est soumis aux deux conditions suivantes :

- (1) cet appareil ne doit pas provoquer d'interférences et
- (2) cet appareil doit accepter toute interférence, y compris celles susceptibles de provoquer un fonctionnement non souhaité de l'appareil.

Canadian Department of Communications Statement

This digital apparatus does not exceed the Class B limits for radio noise emissions from digital apparatus set out in the Radio Interference Regulations of the Canadian Department of Communications.

This class B digital apparatus complies with Canadian ICES-003.

VCCI: Japan Compliance Statement

VCCI Class B Statement

情報処理装置等電波障害自主規制について

この装置は、情報処理装置等電波障害自主規制協議会（VCCI）の基準に基づくクラスB情報技術装置です。この装置は家庭環境で使用されることを目的としていますが、この装置がラジオやテレビジョン受信機に近接して使用されると、受信障害を引き起こすことがあります。

取扱説明書に従って正しい取り扱いをして下さい。

KC: Korea Warning Statement

B급 기기 (가정용 방송통신기자재)

이 기기는 가정용(B급) 전자파적합기기로서 주로 가정에서 사용하는 것을 목적으로 하며, 모든 지역에서 사용할 수 있습니다.

*당해 무선설비는 전파혼신 가능성이 있으므로 인명안전과 관련된 서비스는 할 수 없습니다.

REACH

Complying with the REACH (Registration, Evaluation, Authorisation, and Restriction of Chemicals) regulatory framework, we published the chemical substances in our products at ASUS REACH website at <http://csr.asus.com/english/REACH.htm>.



DO NOT throw the motherboard in municipal waste. This product has been designed to enable proper reuse of parts and recycling. This symbol of the crossed out wheeled bin indicates that the product (electrical and electronic equipment) should not be placed in municipal waste. Check local regulations for disposal of electronic products.



DO NOT throw the mercury-containing button cell battery in municipal waste. This symbol of the crossed out wheeled bin indicates that the battery should not be placed in municipal waste.

ASUS Recycling/Takeback Services

ASUS recycling and takeback programs come from our commitment to the highest standards for protecting our environment. We believe in providing solutions for you to be able to responsibly recycle our products, batteries, other components as well as the packaging materials. Please go to <http://csr.asus.com/english/Takeback.htm> for the detailed recycling information in different regions.

ASUS contact information

ASUSTeK COMPUTER INC.

Address	15 Li-Te Road, Peitou, Taipei, Taiwan 11259
Telephone	+886-2-2894-3447
Fax	+886-2-2890-7798
E-mail	info@asus.com.tw
Web site	www.asus.com.tw

Technical Support

Telephone	+86-21-38429911
Online support	support.asus.com

ASUS COMPUTER INTERNATIONAL (America)

Address	800 Corporate Way, Fremont, CA 94539, USA
Telephone	+1-510-739-3777
Fax	+1-510-608-4555
Web site	usa.asus.com

Technical Support

Telephone	+1-812-282-2787
Support fax	+1-812-284-0883
Online support	support.asus.com

ASUS COMPUTER GmbH (Germany and Austria)

Address	Harkort Str. 21-23, D-40880 Ratingen, Germany
Fax	+49-2102-959911
Web site	www.asus.de
Online contact	www.asus.de/sales

Technical Support

Telephone	+49-1805-010923*
Support Fax	+49-2102-9599-11
Online support	support.asus.com

* EUR 0.14/minute from a German fixed landline; EUR 0.42/minute from a mobile phone.

DECLARATION OF CONFORMITY

Per FCC Part 2, Section 2.1077(a)



Responsible Party Name: Asus Computer International

Address: 800 Corporate Way, Fremont, CA 94539.

Phone/Fax No: (510)739-3777/(510)608-4555

hereby declares that the product

Product Name : Motherboard

Model Number : P8Q77-M

Conforms to the following specifications:

- FCC Part 15, Subpart B, Unintentional Radiators
- FCC Part 15, Subpart C, Intentional Radiators
- FCC Part 15, Subpart E, Intentional Radiators

Supplementary Information:

This device complies with part 15 of the FCC Rules. Operation is subject to the following two conditions: (1) This device may not cause harmful interference, and (2) this device must accept any interference received, including interference that may cause undesired operation.

Representative Person's Name : Steve Chang / President

Steve Chang

Signature : _____
Date : Mar. 19, 2012

Ver. 110101

EC Declaration of Conformity



We, the undersigned,

Manufacturer: ASUS (K) COMPUTER INC.
Address: 4F, No. 150, LITE Rd., PEITOU TAIPEI 112, TAIWAN
Country: TAIWAN
Authorized representative in Europe:
ASUS COMPUTER GmbH
HARKORT STR. 21-23, 40889 RATINGEN
Country: GERMANY

declare the following apparatus:

Product name : Motherboard
Model name : P8Q77-M

conform with the essential requirements of the following directives:

- 2004/108/EC EMC Directive**
 EN 55024:2010
 EN 61000-3-2:2006+A2:2009
 EN 61000-3-3:2008
 EN 55013:2007/A1:2009/A2:2006
 EN 55022:2010

- 1999/5/EC R & TTE Directive**
 EN 50133:2001
 EN 300 440-1 V1.1 (2001-08)
 EN 300 440-2 V1.1 (2001-08)
 EN 300 440-3 V1.1 (2001-08)
 EN 300 440-4 V1.1 (2009-05)
 EN 300 440-5 V1.1 (2009-05)
 EN 301 908-1 V5.2 (2001-05)
 EN 301 908-2 V5.2 (2001-07)
 EN 301 908-3 V1.1 (2009-01)
 EN 302 544-2 V1.1 (2009-01)
 EN 302 623 V1.1 (2009-01)
 EN 302 328-3 V1.3 (2007-09)
 EN 302 328-2 V1.5 (2010-02)
 EN 55089:2001
 EN 62379:2010

- 2002/95/EC RoHS Directive**
 EN 60950-1/A1:2009
 EN 60950-1/A2:2011
 EN 60065:2002 / A2:2010
 EN 60065:2002 / A12:2011

- 2009/123/EC EIP Directive**
 Regulation (EC) No. 1275/2008
 Regulation (EC) No. 642/2009

- 2002/96/EC RoHS Directive**
 Regulation (EC) No. 642/2009



(EC conformity marking)

Position : CEO
Name : Jerry Shen

Jerry Shen

Signature : _____

Declaration Date: Dec. 10, 2012
Year to begin affixing CE marking: 2012

Ver. 121001

Free Manuals Download Website

<http://myh66.com>

<http://usermanuals.us>

<http://www.somanuals.com>

<http://www.4manuals.cc>

<http://www.manual-lib.com>

<http://www.404manual.com>

<http://www.luxmanual.com>

<http://aubethermostatmanual.com>

Golf course search by state

<http://golfingnear.com>

Email search by domain

<http://emailbydomain.com>

Auto manuals search

<http://auto.somanuals.com>

TV manuals search

<http://tv.somanuals.com>