

# ASUS<sup>®</sup>

# P565

## User Manual

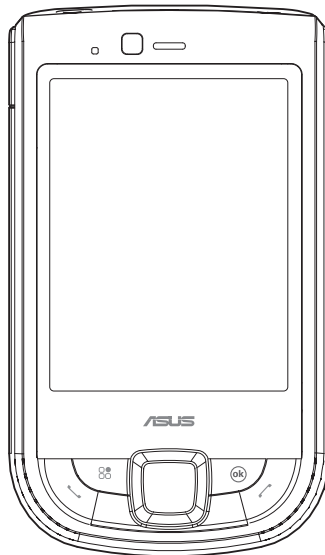

E4024

First Edition

August 2008

Copyright © 2008 ASUSTek Computers, Inc. All Rights Reserved.

No part of this manual, including the products and software described in it, may be reproduced, transmitted, transcribed, stored in a retrieval system, or translated into any language in any form or by any means, except documentation kept by the purchaser for backup purposes, without the express written permission of ASUS Telecom ("ASUS").

Product warranty or service will not be extended if: (1) the product is repaired, modified or altered, unless such repair, modification or alteration is authorized in writing by ASUS; or (2) the serial number of the product is defaced or missing.

ASUS PROVIDES THIS MANUAL "AS IS" WITHOUT WARRANTY OF ANY KIND, EITHER EXPRESS OR IMPLIED, INCLUDING BUT NOT LIMITED TO THE IMPLIED WARRANTIES OR CONDITIONS OF MERCHANTABILITY OR FITNESS FOR A PARTICULAR PURPOSE. IN NO EVENT SHALL ASUS, ITS DIRECTORS, OFFICERS, EMPLOYEES OR AGENTS BE LIABLE FOR ANY INDIRECT, SPECIAL, INCIDENTAL, OR CONSEQUENTIAL DAMAGES (INCLUDING DAMAGES FOR LOSS OF PROFITS, LOSS OF BUSINESS, LOSS OF USE OR DATA, INTERRUPTION OF BUSINESS AND THE LIKE), EVEN IF ASUS HAS BEEN ADVISED OF THE POSSIBILITY OF SUCH DAMAGES ARISING FROM ANY DEFECT OR ERROR IN THIS MANUAL OR PRODUCT.

SPECIFICATIONS AND INFORMATION CONTAINED IN THIS MANUAL ARE FURNISHED FOR INFORMATIONAL USE ONLY, AND ARE SUBJECT TO CHANGE AT ANY TIME WITHOUT NOTICE, AND SHOULD NOT BE CONSTRUED AS A COMMITMENT BY ASUS. ASUS ASSUMES NO RESPONSIBILITY OR LIABILITY FOR ANY ERRORS OR INACCURACIES THAT MAY APPEAR IN THIS MANUAL, INCLUDING THE PRODUCTS AND SOFTWARE DESCRIBED IN IT.

Products and corporate names appearing in this manual may or may not be registered trademarks or copyrights of their respective companies, and are used only for identification or explanation and to the owners' benefit, without intent to infringe.

# Table of Contents

<b>Safety information .....</b>	<b>14</b>
<b>Mobile phone etiquette.....</b>	<b>22</b>
Mobile manners.....	22
<b>Specifications .....</b>	<b>23</b>
<b>Package contents .....</b>	<b>24</b>
<b>Chapter 1: Getting started</b>	
<b>Getting to know your device.....</b>	<b>26</b>
Layout .....	26
<b>Getting your device ready.....</b>	<b>30</b>
Installing the SIM card and battery.....	30
Charging the battery.....	32
Installing and removing a microSD card .....	33
<b>Starting up.....</b>	<b>34</b>
Powering your device.....	34
Using the stylus.....	34

Calibrating your device.....	35
Locking your device .....	35
<b>The Home screen.....</b>	<b>36</b>
ASUS Today.....	37
The Today screen.....	44
Using MultiHome.....	49
<b>AnyTime Launcher .....</b>	<b>50</b>
<b>Searching for information.....</b>	<b>52</b>
<b>Getting Help .....</b>	<b>52</b>
<b>Chapter 2: Entering data</b>	
<b>Using the Input Panel.....</b>	<b>54</b>
Using the Block Recognizer .....	54
Using the onscreen keyboard .....	55
Using the Letter Recognizer.....	56
Using the Transcriber.....	56
<b>Writing and drawing on the screen.....</b>	<b>57</b>
<b>Recording voice.....</b>	<b>59</b>

## **Chapter 3: Device Synchronization**

<b>Synchronizing your device</b> .....	<b>61</b>
<b>Microsoft® ActiveSync</b> .....	<b>61</b>
Synchronizing via mini-USB .....	63
Synchronizing via Bluetooth® .....	64
Synchronizing with an Exchange Server .....	65

## **Chapter 4: Phone features**

<b>Using the phone</b> .....	<b>68</b>
Phone pad .....	68
Turning off the phone function .....	68
Adjusting the volume .....	69
<b>Making a call</b> .....	<b>70</b>
Making a voice call .....	70
Making emergency calls .....	76
Making international calls .....	76
Making a video call .....	76
Video Call Setting .....	78

<b>Receiving a call</b> .....	<b>79</b>
<b>Options during a call</b> .....	<b>80</b>
Managing multiple calls.....	81
<b>ASUS CallFilter</b> .....	<b>82</b>
Launching the shortcut menu.....	82
Managing the Accept list .....	83
Managing the Reject list.....	84
<b>Chapter 5: Messaging</b>	
<b>E-mail messaging</b> .....	<b>86</b>
Setting up an e-mail account.....	86
Sending an e-mail message.....	88
<b>Threaded SMS</b> .....	<b>92</b>
Sending a threaded SMS.....	92
<b>MMS messaging</b> .....	<b>93</b>
Accessing MMS .....	93
Editing MMS settings .....	93
Sending an MMS message.....	94

<b>Windows® Live .....</b>	<b>96</b>
Using Hotmail® .....	96
Using Windows® Live Messenger .....	97

## **Chapter 6: Organizing your life**

<b>Using Contacts .....</b>	<b>101</b>
Viewing Contacts .....	101
Using the SIM Manager .....	104
<b>Using Calendar .....</b>	<b>105</b>
Scheduling an appointment.....	105
Viewing an appointment.....	106
Viewing your schedule .....	106
<b>Using Tasks.....</b>	<b>107</b>
The Tasks list .....	107

## **Chapter 7: Customizing your device**

<b>Customizing the Start menu .....</b>	<b>109</b>
<b>Using the Profile Manager .....</b>	<b>109</b>
<b>Customizing the Today screen.....</b>	<b>111</b>
<b>Entering your contact information.....</b>	<b>112</b>
<b>Setting up sounds and notifications.....</b>	<b>113</b>
<b>Setting the date, time, and alarm .....</b>	<b>113</b>
<b>Setting the ringtone.....</b>	<b>115</b>
Adding ringtone to selection.....	115
Changing the ringtone.....	115
<b>Wake up settings .....</b>	<b>116</b>

## **Chapter 8: Getting connected**

<b>Using the Wireless Manager.....</b>	<b>118</b>
Enabling/disabling flight mode .....	118
Enabling/disabling the wireless connections.....	118
Using your PDA phone as an external modem .....	119
Using Direct Push .....	120



<b>Using Bluetooth® .....</b>	<b>121</b>
Activating Bluetooth in your device .....	121
Adding Bluetooth devices.....	122
<b>Using Wi-Fi .....</b>	<b>122</b>
Turning on Wi-Fi.....	122
Configuring wireless networks .....	123
Adding a wireless network .....	124
<b>Setting a GPRS connection .....</b>	<b>125</b>
Connecting GPRS.....	126
Disconnecting GPRS .....	127
Using the GPRS Tool .....	127
<b>Setting the network .....</b>	<b>128</b>
Configuring the network .....	128
Setting your preferred networks .....	128
<b>GSM/3G Networks.....</b>	<b>129</b>

## **Chapter 9: GPS features**

<b>GPS Catcher</b> .....	<b>131</b>
Updating GPS data.....	131
Setting GPS Catcher.....	131
<b>External GPS</b> .....	<b>132</b>

## **Chapter 10: Multimedia features**

<b>Using the camera</b> .....	<b>134</b>
Launching the camera.....	134
Camera mode .....	135
Taking photos.....	137
Video mode .....	138
Recording videos .....	139
<b>Viewing pictures and videos</b> .....	<b>140</b>
Viewing pictures and videos.....	140
Editing pictures and photos.....	140
<b>Streaming Player</b> .....	<b>142</b>
Playing a streaming file.....	143
Connecting with bookmarks.....	143

<b>EziMusic</b> .....	145
<b>EziPhoto</b> .....	146
<b>YouTube&amp;Flickr</b> .....	147
Using YouTube.....	147
Using Flickr .....	148

## **Chapter 11: Business features**

<b>Ur Time</b> .....	151
Setting time .....	151
Setting alarm.....	151
Setting the World Cock .....	152
<b>Remote Calendar</b> .....	152
Synchronizing your calendar.....	153
Setting Remote Calendar.....	154
<b>Meeting Time Planner</b> .....	155
<b>WorldCard Mobile</b> .....	156

## Chapter 12: ASUS Special features

<b>Gester</b> .....	<b>158</b>
Enabling Gester .....	158
Using Gester gestures .....	159
<b>ASUS Zip</b> .....	<b>160</b>
<b>Backup</b> .....	<b>161</b>
Backing up files .....	161
Restoring files .....	162
<b>Newstation</b> .....	<b>163</b>
Using Newstation .....	163
Using Newstation menus .....	165

## Chapter 13: Other features

<b>Microsoft® Office Mobile</b> .....	<b>167</b>
Excel® Mobile .....	168
OneNote® Mobile.....	169
Word® Mobile .....	171
PowerPoint® Mobile.....	173

ClearVue PDF .....	175
Auto Cleaner .....	176
Restoring default factory settings .....	177
System information .....	177
Task Manager .....	178
Removing programs.....	179
Google Search .....	179
Google Maps Mobile.....	180
SMS Location Link.....	182

## Appendices

Notices.....	184
Replaceable batteries .....	184
Operator access with a tool.....	184
Specific Absorption Rate (SAR) .....	185
Bodyworn operation .....	185
Exposure to radio waves.....	185
ASUS Contact information.....	188

# Safety information

## Phone care

Do not attempt to open the phone casing. There are no user serviceable parts inside and you might damage sensitive electronic circuits and components. Unauthorized disassembly will void the warranty.

Do not leave your phone exposed to strong sunlight or excessive heat for a prolonged period. This may damage it.

Do not handle your phone with wet hands or expose it to moisture or liquids of any kind. Continuous changes from a cold to a warm environment may lead to condensation inside the phone, resulting in corrosion and possible damage.

If you pack your phone in your suitcase during travel, beware of damage. Cramming a suitcase may crack the LCD display. Remember to switch off your wireless connections during air travel.

As with all other radio devices, touching the built-in antenna area during telephone conversation may impair the quality and lead to shorter standby time due to increased power consumption.

## The battery

Your phone is equipped with a high performance Li-Ion battery. Observe the maintenance guidelines for a longer battery life.

- Avoid charging in extremely high or low temperature. The battery has its optimum performance in an ambient temperature of +5 °C to +50 °C.
- Do not store the battery near a fire or heat source.
- Use only the battery approved by the manufacturer.

- Never replace the battery with a non-approved battery.
- Never soak the battery in water or any other liquid.
- Never try to open the battery as it contains substances that might be harmful if swallowed or allowed to come into contact with unprotected skin.
- Never short-circuit the battery, as it may overheat and cause a fire. Keep it away from jewellery and other metal objects.
- Never dispose of the battery in fire. It could explode and release harmful substances into the environment.
- Never dispose of the battery with your regular household waste. Take it to a hazardous material collection point.
- Do not touch the battery terminals.

## The charger

- Avoid using the phone while charging.
- Use only the charger supplied with your phone.
- Never pull the charger cord to release it from the mains – pull the charger itself.

---

### **WARNING!**

- There is a risk of explosion if the battery is replaced by an incorrect type.
  - Dispose of used batteries according to the instructions.
-

## Memory card

- Do not remove or insert a memory card or turn off the handset while data on the card is being read.
- Do not touch the metal terminals with your hands or metal objects.
- Do not bend the memory card or subject it to violent impacts. Keep it away from water and high temperatures.
- Keep all memory cards out of the reach of small children.
- Do not short circuit the contact points or expose it to liquids or moisture. When not in use, keep it in an antistatic container.
- Do not use force when inserting or handling the card, and do not expose it to excessive heat or strong magnetic fields.

## Cleaning and storing

- Your phone should always be handled with care and protected from dirt, dust and dampness. To avoid scratches, never place your phone face down.
- If cleaning is necessary, switch the phone off and wipe carefully with a soft, slightly damp (not wet) cloth. Use a cotton swab to clean the camera lens. Allow the phone to dry completely before switching it on. Never use solvents for cleaning.
- If you are not going to use your phone for some time, fully charge the battery and store the phone in a dry place away from direct sunlight. Your phone should be switched off during storage. Recharge every 6 to 12 months.
- Never expose your phone to heat or strong sunlight.



- Never expose your phone to moisture or liquids of any kind.
- Do not paint your phone or otherwise block the keypad, microphone or earpiece function.
- Do not place stickers that may block the keypad or disturb other functions such as microphone, earpiece, or camera lens.

---

**WARNING!** Failure to follow these instructions may lead to serious personal injury and possible property damage.

---

## Driving safely

Never use handheld phones while driving. It is an offence, that while driving, to hold a phone or cradle it in your neck at any point, during the setup, making or taking of a phone call, text message or any other data related mobile communication. Use of fully installed car kits are still permitted, as are the use of alternate handsfree accessories.

In the interest of safety, we would recommend the use of a cradle while using any form of handsfree accessory.

While driving, we recommend that you use voicemail wherever possible, and that you listen to your messages when you are not in the car. If you must make a handsfree call when driving, keep it brief.

Do not place objects, including both installed or portable wireless equipment, in the area over the airbag or in the airbag deployment area. An airbag inflates with great force. If the airbag inflates, serious injury could result.

## Electronic devices

Most modern electronic equipment is shielded from RF energy.

However, certain electronic equipment may not be shielded against the RF signals from your device.

## **Pacemakers**

The Health Industry Manufacturers' Association recommends that a minimum separation of six (6") inches be maintained between a phone and a pacemaker to avoid potential interference with the pacemaker. These recommendations are consistent with the independent research by and recommendations of Wireless Technology Research.

### **If you have a pacemaker:**

- Always keep your phone more than six inches (15cm) from your pacemaker when turned on.
- Do not carry your phone in your breast pocket.
- Use the ear opposite the pacemaker to minimize the potential for interference
- If you have any reason to suspect that interference is taking place, turn your phone off immediately.

## **Hearing aids**

Some digital phones may interfere with some hearing aids. In the event of such interference, call ASUS Customer Service to discuss alternatives.

## Other medical devices

If you use any other personal medical device, consult the manufacturer of your device to determine if it is adequately shielded from external RF energy. Your physician may be able to assist you in obtaining this information.

Turn your phone off in healthcare facilities when any regulations posted in these areas instruct you to do so.

Hospitals or healthcare facilities may be using equipment that could be sensitive to external RF energy.

## Vehicles

RF signals may affect improperly installed or inadequately shielded electronic systems in motor vehicles. Check with the manufacturer or its representative regarding your vehicle. You should also consult the manufacturer of any equipment added to your vehicle.

## Posted facilities

Turn your phone off where posted notices so require.

## Magnetic media

Magnetic fields generated by mobile devices may damage data on magnetic storage media, such as credit cards, computer discs or tapes. Do not place your phone next to such media.

You should never expose your phone to strong magnetic fields as this may cause temporary malfunction.

## Other Safety Guidelines

### Aircraft

Regulations prohibit using your phone while in the air. Switch off your phone before boarding an aircraft or turn off the wireless connections.

### Blasting areas

To avoid interfering with blasting operations, turn your phone off when in a 'blasting area' or in areas posted: "Turn off two-way radio." Obey all signs and instructions.

### Potentially explosive environments

Turn your phone off when in any area with a potentially explosive environment and obey all signs and instructions.

Sparks in such areas could cause an explosion or fire resulting in bodily injury or even death.

Areas with a potentially explosive environment are often, but not always, clearly marked. They include fuelling areas such as gas stations, below decks on boats, fuel or chemical transfer or storage facilities, vehicles using liquified petroleum gas (such as propane or butane), areas where the air contains chemicals or articles, such as grain, dust, or metal powders, and any other area where you would normally be advised to turn off your vehicle's engine.

### Choking

Keep your phone away from children as the SIM card and other small parts present a choking hazard.

## Cautions

Your device is a high quality piece of equipment. Before operating, read all instructions and cautionary markings on (1) AC Adapter (2) Battery and (3) Product Using Battery.

- Do not use this device in an extreme environment where high temperature or high humidity exists. The device has its optimum performance in an ambient temperature of 0~40°C.
- Do not abuse the device. Avoid striking, shaking or giving it a shock. When not using the unit, lay it down to avoid possible damage due to instability.
- Do not expose this device to rain or other liquid.
- Do not use unauthorized accessories.
- Do not disassemble the phone or its accessories. If service or repair is required, return the unit to an authorized service center. If the unit is disassembled, a risk of electric shock or fire may result.
- Do not short-circuit the battery terminals with metal items.

## Mobile phone etiquette

As mobile phone usage rises, there is now a need to create a set of manners in using a mobile phone in professional and social settings. This section provides you with basic tips with regards to respecting others while using your mobile phone.

### Mobile manners

- Avoid talking on your mobile phone when in enclosed public places such as theaters, libraries, museums, places of worship, elevators, or auditoriums.
- Avoid using your mobile phone while doing other tasks such as driving, shopping, banking, waiting in line, or conducting other personal business.
- Avoid using annoying ringtones.
- Avoid taking a call on your mobile phone during business meetings, appointments, or interviews.
- Look for a private place to take a call, and keep your phone conversations brief.
- Talk on your mobile phone quietly, and do not shout.
- Put your mobile phone on silent or vibrator mode to avoid disturbing others.
- Ask permission before taking a picture or a video clip of another person.
- Avoid using capital letters when sending SMS messages as this can be interpreted as shouting.
- When making a call, introduce yourself to the person at the other end of the line, and do not hang up without saying goodbye.

## Specifications

Processor	Marvell Tavor (800MHz)
Operating System	Microsoft® Windows Mobile™ 6.1 Professional
Memory	256 MB NAND Flash ROM 128 MB DDR
Display	2.8-inch TFT Touchscreen Liquid Crystal Display (LCD), VGA 480 x 640 pixels with 65k colors
Frequency band	HSDPA 3.6Mbps, UMTS 2100Mhz, EDGE/GPRS/GSM (900/1800/1900Mhz): Class 10
GPS	SiRF Star III chipset
GPRS	Class B, Multi-slot Class 10
Camera	3.0 megapixel Auto-Focus camera
Connectivity	Bluetooth : V2.0 EDR USB : USB 1.1 (FS) WLAN : 802.11b/g
Battery capacity	1300 mAh Lithium Ion ( <b>Manufacturer:</b> Hitech; <b>Model:</b> SBP-19)
Expansion slot	MicroSD card slot Supports Secure Digital High Capacity (SDHC) storage card
Audio	Mini-USB audio port Built-in microphone and output speaker
Weight	118g (with battery)
Dimension	102 x 60.5 x 16 mm
Talk time*	3G: 3-5 hrs; 2G: 4-6 hrs
Standby time*	3G: 150-200 hrs; 2G: 200-250 hrs

\* Depending on network environment and phone usage.

**NOTE:** Specifications are subject to change without notice.

# Package contents

Check your product package for the following items:

## Standard items

- ASUS P565 PDA phone
- Battery
- AC Adapter
- Mini-USB cable
- Wired headset
- Stylus
- Protection case
- Bonus CD (with User Manual electronic file)
- Getting Started CD
- Quick Start Guide
- Warranty Card
- microSD Card\*
- Car charger\*
- Car Kit (PDA holder and windshield suction pedestal)\*

\* Optional

---

**NOTE:** If any of the above items is damaged or missing, contact your retailer.

---



# Chapter 1

## Getting started

- **Getting to know your device**
- **Getting your device ready**
- **Starting up**
- **The Home screen**
- **Using MultiHome**
- **AnyTime Launcher**
- **Searching for information**
- **Getting Help**

# Getting to know your device

## Layout

### Front features

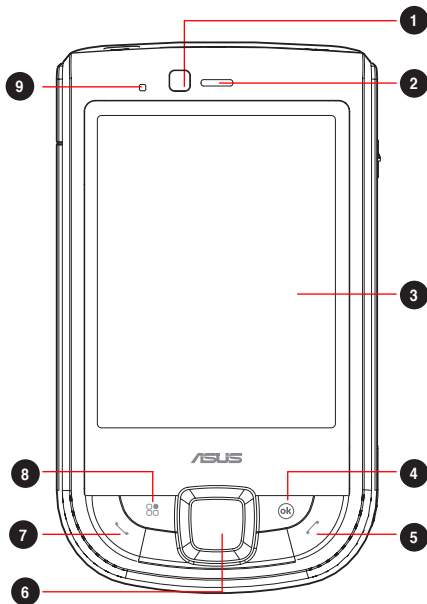

### Back features

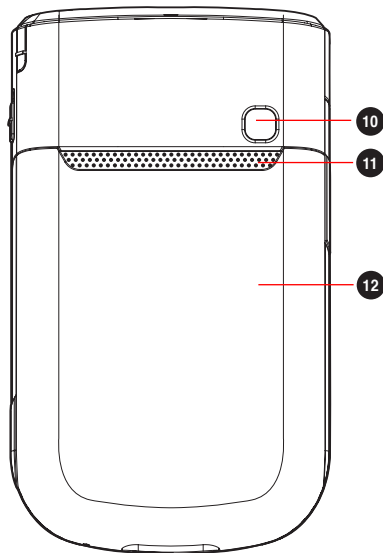

No.	Item	Description
1	Front camera lens	Front camera lens for video call.
2	Earpiece receiver	Allows you to listen to an active call.
3	LCD touch screen	This 2.8-inch, 65,536-color, 480 x 640 resolution, touchscreen TFT LCD allows you to write, draw, or make selections using the stylus.
4	OK key	Press to confirm a command or press to close/exit an application.
5	End key	Press to end a call.
6	Navigation key	This five-direction navigation key allows you to navigate through menus. Press down to confirm a command.
7	Call key	Press to receive an incoming call or to make a call.
8	AnyTime Launcher key	Press to launch the AnyTime Launcher application.
9	Notification LED	This multi-color LED notifies the following: <ul style="list-style-type: none"> <li>• Green - Phone fully charged.</li> <li>• Flashing green - Network detected.</li> <li>• Red - Phone is charging.</li> <li>• Flashing red - Event notification.</li> <li>• Flashing blue - Bluetooth®, Wi-Fi®, or GPS is ON.</li> </ul>
10	Camera lens	This 3.0 megapixel camera comes with auto-focus lens for taking pictures and video clips.
11	Output speaker	Allows you to listen to audio media and phone calls.
12	Battery compartment	Contains the battery that supplies power to the device.

## Left features

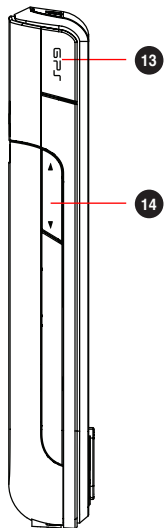

## Right features

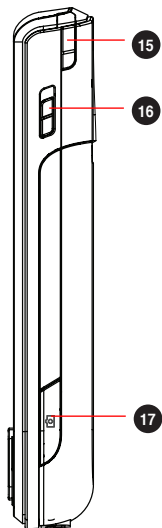

## Top features

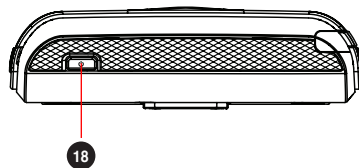

## Bottom features

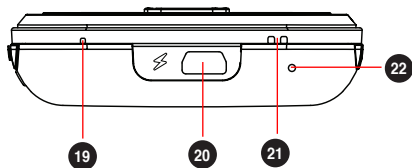

No.	Item	Description
13	GPS antenna port	Allows you to install an external GPS antenna for better signal reception.
14	Volume key	Allows you to adjust the volume.
15	Stylus	Use the stylus to write, draw, or select items on the LCD touch screen.
16	Hold button	Slide downward to disable all keys including the LCD touch screen.
17	Camera key	Press to launch the camera. In camera mode, half-press to focus the object, and full-press to take a picture. In video mode, press to start recording and press again to stop.
18	Power button	Press and hold to power on/off the device. Press to set suspend mode or to wake device from sleep mode.
19	Built-in microphone	Allows you to make or receive calls, or record sounds.
20	Mini-USB connector	Use this connector to synchronize your data, charge the battery, or insert the headset.
21	Carrying strap hole	Allows you to attach a strap to the device.
22	Reset key hole	Insert your stylus into this hole to reset your device.

# Getting your device ready

## Installing the SIM card and battery

Before you can make a phone call using your device, you need to install a Subscriber Identity Module (SIM) card. The SIM card contains your phone number, subscriber details, phonebook, and additional phone memory.

Your device comes with a rechargeable Lithium-Ion (Li-Ion) battery.

New batteries come partially discharged and should be fully charged for about four hours before using them.

---

**CAUTION:** Use only an ASUS qualified battery (SBP-19).

---

### To install a SIM card and battery:

1. Remove the battery compartment cover.

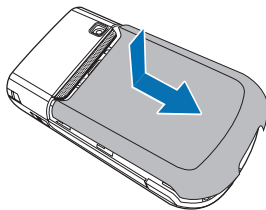

2. Insert the SIM card with its gold contacts facing down and the notched corner oriented to the upper left corner of the slot as shown.

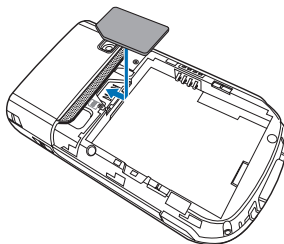

3. Install the battery into the compartment with its copper contacts properly aligned to the copper conductor on the device.

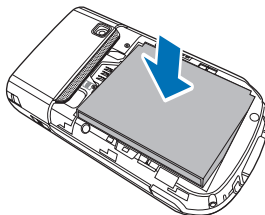

4. Replace the battery compartment cover.

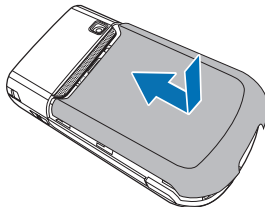

---

**NOTE:** To avoid losing your customized settings, replace the battery within five minutes of removing it from your device.

---

## Charging the battery

The bundled battery is shipped partially charged. Charge the battery up to four hours before using for the first time.

### To charge battery:

1. Connect the AC adapter plug into the mini-USB connector at the bottom of the device.
2. Connect the AC power plug into a grounded wall socket or power strip.

---

#### NOTES:

- The notification LED turns red and the charging battery icon appears on the status bar indicating that the battery is charging.
  - If your battery gets totally discharged, you need to recharge it for at least twenty minutes before you can turn it back on.
-



## Installing and removing a microSD card

Your device is equipped with a microSD card slot. A microSD card provides you with extended memory where you can store your files and other data.

### To install a microSD card:

1. Locate the microSD card slot beneath the SIM card slot inside the device.
2. With the golden fingers facing down, gently insert the microSD card into the slot until it snaps properly.
3. To remove, push the card until it ejects out, then remove the card safely.

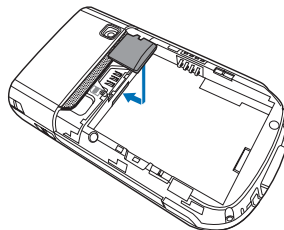

---

**NOTE:** The microSD card is an optional accessory.

---

# Starting up

## Powering your device

Ensure that your device is fully-charged before using the device for the first time.

### To turn on power:

1. Press and hold the Power button on top of the device.

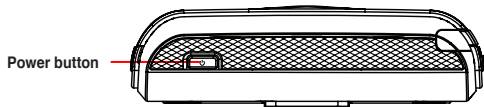

2. Follow the onscreen instructions to align the screen and set the local time zone.

## Using the stylus

The stylus is a pen-like device found behind the upper right corner of your device.

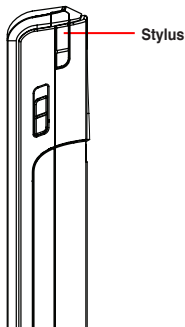

- Use the stylus to write, draw, select, or drag an item on the screen.
- Single-tap an item to select or open it.
- Tap and hold an item to see a menu.

## Calibrating your device

Calibrating your device ensures that the item you tap on the screen is activated. This involves tapping the center of targets that appear in various locations on the screen.

### To calibrate your screen:

1. Tap  > **Settings** > **System** tab, then tap **Screen** icon.
2. On the **General** tab, tap **Align Screen**, then follow the calibration screen instructions.

## Locking your device

You can lock the keys, buttons, and touch screen of your device to avoid inadvertently dialing numbers or launching any application.

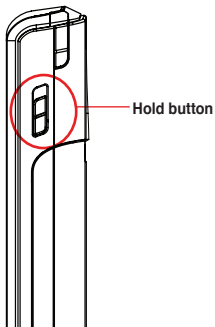

- Locate the Hold button and slide downward to lock.
- Slide upward to unlock.

## The Home screen

The Home screen on your device displays two parts: the ASUS Today and the Today screens.

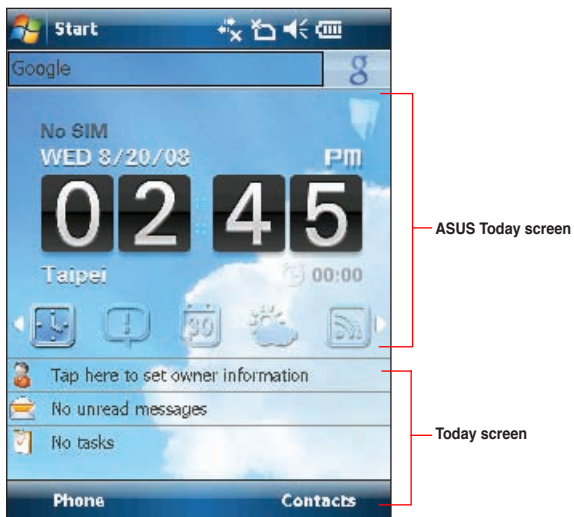

## ASUS Today

ASUS Today on your device's home screen enables you to view or change your time/date settings, notifies you of your missed calls and SMS/MMS/e-mail messages, displays your day's appointments, updates you on the current weather and latest news, and enables you to add and play media files on your device.





---

**NOTE:** You can disable the ASUS Today from your Home screen following the instructions below.











---

### To disable the ASUS Today

1. Tap  > **Settings** > **Today** > **Items** tab.
2. Deselect the check box of **Asus Today**, then tap .

## Icons

Refer to the table below for the ASUS Today icons.





Icon	Description	
<b>Alert icon</b> 		Alerts you on your missed calls, and new SMS/MMS/ e-mail messages.
		Alerts you on your missed calls.
		Alerts you on your new SMS messages.
		Alerts you on your new MMS messages.
		Alerts you on your new e-mail messages.
<b>Calendar icon</b>		Displays your appointment for the day.
<b>Date/time icon</b>		Displays your date/time settings.
<b>Media icon</b>		Enables you to add and play media files.
<b>News icon</b>		Displays the latest news.
<b>Weather icon</b>		Displays the current weather.

## Viewing alerts

ASUS Today notifies you of your missed calls, and new SMS/MMS/e-mail messages.

### To view alerts

Tap , then tap any of the icons for the information that you want to view.

- Tap  to view your missed calls.
- Tap  to view/read your new SMS messages.
- Tap  to view/read your new MMS messages.
- Tap  to view/read your new e-mail messages.

---

**NOTE:** To read your e-mail messages, ensure that you are connected to the Internet via Wi-Fi or GPRS connection. Refer to the Wi-Fi or GPRS sections in this user guide for more details.

---

## Viewing your day's appointment

### To view your day's appointment

Tap  to view your day's appointment in the display screen. If you want to change the information, just click the display screen, then make the necessary changes on the Calendar screen.

---

**NOTE:** You may also enter your calendar of activities or appointments from the ASUS Today screen. Tap , then tap the display screen, and enter the information for your appointments. You will be notified of your appointment on the day itself.

---

## Obtaining the current weather data

ASUS Today enables you to obtain and view the latest weather data of any place around the world.



---

### NOTES:



- Ensure that you are connected to the Internet via Wi-Fi or GPRS connection. Refer to the Wi-Fi or GPRS sections in this user guide for more details.
  - Before using this feature, ensure that you have configured the weather and network settings. For more details on configuring the network settings, refer to the section **Setting the network** in Chapter 8 of the user guide bundled in your Getting Started CD.
-



### To configure the weather settings

1. Tap  > **Settings** > **ASUS Today**.
2. Select **Enable Weather Update**.
3. Select the **Country** and **City** that you want to obtain the latest weather data for.
4. Tap  when done.

### To configure the network settings

1. Tap  > **Settings** > **Connections** > **Network Setting**.
2. Select the **Country** and **Operator** from the dropdown lists. If your mobile service operator is not on the list, tap the **Auto Detect** button.
3. When done, tap .

### To obtain the current weather data

From the ASUS Today screen, tap , then tap the display screen to retrieve the latest weather updates from the server.

## Downloading the latest news updates

### To download the latest news updates

---

**NOTE:** Before downloading news updates, ensure that you are connected to the Internet via Wi-Fi or GPRS connection. Refer to the Wi-Fi or GPRS sections in this user guide for more details.

---

1. Tap , then tap the display screen. The Newstation screen is displayed.
2. From the Categories list, select the channel that you want to obtain the latest news updates from.

---

**NOTE:** Ensure that you are connected to the Internet to get the latest news updates.

---

3. Tap **Menu > Update**. Your news downloads are stored as RSS news feeds on your device and displayed on the ASUS Today screen.

---

**NOTE:** You may read these stored RSS news feeds from the ASUS Today screen even without Internet connection.

---

## Playing media files

ASUS Today gives you quick access to the EziMusic, enabling you to play digital audio and video files stored on your device or in a storage card. You can listen to media files through the speaker of your device or through a headset.

---

**NOTE:** Your device may run low on memory and slow down if you store files on your device. We recommend that you store audio and video files in a storage card.

---

### To play media files

Tap , then tap the display screen. The EziMusic is launched. Refer to the section of **EziMusic** in this user guide for more details on how to play media files.

## The Today screen





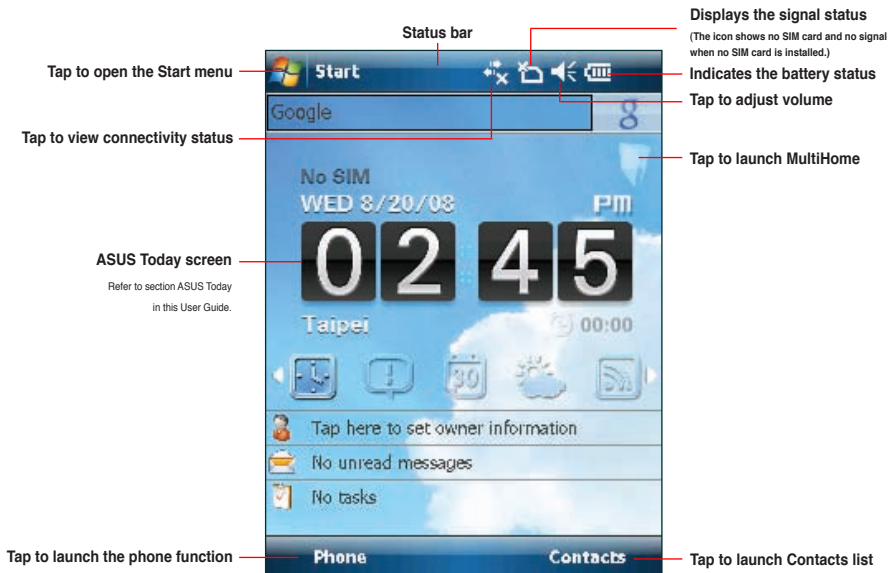









The Today screen displays information useful to you. You can configure the Today screen to have all the important information that you need.

**NOTE:** To know more about customizing the Today screen, refer to the section **Customizing the Today screen** in Chapter 7 of this user guide.































## Status indicators

Refer to the table below for the status indicators.

Icon	Description	
<b>Call status</b> 		Call in progress
		Call forwarded
		Call on hold
		Missed call
<b>General Packet Radio Service (GPRS) connection status*</b> 		GPRS available
		Connecting via GPRS
		Connected via GPRS
		3rd Generation (3G) service available
<b>Messaging status</b> 		New Short Messaging Service (SMS) message
		New voice mail
		New Multimedia Messaging Service (MMS) message

\* This icon depends on your location and mobile service provider.

Icon	Description	
		Battery fully charged
		Battery partially charged
		Battery charging
		Battery low
		No cellular phone service
		No signal
		Searching for cellular phone service
		Indicates signal strength
		Phone off.
		ActiveSync synchronization in progress
		Connecting with ActiveSync
		ActiveSync connection not active
		Synchronization error

Icon	Description	
<b>Sound status</b> 		Sound ON
		Sound OFF
<b>Wi-Fi status</b> 		Wi-Fi is not connected
		Wi-Fi connected
<b>Bluetooth headset connection</b>		Bluetooth stereo headset connected
<b>Roaming service</b>		Roaming service. This icon appears if you have international roaming feature.
<b>Mode status</b>		Vibrate or Meeting mode on
<b>Speakerphone status</b>		Speakerphone on
<b>Alarm status</b>		Appears when you set the alarm
<b>SIM card status</b>		No SIM card installed
<b>Notification status</b>		Notice indicator

## Screen orientation

You can set the screen to three different orientations:

1. Portrait
2. Landscape (right-handed)
3. Landscape (left-handed)

Set to Portrait mode to get a better view or better operation of certain applications on your device. Set to Landscape when viewing pictures, video or viewing longer text files.

To change the screen orientation, tap  > **Settings** > **System** tab > **Screen**, then select the orientation you want.

## Start menu

The Start menu contains various programs and applications that you commonly use. Tap  to display the Start menu items.

You can also customize the items that appear in the Start menu.

### To customize the Start menu:

1. Tap  > **Settings** > **Personal** tab > **Menus**.
2. Select the check boxes of the items you want to appear in the Start menu. You can select up to seven items.



## Using MultiHome

MultiHome provides three themes for the ASUS Today screen: **Original**, **Business**, and **Life**. You can change the theme according to your preference.

**To change the theme:**

1. Tap  from the ASUS Today screen to launch MultiHome.
2. To navigate through the **Original**, **Business**, and **Life** themes, push the navigation key leftward or rightward, or draw a horizontal line on the screen with the stylus.
3. Tap the screen to apply the theme.



Tap the screen to apply the theme to the ASUS Today screen.



Life theme

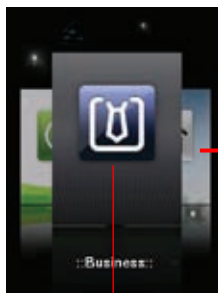

Tap the screen to apply the theme to the ASUS Today screen.

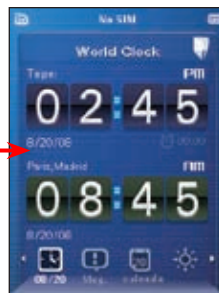

Business theme

# AnyTime Launcher

AnyTime Launcher is an alternative program that allows you to conveniently and quickly launch applications, perform tasks, and change device settings.





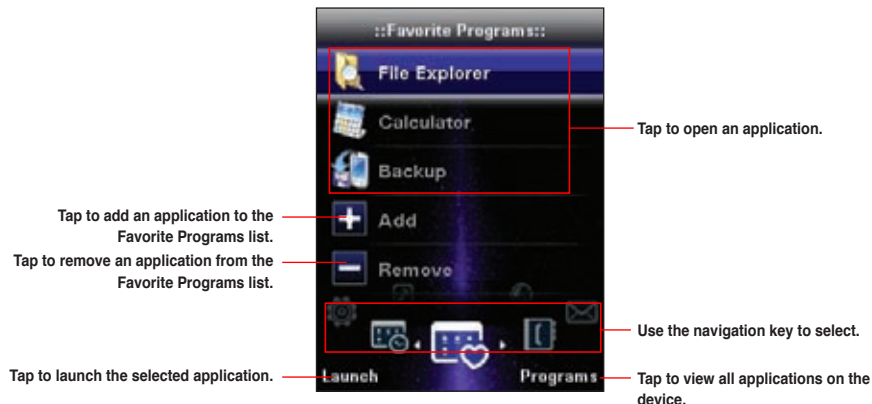

## To run the AnyTime Launcher:

- Press the AnyTime Launcher key .



## Icons

Use the navigation key to scroll through the following icons to open the list of applications or contacts under them.

Icon	Description
	<b>Favorite Programs:</b> Allows you to add your favorite programs.
	<b>Recent Programs:</b> Displays the recent opened programs.
	<b>Favorite Contacts:</b> Allows you to add your favorite contacts.
	<b>Message Center:</b> Allows you to access Messaging function and view missed calls.
	<b>Internet:</b> Allows you to use Internet related applications. .
	<b>Multimedia:</b> Allows you to use multimedia applications.
	<b>My Settings:</b> Allows you to configure your device settings.

## Searching for information

The Search tool enables you to search for files and other items stored in your device or in the external MicroSD card. You can search by file name or by words located in various applications including the Calendar, Contacts, Excel Mobile, Word Mobile, Help, Messages, Notes, and Tasks. You can also filter your search to files larger than 64 KB.

### To search for a file or an item:

1. Tap  > **Programs** > **Search**.
2. In **Search for** field, enter the file name, word, or other information you want to search.
3. In **Type** field, select the data type to help you filter your search.
4. Tap **Search**. Found items are listed in Results.
5. In the Results list, tap the item with the information you need.

## Getting Help

You can easily find Help for using any program on the device.

### To get help for a program:

From the Today screen or program, tap  > **Help**. Then a page opens with links to topics that explain how to use the program.

# Chapter 2

## Entering data

- Using the Input Panel
- Writing and drawing on the screen
- Recording voice



## Using the Input Panel

When you start an application or select a field that requires text, symbols, or numbers, the Input Panel icon appears on the menu bar. The Input Panel allows you to select various input methods including: **Block Recognizer**, **Keyboard**, **Letter Recognizer**, and **Transcriber**.

## Using the Block Recognizer

The Block Recognizer allows you to use a single stroke to write letters, numbers, symbols, or punctuations, which are converted into typed text.

### To use the Block Recognizer:

1. In an application that accepts user input, tap the Input Panel arrow, then tap **Block Recognizer**.
2. Write letters, numbers, symbols, or punctuations in the designated writing area.
  - Write letters on the **abc** (left) area of the box.
    - Write numbers on the **123** (right) area of the box.
    - Tap the space  button to input a space.
    - Tap the special symbols  button to input symbols, punctuations and other special characters.
    - Tap Help  button for help on how to write characters.

## Using the onscreen keyboard

With the onscreen keyboard, you can enter texts, symbols, numbers, or other special characters.

### To input text using the onscreen keyboard:

1. In an application that accepts user input, tap the Input Panel arrow, then tap **Keyboard**.
2. Tap the keys on the onscreen keyboard to enter.



### To enlarge the onscreen keyboard:

1. Tap the Input Panel arrow, then tap **Options...**
2. Select **Keyboard** from the Input Method list.
3. Tap **Large Keys**.

## Using the Letter Recognizer

With the Letter Recognizer you can write individual letters, numbers, or special characters, which are converted into typed text.

### To use the Letter Recognizer:

1. In an application that accepts user input, tap the Input Panel arrow, then tap **Letter Recognizer**.
2. Write letters, numbers, symbols, or punctuations in the designated writing area.
  - Write capital letters on the **ABC** (left) area of the box.
  - Write lower case letters on the **abc** (middle) area of the box.
  - Write numbers on the **123** (right) area of the box.
  - Tap the space  button to input a space.
  - Tap the special symbols  button to input symbols, punctuations and other special characters.
  - Tap Help  button for help on how to write characters.

## Using the Transcriber

Transcriber is a handwriting recognition program that allows you to write in cursive, print, or mixed styles. It recognizes not only written text but also numbers and symbols. Make sure to write legibly. See Help for more information on the Transcriber.

### To use the Transcriber:

1. Start an application that accepts user input, such as Notes or Word Mobile.



2. Tap the Input Panel arrow, then tap **Transcriber**.
3. The Transcriber Intro screen appears. Tap  to close the introduction, or tap **Help** to find more instructions.

#### To write using Transcriber:

1. Tap screen to position the cursor where you want the text to appear.
2. Use the stylus to write on the screen. The handwriting will be converted to text after you lift the stylus from the screen.

#### To edit text:

1. Tap the text you want to edit to position the cursor.
2. You can now rewrite the text or use the Transcriber gestures to edit your selected text. See Help  for more details about the Transcriber gestures.

## Writing and drawing on the screen

You can write or draw directly on the screen and save notes in your own handwriting. If you prefer to use your own handwriting or use drawings in your notes, set the default input mode to **Writing**. If you prefer text, set the default mode to **Typing**.

#### To set the default input mode for Notes:

1. Tap  > **Programs > Notes**.

2. From the Notes list, tap **Menu > Options**.
3. In the **Default mode:** box, tap the down arrow and select any of the following:
  - **Writing** - if you want to draw or enter handwritten text in a note.
  - **Typing** - if you want to create a typed note.
4. Set the other options according to your preference.
5. Tap  when finished.

#### To write/draw in a note:

1. Tap  > **Programs > Notes**.
2. From the Notes list, tap **New**.

If you set the **Default mode** to **Typing**, a blank page appears for typed text.

If you set the **Default mode** to **Writing**, a page with horizontal lines appears for handwritten text.







You can also tap **Menu** and then select/deselect **Draw** option to switch between typing and writing mode.

3. Write/Draw on the screen.
4. When finished, tap  to save the note and return to the Notes list.







## Recording voice

At any time, whether your phone is on stand-by or active mode, you can record sound, voice, or add a recording to a note while using your device.

### To create a voice recording:

1. Tap  > **Programs** > **Notes**.
2. From the Notes list, tap **New**.
3. If you do not see the recording toolbar, tap **Menu** > **View Recording Toolbar**.
4. Tap  to begin recording.
5. Place the receiver near your mouth or source of sound.
6. Tap  when finished recording. A voice record  icon appears on the note. You can tap  to play the voice record.
7. Tap .

### To add a recording to a saved note:

1. Tap  > **Programs** > **Notes**.
2. From the Notes list, tap a saved note to open it.
3. If you do not see the recording toolbar, tap **Menu** > **View Recording Toolbar**.
4. Tap the record  button to begin recording.
5. Place the receiver near your mouth or source of sound.
6. Tap the stop  button when recording is finished. A voice record  icon appears on the note. You can tap  to play the voice record.
7. Tap .

# Chapter 3

## Device Synchronization

- Synchronizing your device
- Microsoft® ActiveSync

## Synchronizing your device

Your device enables you to synchronize data in your device with the data on your computer. You can synchronize contents and transfer data between your device and your computer using Microsoft® ActiveSync on Windows XP™ platform, or Microsoft® Windows Mobile Device Center on Windows Vista™ platform.

---

**NOTE:** For synchronizing on Windows Vista™ platform, refer to the Microsoft® Windows Mobile Device Center's website at <http://www.microsoft.com/windowsmobile/devicecenter.mspx>

---

## Microsoft® ActiveSync

ActiveSync allows you to synchronize data in your device with data in your computer. ActiveSync can also synchronize over a wireless or mobile network with Microsoft Exchange Server, provided that your mobile phone service or company is running Microsoft Exchange Server with Exchange ActiveSync. When synchronized directly with Exchange Server, you can stay up to date even when your computer is turned off.

During synchronization, ActiveSync compares the data in your device with the data in your computer or Exchange Server, and updates all data with recent changes.

You can select and synchronize data in the following locations using ActiveSync:

- Contacts
- Calendar
- Email
- Tasks

- Notes
- Favorites
- Files
- Media

You can also exchange data between your computer and device without synchronizing.

ActiveSync is already installed in your device, but before you can synchronize data with your computer, you must first install ActiveSync in your computer. You can download the latest ActiveSync program from [www.microsoft.com](http://www.microsoft.com).

After you have installed ActiveSync, set up a sync relationship between your device and your computer. ActiveSync recognizes your device and automatically transfers the synchronization settings you have in your device.

If you wish to synchronize your device with Exchange Server through your company or service provider, obtain the name of the Exchange Server, user name, password, and domain name from your network administrator before starting the Sync Setup Wizard.

### **To install and configure ActiveSync in your computer:**

---

**NOTE:** Ensure that you install Microsoft ActiveSync 4.5 or later versions.

---

1. Insert the Getting Started CD that came with your device package.
2. Follow the onscreen instructions.
3. After the setup is complete, the Sync Setup Wizard automatically starts when you connect your device to your computer. Follow screen instructions to complete the wizard.

4. From the Sync Setup Wizard, you can:
  - Configure an Exchange Server connection to synchronize directly with an Exchange Server. Acquire from your network administrator the required parameters for input.
  - Create a synchronization relationship between your computer and your device.
5. Select the information type that you want to synchronize.
6. After you finish the wizard, ActiveSync/Microsoft® Windows Mobile Device Center automatically synchronizes your device. You can disconnect the device after the synchronization is complete.

---

**NOTES:**

- When connected, your device is automatically synchronized with your computer. ActiveSync synchronizes everytime you make a change on either the device or computer.
  - You cannot use WLAN to synchronize database.
  - Refer to your Windows® Mobile Help, for more information about ActiveSync synchronization.
  - Wireless connection may require separately purchased equipment (eg. Wireless router or Access Point).
- 

## Synchronizing via mini-USB

You can connect to your device using the bundled mini-USB cable to synchronize to your computer.

### **To synchronize your device via mini-USB:**

1. After installing ActiveSync to your computer, connect the mini-USB plug to the mini-USB connector at the right side of the device.
2. Connect the other end of the USB cable to your computer. Upon connection, ActiveSync automatically synchronizes your device.

## Synchronizing via Bluetooth®

---

**NOTE:** Ensure that Bluetooth is turned on both on your device and your computer.

---

### To synchronize your device via Bluetooth:

1. Configure the settings of ActiveSync and Bluetooth on your computer.

---

**NOTE:** Refer to the Microsoft® ActiveSync Help on your computer for details.



---

2. Connect your device with your computer using Bluetooth.

---

**NOTE:** Refer to the section **Using Bluetooth®** in this user guide for more details.

---

3. From the list of connected devices, tap the name of the computer you want to synchronize with.
4. Select **ActiveSync**, then tap **Save**.
5. Tap  to exit the Bluetooth settings.
6. From your device, tap  > **Programs** > **ActiveSync** > **Menu** > **Connect via Bluetooth**. The devices starts to connect to your computer.
7. When connected, tap **Sync** to synchronize data.

---

**NOTE:** Media files, such as music and video files, can be synchronized only via a USB cable.

---



## Synchronizing with an Exchange Server

### To synchronize your device with Exchange Server:

1. From the ActiveSync screen, tap **Menu > Add Server Source...**
2. Key in your e-mail address, then tap **Next**. If you prefer the device to detect the Exchange Server Settings automatically, select the check box.
3. In the **Server Address** field, key in the name of the server running Exchange Server then tap **Next**. If necessary, tap the check box **This server requires an encrypted (SSL) connection**.
4. Enter user name, password, and domain then tap **Next**.
5. Tap the check boxes to select the data items that you want to synchronize with Exchange Server. To change the available synchronization settings, select a data item then tap **Settings**. Tap **Finish** when done.
6. Start the sync process.

## Setting the synchronization schedule

### To set the synchronization with Exchange Server:

1. From the ActiveSync screen, tap **Menu > Schedule**.
2. Set the schedule according to your preference. Refer to the table for input details.

Volume	Recommended setup
High	Select a shorter interval in the Peak times list.
Low	Select <b>As items arrive</b> option or a longer interval in the Off-peak times list.
While roaming	Check <b>Use above settings when roaming</b> .
Sending messages	Check <b>Send/receive when I click Send</b> .

# Chapter 4

## Phone features



- Using the phone
- Making a call
- Receiving a call
- Options during a call
- ASUS CallFilter

## Using the phone

Like a standard cellular phone, you can use your device to make and receive voice and video calls. You can also keep a history of calls made, missed, and received, send SMS or MMS messages, take notes while talking, call from Contacts, and copy data from an installed SIM card to your device.

### Phone pad

The phone pad allows you to easily dial and access the Contacts, Call History, and Phone settings. To launch the phone pad, do any of the following:

- Tap  > **Programs** > **Phone**.
- Press .

### Turning off the phone function

You may use other functions even when your device's phone function is turned off.

**To turn off the phone function:**

1. Tap the signal icon  or tap  > **Settings** > **Connections** tab > **Wireless Manager**.
2. Tap the **Phone** icon.

## Adjusting the volume

To adjust the phone or device volume:

1. Tap  from the status bar.
2. From the volume menu, you can:
  - Move the slider to adjust device or phone volume.
  - Tap **On**, **Vibrate**, or **Off** to change the mode and ringer volume settings.

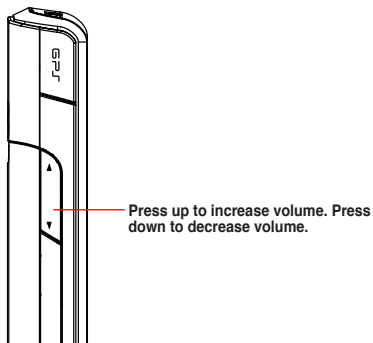

---

**NOTE:** You can also press the volume button at the left side of the device to adjust the volume.

---





## Making a call

You can make a phone call using the phone pad. You can also make calls directly from the Contacts, Call History, Speed Dial, or Voice Commander.

### Making a voice call

#### Calling using the phone pad

**To make calls using the phone pad:**

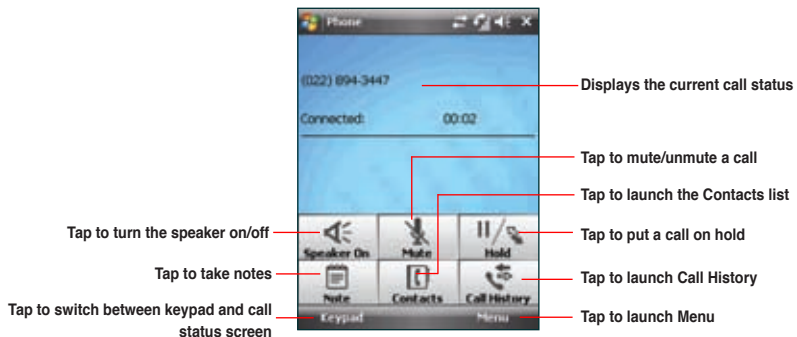
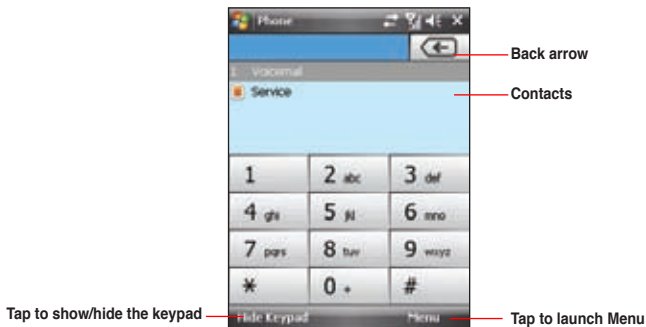

1. Tap  > **Programs** > **Phone** or press  to launch the phone pad.
2. Tap the number or choose a contact or a recently dialed number from the list above the phone pad.  
If you tapped the wrong number, tap  to erase number to the left.
3. Press  to make the call.
4. When finished, press  to end the call.

## Phone pad features



## Calling from Contacts



### To make a call from Contacts:

1. Press the Right Soft key or from the Today screen, tap **Contacts**.
2. You can do any of the following to make a call:
  - Tap name of contact, then tap **Call**.
  - Tap name of contact, then press .
  - You can also tap and hold the contact, and from the shortcut menu tap **Call Work**, **Call Home**, or **Call Mobile**.
  - Tap **Enter a name...** then enter the name or number you want to call from Contacts. Press  to dial the highlighted item.

## Calling from Call History





Your device enables you to check your call logs such as your missed, incoming, or outgoing calls.

### To make a call from the Call History list:

1. Launch **Call History**. To do this, do any of the following:
  - Tap  > **Programs** > **Phone**, then tap **Menu** > **Call History**.
  - After making a call, tap .



The Call History screen displays the following tabs:

-  (default): Displays all calls made, received, or missed.
- : Displays all missed calls.
- : Displays all the calls you made.
- : Displays all the calls you received.

2. Scroll to the desired contact or phone number, then tap **Call** or press .



Tap **Menu** to do other tasks such as saving a caller's contact information to your Contacts list, or send a text message to a caller.

3. Press  to end the call.

## Calling using Smart dialer

The Smart dialer feature in your device enables you to find a contact more quickly. Just key in the first letters of the contact you want to call. Your device smartly matches it with your Contacts list and displays the possible matches.

### To use Smart dialer:

1. On the phone pad, key in the first letters of the contact name.
2. From the list displayed, tap the contact you want to call.
3. Press .
4. To end the call, press .



## Calling using the Speed Dial

The Speed Dial function enables you to quickly and conveniently call frequently-called numbers. You may assign speed dial entries from 2-99.

### To create a Speed Dial entry:

1. Ensure that the entry you want to create is already in the Contacts list.
2. Tap **Contacts** from the Today screen.
3. Tap the contact number that you want to add to speed dial list. Then tap **Menu > Add to Speed Dial...**
4. Edit the name and number and select a numeric key for this contact.
5. Tap  when finished.

### To call a Speed Dial number:

1. Tap  > **Programs > Phone**. Tap and hold the numeric key assigned to the contact you want to call.
2. To end the call, press .

### To delete a Speed Dial entry:

1. Tap  > **Programs > Phone > Menu > Speed Dial**.
2. Tap the contact that you want to delete from the speed dial list, then tap **Menu > Delete**.
3. Tap **Yes** from the pop-up message.

## Using Voice Commander

### To make a phone call using Voice Commander:

1. Tap  > **Programs > Voice Commander.**
2. From the following screen, your device asks you to “Say command.”
3. Audibly say “Call” then the name to call from your Contact list.
4. Say “Yes” or “No” after the confirmation question.

If you said “Yes”, the application proceeds and dials the number. Otherwise, it returns to the Voice Commander menu.

5. Say “Goodbye” or tap  to exit Voice Commander.

---

#### NOTES:

- To use Voice Commander while using a headset, press the answer button\* on the headset then follow given instructions. (\* Answer button may not be available in some headset models.)
  - Some languages may not support the Voice Commander function.
- 

### To personalize the voice commander:

1. Tap  > **Settings > Personal tab > Voice Commander Settings.**
2. Set the Voice Commander according to your preference.

Refer to the Help center on your device for details.

To launch the Help center, tap  > **Help.**

3. Tap  when done.

## Making emergency calls



Calls to emergency service number can be made under any circumstances, even if you have locked the SIM card.

### To place an emergency call

Enter the emergency number appropriate for your location, and press  .

## Making international calls

### To place an international call:

1. Tap and hold  on the keypad to enter a (+) plus sign.
2. Enter the full phone number with the country code, area code, and phone number, and then press  .

## Making a video call



---

### IMPORTANT:

- Before using the video call function, apply for a 3G SIM card from your mobile service provider.
  - Ensure that you and the recipient of your call are both using mobile devices with video call function and a 3G SIM card.
-

## Using the phone pad

### To make a video call using the phone pad:

1. Tap  > **Programs** > **Phone** or press , then key in the number you want to call.
2. Tap **Menu** > **Video Call**, then the device begins to establish the connection.
3. When finished, press  to end the call.

## Calling from Contacts



### To make a video call from Contacts:

1. From the Today screen, tap **Contacts**.
2. Select a contact and tap **Menu** > **Video Call**.
3. When finished, press  to end the call.





## Calling from Call History

Your device enables you to check your call logs such as your missed, incoming, or outgoing calls.

### To make a call from the Call History list:

1. Launch **Call History**. To do this, do any of the following:
  - Tap  > **Programs** > **Phone**, then tap **Menu** > **Call History**.
  - After making a call, tap .

The Call History screen displays the following tabs:

-  (default): Displays all calls made, received, or missed.
-  : Displays all missed calls.
-  : Displays all the calls you made.
-  : Displays all the calls you received.

2. Scroll to the desired contact or phone number, then tap **Menu > Video Call**.
3. Press  to end the call.

## Video Call Setting

The Video Call Setting function enables you to set up the video call related features.

### General Settings

**To set the General settings:**

1. Tap  > **Settings > Personal tab > Video Call Setting > General tab**.
2. Select your preferred items.
  - Select the **Accept without camera** box if you do not want to show your video profile in video call.
  - Select the **Connect Vibration Alert** box if you want to enable the vibration alert when a video call is established.
  - Select the profile you want to show in a video call. The default is video profile. You can also set a picture as your profile.

## Service Settings



### To set the Service settings:

1. Tap  > **Settings** > **Personal** tab > **Video Call Setting** > **Service** tab.
2. Select the service item that you want to set. Then tap **Retrieving Settings...** button.

---

**NOTE:** The service options vary with different service providers.



---

3. Set the preferences that you want for your selected service option.
4. Tap  when finished.
  - Set the default audio path for video call.
3. Tap **Done** or  when finished.

## Receiving a call

When you receive a call, a message prompts and allows you to answer or reject the incoming call.

### To answer or reject an incoming call:

- To answer a call, tap **Answer**, or press .
- To reject an incoming call, tap **Ignore**, or press .

---

**TIP:** Press and hold  to switch receiver to speakerphone mode.



---

### To terminate a call:

- Press .

## Options during a call



Listed in the table below are the possible menu options for when a call is in progress. Some of these options are available only when multiple calls are in progress or during a conference call.

IN-CALL MENU OPTION	DESCRIPTION
Hold	Places the active call on hold. You can also press  during an active call to put it on hold.
Unhold	Activates the call that is on hold. You can also press  to activate the call that is on hold.
Mute	Switches off the microphone for the active call (you can hear the caller but the caller cannot hear you).
Unmute	Turns the microphone for the active call back on.
Speakerphone On/Off	Activates/deactivates the speakerphone.
Conference	Joins together all existing calls if you have subscribed to this service.
Paste	Pastes the phone number you copied from your messages, notes, or contacts to the phone pad instead of keying in the number manually.
View Contacts	Opens the Contacts list.
Save to Contacts	Saves the caller to the Contacts list.
Create Note	Allows you to create a note during an active call.
Call History	Opens the Call History list.
Speed Dial	Opens the Speed Dial list.
Options	Opens the Phone settings.





## Managing multiple calls

### To answer another call:

1. Tap  to place the first call on hold and answer the second call.
2. To end the second call and return to the first call, press .

### To hold a call to make a second call:

Tap  to place the first call on hold and call a second number. Press  to end the second call and go back to the first call.

### To switch between calls:

To switch between two calls, tap .

### To set up a multiple call:

With multiple calls in progress, tap **Menu > Conference**.

## ASUS CallFilter

The ASUS CallFilter is a utility that allows you to control all your incoming calls. Using this utility, you can manage a list of telephone numbers from your Contacts list, call log, message log, or any unlisted telephone number that you want to accept or reject.

### Launching the shortcut menu

The shortcut menu allows you to conveniently activate either the Accept or Reject list.



**To launch the shortcut menu:**

- Tap  > **Programs** > **Call Filter**.

## Managing the Accept list

The Accept list allows you to select telephone numbers you only want to accept. Incoming calls that are not included in the Accept list will automatically be rejected.

### To add items in the Accept list:

1. Tap  > **Programs** > **CallFilter**.
2. Select **Accept List** from the Edit List box.
3. Select source of data. You can get data from your Contacts, Call log, SMS/MMS number, or you can add anonymous number and key in new numbers.
4. From the list (e.g. Contacts), select an item then tap **Add** or  to add a new Accept list item.
5. Click  to exit.



To remove items from the Accept list, select a contact from the Accept list then tap **Remove** or



## Managing the Reject list

The Reject list allows you to select telephone numbers you want to reject. Incoming calls that are in the Reject list will be rejected.

### To add items in the Reject list:

1. Tap  > **Programs** > **CallFilter**.
2. Select **Reject List** from Edit List box.
3. Select source of data. You can get data from your Contacts, Call log, SMS/MMS number, or you can add anonymous number and key in new numbers.
4. From the list (e.g. Contacts), select an item then tap **Add** or  to add a new Reject list item.
5. Click  to exit.

To remove items from the Reject list, select a contact from the Reject list then tap **Remove** or



# Chapter 5

## Messaging

- E-mail messaging
- Threaded SMS
- MMS messaging
- Windows® Live

# E-mail messaging

## Setting up an e-mail account

Before you can send and receive e-mail messages, you need to set up an e-mail account that you have with an Internet service provider (ISP) or an account that you access using a VPN server connection (typically a work account). You can send e-mail messages by synchronizing or by connecting directly to an e-mail server through your Internet service provider or a corporate network.

---

**NOTE:** Before you set up an e-mail address on your device, you must have an Internet or an e-mail account.

---

### To set up an e-mail account:

1. Tap  > **Messaging** > **Setup E-mail**.
2. Key in your **E-mail address** and **Password**, then tap **Next**.

---

**NOTE:** By default, your device automatically attempts to obtain your e-mail settings from the Internet, particularly for Internet e-mail accounts such as Yahoo or Hotmail accounts.

---

3. If you want to manually enter your e-mail settings, clear the **Try to get e-mail settings automatically from the Internet** checkbox. Otherwise, tap **Next**.

---





**NOTE:** Obtain the e-mail server information from your mobile service provider.

---

4. Key in **Your name** and **Account display name**, then tap **Next**.

5. From the dropdown list, select the time interval that you want to automatically send/receive e-mail messages. If you want to view more download settings, tap **Review all download settings**, and select your preferred download settings.
6. When done, tap **Finish**.

## Managing e-mail accounts

TO	DO THIS
View a list of accounts	Tap  > <b>Messaging</b> . A list of accounts is displayed with the number of unread messages in the Inbox of each account shown in parenthesis.
Send/receive Internet e-mail messages	Tap  > <b>Messaging</b> . Select the Internet e-mail account for which you want to send and receive messages and tap <b>Menu &gt; Send/Receive</b> . To stop this process, tap <b>Menu &gt; Stop Send/Receive</b> .
Delete an account	Tap  > <b>Messaging</b> . Select an account and tap <b>Menu &gt; Delete</b> .
Switch between accounts	With an account open, tap <b>Menu &gt; Go To</b> , then tap an account you want to switch to. Or push the navigation key leftward or rightward to quickly switch to another account.
Changing account options	Tap  > <b>Messaging</b> . Select an account and tap <b>Menu &gt; Options</b> and then select the type of option you want to change. Tap <b>ok</b> when finished.

## Sending an e-mail message

### To send an e-mail message:

1. Tap  > **Messaging**.
2. Tap an e-mail account.
3. Tap **Menu** > **New** .
4. In **To:** field, enter e-mail address of the person to which you want to send the message or tap **Menu** > **Add Recipient** to select from your Contacts list.

---

**NOTE:** If you are sending a message to more than one recipient, separate them with a semicolon (;).

---

5. Key in your message in the message field.
6. When finished, tap **Send**.

---

**NOTE:** If you are working offline, e-mail messages are saved to the Outbox folder and sent the next time you connect.

---



TO	DO THIS
Insert a picture/voice note/file into an e-mail message	While composing your message, tap <b>Menu &gt; Insert &gt; Picture/Voice Note/File</b> .
Set the priority, security, permission, and language of an e-mail message	While composing your message, tap <b>Menu &gt; Message Options</b> .
Cancel a message	While composing your message, tap <b>Menu &gt; Cancel Message</b> .
Save a message	While composing your message, tap <b>Menu &gt; Save to Drafts</b> .
Delete a message	With the message you want to delete selected, tap <b>Delete</b> .
Move a message to another folder	With the message you want to move selected, tap <b>Menu &gt; Move</b> . Tap the new folder and tap <b>Select</b> .
Sort messages	On any account screen, tap <b>Menu &gt; Tools &gt; Sort By</b> and select your desired sort method.
Insert a signature	On any account screen, tap <b>Menu &gt; Tools &gt; Options &gt; Signatures</b> .
Change message options	On any account screen, tap <b>Menu &gt; Tools &gt; Options...</b>

## Downloading e-mail messages

To send and receive e-mail messages:

- Synchronize e-mail messages with Microsoft Exchange or Microsoft Outlook on your computer.
- Send and receive e-mail messages by connecting directly to an e-mail server through an Internet Service Provider (ISP) or a network.

## Synchronizing e-mail messages

You can include e-mail messages as part of the general synchronization process. On Windows® XP platform, you need to enable mail synchronization in Microsoft® ActiveSync. For more information on enabling mail synchronization, see the ActiveSync online help on your computer. On Windows® Vista platform, you can synchronize your e-mail messages via the Windows® Mobile Device Center.



---

### NOTES:

- For synchronizing on Windows Vista™ platform, refer to the Windows® Mobile Device Center's website at <http://www.microsoft.com/windowsmobile/devicecenter.mspx>
  - To connect directly to an e-mail server, see **Synchronizing with an Exchange Server** in this user guide.
-

## Managing folders

Each Messaging account has a set of five folders: **Deleted Items**, **Drafts**, **Inbox**, **Outbox**, and **Sent Items**. These folders store messages that you send and receive through the account. You can move a message to a different folder within the same account.

TO	DO THIS
View message folder contents	Tap  > <b>Messaging</b> . Select the account that you want to view. Tap <b>Menu &gt; Go To &gt; Folders</b> and select the folder that you want to view.
Moving a message to a different folder	Tap  > <b>Messaging</b> . Select the account with the message that you want to move. Select the message you want to move and tap <b>Menu &gt; Move....</b> Select the folder into which to move the message.

## Threaded SMS

Your device organizes your SMS messages from a single contact or number into a single thread of conversation, making it easier for you to follow the messaging flow and send the appropriate responses.

### Sending a threaded SMS

**To send a threaded SMS message:**

1. Tap  > **Messaging** > **Text Messages** > **Menu** > **New**
2. Key in your recipient's phone number or tap **To:** to select a recipient from the Contacts list. Separate multiple recipients with a semicolon (;).
3. Key in your message.
4. When finished, tap **Send** to send out the message.

---

**NOTE:** Once your recipient replies to your message, your device displays the message thread, making it easier for you to follow the mobile conversation with your recipient.

---

## MMS messaging

Multimedia Messaging System (MMS) allows you to send text messages with multiple slides. Each slide may include a picture, video or audio, or text. MMS messages are sent by GPRS (General Packet Radio Service) to e-mail accounts or other MMS-enabled mobile devices.

---

### NOTES:

- You need to subscribe to the GPRS and MMS services with your service provider before you can send and receive MMS messages. Ask your mobile service operator on how to activate the MMS feature. Only mobile phones with MMS feature can send/receive MMS messages.
  - Depending on the service that you subscribe to, you may not be able to send and receive MMS messages to users using a different mobile phone network.
- 

## Accessing MMS

To access MMS, do any of the following:

- Tap  > **Messaging** > **MMS**.
- After capturing a picture or video clip, press **Menu** > **Send via MMS**.

## Editing MMS settings

1. From the MMS main screen, tap **Menu** > **Tools** > **Options**.
2. From the list of accounts, tap **MMS**.

3. On the **MMSC Settings** tab, select your Internet Service Provider from the list. Tap **Edit** to access Multimedia Messaging Service Center (MMSC) settings.

---

**NOTE:** Contact your mobile service provider for detailed settings.

---

## Sending an MMS message

### To send an MMS message:

1. Tap  > **Messaging** > **MMS** > **Menu** > **New**.
2. In the **To:** field, key in the mobile phone number or e-mail address of your recipient. You can enter it using the phone pad or tapping **Menu** > **Add Recipient** to select from your Contacts. If you have more than one recipient, separate them with semicolon (;).
3. In the **Subject** field, key in a subject for the message.
4. Tap the **Insert Picture/Video** field. All of your pictures and video clips will be displayed in thumbnail view.
5. Tap a picture or video clip to insert it to the message.
6. Tap the **Insert Audio** field. All of your available audio clips will be displayed in thumbnail view.
7. Select the audio clip you want to attach, then tap **Select**.

---

**NOTE:** You will not be able to attach an audio file to a slide with a video clip.

---

8. Tap the **Insert Text** field and key in your message.
9. Tap **Send** to send the message.

The following assumes that you are on the MMS message screen.

TO	DO THIS
Copy the message to other recipients	Using the stylus, move the scroll bar to display the <b>Cc:</b> field. Key in the recipient's phone number or e-mail address or tap <b>Menu &gt; Add Recipient</b> to select a recipient from your Contacts list.
Hide a recipient's contact information from other message recipients	Using the stylus, move the scroll bar to display the <b>Bcc:</b> field. Key in the recipient's phone number or e-mail address or tap <b>Menu &gt; Add Recipient</b> to select a recipient from your Contacts list.
Hide sender information	Tap <b>Menu &gt; Options &gt; Send Options</b> . Select the <b>Hide Sender</b> check box.
Create an MMS message from a template	Press <b>Menu &gt; Template &gt; New from Template</b> to compose a message using a predefined template.
Create an MMS message template	Create a message or open an existing message, and tap <b>Menu &gt; Template &gt; Save as Templates</b> .
Add preset or frequently used text strings to a message	In a text field, tap <b>Menu &gt; My Text</b> . Select the text string that you want to add.
Edit a preset message	In a text field, tap <b>Menu &gt; My Text &gt; Edit My Text Messages</b> .
Request message read notification	Tap <b>Menu &gt; Options &gt; Send Options</b> . Select the <b>Read Report</b> check box.
Request message delivery notification	Tap <b>Menu &gt; Options &gt; Send Options</b> . Select the <b>Delivery Report</b> check box.

## Windows® Live

Windows® Live provides a set of services including e-mail, messaging, and search that brings all your online necessities together. With Windows® Live, you can conveniently do the following on your device:

- Access your Hotmail, Messenger, or Microsoft Exchange account and send or receive e-mail messages.
- Start a chat with your friends who are online.
- Search the web using the Windows® Live search engine.

To use Windows® Live, you must have a Passport account. If you have a Hotmail® or an MSN® account, you already have a Passport. Once you have obtained either a Microsoft® Passport or Microsoft® Exchange Server account, you are ready to set up your account.

---

**NOTE:** You need a Microsoft® Passport account to use Windows Live® application. If you do not have a passport account, go to [www.passport.com](http://www.passport.com) to obtain one.

---

## Using Hotmail®

Use the Windows® Live application to access your Hotmail® mailbox and access your e-mail messages on your device.

### To sign in Hotmail®:

1. Tap  > **Programs > Windows Live.**
2. On the Windows Live - Sign In screen, tap **Sign in to Windows Live** to enter Windows Live Setup session.
3. Tap **Accept**, then enter the e-mail address and password for your Hotmail® account.



4. Select **Save password** and tap **Next**.
5. Tap the check boxes to show or hide Windows® Live items on the Today screen, then tap **Next**.
6. Select the items you want to synchronize on your device, then tap **Next**. Wait for a few minutes for the synchronization process to finish.

The next time you sign in to Windows® Live, your username and password is displayed.

## Using Windows® Live Messenger

### To sign in and out of Windows® Live Messenger:

1. Set e-mail address and password in Windows® Live.
2. When the setting is finished, tap  > **Programs > Messenger**.
3. On the Windows® Live Messenger main screen, tap **Signing In**.
4. To sign out, press **Menu > Sign Out**.

---

**NOTE:** If you do not sign out of the Windows® Live Messenger application, you will remain connected. This may result in additional charges from your service provider.

---

## Common Windows® Live Messenger features

TO	DO THIS
Add a contact	Tap <b>Menu &gt; Add new contact</b> , and follow the instructions on the screen.
Delete a contact	Select the contact to delete and tap <b>Menu &gt; Contact options &gt; Remove Contact</b> .
Send an instant message	Select the recipient you want to chat with and tap <b>Send IM</b> . Key in your message and tap <b>Send</b> .
Add other people to a conversation	From a chat session, tap <b>Menu &gt; Options &gt; Add participant</b> , then select a contact and tap <b>Add</b> .
Switch to another chat session	In the list of ongoing chats displayed at the bottom of screen, Tap the name of a contact you want to chat.
Return to the contacts list	Tap  at the bottom of the screen.
End a chat session	From a chat session, tap <b>Menu &gt; End Conversation</b> .
See all who are chatting	From a chat session, tap <b>Menu &gt; Options &gt; View participants</b> .
Block someone on your Messenger contacts list from seeing and contacting you	In the Messenger contacts list, select the contact's name. Tap <b>Menu &gt; Contact options &gt; Block contact</b> . The contact will no longer be able to see your status or send you messages.

TO	DO THIS
Unblock a contact	In the Messenger contacts list, select the contact's name. Tap <b>Menu &gt; Contact options &gt; Unblock contact</b> .
Change your status	Above the Messenger contacts list, tap your name, then tap a status description to use. Or tap <b>Menu &gt; Change Status</b> , then tap a status description.
Send a voice clip	Tap <b>Voice clip</b> from a chat session to record then tap <b>Send</b> .

---

**NOTES:**

- If your Internet service provider (ISP) only allows one Access Point Name (APN) connection at a time, you may meet some problems when using Windows Live Messenger concurrently with other Internet related applications.
  - We recommend that you close Windows Live Messenger before activating any applications that require an Internet connection such as Internet Explorer, MMS, or Streaming Player.
-

# Chapter 6

## Organizing your life

- **Using Contacts**
- **Using Calendar**
- **Using Tasks**

## Using Contacts

Contacts contains your list of contact information such as mobile or work numbers and e-mail addresses. Using Bluetooth® on the device, you can quickly share Contacts information with other device users. If you use Outlook on your computer, you can synchronize Contacts between your device and computer.

### Viewing Contacts



To view the Contacts list, do any of the following:

- Tap  > **Contacts**.
- On the Today screen, tap **Contacts**.

The contact list displays the names of your contacts alphabetically. Beside each name in the contact list is an abbreviation for the default communication method, such as the person's work phone number (w), mobile phone number (m), or home phone number (h). Your device automatically sets a contact's mobile phone number as the contact's default number

If there are phone numbers stored in your SIM card, the entries display with a SIM card icon before the name.

TO	DO THIS
Create a new contact on the device	On the Today screen, tap <b>Contacts &gt; New &gt; Outlook Contact</b> . Enter information for the new contact and tap  .
Create a new contact on the SIM card	On the Today screen, tap <b>Contacts &gt; New &gt; SIM Contact</b> . <b>NOTE:</b> You can only store one phone number for a SIM contact.

TO	DO THIS
Edit a contact's information	On the Today screen, tap <b>Contacts</b> . Select the contact whose information you want to edit and tap <b>Menu &gt; Edit</b> . When finished making changes, tap  .
Call a contact from the contact list	On the Today screen, tap <b>Contacts</b> . Tap the contact you want to call and use the stylus to scroll to the number you want to call, and tap <b>Call</b> .
Send a text message to a contact	On the Today screen, tap <b>Contacts</b> . Tap the contact to which you want to send a text message and scroll to the number. Tap <b>Send text message</b> .
Send an MMS message to a contact	On the Today screen, tap <b>Contacts</b> . Tap the contact to which you want to send an MMS message and scroll to the number. Tap <b>Menu &gt; Send MMS</b> .
Beam a contact's information to another device	On the Today screen, tap <b>Contacts</b> . Tap the contact to beam and scroll to the number. Tap <b>Menu &gt; Send Contact &gt; Beam</b> . Tap the device name to send.
Find a contact by name	On the Today screen, tap <b>Contacts</b> . If you are not in Name view, tap <b>Menu &gt; View By &gt; Name</b> . Enter the first few letters of the contact's name until the contact is displayed.
Find a contact by company	On the Today screen, tap <b>Contacts</b> . Tap <b>Menu &gt; View By &gt; Company</b> . Tap the company to see all the contacts listed under it.
Find a contact using filter	From the Contact list, tap <b>Menu &gt; Filter</b> . Tap the category. To show all contacts again, tap <b>All Contacts</b> .
Assign a ringtone to a contact	On the Today screen, tap <b>Contacts</b> . Select the contact to which you want to assign a custom ringtone and tap <b>Menu &gt; Edit</b> and scroll to Ring tone. Tap <b>Ring tone</b> and select a ringtone, then tap  <b>NOTE:</b> You can only assign a ringtone to contacts stored in your Outlook Contact list.

TO	DO THIS
Add a picture to a contact	<p>On the Today screen, tap <b>Contacts</b>. Select the contact to which you want to add a picture and tap <b>Menu &gt; Edit</b>. Tap <b>Select a picture...</b> and tap an picture, or select <b>Camera</b> and take a picture to use.</p> <p><b>NOTE:</b> You can only add a picture to contacts stored in your Outlook Contact list.</p>
Send your approximate location	<p>From the Today screen, tap <b>Contacts</b>. Tap the contact that you want to send your location to, then tap <b>Menu &gt; Send My Location</b>.</p>
Locate a contact in the Google Maps	<p>From the Today screen, tap <b>Contacts</b>. Tap the contact whose location you want to locate, then tap <b>Menu &gt; Locate in Google Maps...</b></p>

---

**NOTE:** For more details on Google Maps, refer to the section **Google Maps Mobile** in Chapter 13.

---

## Using the SIM Manager

SIM Manager enables you to manage your contacts stored in the SIM card, as well as to copy contacts from your device to the SIM card and vice-versa.

To launch the SIM Manager, tap  > **Programs** > **SIM Manager**.



TO	DO THIS
Create a new contact on the SIM card	Tap <b>New</b> and then key in the contact name and phone number. Tap <b>Done</b> when finished.
Select/deselect all contacts on the SIM card	To select all contacts on the SIM card, tap <b>Menu</b> > <b>Select All</b> . To deselect all contacts, tap <b>Menu</b> > <b>Deselect All</b>
Copy a contact from the SIM card to the Contacts list on the device	Select the contact entry that you want to copy. Tap <b>Menu</b> > <b>Copy to Contacts</b> , then tap <b>Copy</b> .
Copy or retrieve a contact from the Contacts list to the SIM card	Tap <b>Menu</b> > <b>Retrieve from Contacts</b> . The contacts stored on your device is displayed. Select the contact entry that you want to copy or retrieve from your device to the SIM card, then tap <b>Retrieve</b> .
Delete a contact on the SIM card	Select the contact that you want to delete, then tap <b>Menu</b> > <b>Delete</b> . From the confirmation screen, tap <b>Delete</b> .
Call or edit a contact	Tap and hold the contact that you want to call or edit, then tap <b>Dial</b> or <b>Edit</b> .



## Using Calendar



Use Calendar to schedule appointments, including meetings and other events. You can also set Calendar to remind you of your appointments. If you use Outlook on your computer, you can synchronize appointments between your phone and computer.

To open the Calendar program, do one of the following:

- Tap  > **Calendar**.
- On the ASUS Today screen, tap .

## Scheduling an appointment

**To schedule an appointment:**

1. Tap  > **Calendar**.
2. Tap **Menu** > **New Appointment**.
3. Enter information about the appointment.  
To schedule an all-day event, in **All Day**, select **Yes**.
4. Tap .

TO	DO THIS
Make a recurring appointment	Tap the appointment and tap <b>Menu</b> > <b>Edit</b> . Tap <b>Occurs</b> and select one of the recurrence options.
Delete an appointment	Tap the appointment to delete and tap <b>Menu</b> > <b>Delete</b> .
Beam an appointment	Tap the appointment to delete and tap <b>Menu</b> > <b>Beam...</b>

## Viewing an appointment

To view an appointment:

1. Tap  > **Calendar**.
2. Tap the appointment to view.

## Viewing your schedule

To view your schedule

1. Tap  > **Calendar**.
2. Tap **Menu** and then select your desired view.
  - **Agenda**
  - **Day**
  - **Week**
  - **Month**
  - **Year**

TO	DO THIS
View today's appointment	From any Calendar view, tap <b>Menu</b> > <b>Go to Today</b> .
View your agenda for a specific date	From any Calendar view, tap <b>Menu</b> > <b>Go to Date</b> . Tap the date to view.
Show week numbers	From any Calendar view, tap <b>Menu</b> > <b>Tools</b> > <b>Options....</b> Select the <b>Show week numbers</b> check box.
Change the display of the work week	In any Calendar view, tap <b>Menu</b> > <b>Tools</b> > <b>Options...</b> and do the following: <ul style="list-style-type: none"><li>• To specify the first day of the week, in <b>1st day of week</b>, select <b>Sunday</b> or <b>Monday</b>.</li><li>• To specify the number of days you want to appear in a week, in <b>Week view</b>, select <b>5-day week</b>, <b>6-day week</b>, or <b>7-day week</b>.</li></ul>

# Using Tasks

Use Tasks to keep track of what you have to do.







## The Tasks list

The task list is your “things to do” list. When you create or edit tasks with Outlook on your computer and then synchronize it with your device, additional information, such as due date, priority, and category, may show. A task that has been marked as high priority is preceded by an exclamation mark, and a low priority task is marked by a downward-pointing arrow. Overdue tasks are displayed in bold red.

---

**NOTE:** You can synchronize information on your phone with your computer to keep your task list up to date in both locations.

---

TO	DO THIS
Create a task	Tap  > <b>Programs &gt; Tasks &gt; Menu &gt; New Task</b> . Enter the task name and details, then tap  .
Mark a task as completed	Tap  > <b>Programs &gt; Tasks</b> . Select the task to mark complete, then tap <b>Complete</b> .
Delete a task	Tap  > <b>Programs &gt; Tasks</b> . Select the task to delete, then tap <b>Menu &gt; Delete Task</b> . Press <b>Yes</b> to confirm.
Change a completed task to incomplete	Tap  > <b>Programs &gt; Tasks</b> . Select a completed task, then press <b>Activate</b> to change status to incomplete.
Find a task	Tap  > <b>Programs &gt; Tasks</b> . Tap <b>Menu &gt; Sort by</b> and select a sort option or <b>Menu &gt; Filter</b> and select a category.

# Chapter 7



## Customizing your device

- Customizing the Start menu
- Using the Profile Manager
- Customizing the Today screen
- Entering your contact information
- Setting up sounds and notifications
- Setting the date, time, and alarm
- Setting the ringtone
- Wake up settings

## Customizing the Start menu

You can choose up to seven programs to appear in the Start menu.

**To customize the Start menu:**

1. Tap  > **Settings** > **Menus**.
2. Select up to seven programs that you want to be on the Start menu.
3. Tap .



## Using the Profile Manager

Profile Manager provides you with a convenient way to customize the ringtone and notification settings of your device to suit different scenarios.



There are four profile modes that you can choose from:

- **Normal:** This mode allows you to customize the ringtone for incoming calls, messages, and alert notifications.
- **Meeting:** In this mode, the volume is turned off and your phone vibrates to alert you about an incoming call.
- **Silent:** This mode puts both the volume and ringing tone of your device on mute mode.
- **Automatic:** When set to this mode, your device's sound and alert settings are automatically switched from Normal to Meeting mode based on your Calendar.



### To change to Normal mode:

1. Tap  > **Settings** > **Profile Manager**.
2. Select **Normal**, then select one of these options from the dropdown list: **Default**, **Outdoor**, and **Personal**. If you want to change the settings of an option, tap **Edit**.
3. Tap **Tone**, **Volume**, or **Name** tabs and make the necessary changes.
4. When done, tap .

### To change to Meeting mode

1. Tap  > **Settings** > **Profile Manager**.
2. Select **Meeting**.
3. If you want to change the settings, tap **Edit**.
4. Tap the slider to adjust the speech volume setting.
5. When done, tap .

### To change to Silent mode

1. Tap  > **Settings** > **Profile Manager**.
2. Select **Silent**.
3. If you want to change the settings, tap **Edit**.
4. Tap the slider to adjust the speech volume setting.
5. When done, tap .

### To change to Automatic mode

1. Tap  > **Settings** > **Profile Manager**.
2. Select **Automatic**.

---



**NOTE:** If the system detects that you are currently busy based on your Calendar, the sound and alert settings in your device automatically switch from Normal to Meeting mode.

---



3. When done, tap .

## Customizing the Today screen



### To change the theme of your device:

1. Tap  > **Settings** > **Today**.
2. From **Appearance** tab, select a theme for your device.
3. Tap  when finished.

### To customize the items displayed on the Today screen:

1. Tap  > **Settings** > **Today**.
2. From **Items** tab, check the items you want to show on the Today screen.
4. Tap  when finished.

### To change the background image:

1. Tap  > **Settings** > **Today**.
2. From **Appearance** tab, select the box of **Use this picture as the background** and tap Browse. Then tap an image to use as the background image.
3. Tap  when finished.

## Entering your contact information



The Owner Information feature allows you to enter and display your personal contact information, such as your name, alternative contact numbers, and e-mail address, on your device.

---

**NOTE:** We recommend that you enter your contact information so you can easily be contacted in case of loss.

---

### To enter owner information:



1. Tap  > **Settings** > **Owner Information**.
2. Key in your details and tap .





## Setting up sounds and notifications

This function enables you to customize the sounds for ringtones, notifications, reminders, alert, warnings, e-mail, text message, and key tones. The phone comes with some polyphonic ringtones from which you can choose.

### To change the sound:

1. Tap  > **Settings** > **Personal** tab > **Sounds & Notifications**.
2. From the **Sounds** tab, check boxes before the items you want to enable sounds for.
3. When done, tap .

### To change the notifications:

1. Tap  > **Settings** > **Personal** tab > **Sounds & Notifications**.
2. From the **Notifications** tab, select an event from the dropdown list and change the settings.
3. When done, tap .

## Setting the date, time, and alarm

### To set the date and time:

1. Tap  > **Settings** > **System** tab > **Clock & Alarms**.
2. On the **Time** tab, enter the Time zone, Date, and Time settings.



3. Select the box of **Sync to current time zone** if you want to sync the time on your device with your mobile service provider.
- 

**NOTES:**

- If you deselect this option, the time on your device is synchronized when you sync the device with your PC.
  - If you select this option, the time on your device does not change when you sync the device with your PC.
  - Some service providers may not support this function.
- 

4. Tap .

**To set the alarm:**

1. Tap  > **Settings** > **System** tab > **Clock and Alarms**.
2. On the Alarm tab, enter the necessary alarm settings.
3. Tap .

---

**NOTE:** You can also configure the date/time settings directly from the ASUS Today screen. Just tap  and configure the necessary settings.





---

## Setting the ringtone

With your device you can add and configure your favorite music as your phone ringtone. You can easily configure your favorite song or sound as your ringtone with the following compatible audio formats: aac, amr, .mp3, .wav, .wma, and .mid.

## Adding ringtone to selection





To add ringtone to the selection category under phone setting:

1. Tap  > **Settings** > **Ring tones**.
2. Select a specific file extension from the list box.
3. Tap to check a ringtone file that you want to add.  
Tap  to play ringtone sound and tap  to stop.
4. Tap  when finished.



## Changing the ringtone

To change the ringtone:

1. Tap  > **Settings** > **Phone**.
2. On the **Phone** tab, select a ringtone from the **Ring tone** list box. The songs or sounds that you added as ringtone appears on this list along with the default ringtones that came with the device.  
Tap  to play ringtone sound and tap  to stop.
3. Tap  when finished.

---



**NOTE:** Refer to the device's preinstalled ringtones in the list box.

---

## Wake up settings

You can set the wake-up actions whenever your device is in sleep mode.

### To set the wake-up action:

1. Tap  > **Settings** > **Wakeup Source**.
2. Select from the available wake-up actions.  
Tap **Select All** to select all actions or tap **Select None** to deselect all available actions.
3. Tap  when finished.

# Chapter 8

## Getting connected

- Using the Wireless Manager
- Using Bluetooth®
- Using Wi-Fi
- Setting a GPRS connection
- Setting the network
- GSM/3G Networks

## Using the Wireless Manager

The Wireless Manager allows you to enable/disable the flight mode function; enable/disable Wi-Fi, Bluetooth and phone connections; use your device as an external modem; and disable/enable Direct Push.

### Enabling/disabling flight mode

Your device allows you to enable flight mode before taking an onboard flight. The flight mode feature enables you to turn off the wireless connections and transmitting function of your device but allows you to use its basic functions, such as listen to music and play games, while onboard. You cannot send SMS or make calls while flight mode is enabled.

#### To enable/disable flight mode:

1. Tap  > **Settings** > **Connections** tab > **Wireless Manager**.
2. Tap the **Flight Mode** icon. When enabled, the icon turns blue.

To disable the flight mode function, tap the **Flight Mode** icon. The icon turns gray when disabled.

### Enabling/disabling the wireless connections

You can turn on/off the wireless connections on your device such as Wi-Fi, Bluetooth, and GPRS connections from the Wireless Manager application.

To enable/disable the wireless connections:

1. Tap  > **Settings** > **Connections** tab > **Wireless Manager**.

2. Tap the **Wi-Fi** or **Bluetooth** icons to turn on any of these wireless connections. The selected icon turns blue when enabled.

To disable a wireless connection, tap the icon of the wireless connection that you want to turn off. The icon turns gray when disabled.

## Using your PDA phone as an external modem

With Internet Sharing, you can use your device to connect your PC to the Internet. To connect your device to your PC, you can use a USB Bluetooth dongle.

---

**NOTE:** Ensure that you have Internet connection via Wi-Fi or GPRS connection. Refer to the Wi-Fi or GPRS sections in this user guide for more details.

---

## Using a USB cable to connect your device to your PC

---

**NOTE:** Ensure that you have installed Microsoft® ActiveSync 4.5 or later on your PC.

---

### To use a USB cable to connect your device to your PC:

1. Ensure that the ActiveSync USB connection on your PC is disabled. To disable:
  - Open ActiveSync on your PC, and click **File > Connection Settings**.
  - Clear the **Allow USB connections** checkbox.

2. Tap  > **Settings** > **Connections** tab > **Wireless Manager** > **Internet Sharing**.
3. Select **USB** from the **PC Connection** dropdown list.
4. From the Network Connection list, select the network that your device will use to connect to the Internet.
5. Tap **Connect**. Allow a few seconds for your device to establish the Internet connection.

## Using Direct Push

Direct Push is a technology that allows you continuously retrieve e-mail messages even without synchronising your device with your PC.

### To use Direct Push:

1. Tap  > **Settings** > **Connections** tab > **Wireless Manager**.
2. Tap the **Direct Push** icon to enable the Direct Push function. When enabled, the icon turns blue.  
To disable Direct Push, tap the **Direct Push** icon. The icon turns gray when disabled.



## Using Bluetooth®

Bluetooth® is a short-range wireless communication technology that allows devices with Bluetooth capabilities to exchange data within a radius of 7-10 meters (21-30 feet) without requiring a physical connection. With Bluetooth enabled in your device, you can:

- Connect and communicate, such as beam files, tasks, or contacts, with other Bluetooth-enabled devices.
- Use Bluetooth service. After you connect to another device or computer using Bluetooth, you can use the services available on that device.

---



**NOTE:** The real distance will be variant by the environment and block.

---

## Activating Bluetooth in your device

Use the Wireless Manager to enable or disable Bluetooth in your device.

**To activate Bluetooth in your device:**

1. Launch the Wireless Manager. To do this, you can either:
  - Tap  > **Settings** > **Connections** tab > **Wireless Manager**.
  - Tap  > **Wireless Manager**.
2. Tap the Bluetooth icon to turn on/off the Bluetooth connection. The icon turns blue when enabled, and gray when disabled.

---

**TIP:** When not in use, deactivate Bluetooth in your device to conserve battery power.

---

## Adding Bluetooth devices

### To add Bluetooth devices:

1. Ensure that Bluetooth is enabled on the device you want to add and the device is set as visible.
2. Tap  > **Settings** > **Connections** tab > **Bluetooth**.
3. Tap **Add new device...** to search for available Bluetooth devices. The search may take a while.
4. Select the device you want to connect to, then tap **Next** or press the Right Soft key.
5. Enter the alphanumeric passcode of the device you want to connect then tap **Next** or press the Right Soft key. You can find the passcode in the documentation that came with the target device.
6. Enter the display name for this connection.
7. Repeat steps 3 - 6 to connect to more devices.

## Using Wi-Fi

### Turning on Wi-Fi



#### To turn on Wi-Fi:

1. Tap  > **Settings** > **Connections** tab > **Wi-Fi** > **Menu** > **Turn On Wi-Fi**.  
The Device then automatically scans for all available wireless networks within the Wi-Fi range.
2. From the list of detected wireless networks, select a wireless network that you want to connect the device to, then tap **OK**.
3. Select whether the wireless network connects to **The Internet** or **Work** network, then tap **Connect**.

4. Enter a password and tap **Connect**. If no password needed, just tap **Connect**. The device then connects to the selected network.

## Configuring wireless networks

### To configure a wireless network:

1. To launch the Wi-Fi settings page, you can either:
  - Tap  > **Settings** > **Connections** tab > **Wi-Fi**.
  - Tap  from the status bar and then tap **Settings** > **Wi-Fi**.
2. On the Configure Wireless Networks screen, tap an available wireless network, then make the necessary changes.

If the wireless network you want to connect to is not on the list, tap **Add New....**

Refer to the succeeding sections for details on how to add new wireless networks.

Tap the **Network Adapters** tab and select an adapter. Tap an adapter to set if necessary.



3. Tap  when done.

## Adding a wireless network

If the device fails to automatically detect the wireless network you want to connect to, you can manually add a network. Ask for the wireless network settings from your network administrator.

### To add a wireless network:

1. To launch the Wi-Fi settings page, you can either:

- Tap  > **Settings** > **Connections** tab > **Wi-Fi**.
- Tap  from the status bar, then tap **Settings** > **Wi-Fi**.

Then tap **Add New...** from the **Wireless** tab.

2. Enter a name for the network and select an item from the **Connects to:** drop-down menu. Then tap **Next**.
3. Set authentication, data encryption, and network key. Ask your network administrator for these information. Then tap **Next**.

---

**NOTE:** Obtain the authentication, data encryption, and network key from your network administrator.

---

4. If you need to change the EAP type, check the check box and then change the EAP type.
5. Tap **Finish** when done.

## Setting a GPRS connection

Your device allows you to connect via General Packet Radio Service (GPRS). GPRS is a wireless communication standard that runs at speeds of up to 144 kbps, compared to 9.6 kbps of the current Global System for Mobile Communication (GSM). It supports a wide range of bandwidth that allows sending and receiving small bursts of data, such as e-mail and web browsing. To set a GPRS connection in your device:

1. From the Today screen, tap **G** / **3G** on the status bar, then tap **Settings > Connections**. Or from the Settings screen, tap **Connections** tab > **Connections**.
2. From the Connections screen, tap **Add a new modem connection**.
3. Enter a unique name for the connection then select **Cellular Line (GPRS)** from the modem list.
4. Enter the Access point name. Consult your network service provider for the access point.
5. Enter your user name, password, and domain then tap **Finish**. Contact your network administrator for assistance.



---

### NOTES:

- The network connection may vary with different locations and mobile service providers. Consult your mobile service provider for the applicable network connection in your area.
  - The charge of GPRS services and the GPRS connection settings might vary with different operators. Consult your service provider for suitable solution.
  - The GPRS and USB connections cannot be used at the same time.
-

## Connecting GPRS

### To connect GPRS:

1. Tap  > **Settings** > **Connections** tab > **Connections**.
2. From the Connections screen, tap **Manage existing connections**.
3. Tap and hold on an existing connection then from the pop-up menu tap **Connect**.  
Tap **Delete** if you want to delete the selected connection.
4. When connected, tap  to exit.

---

**NOTE:** When WLAN is used simultaneously with the GPRS, the GPRS will get signal priority. We recommend not to use WLAN and GPRS at the same time.

---

If you have set a default GPRS connection, it automatically connects when you launch an application that connects to the Internet.

1. Launch any application that connects to the Internet such as Internet Explorer. The device will automatically connect to your default GPRS connection. A pop-up callout appears to display the connection status.
2. When connected, you can start browsing the Internet. If you are using Internet Explorer, the default site will be displayed.

## Disconnecting GPRS

### To disconnect GPRS:

1. Tap  > **Settings** > **Connections** tab > **Wireless Manager**.
2. Tap the GPRS icon. The icon turns gray when disabled.

---



#### NOTES:

- You can only disconnect but you cannot enable the GPRS connection in the Wireless Manager application.
  - If your ActiveSync is set to sync with Exchange Server automatically, synchronisation will occur after you connect again.
  - GPRS will automatically reconnect everytime you launch an application that requires GPRS connection (such as Internet Explorer or Windows Live Messenger).
- 

## Using the GPRS Tool

The GPRS Tool allows you to conveniently select and connect to your GPRS service provider.

### To connect via GPRS Tool:

1. Tap  > **Settings** > **Connections** tab > **Network Setting**.  
You can also tap  /  on the status bar then tap **Settings** from the popup callout.
2. From the Network Setting screen, select your GPRS provider from the list.

---

#### NOTES:



- Operators vary in different regions.
  - The GPRS and USB connections cannot be used at the same time.
-

## Setting the network

Your device enables you to configure your device's network connection as well as set multiple networks in the order that you want to access them.

## Configuring the network

**To configure the network settings:**

1. Tap  > **Settings** > **Connections** tab > **Network Setting**.
2. Select the **Country** and **Operator** from the dropdown lists. If your mobile service operator is not on the list, tap the **Auto Detect** button.
3. When done, tap .

## Setting your preferred networks

Your device enables you to set multiple networks in the order that you want your device to access them. If your primary network is not accessible, your device will automatically try to access an available network in your network list.

**To set preferred network:**



1. From the phone pad, tap **Menu** > **Options** > **Network** tab.
2. Tap **Set Networks** and follow the onscreen instructions.
3. When you have set your preferred networks, tap  to return to the **Network** tab. In the **Network selection** list, tap **Automatic**.



## GSM/3G Networks

GSM/3G Networks allows you to conveniently switch network type. Network options include Automatic, 3G, and GSM. The default setting is Automatic, which allows the device to search for the proper service automatically.

### To choose network type:

1. Tap  > **Settings** > **Connections** tab > **GSM/3G Networks**.
2. Select a proper network type, then tap .

If you prefer to use the service your SIM card automatically detected, select **Automatic**.

3. When prompted, tap  to restart your device and apply changes.

---

### NOTES:

- Network type varies with different service providers.
  - Ensure that you choose the right network type for your SIM card.
-

# Chapter 9

## GPS features



- GPS Catcher
- External GPS

## GPS Catcher

The GPS Catcher allows you to update the Global Positioning System (GPS) data in your device. The GPS data contains important information about the status of satellite, and the current date and time for determining the satellite position.

### Updating GPS data

**To update GPS data:**

1. Tap  > **Programs** > **GPS Catcher**.
2. Then tap **Update** to start update.
3. Tap  when finished.

---

#### NOTES:

- To make a successful update, ensure that your device is connected to the Internet.
  - The expiration of GPS data is three days. You need to update it again when it is expired.
  - You can also set GPS Catcher to update automatically, refer to the **Setting GPS Catcher** section for details.
- 

### Setting GPS Catcher

**To set GPS Catcher:**

1. From the GPS Catcher screen, tap **Menu** > **Setting**.
2. Set the options according to your preference. Tap **Done** when finished.

## External GPS

Your device allows you to use an external GPS device to receive GPS data.

---

### NOTES:

- Your Pocket PC support only Bluetooth-enabled external GPS devices.
  - Before using an external device, connect your external GPS device to your Pocket PC via Bluetooth. Refer to **Using Bluetooth®** section for details.
- 

### To set an external GPS device:

1. Tap  > **Settings** > **System** tab > **External GPS**.
2. From the **Programs** tab, select a program port.

---

**NOTE:** By default, the port is set to **GPD1**. We recommend that you DO NOT change the default setting.

---

3. From the **Hardware** tab, specify a hardware port and baud rate for your external GPS device to use.

---

**NOTE:** By default, the hardware port is set to **COM2**, and the baud rate is set to **57600**. Refer to the user guide of your external GPS device for details.

---

4. From the **Access** tab, select the **Manage GPS automatically (recommended)** box.

---

**IMPORTANT:** If you clear this check box, some GPS related application in your device may not be able to obtain GPS data.

---

# Chapter 10

## Multimedia features

- Using the camera
- Viewing pictures and videos
- Streaming Player
- EziMusic
- EziPhoto
- YouTube&Flickr

## Using the camera

The built-in camera allows you to take photos and record audio/video clips.

### Launching the camera

To start using the camera, do either of the following:

- Tap  > **Programs** > **Pictures & Videos** > **Camera** icon.
- Press the Camera button on the right side of your device.

To exit the Camera, tap the exit  icon on the camera screen.

### Supported formats

Using the camera mode or video mode, the images or video clip captured are stored in the following formats:

- **Still image (Camera mode):** - JPEG (.jpg)
- **Video (Video mode):** - 3GP (.3gp), MPEG-4 (.mp4)

## Camera mode

The following describes the screen icons in the Camera feature.

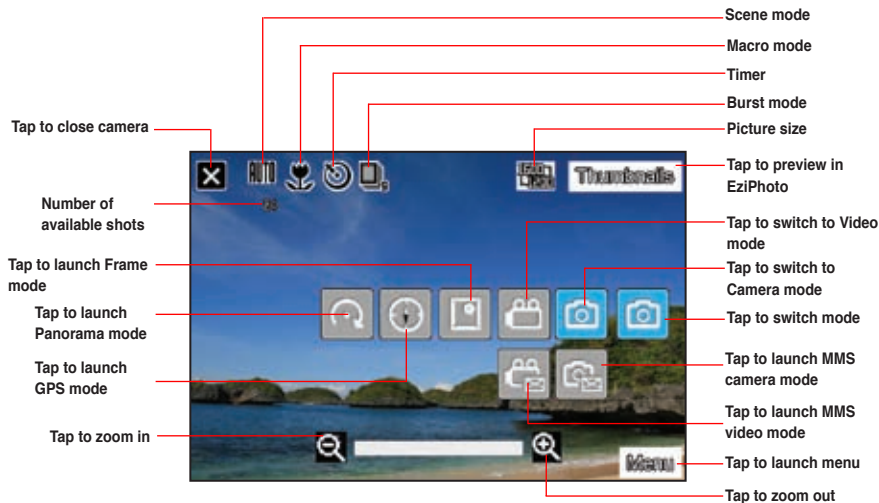

### NOTES:

- By default, the preview screen is set to landscape.
- After launching the camera, your device is set to camera mode by default.
- In camera mode, the camera button functions as shutter button.

## Camera options menu

The camera options menu allows you to change various camera and picture settings.

### To launch options menu:

1. Tap **Menu** from the camera screen.
2. From the shortcut menu, tap an icon to display contents.
  - **Scene**: Allows you to select presets appropriate for a night scene or sports event. Select **Auto** to use best setting for any scene.
  - **Macro**: Allows you to turn the macro mode on/off.
  - **Self-Timer**: Sets the delay of shutter release to 5 or 10 seconds after you have pressed the camera/shutter button.
  - **Burst**: Allows you to take 4 or 9 pictures in succession with one press of the camera/shutter button.
  - **Picture Size**: Allows you to set the frame size of the picture.
  - **Zoom**: Allows you to change the maximum magnification allowed.
  - **Advanced**: This option allows you to set the following settings: **Camera**, **Video**, **Color Adjustment**, and **General**.



## Taking photos

After launching the camera, your device is set to Camera mode by default. If set to Video mode, tap **Menu** > **Change Mode** > **Camera Mode** then tap **Exit**.

You can also switch between camera mode and video mode by tapping the camera/video mode icon on the screen.

### To take photos:

1. Full-press the camera button. When the  icon appears, ensure that the device is stable and not shaking.
2. Tap **Camera** and then repeat steps 1 to 2 to take more photos.

---

**NOTE:** The image is automatically saved to the default storage location and can be viewed using the Pictures & Videos application.

---

## Video mode

The following describes the screen icons in Video mode:



## Video options menu

The video options menu allows you to change various video and playback settings.

**To launch video options menu:**

1. Tap **Menu** from the video screen.
2. From the shortcut menu, tap an icon to display contents.
  - **Video Size:** Allows you to set the frame size of video.
  - **Advanced:** This option allows you to set the following settings: **Camera**, **Video**, **Color Adjustment**, and **General**.

## Recording videos

Set the device to video capture mode to record videos.

### To set video mode:

- Tap **Menu > Change Mode > Video Mode** then tap **Exit**.
- Tap the video mode icon on the screen.

### To record video:

1. Aim the device at your subject.
2. Full-press the camera button to begin recording. The record indicator turns from green to red while video is recording.
3. Press the camera button again to stop recording.

---

#### NOTES:

- The video clip is automatically saved to the default storage location.
  - Use Windows Media Player Mobile to playback video clip in your device.
  - Use Apple® QuickTime™ player, if you wish to play video clips in your computer. You can download QuickTime™ installer from [www.apple.com/quicktime](http://www.apple.com/quicktime).
-

## Viewing pictures and videos

Use the Pictures & Videos Application to preview stored images and playback video clips.

### Viewing pictures and videos

**To view pictures and videos:**

1. Tap  > **Programs > Pictures & Videos.**
2. Tap the picture or video clip you want to see.
  - To view pictures or launch video clips stored in MicroSD card, tap the folder list (labeled **My Pictures**), and tap **Storage Card.**
  - To view pictures stored in **My Pictures** folder on your device, tap **My Pictures** then tap a picture thumbnail.
  - To playback video clips in **My Pictures** folder on your device, tap **My Pictures** then tap a video.

### Editing pictures and photos

**To edit pictures and photos:**









1. Tap  > **Programs > Pictures & Videos.** Tap a picture or a photo thumbnail to open.
2. Tap **Menu > Image Editor.**
3. Edit the image.

Draw, add stamp, and type on the picture using the tools.

You can also erase and undo editing with the eraser tool and the undo tool.

Refer to the tool icons and their descriptions on the next page.

## Tool bar

Icons	Description	Icons	Description
	Tap to hide the tool bar		Tap to erase some parts in the picture
	Tap to select the color of your editing stroke		Tap to undo editing
	Tap to select the size of the pencil stroke		Tap to save the image
	Tap to add some stamps in the picture		Tap to exit editing
	Tap to add text		

---

### NOTES:

- This image editor function can only be applied to the pictures or photos with 640 x 480 resolution.
  - The image bigger than 640 x 480 resolution will be zoomed into 640 x 480 resolution.
- 

4. Tap  to save the picture. Then tap **Yes** to confirm.

---

**NOTE:** In this option, the original picture is replaced by the edited file.

---

You can also tap  in the Tool bar and choose **Save as** to save the edited picture as another file name.

## Streaming Player

Streaming Player allows you to play audio or video files streamed to your device from the Internet. Supported formats include 3gp, 3g2, mp4, and sdp.

**NOTE:** Before using Streaming Player, ensure that you are connected to the Internet via Wi-Fi, or GPRS connection. Refer to the sections on Wi-Fi, or GPRS in this user guide for activating any of these connections on your device.

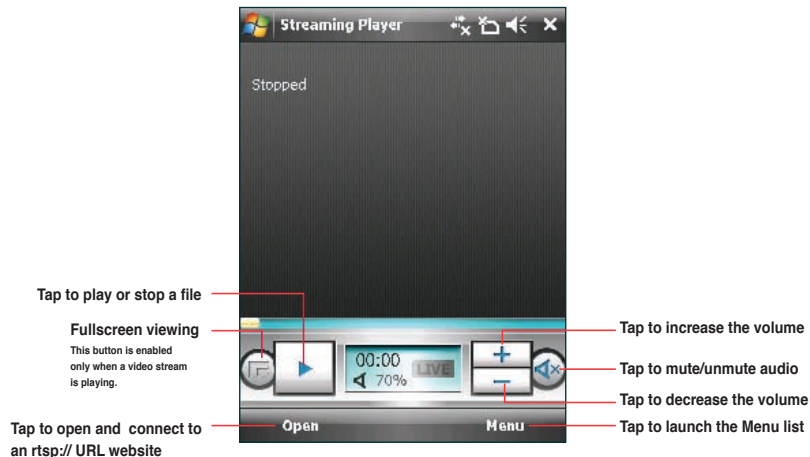

**NOTE:** A Real Time Streaming Protocol (RTSP) website provides multimedia data streams such as audio or video clips.

## Playing a streaming file

To play a streaming file:

1. Tap  > **Programs** > **Streaming Player**, then tap **Open**.
2. Select **Connect with tracking history or manual input of URL**.
3. Key in the web address then tap **Connect**.

---

**NOTE:** Streaming Player only recognizes an **rtsp:// URL** web address.

---

4. Tap  to play a streaming file from your preferred rtsp website.

---

**NOTE:** You may bookmark your favorite rtsp://URL website. Refer to the next section for more details.

---

## Connecting with bookmarks

Your device enables you to store and play streaming files from your favorite rtsp websites.

---



**NOTE:** Before you can connect to a favorite rtsp website, you must first add the website to your Bookmark list.

---



### To create a bookmark:

1. On the Streaming Player screen, tap **Menu > Bookmark Manager**.
2. Tap **New Folder**, then enter the name for the folder.
3. Tap **Save** to save the folder name. You can add an `rtsp://URL` website to the folder you have created the next time you connect to the Internet.

### To bookmark an `rtsp://URL` web address:

1. Tap  > **Programs > Streaming Player**, then tap **Open**.
2. Select **Connect with tracking history or manual input of URL**.
3. Key in the `rtsp://URL` web address then tap **Connect**.
4. Tap  to play a streaming file from your preferred `rtsp` website. While a streaming file is playing, tap **Menu > Add to My Bookmark**.
5. Assign a specific name for the streaming file that you want to save.
6. Select the folder in your Bookmark list where you want to save the file.

### To play a bookmarked streaming file:



1. Tap  > **Programs > Streaming Player**, then tap **Open**.
2. Select **Connect with Bookmark**.
3. Select a file from your Bookmark folders, then tap **Connect**.
4. Tap  to play a streaming file from your favorite `rtsp` website.



# EziMusic

EziMusic enables you to enjoy music and manage music files easily.

To launch EziMusic, do either of the following:

- Tap  > **Programs** > **EziMusic**.
- Press the AnyTime Launcher key, then tap  > **EziMusic**.

The following describes the EziMusic profile on your device.

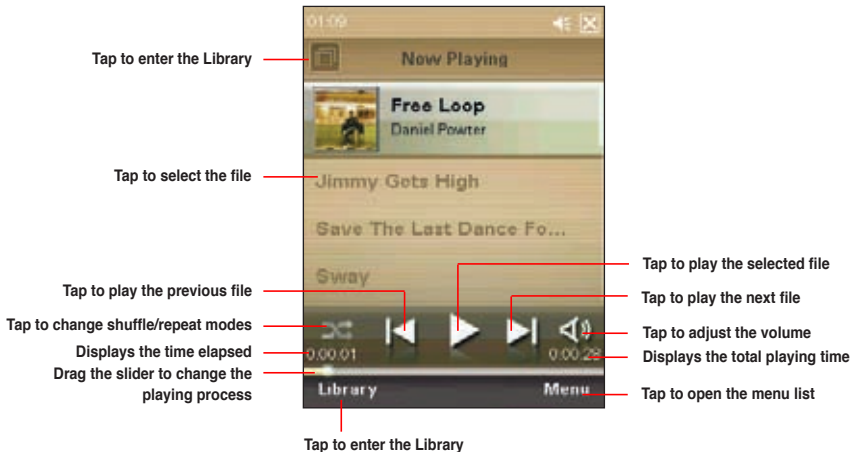



**NOTE:** For more details, refer to the Feature Highlights Guide.

# EziPhoto

EziPhoto enables you to view and manage your photos conveniently.

To launch EziPhoto, do either of the following:

- Tap  > **Programs** > **EziPhoto**.
- Press the AnyTime Launcher key, then tap  > **EziPhoto**.

The following describes the EziPhoto profile on your device.



**NOTE:** For more details, refer to the Feature Highlights Guide.

## YouTube&Flickr

YouTube&Flickr enables you to upload videos to the YouTube website and pictures to the Flickr website via MMS, and e-mail messages.

---

**IMPORTANT:**

- Ensure that you have registered the MMS service with your mobile service provider before uploading videos or pictures via MMS.
  - Set up an e-mail account on your device before uploading videos or pictures via e-mail messages. Refer to the **Setting up accounts** section in Chapter 5: Messaging for details.
- 

## Using YouTube

You are allowed to upload videos directly to the YouTube website from your device via MMS, and e-mail messages.

---

**IMPORTANT:** Before using YouTube, register for a YouTube account and set up your Mobile Profile at the YouTube website at <http://www.youtube.com>. YouTube provides you with a special e-mail address ending with @mms.youtube.com.

---

### To upload video clips to YouTube:

1. Tap  > **Programs** > **YouTube&Flickr** > **YouTube**.
2. Tap **Menu** > **Space Setting**

3. In the **Email for YouTube uploading** area key in your e-mail address, then tap **Done**.
4. Select **MMS** or an e-mail account from the dropdown list.
5. Tap **Add**, then tap a video clip from the list.

---

**NOTE:** Consult your mobile service provider for the size limit of an MMS message. You are allowed to upload several video clips at a time within the limit.

---

5. Key in a title, and description for your video clip.
6. Tap **Send** to upload the video clip to YouTube website.

## Using Flickr

You are allowed to upload photos directly to the Flickr website from your device via MMS, and e-mail messages.

---

**IMPORTANT:** Before using Flickr, register a Flickr account at the Flickr website at <http://www.flickr.com>.

---

### To upload photos to Flickr:

1. Tap  > **Programs > YouTube&Flickr > Flickr**.
2. Tap **Menu > Space Setting**.
3. In the **Email for Flickr uploading** area key in **<your username> @photos.flickr.com**, then tap **Done**.

4. Select **MMS** or an e-mail account from the dropdown list.
5. Tap **Add**, then tap a photo from the list.

---

**NOTE:** Consult your mobile service provider for the size limit of an MMS message. You are allowed to upload several photos at a time within the limit.

---

6. Key in a title, description, and tag for your picture.
7. Tap **Send** to upload the picture to the Flickr website.

# Chapter 11

## Business features



- **Ur Time**
- **Remote Calendar**
- **Meeting Time Planner**
- **WorldCard Mobile**

## Ur Time

Ur Time allows you to set the time and alarm at your current location as well as set the time for up to four cities.

### Setting time



**To set time:**

1. Tap  > **Programs** > **Ur Time**.
2. Tap **Menu** > **Time**. Set the local time at your current location.
3. Tap  when finished.





### Setting alarm

**To set the alarm:**

1. Tap  > **Programs** > **Ur Time**.
2. Tap **Menu** > **Alarm**, then tap **New** to add a new alarm, or select an existing alarm and tap **Edit**.
3. Set alarm details.  
To activate anti-snooze feature, check the **Snooze** box and set snooze interval.
4. Tap  when finished.

## Setting the World Clock

### To set World Clock:

1. Tap  > **Programs** > **Ur Time**.
2. Tap **Menu** > **World Clock**. You can set the time for up to four cities.
3. Tap . The World Clock appears on the Today screen.

## Remote Calendar

Remote Calendar allows you to access your Google Calendar from your device. From your device, you can either view the calendar or synchronize events and agenda with your Google Calendar in bi-directional way. Download events from Google calendar, or upload events to Google Calendar with your device.

---

### **IMPORTANT:**

- Obtain a Google account before you use this function. Visit [www.google.com/calendar](http://www.google.com/calendar) for details on account register.
  - Ensure that your device is connected to Internet via GPRS when using the Remote Calendar.
-



## Synchronizing your calendar

### Downloading events from Google Calendar

To download agenda or events form your Google Calendar:

1. Tap  > **Programs** > **Remote Calendar**
2. Key in the **Username** and **Password**, then tap **Sync** to start synchronizing.
3. When the calendar is synchronized successfully, a pop-up message appears. Tap **Yes** to open the calendar or tap **No** to exit.

### Uploading events to Google Calendar

To upload new events or modified events to your Google Calendar:

1. Tap  > **Calendar**.
2. Select the event you want to upload to Google Calendar, then tap **Menu** > **Upload to Google**.



## Setting Remote Calendar

The Remote Calendar allows you to set synchronization mode.

### To set your Remote Calendar:

1. Tap  > **Programs** > **Remote Calendar** > **Option** > **Setting**.
2. Set your desired synchronization mode, then tap **OK** to apply changes or tap **Cancel** to quit.



Tap to select sync mode.

Tap to select sync interval.

This item is inactive when the sync mode is set to Manual.

Tap to select sync direction.

Tap to select priority when event conflict happens.

# Meeting Time Planner

Meeting Time Planner allows you to find a suitable time to have a video conference, telephone or net meeting with participants in different time zones.

## To use the Meeting Time Planner:

1. Tap  > **Programs** > **Meeting Time Planner**.
2. Select the date and the cities.

A color-coded 24-hour timetable of the chosen cities appear, allowing you to identify the best time for the meeting. Dark blue is late night/early morning, light blue is off-peak hour, and white is peak daytime hour. You can also change the time interval shown by tapping **Interval** on the lower-right corner of the screen.

3. Select the time for your meeting and tap **New Date**.
4. Fill in the meeting information and tap  to add your date into the Calendar.

---

**NOTE:** You can tap **Interval** > **Summer Time** to use daylight saving time.



---



# WorldCard Mobile

WorldCard Mobile is capable of automatically recognizing business cards and sorting recognized field information by name, title, company, phone number, fax number, address, or other properties. You can also edit business card information for effective sorting and management.

## To use WorldCard Mobile

1. Tap  > **Programs** > **WorldCard Mobile**.
2. Tap  and then press the Camera button to capture the image of a business card. Tap **WorldCard Mobile**.
3. Select a language and then tap **Recognize** to run automatic recognition.
4. Edit the business card information if necessary.
5. To save the card information, do any of the following:
  - Tap , then tap **Yes** to confirm.
  - Tap **Export** to export the selected information to the Contacts.

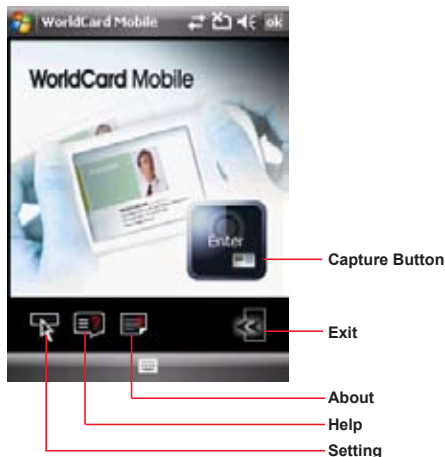

# Chapter 12

## ASUS Special features

- Gester
- ASUS Zip
- Backup
- Newstation

# Gester

This feature detects your finger movements on the screen to trigger special effects such as scrolling, panning, and zooming.

## Enabling Gester

### To enable the Gester feature

1. Tap  > **Settings** > **System** tab > **Gester**.
2. Select the check box of **Enable Gester Function**.
3. Select the **Enable Sound Effects** to activate the sound effects for the Gester functions.







---

**NOTE:** The sounds are for some of the gestures only.

---

4. Tap  when finished.

## Using Gester gestures

Action	Gesture	Description
<b>Scroll</b>		<b>Scroll up/down:</b> Slide your finger upward/downward on the screen. <b>NOTE:</b> To stop scrolling, touch the screen with your finger.
		<b>View previous page/next page in Internet Explorer and EziPhoto:</b> Slide your finger leftward/rightward on the screen.
<b>Pan</b>		<b>Pan up/down:</b> Slide your finger upward/downward on the screen and then stop at your destination.
		<b>Pan left/right:</b> Slide your finger leftward/rightward on the screen and then stop at your destination.
		<b>Pan top-left/bottom-right:</b> Slide your finger in a left-slanted upward/right-slanted bottom direction on the screen and then stop at your destination.
<b>Zoom</b>		<b>Zoom in in Internet Explorer and EziPhoto:</b> Slide your finger in a right-slanted upward direction on the screen.
		<b>Zoom out in Internet Explorer and EziPhoto:</b> Slide your finger in a left-slanted downward direction on the screen.

# ASUS Zip

ASUS Zip allows you to compress files to save space of your memory card or device.

## To compress files:

1. Tap  > **Programs** > **ASUS Zip**.
2. Select the radio button before **New compress file**, then tap **Next**.
3. Select files or folders and tap **Add** button, then tap **Next**.
4. Rename the file and select the location and compression mode. Check the **Password** box if you want to set password for the file. Tap **Next**.
5. Tap **Done** to exit. Check the **Exit and open folder** box if you want to open the folder where the compressed files are stored.

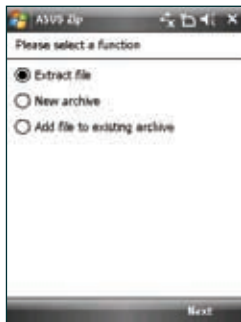

## To add files to an existing compressed file:

1. Tap  > **Programs** > **ASUS Zip**.
2. Select the radio button before **Add file to existing compressed file**, then tap **Next**.
3. Select a compressed file, then tap **Next**.
4. Select files or folders you want to add and tap **Add** button, then tap **Next**.
5. Tap **Done** to exit. Check the **Exit and open folder** box if you want to open the folder where the compressed files are stored.



### To extract files from a compressed file:

1. Tap  > **Programs** > **ASUS Zip**.
2. Select the radio button before **Extract file**, then tap **Next**.
3. Select a compressed file, then tap **Next**.
4. Select a folder to save the extracted files, then tap **Next**.
5. Tap **Done** to exit. Check the **Exit and open folder** box if you want to open the folder where the compressed files are stored.

## Backup

The Backup function allows you to backup as well as restore your files and data to your device and storage card.

### Backing up files

#### To back up files:

1. Tap  > **Programs** > **Backup** > **Backup**.
2. Select the location and the items you want to backup. Then tap **Next**.
3. Rename the file and select the storage location for the backup. Then tap **Next**.
4. Enter four digits as your password to encrypt the backup file. Then tap **Next**.
5. Tap **Start** to begin backup. Or tap **Back** to return to the last screen.

---

**NOTE:** The system will turn off all processing applications when backing up files.

---

6. When finished, tap **Reset** to reset the device.

## Setting Backup

### To set Backup:

1. Tap  > **Programs** > **Backup**, then tap **Option**.
2. Check the box if you want the device to automatically reset after backup. Tap  when finished.

## Restoring files

### To restore files:

1. Tap  > **Programs** > **Backup** > **Restore**.
2. Select the location and the items you want to restore, then tap **Next**.
3. Select the items you want to restore, then tap **Next**.
4. Enter the password to decrypt the backup file, then tap **Next**.
5. Select the items you want to restore from the backed up files, then tap **Next**.
6. Tap **Start** to begin restoring files. Tap **Back** to return to the last screen.

---

**NOTE:** The system will turn off all processing applications when restoring files.

---

7. When finished, tap **Reset** to reset the device.

# Newstation

With the Newstation in your device, you can conveniently browse news and blogs anywhere and anytime.

---

**NOTE:** Ensure that your device is connected to Internet when using Newstation.

---

## Using Newstation

### To read RSS news:

1. Tap  > **Programs** > **Newstation**.
2. Tap a category folder to open.
3. Tap a channel name to open.
4. Browse your favorite subjects.

### To create a new category folder:

1. Tap  > **Programs** > **Newstation**.
2. Tap **Menu** > **New Category** then edit the category name.

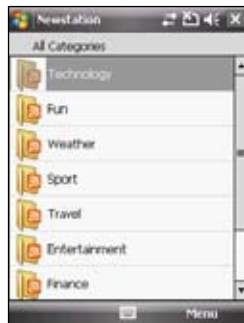

### To add a channel:

1. Tap  > **Programs** > **Newstation**, then tap a category folder to open.
2. Tap **Menu** > **New Channel**. You can add a channel from either Internet or an existing file.
  - **Input from URL**

Select the radio button of **Input from URL** and enter the URL address. Then tap **Next**.

Select a category where you want to add the channel. Then tap **Finish**.
  - **Import from a file**

Select the radio button of **Import from a file**, then tap **Next**.

Select a folder and choose a file from the list.

Choose channels from the list, then tap **Next**.

Select a category where you want to add the channel, then tap **Finish**.

## Using Newstation menus

### Category Menu

To use the category menu:

1. Tap  > **Programs** > **Newstation**.
2. Select a category folder. Then tap **Menu**. The menu list pops up.
3. Tap an option that you need.

### Channel Menu

To use the channel menu:

1. Tap  > **Programs** > **Newstation**.
2. Tap a category folder, then select a channel and tap **Menu**.
3. Tap an option that you need.

### Subject Menu

To use the subject menu:

1. Tap  > **Programs** > **Newstation**.
2. Tap a category folder. Then tap a channel to open. Select a subject and tap **Menu**. The menu list pops up.
3. Tap an option that you need.



# Chapter 13





## Other features

- **Microsoft® Office Mobile**
- **ClearVue PDF**
- **Auto Cleaner**
- **Restoring default factory settings**
- **System information**
- **Task Manager**
- **Removing programs**
- **Google Search**
- **Google Maps Mobile**
- **SMS Location Link**

## Microsoft® Office Mobile

Your device comes with preinstalled Microsoft® Office Mobile applications which enable you to create, view, and edit spreadsheets, presentations, note, and word files on your device. Use these applications like you would normally use the Office applications on your computer.

To access these applications, tap  > **Office Mobile**. Select the appropriate application to use.

ICON	DESCRIPTION
	Excel Mobile allows you to view, create, and edit an Excel spreadsheet.
	OneNote Mobile allows you to view, create, and edit an OneNote file.
	Powerpoint Mobile allows you to view a powerpoint presentation.
	Word Mobile allows you to view, create, and edit a word file.

## Excel® Mobile

Excel® Mobile enables you to create, view, and edit spreadsheets on your device. Any editing or formatting done on a spreadsheet file is kept intact even when you open the spreadsheet file on your computer. Excel® Mobile is compatible with Microsoft® Office Excel 2007.

To launch Excel® Mobile, tap  > **Office Mobile** > **Excel Mobile**.

TO	DO THIS
Create a new spreadsheet	Tap <b>New</b> to create a new spreadsheet; or tap <b>Menu</b> > <b>File</b> > <b>New</b> to create another new spreadsheet while working on a current file. A blank workbook is displayed. Enter the data for your new spreadsheet. Tap  when done.
Clear contents, formatting, or both	Using the stylus, highlight the cells, rows, or columns that you want to clear. Tap <b>Menu</b> > <b>Edit</b> > <b>Clear</b> . Tap <b>Contents</b> to clear the contents in the highlighted cell or cells; tap <b>Format</b> to clear the formats applied to the cells, rows, or columns; and tap <b>All</b> to clear both the contents and formats applied to the cells, rows, or columns.
Format cells, rows, or columns	Tap <b>Menu</b> > <b>Format</b> . Make the necessary formats for the cells, rows, or columns.
Modify the sheets	Tap <b>Menu</b> > <b>Format</b> > <b>Modify Sheets</b> . You may rename, insert, delete, move up or move down the sheet.
Insert cells (rows or columns), chart, symbol, function	Tap <b>Menu</b> > <b>Insert</b> . Select the item that you want to insert. You may insert rows, columns, charts, symbols, or functions.
Sort data	Tap <b>Menu</b> > <b>Sort</b> . Select the columns that you want to sort. Deselect the <b>Ascending</b> checkbox if you want to sort the data in descending order.
Save a file	Tap <b>Menu</b> > <b>File</b> > <b>Save As...</b> Enter the name, folder, and location for the file. Tap <b>Save</b> .



TO	DO THIS
Rename or move a spreadsheet file	Tap <b>Menu &gt; File &gt; Rename/Move...</b> Enter the new name in the <b>Name</b> field. To move the file to another location, select the folder or location where you want to move the file. When finished, tap <b>ok</b> .
Send a file via an e-mail message	Tap <b>Menu &gt; File &gt; Send via E-mail... &gt; Outlook E-mail</b> . A new e-mail template is displayed with the Excel file attached. Key in the recipient's e-mail address, the subject, and your message. Tap <b>Send</b> .
Beam a file	Tap <b>Menu &gt; File &gt; Beam...</b> From the list of devices, tap the device you want to send the file to, then tap <b>Tap to Send</b> .
Delete a file	Tap <b>Menu &gt; File &gt; Delete</b> . Tap <b>Yes</b> in the confirmation message.

## OneNote® Mobile

OneNote® Mobile is a note-taking application. It allows you to capture information in multiple ways and organize it according to your needs. Besides text, you can also insert audio recording and pictures to your notes.

To launch OneNote® Mobile, tap  > **Office Mobile > OneNote Mobile**.

TO	DO THIS
Create a new note	Tap <b>New</b> . When finished, tap <b>ok</b> or <b>Done</b> .
Apply text formatting	Highlight the text you want to apply formatting to. Tap <b>Menu &gt; Format</b> . You can apply bold, italic, underline, or strikethrough formatting to the text.
Clear all formatting styles	Highlight the text you want to clear the formats for. Tap <b>Menu &gt; Format &gt; Clear All</b> .

TO	DO THIS
Creating a bulleted or numbered list	Tap <b>Menu &gt; List</b> . Select the list type that you want to create.
Clear the applied list	Highlight the lines of text, then tap <b>Menu &gt; List &gt; Clear</b> .
Cut, copy, or paste text	Tap <b>Cut</b> , <b>Copy</b> , or <b>Paste</b> from <b>Menu</b> .
Take a picture to insert into your note	Tap <b>Menu &gt; Take Picture</b> . After taking the picture, tap the name of your note at the bottom right corner of the screen. The picture appears on your note.
Insert an existing picture into your note	Tap <b>Menu &gt; Insert Picture</b> . From the existing pictures that are displayed, tap the picture that you want to insert into your note.
Insert recording to your note	Tap <b>Menu &gt; Insert Recording</b> . Create your recording, then tap <b>OK</b> when done.
Delete a note	From the list of existing notes, tap <b>Menu &gt; Delete</b> . Tap <b>Yes</b> to confirm deletion.
Rename a note	From the list of existing notes, tap <b>Menu &gt; Rename</b> . Key in the new note name. When finished, tap <b>ok</b> or <b>Done</b> .
Sort the notes by name or by date modified	From the list of existing notes, tap <b>Menu &gt; Options</b> . From the dropdown list in the <b>Sort notes by</b> field, select the sort type. When finished, tap <b>ok</b> or <b>Done</b> .

## Word® Mobile

Word® Mobile enables you to view and edit Word documents on your device. It saves the editing or formatting that you have done on a Word document from your PDA phone, even when you open the Word document on your computer. Word® Mobile is compatible with Microsoft® Office Word 2007.

To launch Word® Mobile, tap  > **Office Mobile** > **Word Mobile**.



TO	DO THIS
Create a new word file	Tap <b>New to create a new word file</b> ; or tap <b>Menu &gt; File &gt; New</b> to create another file while working on the current one. Enter the contents for your new word file. Tap <b>ok</b> when done.
Save the existing as another file	Tap <b>Menu &gt; File &gt; Save As...</b> Enter the name, folder, and location for the file. Tap <b>Save</b> .
Rename or move a file	Tap <b>Menu &gt; File &gt; Rename/Move...</b> Enter the new name in the <b>Name</b> field. To move the file to another location, select the folder or location where you want to move the file.
Send a file via an e-mail message	Tap <b>Menu &gt; File &gt; Send via E-mail... &gt; Outlook E-mail</b> . A new e-mail template is displayed with the word file attached. Key in the recipient's e-mail address, the subject, and your message. Tap <b>Send</b> .
Beam a file	Tap <b>Menu &gt; File &gt; Beam...</b> From the list of devices, tap the device you want to send the file to, then tap <b>Tap to Send</b> .
Delete a file	Tap <b>Menu &gt; File &gt; Delete</b> . Tap <b>Yes</b> in the confirmation message.
Apply font formatting	Tap <b>Menu &gt; Format &gt; Font</b> . Set your preferred font format. Tap <b>ok</b> when done.
Apply paragraph formatting	Tap <b>Menu &gt; Format &gt; Paragraph</b> . Set your preferred paragraph format. Tap <b>ok</b> when done.

TO	DO THIS
Check the spelling in a file	Tap <b>Menu</b> > <b>Tools</b> > <b>Spelling</b> .
Count the words or characters in a file	Tap <b>Menu</b> > <b>Tools</b> > <b>Word Count</b> .
Insert the date	Tap <b>Menu</b> > <b>Tools</b> > <b>Insert Date</b> .
Find or replace text	Tap <b>Menu</b> > <b>Edit</b> > <b>Find/Replace...</b>
Cut, copy, or paste text	Tap <b>Cut</b> , <b>Copy</b> , or <b>Paste</b> from <b>Menu</b> .
Clear the contents	Tap <b>Menu</b> > <b>Edit</b> > <b>Clear</b> .
Select all contents	Tap <b>Menu</b> > <b>Edit</b> > <b>Select All</b> .
Create a duplicate file	From the list of existing files, tap and hold the file that you want to create a duplicate. The file menu list appears. Tap <b>Create Copy</b> .

## PowerPoint® Mobile

PowerPoint® Mobile enables you to view presentation files on your PDA phone. It is compatible with Microsoft® Office PowerPoint 2007.

To launch PowerPoint® Mobile, tap  > **Office Mobile** > **PowerPoint Mobile**.

TO	DO THIS
Set up the presentation settings such as the orientation, slide animation, or slide transition	Tap <b>Menu</b> > <b>Set up Show</b> . Set up your preferred settings. Tap  when done.
View a presentation file	From the list of existing files, tap the file that you want to view. While viewing the slideshow presentation, tap and hold the device's screen. From the menu list that appears, tap on any menu item.
Copy an existing file	From the list of existing files, tap and hold the file that you want to copy. The file menu list appears. Tap <b>Create Copy</b> .
Delete a file	From the list of existing files, tap and hold the file that you want to delete. The file menu list appears. Tap <b>Delete</b> .
Rename or move a file	From the list of existing files, tap and hold the file that you want to rename or move. The file menu list appears. Tap <b>Rename/Move...</b> Enter the new name in the <b>Name</b> field. To move the file to another location, select the folder or location where you want to move the file. When finished, tap  .

TO	DO THIS
Create a duplicate file	From the list of existing files, tap and hold the file that you want to create a duplicate. The file menu list appears. Tap <b>Create Copy</b> .
Send a file via an e-mail message	Tap <b>Menu &gt; File &gt; Send via E-mail... &gt; Outlook E-mail</b> . A new e-mail template is displayed with the Excel file attached. Key in the recipient's e-mail address, the subject, and your message. Tap <b>Send</b> .
Beam a file	Tap <b>Menu &gt; File &gt; Beam...</b> From the list of devices, tap the device you want to send the file to, then tap <b>Tap to Send</b> .

# ClearVue PDF

ClearVue PDF allows you to read documents in Portable Document Format (PDF).

## To launch the ClearVue PDF application:

- Tap  > **Programs** > **ClearVue PDF**.

## To exit the ClearVue PDF application:



- Tap **File** > **Exit**.

TO	DO THIS
Open a PDF file	Tap <b>File</b> > <b>Open...</b> . Tap a file to open.
Close an open file	Tap <b>File</b> > <b>Close</b> .
Open a recently viewed file	Tap <b>File</b> > <b>Recent Files</b> . A list of recently viewed files appears. Tap the file you want to open.
Zoom the content of an open file	Tap <b>Zoom</b> . Select the scale you want to use or tap <b>Custom...</b> to customize the scale.

## Auto Cleaner

To free memory, you can use this function to conveniently close the running applications that you are not using.

### To set Auto Cleaner:

1. Tap  > **Settings** > **System** tab > **Auto Cleaner**.
2. Select the check box to activate the Auto Cleaner function, then select either **Short** or **Long press X to close the program**.
3. Tap **Setting** button to set the **Exception** and the **Forced**.
4. Tap  when finished.

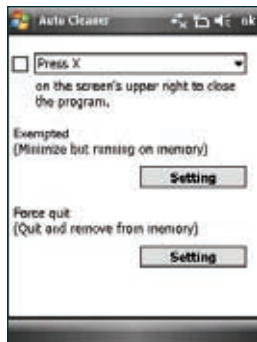



## Restoring default factory settings

This option allows you to restore the device system to its default factory settings.

### To restore default settings:

1. Tap  > **Settings** > **System** tab > **Default Settings**.
2. Enter '1234' in the Password field and tap OK to confirm that you want to restore to default settings.
3. Tap **Yes** to start restoring.

---

**WARNING:** This option deletes all files stored in your device. Back up your important data to your storage card or computer before restoring to the default settings. Before proceeding with restoring to the default settings, ensure that you remove the microSD card from the device.

---

## System information

The System Information contains important device information including the current device settings and version.

### To launch the System Information:

1. Tap  > **Settings** > **System** tab > **System Information**.
2. Tap the **Device Info** tab for device hardware information.
3. Tap **Version** tab to display the ROM, Boot, Radio and Battery version.

## Task Manager

The Task Manager allows you to monitor the currently running programs, memory and CPU occupancy. You can use this function to end these programs easily. You can also switch to any of the listed programs from the Task Manager screen.

### To launch Task Manager:

Tap  > **Programs** > **Task Manager**.

### To end a program:

Select the program you want to end and tap **End Task**.

To end all tasks, tap **Menu** > **End All Tasks**.

### To switch to a program:

Select a program and press down the Navigation key, or tap **Menu** > **Switch To**.

## Removing programs

To free the storage memory of your device, you can remove the programs you installed. But for the programs preinstalled in your device, you are not allowed to remove them.



### To remove a program:

1. Tap  > **Settings** > **System** tab > **Remove Programs**.
2. Select a program you want to remove, then tap **Remove**.
3. A warning message pops up. Tap **Yes** to confirm.

## Google Search

Google Search enables you to do web searches on your device as you would on Google search engine on your computer.

### To display the Google Search bar on the Today screen:

1. Tap  > **Settings** > **Personal** tab > **Today**.
2. From the list on the **Items** tab, select **Google Search**.
3. Tap  when done. The Google Search bar is displayed on the Today screen.

# Google Maps Mobile

Google Maps Mobile is a free map service from Google that allows you to get traffic updates, driving directions, business listings, and satellite images on your device.

---

## NOTES:

- Some functions of Google Maps Mobile may not work depending on your location.
  - Google Maps is only available in these countries: Russia, France, Germany, Italy, Spain, Portugal, Belgium, Switzerland, Sweden, Norway, Denmark, United Kingdom, Taiwan, and China.
  - Google Maps Mobile (GMM) is solely provided by Google and Google may update GMM on its website at anytime at its own discretion. If you encounter problems in using Google Maps Mobile, contact Google directly.
- 

To launch Google Maps Mobile, tap  > **Google Maps**.

TO	DO THIS
Get directions	Tap <b>Menu &gt; Directions</b> . In the <b>Start point</b> field, key in the area where you are coming from; and in the <b>End point</b> field, key in the area where you are going to. Tap <b>ok</b> when done.
Get a satellite imagery of an area	Tap <b>Menu &gt; Satellite View</b> .
Get live traffic updates	Tap <b>Menu &gt; Show Traffic</b> .

Find the location of a contact	Tap <b>Menu &gt; Options &gt; Lookup Contact...</b> From your contacts list, select the contact that you want to find.
Find your approximate location	Tap <b>Menu &gt; My Location</b> , and press <b>0 (zero)</b> to move the map to your location. A flashing blue dot appears indicating your approximate current location. If the GPS signal is weak, a flashing blue dot surrounded by a light blue circle appears. <b>NOTE:</b> For a better signal reception, use an external GPS device with your mobile device.

---

**NOTE:** You may also send your location to a contact or find the location of a contact in the Google Maps. For more details, refer to page 103.

---

## SMS Location Link

This function allows you to send your current location and the location link on Google Map through SMS.

---

**NOTE:** Turn on GPS in your device before using this function.

---

### To send your location and the location link through SMS:

1. Tap  > **Messaging**, tap **Text Message**. Tap **Menu** > **Send My Location**.
2. Key in the recipient's number or tap **To:** area to add recipients from your contact list.
3. Key in your message and tap **Send** when finished.

You may also send your location directly to one of your contacts in your contacts list. To do this:

- Tap **Contacts** from the ASUS Today screen, select a contact from the list, and tap **Menu** > **Send My Location**.

# Appendices

- **Notices**
- **Specific Absorption Rate (SAR)**
- **ASUS contact information**

# Notices

## Replaceable batteries

If an equipment is provided with a replaceable battery and if replacement by an incorrect type could result in an explosion (e.g. with some lithium batteries), the following applies:

- if the battery is placed in an OPERATOR ACCESS AREA, there shall be a marking close to the battery or a statement in both the operating and the servicing instructions;
- if the battery is placed elsewhere in the equipment, there shall be a marking close to the battery or a statement in the servicing instructions.

The marking or statement shall include the following or similar text:

---

**CAUTION:**

- RISK OF EXPLOSION IF BATTERY IS REPLACED BY AN INCORRECT TYPE.
  - DISPOSE OF USED BATTERIES ACCORDING TO THE INSTRUCTIONS.
- 

## Operator access with a tool

If a TOOL is necessary to gain access to an OPERATOR ACCESS AREA, either all other compartments within that area containing a hazard shall be inaccessible to the OPERATOR by the use of the same TOOL, or such compartments shall be marked to discourage OPERATOR access.

An acceptable marking for an electric shock hazard is (ISO 3864, No. 5036).

Equipment for restricted access locations



For equipment intended only for installation in a RESTRICTED ACCESS LOCATION, the installation instructions shall contain a statement to this effect.

---

**WARNING:** The user needs to switch off the device when exposed to areas with potentially explosive atmospheres such as petrol stations, chemical storage depots and blasting operations.

---

## Specific Absorption Rate (SAR)

### Bodyworn operation

For bodyworn operation, this device has been tested and meets the FCC RF exposure guidelines for use with an accessory that contains no metal and the positions the handset a minimum of 1.5 cm from the body. Use of other enhancements may not ensure compliance with FCC RF exposure guidelines. If you do not use a body-worn accessory and are not holding the device at the ear, position the handset a minimum of 1.5 cm from your body when the device is switched on.

### Exposure to radio waves

#### **THIS MODEL MEETS INTERNATIONAL GUIDELINES FOR EXPOSURE TO RADIO WAVES**

Your mobile device is a radio transmitter and receiver. It is designed not to exceed the limits for exposure to radio waves recommended by international guidelines. These guidelines were developed by the independent scientific organization ICNIRP and include safety margins designed to assure the protection of all persons, regardless of age and health.

The guidelines use a unit of measurement known as the Specific Absorption Rate, or SAR. The ICNIRP SAR limit for mobile devices used by the general public is 2 W/kg. The highest CE SAR value for this device when tested for use on the head was 0.955 W/kg\* and 0.445 W/kg\* on the body.

As SAR is measured utilizing the device's highest transmitting power, the actual SAR of this device while operating is typically below that indicated above. This is due to automatic changes to the power level of the device to ensure it only uses the minimum level required to reach the network.

While there may be differences between the SAR levels of various phones and at various positions, they all meet the governmental requirements for safe exposure. Please note that improvements to this product model could cause differences in the SAR value for later products; in all cases, products are designed to be within the guidelines.

The World Health Organization has stated that present scientific information does not indicate the need for any special precautions for the use of mobile devices. They note that if you want to reduce your exposure then you can do so by limiting the length of calls or using a 'handsfree' device to keep the mobile phone away from the head and body.

Additional Information can be found on the websites of the World Health Organization (<http://www.who.int/emf>).

---

\* The tests are carried out in accordance with international guidelines for testing. The limit incorporates a substantial margin for safety to give additional protection for the public and to account for any variations in measurements. Additional related information includes the ASUS testing protocol, assessment procedure, and measurement uncertainty range for this product.

---

## ASUS

Address: 15 Li-Te Road, Peitou, Taipei, Taiwan

Tel: 886228943447; Fax: 886228907698

## Declaration

We declare that the IMEI codes for this product, **ASUS P565**, are unique to each unit and only assigned to this model. The IMEI of each unit is factory set and cannot be altered by the user and that it complies with the relevant IMEI integrity related requirements expressed in the GSM standards.

Should you have any questions or comments regarding this matter, please contact us.

Sincerely yours,

**ASUSTeK COMPUTER INC.**

Tel: 886228943447

Fax: 886228907698

Email: <http://vip.asus.com/eservice/techserv.aspx>

## ASUS Contact information

### ASUSTeK COMPUTER INC. (Asia Pacific)

Address 15 Li-Te Road, Peitou, Taipei, Taiwan 11259  
Website [www.asus.com.tw](http://www.asus.com.tw)

#### Technical Support

Telephone +886228943447  
Support Fax +886228907698  
Software download [support.asus.com\\*](http://support.asus.com)

### ASUS COMPUTER INTERNATIONAL (America)

Address 800 Corporate Way, Fremont, CA 94539, USA  
Telephone +15029550883  
Fax +15106084555  
Website [usa.asus.com](http://usa.asus.com)  
Software download [support.asus.com\\*](http://support.asus.com)

### ASUS COMPUTER GmbH (Germany and Austria)

Address Harkort Str. 21-23, D40880 Ratingen, Germany  
Telephone +49210295990  
Fax +492102959911  
Online contact [www.asus.com.de/sales](http://www.asus.com.de/sales)

#### Technical Support

Telephone +49180595990  
Fax +492102959911  
Online support [www.asus.com.de/support](http://www.asus.com.de/support)  
Website [www.asus.com.de/news](http://www.asus.com.de/news)

\* Available on this site is an online Technical Inquiry Form that you can fill out to contact technical support.

# Declaration of Conformity

**We, ASUS COMPUTER GmbH**

**HARKORT STR. 25 40880 RATINGEN, BRD. GERMANY**

declare that the product

**PDA Phone P565**

is in conformity with

R&TTE Directive (99/5/EC), the EMC Directive (89/336/EEC), and the Low Voltage Directive (2006/95/EC) issued by the Commission of the European Community.

- EN 300328** Electromagnetic compatibility and Radio spectrum Matters (ERM); wideband transmission equipment operating in the 2.4Ghz ISM band and using spread spectrum modulation techniques; Part 1: technical characteristics and test conditions Part2: Harmonized EN covering essential requirements under article 3.2 of the R&TTE
- EN 300440-2** Electromagnetic compatibility and Radio spectrum Matters(ERM); Short range devices; Radio equip-ment to be used in the 1 GHZ to 40 GHZ frequency range; Part2: Harmonized EN under article 3.2 of the R&TTE Directive
- EN 301489-1** Electromagnetic compatibility and Radio spectrum Matters(ERM); Electromagnetic
- EN 301489-7** compatibility(EMC) standard for radio equipment and services; Part 1 : Common technical
- EN 301489-17** requirements; Part 7 : Specific conditions for mobile and portable radio and ancillary equipment of
- EN 301489-24** digital cellular radio telecommunications systems (GSM and DCS); Part 17: Specific conditions for wideband data and HIPER-LAN equipment ; Part24: Specific conditions for IMT-2000 CDMA Direct Spread (UTRA) for Mobile and Portable (UE) radio and ancillary equipment
- EN 301511** Global System for Mobile communications(GSM) Harmonized EN for mobile stations in the GSM 900 And GSM 1800 bans covering essential requirements of article 3.2 of article 3.2 of the R&TTE directive(1999/5EC)

- EN 301908-1**  
**EN 301908-2** Electromagnetic compatibility and Radio spectrum Matters(ERM); Base Stations(BS), Repeaters and User Equipment(UE)for IMT-2000 Third-Generation cellular Networks,-Part1:Harmonized EN for IMT-2000, Introduction and common requirements, covering Essential requirements of article 3.2 of the R&TTE Directive Part2:Harmonized EN for IMT-2000,CDMA Direct Spread (UTRD FDD) (UE)covering essential requirements of article 3.2 of the R&TTE Directive.
  - EN 55022:2006** Limits and methods of measurement of radio disturbance characteristics of information technology equipment
  - EN 55024:**  
**1998+A1:2**  
**001+A2:2003** Information Technology equipment-Immunity characteristics-Limits and methods of measurement
  - EN 50360**  
**EN 50361** the limitation of exposure of the general public to electromagneticnetwork fields (0 Hz to 300 GHz) International Commission on Non-Ionising Radiation Protection (1998), Guidelines for limiting exposure in time-varying electric, magnetic, and electromagnetic fields
  - EN 61000-3-2 :**  
**2000+A2:2005** Disturbances in supply systems caused
  - EN 61000-3-3 :**  
**1995+A1:2001** Disturbances in supply systems caused
  - EN 55013** Limits and methods of measurement of radio disturbance characteristics of broadcast receivers and associated equipment
  - EN 55020** Immunity from radio interference of broadcast receivers and associated equipment
  - EN 50332-1** Sound system equipment-Headphones and earphones associated with portable audio equipment-Maximum sound pressure level measurement methodology and limit considerations-Part1:General method for "one package equipment"
  - CE marking**
- 
- EN 60065** Safety requirements for mains operated electronic and related apparatus for household and similar general use
  - EN 60335** Safety of household and similar electrical appliances
  - EN 60950-1** Safety for information technology equipment including electrical business equipment
  - EN 50091-1** General and Safety requirements for uninterruptible power systems (UPS)

**Date : 07/01/2008**

## Free Manuals Download Website

<http://myh66.com>

<http://usermanuals.us>

<http://www.somanuals.com>

<http://www.4manuals.cc>

<http://www.manual-lib.com>

<http://www.404manual.com>

<http://www.luxmanual.com>

<http://aubethermostatmanual.com>

Golf course search by state

<http://golfingnear.com>

Email search by domain

<http://emailbydomain.com>

Auto manuals search

<http://auto.somanuals.com>

TV manuals search

<http://tv.somanuals.com>