

---

# ATI Multimedia Center 7.1

## User's Guide

Version 6.0

P/N 137-40188-60 Rev. F

© Copyright 2000, by ATI Technologies Inc.

All rights reserved, including those to reproduce this guide or parts thereof, in any form without the express written permission of ATI Technologies Inc.

Features and specifications are subject to change without notice. Trademarks and/or registered trademarks are the properties of their respective owners:

ALL-IN-WONDER 128, ALL-IN-WONDER 128 PRO, ALL-IN-WONDER RADEON,  
RADEON VE – ATI Technologies Inc.; Athlon – Advanced Micro Devices Inc.;  
CDDB – Escient; Windows – Microsoft Corp.; GuidePlus+ – Gemstar Technology Development  
Limited; HydraVision – Appian Graphics; Pentium, Pentium II, Pentium III, Pentium with MMX  
Technology – Intel Corporation.

## **Disclaimer**

The manufacturer (MFR) reserves the right to make changes to this document and the products which it describes without notice. The MFR shall not be liable for technical or editorial errors or omissions made herein; nor for incidental or consequential damages resulting from the furnishing, performance, or use of this material.

# Table of Contents

<b>Using Your ATI Multimedia Center . . . . .</b>	<b>7</b>
Starting ATI Multimedia Center.....	8
Starting from LaunchPad.....	8
Starting from Windows® taskbar.....	9
Attaching and Detaching Panels.....	9
Online Help.....	10
<b>TV .....</b>	<b>11</b>
Video-In.....	12
Setting up TV .....	13
Sizing the TV display .....	14
TV Control menu.....	15
TV display settings.....	16
TV video settings.....	17
TV Tuner settings.....	18
TV Stills Gallery settings .....	21
TV Schedule settings.....	21
ATI TV Bar .....	22
Channel Surfing.....	23
Closed Captioning .....	24
Hot Words™ .....	26
TV Magazine.....	28
Secondary Audio Program (SAP) .....	30
Zooming and panning.....	30
Video Desktop.....	31
Program Lockout.....	32
Parental Control.....	33
Capturing Video and still images .....	34
<b>TV-on-Demand™ .....</b>	<b>36</b>
<b>Digital VCR .....</b>	<b>39</b>
Saving and compressing captured video .....	39
Digital VCR settings .....	40
Real-time MPEG encoding .....	41
Achieving the best results with MPEG video capture.....	42
<b>TV Listings.....</b>	<b>44</b>
Setting up TV Listings .....	45
Getting around.....	46
Recording .....	46
Viewing .....	47
Views.....	47
Filter options.....	48

Actors tab .....	48
Categories tab .....	49
Searches .....	49
Favorite search .....	49
Movies tab .....	50
Schedules tab .....	51
Searches tab .....	51
Setting search parameters .....	52
Sports tab .....	53
Stations tab .....	53
Titles tab .....	54
Days and dates .....	54
<b>Stills Gallery .....</b>	<b>55</b>
Stills Gallery settings.....	55
<b>CD Audio.....</b>	<b>57</b>
CD Audio settings .....	58
CD Database .....	59
CD Audio Schedule settings.....	60
<b>Video CD .....</b>	<b>61</b>
Video CD Control menu.....	62
Capturing still frames from Video CDs .....	63
Zooming and Panning .....	63
Video CD Display settings .....	64
Video CD Preferences settings.....	65
Video CD Stills Gallery settings .....	66
<b>DVD .....</b>	<b>67</b>
What can I play on my DVD drive?.....	68
Sizing the Video Display panel .....	68
Full-screen controls .....	68
Playing DVD Video Disks .....	69
Selecting audio streams .....	69
Setting up sub-titles .....	69
Using the menus .....	70
Searching DVD disks .....	70
Selecting viewing angle.....	70
Parental Control.....	71
Zooming and Panning .....	71
DVD Control menu .....	72
DVD display settings.....	73
DVD Preferences settings .....	74
DVD Video settings .....	75
DVD Closed Captioning .....	75
DVD Schedule settings .....	76
Region codes .....	77

<b>File Player .....</b>	<b>78</b>
File Player Control menu .....	79
Zooming and Panning .....	80
File Player Display settings .....	81
File Player Preferences settings.....	82
File Player Stills Gallery settings .....	82
File Player Schedule settings.....	82
<b>Schedule .....</b>	<b>83</b>
Schedule settings .....	84
<b>TV Out .....</b>	<b>85</b>
<b>Multi-monitor support.....</b>	<b>86</b>
<b>Teletext .....</b>	<b>86</b>
<b>Troubleshooting.....</b>	<b>87</b>
Audio problems ... ..	87
Video problems ... ..	91
<b>Index .....</b>	<b>Index - 1</b>



---

# Using Your ATI Multimedia Center

This chapter explains how to use the special features that your ATI Multimedia Center offers. The Multimedia Center is a suite of products that provides TV, Video CD, CD Audio, DVD, and File Player in one package.

Because North American and European television use different broadcast standards, closed-captioning and related features are available only in North America.

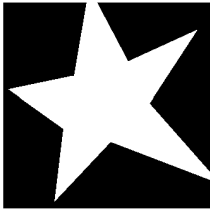

## IN THIS CHAPTER...

- **Starting ATI Multimedia Center** on page 8
- **TV** on page 11
- **ATI TV Bar** on page 22
- **TV-on-Demand™** on page 36
- **Digital VCR** on page 39
- **TV Listings** on page 44
- **Stills Gallery** on page 55
- **CD Audio** on page 57
- **Video CD** on page 61
- **DVD** on page 67
- **File Player** on page 78
- **Schedule** on page 83
- **TV Out** on page 85
- **Multi-monitor support** on page 86
- **Teletext** on page 86
- **Troubleshooting** on page 87

## Starting ATI Multimedia Center

### Starting from LaunchPad



The LaunchPad provides a convenient way to start all your Multimedia Center features — just click the feature you want. LaunchPad opens automatically when you start your computer, or if you prefer, you can right-click LaunchPad, and uncheck **Load on Startup** in the drop-down menu.

- To dock LaunchPad, right-click it, then click **Dock** in the menu. To change the docking position, right-click LaunchPad while it is docked, point to **Side ►**, then choose a location.
- To change the size of the LaunchPad when it is not docked, double-click it or right-click it, and choose a size.

The buttons in the upper right of LaunchPad let you access your desktop settings, get Help, and close LaunchPad. If your system does not have a TV tuner, **Video In** appears in place of TV in the LaunchPad.

#### **Note**

TV, DVD, Video CD, and File Player use some of the same resources. If you try to start one of these features while another is running, a resource conflict message appears. You have four choices:

- Run both features with reduced performance, where possible.
- Suspend the first feature while the other is active.
- Close the first feature.
- Press **Cancel** to continue without starting the second feature.



## Starting from Windows® taskbar

- 1** In the Windows taskbar, click **Start**.
- 2** Point at **Programs ▶**.
- 3** Point at **ATI Multimedia Center ▶**.
- 4** Click **CD Audio, DVD, LaunchPad, File Player, TV, or Video CD**.

*For information about using the ATI Multimedia Center features, see the online help.*

## Attaching and Detaching Panels

You can detach the DVD, Video CD, TV, CD Audio, and File Player, control panels from their display panels, move them to any location on your screen, and re-attach them.

### To detach a panel

Move the cursor to the border of the panel you want to detach. As the cursor reaches the border, it changes to the detach symbol. Click the panel, and drag it away.

### To attach a panel

Drag a panel to the panel you want to attach until its outline changes, then release the mouse button. The panels will snap back together.

### Online Help



**Feature Help.** Click the Help button in any display panel to open the online help.

F1

**Context-Sensitive Help.** Context-sensitive help is always available for each feature; just press the F1 key.



**Tool Tips.** Simply move the mouse cursor over a control to see a description of its purpose. As you become familiar with your ATI Multimedia Center, you may want to turn off Tool Tips — click the **Show Tool Tips** checkbox in the **Display** tab (for more information, see *TV display settings* on page 16).



**ATI Desktop Help.** For help on your ATI video card's graphics features, double-click the ATI icon in the lower-right corner of your screen.

## TV

Watch Television on your computer! You can receive up to 125 cable television channels and 70 antenna channels in smooth, full-motion video on the whole screen or in a window.

TV delivers advanced features: Closed Captioning, Video/Still Capture, Channel Surfing, Scheduled Events, TV Listings, Parental Control, and more.

When you click the logo in the upper left corner of the display panel, the “About...” notice appears. If you have more than one feature installed, a Task menu displays available and active features.

*For information about using TV controls, see the online help and Tool Tips.*

**Note**

- All channels may not be available in all countries.
- Not all TV features are available with Video-In cards.

### To start TV



#### from LaunchPad

Click **TV** in the Launchpad. For information on LaunchPad, see [page 8](#).

#### from Windows® taskbar

- 1 In the Windows taskbar, click **Start**, then point at **Programs** ►.
- 2 Point at **ATI Multimedia Center** ►, then click **TV**.

 You can also start TV from other Multimedia Center features installed on your system—DVD, Video CD, CD Audio, and File Player. Click the ATI logo in the upper left corner of the feature's control panel, then click **TV**.

## Video-In

If there is no TV tuner in your computer system, a small control panel with controls for composite input is provided for capturing video from external video sources.



#### **Note**

If you have a Video-In card, the following dialogs and features are unavailable:

- TV Tuner settings (see [page 18](#).)
- Channel Surfing (see [page 23](#).)
- TV-on-Demand (see [page 36](#).)
- Program Lockout (see [page 32](#).)
- Parental Control (see [page 33](#).)

## Setting up TV

The first time you start TV, you must complete the Initialization Wizard. After that, the Wizard will not run unless you want to re-run it in order to change settings. The Initialization Wizard guides you quickly and easily through setting up TV channels, Parental Control, Sound, and TV-on-Demand.

### Note

- If you have a Video-In card, only the Sound Initialization Wizard is used.
- TV-on-Demand is only available if your card supports it.

## Initialization Wizard



Click the Setup button, then click the **Display** tab.

Click the **Initialization Wizard...** button. The *TV Channels Initialization Wizard* appears. Follow the Wizard's instructions to select cable or antenna, choose the broadcast standard, and to scan for active channels.

- If you have TV Listings installed with its current database, it will also add the channel name for each channel. For more information see *TV Listings* on page 44.

Click **Next >**. The *TV Parental Control Initialization Wizard* appears. Follow the Wizard's instructions to set or change your Parental Control password.

### Note

- Passwords are **optional**.
- Passwords are **case-sensitive**, and must be at least **three characters** in length.
- If you forget your password, you will have to uninstall and reinstall your TV software.

Click **Next >**. The *Sound Initialization Wizard* appears. Follow the Wizard's instructions to set up your audio connection.

- If you do not hear TV audio, ensure that the TV is tuned to a broadcasting channel, and that you have made the correct audio connections. See *Troubleshooting* on page 87 for more information.

Click **Next >**. The *TV-on-Demand Initialization Wizard* appears. Follow the Wizard's instructions to set up a temporary file and allocate file space. Available time is indicated. The **Advanced Settings** button lets you customize settings for image quality and processor load.

Click **Next >**. The *End of Initialization Wizard* panel appears. Click **Finish** to complete TV setup.

### Sizing the TV display

You can resize the TV display using the mouse, the Maximize button, or CTRL key combination.

- The F2 key hides/shows the control panel, to save desktop space.



#### To resize the TV display using the mouse

Drag the display's border. The TV display maintains a fixed aspect ratio (width-to-height) of 4:3 to avoid picture distortion.



#### To display TV in full-screen

Press CTRL+F or ALT+F, or click the Maximize button. To return to the previous size, click  or press the **Esc** key.

#### Ctrl

#### To display preset sizes using the CTRL key

160 x120 pixels	CTRL+1
240 x180 pixels	CTRL+2
320 x240 pixels	CTRL+3
640 x480 pixels	CTRL+4
Toggle between full screen and current size	CTRL+F ALT+F
Increase size of display panel	CTRL + Up Arrow
Decrease size of display panel	CTRL + Down Arrow

## TV Control menu

You can access TV functions by right-clicking on the video viewing area or the control panel. This is very useful in full-screen mode. The following menu items are available:

<b>Setup</b>	Opens the TV setup page.
<b>Always On Top</b>	Displays TV on top of other applications.
<b>Hide Controls</b>	Hides the TV Control panel.
<b>Zooming</b>	Select zoom ratio ( <b>2x</b> , <b>4x</b> , or <b>8x</b> ) or <b>Unzoom</b> if already zoomed. See <a href="#">Zooming and panning</a> on page 30.
<b>Video Size</b>	Indicates the sizes available for the current panel: <b>160 x 120</b> <b>240 x 180</b> <b>320 x 240</b> <b>640 x 480</b> <b>Full Screen</b>
<b>Connector</b>	Specifies the video input: <b>TV Tuner</b> Selects TV Tuner input. <b>Composite</b> Selects composite video input. <b>S-Video</b> Selects S-Video input.
<b>Sound Mode</b>	Sets the audio mode: <b>Captions when muted</b> Displays closed captions when audio is muted. <b>Stereo</b> Enables stereo TV audio. <b>Mono</b> Enables monaural TV audio. <b>SAP</b> Enables the Secondary Audio Program.
<b>Closed Captions</b>	Specifies how closed-captioned text is displayed. You can also enable the Hot Words and TV Magazine features. See <a href="#">Hot Words™</a> on page 26 and <a href="#">TV Magazine</a> on page 28.
<b>About...</b>	Displays the About... dialog.
<b>Exit</b>	Closes TV.

## TV display settings

The Display settings page lets you control how video is displayed in TV.

### To open the Display settings page



Click the Setup button in the TV control panel, then click the **Display** tab.

<b>Screen Size</b>	Indicates the sizes available for the current panel. If the current panel does not support resizing, the values are greyed-out.
<b>Tool Tips</b>	<p><b>Show Tool Tip</b> Show helpful aids for using TV when you point at a control with your mouse.</p> <p><b>Show Shortcut</b> Show keyboard shortcuts when you point at a control with your mouse.</p>
<b>Display Feature</b>	<p><b>Video Desktop</b> When TV is minimized, TV display replaces your desktop pattern.</p> <p><b>Fixed Aspect Ratio</b> Click to preserve the width-to-height ratio when you resize or zoom the display.</p> <p><b>Crop Edges</b> Crop image edges to hide overscan noise.</p> <p><b>Always On Top</b> Display TV on top of other applications.</p> <p><b>Auto Hide Controls when in full screen</b> Hide TV controls when displaying TV in full screen.</p>
<b>Hide Player Hotkey</b>	Specify a keyboard key that hides/displays TV.
<b>Initialization Wizard</b>	Re-runs the Initialization Wizard. See <a href="#">Initialization Wizard</a> on page 13.



## TV video settings

The video settings page lets you choose a video connector and fine-tune video characteristics.

### To open the Video settings page



Click the Setup button in the Television control panel, then click the **Video** tab.

<b>Connector</b>	<p>Choose cable, composite or S-Video input.</p> <ul style="list-style-type: none"> <li>If you choose Composite or S-Video, you must specify the <b>Broadcast Standard</b>.</li> </ul>
<b>Broadcast Standard</b>	<p>Choose the broadcast standard: NTSC, PAL, or SECAM.</p>
<b>Video Properties</b>	<p><b>Color</b> Adjusts the amount of color in the image.</p> <p><b>Brightness</b> Adjust the amount of white in the image.</p> <p><b>Contrast</b> Adjusts the gradation of tones between light and dark areas.</p> <p><b>Tint</b> Adjusts the balance of red-to-blue in the image.</p> <ul style="list-style-type: none"> <li>Tint is not adjustable for PAL or SECAM.</li> </ul>

### TV Tuner settings

The tuner settings page lets you autoscans for active TV channels, choose cable or antenna input, name channels, and set channel-specific options.

#### To open the Tuner settings page



Click the Setup button in the TV control panel, then click the **TV Tuner** tab.

<b>Channel Name</b>	You can enter channel names
<b>Details...</b>	Select a channel, then click the <b>Details...</b> button to open the <b>Channel Property Details</b> page (see <a href="#">Channel Property Details</a> on page 18).
<b>Autoscan</b>	Scans for all active TV channels, and stores them when you click the <b>Set</b> button.
<b>Cable Standard</b>	Selects the country and cable or antenna.

### Channel Property Details

When you select a channel and then click the **Details...** button in the TV Tuner settings page, the Channel Property Details page opens to let you set properties for particular channels—favorites list, channel assignment, and properties for audio, video, program lockout, and closed captioning.

For example, in the Channel Specific Settings Video page, you could change a channel to SECAM when the other channels are (by default) PAL. In the Closed Captioning page you could enable a set of Hot Words specifically for a particular channel.

<b>Channel Name</b>	Type a name for the channel.
<b>Number</b>	Displays the channel number.
<b>Tunes to Station</b>	Specify the TV station that is received when you tune to a particular channel. For example, you could assign the actual channel 5 to the Television's channel 2. Autoscanning returns all channel assignments to normal (see <a href="#">Autoscan</a> on page 18).
<b>Channel in Favorite List</b>	Check to add the channel to the channels that TV receives when you click the channel up/down buttons). To remove a channel, uncheck it.
<b>Channel in Visual Selection List</b>	Check to add the channel to the Visual Selection list (see <a href="#">Channel Surfing</a> on page 23). To remove a channel, uncheck it.
<b>Channel Specific Settings</b>	<p><b>Audio</b> Click <b>Audio</b>, then click <b>Details...</b> to open the Sound details page.</p> <p><b>Mute Settings</b></p> <p><b>Global</b> Uses global settings for all channels.</p> <p><b>Mute On</b> Mutes selected channel.</p> <p><b>Mute Off</b> Cancels all muting.</p> <p><b>SAP Settings</b> see <a href="#">Secondary Audio Program (SAP)</a> on page 23.</p> <p><b>Global</b> Uses global settings for all channels that provide it.</p> <p><b>Stereo</b> Activates stereo audio for this channel, if it provides it.</p> <p><b>Mono</b> Activates monaural audio for this channel.</p> <p><b>SAP</b> Activates SAP for this channel.</p>

**Channel  
Specific  
Settings**

**Video**

Click **Video**, then click **Details...** to open the Channel Based Video Settings page. Move the sliders to change the values

**Color** Amount of color in the image.

**Brightness** Balance of light and dark in the image.

**Contrast** Gradation of tone between the image's highlights, midtones and shadows.

**Tint** Balance of red, green, and blue in the image.

**Broadcast Standard**

Choose the broadcast standard for this channel.

**Program Lockout**

Click **Program Lockout**, then click **Details...** to open the Program Lockout Settings page (see [Program Lockout](#) on page 32).

**Closed Captioning**

Click **Closed Captioning**, then click **Details...** to open the Closed Captioning Channel Settings page (see [Closed Captioning](#) on page 24).

## TV Stills Gallery settings

You can capture still images from TV, and save them in the Stills Gallery.

### To open the TV Stills Gallery settings page



Click the Setup button in the TV control panel, then click the **Stills Gallery** tab. For information on the Stills Gallery, see [Stills Gallery](#) on page 55.

## TV Schedule settings

The Scheduler lets you set up TV to watch or record selected TV programs at times you specify. If you have the features installed, you can also schedule events for CD Audio, TV Magazine, Digital VCR, and File Player.

### To open the Schedule settings page



Click the Setup button in the TV control panel, click the **Schedule** tab, then click the **Create New** button. The Schedule Wizard will guide you through creating new scheduled events. See [Schedule](#) on page 83 for details.

## ATI TV Bar

Browse the Web and watch TV at the same time, without resizing your windows! ATI TV Bar displays TV in your Internet Explorer Web Browser.

North American users can also view a display of channel names and numbers, with continuously updated program information.

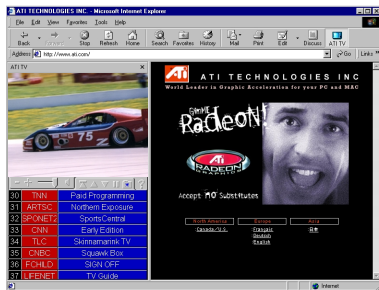

### To open ATI TV Bar

- 1 Launch Internet Explorer.
- 2 In Explorer's menu bar, click **View** ►, point to **Explorer Bar** ►, then click **ATI TV**.



Or click the ATI TV button in Explorer's menu bar.

- If TV is not running, ATI TV Bar opens it, and displays it in the TV Bar. Closing ATI TV Bar also closes TV.
- If TV is running, it is displayed in TV Bar, and the regular TV display disappears from your desktop. Closing TV Bar returns TV to its normal display on your desktop.
- If you resize Explorer, the TV display automatically fits itself to the new size.

### ATI TV Bar controls

From left to right, the ATI TV Bar controls are:

Channel down, Channel up, Volume, Mute, Go to top, Page up, Page down, Pause scrolling, Favorites, and Help.



## Channel Surfing

You can browse through several TV channels simultaneously, and select channels by clicking on “thumbnail” images (miniature representations) of the channels. Each thumbnail displays the channel number, and is regularly updated to display the current program.



- If any channel in the selection list is a locked-out channel (see *Program Lockout* on page 32), a password is required to access it. If a password is not entered, only unlocked channels are displayed.
- After an autoscan (see *Autoscan* on page 18), all detected channels are included in the selection list. A magnifying glass appears to the left of the lock-out icon. Click the magnifying glass button to add or remove the channel from the selection list.
- Most controls are disabled during Channel Surfing.

### To use Channel Surfing

- 1  Click the Channel Surf button in the TV control panel.  
*A grid of thumbnails appears over your TV display.*
- 2 Click the thumbnail for the channel you want to preview.  
*The channel you clicked becomes “live”, and plays video and audio for a few seconds.*
- 3 To select a channel for viewing, double-click a thumbnail.  
*The grid of thumbnails disappears, and the selected channel appears on your screen.*

## Closed Captioning

Display closed captioned text over video, like a standard TV, and/or in a separate window beside the video. When you use the separate window, you can use the scroll bar to review the last few minutes of text.

You can set the background color, the font, and the font color for the window.

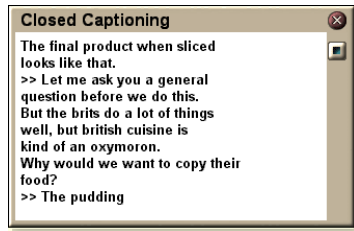

**Note** Closed-Captioning is only available in North America.

### To display closed-captioned text



Click the Closed Caption button in the TV control panel.



To close the Closed Captioning window, click the Exit button.

### Closed Caption settings

The Closed Caption settings page lets you specify how closed captioned text is displayed—over video or in a window—and the background color, the font, and the font color for the window. You can also set up and enable the HotWords and TV Magazine features.



## To set up closed captioning



Click the Setup button in the TV control panel, then click the **Closed Caption** tab.

<b>Placement</b>	<p><b>External Window</b> Displays closed captioned text in its own window. Click <b>Font...</b> to select the display font.</p> <p><b>Video Window</b> Displays closed captioned text superimposed on the video. Click <b>Font...</b> to select the display font.</p> <p><b>Solid Background</b> Displays closed captioned text on a solid background.</p> <p><b>Shaded Background</b> Displays closed captioned text on a shaded background.</p>
<b>HotWords</b>	<p><b>Enable</b> Check to enable HotWords when Closed Captioning is on (see <i>Hot Words™</i> on page 26).</p> <p><b>HotWords Setup</b> Opens the HotWords settings page.</p>
<b>TV Magazine</b>	<p><b>Enable</b> Activates TV Magazine (see <i>TV Magazine</i> on page 28.)</p> <p><b>TV Magazine Setup</b> Opens the TV Magazine Setup Wizard.</p>
<b>Closed Caption On Mute</b>	<p>Display closed captioned text when the audio is muted.</p>
<b>Show Alternate Text If Present</b>	<p>If T1 mode closed captioned data is present in the caption stream, checking this box displays a full page of T1 mode, scrollable, closed captioned text. If you turn off Closed Captioning or change channels, the page is hidden.</p>

### Hot Words™

Have your computer watch TV for you! When you turn on Closed Captioning, you can specify words and phrases that Television will detect in the closed-captioned text.

You can set Hot Words to show the matched text, restore TV, play a sound, enable TV Magazine, or enable the Digital VCR when the Hot Words appear. You can also have TV automatically transcribe the text when the specified words appear.

You can enable Hot Words, and then minimize TV; when the specified words occur, TV opens. You specify words using the Hot Words setup button in the Closed Caption settings page.

**Note** Hot Words is only available in North America.

## To set up Hot Words



Click the Setup button in the Television control panel, click **Closed Caption**, then click the **HotWords Setup** button. The HotWords Setup Wizard opens.

To enable HotWords, check the **Enable** box. The HotWords Setup Wizard will guide you through HotWords setup.

<b>First Word</b>	Type the first word to be matched.
<b>Match Type</b>	Choose the type of match you want: <ul style="list-style-type: none"> <li>• <b>By Itself</b> Notify when the First Word occurs.</li> <li>• <b>Followed by</b> Notify when the First Word occurs, and is immediately followed by the Optional Word you specify.</li> <li>• <b>Not Followed By</b> Notify when the First Word occurs, if it is <u>not</u> immediately followed by the Optional Word.</li> <li>• <b>In Sentence With</b> Notify when the First Word occurs, if it is in a sentence with the Optional Word.</li> </ul>
<b>Optional Word</b>	Type the word you want to match with the First Word. When you specify an Optional Word, the system only looks for the <b>First Word+Optional Word</b> combination.
<b>Partial</b>	Check this box to notify when a <u>part</u> of the First Word occurs.
<i>Use the <b>Add</b> and <b>Remove</b> buttons to add and remove words from the list.</i>	
Actions to take when your HotWords occur.	<p><b>Show Matched Text</b> Displays the text that matches your Hot Word(s).</p> <p><b>Restore Player</b> Opens Television in its current state.</p>
<b>Recording</b>	<p><b>Enable TV Magazine</b> Activates TV Magazine (see <a href="#">TV Magazine</a> on page 28).</p> <p><b>Enable Digital VCR</b> Activates the Digital VCR (see <a href="#">Digital VCR</a> on page 39).</p>

## TV Magazine

Use TV Magazine to transcribe closed captioned broadcasting, including pictures and text. You can save files as RTF (Rich Text Format), which preserves formatting, and can be used in many word processors, plain text (TXT), or Hypertext Markup Language (HTML). You can use the Schedule feature to start TV Magazine at dates and times you specify (see [Schedule](#) on page 83).

**Note**

- TV Magazine is only available in North America.
- When TV Magazine is enabled, it transcribes closed-captioned text even if the Closed Captioning button is off.

### To start TV Magazine



Click the Setup button in the Television control panel, click the **Closed Caption** tab, then click the **TV Magazine Setup** button.

To enable TV Magazine, check the **Enable** box. The first time you use TV Magazine, the TV Magazine Setup Wizard will guide you through the setup.

<b>File Name</b>	Type a name for the file.
<b>File Format</b>	Select a file format (RTF, TXT, or HTML).
<b>Options</b>	<p><b>Overwrite files</b> Check to overwrite existing files. Uncheck to keep existing files.</p> <p><b>Remove Advertising</b> Automatically skips commercial advertising when you display or transcribe closed-captioned text. It works best with programs that use scrolling transcripts rather than “text bubbles” to record closed-captioned text; for example: Talk shows, News broadcasts, Sports, and Soap operas.  (Depending upon the closed-captioning format, commercials may occasionally be recorded—a little experimentation will show you how to get the best results.)</p> <p><b>Case Conversion</b> Convert all characters to upper or lower case.</p>
<b>Stop Transcribing After</b>	Specify the number of minutes to transcribe.
<b>Select Layout</b>	<p><b>No image</b> No images are saved.</p> <p><b>Images on Left</b> Images are placed on the left, text on the right.</p> <p><b>Images on Right</b> Images are placed on the right, text on the left.</p> <p><b>Alternate images</b> Images and text alternate left and right.</p> <p><b>Use black &amp; white pictures</b> Save images as black &amp; white, to save disk space.</p> <p><b>Image Density</b> 1/page 2/page 4/page</p>

## Secondary Audio Program (SAP)

The Secondary Audio Program can be used to broadcast, for example, language translations, reading services for the visually impaired, weather forecasts, or information about a show.

**Note**

- Not all television stations broadcast stereo or SAP.
- SAP is not available in Japanese versions of TV.

### To hear the Secondary Audio Program



Right-click the Mute button in the Television control panel, and click **Sap** in the drop-down menu.

You can also use the menu to:

- Turn on captions when the audio is muted.
- Switch from stereo to mono.

## Zooming and panning

You can zoom in on the video in the Display panel to enlarge a selected portion of the screen, and return your display to normal. You can also pan (move the image horizontally and vertically) in the zoomed area.

### To zoom

Click within the display panel, then hold down the mouse button and draw a rectangle around the area you want to zoom.

 Or, right-click the 1:1 button to open a menu where you can set the zoom level— Zoom x2, Zoom x4, or Zoom x8.

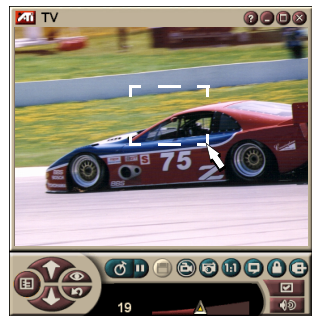

### To pan in the zoomed area

Move your mouse within the zoomed area to pan horizontally or vertically.

### To unzoom

Right-click in the display panel to open the control menu, point at **Zooming** ►, then click **Unzoom**, or

- 1. Click the 1:1 button in the control panel.

## Video Desktop

### To replace your desktop pattern with live TV display when you minimize TV

- 1. Click the Setup button in the Television control panel, click the **Display** tab, then check **Video Desktop**.

- 2. When you minimize Television, live TV display replaces your desktop.



A TV icon appears in the “tray” on the right side of

the Windows® taskbar.

Click the icon to display a small control panel that you can use to change channels and control the volume. Closed-captioned information is not displayed.



If you do not have a TV tuner, this control panel containing volume and mute controls is available.



### To restore your desktop pattern and TV

Click the **TV** button (or the **Video** button, if you have a Video-In card) in the Windows® taskbar.

## Program Lockout

Program Lockout lets you block particular programs at specific times, and set a password to unlock them. Use the Program Lockout page to specify channel, time, and duration.

### Note

- Passwords are **case-sensitive**. For example, PASSWORD, Password, and passWord are *not* the same.
- If you forget your password, you must uninstall and reinstall your TV software to view password-protected programs.

### To set program lockout

- 1  Click the Setup button in the Television control panel, then click the **TV Tuner** tab.
- 2 Click the channel you want, then click the **Details...** button.
- 3 Click **Program Lockout**, then click the **Details...** button.
- 4 Click **Create New**.

*The Program Lockout Wizard guides you through the lockout procedure.*



*In the channel list, locked-out channels have a padlock to the right of the channel name.*

### To remove program lockout

- 1  Click the Setup button in the Television control panel, then click the **TV Tuner** tab.
- 2 Click the channel you want to unlock, then click the **Details...** button.
- 3 Click **Program Lockout**, then click the **Details...** button.
- 4 Select the program you want to unlock.
- 5 Click the **Delete** button. To remove all program locks, click the **Delete All** button.
- 6 Click **OK**.



## Parental Control

Parental Control lets you restrict access to TV programs depending on their content rating. The video and audio of programs that you restrict will be scrambled until the correct password is entered.

### Note

- Parental Control is only available for North American (NTSC) Television.
- Passwords are **case-sensitive**, and must be at least **three characters** in length.
- If you forget your password, you must uninstall and reinstall your TV software.
- Parental Control is only available for computer systems that have a TV tuner.
- The capture still frames feature is disabled for scrambled programs, and video capture records only scrambled material.

### To use Parental Control



Click the Parental Control button in the Television control panel to display a menu of choices. The selected level is checkmarked.

- 1 Click the level you want.  
*The Set Password dialog appears.*
- 2 Type your password in the upper box, then type it in the lower box to confirm it.

The following table summarizes the FCC guidelines for Parental Control.

Programs designed solely for children	
TV-Y	This program is designed to be appropriate for all children.
TV-Y7	This program is designed for children age 7 and above.
Programs designed for the entire audience	
TV-G	General audience.
TV-PG	Parental guidance suggested.
TV-14	Parents strongly cautioned.
TV-MA	Mature audience only.

## Capturing Video and still images

**Full-motion video.** The Digital VCR lets you capture a clip of full-motion video plus audio from your video source and save it as an MPEG or AVI file on your computer's hard disk. See [Digital VCR](#) on page 39 for details.



**Still images.** Capture full-color, 24-bit-per-pixel, still images from television, and MPEG clips (see [Video CD](#) on page 61), save them, and print them. The images are placed in the Stills Gallery, which saves them as Windows-standard bitmaps (.bmp) or a wide variety of standard formats.



The Stills Gallery also supports most industry-standard graphics file formats, so you can insert the images into reports, presentations, letters, and other documents, to add impact to training applications and presentations. See [Stills Gallery](#) on page 55 for details.

**Note**

If the program is restricted by Parental Control, still capture is disabled (see [Parental Control](#) on page 33).

## Recording a clip of video and audio from TV

### To record a clip of video and audio



Click the Record button in the Television control panel.

*The Digital VCR starts recording video and audio to an MPEG or AVI file on your computer's hard disk. For information on specifying capture formats, see [Digital VCR settings](#) on page 40.*



To stop recording, click the Record button in the Digital VCR. A Save As dialog opens, so you can name and save the captured video.

**Note**

If the program is restricted by Parental Control, the recorded material is scrambled (see [Parental Control](#) on page 33.)

### To capture still frames from Television



Click the Camera button in the Television control panel. The current frame is placed in the Stills Gallery (see [Stills Gallery](#) on page 55).

**Note**

If the program is restricted by Parental Control, Still Capture is disabled (see [Parental Control](#) on page 33.)

## TV-on-Demand™

TV-on-Demand (“Time-Shifting”) is available if your graphics card supports it (for example, the ALL-IN-WONDER RADEON and the ALL-IN-WONDER 128 PRO). TV-on-Demand combines the immediacy of live TV with the storage and replay capability of a VCR to create a new way to watch and interact with TV.



**Live Pause.** With a mouse click, you can pause a live TV broadcast, and resume viewing the time-shifted video later, without missing any of the action.

**Instant Replay.** If you want to replay a sequence, you can back up the program, see what you missed, and then catch up to live programming. You can vary the playback speed or skip ahead by a pre-set number of seconds. You can also export time-shifted video as an MPEG (.MP2) file.

### Note

- Because TV-on-Demand records to your hard drive, you cannot use the Digital VCR in TV-on-Demand mode (see [Digital VCR](#) on page 39).
- You cannot time-shift copy-protected video sources.

### To view time-shifted video

 Click the TV-on-Demand button or the Pause button  in the TV control panel.

- When you click the Pause button, the TV control panel changes to the TV-on-Demand control panel, the last frame of video is displayed, and TV-on-Demand captures live video.



Live TV mode



TV-on-Demand mode

The TV control panel changes to the TV-on-Demand control panel, and time-shifted video is displayed.

- When you click the Play button , time-shifted video is displayed, continuing from where you paused.

**Note**

If you do not hear TV audio, see [Troubleshooting](#) on page 87.



**To return to live broadcasting**

 Click the Live TV button in the TV-on-Demand control panel. Video recording stops. To keep recording while you watch live TV, stay in TV-on-Demand mode and drag the slider to the right (see [To move within time-shifted video](#) on page 38).

**To play time-shifted video**

Click the Play button  in the TV-on-Demand control panel.

**To pause time-shifted video**

The Pause button  is displayed in live TV mode or in TV-on-Demand mode while time-shifted video is playing. When you click the Pause button, time-shifted video stops, a still image is displayed, and the Pause button changes to the Play button .

When you click the Play button, time-shifted video resumes playback, and the Play button changes to the Pause button.

**To change playback speed in time-shifted video**

 Click the Speed button to select playback speed: Slow Play (half-speed), Normal Play, and Fast Play (1.5x speed). Right-clicking the Speed button displays a menu of speeds.

- The Speed button is only enabled when you are in TV-on-Demand mode, but behind **Live**.

**To skip backwards and forwards in time-shifted video**

 Click the left button to skip back; click the right button to skip forward. The default settings are:

- Forward: 10 seconds
- Backward: 30 seconds

You can right-click the button to change the time settings to 10 seconds, 30 seconds, 1 minute, or two minutes.

### To move within time-shifted video



Drag the slider with your mouse. The time display indicates the position in the recorded video. As you move the slider all the way to the right, the time display indicates **Live**.

### To export time-shifted video



Click the Export button in the TV-on-Demand control panel. A dialog appears, where you can select the portion of time-shifted video you want to save (Range:), and the location to store it (Output File:). Exported video is saved in MP2 format.

You can export more quickly if you return to live broadcast mode first (but do not return to TV-on-Demand, or you will overwrite your previously-recorded video).

## Digital VCR

The Digital VCR provides simple controls and powerful capture options. You can capture a clip of full-motion video and audio from your video source and save it as an MPEG or AVI file. You can play captured files in the File Player (see [File Player](#) on page 78.) The Schedule feature lets you record TV programs on the dates and times you specify (see [Schedule](#) on page 83).



### Note

Because TV-on-Demand records to your hard drive, you cannot use the Digital VCR in TV-on-Demand mode (see [TV-on-Demand™](#) on page 36). Instead, use the Export function when you are in TV-on-Demand mode (see [To export time-shifted video](#) on page 38.)

### To start the Digital VCR

When you capture video (see [To record a clip of video and audio](#) on page 35) from TV, the Digital VCR opens automatically. If you want the Digital VCR to prompt you before recording, click the **Prompt before Recording** checkbox in the **Digital VCR** tab of the **TV Player Setup** page (see [Digital VCR settings](#) on page 40).

## Saving and compressing captured video

The Digital VCR Custom Settings... page lets you compress your captured video and save it in several industry-standard formats (see [Recording Quality](#) in [Digital VCR settings](#) on page 40). The quality of the video that you capture depends on the following conditions:

- speed of your system (CPU)
- amount of system memory (RAM)
- performance of your hard disk
- size of the video capture window
- Video codec (encoder-decoder) used

## Digital VCR settings

Use the Digital VCR settings pages to specify recording quality, duration, general options, and custom settings.

### To set up the Digital VCR



Click the Setup button in the TV control panel, then click the **Digital VCR** tab.

<p><b>Recording Quality</b></p>	<p>Check <b>Best Quality, Good Quality, Video CD</b> (see <i>Note</i>), or <b>Longest Time</b>. (The higher the quality, the less video you will be able to store on a disk.) For extremely fine control, click the <b>Set Custom</b> button to open the <b>Custom Settings</b> page, where you can create and modify preset capture formats.</p> <p>Click the <b>Create New...</b> button to create a new, preset capture format. The Capture Wizard guides you through the process.</p> <p>Click the <b>Edit...</b> button to modify an existing, preset capture format.</p> <ul style="list-style-type: none"> <li>• Step 2 of the Capture Wizard provides a <b>deinterlacing</b> option. Select it to prevent horizontal streaks in captured video.</li> </ul>
	<p><b>Note:</b> The <b>Video CD</b> setting lets you create Video-CD-compliant files that can be played on most consumer DVD players. To create a CD containing the Video CD files, you need a writeable CD drive and accompanying CD creation software.</p>
<p><b>Disk Space Settings</b></p>	<p>Allocates the amount of disk to store captured video.</p> <p><b>Record to Drive</b> Select the drive to hold captured video.</p> <p><b>Amount of disk space to leave free</b> Use the slider to set the amount of space to leave on your hard drive. Use this to prevent the recording from completely filling your drive.</p>
<p><b>Current Settings</b></p>	<p>Displays the video format, size, frame rate, and audio format for captured video.</p>
<p><b>Capture Still at 640 x 480</b></p>	<p>Capture still images in 640 x 480 pixel format.</p>



<b>Prompt Before Recording</b>	Do all capture setup, then display a dialog that starts capture.
<b>Record for</b>	Check the box, then type the number of hours and minutes you want to record.

## Real-time MPEG encoding

If your computer uses a Pentium® II, Pentium® III, Pentium® processor with MMX technology, or an AMD Athlon™ processor, you can capture video and save it in MPEG format, in real time.

The Digital VCR Custom Settings provide four, pre-set MPEG recording settings, as well as AVI, and you can customize video and audio settings for your particular purposes.

### To customize MPEG recording settings

#### Note

You should have a good understanding of MPEG before changing these settings. Of course, experimentation is a great teacher; if the results are not to your liking, simply click **Cancel** to return to the pre-set values.

- 1** Click the Setup  button in the TV control panel, then click the **Digital VCR** tab.
- 2** Click the **Set Custom...** button.  
*The Custom Settings page opens.*
- 3** Select the MPEG format you want to use.
  - To change preset values, click the **Edit...** button. The Capture Wizard will guide you through making changes.
  - To create a new capture format, click the **Create New...** button. The Capture Wizard will guide you through creating the new format.

## Achieving the best results with MPEG video capture

### To access MPEG properties

- 1 Click the setup button  in the Television control panel, then click the **Digital VCR** tab.
- 2 In **Recording Quality**, click the **Set Custom...** button.
- 3 Click **Best Quality**, then click the **Edit...** button.  
*Capture Wizard (Step 1) appears.*
- 4 Enter a name and description (if desired) for the preset.
- 5 Click **Next >**.  
*Capture Wizard (Step 2) appears.*
- 6 Select MPEG-1 or MPEG-2, then click **Next >**.  
*Capture Wizard (Step 3) appears*

### To select I-frame-only MPEG capture

This uses less CPU, but requires 2 to 3 times the bit-rate, which produces larger files.

- 1 Click the **I Frames Only** button.
- 2 Click **Next>**, then click **Finish**.

### To select I, B, P frame MPEG capture

This uses more CPU, but greatly reduces the bit-rate required to achieve good quality video.

- 1 In Capture Wizard (Step 3), set **Number of P Frames in Group** to **4**.
- 2 Set **Number of B Frames in Subgroup** to **2**.  
(Clicking the **Default** button sets the above values.)

To achieve full 29.97 frames/second capture performance in MPEG-1 or MPEG-2 format, we recommend the following settings. Example CPU speeds and bit rates (Mbps) are given, but note that some video compresses better than others, depending on the amount of rapid motion and the number of complex scenes.

Video Format	IBP Frames (Mbps)	Minimum CPU Required	I-Frame Only (Mbps)	Minimum CPU Required
160x120	1.0	P200-MMX	1.0	P200-MMX
352x240	1.5	PII-266	2.0	P200-MMX
320x480	3.0	PII-400	4.0	PII-266
640x480	4.0	Athlon 600	6.0	PIII-450
720x480	4.0	Athlon 700	6.0	PIII-450

**Mbps** = Megabits per second, or millions of bits per second.  
1 Mbps is approximately 125Kbytes/second.

- The motion estimation slider can be used to control the quality of the video – a high setting (75 or more) uses more CPU, but provides better quality video. A low setting (25 or less) speeds up encoding, but produces lower quality video at a given bit-rate.
- The above bit-rate settings are based on a motion estimation setting of 10.
- If your system is not capable of achieving smooth-looking video at 29.97, try the following:
  - Capture I frames only.
  - Capture using a smaller frame size.
  - Capture video only, with no audio.

MPEG-1 decoders are widely used, so video encoded in MPEG-1 format can be played on many PCs. However, MPEG-1 playback on a PC uses the Microsoft MPEG-1 decoder, which may not provide the best performance.

MPEG-2 playback on a PC requires an MPEG-2 decoder. With ATI graphics cards, MPEG-2 decoders use the ATI hardware IDCT and motion compensation, which provides higher resolution video playback and less CPU loading than the Microsoft MPEG-1 decoder.

## TV Listings



Gemstar's GUIDE Plus+™ is an electronic television programming guide for Microsoft Windows. It provides advanced program information, such as station names and numbers, as well as program names and details.

Before you use TV Listings for the first time, it is recommended that you complete the TV Initialization Wizard (see [Setting up TV](#) on page 13).

You can schedule recording and viewing sessions, search for programs, and maintain a list of your favorite shows. For more information, see the TV Listings Help.

### Note

- TV Listings is only available in North America.
- You need an internet connection to download the TV listings to your computer.



### To start TV Listings

Click the TV Listings button in the TV control panel, or click **TV Listings** in the LaunchPad.



### To access TV Listings information from TV

- When you Autoscan, TV Listings provides station names (see [Autoscan](#) in [TV Tuner settings](#) on page 18.)
- When you change channels, the current program name, and the station name and number are displayed.
- When watching TV, right-click the TV Listings button to get the following options:

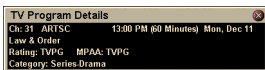

- **TV Program Details** If TV Listings has information about this program, it displays a panel containing detailed program information.
- **Auto Update** As time passes, or as you change channels, the TV Program Details panel updates its program information.
- **Copy** Check this to copy the TV Program Details panel's information into your Windows clipboard.

- Right-clicking in the text area of the TV Program Details panel also provides access to the **Auto Update** and **Copy** features.

**Note**

When you use TV Listings, the TV Control panel is hidden and the following features are unavailable:

- On-screen display of channel information.
- Resizing the Display panel (see [page 14](#)).
- Zoom and Pan (see [page 30](#)).
- Video Desktop is deactivated when you open TV Listings, and reactivated when you close TV Listings (see [page 31](#)).

TV Listings is unavailable when you use the following features:

- Channel Surf (see [page 23](#)).
- Video capture (see [page 34](#)).

## Setting up TV Listings

### Registration

The first time you launch the GUIDE Plus+ system, you will need to register. This allows you to download the listings for your area or cable service.

### To download updated listings

- 1** In the **File** menu, click **Download Weekly File ...**  
*The Download Assistant opens.*
- 2** Click the **Download** button to download the listings.  
To make changes, click the **Change Settings** button.

### To customize channels

The **Edit** menu contains two features related to the channel list:

- **Station Lists ...** lets you create and maintain a list of stations, based on the master list for your area or cable service.
- **Channel Number ...** lets you assign and maintain channel numbers for each station.

## Getting around

To navigate the various TV Listings views, click the tab for the view you want, or select the appropriate view from the **View** menu at the top of the screen.

Use the mouse or cursor keys to move within the current view. Left-click to select an item and display its details in the details window above the grid or log.

Right-click to open a pop-up menu with various options:

<b>Watch</b>	Adds the item to your <b>Watch</b> schedule (see <a href="#">Schedules tab</a> on page 51).
<b>Record</b>	Adds the item to your <b>Record</b> schedule (see <a href="#">Schedules tab</a> on page 51).
<b>Favorite</b>	Adds the item to your <b>Favorites</b> list (see <a href="#">Favorite search</a> on page 49).
<b>Program Details</b>	Opens a window that includes a detailed description of the program, as well as additional air dates.
<b>Go To</b>	Tunes the PIP (Picture-In-Picture—the window in the upper left corner of the guide where the TV picture is displayed) to the selected station.

## Recording

TV Listings works with your TV tuner to automatically record shows. When you select a program to record, a pop-up window appears, requesting a file name and location to save the file.



When you select a program for recording, the Record icon appears next to the title in any view where that program is displayed.



**Record**

- To remove a program from the Record Schedule, simply click the Record icon next to the program title.

## Viewing

TV Listings works with your TV tuner to automatically display shows. When you select a program for viewing, the Watch icon appears next to the title in any view where that program is displayed.



- To remove a program from the Watch Schedule, simply click the Watch icon next to the program title.

## Views

There are two, main views for the guide: **Grid** and **Log**.

**Grid view** displays 24 hours of listings in a table (similar to your newspaper or cable guide). Use the arrow keys to scroll up, down, left, or right. You can also scroll using the horizontal and vertical scroll bars.

- Scroll to a specific program to display its details in the area above the grid.
- To display just the stations you want, use the **Station Lists ...** option in the **Edit** menu (see *To customize channels* on page 45.)

**Log view** displays the data in a list, in the following order: Date/Station/Category and Title/Episode. Use the arrow keys to scroll up, down, left, or right. You can also scroll using the horizontal and vertical scroll bars.

- Scroll to a specific program to display its details in the area above the log.
- To display just the stations you want, use the **Station Lists ...** option in the **Edit** menu (see *To customize channels* on page 45.)

## Filter options



Click the Filter icon to open the Filter options dialog, where you can adjust the current view and quickly locate programs. Select the boxes you want to apply to the current view, and click **Close**.

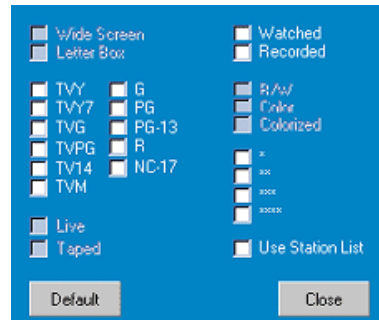

Select the **Use Station List** checkbox to apply the most recently customized station list.

## Actors tab

The Actors tab displays all actors and actresses starring in all the movies in the current listings. A list of actor names is displayed on the left of the screen. Click the name of the actor for whom you want to display all movies and show times.

- Use the arrow keys to scroll up and down in the Actors List.
- You can also type an actor's partial or full name in the textbox above the Actors List to quickly locate that actor.
- Scroll to a specific program to display its details in the area above the list.
- To display just the stations you want, use the **Station Lists ...** option in the **Edit** menu (see *To customize channels* on page 45).



## Categories tab

The Categories tab displays all genre categories in the current listings. A list of genre categories is displayed on the left of the screen.

- Click the category you want to view, to display all titles for that category on the right side of the screen.
- Double-clicking on categories with a + sign opens a list of sub-categories on the right side of the screen.
- Use the arrow keys to scroll up and down in the Categories List. You can also scroll using the horizontal and vertical scroll bars.
- Scroll to a specific program to display its details in the area above the log.
- To display just the stations you want, use the **Station Lists** option in the **Edit** menu (see *To customize channels* on page 45).

## Searches

GUIDE Plus+ comes with a powerful search engine to help you find the programs you want. You can save and maintain a list of custom searches to run each week, as well as a Favorites search that tracks your favorite shows and movies.

## Favorite search

Access the Favorite search under the **Searches** tab. Favorites are a special list of show titles that you keep and use to find your favorite shows with a mouse click. You can add and remove items from your favorites list from any view in the guide.

- Favorites is always the first search displayed in the Searches tab. It behaves like other searches, but it cannot be deleted.
- When one of your favorites appears in any view of the guide, 😊 appears in front of the title.

Typically, you use the favorites list to find your preferred shows when your data file is updated. Select the Favorites search from the list of searches, and the guide will look up and display all your favorite items. You can then select any or all of these items into your Schedule. You can set Favorites in two ways:

- In any view, select an event you want to place in your Favorites list. Right-click to open the **Event** menu, then select the **Favorite** option to toggle the item in or out of your Favorites list.
- In any list of events, three checkboxes appear in front of the event. The right checkbox is the Favorites indicator; click to toggle it.

### Movies tab

The Movies tab displays all movie sub-categories for all movies in the current listings, on the left side of your screen.

- Click the category you want to view; all titles for that category will be displayed on the right side of your screen.
- Use the arrow keys to scroll up and down in the Movies List. You can also scroll using the horizontal and vertical scroll bars.
- Scroll to a specific program to display its details in the area above the log.
- To display just the stations you want, use the **Station Lists ...** option in the **Edit** menu (see *To customize channels* on page 45).

## Schedules tab

A schedule is a list of TV events that you have selected in any view, including search results. The schedule is in the form of a Log View (see [page 47](#)). There are three lists you can choose from:

- **Watch** displays all events with at least the Watch indicator set.
- **Record** displays all events with at least the Record indicator set.
- **All** displays all events with either the Watch or Record indicator set.

In any view, when an event has been scheduled, an icon appears in front of the title, indicating whether the item is scheduled to watch, record, or both. Scheduled items can be added and removed in two ways:

- 1** In any view, select the event you want to place in your schedule, right-click to open the **Event** menu, then select **Watch** or **Record** to toggle the item in or out of your list of scheduled items.
- 2** In any list of events, three checkboxes appear in front of the event; the left checkbox is the Watch indicator, and the center checkbox is the Record indicator. Click either one to toggle it.

## Searches tab

The Searches tab displays a list of saved searches, including a list of personal Favorites (see [Favorite search](#) on page 49), which is always the first search in the list. The Search title is automatically updated when you click it.

- To create a new search, click the **Search** menu, then click **New Search**. The Search dialog opens.
- To edit a saved search, double-click the search title, or launch the Search dialog (as above), then click **Load Search**.

## Setting search parameters

To start a new search, in the **Search** menu, click **New Search ...** to open the Search dialog, which you can use to set the following options:

<b>Stations</b>	Select <b>All</b> or <b>None</b> using the appropriate buttons at the bottom of the list. To use selected stations, click the station names to highlight them.
<b>Program Categories</b>	Select <b>All</b> or <b>None</b> using the appropriate buttons at the bottom of the list. To use selected categories, click the category names to highlight them.
<b>Date/Time Ranges</b>	Use the pull-down items to select date ranges, and the check boxes to select the hours you wish to include in your search.
<b>Rating</b>	Highlight one or more entries in this list to search for movies with specific quality ratings.
<b>MPAA</b>	Highlight one or more entries in this list to search for movies with specific MPAA ratings.
<b>Parental Guidance</b>	Highlight one or more entries in this list to search for movies with specific ratings.
<b>Text Search</b>	Enter names, titles, and/or keywords in the text box. Check the <b>Title</b> , <b>Desc</b> , and/or <b>Performers</b> boxes to search the appropriate fields for the text.
<b>Year of Release</b>	Use the pull-down items to search for movies before, after, or within specific years.

Use the icons at the top of the Search dialog to:

- Create a new search
- Load an existing search
- Save the current search criteria
- Run the current search
- Exit the search dialog

## Sports tab

The Sports tab displays all sports sub-categories for all sporting events in the current listings, on the left side of your screen. Click the category on the left side of the screen for which you want to display all titles. Titles will appear on the right side of the screen.

- If you have the **Use Station List** checkbox in the Filter options checked (see *Filter options* on page 48), only those stations in the currently-selected station list are displayed.
- Use the arrow keys to scroll up, down, left, or right. You can also scroll using the horizontal and vertical scroll bars.
- Scroll to a specific program to display its details in the area above the log.
- To display just the stations you want, use the **Station Lists ...** option in the **Edit** menu (see *To customize channels* on page 45).

## Stations tab

The Stations tab displays listings for each station, on the left side of your screen. Click the station you want, or use the arrow keys to move up or down the list. The listings for that station are displayed on the right side of your screen.

There are two ways to view listings in the Stations tab. You control how the listings are displayed via the Stations tab **Format** option:

- 1 Log view** is the standard view. Each station is shown in its own, rolling log.
  - 2 Grid view** can be activated from the **Grid Mode** option of the **View** menu (see *Views* on page 47). Each station is shown as a 24-hour grid.
- Use the arrow keys to scroll up or down. You can also scroll using the horizontal and vertical scroll bars.

- Scroll to a specific program to display its details in the area above the list.
- To display just the stations you want, use the **Station Lists** option in the **Edit** menu (see *To customize channels* on page 45).

### Titles tab

The Titles tab displays all titles in the current listings, on the left side of your screen. Click a title to display all show times for that title, on the right side of your screen.

- Use the arrow keys to scroll up or down. You can also type a partial or full Title name in the textbox above the Title list, and quickly jump to a particular title.
- Scroll to a specific program to display its details in the area above the log.
- To display just the stations you want, use the **Station Lists ...** option in the **Edit** menu (see *To customize channels* on page 45).

### Days and dates

Each view contains listings for the current date. To change the date, select the date you wish to view from the **Dates** menu at the top of the screen.

## Stills Gallery

The still images you capture from TV, Video CD, or File Player are saved in the Stills Gallery. You can save images in a variety of graphics formats and sizes. The Stills Gallery controls let you delete images, hide them, save them as wallpaper, and print them.

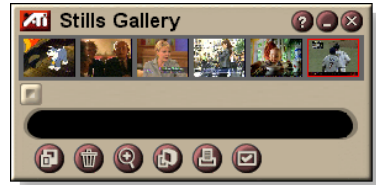
**Note**

If you close the Stills Gallery without saving, your captured still images are **deleted**.

When you click the logo in the upper left corner of the Stills Gallery, the “About...” notice appears. If you have more than one feature installed, a Task menu displays available and active features.

*For information about using the Stills Gallery controls, see the online help and Tool Tips.*

## Stills Gallery settings

Use the Stills Gallery Setup page to define how the Stills Gallery saves and prints captured images.

### To set up the Stills Gallery



Click the Setup button in the Stills Gallery, TV, File Player, or Video CD control panel, then click the **Stills Gallery** tab.

<p><b>Capture Options</b></p>	<p><b>Capture to Gallery</b> Captures still images to the Stills Gallery.</p> <p><b>Capture to numbered file</b> Stores captured images in numbered files (pic001.bmp, pic002.bmp ...) on your hard disk.</p> <p><b>Capture to clipboard</b> Places captured images on the Windows Clipboard.</p> <p><b>Capture to printer</b> Send the captured image to the printer.</p> <p><b>Use only 256 colors</b> Saves captured images as 256-color files, to save disk space.</p>						
<p><b>Save Options</b></p>	<p><b>Warn if closed without saving</b> Alerts you if you close Television or the Stills Gallery without saving captured images.</p> <p><b>Show paths of saved images</b> Displays the drive, folders, and subfolders that contain saved images.</p>						
<p><b>Tool Tips</b></p>	<p><b>Show Tool Tips</b> Display tool tips for the Stills Gallery controls.</p> <p><b>Show Short Cut</b> Display shortcut keys for the Stills Gallery controls.</p>						
<p><b>Always on top</b></p>	<p>Keep the Stills Gallery on top of other applications.</p>						
<p><b>Print Options</b></p>	<p><b>Center image</b> Print image in center of page.</p> <p><b>Image size:</b></p> <table border="0"> <tr> <td>Maximize</td> <td>Print in full-page format.</td> </tr> <tr> <td>One to one</td> <td>Print same size as original.</td> </tr> <tr> <td>Double</td> <td>Print twice original size.</td> </tr> </table>	Maximize	Print in full-page format.	One to one	Print same size as original.	Double	Print twice original size.
Maximize	Print in full-page format.						
One to one	Print same size as original.						
Double	Print twice original size.						



## CD Audio

Use CD Audio to play standard audio CDs.

Advanced features such as Random play, Intro play (which plays the first ten seconds of each track) and

Loop play are available. The Schedule feature lets you schedule CD playback on dates and times you specify (see [Schedule](#) on page 83).



When you click the logo in the upper left corner of the display panel, the “About...” notice appears. If you have more than one feature installed, a Task menu displays available and active features.

*For information about using CD Audio controls, see the online help and Tool Tips.*

### To start CD Audio

#### from LaunchPad



Click CD Audio in the Launchpad. For information on LaunchPad, see [page 8](#).

#### from Windows® taskbar

- 1 In the Windows taskbar, click **Start**.
- 2 Point at **Programs** ▶.
- 3 Point at **ATI Multimedia Center** ▶.
- 4 Click **CD Audio**.

 You can also start CD Audio from other Multimedia Center features—DVD, Video CD, TV, and File Player. Click the ATI logo in the upper left corner of the feature’s control panel, then click **CD Audio**.

## CD Audio settings

Use the CD Audio Settings page to set up playlists and shuffle play, and to use an LCD panel for track number and playback time.

### To set up CD Audio



Click the Setup button in the CD Audio control panel, then click the **CD Audio Settings** tab.

<b>Play List</b>	Displays all tracks in the playlist (the list of your selections).
<b>Shuffle Play</b>	<p><b>Shuffle all tracks</b> Play all tracks in random order.</p> <p><b>Shuffle user playlist</b> Play playlist in random order.</p>
<b>Disc Information</b>	If the information is available, displays the name of the disc and the artist. You can also type in the information.
<b>Available Tracks</b>	Displays the tracks that you can add to the playlist. Use the buttons to add or remove selected tracks or all tracks.
<b>LCD Display</b>	Check to display track number and current playback time on an LCD display.
<b>Tool Tips</b>	<p><b>Show Tool Tips</b> Display tool tips when you point at a control with your mouse.</p> <p><b>Show Shortcut</b> Display keyboard shortcuts when you point at a control with your mouse.</p>

## CD Database

If you are connected to the Internet, you can use the CD Database to display album title, artist, song names, and other information on your computer as your CD plays.

When you put an audio CD in your CD-ROM drive, the CD Audio program can query a global CDDDB<sup>®</sup> server for information about the disk. If the database contains information for your disk, CD Audio downloads and displays the data.

- Access to the CDDDB service is free of charge to end-users.

### To open the CD Audio CD Database page



Click the Setup button in the CD Audio control panel, then click the **CD Database** tab.

<p><b>Server</b> Address of CDDDB server (default: cddb.cddb.com)</p>	<p><b>Port</b> Port to use with this CDDDB server (default: 8880).</p> <p><b>Get Sites List from Server</b> Get sites list from server using current settings.</p>
<p><b>Protocol</b></p>	<p><b>CDDBP</b> Use direct TCP/IP connection.</p> <p><b>HTTP</b> Use the HTTP connection if you are behind a firewall. A CGI script must be defined (default: /-cddb/cddb.cgi)</p>
<p><b>Proxy Server</b> Access the database using a proxy server</p>	<p><b>Server</b> Address of proxy server (a proxy server is another computer on your LAN that connects to the Internet without compromising the security of your network).</p> <p><b>Port</b> Port to use with proxy server.</p> <p><b>Requires Proxy Authentication</b> This proxy server requires authentication.</p>

**Dial-Up Networking**

Use dial-up networking when accessing the server.

**Use this connection when making remote queries**

When not connected, connect using this entry.

**Only perform remote queries when connected**

Access the database only when already connected.

**Disable CD Database**

No queries are performed when this box is checked.

## CD Audio Schedule settings

You can schedule CD Audio to play on the dates and times you specify. If you have the features installed, you can also schedule events for TV Magazine, Digital VCR, File Player, and TV.

### To open the CD Audio Schedule settings page



Click the Setup button in the CD Audio control panel, then click the **Schedule** tab. The Schedule Wizard will guide you through creating new scheduled events. See [Schedule](#) on page 83 for details.

## Video CD

Video CD plays Video CD 1.0 CDs and Karaoke CDs.

When you click the logo in the upper left corner of the display panel, the “About...” notice appears. If you have more than one feature installed, a Task menu displays available and active features.

*For information about using Video CD controls, see the online help and Tool Tips.*



### To start Video CD

#### from LaunchPad



Click **Video CD** in the Launchpad. For information on LaunchPad, see [page 8](#).

#### From Windows® taskbar

- 1 In the Windows taskbar, click **Start**.
- 2 Point at **Programs** ▶.
- 3 Point at **ATI Multimedia Center** ▶.
- 4 Click **Video CD**.

 You can also start Video CD from other Multimedia Center features—TV, CD Audio, File Player, and DVD. Click the ATI logo in the upper left corner of the feature’s control panel, then click **Video CD**.

## Video CD Control menu

You can access Video CD functions by right-clicking on the video viewing area or the control panel. This is very useful in full-screen mode. The following menu items are available:

<b>Setup</b>	Open the Video CD setup page.
<b>Eject CD</b>	Eject the video CD from the drive.
<b>Play</b>	Play the loaded Video CD.
<b>Pause</b>	Pause playback.
<b>Stop</b>	Stop playback.
<b>Display Size</b>	<b>50%</b> Display video at 1/2 size.
	<b>75%</b> Display video at 3/4 size.
	<b>100%</b> Display video full size.
	<b>200%</b> Display video at double size.
	<b>Full Screen</b> Display video in full screen, no borders.
<b>Show Controls</b>	Display the Control panel.
<b>Audio Channels</b>	Click to select audio tracks for dual-mode MPEG CDs:
	<b>Stereo</b> Stereo audio playback.
	<b>Both Channels</b> Both audio channels active.
	<b>Left Channel</b> Left channel audio only.
	<b>Right Channel</b> Right channel audio only.
<b>Movie Scale</b>	<b>Show Time</b> Display scale in time.
	<b>Show Frames</b> Display scale in frames.
	<b>Time Remaining</b> Display time remaining in current CD.
	<b>Total Time</b> Display total time of current CD.
<b>Zoom</b>	<b>Unzoom</b> Return to normal display.
	<b>Zoom 2x</b> Zoom to double size.
	<b>Zoom 4x</b> Zoom to 4 times size.
	<b>Zoom 8x</b> Zoom to 8 times size.
<b>About...</b>	Display the About... dialog.
<b>Exit</b>	Close the Video CD program.

## Capturing still frames from Video CDs

### To capture still frames from Video CDs



Click the Camera button in the Video CD control panel. The current frame is placed in the Stills Gallery (see *Stills Gallery* on page 55).

## Zooming and Panning

You can zoom in on the video in the Display panel to enlarge a selected portion of the screen, and return your display to normal.

### To zoom in

Click within the display panel, then hold down the mouse button and draw a rectangle around the area you want to zoom.



 Or, right-click the 1:1 button to open a menu where you can set the zoom level— Zoom x2, Zoom x4, or Zoom x8.

### To pan in the zoomed area

Move your mouse within the zoomed area.

### To zoom in the zoomed area

Hold down the Shift key, and draw another rectangle in the zoomed area.

### To unzoom or use predefined zoom levels

Right-click in the display panel to open the Control Menu (see *Video CD Control menu* on page 62), then click Zoom, and select Unzoom, Zoom x2, Zoom x4, or Zoom x8.

 Or, click the 1:1 button to unzoom, or right-click the button to open a menu where you can set the zoom level — Zoom x2, Zoom x4, or Zoom x8.

## Video CD Display settings

Use the Video CD Display settings pages to set up video size and general operation.

### To open the Video CD Display settings page



Click the Setup button in the Video CD control panel, then click the **Display** tab.

<b>Video Size</b>	Choose playback size: 50%, 75%, 100%, 200%, or Fullscreen.
<b>Tool Tips</b>	<b>Show Tool Tips</b> Show tool tips when you point at controls with your mouse. <b>Show Shortcuts</b> Show keyboard shortcuts when you point at controls with your mouse.
<b>Always on top</b>	Keep Video CD on top of other applications.
<b>Keep Aspect Ratio</b>	Maintain the width-to-height ratio when you resize or zoom the display.
<b>Autohide Controls in Full screen</b>	Automatically hide Video CD controls when playing full-screen.



## Video CD Preferences settings

Use the Video CD Preferences settings page to set up general characteristics for your player.

### To open the Video CD Preferences settings page



Click the Setup button in the Video CD control panel, then click the **Preferences** tab.

<b>Movie Scale</b>	<p><b>Show Frames</b> Display scale in frames.</p> <p><b>Show Time</b> Display scale in time.</p> <p><b>Show Total Time</b> Display the total time of the playing video CD or file.</p> <p><b>Show Time Remaining</b> Display the remaining time in the playing video CD or file.</p>
<b>General Settings</b>	<p>Automatically play a loaded CD.</p>
<b>Power Management</b>	<p>Select one of the following levels:</p> <p><b>Always</b> Power management always enabled.</p> <p><b>Disabled while playing</b> Power management is disabled while a CD is playing.</p> <p><b>Allow display to turn off while paused</b> Only the display turns off when playback is paused.</p> <p><b>Disabled</b> Power management is never enabled.</p>

## Video CD Stills Gallery settings

You can capture still images from Video CDs, and save them in the Stills Gallery.

### To open the Video CD Stills Gallery settings page



Click the Setup button in the Video CD control panel, then click the **Stills Gallery** tab. For information on the Stills Gallery, see [Stills Gallery](#) on page 55.

## DVD

DVD (Digital Versatile Disc) is a high-density format that provides as much as 17 Gigabytes of storage—25 times more than a CD-ROM. This vastly increased capacity lets you view a full-length movie or play games that used to require multiple CDs.



Many DVD titles provide new viewing capabilities: interactive menu selection, multiple languages, foreign-language subtitles, multiple viewing angles, and more. New video and audio technologies such as MPEG-2 video compression give you a higher level of multimedia video and audio experience.

When you click the logo in the upper left corner of the display panel, the “About...” notice appears. If you have more than one feature installed, a Task menu displays available and active features.

*For information about using the DVD controls, see the online help and Tool Tips.*

### To start DVD



#### from LaunchPad

Click **DVD** in the Launchpad. For information on LaunchPad, see [page 8](#).

#### from Windows® taskbar

- 1 In the Windows taskbar, click **Start**.
- 2 Point at **Programs** ►.
- 3 Point at **ATI Multimedia Center** ►.
- 4 Click **DVD**.



You can also start DVD from other Multimedia Center features installed on your system—TV, Video CD, File Player, and CD Audio. Click the ATI logo in the upper left corner of the feature's control panel, then click **DVD**.

## What can I play on my DVD drive?

You can play all video discs that conform to the DVD Video Disc 1.0 specification, including encrypted (copy-protected) and interactive titles.

## Sizing the Video Display panel

You can resize the video display panel by using your mouse to drag an edge, and you can use the CTRL key to display these preset screen sizes:

50% of original size.	CTRL+1
75% of original size.	CTRL+2
100% of original size.	CTRL+3
Full-screen	CTRL+4 CTRL+F

## Full-screen controls

When you play DVD discs in



full-screen mode, the player controls appear at the bottom of your screen. You can use the following keys to return to windowed video, and hide or show the on-screen controls.

Ctrl + F	Exit full-screen mode.
F2	Hide / Show the on-screen controls.

## Playing DVD Video Disks

All DVD players and drives will read **audio CDs** and **CD-ROMs**, and play music from **Enhanced CDs** (CD Plus, CD Extra).

### To play DVD discs

Place a DVD disk in your DVD drive, then click the Play DVD button in the File Open dialog.

## Selecting audio streams



When you view a standard DVD Video disc that has multiple audio streams, clicking the audio channel button displays a pop-up menu of available audio streams. The currently-playing channel is checkmarked.

- All DVD Video Discs support up to eight audio channels.

## Setting up sub-titles



Click the sub-title selection button in the DVD control panel to display a menu of sub-title language choices. Click the language you want for sub-titles. The selected language is checkmarked.

- All DVD Video Discs support up to thirty-two sub-title languages.

## Using the menus



Click the Menu button in the DVD control panel. A pop-up “menu of menus” opens, where you can select a menu to jump to. Standard DVD Video Discs provide up to six menus:

- Title (usually, a whole movie or album)
- Root
- Audio
- Sub-picture (sub-pictures overlay the video, and are used for sub-titles, karaoke, menus, simple animation, etc.).
- Angle
- Chapter

## Searching DVD disks

DVD Video Disc content consists of “titles” (movies or albums), and “parts of titles” (chapters or songs). Use Search to go to a specific location on the disc.



Click the Search button in the DVD control panel to open the search dialog. You can search DVD discs for:

- Title (usually a whole movie)
- Title and Chapter (a Chapter is part of a Title).
- Time within the current Title and Chapter in HH:MM:SS:FF format: HH=hour, MM=minute, SS=second, FF=frame).

## Selecting viewing angle



Click the Angle button in the DVD control panel to display a menu of camera angles. The selected angle is checkmarked.

- Not all DVD Video Discs support multiple viewing angles; the DVD content must be encoded with multiple viewing angles for this feature to be active.

## Parental Control



Parental Control lets you restrict access to selected material by requiring password access. Click the Parental Lockout button in the DVD control panel to display a menu of parental level choices. The selected level is checkmarked.

- When a parental level is selected, a password dialog appears. A password is required to change parental levels.

## Zooming and Panning

You can zoom in on the video in the Display panel to enlarge a selected portion of the screen, and return your display to normal.

### To zoom in

Click within the display panel, then hold down the mouse button and draw a rectangle around the area you want to zoom.



 Or, right-click the 1:1 button to open a menu where you can set the zoom level— Zoom x2, Zoom x4, or Zoom x8.

### To pan in the zoomed area

Move your mouse within the zoomed area.

### To zoom in the zoomed area

Hold down the Shift key, and draw another rectangle in the zoomed area.

### To unzoom or use predefined zoom levels

Right-click in the display panel to open the Control Menu (see [DVD Control menu](#) on page 72), then click Zoom, and select Unzoom, Zoom x2, Zoom x4, or Zoom x8.

 Or, click the 1:1 button to unzoom, or right-click the button to open a menu where you can set the zoom level — Zoom x2, Zoom x4, or Zoom x8.

## DVD Control menu

As well as using the control panel buttons, you can access DVD functions by right-clicking on the video viewing area or the control panel. This is very useful when you play files in full-screen mode. The following menu items are available:

<b>Setup</b>	Opens the Preferences page.
<b>Hide controls</b>	Hides the full-screen controls (see <a href="#">Full-screen controls</a> on page 68).
<b>Eject</b>	Ejects the DVD disc from the drive.
<b>Resume</b>	Continues play, after pausing
<b>Play/Pause</b>	Toggles between play and pause.
<b>Stop playing</b>	Stops play.
<b>Play at specific part</b>	Search for a specific location on the disc (see <a href="#">Searching DVD disks</a> on page 70).
<b>Restart program</b>	Starts play at the beginning of the file.
<b>Go Up</b>	Goes up in a playlist.
<b>Menu</b>	Displays a “menu of menus” (see <a href="#">Using the menus</a> on page 70).
<b>Subtitle</b>	Displays a menu of subtitle language choices (see <a href="#">Setting up sub-titles</a> on page 69).
<b>Audio</b>	Displays a menu of audio streams (see <a href="#">Selecting audio streams</a> on page 69).
<b>Angle</b>	Displays a menu of camera angles (see <a href="#">Selecting viewing angle</a> on page 70).
<b>Parental Control</b>	Displays a menu of parental level settings.
<b>Search</b>	Search for any title or chapter.
<b>Zoom</b>	Zoom 2x, 4x, 8x, Unzoom.
<b>About...</b>	Displays the About... dialog.
<b>Exit</b>	Closes DVD.



## DVD display settings

The Display settings page lets you control how video is displayed in DVD.

### To open the Display settings page



Click the Setup button in the DVD control panel, then click the **Display** tab.

<b>Display Size</b>	Display video at 50%, 75%, 100%, or full screen.
<b>Layout Preference</b>	<p>If the DVD video disc contains the appropriately formatted content, DVD video can be displayed with a width-to-height ratio of 4:3 (standard TV shape) or 16:9 (widescreen).</p> <p><b>Wide screen</b> Displays the full image with a width-to-height ratio of 16:9 (for wide-screen TVs).</p> <p><b>Letterbox</b> Displays the image with top and bottom borders (in 4:3 format, for a shorter but full-width image).</p> <p><b>Pan Scan</b> Displays a 16:9 image formatted to fit a standard 4:3 screen; the image is full-height and 75% of the full width.</p>
<b>Options</b>	<p><b>Keep Aspect Ratio</b> Maintains the aspect ratio (width-to-height ratio) when you resize the display.</p> <p><b>Always on Top</b> Always displays the player on top of other windows.</p> <p><b>Auto Hide in Full Screen</b> Automatically hides controls in full-screen mode if no user interaction occurs. Controls automatically re-appear if you move the mouse.</p>
<b>Tool Tips</b>	<p><b>Show Tool Tips</b> Displays helpful aids for using DVD.</p> <p><b>Show Shortcut</b> Displays shortcut keys.</p>

## DVD Preferences settings

The Preferences settings page lets you control how video is displayed in DVD.

### To open the Display settings page



Click the Setup button in the DVD control panel, then click the **Preferences** tab.

<b>Preferred Language</b>	<p>Select a 1st choice and a 2nd choice for your preferred language.</p> <ul style="list-style-type: none"> <li>• DVD automatically selects the audio stream and subtitles to match the 1st choice.</li> <li>• If the 1st choice is not available, the 2nd choice is used.</li> <li>• If neither 1st or 2nd choice is available, the player uses the first available audio and sub-picture stream.</li> <li>• You can use the Sub-titles button to change languages during playback (see <a href="#">Setting up sub-titles</a> on page 69).</li> </ul>
<b>Power Management</b>	<p>Select one of the following levels:</p> <ul style="list-style-type: none"> <li>• <b>Always</b> (power management always enabled).</li> <li>• <b>While not playing</b></li> <li>• <b>Display to turn off while paused</b> (only the display turns off when playback is paused).</li> <li>• <b>Never</b></li> </ul>
<b>Enable Subtitles Always</b>	<p>Always display subtitles.</p>
<b>Show Subtitles When Muted</b>	<p>Display subtitles whenever the audio is muted.</p>

## DVD Video settings

The Display Settings page lets you adjust video characteristics. Your hardware will determine which settings are available.

### To open the DVD Video settings page



Click the Setup button in the DVD control panel, then click the **Video** tab.

<b>Brightness</b>	Adjusts the intensity of light in your display.
<b>Gamma</b>	Adjusts the color brightness of your display. The higher the gamma, the higher the brightness and contrast, with maximum being a flat (unmodified) setting.
<b>Saturation</b>	Adjusts the richness of color (determined by the amount of grey in a color) in your display.

## DVD Closed Captioning

Display closed captioned text over video, and/or in a separate window beside the video. When you use the separate window, you can use the scroll bar to review the last few minutes of text. You can set the background color, the font, and the font color for the window.

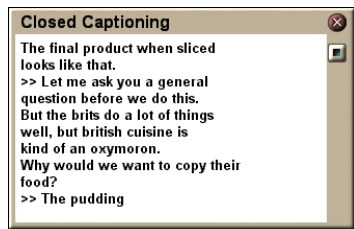

**Note** Closed-Captioning is only available in North America.

### To display closed-captioned text



Click the Closed Caption button in the DVD control panel.



To close the Closed Captioning window, click the Exit button.

## Closed Caption settings

The Closed Caption settings page lets you specify how closed captioned text is displayed—over video or in a window—and the background color, the font, and the font color for the window.

### To set up closed captioning



Click the Setup button in the DVD control panel, then click the **Closed Caption** tab.

<b>Placement</b>	<b>External Window</b> Displays closed captioned text in its own window. Click <b>Font...</b> to select the display font.
	<b>Video Window</b> Displays closed captioned text superimposed on the video. Click <b>Font...</b> to select the display font.
	<b>Solid Background</b> Displays closed captioned text on a solid background.
	<b>Shaded Background</b> Displays closed captioned text on a shaded background.
<b>Closed Caption On Mute</b>	Display closed captioned text when the audio is muted.

## DVD Schedule settings

If you have the features installed, you can schedule events for TV Magazine, Digital VCR, File Player, and TV.

### To open the DVD Schedule settings page



Click the Setup button in the DVD control panel, then click the **Schedule** tab. The Schedule Wizard will guide you through creating new scheduled events. See [Schedule](#) on page 83 for details.

## Region codes

There are six region codes, or “country codes”, which are used to prevent playback of certain discs in certain geographical regions. DVD players will not play discs that are not allowed in the region.

If you insert a DVD disc whose region code is different from the currently-set value, a dialog appears where you can change the region code for your location.

<b><i>You can only change Region Codes five times.</i></b>	
<b>Region 1</b>	The U.S., U.S. territories and Canada.
<b>Region 2</b>	Europe, Japan, the Middle East, Egypt, South Africa, Greenland.
<b>Region 3</b>	Taiwan, Korea, the Philippines, Indonesia, Hong Kong.
<b>Region 4</b>	Mexico, South America, Central America, Australia, New Zealand, Pacific Islands, Caribbean
<b>Region 5</b>	Russia, Eastern Europe, India, most of Africa, North Korea, Mongolia.
<b>Region 6</b>	China

## File Player

Use the File Player to play various multimedia file formats. The types of file you can play depends on your system's software. For example, MPEG-2 file playback is available if software such as ATI's DVD Player is installed.

You can play the following, multimedia files:

- AVI
- MPEG (.mpg, .mpeg)
- MP (.mp3, .mp2)
- MIDI (.mid)
- WAV (.wav)



*For information about using File Player controls, see the online help and Tool Tips*

### To start File Player

#### *from LaunchPad*



Click **File Player** in the Launchpad. For information on LaunchPad, see [page 8](#).

#### *from Windows® taskbar*

- 1** In the Windows taskbar, click **Start**.
- 2** Point at **Programs** ►.
- 3** Point at **ATI Multimedia Center** ►.
- 4** Click **File Player**.

## File Player Control menu

You can access File Player functions by right-clicking on the video viewing area or the control panel. This is very useful when you play files in full-screen mode. The following menu items are available:

<b>Setup</b>	Open the File Player Setup page.
<b>Hide/Show Controls</b>	Hide the File Player Control panel.
<b>Play</b>	Play the current file.
<b>Stop</b>	Stop playing.
<b>Time display mode</b>	<b>Set time mode:</b> Elapsed Time Remaining Time Total Time
<b>Zoom Mode</b>	<b>Set Zoom:</b> Unzoom, Zoom 2x, Zoom 4x, Zoom 8x.
<b>Video Size</b>	<b>Set playback size:</b> 50%, 75%, 100%, 200%, Full Screen.
<b>About...</b>	Displays the "About" dialog.
<b>Exit</b>	Closes the File Player.

## Zooming and Panning

You can zoom in on the video in the Display panel to enlarge a selected portion of the screen, and return your display to normal.

### To zoom in

Click within the display panel, then hold down the mouse button and draw a rectangle around the area you want to zoom.

 Or, right-click the 1:1 button to open a menu where you can set the zoom level— Zoom x2, Zoom x4, or Zoom x8.



### To pan in the zoomed area

Move your mouse within the zoomed area.

### To zoom in the zoomed area

Hold down the Shift key, and draw another rectangle in the zoomed area.

### To unzoom or use predefined zoom levels

Right-click in the display panel to open the Control Menu (see [File Player Control menu](#) on page 79), then click Zoom, and select Unzoom, Zoom x2, Zoom x4, or Zoom x8.

 Or, click the 1:1 button to unzoom, or right-click the button to open a menu where you can set the zoom level — Zoom x2, Zoom x4, or Zoom x8.



## File Player Display settings

The Display settings page lets you control how video is displayed in the File Player.

### To open the Display settings page



Click the Setup button in the File Player control panel, then click the **Display** tab.

<b>Video Size</b>	Display video at 50%, 75%, 100%, 200%, or full screen.
<b>Options</b>	<p><b>LCD Display</b> Display track number and current playback time on an LCD display.</p> <p><b>Always on Top</b> Always display File Player on top of other applications.</p> <p><b>Auto Hide Controls when in Full Screen</b> Automatically hides controls in full-screen mode if no user interaction occurs. Controls automatically re-appear if you move the mouse.</p> <p><b>Keep Aspect Ratio</b> Maintains the aspect ratio (width-to-height ratio) when you resize the display.</p>
<b>Time Mode</b>	Set the time mode: <b>Elapsed Time</b> , <b>Remaining Time</b> , or <b>Total Time</b> .
<b>Tool Tips</b>	<p><b>Show Tool Tips</b> Displays helpful aids for using the File Player.</p> <p><b>Show Shortcut</b> Displays shortcut keys.</p>

## File Player Preferences settings

The Preferences settings page lets you specify power management settings.

<b>Power Management</b>	Select one of the following levels:
	<b>Always</b> Power management always enabled.
	<b>Disabled while playing</b> Power management is disabled while a CD is playing.
	<b>Allow display to turn off while paused</b> Only the display turns off when playback is paused.
	<b>Disabled</b> Power management is never enabled.

## File Player Stills Gallery settings

You can capture still images from the File Player.

### To open the File Player Stills Gallery settings page



Click the Setup button in the File Player control panel, then click the **Stills Gallery** tab. For information on Stills Gallery, see [Stills Gallery](#) on page 55.

## File Player Schedule settings

You can schedule the File Player to play media files on the dates and times you specify. If you have the features installed, you can also schedule events for CD Audio, TV Magazine, Digital VCR, and TV.

### To set up scheduled events



Click the Setup button in the File Player control panel, then click the **Schedule** tab. The Schedule Wizard will guide you through creating new scheduled events. See [Schedule](#) on page 83 for details.

## Schedule

Use the Schedule feature to activate events on the dates and times you want. You can schedule events for CD Audio, TV Magazine, Digital VCR, File Player, and TV.

### To set up scheduled events



Click the Setup button in the DVD, TV, CD Audio, or File Player control panel. Click the **Schedule** tab, and then click the **Create New** button.

The Schedule Wizard will guide you through creating new scheduled events. Step 4 of the Wizard asks if you want to set up feature-specific settings (for example, if you are recording video, you can specify quality and duration for particular events). When you click the **Finish** button, your event is added to the scheduled event list; checked items are active.

## Schedule settings

<b>Name</b>	The name of the event. Checked events are active.
<b>Feature</b>	The feature to schedule: CD Audio, File Player, Television, TV Magazine, Video Capture, or Video CD.
<b>When</b>	When the event occurs.
<b>Next Run Time</b>	The next time the event will run.
<b>Modify</b>	Click to change values for a scheduled event.
<b>Delete</b>	Remove a scheduled event.
<b>Delete All</b>	Remove all scheduled events.
	<ul style="list-style-type: none"><li>• Events whose date (On Month &amp; Day) has passed are not automatically removed. To re-activate an event, set its Month &amp; Day to today or later.</li><li>• If a settings page is open, or if the About Help... box is being displayed, the Scheduler cannot process events. If an event occurs, a warning dialog tells you that a particular event was not processed.</li><li>• When the Multimedia Center first runs, if there are any scheduled events recorded, and the Scheduler program is not running, a warning dialog tells you that the scheduled events will not be processed.</li></ul> <p>You can run the Scheduler immediately, and/or install it in your Windows Startup file, so that it runs every time Windows is started. the warning dialog is displayed whenever you click OK after adding an item to the scheduled viewing list.</p>

## TV Out

You can connect a television set as your computer's display, and use your Multimedia Center to view computer output directly on your television in NTSC or PAL formats, connect using Composite or S-Video output capabilities, and display images on the TV and PC monitor simultaneously.

TV Out provides a big-screen experience for entertainment PCs that is ideal for playing games, giving presentations, watching movies, and browsing the Internet.

**Note**

You must attach a TV before enabling TV out. For information on attaching a TV, see the User's Guide for your ATI card.

### To enable the television display

- 1** In the Windows taskbar, click **Start**.
- 2** Point to **Settings ►**, then click **Control Panel**.
- 3** Double-click **Display**.
- 4** Click the **Settings** tab.
- 5** Click **Advanced...**
- 6** Click **Displays**.
- 7** Check the **Television** checkbox.
- 8** Click **OK**.

To cancel TV Out, click the Television checkbox to clear it.



*For more information about television display, click Desktop Help.*

## Multi-monitor support

ATI RADEON VE cards with integrated HydraVision™ software provide flexible, multi-monitor support for your system. Many configurations of CRT, DVI flat panel, and TV monitor displays are available.



ATI RADEON VE cards, provide Multi-monitor support for DVD, File Player, and Video CD. For details, please see the *RADEON VE Installation and Setup User's Guide*.

## Teletext

ATI's new Teletext application lets you get the most out of working with Teletext. ATI Teletext eliminates all the familiar disadvantages of television's teletext, and allows you to surf in the teletext data stream. The *ATI Teletext User's Guide*



provides complete installation and operating instructions.

**Note** Teletext is only available in Europe.

## Troubleshooting

If you have problems with video or audio, try these suggestions.

### Audio problems ...

#### No sound

*Check your speakers:*

- If you have external speakers, ensure that they are powered-on (POWER indicator light is on) and connected to the LINE-OUT or SPEAKER OUT connectors on your sound card.

#### Still no sound?

*Play a .WAV sound:*

- 1 Click **Start**, point at **Settings** ►, select **Control Panel**, then double-click **Sounds**.
- 2 In the **Events** area, Click **Asterisk**, then click a .WAV file in the **Sound** area.
- 3 Click the Play button  to preview the sound.

*If you still do not hear any sound, open the Volume Control:*

- Click **Start**, point at **Programs** ►, point at **Accessories** ►, point at **Entertainment** ►, then select **Volume Control**. Or, right-click the speaker icon  (usually in the lower-right corner of your screen), then click **Open Volume Controls**.

If the speaker icon is not in your Taskbar, do the following:

- In the Windows Taskbar, click **Start**, point to **Settings**, then click **Control Panel**.
  - Double-click **Multimedia**.
  - In the **Audio** tab, check **Show volume control on the Taskbar**.
- Ensure that the **Volume Control** and the **Wave** channel are not muted or set very low. Also ensure that the **MIDI** (or **Synthesizer**) channel is not muted.

When you hear sound from your speakers, you know they are working.

- If you still experience audio problems, check the audio connections to your ALL-IN-WONDER 128 family card.

**No sound from TV**

Ensure that the audio connection between your ALL-IN-WONDER 128 family card or ALL-IN-WONDER RADEON card and your sound card is correct.

- For complete installation instructions, refer to the ALL-IN-WONDER 128 / ALL-IN-WONDER 128 PRO / ALL-IN-WONDER RADEON Installation and Setup User's Guide.

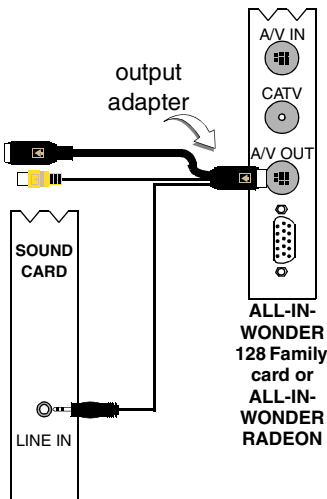



## Can't capture sound

Check the Record mixer settings:

- 1 Click **Start**, point at **Programs** ►, point at **Accessories** ►, point at **Entertainment** ►, then select **Volume Control**. Or, right-click the speaker icon  (usually in the lower-right corner of your screen), then click **Open Volume Controls**.
- 2 In the **Volume Control** menu, click **Options**, click **Properties**, click **Recording**, then click **OK**. The **Recording Control** opens.
- 3 Ensure that **Line** (or the Audio input you selected in the *Sound Initialization Wizard* — see [page 13](#)) is checked, then click  to close the dialog.

## Can't capture sound when recording from a videotape.

Connect the VCR audio output to your PC:

- Left and right audio output from your VCR must be connected to your ALL-IN-WONDER 128 family card or ALL-IN-WONDER RADEON card (note that S-Video does not provide an audio connection). For complete installation instructions, refer to the *ALL-IN-WONDER 128 / ALL-IN-WONDER 128 PRO / ALL-IN-WONDER RADEON Installation and Setup User's Guide*.

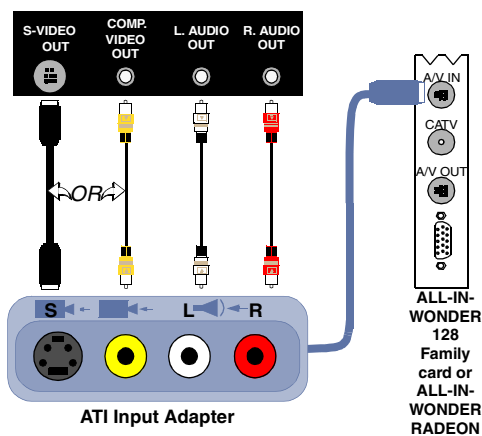

**No sound on the videotape when outputting to a VCR:**

Connect your PC audio to the VCR:

- Left and right audio output from your VCR must be connected to your ALL-IN-WONDER 128 family card or ALL-IN-WONDER RADEON card (note that S-Video does not provide an audio connection). For complete installation instructions, refer to the *ALL-IN-WONDER 128 / ALL-IN-WONDER 128 PRO / ALL-IN-WONDER RADEON Installation and Setup User's Guide*.

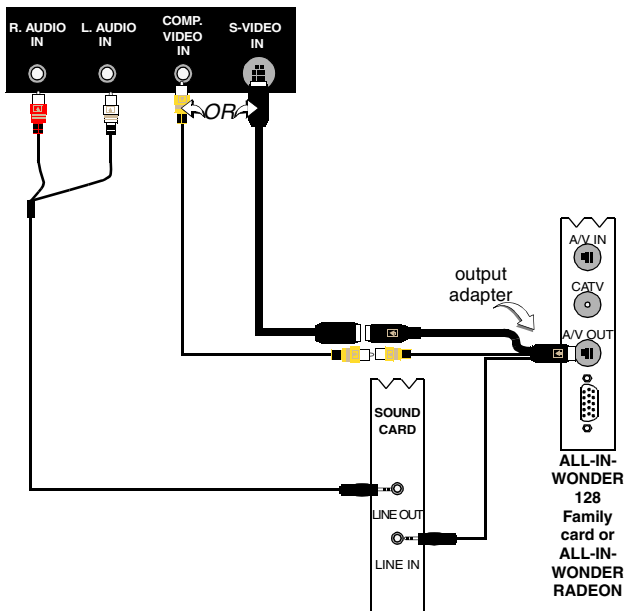

## Video problems ...

### Video is unstable or only black and white

*Check that you are using the correct broadcast standard format:*

- See *Broadcast Standard* in *TV video settings* on page 17. For proper operation, you must specify your country in the *TV Channels Initialization Wizard* (see *page 13*).
- Check the quality of your incoming TV signal on another receiver; bad reception may be the cause.

### There is no video or audio

- Ensure that your cable or antenna is connected.
- Ensure that the video connector is set to the correct source (see **Connector** in *TV video settings* on page 17).
- Check that the audio and video connectors are securely plugged into the correct jacks.
- Check that your video card is securely seated in its slot. Please refer to the user guide for the card location.



# Index

## A

**ATI TV Bar** 22

controls 22

**Attaching and detaching control panels** 9

**Audio troubleshooting** 87

**Autoscan** 18

## C

**Cable standard** 18

**Capture Wizard** 40, 41

**Capturing video and still images** 34

saving and compressing captured files 39

**CD Audio** 57

CD Database 59

Schedule settings 60

settings 58

**CD Database** 59

**Channel name** 18

**Channel Property Details** 18

**Channel Surfing** 23

**Closed Captioning**

settings 24, 75

**Closed-captioned text**

transcribing 28

**Control menu**

DVD 72

File Player 79

TV 15

Video CD 62

**Control panels**

attaching and detaching 9

## D

**Digital VCR**

achieving best results with MPEG 42

Capture Wizard 41

real-time MPEG encoding 41

setting up 39

settings 40

**DVD** 67

Closed-Captioning settings 75

control menu 72

display settings 73

full-screen controls 68

Parental Control 71

Preferences settings 74

region codes 77

Schedule settings 76

searching DVD disks 70

selecting audio channels 69

selecting viewing angle 70

setting up sub-titles 69

using the menus 70

Video settings 75

zooming and panning 71

**DVD audio channels**

selecting 69

**DVD menus**

using 70

**DVD Parental Control** 71

**DVD sub-titles**

selecting 69

## E

**Exporting time-shifted video** 38

## F

**File Player** 78

Control menu 79

Display settings 81

Preferences 82

Schedule Settings 82

Schedule Wizard 82

Stills Gallery 55

Stills Gallery Settings 82

zooming and panning 80

## **H**

### **Help**

- features, context-sensitive, Tool
- Tips, desktop 10

### **HotWords**

- setting up 26
- Wizard 27

### **HotWords Wizard 27**

## **I**

### **I, B, P frames 42**

### **I-frames 42**

### **Initialization Wizard 13**

- TV 13

### **Instant Replay 36**

## **K**

### **Karaoke CDs 61**

## **L**

### **LaunchPad**

- starting Multimedia Center from 8

### **Live Pause 36**

## **M**

### **MPEG**

- achieving best results with video
  - capture 42
- customizing recording settings 41
- real-time encoding 41

### **Multimedia Center**

- starting 8
- using 7

### **Multi-monitor support 86**

## **O**

### **overview 11**

## **P**

### **Parental Control 33**

- DVD 71
- password 13
- Wizard 13

### **Program Lockout**

- passwords 32
- Wizard 32

## **R**

### **RADEON VE 86**

### **Real-time MPEG encoding 41**

### **Recording quality 40**

### **Region codes 77**

### **Resource conflict 8**

## **S**

### **SAP 30**

### **Schedule**

- settings 84
- Wizard 83

### **Schedule Wizard**

- CD Audio 60
- DVD 76
- File Player 82
- TV 21

### **Secondary Audio Program 30**

### **Settings**

- CD Audio 58
- Closed Captioning 24, 75
- Digital VCR 40
- DVD display 73
- DVD Preferences 74
- DVD video 75
- File Player 81
- File Player Preferences 82
- File Player Schedule 82
- File Player Stills Gallery 82
- HotWords 26
- MPEG recording 41
- Schedule 84
- Stills Gallery 55
- TV display 16
- TV Stills Gallery 21
- TV Tuner 18
- TV tuner settings 18
- TV Video 17
- Video CD 64
- Video CD Stills Gallery 66

- Sizing TV display** 14
- Sound Initialization Wizard** 13
- starting from Taskbar** 11
- Starting Multimedia Center** 8
- Still image capture** 34
- Stills Gallery** 55
  - settings 55
- Surfing**
  - channels 23

## **T**

- Teletext** 86
- Tool Tips** 10
- Transcribing closed-captioned text** 28
- Troubleshooting**
  - audio 87
  - sound card connection 88
  - VCR audio connection 89
  - video 87

## **Tuner settings**

- TV 18

## **TV**

- capturing video and still images 34
- Channel Property Details 18
- Channel surfing 23
- Closed-Captioning settings 24
- Control menu 15
- Digital VCR 39
- HotWords 26
- Initialization Wizard 13
- Parental Control 33
- Program Lockout 32
- recording a clip of video and audio
  - from TV 35
- saving and compressing captured files 39
- Schedule settings 21
- Secondary Audio Program 30
- setting up 13
- starting from LaunchPad 11
- Stills Gallery 55
- Stills Gallery settings 21
- tuner settings 18
- TV Bar 22

- TV Listings 44
- TV Magazine 28
- TV-on-Demand 36
- Video Desktop 31
- video settings 17
- zoom and pan 30

## **TV Bar** 22

## **TV Channels Initialization Wizard** 13

## **TV display**

- settings 16
- sizing 14

## **TV Listings** 44

- accessing information from TV 44
- Actors tab 48
- Categories tab 49
- days and dates 54
- favorites search 49
- filter options 48
- getting around 46
- movies tab 50
- recording shows 46
- Schedules tab 51
- searches 49
- Searches tab 51
- setting search parameters 52
- setting up, registering, downloading
  - updated listings, customizing channels, updating listings 45
- Sports tab 53
- starting 44
- Stations tab 53
- Titles tab 54
- viewing shows 47
- views, Grid, Log 47

## **TV Magazine**

- setting up 28
- starting 28
- Wizard 25, 28

## **TV Magazine Wizard** 25

## **TV Out** 85

## **TV-on-Demand** 14, 36

- changing playback speed 37
- exporting time-shifted video 38
- Initialization Wizard 14

- Instant Replay 36
- Live Pause 36
- moving within time-shifted video 38
- pausing time-shifted video 37
- playing time-shifted video 37
- skipping backwards and forwards in time-shifted video 37
- viewing time-shifted video 36

## **V**

### **Video capture 34**

- achieving best results with MPEG 42

### **Video CD**

- capturing still frames 63
- Control menu 62
- display settings 64
- Stills Gallery 55
- Stills Gallery settings 66
- Video CD 1.0, Karaoke CDs 61
- zooming and panning 63

### **Video CD 1.0 61**

### **Video Desktop 31**

### **Video settings**

- TV 17

### **Video troubleshooting 87**

### **Video-In 12**

### **Viewing angles**

- selecting 70

## **W**

### **Wizard 82**

- Capture 40, 41
- HotWords 27
- Initialization 13
- Program Lockout 32
- Schedule 83
- Sound Initialization 13
- TV Channels Initialization 13
- TV Magazine 25, 28
- TV Parental Control 13
- TV Schedule 21
- TV-on-Demand 14

## **Z**

### **Zoom and pan 30**

### **Zooming and panning**

- DVD 71
- File Player 80
- Video CD 63



## Free Manuals Download Website

<http://myh66.com>

<http://usermanuals.us>

<http://www.somanuals.com>

<http://www.4manuals.cc>

<http://www.manual-lib.com>

<http://www.404manual.com>

<http://www.luxmanual.com>

<http://aubethermostatmanual.com>

Golf course search by state

<http://golfingnear.com>

Email search by domain

<http://emailbydomain.com>

Auto manuals search

<http://auto.somanuals.com>

TV manuals search

<http://tv.somanuals.com>