



# **USE AND CARE GUIDE**

*SAVE THESE INSTRUCTIONS FOR FUTURE REFERENCE*

**IMPORTANT!**  
**To get the best performance from your dryer, read all operating instructions before using it for the first time.**

## **DRYER**

### **CONTENTS**

IMPORTANT SAFETY INSTRUCTIONS	2
SAFETY FEATURES	2
ASKO DRYER FEATURES	3
ENERGY SAVING TIPS	3
INSTALLATION INSTRUCTIONS	4
PREPARING THE LAUNDRY	10
T701 OPERATING INSTRUCTIONS	12
T721 OPERATING INSTRUCTIONS	13
T731 OPERATING INSTRUCTIONS	14
T761 AND T781 OPERATING INSTRUCTIONS	17
CARE AND MAINTENANCE INSTRUCTIONS	22
TROUBLESHOOTING	24
PRODUCT WARRANTY	25
INDEX	26

## IMPORTANT SAFETY INSTRUCTIONS

### **WARNING!**

To reduce the risk of fire, electric shock, or injury to persons when using your appliance, follow basic precautions, including the following:

- ◆ Read all instructions before using the appliance.
- ◆ Do not wash or dry articles that have been previously cleaned in, washed in, soaked in, or spotted with gasoline, dry-cleaning solvents, cooking oils, other flammable or explosive substances as they give off vapors that could ignite or explode.
- ◆ Do not allow children to play on or in the appliance. Children should be closely supervised when near the appliance.
- ◆ Before the appliance is removed from service or discarded, remove the door to the drying compartment.
- ◆ Do not reach into the appliance if the drum is moving.
- ◆ Do not install or store this appliance where it will be exposed to the weather.
- ◆ Do not tamper with controls.
- ◆ Do not attempt to repair or replace any part of the appliance or perform any servicing unless specifically recommended in this guide.
- ◆ Do not use fabric softeners or dryer sheets unless the manufacturer gives written assurance that the product will not damage a tumble dryer.
- ◆ Do not heat-dry items containing:
  - vinyl, plastic, foam rubber or similarly textured rubberlike materials
  - fiberglass
  - wool unless the label specifies "washable"
- ◆ Clean the lint filter before or after each load.
- ◆ Keep the area around the exhaust opening and adjacent surrounding areas free from the accumulation of lint, dust and dirt.
- ◆ The interior of the machine should be cleaned periodically by an authorized ASKO service agent.
- ◆ Do not place items exposed to cooking oils in your dryer. Items contaminated with cooking oils may contribute to a chemical reaction that could cause a load to catch fire.
- ◆ Electrical installation, if required, must be done by a licensed electrician.
- ◆ Do not operate appliance while away from the home.

- ◆ Do not heat dry items that have been dry-cleaned.
- ◆ The dryer is made and marked to facilitate recycling. When it is no longer useful, contact your local refuse collection service for advice on how to properly dispose of the dryer for purposes of recycling.

### **WARNING!**

**This appliance must be properly grounded.**

#### **GROUNDING INSTRUCTIONS**

##### **A) Grounding instructions for a grounded, cord-connected appliance**

In the event of malfunction or breakdown, grounding will reduce the risk of electric shock by providing a path of least resistance for electric current. This appliance is equipped with a cord having an equipment-grounding conductor and a grounding plug. The plug must be plugged into an appropriate outlet that is properly installed and grounded in accordance with all local codes and ordinances.

To reduce the risk of fire, this appliance must be exhausted outdoors or the equivalent. Do not exhaust into a chimney, wall, ceiling or concealed space in a building.

### **WARNING!**

**Improper connection of the equipment-grounding conductor can result in a risk of electric shock. Check with a qualified electrician or service representative or personnel if you are in doubt as to whether the appliance is properly grounded.**

**Do not modify the plug provided with the appliance. If it will not fit the outlet, have a proper outlet installed by a qualified electrician.**

##### **B) Grounding instructions for a permanently connected appliance:**

This appliance must be connected to a grounded metal, permanent wiring system, or an equipment-grounding terminal or lead on the appliance.

**NOTE:** This manual does not cover every possible condition and situation that may occur. Use common sense and caution when installing, operating, and maintaining any appliance.

## SAFETY FEATURES

### **CHILD-SAFE DOOR CATCH**

ASKO dryers have a child-safe magnetic door catch that allows the door to be easily opened from the inside.

### **CHILD-SAFE START FEATURE**

You can program Models T731, T761 and T781 not to start unless the Start button is held down for three seconds. This is to prevent children from inadvertently starting the machine. Refer to the operating instructions for these models to program this safety feature.

### **AUTOMATIC DOOR SWITCH**

A door switch automatically stops the dryer when the door is opened. The dryer will not start again until you close the door and press the Start button.

### **OVERHEAT PROTECTION**

ASKO dryers have an overheat protection switch that automatically turns off the machine if the temperature gets too high. Refer to page 3 for more information.

# ASKO DRYER FEATURES

Your new energy-efficient ASKO dryer is designed to give you maximum drying performance using less energy. To make the most of the dryer's functions and features, we recommend that you read this manual carefully before using your machine for the first time. For operating instructions, refer to the section in this guide for your specific model.

Below is an illustration of the parts and features of your ASKO dryer.

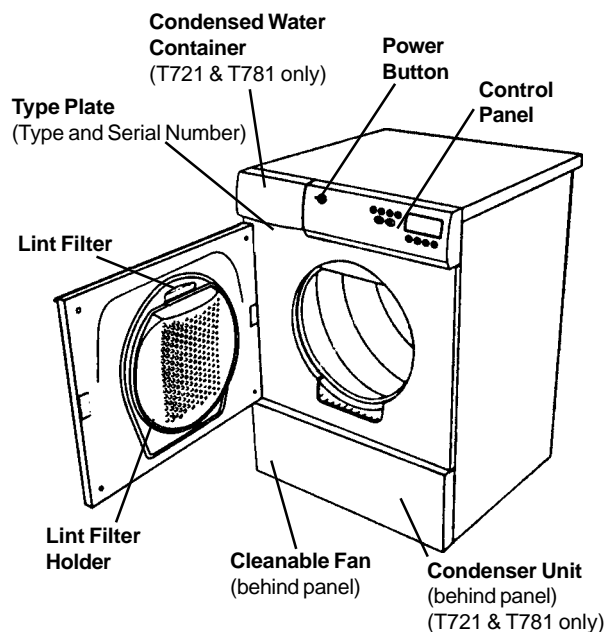

## DRYING SYSTEMS

ASKO dryers come with three different drying systems:

### Sensidry™

Models T731, T761 and T781 have our state-of-the-art Sensidry system. These machines are equipped with a humidity sensor that ensures different fabrics always dry thoroughly. This sensor turns off the heat when the laundry has reached the appropriate dryness.

### Thermostat-Control

Model T701 has a thermostat that controls the temperature by turning the heating element on and off to maintain the selected drying temperature (Normal or Low) within +/- 5° F.

### Timer-Control

Model T701 has timer-controlled drying in addition to the two automatic (thermostat-controlled) programs.

Model T721 offers only timed drying. You can set the dryer to run from 30 minutes to 190 minutes.

Model T731 has timer-controlled drying in addition to the four automatic programs.

When using a timed drying program, be careful not to dry the clothes too long. It's best to use a shorter time; then if the load isn't dry, you can set the timer for a few more minutes.

## OVERHEAT PROTECTION

ASKO dryers are designed with an overheat protection switch that automatically turns off the machine if the temperature is too high. The machine will not start until it has cooled sufficiently.

The dryer could overheat if the lint filter or exhaust hose becomes clogged with dust. It's a good idea to make sure the lint filter, exhaust hose and vent duct are clean before you call for service. If you use dryer sheets (not recommended), you may need to wash the lint filter with warm water and a soft brush to clean any blocked holes. If you have a condenser dryer (T721 or T781), first make sure the condensation water container is empty (see page 22).

If the overheat protection switch is activated, you have to reset it before the machine will run. To do this, press the reset button (rubber disk) on the back of the machine, as illustrated below. You should hear a click when it engages. The machine cannot be reset until it has cooled sufficiently.

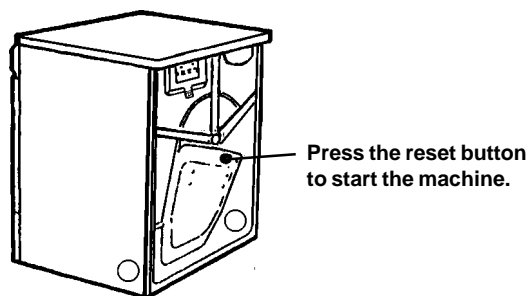

**NOTE:** If your dryer overheats frequently, it may not be vented properly or the room in which it is located may not have sufficient air circulation. Contact your installer to have these issues checked out.

## COOL-DOWN

Every program on an ASKO dryer ends with a cool-down cycle to reduce wrinkling. Unlike with other dryers, the laundry will feel cool when you remove them from an ASKO dryer. No more scorched fingertips.

# ENERGY SAVING TIPS

- ◆ Dry consecutive loads to avoid reheating the dryer.
- ◆ Do not overload the dryer.
- ◆ Use the highest spin speeds allowed for the garments.
- ◆ Do not put extremely wet clothes into the dryer.
- ◆ Dry like fabrics together (i.e., heavy fabrics together, light fabrics together).
- ◆ Clean the lint filter after each load.
- ◆ Do not over-dry clothes when using the timed program.
- ◆ Spin the clothes at no less than 800 rpm.

# INSTALLATION INSTRUCTIONS

Read these instructions carefully and completely before you install the machine. The installation should be carried out by a qualified person who is familiar with all local codes and ordinances for electrical and plumbing connections.

**NOTE:** Cosmetic damage must be reported to your dealer within five days from the date of purchase. After unpacking the dryer, thoroughly check the unit for cosmetic damage.

## SPECIFICATIONS

Height	33-1/2"–34-1/2 (850–876 mm)	Outer casing	Stove-enamelled hot-dipped galvanized steel
Width	23-7/16" (595 mm) Plus exhaust hose connection	Power requirement	2800 watts
Depth	T761/T781: 23-7/16" (595 mm) T701/T721/T731: 24-7/16" (620 mm)	For connection	Single-phase, 230 V, 30 Amp
Weight	86 lbs (39 kg)	Internal fuse	15 amp.
Drum material	Stainless Steel	Heating element	2500 watts

## CONNECTING THE EXHAUST DUCT TO THE DRYER (T701/T731/T761)

**NOTE:** You will need to purchase a UL-CSA-approved 4-inch ridged metal exhaust duct.

The dryer is delivered with the stub pipe attached to the rear exhaust outlet, but the exhaust duct can be attached to either the right or left exhaust outlet.

**NOTE:** Maximum duct length of 22 feet is allowed. Subtract 4 feet of duct for each 90° elbow.

ASKO dryers have a "T-style" exhaust vent that allows you to connect the duct on the rear or on the left or right side.

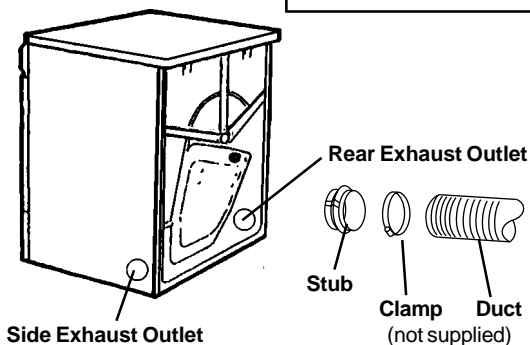
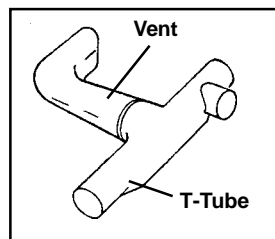

## CONNECTING THE EXHAUST DUCT TO THE LEFT OR RIGHT SIDE OUTLET

To connect the exhaust duct to the left or right side outlet, follow the steps below:

1. Using a flathead screw-driver, turn the exhaust outlet cover you plan to use to the right or left to align the tabs holding the cover in place.
2. Remove the exhaust outlet cover.
3. Remove the stub pipe from the rear exhaust outlet and place it in the outlet you plan to use.
4. Push the duct onto the stub pipe and secure it with a clamp.
5. With the duct attached, insert the stub pipe into the hole. It should snap into place.
6. After you push the dryer into place, check for kinks in the duct.
7. Use the exhaust outlet cover you removed from the to cover the rear exhaust outlet.

**WARNING!**  
To reduce the risk of fire, this appliance must be exhausted OUTDOORS or the equivalent.

Never cover the end of the dryer stub or exhaust duct with anything to catch lint, except for UL approved vent basket.

## CONNECTING THE EXHAUST DUCT TO THE REAR OUTLET

To connect the exhaust duct to the rear outlet, follow the steps below:

1. Push the duct onto the stub pipe and secure it with a clamp.
2. With the duct attached, insert the stub pipe into the hole. It should snap into place.
3. After you push the dryer into place, check for kinks in the duct.

**NOTE:** Excessive duct length and too many bends can impede drying performance. We recommend that you cut off any excess exhaust duct and run the duct with as few bends as possible. Make any necessary bends as gentle as possible.

## CONNECTING TO A VENTILATION DUCT (T701/T731/T761)

You will need a UL-CSA-approved, 4-inch ridged metal exhaust duct.

**NOTE:** The more bends and the longer the duct, the less air will circulate through the machine, which will impede drying performance. We recommend that you cut off any excess exhaust duct and run the duct with as few bends as possible. And make any necessary bends as gentle as possible.

**NOTE:** Maximum duct length of 22 feet is allowed. Subtract 4 feet of duct for each 90° elbow.

If more than 20 feet of duct is needed, the diameter must be increased to 6" or 8" (152 mm or 203 mm).

**NOTE:** When installing in warm climates (77° F and above) with high humidity levels, do not route the air exhaust duct upwards.

To connect the exhaust duct to a ventilation outlet, follow the steps below:

1. Connect the exhaust duct to a ventilation exhaust fitting or to a discharge through the wall.
2. Secure the duct joint to the outlet stub on the machine.
3. Run the duct with as few bends as possible to the point of discharge.

### WARNING!

**This appliance should not be exhausted into a chimney, a wall, a ceiling, or a concealed space of a building. Only a metal ventilation grill should be used.**

If the duct is taken to a wall outlet, a ventilation grill should be fitted to prevent reverse flow of cold air. Fit the ventilation grill to the outside or inside of the wall.

### Installation Examples

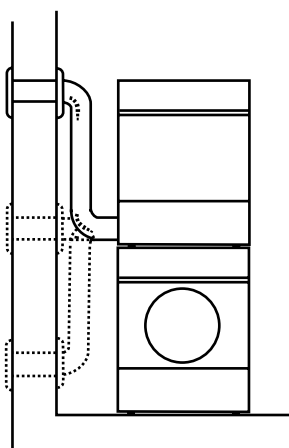

Subtract 4 feet (122 cm) for every 90° elbow.

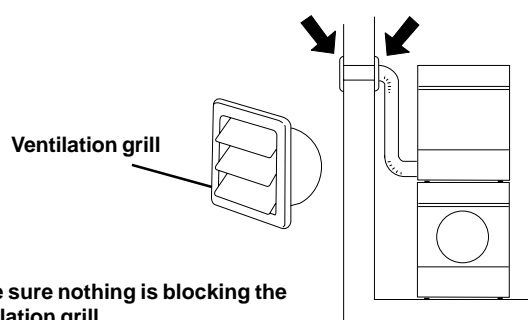

Make sure nothing is blocking the ventilation grill.

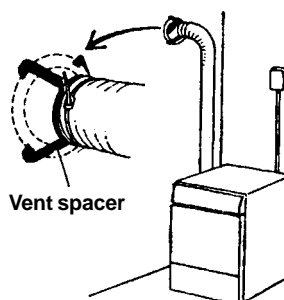

If there is only one vent duct from the room, a vent spacer must be fitted.

## CONDENSATION DRAIN CONNECTION (T721 AND T781)

If possible, you should install the dryer so the condensed water will continuously flow into a drain or sink. To do this, follow the instructions below:

1. Disconnect the short hose (1) from the blue connection. (It's okay to let the hose hang down.)
2. Connect the rubber hose supplied with the dryer to the blue nipple (2).
3. Run the hose to a drain or sink, as illustrated.

**NOTE:** The drain hose must not be more than 40" above the floor.

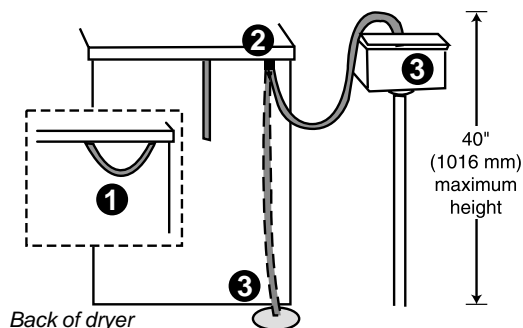

## LEVELING THE MACHINE

It is important that the machine is level. Each foot on the dryer is adjustable, so you can level the unit on any surface. Once it is level, securely tighten the lock nuts on the feet.

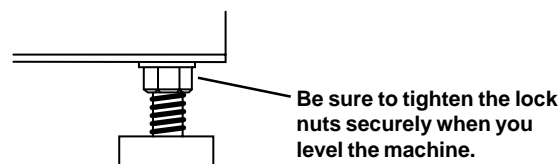

Be sure to tighten the lock nuts securely when you level the machine.

## FREESTANDING INSTALLATION

The dryer can be placed next to the washing machine. It is essential that the machine is leveled and the locknuts are tight to eliminate vibration noise.

There should be at least 1/2" (12 mm) of space between the washer and dryer.

## BUILT-IN INSTALLATION

ASKO dryers can be installed beneath a cabinet or worktop with a minimum height of 34" (864 mm). There must be a gap of about 1/2" (12 mm) all around the machine, including between the rear edge of the machine top panel and the back wall. The opening width must be at least 24-1/2" (622 mm).

Space must also be available for the exhaust hose on the left, right or rear of the machine. See the diagram for hole sizes and positions. Note that the hole measurements are to the center of the hole.

## CONDENSING DRYERS (T721IT781)

The condensing models work best when they have good air circulation. Therefore, we don't recommend they be installed beneath a cabinet. If it is necessary, however, be sure to leave a gap of at least 1/2" (12 mm) on all sides.

If you install the dryer so the condensed water will continuously flow into a drain or sink, you will need a drain outlet behind the unit. The maximum drain height is 40" (1016 mm). (See page 4.)

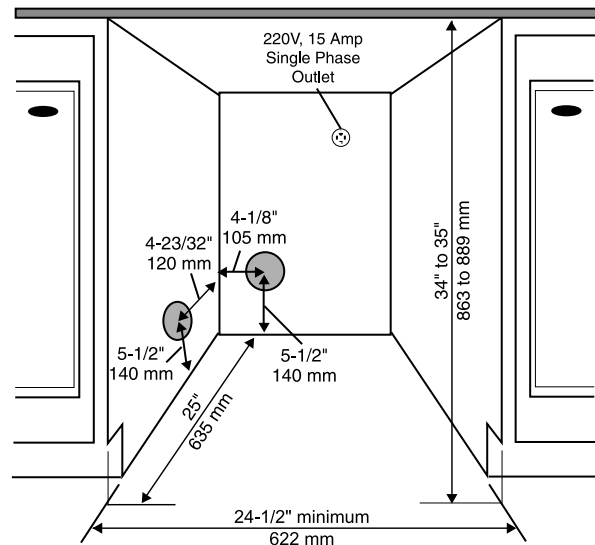

**NOTES:** The height adjustment for the dryer is 33-1/2" to 34-1/2" (850 mm to 876 mm). Do not raise it higher than 34-1/2".

Hole measurements are from center of hole.

## ELECTRICAL CONNECTIONS

### WARNING!

This appliance must be properly grounded. Refer to the "Important Safety Instructions" on page 2 for grounding instructions.

The power supply cord must be grounded. If the machine is to be used in a wet area, the supply must be protected by a residual current device.

Connection to a permanently wired supply point must be made only by a qualified electrician.

As supplied: Single-phase, 230 V, 60 Hz,  
2500 Watt heater rating  
30 A fuse required

### WARNING:

The receptacle on the rear of the machine is designed to accommodate ASKO washers **ONLY** (rated 208–240 V.) To use this receptacle, you must use the ready-fitted plug supplied with the washing machine or an equivalent. The supply connection must be 208–240 V, 20 A.

ASKO washers rated 208–240 V have two internal fuses of 15 A each.

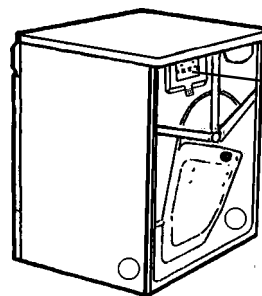

Remove cover to access terminal box. (Requires a 20-Torx screwdriver.)

**NOTE:** In Canada, the dryer is delivered ready-fitted with a four-prong plug intended for connection to a single-phase supply.

## CONNECTING A 3-WIRE POWER CORD

### WARNING!

Before starting this procedure, be sure the power is turned off at the breaker/fuse box.

### Power Supply Cord

You will need a 3-wire power supply cord with three No. 10 copper wires and a matching 3-wire receptacle of NEMA Type 10-30R, as illustrated below:

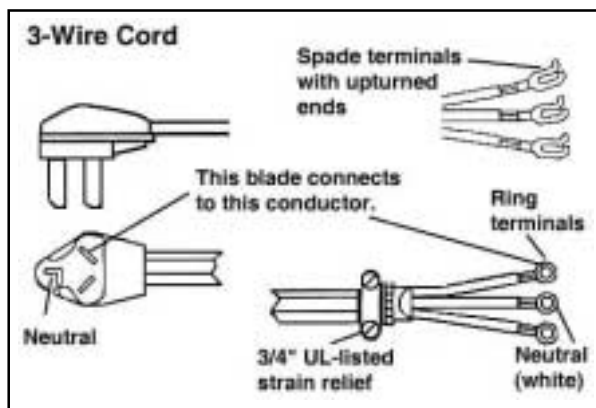

To connect a 3-wire power cord to the dryer, follow the steps below.

NOTE: The numbers in the illustration below correlate to the step numbers.

1. Turn the power off at the breaker/fuse box.
2. Remove terminal block cover.
3. Use the strain relief attached below the terminal block opening.
4. Loosen or remove center terminal block screw.
5. Connect neutral (white) wire of power supply cord to the center, silver-colored terminal screw. Tighten screw.
6. Connect the other wires to outer screws.
7. Tighten the strain relief screws.
8. Replace terminal box cover on back of dryer.
9. Plug dryer into wall receptacle.
10. Turn power on at breaker/fuse box.

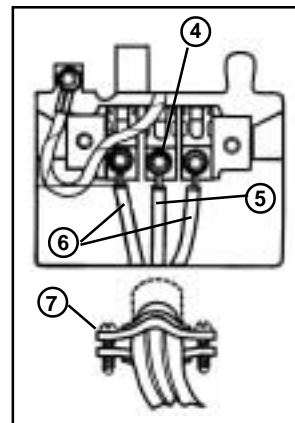

## CONNECTING A 4-WIRE POWER CORD

### WARNING!

Before starting this procedure, be sure the power is turned off at the breaker/fuse box.

### Power Supply Cord

You will need a 4-wire power supply cord with four No. 10 copper wires and a matching 4-wire receptacle of NEMA Type 14-30R, as illustrated below. The fourth wire must be identified with a green cover and the neutral conductor by a white cover.

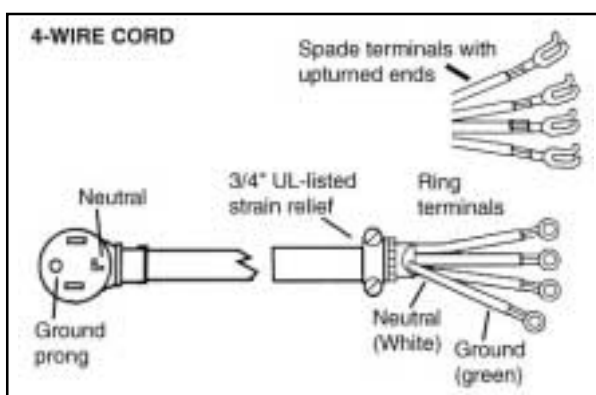

To connect a 3-wire power cord to the dryer, follow the steps below.

NOTE: The numbers in the illustration below correlate to the step numbers.

1. Turn the power off at the breaker/fuse box.
2. Remove terminal block cover.
3. Use the strain relief attached below the terminal block opening.
4. Remove center terminal block screw.
5. Remove ground wire (green with yellow stripes) from external ground connector screw. Fasten under center, silver-colored terminal block screw.
6. Connect ground (green) wire of cord to external ground conductor screw.
7. Connect neutral (white) wire of cord under center screw of terminal block.
8. Connect the other wires to outer screws.
9. Tighten the strain relief screws.
10. Replace terminal box cover on back of dryer.
11. Plug dryer into wall receptacle.
12. Turn power on at breaker/fuse box.

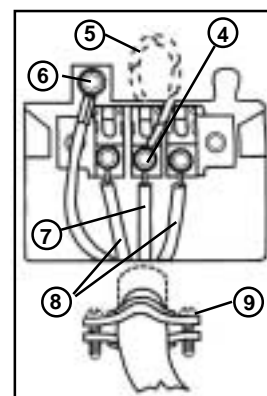

## STACKED INSTALLATION

ASKO dryers can be mounted on top of any matching ASKO washer. Mounts are supplied with the machine. The metal brackets are attached to the lower back of the unit. The plastic cups are packed inside the dryer.

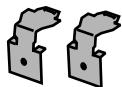

Two metal brackets for securing the dryer to the washer



Two plastic cups to secure the dryer legs.

To install the dryer on top of the washer, follow the steps below:

1. Remove the two outside screws (A) (20 torx) from the back of the washer and use them to secure the metal brackets (B), as illustrated below.

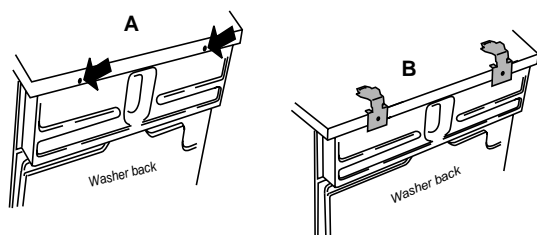

2. To ensure the dryer is correctly positioned on top of the washer, you will need to align the plastic cups with the front top edge of the washer. To position the plastic cups, break off the left tab on the cup to be placed on the right side of the washer and break off the right tab on the cup to be placed on the left side of the washer.

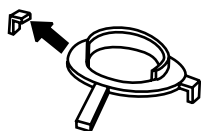

Plastic cups

3. Remove the protective paper from the self-adhesive surface beneath the cups. Being careful not to press the adhesive surface against the top of the washing machine, use the tabs to position the cups (as illustrated below) then press them firmly into place.

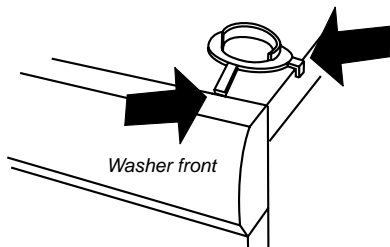

4. Once the cups are correctly in place, break off the remaining plastic tabs.

5. Lift the dryer into position. Raising the front edge, push the dryer backwards until it engages with the brackets on the back of the washer.

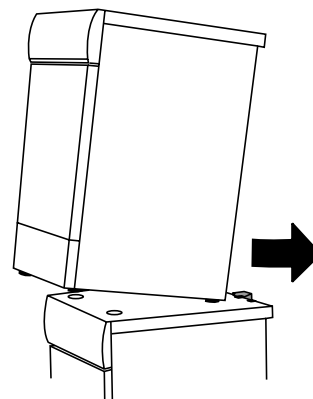

6. Carefully lower the front of the dryer, making sure the feet fit into the plastic cups.

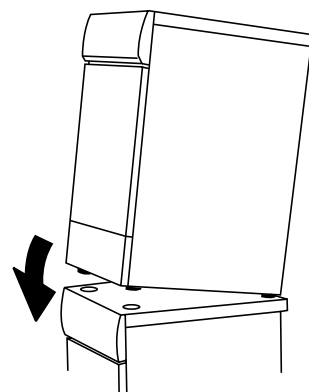

### Stacked Installation

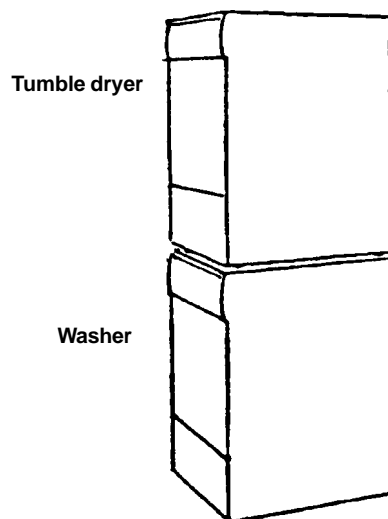

Total height 67".  
Adjustable to 69".

**WARNING!**  
Never stack a washer on top of a dryer!



## REVERSING THE DOOR HINGES

The door hinges on ASKO dryers are reversible. The dryers are shipped left-hinged. To reverse them, follow the steps below:

**WARNING!** Switch off the main power supply before you start this procedure.

1. Remove the two 20 torx screws on the bottom of the bottom panel then grasp the bottom of the panel and pull it forward and down.

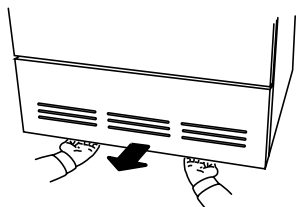

2. Remove the bottom hinge bracket by removing the three screws holding the bracket in place.

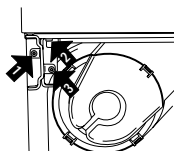

3. Supporting the door from the bottom, pull it out and to the left as you turn the hinge bracket counter-clockwise.

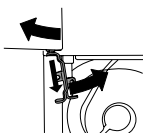

4. Remove the hinge pin at the top of the hing bracket.
5. Turn the hinge bracket upside down and put the hinge pin into the top hole.

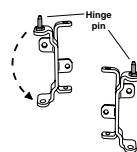

6. Transfer the top hinge pin to the right side of the dryer casing.

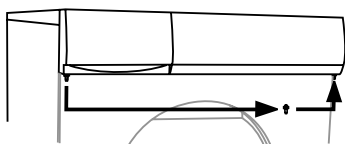

7. Loosen the two screws on both outer edges of the door so you can remove the magnetic door catch and the cover plate.

8. Remove the magnetic catch by pushing it up then lifting it out from the bottom.

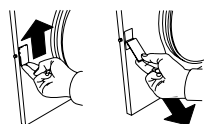

9. Remove the cover plate on the opposite side of the door by pushing it down then lifting it out from the top.

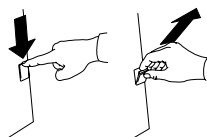

10. Reverse steps 8 and 9 to place the door catch and cover plate into their new positions.

11. Tighten the screws on the sides of the doors to hold the magnetic catch and cover plate in place.

12. Using a flathead screwdriver, carefully remove the plastic plugs in the upper and lower edge of the door and place them in the empty holes on the opposite side.

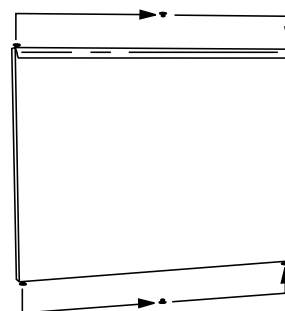

13. Remove the screw in the top right corner of the bottom panel. (If you have a condenser dryer, you will have to open the condenser unit door.)

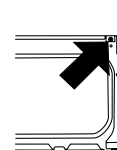

14. Now you are ready to mount the door on the right side. Holding the door at an angle (as illustrated), fit the hinge pin into the top hole.

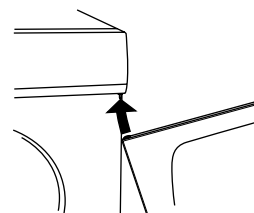

15. Position the bottom hinge bracket and secure it with the screws in the order illustrated at right (a, b, c).

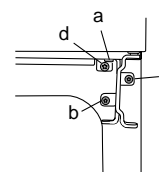

16. Replace the screw you removed in step 13 (d).

17. Replace the lower panel.

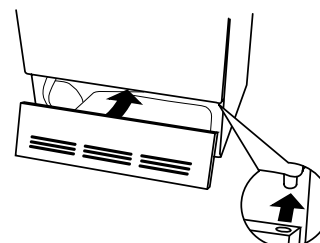

18. Turn back on the main power.

## PREPARING THE LAUNDRY

With proper attention to how you prepare your laundry items for washing and drying, your wardrobe and linens will look like new for years.

### SORTING THE LAUNDRY

For best drying results, clothes should be sorted properly. Most importantly, you should follow the care label instructions (see next page).

Below are some suggestions on how to sort your laundry for drying.

- ◆ Permanent press items should be dried together. For the most wrinkle-free results when drying permanent press items, you should fill the machine only half full. These items also should be removed promptly from the dryer and hung up or folded right away.
- ◆ Dry heavy fabrics together and lightweight fabrics together.
- ◆ Dry fabrics that *shed* lint (chenille, terry cloth, etc.) separately from fabrics that *collect* lint (synthetics, velveteen, corduroy, etc.).
- ◆ Separate non-colorfast fabrics from light-colored items.
- ◆ If the care label says "Wash Separately," the fabric is likely to lose color (excess dye) for the first few washings. To minimize the possibility of the dye transferring to white or lighter colored items, dry new colored garments with items of similar color or alone. Bright reds and oranges on cottons are the dyes most likely to transfer colors.

**NOTE:** Refer to "Important Safety Instructions" on page 2 for a list of specific materials that should never be put in a tumble dryer.

### FABRIC SOFTENER SHEETS

We recommend that you do not use fabric softener sheets in the dryer. Over time, the chemicals on these sheets can build up inside the lint filter and clog the holes that circulate the air.

### RECOMMENDED TEMPERATURE SETTINGS AND LOAD SIZES

Different fabrics require different load sizes and drying temperatures. The table below gives recommended

### DRYING TIMES

Drying times will vary due to the amount of laundry in the machine, moisture content, type of fabric, air temperature and humidity. The length of the vent hose can also affect drying times. (See "Connecting to a Ventilation Duct" on page 5 for the recommended installation.)

### GENERAL LAUNDRY ADVICE

- ◆ Read all recommended care labels carefully. If the care label says "Drip dry," "Line dry" or "Dry flat," do not dry that item in the dryer. Certain fabrics will melt or become dangerously flammable if heated, while others may lose their shape.
- ◆ Remove any sharp ornaments, pins or buckles to prevent snags.
- ◆ Empty pockets and turn them inside out.
- ◆ Close zippers and hooks to prevent snagging.
- ◆ Tie sashes and strings to prevent tangling.
- ◆ Mend any small rips to prevent them from enlarging.
- ◆ Turn colored cotton garments, velvet and finer knitwear inside out before washing.
- ◆ Turn delicate items, sweaters and T-shirts inside out to prevent pilling and to protect the prints.
- ◆ Prewash severely soiled items.
- ◆ Wash and dry colored fabrics separately the first time.
- ◆ Thoroughly rinse down items, such as comforters (Super rinse).
- ◆ Use fabric softener to eliminate static electricity in synthetic garments and to soften cotton.

temperature settings and load sizes for different fabrics.

<b>Fabric Type</b>	<b>Temp Setting</b>	<b>Load Size</b>
Cotton w/out elastic and/or decorative trim	Normal	Full
Linen – white and colorfast	Normal	Half
Cotton/polyester blends	Low	Half
Polyester/acrylic blends	Low	Half
Rayon and acetate	Low	Half
Washable silk and nylon *	Low	Third

- \* Always refer to the care label on the garment to determine if it can be tumble dried. (See page 11.) Some wool and silk and hand-washable items should not be tumble dried. These items should be removed from the washer then pressed out in a terry towel to remove excess water before being hung up or laid flat to dry.

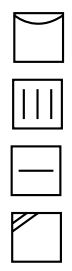

...ed  
... the bleach  
... reach

**CARE SYMBOL**

Dry clean

# T701 OPERATING INSTRUCTIONS

**WARNING!** To reduce the risk of electric shock or injury to persons, read the "Important Safety Instructions" section on page 2 before operating this appliance.

## THE CONTROL PANEL

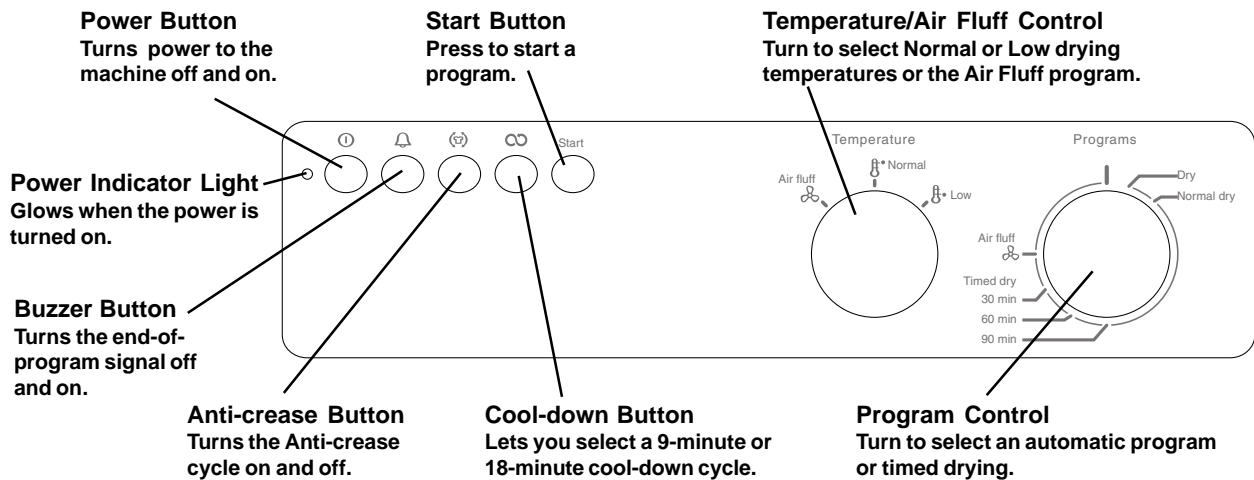

## POWER BUTTON

The Power button turns the power to the machine on and off. When the power is on, the power indicator light glows red. The power must be on before you can start the machine.

## START BUTTON

This button starts the dryer. If you open the door during a program, the dryer will stop tumbling automatically. To continue the program, close the door and press Start.

## PROGRAM CONTROL

This model has two preset programs:

**Dry** – for heavy items, such as jeans or thick towels

**Normal Dry** – for cottons, permanent press, synthetics, etc.

These programs work with a thermostat that measures the exhaust temperature coming out of the dryer and automatically turns the machine off when the clothes are appropriately dry.

### Timed Drying (30, 60 or 90 minutes)

If you prefer, you can set the Program Control knob to a specific number of minutes to dry the laundry. When you choose timed drying, you must set the Temperature Control knob to Normal or Low.

### Air Fluff Program

The Air Fluff program is designed to shake dust out of fabrics, air them, or soften them. This program does not activate the heating element.

## TEMPERATURE CONTROL

### Normal

This temperature setting should be used for heavier fabrics, such as denim, cotton, linen, etc.

### Low

This temperature setting should be used for lighter, more delicate fabrics, such as synthetics, permanent press, acrylics, etc.

### Air Fluff

This setting does not activate the heating element. It simply circulates the air as the clothes tumble to shake out the dust and refresh the clothes.

## OPTIONS

### Buzzer

When this button is depressed (on), a buzzer will sound for three seconds when the program is complete. *Note:* The Cool-down button must also be pressed in for the buzzer to sound.

### Anti-crease

The Anti-crease option prevents garments from wrinkling if you're unable to remove them right away. When this button is depressed (on), the drum will continue to rotate for three seconds every minute after they drying program is complete, until the door is opened or one hour has passed. If the buzzer is on, it will sound each time the anti-crease program activates.

### Cool-down

When this button is depressed (on), the cool-down time is increased from 9 minutes to 18 minutes. This option can not be selected with the Anti-crease option.

## INTERRUPTING OR CANCELLING A PROGRAM

To interrupt a program, simply open the door. The dryer will stop tumbling automatically. To continue the program, close the door and press Start. The program will continue from the point it was interrupted.

To cancel a program, press the Power button to turn off the power or turn the Program Control knob clockwise until the dryer stops.

# T721 OPERATING INSTRUCTIONS

**WARNING!** To reduce the risk of electric shock or injury to persons, read the "Important Safety Instructions" section on page 2 before operating this appliance.

## THE CONTROL PANEL

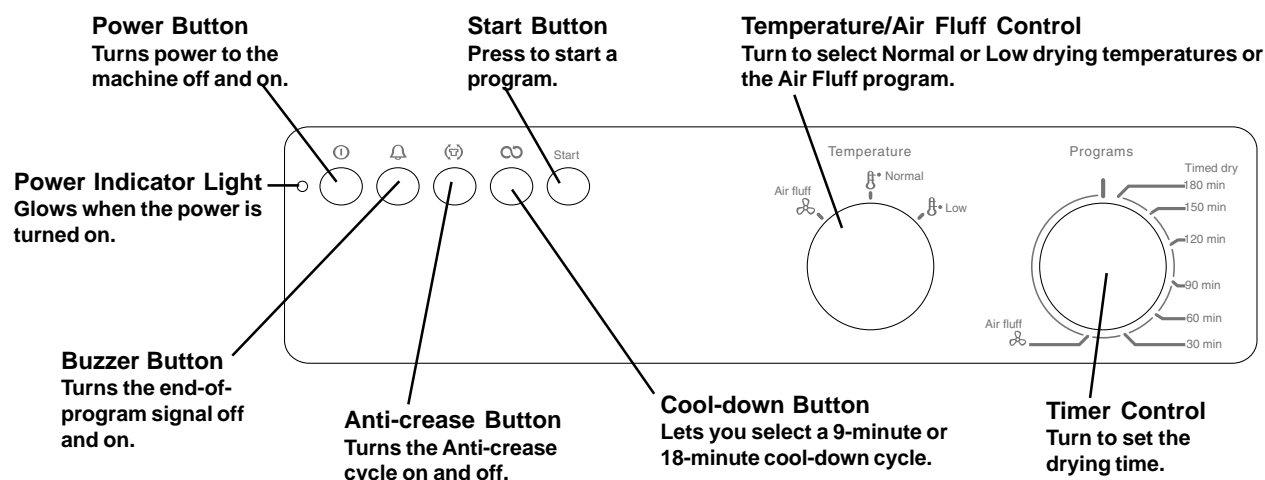

### POWER BUTTON

The Power button turns the power to the machine on and off. When the power is on, the power indicator light glows red. The power must be on before you can start the machine.

### START BUTTON

Press this button to start the dryer. If you open the door during a program, the dryer will stop tumbling automatically. To continue the program, close the door and press Start.

### TIMER CONTROL KNOB

Use this knob to set the number of minutes you want to dry the laundry.

#### **Air Fluff Program**

The Air Fluff program is designed to shake dust out of fabrics, air them, or soften them.

### TEMPERATURE CONTROL

#### **Normal**

This temperature setting should be used for heavier fabrics, such as denim, cotton, linen, etc.

#### **Low**

This temperature setting should be used for lighter, more delicate fabrics, such as synthetics, permanent press, acrylics, etc.

#### **Air Fluff**

This setting does not activate the heating element. It simply circulates the air as the clothes tumble to shake out the dust and refresh the clothes.

### OPTIONS

#### **Buzzer**

When this button is depressed (on), a buzzer will sound for three seconds when the program is complete. *Note:* The Cool-down button must also be pressed in for the buzzer to sound.

#### **Anti-crease**

The Anti-crease option prevents garments from wrinkling if you're unable to remove them right away. When this button is depressed (on), the drum will continue to rotate for three seconds every minute after they drying program is complete, until the door is opened or one hour has passed. If the buzzer is on, it will sound each time the anti-crease program activates.

#### **Cool-down**

When this button is depressed (on), the cool-down time is increased from 9 minutes to 18 minutes. This option cannot be selected with the Anti-crease option.

### INTERRUPTING OR CANCELLING A PROGRAM

To interrupt a program, simply open the door. The dryer will stop tumbling automatically. To continue the program, close the door and press Start. The program will continue from the point it was interrupted.

To cancel a program, press the Power button to turn off the power or turn the Timer Control knob clockwise until the dryer stops.

# T731 OPERATING INSTRUCTIONS

**WARNING!** To reduce the risk of electric shock or injury to persons, read the "Important Safety Instructions" section on page 2 before operating this appliance.

## THE CONTROL PANEL

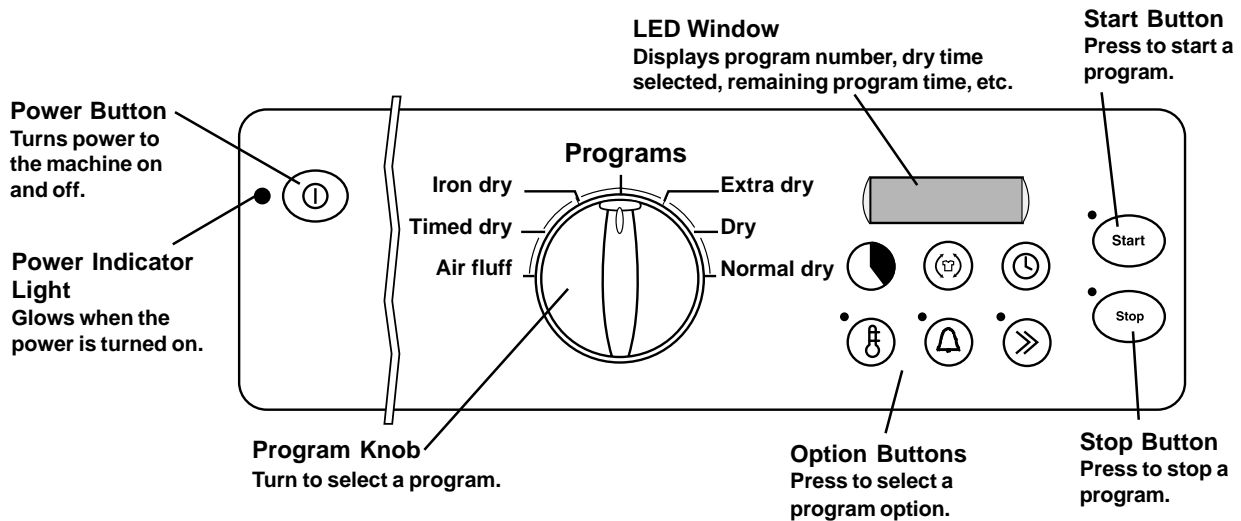

### POWER BUTTON

The Power button turns the power to the machine on and off. When the power is on, the power indicator light glows red. The power must be on before you can start the machine.

### PROGRAM KNOB

Turn this knob to select a program. The programs are described on the following page.

**12:00 Position** – This is where the line on the knob aligns with the line above the knob. When the knob is in this position, "00" displays on the LED to indicate no program has been chosen.

### START BUTTON

After you have selected a program and the desired options, press this button to start the dryer. The red indicator light next to the Start button will come on. The indicator light will go off when the program ends or has been cancelled.

### STOP BUTTON

You can stop or cancel a program by pressing and holding the Stop button until the dryer stops. When you press Start, the program will start from the beginning.

### INTERRUPTING OR CANCELLING A PROGRAM

To interrupt a program, simply open the door. The dryer will stop tumbling automatically. To continue the program, close the door and press Start. The program will continue from the point it was interrupted.

To cancel a program, press and hold the Stop button

until the Stop indicator light goes off (approximately 3 seconds). You will have to reselect a program and press Start to restart the dryer.

### LED WINDOW

The LED window displays the program number for the Sensidy programs, as illustrated below:



The corresponding program numbers are:

Extra dry = P1      Normal Dry = P3  
Dry = P2            Iron Dry = P4

When you select Timed Dry, the LED displays the number of minutes selected, *plus* the cool-down time, as illustrated below:



When you select Air Fluff, the LED displays the number of minutes selected, as illustrated above. With both programs 5 and 6, as the program advances, the LED displays the remaining time.

"End" on the LED indicates the program is complete.

"C" indicates the program is in the cool-down cycle.

## PROGRAMS

Your ASKO dryer has our state-of-the-art Sensidry system. This means it has a humidity sensor that ensures different fabrics always dry thoroughly. This sensor turns off the heat when the laundry has reached the appropriate dryness.

The Extra Dry, Dry, Normal Dry, and Iron Dry programs are automatic (Sensidry) programs designed for certain types of loads, as defined in the table below. The sensor detects different levels of humidity with each program. It is important, therefore, to select the appropriate program for the type of load you are drying.

If you prefer, you can select Timed Dry, which does not

activate the humidity sensor. You should be careful when using this option not to overdry the fabrics. This program automatically uses the Low temperature setting, but you can change it to Normal by depressing the Temperature button.

When using Timed Dry, it's best to use a shorter time; then if the load isn't dry, you can set the timer for a few more minutes.

*NOTE:* Always follow the care label instruction.

<b>Program</b>	<b>Definition</b>
<b>Extra dry (P1)</b>	For items that are extremely difficult to dry, such as jeans and thick towels.
<b>Dry (P2)</b>	Cotton w/out elastic and/or decorative trim.
<b>Normal dry (P3)</b>	Cotton with elastic and/or decorative trim, linen (white and colorfast).
<b>Iron dry (P4)</b>	Synthetics, polyester, cotton/polyester blends.
<b>Timed Dry</b>	Any fabric that can be machine dried. (See note below.)
<b>Air Fluff</b>	This setting does not heat. It simply circulates the air as the clothes tumble to shake out the dust and refresh the clothes. (See note below.)

*NOTE:* When using Timed Dry and Air Fluff, you must set the number of minutes for the program to run. (See "Time" in the "Option Buttons" section below for details.)

## OPTION BUTTONS

The option buttons allow you to select program time, normal or low temperature, anti-crease, delayed start, buzzer and quick cooling. Each of these options is defined in more detail in the following paragraphs.

### TIME

If you set the program knob to Timed Dry or Air Fluff, you must select the length of drying time by pressing this button until the number of minutes you wish to dry the load displays on the LED. The time advances in 5-minute increments and you can select between 5 and 90 minutes. If you pass the time you wanted to select, continue to press the button until the correct time displays.

### ANTI-CREASE

The Anti-crease option prevents garments from wrinkling if you're unable to remove them right away. You can select one, two, or three hours by pressing the Anti-crease button until the number of hours you prefer displays, as illustrated below:



*NOTE:* "0" on the LED indicates the option is not active.

When you set a time, the drum will continue to rotate after the program is complete for three seconds every minute until the door is opened or the selected time (1–3 hours) has passed. If the buzzer is on, it will sound each time the anti-crease program activates.

### DELAYED START

This option lets you set the dryer to start at the most convenient time. This feature is also useful in areas where utility companies offer discount rates during off-peak hours. You can set delayed start from 1 hour to 24 hours, in one-hour increments.

To set a delayed start time, press the button until the number of hours you wish to delay starting the machine displays on the LED, as illustrated below:



If you pass the time you wanted to select, continue to press the button until the correct time displays. If you decide not to delay starting the unit, continue to press the button until "0" displays.

Press Start and the unit will start after the number of hours you selected has passed.

To cancel Delay Start after you have pressed the Start button, press and hold the Stop button until the LED displays the program number or, if the program knob is set on 5 or 6, the number of minutes. You can then press Start and the unit will start right then.

### TEMPERATURE CONTROL

You have two temperature options: Normal and Low. The Normal setting should be used for heavier fabrics, such as denim, cotton, linen, etc. The Low setting should be used for lighter, more delicate fabrics, such as synthetics, permanent press, acrylics, etc.

The indicator light will stay lit when Low is selected. It will remain off when Normal is selected.

## **BUZZER**

Press this button to set a buzzer to sound for three seconds when a program is complete. The indicator light will stay lit when this option is on.

If you selected the Anti-crease option, the buzzer will sound every time the drum rotates.

## **COOL-DOWN**

Every program, except Air Fluff, ends with a cool-down cycle that tumbles the clothes without heat to reduce wrinkling. The Cool-down button lets you choose between the Normal cool-down cycle (15 minutes) or a Quick cool-down cycle (5 minutes). The indicator light will stay lit when Quick is selected.

## **CHANGING OPTION SETTINGS**

You cannot change the option settings after you have pressed Start. To change a setting, hold down the Stop button until the unit stops, make your change, then press Start again. The program will restart from the beginning.

## **PROGRAM MEMORY**

The dryer is designed to retain the settings last selected with each program. For example, if you select Normal Dry, the Low temperature option, a 2-hour anti-crease, and Quick cool-down, next time you select Normal Dry these options will automatically be selected.

## **CHILD-SAFE START FEATURE**

You can program the dryer not to start unless the Start button is held down for three seconds. This is to prevent children from inadvertently starting the machine. To program this function, follow the steps below:

1. Turn the machine off then on again. ("00" should show on the LED.)
2. Press the Start button five times in succession then press the Anti-Crease button five times. (This must be done within 15 seconds.)
3. Within three seconds, press the Anti-crease button again to select Child-safe start. The LED will display "3" to indicate the Child-safe start is active. (If the child-safe start has already been activated, "0" will display after you press the Anti-crease button.)

## **T731 ERROR MESSAGES**

Error messages will display on the LED if a fault occurs while a program is in progress. The table below defines each possible error message. If the message still

displays after you have checked the possible solutions, call a service technician.

<b>MESSAGE</b>	<b>ERROR</b>
F1	Call a service technician.
F2	There may have been a power outage. Check the breaker box and fuses. The dryer is programmed to stop after a maximum of 3 hours drying time. If it has run this long, let it cool and try to start the program again. Try turning the power off then on again. If the message remains, call a service technician.
F3	This indicates a thermistor fault. Call a service technician.
F4	This indicates the overheat protection device has activated. Clean the lint filter and try running the program again.
F5	This indicates a fault in the moisture sensor. Running a dry program with dry clothes or an empty machine could also cause this error. Try opening the door. If the message remains, call a service technician.



# T761 AND T781 OPERATING INSTRUCTIONS

**WARNING!** To reduce the risk of electric shock or injury to persons, read the "Important Safety Instructions" section on page 2 before operating this appliance.

## THE CONTROL PANEL

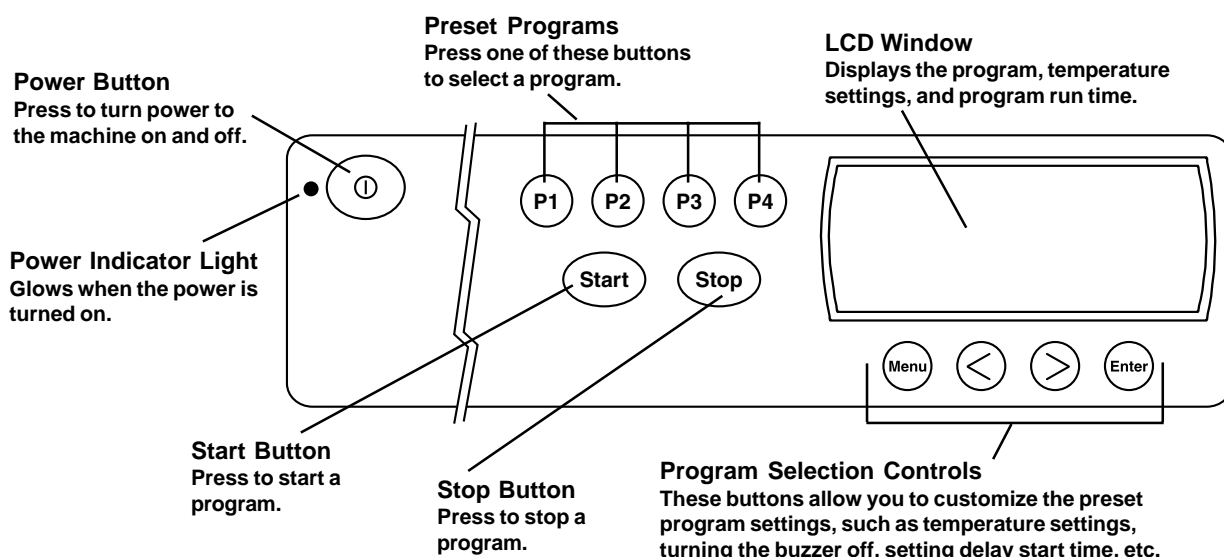

### POWER BUTTON

The Power button turns the power to the machine on and off. When the power is on, the power indicator light glows red. The power must be on before you can set the programs or start the machine.

### START BUTTON

Once you have selected a program (P1–P4) and set the desired options, press this button to start the dryer.

### STOP BUTTON

You can stop or cancel a program by pressing Stop until the dryer stops (about three seconds). If you stop the dryer this way, it cancels the program in progress.

### INTERRUPTING OR CANCELLING A PROGRAM

To interrupt a program, simply open the door. The dryer will stop tumbling automatically. To continue the program, close the door and press Start. The program will continue from the point it was interrupted.

To cancel a program, press and hold the Stop button until the dryer stops (about three seconds). To restart the dryer, you will have to reselect a program and press Start.

## UNDERSTANDING THE LCD WINDOW

The LCD window is easy to read and understand. The illustration below explains each item on the LCD window. The LCD window also displays the menus and options

available when you customize the preset programs (see page 18).

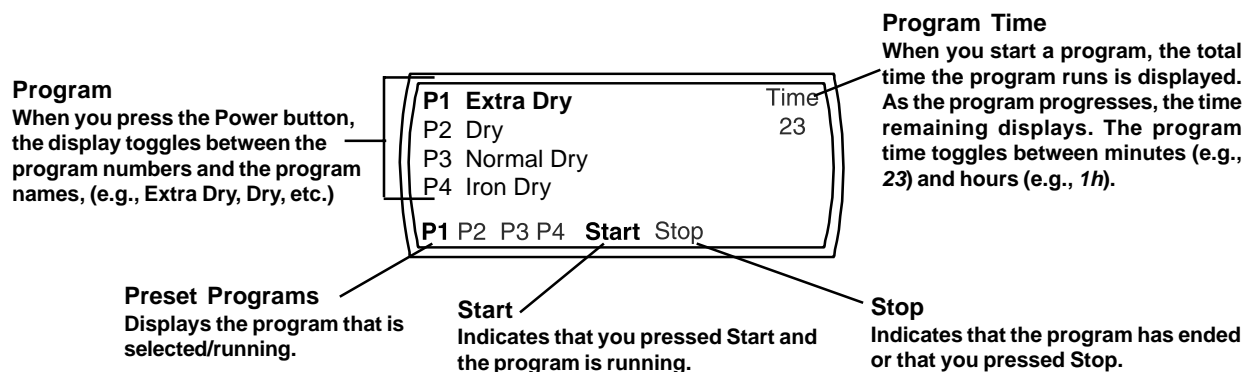

## THE PRESET PROGRAMS

ASKO dryers are delivered with the four most commonly used programs. The table below lists the preset programs and the settings for each. To select a program, simply press one of the program buttons and press Start. For additional programming options, refer to "Customizing the Preset Program Buttons" below.

With ASKO's Sensidry™ system, you need never worry about over-drying your laundry. Just select the proper program for the type of fabric you're drying and Sensidry does the rest. Once you select a program, Sensidry monitors the temperature and measures the humidity level. When it detects the appropriate measurements, it automatically shuts off the machine.

Preset Program	Dry Cycle	Dry Temp	Cooling Time	Buzzer	Anti-Crease
P1	Extra Dry	Normal	Quick <sup>(1)</sup>	On	1 hr.
P2	Dry	Normal	Quick	On	1 hr.
P3	Normal Dry	Normal	Quick	On	1 hr.
P4	Iron Dry	Low <sup>(2)</sup>	Quick	On	1 hr.

NOTES: (1) The Quick cooling time is 5 minutes.

(2) On Model T781, the dry temperature for program P4 is Normal.

**WARNING!** Some fabrics may not be able to withstand extremely hot temperatures. Always refer to the garment care label to recommended wash temperatures.

## CUSTOMIZING THE PRESET PROGRAM BUTTONS

In addition to the preset programs listed above, you can customize the preset buttons to use any of the programs listed in the table below. This table also lists the pre-programmed settings for each program. For example, if you select Normal dry on the program menu, it is automatically programmed to dry at the low temperature, cool-down for 15 minutes (normal time), run the anti-crease cycle for one hour, and set off the buzzer when the program ends. You can modify some of these settings. (See "Dry Program Options" below.)

### AVAILABLE PROGRAMS

Program	Dry Temp	Cooling Time	Anti-Crease	Buzzer
Extra dry	Normal	15 minutes	1 hour	On
Dry	Normal	15 minutes	1 hour	On
Normal Dry	Low	15 minutes	1 hour	On
Iron Dry	Low	15 minutes	1 hour	On
Air fluff	n/a	n/a	1 hour	On
Timed dry	Low	15 minutes	1 hour	On

## PROGRAM OPTIONS

The table below defines the program options. The next table lists all of the programs on the Program menu as well as the settings and options available with each.

### OPTION DEFINITIONS

Options	Definitions
<b>Cool-down</b>	This option tumbles the clothes without heat for a few minutes after the program ends to reduce wrinkling. The Normal cool-down tumbles for 15 minutes; the Quick for 5 minutes.
<b>Buzzer</b>	If this option is on, a buzzer sounds for 3 seconds at the end of the program.
<b>Anti-crease</b>	This option is designed to prevent wrinkling if you're unable to remove them from the dryer right away. After the program ends, the drum will continue to rotate for three seconds every minute until the door is opened or one hour has passed. You can turn this option off or choose 1, 2, or 3 hours.
<b>Temperature</b>	You have three temperature options: Normal, Low, and Air Fluff. Normal is for heavier fabrics, such as denim, cotton, and linen. Low is for lighter, more delicate fabrics, such as synthetics. Air Fluff does not activate the heating element. It simply circulates the air as it tumbles to shake out the dust and refresh the clothes.
<b>Delayed Start</b>	You can set a delayed start from 1 to 24 hours. This option is useful in areas where utility companies offer discount rates for off-peak hours.
<b>Timed Dry</b>	You can set the program length, from 5 to 90 minutes.

The table below lists the options available with each dry program. These options can be temporary or permanent, depending on your preference. Refer to the “Programming Instructions” setting below for detailed instructions on how to navigate the program menu and make temporary and permanent changes to the programs.

### OPTIONS AVAILABLE WITH EACH PROGRAM

Program	Dry Temp	Cooling Time <sup>(1)</sup>	Anti-Crease	Buzzer	Delay Start
Extra dry	Normal or Low	Normal or Quick	1, 2, or 3 hours	On or Off	1 to 24 hours
Dry	Normal or Low	Normal or Quick	1, 2, or 3 hours	On or Off	1 to 24 hours
Normal Dry	Normal or Low	Normal or Quick	1, 2, or 3 hours	On or Off	1 to 24 hours
Iron Dry	Normal or Low	Normal or Quick	1, 2, or 3 hours	On or Off	1 to 24 hours
Air fluff <sup>(2)</sup>	n/a	n/a	1, 2, or 3 hours	On or Off	1 to 24 hours
Timed dry <sup>(2)</sup>	Normal or Low	Normal or Quick	1, 2, or 3 hours	On or Off	1 to 24 hours

**NOTES:** (1) The Normal cool-down cycle is 15 minutes; the Quick cycle is 5 minutes.

(2) The Air fluff and Timed dry programs require you to select a program time. You can select from 5 to 90 minutes, in 5-minute increments.

### PROGRAMMING INSTRUCTIONS

Below are the basic instructions for changing a preset program. The following paragraphs explain the menus and how to navigate through them. You can make temporary (one-time) program changes, or you can make permanent changes.

1. Press the button for the preset program you want to change (**P1–P4**). The program you select will display in the lower left corner of the LCD window.

2. Press **MENU** until the menu you want to change displays (e.g., Programs, Temperature, etc.).

3. Press **>** to scroll through the available options or to toggle between off and on.

4. Press **ENTER** to save your settings and return to the Main Program screen. The LCD will display your new settings.

5. If you want to use this setting *temporarily* (for this one load), **START**. When the program ends it will revert back to the previous setting.

6. If you want to save this setting *permanently*, press **ENTER** again then press **START**. The program will retain the change. See “Navigating the Menus” below for detailed instructions on creating customized programs.

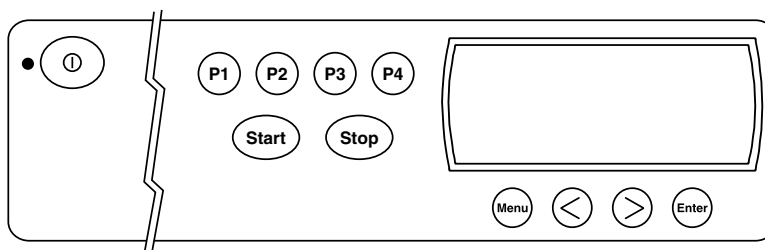

### NAVIGATING THE MENUS

The following paragraphs explain how to navigate through the menus and change the preset programs. If you don't want to make changes in all of the menus, continue to press **MENU** until the one you do want to change displays.

To restore a preset program to the factory default settings, simply press the button for the preset program (**P1–P4**) you want to restore and hold it down while you press **ENTER**. The program will revert to the factory default settings.

If you change your mind in the process of changing a program, press the Power button to switch the dryer off. When you switch the power back on, the program will be as originally set.

**Remember, the first step to customizing a preset program is to press the button for the program you want to customize (P1–P4).**

### The Program Menu

The Program menu lets you set the dry program you prefer. You would also use this menu to set the machine for a Timed Dry or Air Fluff program. (See “Timed Dry and Air Fluff” on this page.)

1. Press **MENU** until “Select Program” displays.

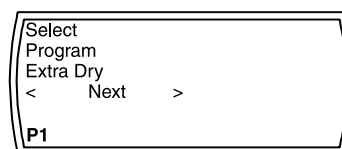

2. Press **>** to scroll through the program choices (Extra Dry, Dry, Normal, etc.)

3. When your preference displays, press **ENTER**. The LCD will display the new program setting.

4. If you only want to use this setting *temporarily* (for this one load), press **START**. When the program ends it will revert back to the previous setting.

5. If you want to save this setting *permanently*, press **ENTER** again then press **START**. The program will retain the change.

## Timed Dry and Air Fluff

When you select Timed Dry or Air Fluff on the program menu, the word "Time" and a number (of minutes) will flash in the upper right corner of the LCD window. This indicates you must select a program time (5 to 90 minutes in 5-minute increments).

1. Press **MENU** until "Select time" displays.

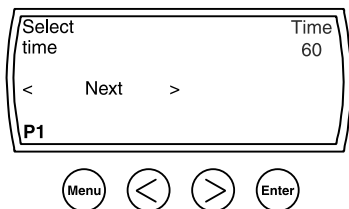

2. To change the number, simply press an **Arrow** button until the length of time you want the program to run displays.
3. If you only want to use this setting *temporarily* (for this one load), press **START**. When the program ends it will revert back to the previous setting.
4. If you want to save this setting *permanently*, press **ENTER** again then press **START**. The program will retain the change.

When you press **START**, the time remaining for the program to run displays in the bottom right-hand corner of the LCD window, as illustrated below:

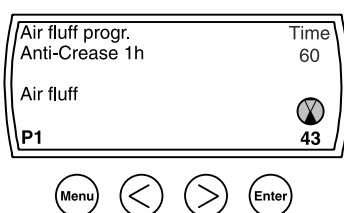

The remaining time toggles between the minutes remaining (e.g., 23) and the hour(s) remaining (e.g., 1h).

## The Temperature Menu

This menu lets you select a Normal or Low temperature. Only the temperatures available for the dry program you selected will display.

1. Press **MENU** until "Select temperature" displays.

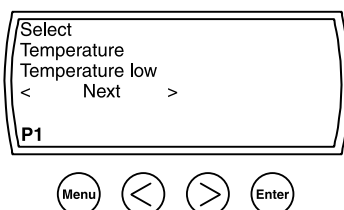

2. Use the **Arrow** buttons to toggle between the Normal and Low temperature settings.
3. If you only want to use this setting *temporarily* (for this one load), press **START**. When the program ends it will revert back to the previous setting.
4. If you want to save this setting *permanently*, press **ENTER** again then press **START**. The program will retain the change.

## The Delayed Start Program

This program lets you delay starting the dryer for up to 24 hours. This feature is useful in areas where utility companies offer discount rates during off-peak hours.

When you select Delayed Start on the program menu, you must select a delay time (1 to 24 hours).

1. Press **MENU** until "Select time for delayed start" displays.

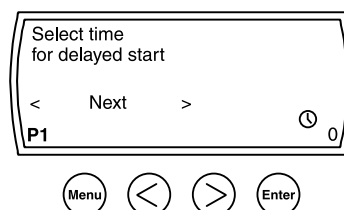

2. In the bottom right corner of the LCD window, a clockface and a zero will flash. To change the zero, simply press an **Arrow** button until the LCD displays the number of hours you want to delay starting the program (1–24 hours).
3. If you only want to use this setting *temporarily* (for this one load), press **START**. When the program ends it will revert back to the previous setting.
4. If you want to save this setting *permanently*, press **ENTER** again then press **START**. The program will retain the change.

When you press **START**, the clockface and the hours you set for the delay will display, as illustrated below:

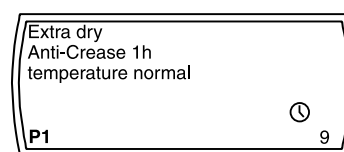

## Selecting Options

This lets you select Buzzer, Anti-crease, and Normal or Quick Cooling. Only the options available with the program you selected will display. (See tables on page 14.)

1. Press **MENU** until "Select Options" displays.
2. Continue to press **MENU** to scroll through the options.
3. Press an **Arrow** button to toggle between Off and On.
4. If you only want to use this setting *temporarily* (for this one load), press **START**. When the program ends it will revert back to the previous setting.
5. If you want to save this setting *permanently*, press **ENTER** again then press **START**. The program will retain the change.

## RESTORING A PRESET PROGRAM

To restore a preset program to its factory default settings, simply press the button (**P1–P4**) for the preset program you want to restore and hold it down while your press **ENTER**. The program will revert to its factory default settings.

## **CHANGING THE LANGUAGE ON THE LCD DISPLAY**

There are eleven languages available for the LCD window:

- |              |               |
|--------------|---------------|
| ◆ English    | ◆ Swedish     |
| ◆ French     | ◆ Danish      |
| ◆ Spanish    | ◆ Norwegian   |
| ◆ Portuguese | ◆ Netherlands |
| ◆ Italian    | ◆ Finnish     |
| ◆ German     |               |

To change the language, follow the steps below:

1. Turn the machine off then on again.
2. Press **ENTER** five times in succession then press **P1** five times. (This must be done within 15 seconds.)
3. When the Language menu displays, press an **Arrow** button to advance through the menu to the desired language.
4. Once the correct language displays, press **ENTER** to program the LCD window to display the language you selected.

## **CHILD-SAFE START**

As a safety measure, you can program the T761 and T781 not to start unless the Start button is held down for three seconds. To do this, follow the steps below:

1. Turn the machine off then on.
2. Press **ENTER** five times, then press **P3** five times. (This must be done within 15 seconds.)
3. "Delayed start" displays with "0" flashing in the lower right corner. Press the **Right Arrow** button to toggle the display to "3."

## **CHILD-SAFE MENU BUTTON**

Please note that when you set the child-safe Start button, the Menu button is *automatically* programmed to delay for three seconds before it becomes active. This prevents a child from accidentally changing the program settings.

When you want to change a program, press the Menu button for three seconds to activate the menus. The Menu button will work normally (without the 3-second delay) until you have completed your changes. If it is not pressed for two minutes, it will automatically revert back to the child-safe mode.

## **T761 AND T781 ERROR MESSAGES**

Error messages will display in the LCD window if a fault occurs while a program is in progress. The table below defines each possible error message. If the message

still displays after you have checked the possible solutions, call a service technician.

<b>ERROR MESSAGE</b>	<b>SOLUTION</b>
Maximum program time	Make sure both fuses are intact. Clean the lint filter. Make sure exhaust hose is clear (T761).
Overflow (T781)	Clear message by turning the power off then on. Make sure the condensed water container is empty. If draining into a drain pipe, make sure the black rubber hose is not kinked or blocked. The drain should not be higher than 40 inches from the floor. Make sure the condensation pump is not blocked.
Sensor	This can appear if there are dry clothes in the drum when the unit is started. Cancel the error message by opening the door or turning the power off then on.
Thermistor	Call a service technician.

## CARE AND MAINTENANCE INSTRUCTIONS

### CLEANING THE LINT FILTER

The wear on fabrics in a tumble dryer is insignificant. The lint caught in the lint filter is dust and fiber residue that has been formed when the garments have been worn. The lint filter must be cleaned after *each* load. If this is not done, drying performance will suffer, as insufficient air will pass through the drum. The machine may also overheat after a while, which will cause it to stop automatically.

To clean the lint filter, follow the steps below:

1. Grasp the handle and pull it toward you.
2. Remove the filter from the holder.
3. Open the filter and gently brush away any lint.
4. Fold the filter together and return it to the holder on the door.
5. Push the holder in until it snaps into place.

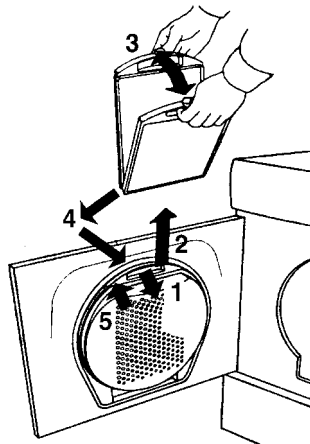

**NOTE:** If you use dryer sheets (not recommended), you may occasionally need to wash the lint filter with warm water and a soft brush to clean any blocked holes.

### CLEANING THE CONTROL PANEL

To clean the control panel, use only a soft, warm, damp (not wet) cloth. To prevent penetration of water into the door lock and electrical components, **never spray water or cleaning solvent of any kind on the control panel.**

Also, never use abrasive cleaners or scouring pads on the outer surfaces because they will scratch the finish and possibly remove the writing on the control panels. Some paper towels may also scratch the finish.

### CLEANING THE EXHAUST HOSE—T701, T731, AND T761 ONLY

About once a year you should remove the exhaust hose and clean it. At this time, you should also clean the exhaust outlet on the machine and the ventilation duct.

Periodically, you should check the dryer exhaust outside to be sure the air flow is strong and nothing is blocking the vent.

### EMPTYING THE CONDENSED WATER CONTAINER—T721 AND T781 ONLY

If the dryer is not installed to pump out the condensed water into a drain or sink, the condensation water collects in the water container to the left of the control panel. You should empty the container every three to five dryer loads, depending on the spin speed you use when you wash the clothes. For example, clothes spun at 800 rpm will have more moisture when you take them out of the washer than clothes spun at 1400 rpm. Therefore, the dryer will have to remove more water.

If the container becomes too full, the machine will shut down. To restart the program, empty the container and press Start. It may be a few minutes before the machine starts because it drains the excess water from the sump before it restarts.

**NOTE:** Do not remove the water container while the machine is running.

To empty the container, follow the steps below:

1. Slowly pull out the condensed water container. The water drains from the back, so be careful to keep the drawer handle tilted down.

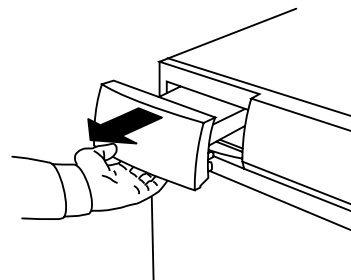

2. Pour out the water.

**NOTE:** The condensed water is soft and safe to use for watering plants.

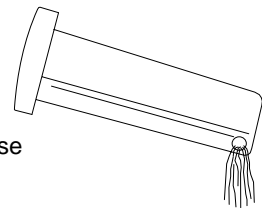

3. Replace the container. You should hear it snap into place.

# CLEANING THE CONDENSER UNIT T781

1. Turn off the main power to the machine.

2. Remove the two Torx screws on the bottom of the front panel that hold the bottom of the panel and pull it forward and

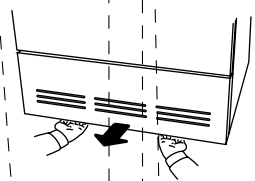

3. Unscrew the two 1/4" safety screws (A) on the bottom of the fan cover and fold down the four tabs (B).

4. Remove the fan cover



5. Hold the fan in place with a nut and screw the nut.

6. Pull out the condenser coils with a brush and water.

7. Reinstall the fan cover and screw the nut.

The condenser unit should be cleaned on a regular basis, probably every 3-4 months. If you have pets, you should probably clean it more often. To clean the condenser unit, follow the steps below:

1. Turn off the main power to the machine.

2. Remove the two Torx screws on the bottom of the front panel that hold the bottom of the panel and pull it forward and

3. Turn the fan cover on the condenser unit and fold down the four tabs (B).

4. Pull the fan cover

5. Hold the fan in place with a nut and screw the nut.

6. Pull out the condenser coils with a brush and water.

7. Reinstall the fan cover and screw the nut.

9. Turn back on the main power.

## TROUBLESHOOTING

If you experience a problem with your dryer, you should review the following list of frequently encountered situations or go to our website at [www.askousa.com](http://www.askousa.com). It could save you the cost and inconvenience of a service call.

Even though the product is under warranty, if the problem is not caused by defective product workmanship or materials, you will be charged for a service call. Refer to page 25 to determine what is and is not covered under your warranty. If you're still not sure, contact the AM Advisory Center before you call a serviceman.

### BEFORE YOU CALL

Before calling for service or contacting ASKO regarding a warranty issue, make a note of the model name, type number and serial number. The model is on the left front of the control panel. The type plate with the type name and serial numbers is located behind the door in the upper left corner. (See illustration at right.)

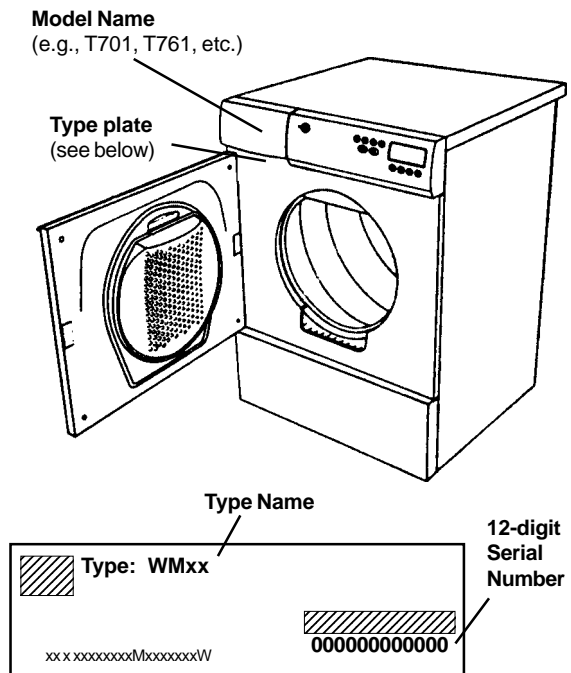

#### **The machine won't start.**

- ◆ Make sure the door is closed securely.
- ◆ Models T721/T781: Make sure the condensation tank is empty. (See page 22).
- ◆ Make sure the Power is turned on.
- ◆ Check that you set the program or time correctly.
- ◆ Check that the electric plug is securely in the socket.
- ◆ Check the house breaker/fuses and the fuses on the back of the dryer.
- ◆ If all of the above options are eliminated, the overheat protection has probably been activated. See "Overheat Protection" on page 3 for possible causes and instructions on how to restart the unit.

#### **The machine starts but it stops when I release the power button.**

- ◆ The overheating protection has probably activated. See "Overheat Protection" on page 3 for possible causes and instructions on how to restart the unit.

#### **The machine takes too long to dry my laundry.**

- ◆ Check that the lint filter is clean.
- ◆ If you use dryer sheets (not recommended), you may need to wash the lint filter with warm water and a soft brush to clean any blocked holes.
- ◆ Be careful not to overload the dryer because the warm air needs sufficient room to circulate properly and the clothes need room to tumble freely.
- ◆ The laundry should only be damp when it comes

out of the ASKO washer. If it seems too wet, try using a faster or longer spin cycle.

- ◆ Make sure the outside vent exhaust is not blocked.

#### **My clothes are coming out wrinkled.**

- ◆ You should remove the clothes as soon as the dryer signals the end of the cycle. If you can't remove the clothes right away, use the Anti-crease option.
- ◆ Dry heavy fabrics together and light fabrics together.
- ◆ Dry only permanent press items together.
- ◆ Dry in smaller loads.
- ◆ Use slower spin speeds.
- ◆ Use fabric softener in the rinse program.
- ◆ You may be using the wrong wash temperature. Try using a lower wash temperature, especially for permanent press and delicate items.

#### **The motor is running but the drum isn't turning.**

- ◆ This usually means a belt is broken. Call a servicer.

#### **The machine makes a funny noise.**

- ◆ A slight rumbling may be heard when you first turn on the dryer. This is normal and it should only last a few seconds.



# ASKO PRODUCT WARRANTY

MODELS T701, T721, T731, T761, T781

Be sure to complete the Warranty Registration Card you received with your appliance and mail it to AM Appliance Group to validate your appliance warranty.

Cosmetic damage must be reported to your dealer within five days from the date of purchase. After unpacking the dryer, thoroughly check the unit for cosmetic damage.

## FOR RESIDENTIAL INSTALLATIONS ONLY

<b>LENGTH OF WARRANTY</b>	<b>AM APPLIANCE GROUP WILL PAY FOR:</b>
<b>Three-Year Full</b> From date of purchase.	ASKO replacement parts and/or repair labor to correct defect in materials or workmanship. Service must be provided by an authorized ASKO service agent.
<b>Fourth &amp; Fifth Year Limited</b> Three year full plus fourth and fifth year limited from date of purchase.	ASKO replacement parts (labor cost not included) for any defective solid-state controls, timers, motors, or pumps. Service must be provided by an authorized ASKO service agent.
<b>Lifetime</b>	ASKO replacement parts (labor cost not included) of the stainless steel drum if it fails to hold water due to a manufacturing defect, such as rusting or cracking. Service must be provided by an authorized ASKO service agent.

## FOR NON-RESIDENTIAL INSTALLATIONS

<b>Six-Month Full Warranty</b> From date of purchase.	ASKO replacement parts and/or repair labor to correct defect in materials or workmanship. Service must be provided by an authorized ASKO service agent.
--	---

## AM APPLIANCE GROUP WILL NOT PAY FOR:

- A. Service calls to:
  - 1. Correct the installation of the appliance.
  - 2. Repair damage due to shipment, delivery, installation, misuse or abuse.
  - 3. Instruct how to use the appliance.
  - 4. Replace house fuses or correct house wiring.
  - 5. Correct house plumbing, including drainage problems related to improper installation.
  - 6. Clean or service air device in drain line.
- B. Repair and/or replacement parts for failure of product if appliance is used for other than home/residential use.
- C. Damage resulting from accident, fire, floods, acts of God, alteration, misuse, abuse, improper installation, or installation not in accordance with local electrical or plumbing codes.
- D. Any shipping costs for parts during the limited warranty period.
- E. Replacement parts or repair labor costs for units operated outside the Continental United States.
- F. Pickup and delivery. ASKO washers are designed to be repaired in the home.

## IN NO EVENT SHALL AM APPLIANCE GROUP BE RESPONSIBLE FOR ANY INCIDENTAL OR CONSEQUENTIAL DAMAGES.

Some states will not allow the exclusion or limitation of incidental or consequential damages, so this exclusion or limitation may not apply to you. This warranty gives you specific legal rights and you may also have other rights which vary from state to state.

**For warranty service, contact the dealer from whom you purchased the unit or an authorized ASKO service agent.** Service will be provided during normal business hours. Should you have a service problem that can not be resolved locally, contact AM Appliance Group at the numbers listed below. Before calling for service or contacting AM Appliance Group regarding a warranty issue, make a note of the model, type name, and serial number (see page 24).

Write to us at:  
AM Appliance Group  
P. O. Box 851805  
Richardson, Texas 75085-1805  
www.askousa.com

Or call our  
ASKO Advisory Center a  
Division of AM Appliance Group at  
800-898-1879 or  
972-238-0794

# INDEX

<b>A</b>	
Air Fluff program	
T701	12
T721	13
T731	15
T761 & T781	19
Anti-crease option	
T701	12
T721	13
T731	15
T761-T781	18
Automatic door switch	2
<b>B</b>	
Built-in installation	6
Buzzer option	
T701	12
T721	13
T731	16
T761/T781	18
<b>C</b>	
Care and cleaning	22
Care label symbols	11
Changing the LED readouts (T761/T781)	20
Child-safe start	2
T731	16
T761/T781	20
Condensation container, emptying (T721/T781)	22
Condensation drain connection (T721/T781)	5
Condenser, cleaning (T721/T781)	23
Control panel	
T701	12
T721	13
T731	14
T761/T781	17
Control panel, cleaning	22
Cool-down	3
T701	12
T721	13
T731	16
T761/T781	18
Cosmetic damage	4, 25
Customizing the preset programs (T761/T781)	18
<b>D</b>	
Damage, cosmetic	4, 25
Delayed start	
T731	15
T761 and T781	18, 20
Door, cleaning	22
Door hinges, reversing	9
Dryer features	3
Drying problems	11, 24
Drying times	10
Duct connection	4
<b>E</b>	
Electrical connections	6, 7
Energy saving tips	3
Error messages	
T731	16
T761 & T781	21
Exhaust duct	
cleaning	22
connecting	4
<b>F</b>	
Fabric softener sheets	10
Fan, cleaning	23
Freestanding installation	6
<b>H</b>	
Hinges, reversing	9
<b>I</b>	
Installation instructions	4-9
<b>L</b>	
Languages, changing the LED (T761/T781)	20
Laundry tips	10
LCD window (T761/T781)	17
LED window (T731)	14
Lint filter	22
Load sizes, recommended	10
<b>M</b>	
Magnetic door lock	2
Menus, programming (T761/T781)	19
<b>O</b>	
Operating instructions	
T701	12
T721	13, 14
T731	14-16
T761/T781	17-20
Overheat protection	3
<b>P</b>	
Power cord connection	7
Preset programs (T761/T781)	
customizing	18
restoring	20
Problem-solving	24
Program menu (T761/T781)	19
Programs and program options	
T701	12
T721	13
T731	15
T761/T781	18
<b>R</b>	
Remaining time indication	14
Restoring a preset program (T761/T781)	20
<b>S</b>	
Safety features and instructions	2
Sensidry	3
Service	25
Solutions to problems	24
Sorting the laundry	10
Specifications	4
<b>T</b>	
Temperature control	
T701	12
T721	13
T731	15
T761 & T781	18, 20
Temperature menu (T761/T781)	20
Temperature settings	10
Thermostat Control	3
Troubleshooting	24
<b>V</b>	
Ventilation duct connection	4, 5
<b>W</b>	
Warranty information	25

## Free Manuals Download Website

<http://myh66.com>

<http://usermanuals.us>

<http://www.somanuals.com>

<http://www.4manuals.cc>

<http://www.manual-lib.com>

<http://www.404manual.com>

<http://www.luxmanual.com>

<http://aubethermostatmanual.com>

Golf course search by state

<http://golfingnear.com>

Email search by domain

<http://emailbydomain.com>

Auto manuals search

<http://auto.somanuals.com>

TV manuals search

<http://tv.somanuals.com>