

How to use your tumble dryer

7005

Important:

Read all instructions before using the appliance.
The machine must be installed by a qualified
electrician.

WARNING—To reduce the risk of fire, electric shock, or
injury to persons, read the **IMPORTANT SAFETY
INSTRUCTIONS** before operating this appliance.
SAVE THESE INSTRUCTIONS!

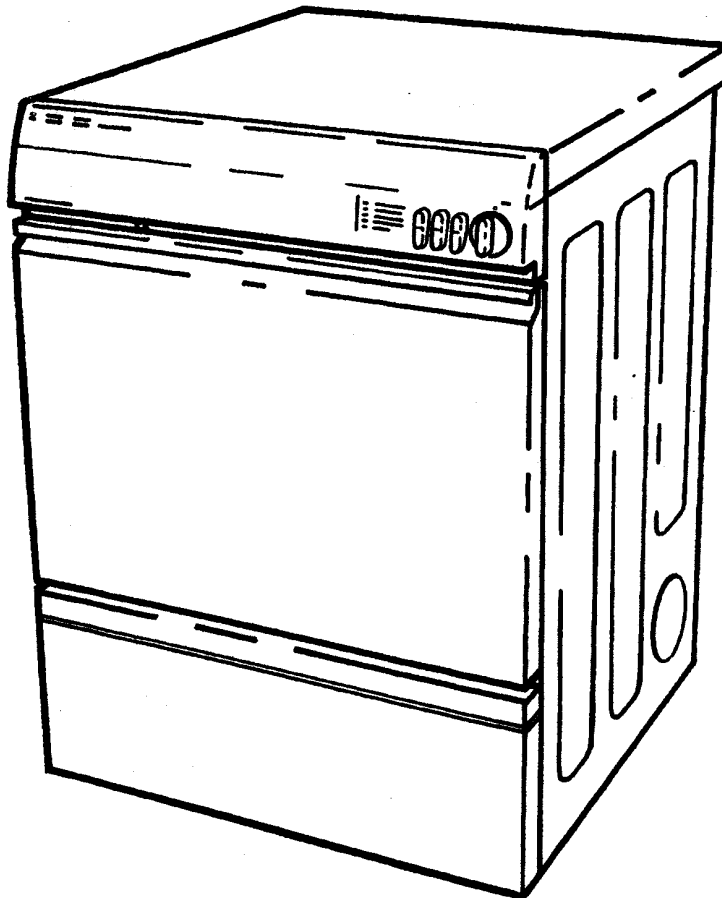

USA

WARNING - Important!

Improper connection of the equipment grounding conductor can result in a risk of electric shock. Check with a qualified electrician or serviceman if you are in doubt as to whether the appliance is properly grounded.

This appliance must be grounded. The plug must be plugged into an appliance outlet that is properly installed and grounded in accordance with all local codes and ordinances.

Do not wash or dry articles that have been previously cleaned in, washed in, soaked in, or spotted with gasoline, dry-cleaning solvents, other flammable or explosive substances as they give off vapors that could ignite or explode.

Instructions for use

Follow the figures in the strip through these instructions for a brief summary of how to use the machine. Further details and hints are given below the strip.

Contents

Instructions for use	2
Parts of the tumble dryer	2
Sorting fabrics	3
Which program to use?	4
If the machine does not work	5
Cleaning the fluff filter	5
How the dryer works	6
Safety	6
Electrical installation	7
Specifications	7
Drying times and energy consumption	7
Installation	8-10
Positioning the tumble dryer	8-9
Changing the door hingeing	10
Electrical installation	10
Warranty	11
Instructions summary	12

NOTE!

Items to be tumble-dried must first have been spin-dried, preferably at 800 rpm or more.

Parts of the tumble dryer

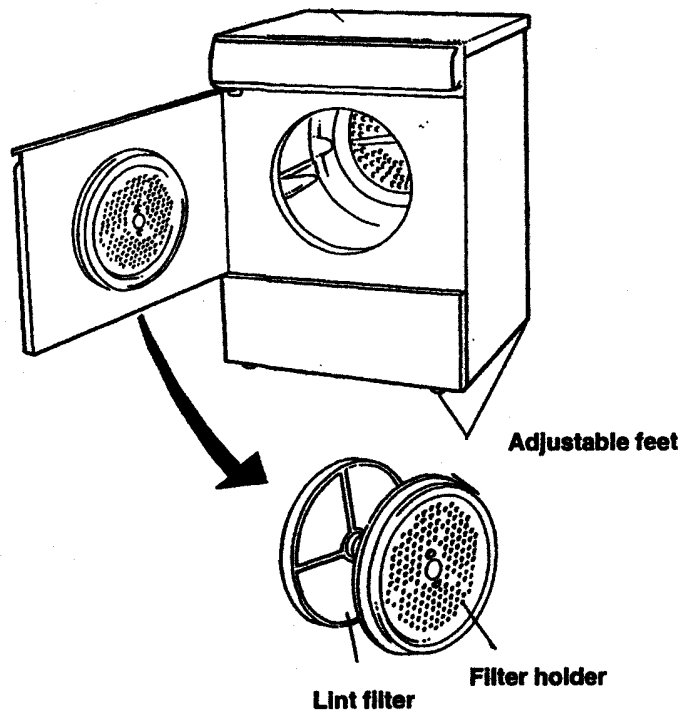

Control panel

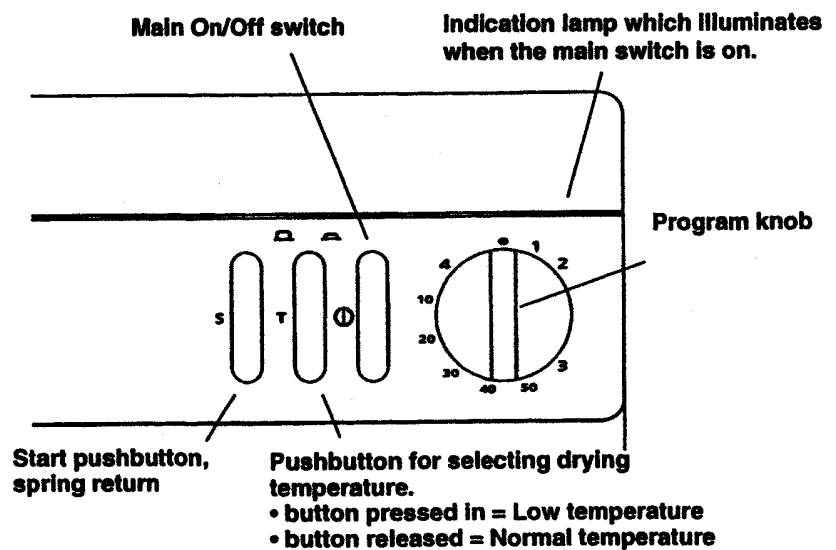

- ① Load the washing to be tumble-dried and close the door.

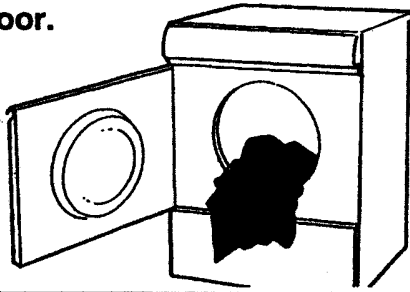

- ② Select the drying temperature:
pushbutton pressed in = Low temperature
pushbutton released = Normal temperature

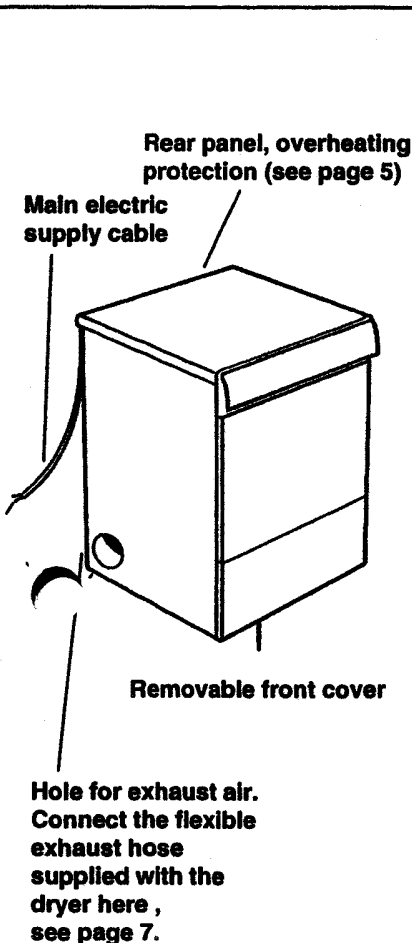
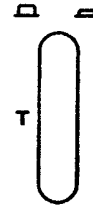

Sorting fabrics



Materials suitable for tumble drying

For the best drying results, clothes should be sorted properly. Separate the lint shedders (chenille and terry cloth) from the lint collectors (synthetics, flannel and fabrics with a nap, such as velveteen and corduroy). Separate non-colorfast from light colored items, heavy fabrics from light weight fabrics and permanent press from heavy, bulky items.



Do not tumble dry

Read all permanent care labels carefully. If a garment's care label says "Drip dry", "Line Dry" or "Dry Flat", do not dry in the dryer. Certain materials will melt or become dangerously flammable if heated, while others may lose their shape. Other items that should not be tumble dried are:

- Items that have been dry-cleaned at home.
- Wool (unless the garment's manufacturer recommends it)
- Fiberglass
- Laminated or rubber coated items
- Vinyl or plastic
- Do not use fabric softeners or products to eliminate static unless recommended by the manufacturer of the fabric softener or product.

Note: SAFETY

Do not allow children to play on or in the appliance. Close supervision of children is necessary when the appliance is used near children.

Type of washing	Temperature
White wash, colored wash (cotton, linen)	Normal
Synthetics permanent press (polyester, cotton)	Normal
Delicate wash, Mild delicate wash, Temperature-sensitive materials such as acrylics, rayon and acetate	Low

Use the T button to set the machine for tumbling at low temperature. Otherwise the temperature will automatically go up to normal temperature (i. e. the T button is released).

- ③ Set the required program using the program knob

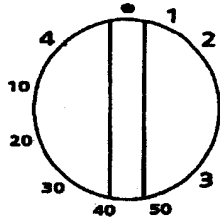

- ④ Press the main On/Off switch...



... and the Start pushbutton
The indicating lamp will light

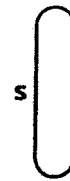

The start pushbutton springs out again after use.

Which program to use

The program to be used depends on what is to be done with the washing after tumble-drying. Two automatic programs are provided: Extra dry and Dry. If washing is not to be dried completely, e.g. because it is to be ironed, it is a good idea to use the time program instead.

Either of the operating temperatures (Low or Normal) is available with either of the automatic programs or with the time program.

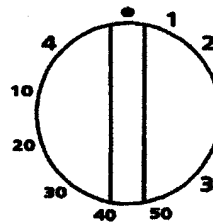

Turn the program knob clockwise to the required program.

A program can be stopped at any time by turning the knob to the 0 position.

When you want extra dry fabrics

1. Extra dry

This automatic program is intended for use with washing that is extremely difficult to dry, e.g. jeans with very thick seams. The heat is turned off when the washing is completely dry, and is followed by a cooling period of about 15 minutes.

When you want dry fabrics

2. Dry

This program turns off the heat when the washing is dry, but not absolutely bone-dry. It is then cooled for about 15 minutes.

When you want to iron fabrics

3. Timed program

The timed program can be set for any desired heating time up to one hour. At the end of the preset time, the washing is cooled for about 15 minutes.

Drying time depends on

When you want to air fabrics

4. Airing program cold

This program cannot be combined with heating. It is used to shake the dust out of garment, air them or soften them up.

If the washing is not dry

When using the automatic programs, it can happen that not all of the washing is properly dry. This may be due to such reasons as very heavy fabrics or thick seams. To dry these items, give a further period of drying in the timed program for about 10 minutes. Also do not overload the dryer. If a dryer is overloaded, its efficiency is lessened and clothes may not dry evenly.

Do not over-dry

When using the timed program, it is possible to over-dry fabrics, if too long a time has been set. This can cause the fabrics to wrinkle, shrink, or feel harsh. Synthetic materials can also become charged with static electricity.

Dryer added fabric softeners

Because some dryer added fabric softeners may cause damage to automatic dryers, use only ones that the manufacturers give a written assurance that their softener can safely be used in your dryer.

Single items

Use the timed program when there is only one item to be dried. This is because the automatic program may turn off the heating too early, so that the item is not properly dried.

Permanent press hints

For the most wrinkle free permanent press drying, only dry one half load at a time to assure enough room for items to tumble freely. Do not combine permanent press items with other very heavy clothes in the dryer. Remove clothes immediately after the drying cycle is completed and either hang them up or lay them flat.

- ⑤ If you want to check how dry the washing is:
Open the door.

The drum stops automatically and will not restart until you close the door and press the Start pushbutton.

The dryer signals when washing is ready

When the program that has been used has finished, the dryer stops and two signals sound. When drying permanent press fabrics, best results will be obtained if they are removed as soon as possible after the program has stopped.

- ⑥ When the dryer has stopped:

- Remove the washing
- Clean the lint filter
- Turn off the power at the main On/Off pushbutton switch

If the machine does not work

The machine will not start

Check that:

- * the door is properly closed.
- * the On/Off pushbutton is pressed in.
- * you have set the required program or the required time correctly.
- * the electric plug is firmly inserted in its socket (if the machine is not permanently wired in).
- * all fuses are intact.

NOTE! If the machine still fails to start, it is probable that the overheating cutout has operated. It switches off the tumbler if the temperature is too high, for example if dust has blocked the lint filter. Clean the filter and reset the overheating protection switch by pressing the rubber disc on the back of the machine.

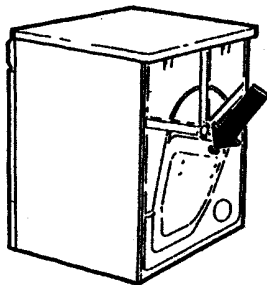

The machine starts, but will not continue to run

If the machine starts when the Start button is pressed, but stops as soon as the button is released, it indicates that the overheating cutout has operated. Clean the lint filter and allow the machine to cool down.

Excessive drying time

Check that the lint filter is not blocked. Do not overload the dryer. Items to be tumble-dried must first have been spin-dried, preferable at 00 r/min or more.

NOTE: When you start the dryer for the first time, a slight rumbling may be heard during a short warming-up period. When the dryer is run-in, this sound will disappear.

Cleaning the lint filter

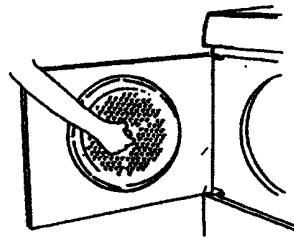

Filter holder

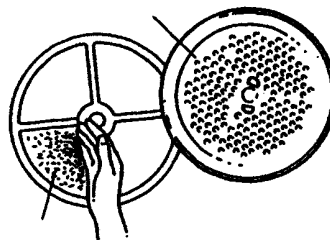

Fluff filter

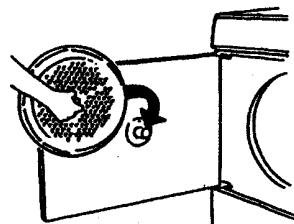

The lint filter must be cleaned after each time the machine has been used. If this is not done, drying performance will suffer, as insufficient air will pass through the drum. The machine may also overheat: this will cause it to stop automatically.

Clean the filter as follows:

1. Grasp the filter holder by the two holes near the center and pull it off the peg on which it is supported in the front door.
2. Take the filter out of the holder and brush away the lint in it by hand.

NOTE! Wear and tear of fabrics in a tumble dryer is insignificant. The lint caught in the lint filter is dust and fiber residue that has been formed when the garments have been used.

3. Replace the filter in the holder and refit the holder in position on the peg in the door.

NOTE! Clean lint collecting near the tumble dryer as it can be sucked into the air intake.

Other user service

About once a year, remove the exhaust air hose and clean it and the outlet from the machine.

How the dryer works

- 1 Air is drawn from the room through the bottom of the machine.
- 2 An electric heater heats the air passing into the drum.
- 3 Warm air enters the drum through holes in the back and dries the washing. The drum rotates, and the two paddles prevent garments from becoming tangled.
- 4 The air passes through the lint filter and the front of the drum and enters the fan.
Air is forced out through the outlet through a fixed duct (see page 10)

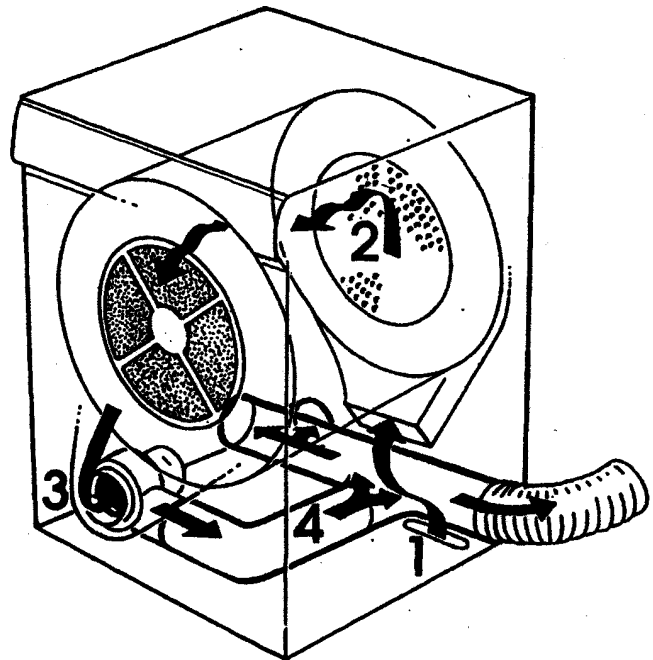

The temperature remains at approximately 40° C (104° F) as long as the clothes are moist. When the clothes dry, the temperature rises and the heater element is automatically switched off at the preset temperature. The air that is not heated is then drawn through the drum and cools the clothes for about 15 minutes.

The thermostats which switch off the heating at normal and low temperature 60° C (140° F), 45° C (113° F) are fitted next to the fan. There are also two thermostats next to the heater element. One switches off the heater element if the temperature becomes too high and the other switches off the

complete tumble dryer if a fault occurs. This overheating protection, which is fitted at the rear of the machine, can be reset when the temperature has fallen. Refer to the section entitled "If the machine does not work" (page 5).

Important Safety Instructions

WARNING - To reduce the risk of fire, electric shock, or injury to persons when using your appliance, follow basic precautions, including the following:

1. Read all instructions before using the appliance.
2. Do not wash or dry articles that have been previously cleaned in, washed in, soaked in, or spotted with gasoline, dry-cleaning solvents, other flammable or explosive substances as they give off vapors that could ignite or explode.
3. Do not allow children to play on or in the appliance. Close supervision of children is necessary when the appliance is used near children.
4. Before the appliance is removed from service or discarded, remove the door to the washing or drying compartment.
5. Do not reach into appliance if the tub, agitator, or drum is moving.
6. Do not install or store this appliance where it will be exposed to the weather.
7. Do not tamper with controls.
8. Do not repair or replace any part of the appliance or attempt any service unless specifically recommended in the user-maintenance instructions or in published user-repair instructions that you understand and have the skills to carry out.
9. Do not use fabric softeners or products to eliminate static unless recommended by the manufacturer of the fabric softener or product.
10. Do not use heat to dry articles containing foam rubber or similarly textured rubberlike materials.
11. Clean lint screen before or after each load.
12. Keep area around the exhaust opening and adjacent surrounding areas free from the accumulation of lint, dust, and dirt.
13. The interior of the machine and exhaust duct should be cleaned periodically by qualified service personnel.
14. The dryer door has a magnetic lock, which means that it can be opened from the inside. A door switch automatically stops the dryer if the door is opened. The machine does not start automatically if the door is closed, e.g. if a child should get into the drum and close the door from the inside. In order to restart the machine, the Start pushbutton must be pressed.
15. The machine is protected by a thermostat fitted by the heating element, which turns the machine off if the temperature is too high.

Specification

Height	32 1/4" (820 mm)
Width	23 1/2" (595 mm) + exhaust hose connection
Depth	23 1/2" (595 mm), including control panel and program knob
Depth - Door open	46" (1170 mm)
Weight	86 lbs. (39 kg)
Speed	52 rpm
Drum material	Stainless steel
Outer casing	Galvanised steel sheet
Installation	Free-standing, build- in or on top of a washing machine
Power requirement	3150 W
For connection	Double-phase, 208-240 V, 30 A
Internal fuse	15 A
Power requirement	3150 W

Air evacuation

The air evacuation can be connected at the rear. When the machine is belvered, one at the rear is open.

The tumble dryer is supplied with a stub pipe. A UL-CSA hose must be supplied by the consumer or installer.

Fit the air evacuation as follows:

- Push the hose onto the stub pipe and fasten a clamp.
- Insert the stub pipe with the hose into the hole.

WARNING – To reduce the risk of fire, this appliance **MUST BE EXHAUSTED OUTDOORS** or the equivalent.

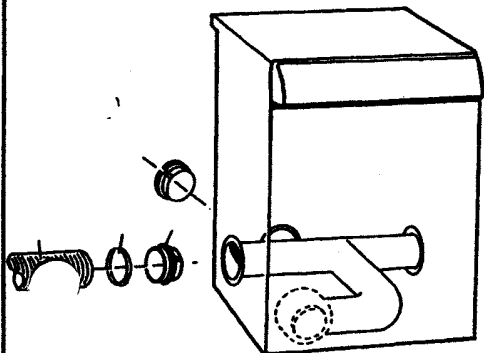

Drying times and energy consumption

Drying times and energy consumption

The table below shows drying times and energy consumption in accordance with the following conditions:

- Program 2 has been used (the normal "Dry" automatic program).
- Drying temperature Normal
- Fabrics dried are of cotton, previously spun at 800 r/min.
- The dryer is in a room with a temperature of 20° C (68° F), and the exhaust hose supplied with the machine is in use.

Drying times

many factors, such as the amount of washing, moisture content, type of fabric, air temperature and humidity. Performance can also be affected by how the machine has been installed. Drying time is also naturally affected by how dry the washing is to be when removed from the machine.

Connection to a ventilation duct

Connect the exhaust hose to a ventilation exhaust fitting or to a discharge through the wall.

Secure the hose joint to the outlet stub on the machine.

Run the hose with as few bends as possible to the point of discharge. If necessary, it can be extended to a maximum of 22 feet of 4" diameter hose.

Make any bends as gentle as possible. A maximum of four 90° bends may be fitted in the hose. The more bends and the longer the hose, the less will be the amount of air passing through the machine.

If more than 22 feet of hose is needed, diameter must be increased to 6" or 8".

If the hose is taken to a wall outlet, a ventilation grille should be fitted to prevent reverse flow of cold air.

IMPORTANT!

The appliance should not be exhausted into a chimney, a wall, a ceiling, or a concealed space of a building. The only rigid or flexible metal duct should be used for exhausting, unless the appliance has been investigated for use with nonmetallic duct.

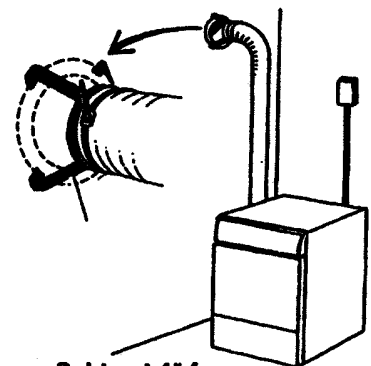

Subtract 4" for every 90° elbow

Fit the ventilation grille to the inside or outside of the wall

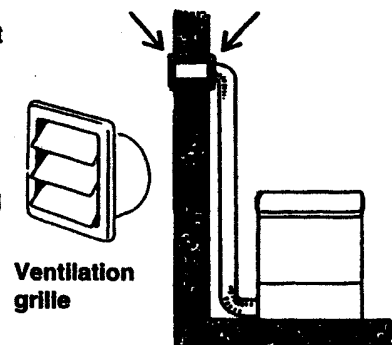

Ventilation grille

Installation

(It is essential that the machine is leveled and the locknuts are tight.)

Positioning of the tumble dryer:

A Free-standing installation

The dryer can be placed next to a washing machine.

Locknut

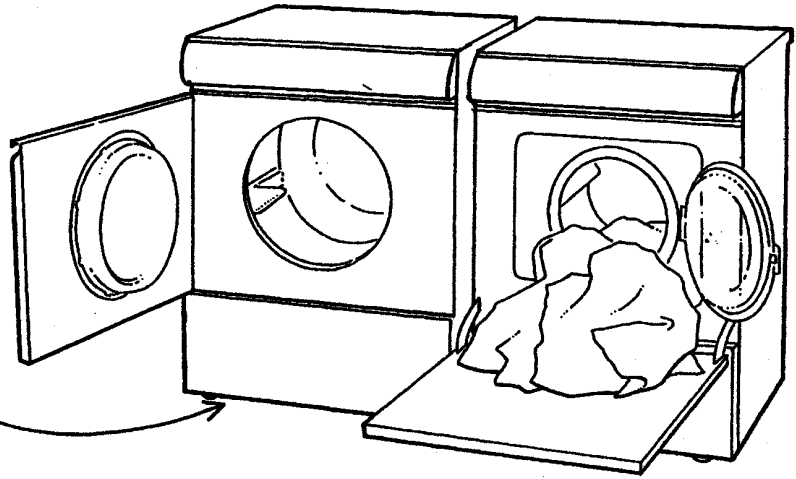
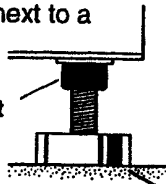

B Built in

The dryer can be built in beneath a countertop with a height of 33 1/2–35 1/2". At least 23 5/8" width is needed.

Space must also be available for the exhaust hose on the left, right or rear of the machine. See the diagram for hole sizes and positions.

NOTE:

Height Adjustment: 32 1/4–33 1/2".
Do not Raise Higher than 33 1/22.

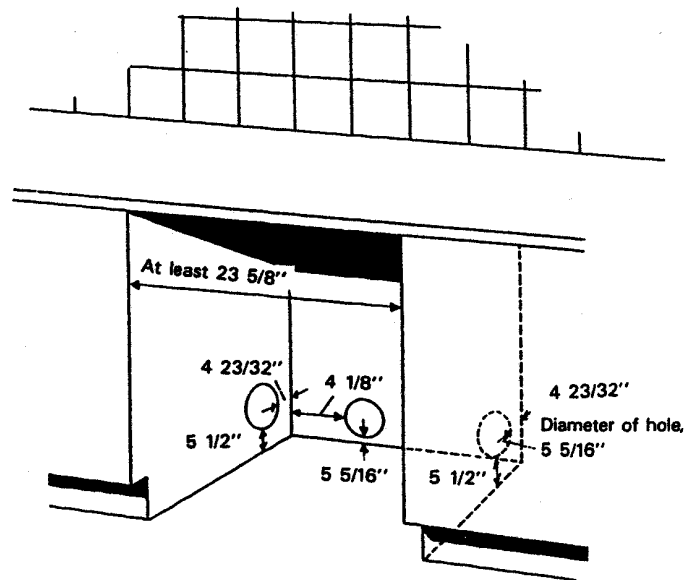

How much air does the dryer need?

The dryer needs about 196 cubic yards of fresh air per hour. The room in which it is installed must therefore have a sufficient air change rate to ensure that the machine receives enough fresh air.

Energy saving hints

- Dry consecutive loads to avoid reheating the dryer.
- Do not overload the dryer.
- Do not put unspun, very wet items in the dryer.
- Clean the lint filter after each load.
- Do not over dry clothes when using the timed program.
- If you plan on ironing items, remove them while still slightly damp.
- Leave the door closed while the dryer is in operation.

C. Stacked Installation

The dryer can be mounted on top of any ASKO matching washing machine. Use the mounts supplied with the machine.

These parts are supplied with the tumble dryer:

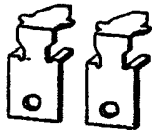

2 metal brackets for securing the tumble dryer

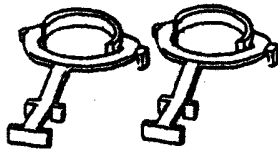

2 plastic cups

How to install the tumble dryer on top of a washing machine

1. Remove the screws shown from the back of the washing machine, and use them to secure the two brackets.

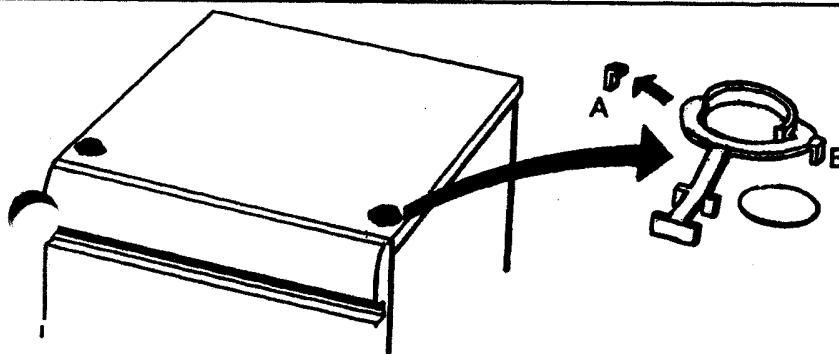
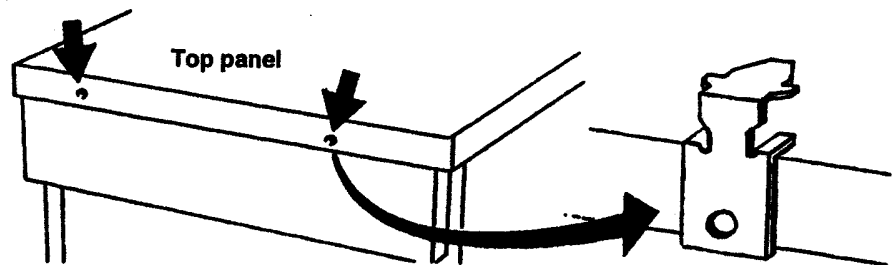

The edge of the detergent compartment

Side of the top panel

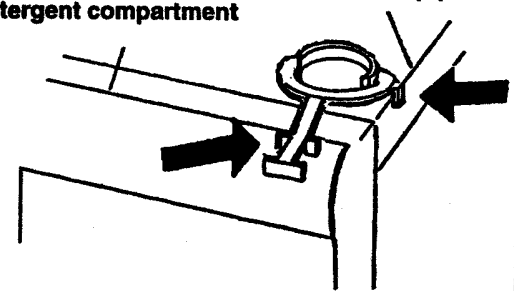

2. Fix the plastic cups which locate front feet of the tumble dryer on top of the washing machine. This is important, as they ensure that the machine is safely positioned on top of the washing machine. Break off tab A on the plastic cup to be fitted on the right-hand side of the machine, and tab B from the cup to be fitted on the left-hand side of the machine. Remove the protective paper from the self-adhesive surface beneath the cups. Taking care not to press the exposed adhesive surface

against the top of the washing machine, so that the cups fasten before being properly located, position the cups so that the tabs indicated by the arrows (see right-hand drawing) locate the cup exactly with respect to the front and sides of the machine. When the cups are properly positioned as shown, press them firmly down on to the top of the washing machine. Finish by breaking off the plastic tabs, which have now served their purpose.

3. Lift the tumble dryer into position, raise the front edge and push the machine backwards until it engages with the brackets.

Lower the front of the dryer, making sure that its feet drop into the plastic cups.

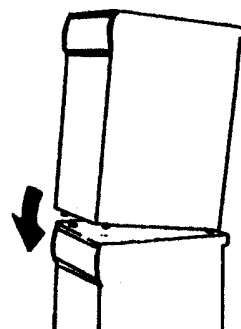
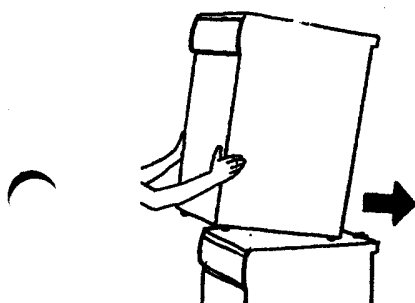

Tumble dryer

Washing machine

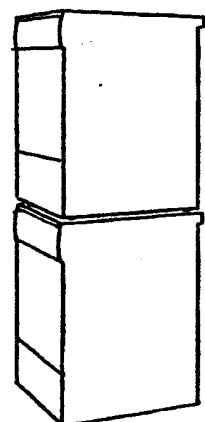

Changing the door hinging...

Switch off the main power supply first!

Tools: Phillips screwdriver, 10 mm wrench.

1. Remove the lower panel A.
2. Unscrew the upper screw B + C.
3. The upper hinge is now loose. Raise the door a little so that it comes away from the bottom hinge. Remove the top hinge.
4. Move the hinge pin J to the other hole in the hinge using 10 mm wrench.
5. Push out the hinge bearings from the old holes in the door.
6. Take the door apart by removing all screws which are around the edge of the door.
7. Undo magnet cap D.
8. Remove the cover washer from the magnet position E on the other side.
9. Screw the magnet tight at E (spring plus washer plus screw) and insert cover washer in the hole at D.
10. Screw the door together.
11. Remove the plug from the new hole for the hinge at H. Insert this plug in the old hinge hole.
12. Knock out the hole at the lower hinge hole K using a screwdriver. Insert the plug supplied in the old hinge hole.
13. Fit the hinge bearings in the new hinge hole.
14. Unscrew the lower hinge and move the hinge pin as shown in Item 5 above.
15. Remove the plastic protection at F and G and place this where the hinge was previously fitted.
16. Tighten the top hinge.
17. Screw in screw B for the bottom hinge a few turns.
18. Insert the lower hinge pin in the door hole. Place the door's top hinge hole on the upper hinge pin. Place the door and the lower hinge in position in screw B that has already been fitted. Screw in screw C.
19. Adjust the lower hinge so that the door hangs straight. Tighten screws B and C.
20. Refit the lower panel.

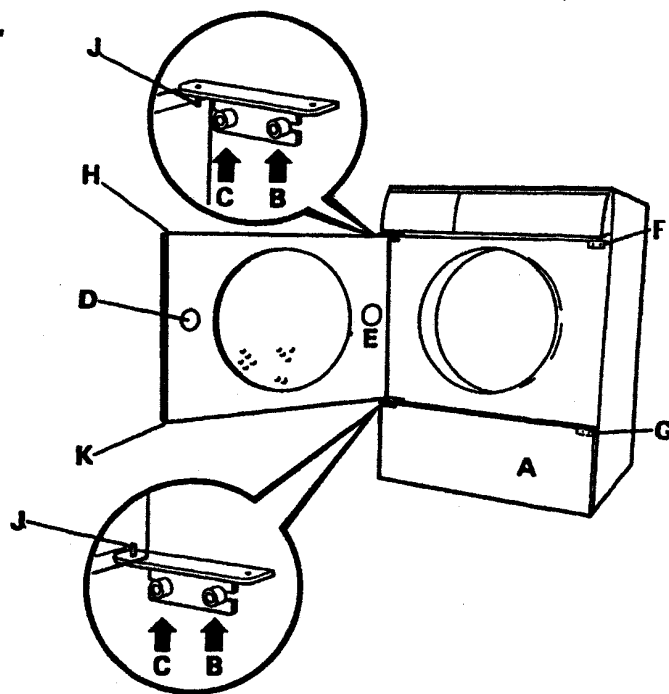

Electrical installation

The machine is delivered ready-fitted with a plug, and is intended for connection to a single-phase supply. The supply must be earthed. If the machine is to be used in a wet area, the supply must be protected by a residual current device.

Connection to a permanently wired supply point must be made only by a qualified electrician.

As supplied: 1-phase, 208-240 V, 60 Hz
2850 W heater rating,
30 A fuse required

NOTE: On rear of the machine there is a receptacle only dedicated ASKO washing machines, rated 208-240 V. In use of this receptacle, delivered ready-fitted plug or an equal must be used. The supply connection must be 208-240 V, 30 A. ASKO washing machines rated 208-240 V have an internal fuse of 15 A.

GROUNDING INSTRUCTIONS

This appliance must be grounded. In the event of malfunction or breakdown, grounding will reduce the risk of electric shock by providing a path of least resistance for electric current. This appliance is equipped with a cord having an equipment-grounding conductor and a grounding plug. The plug must be plugged into an appropriate outlet that is properly installed and grounded in accordance with all local codes and ordinances.

WARNING - Improper connection of the equipment-grounding conductor can result in a risk of electric shock. Check with a qualified electrician or serviceman if you are in doubt as to whether the appliance is properly grounded. Do not modify the plug provided with the appliance - if it will not fit the outlet, have a proper outlet installed by a qualified electrician.



ASKO Product Warranty

Home Clothes Washers and Dryers

For Residential Installations

Length of warranty	ASKO will pay for:
ONE YEAR FULL WARRANTY From date of purchase	ASKO replacement parts and/or repair labor to correct defect in materials or workmanship. Service must be provided by an authorized ASKO service outlet.
FIVE YEAR LIMITED WARRANTY One year full plus second through fifth year limited from date of purchase.	ASKO replacement parts (repair labor costs not included) for any defective solid state controls, timers, motors, pumps.
TWENT-FIVE YEAR LIMITED WARRANTY One year full plus second through twentyfive year limited from date of purchase.	ASKO replacement parts (repair labor costs not included) for the stainless steel inner and outer drum/tub if it fails to hold water due to a manufacturing defect such as cracking or rusting.

For Non-Residential Installations

SIX MONTHS FULL WARRANTY FROM DATE OF PURCHASE	ASKO replacement parts and/or labor to correct defect in materials or workmanship. Service to be provided by an authorized ASKO service outlet.
---	---

<p>ASKO will not pay for:</p> <p>A. Service calls to:</p> <ol style="list-style-type: none"> 1. Correct the installation of the washer or dryer 2. Instruct how to use the washer or dryer 3. Replace house fuses or correct housing wiring 4. Correct house plumbing 5. Cleaning or servicing of the button trap, outlet pump of the washer 6. Cleaning or serving of the lint filter or condensing unit of the dryer <p>B. Repair and/or parts for failure of product if washer or dryer is used in other than normal use.</p> <p>C. Damage resulting from accident, fire, floods, acts of God, alteration, misuse abuse, improper installation or installation not in accordance with local electrical or plumbing codes.</p> <p>D. Any labor or shipping costs for parts during the limited warranty.</p> <p>E. Replacement parts or repair labor costs for units operated outside the Continental United States.</p> <p>F. Pick-up and delivery. ASKO products are designed to be repaired in the home.</p>

IN NO EVENT SHALL ASKO INC. BE RESPONSIBLE FOR ANY INCIDENTAL OR CONSEQUENTIAL DAMAGES.

Some states will not allow the exclusion or limitation of incidental or consequential damages, so this exclusion or limitation may not apply to you. This warranty gives you specific legal rights and you may also have other rights which vary from state to state.

For warranty service, contact the dealer from whom you purchased the unit or an authorized ASKO service outlet. Service will be provided during normal business hours. Should you have a service problem that is not resolved locally write:

ASKO USA INC.
P O Box 851805
Richardson, TX 75085-1805

How to use the tumble dryer

1. Load the washing to be tumble-dried and close the door.

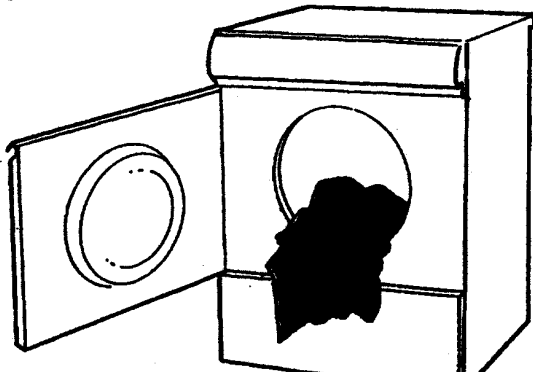

2. Select the drying temperature:

Pressed in: Low
Released: Normal

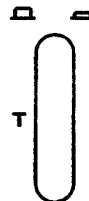

Normal:
Whites
Coloureds
Synthetics
Permanent Press

Low
Acrylics
Delicate items

3. Set the required program using the program knob.

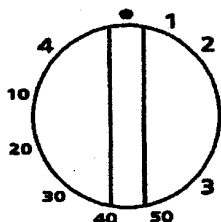

1 Extra dry (Automatic program)

2 Dry (Automatic program)

3 Timed program. Set the required time (up to one hour) and the required temperature

4 Airing program (No heat)

Normal program when dry washing is wanted.

4. Press the main On/Off switch and the Start pushbutton.

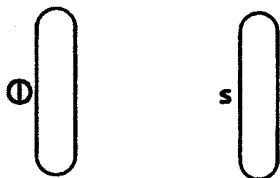

If you want to check how dry the washing is:

- * Open the door. The drum stops automatically.
- * Restarting: Close the door and press the Start pushbutton

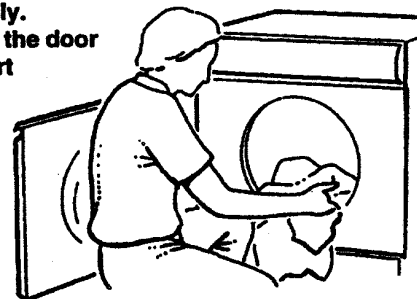

When the dryer has stopped:

- * Remove the washing
- * Clean the lint filter (see page 5)
- * Turn off the power and the main On/Off pushbutton switch



Do not tumble dry items labeled "Drip Dry", "Line Dry" or "Dry Flat".

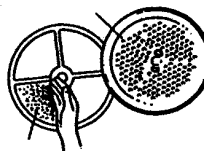

Clean the lint filter *each* time the machine has been used.

Free Manuals Download Website

<http://myh66.com>

<http://usermanuals.us>

<http://www.somanuals.com>

<http://www.4manuals.cc>

<http://www.manual-lib.com>

<http://www.404manual.com>

<http://www.luxmanual.com>

<http://aubethermostatmanual.com>

Golf course search by state

<http://golfingnear.com>

Email search by domain

<http://emailbydomain.com>

Auto manuals search

<http://auto.somanuals.com>

TV manuals search

<http://tv.somanuals.com>