

ASHLY

DPX-200

Parametric Equalizer Compressor/Limiter

Operating Manual

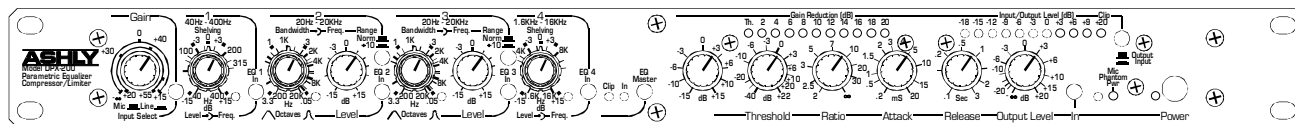

ASHLY AUDIO INC.

847 Holt Road Webster, NY 14580-9103 Phone: (585) 872-0010
Toll-Free: (800) 828-6308 Fax: (585) 872-0739 Internet: www.ashly.com

Table Of Contents

1	INTRODUCTION	3
2	UNPACKING	3
3	AC POWER REQUIREMENTS	3
4	MECHANICAL INSTALLATION	4
5	PARAMETRIC EQUALIZER CONTROLS	4
5.1	Equalizer Input Select Switch	4
5.2	Gain	4
5.3	Phantom Power	4
5.4	Shelving Filters	4
5.5	Parametric Filters	4
5.6	EQ Clipping	4
5.7	EQ Master Switch	4
6	COMPRESSOR/LIMITER CONTROLS	5
6.1	Gain	5
6.2	Threshold	5
6.3	Ratio	5
6.4	Attack Time	6
6.5	Release Time	6
6.6	Output Level	6
6.7	In/Out Switch	6
6.8	Threshold/Gain Reduction Display	6
6.9	Input/Output Meter Display	6
7	CONNECTIONS AND CABLES	7
7.1	Balanced and Unbalanced Audio Connections	7
7.2	Inputs and Outputs	7
7.3	Chain Switch	7
7.4	Compressor/Limiter Detector Loop/Ducking	7
8	TYPICAL APPLICATIONS	8
8.1	Parametric Equalizer Applications	8
8.2	Compressor/Limiter Applications	9
8.3	Special Effects	10
9	DESIGN THEORY	11
10	BLOCK DIAGRAM	14
11	TROUBLESHOOTING TIPS	14
12	WARRANTY INFORMATION	15
13	SPECIFICATIONS	15
14	DIMENSIONS AND SCHEMATICS	16

1. INTRODUCTION

The Ashly DPX-200 combines a four band parametric equalizer and full function peak compressor/limiter in a single rack space product. Both equalizer and compressor/limiter can be used as stand-alone processors, or can be automatically chained together with a back panel switch.

Parametric EQ filters offer custom tailoring of equalization solutions. Where a graphic EQ boosts or cuts fixed frequencies, a parametric EQ boosts or cuts tunable frequencies. The DPX-200 parametric equalizer uses two tunable shelving filters along with two fully adjustable, 20Hz-20KHz parametric filters, resulting in very precise control of frequency response.

The Ashly compressor limiter circuit was designed in response to the need for universal peak-sensitive automatic gain control (AGC) devices with exceptional audio performance and rugged durability. The result is a wide-bandwidth, ultra-low-distortion, low noise VCA (voltage controlled amplifier) which is versatile and highly listenable.

Premium components are used throughout the DPX-200, and computerized automatic assembly equipment verifies that each component's electrical specifications are within tight tolerances before becoming part of the circuit assembly. Each finished unit is then tested twice before leaving the factory, guaranteeing you a worry-free, professional product for many years.

Please read this instruction manual thoroughly before operation so that you may realize all the features and benefits the Ashly DPX-200 has to offer.

2. UNPACKING

As a part of our system of quality control, every Ashly product is carefully inspected before leaving the factory to ensure flawless appearance. After unpacking, please inspect for any physical damage. Save the shipping carton and all packing materials, as they were carefully designed to reduce to minimum the possibility of transportation damage should the unit again require packing and shipping. In the event that damage has occurred, immediately notify your dealer so that a written claim to cover the damages can be initiated.

The right to any claim against a public carrier can be forfeited if the carrier is not notified promptly and if the shipping carton and packing materials are not available for inspection by the carrier. Save all packing materials until the claim has been settled.

3. AC POWER REQUIREMENTS

A standard IEC-320 AC inlet is provided on the rear panel to accept the detachable power cord shipped with the unit. Units distributed within the United States are for 120V AC. Units distributed outside the United States are for 240V AC. A standard IEC-320 AC inlet is provided on the rear panel to accept the detachable power cord shipped with the unit. Units distributed within the United States are for 120V AC. Units distributed outside the United States are for 240V AC.

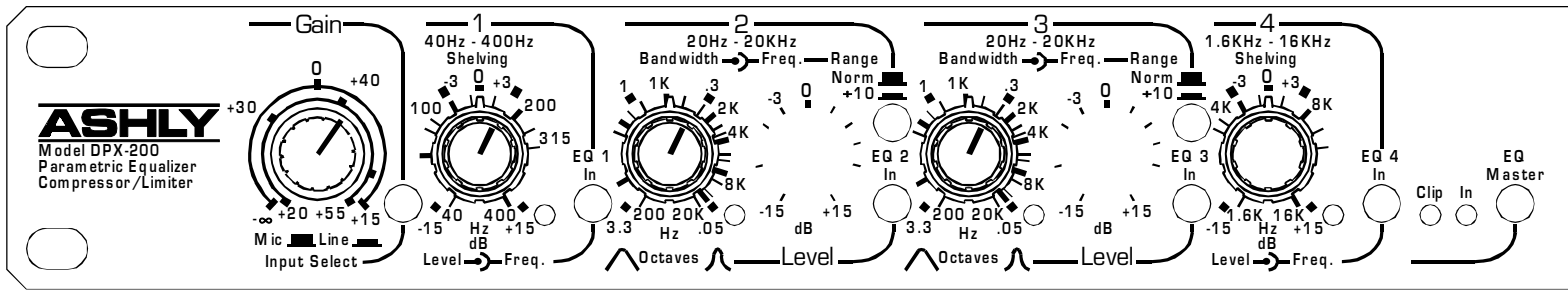

4. MECHANICAL INSTALLATION

The DPX-200 mounts in a standard 19 inch equipment rack. The mounting screw threads vary with different rack manufactures and you should refer to your rack instructions for proper hardware. An oval head or flat head screw with a plastic countersink washer is preferred to protect the finish of the DPX-200 under the screw.

This unit is housed in a rugged steel case and will tolerate moderate abuse. However, for road systems which may be dropped or otherwise subjected to extreme forces, we recommend some rear support for the chassis to prevent bending the front panel when these forces occur.

For installations where it is desirable to protect the front panel controls from tampering or accidental misadjustment, use the Ashly security cover. Installation is simple and does not require removal of the equipment from your rack. See your Ashly dealer for details.

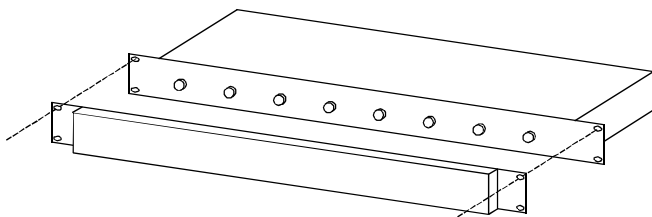

Ashly Security Cover Installation

5. PARAMETRIC EQUALIZER CONTROLS

5.1 Equalizer Input Select Switch

The DPX-200 equalizer input is selectable between line level or mic input, each with its own connector. The line level input is used for normal signal processing, while the discrete mic input provides more gain for those applications where the DPX-200 is used as a comprehensive mic preamp. Press the input select switch in for line input, and out for mic input

5.2 Gain

A single knob, dual function gain control is used for both mic and line inputs. When the mic input is selected, the gain range is from +20dB to +55dB. A -20dB pad switch on the back panel allows for nominal 0dB mic input level. When line level input is selected, the gain control range is $-\infty$ to +15dB. Unity gain for line level signal is 0.

5.3 Phantom Power

+48V phantom power is provided to the mic input XLR for use with condenser microphones. The phantom power switch is on the back panel, and a red LED near the power switch indicates that phantom power is turned on.

5.4 Shelving Filters

The nature of a shelving filter is such that the frequency response ramps up (or down) to a plateau and then levels off again, hence the term “shelf”. The DPX-200 has a low and high shelving filter for general tone control or correction. Using the outer concentric knob, the calibrated frequency tick-marks indicate the halfway point between unaffected signal and the frequency where the shelf flattens out. The inner concentric knob is the level control for that filter, and indicates the decibel level of the flat portion of the shelf relative to the unaffected signal. The frequency range on the low shelf is 40Hz-400Hz, while the hi shelf range is 1.6KHz-16KHz. Both filters have a ± 15 dB boost or cut, and can be switched in or out. A green LED turns on when the filter is engaged.

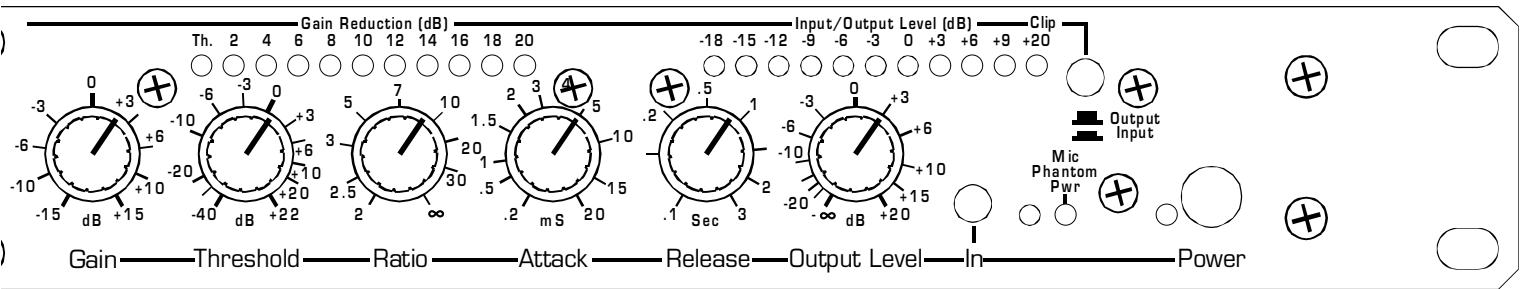

5.5 Parametric Filters

Two 20Hz-20KHz parametric filters allow custom tailoring of EQ points, most useful for feedback control, resonance compensation, or other types of frequency specific voicing. Each parametric filter consists of three main controls, frequency, bandwidth, and level. Also, an in/out switch for each filter facilitates easier setups by allowing comparisons between filtered and unfiltered signal. A green LED turns on when the filter is engaged.

Frequency: The outer concentric frequency control determines the filter's peak frequency, or the point that is boost or cut. A peak filter, as the name implies, has a symmetrical rise and fall around the center frequency, as opposed to the plateau nature of a shelving filter. For maximum frequency resolution on the parametric filter, a frequency range switch divides the calibrated frequency labels by 10, meaning that if the frequency control is set at 1K, and the range switch is then pressed in, the frequency is now 100Hz instead of 1KHz. Tick marks on the face panel are calibrated to ISO 1/3 octave center frequencies.

Bandwidth: The inner concentric bandwidth control determines how broad or narrow the peak filter coverage is, and is expressed in octaves. For general tone control, use a broader bandwidth. For notching out feedback frequencies, use a narrower bandwidth. Being able to optimize bandwidth for the job at hand is the main reason parametric equalizers are preferred for notching and feedback control.

Level: As with the shelving filters, the level control boosts or cuts the frequency by up to 15 dB at the filter peak.

5.6 EQ Clipping

The equalizer section has its own clip LED in case both the EQ and comp/limiter are wired independently. All critical signal points within the parametric EQ are monitored for signal level which exceeds +19dBu.

5.7 EQ Master Switch

The EQ master switch allows easy comparison between filtered and unfiltered signal. A green LED next to the switch turns on when the four filters are engaged. Note that the gain control is always active regardless of the setting of the EQ master switch.

6. COMPRESSOR - LIMITER CONTROLS

6.1 Gain

The Gain control is used to adjust incoming signal level to the VCA circuit. **It is always active, so switching out the limiter function has no effect on this control.** Used in conjunction with the input/output level meter display, this control is useful for setting up optimal system levels. This control should normally be left at "0" to achieve accurate threshold calibration.

6.2 Threshold

The threshold control has a range of -40dB to +22 dB, allowing applications from low level compression to high level limiting. **The threshold control determines the audio level above which gain reduction occurs.** When the threshold LED comes on, that means that gain reduction is beginning to occur, due to input signal peaks exceeding the selected threshold in dB.

6.3 Ratio

This control determines the resultant change in output level to changes in input level for all signals above threshold. **The numbers printed around the ratio control are calibrated in db and indicate the increase in input (above threshold) required to produce a 1db increase in output.** This can be expressed conveniently as a ratio. If the output remains constant no matter how high the input level, we have an infinite (∞) input/output ratio. It should be remembered that the ratio control has no effect on signals which are below threshold.

There is a common but incorrect notion that limiting always implies the use of an infinite ratio. Although there are times when an infinite ratio is desirable, there will be situations where infinite, or "hard", limiting action is neither appropriate nor necessary. In fact, it should

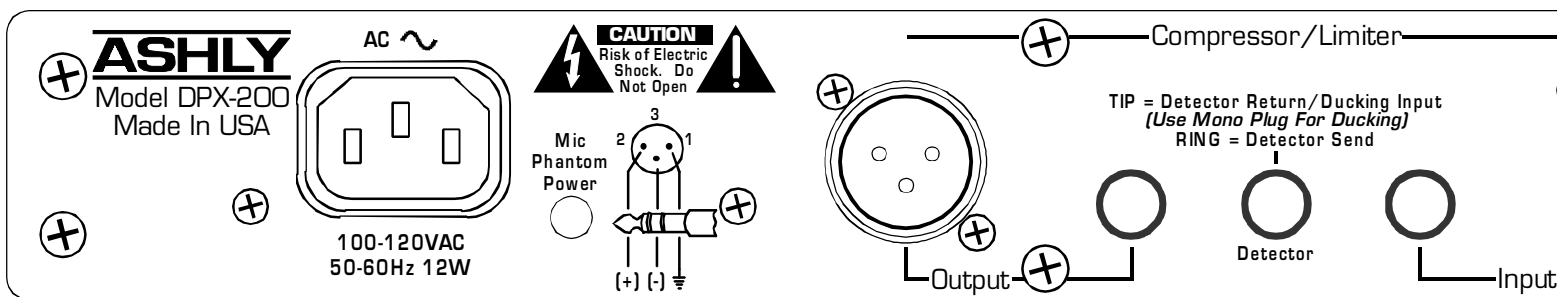

be noted that an infinite ratio setting is likely to cause noticeable side effects in the sound, and may not be usable on programs where subtle control is desired.

6.4 Attack Time

The response of the compressor/limiter to signal levels above threshold is further defined by the attack time control. **Attack time is the amount of time it takes to attenuate the output level after threshold has been reached.** For very fast transients, such as hand claps, snare drums, or other percussive sounds, a fast attack time is usually desirable so that the limiter can respond in time to control the peak level. On other types of program material, a slower attack time may be preferred. An abrupt attack may, on some material, “square off” the top of a waveform, producing a distorted sound. The DPX-200 provides continuously variable attack times from 200 microseconds to 20 milliseconds.

6.5 Release Time

Another parameter which affects compressor/limiter performance is release time, or **the time required to restore system gain to normal after the input signal has fallen below threshold level.** Again, proper release time will depend on the type of program material being processed and the way in which the limiter is being used.

When subtle limiting is desired, slow release times are often chosen to avoid condition referred to as “pumping” or “breathing”. This occurs when overall gain is modulated up and down by repeated peaks which are followed by quieter intervals. If the release time is set too fast, then the overall level will jump up and down, producing an objectionable and unsettling effect. Note that, in some cases, an individual track or channel which seems to be pumping may sound acceptable when heard in context of a complete mix.

*A unique feature of all Ashly compressor/limiters is the incorporation of a **double release-time constant.*** When a conventional compressor/limiter is adjusted for slow release times, transients such as mic “pops” may cause a severe reduction in gain followed by a slow fade-up, making the action of the limiter very obvious. With

the double time constant, release from gain reduction after a brief transient is always fast, with a slower release after a sustained overdrive.

6.6 Output Level

Output level control is provided to fully cut or restore up to 18 dB of system gain. For unity gain, set the control to 0. NOTE: When the compressor/limiter is switched out, the output control still functions.

6.7 In/Out Switch

This switch enables you to quickly hear the compressor/limiter in or out of the audio chain. When the switch is in the out position, all limiting and compression controls and functions are bypassed, with the exception of the gain and output controls, which continue to function as straightforward level controls.

6.8 Threshold/Gain Reduction Display

As soon as the threshold level is reached, the yellow LED illuminates. Depending on how far the input level rises above threshold, successive red LED’s will illuminate, indicating gain reduction. **Gain reduction can best be described as the difference between input level and the resulting change to output level.** For signals below threshold, there will of course be no gain reduction, that is, a 10dB increase in input will yield a 10dB increase in output. For signals above threshold however, output level will increase only to the extent that the ratio control allows. With a high ratio, say 20 or so, it will take 20dB of increased input level to increase output level by 1dB. With a gentler ratio of 3:1, input signals above threshold will be “gain-reduced” at the output by 1/3. In other words, with threshold set at 0dB, a signal peak at +12 dBV that is 3:1 compressed (ratio at 3) will produce only +4 dB (12÷3) at the output, and 8 dB of gain reduction has occurred (12 dBV input minus 4 dBV output=8 dB reduction.)

6.9 Input/Output Meter Select

While the gain reduction display accurately represents the action of the limiter, comparing input to output levels in real time is somewhat more intuitive, and is made simple using the input/output meter select switch.

INPUTS are Active Balanced.
 OUTPUTS May Be Wired
 Balanced Or Unbalanced.

JoB4010064(E)M-DJC\JoB4EB9(aEB)65Dt0

The input meter takes its signal just after the gain control, and will indicate input signal level regardless of output levels or limiter settings. The output meter display takes its signal from the actual output of the unit, so every control that affects the output will also have an effect on output meters. Used in conjunction with the gain reduction meters, input/output meters prove to be an extremely useful diagnostic tool when working with system dynamics and level control.

7. CONNECTIONS AND CABLES

7.1 Balanced and Unbalanced Audio Connections

Balanced signal connections are preferred in pro audio applications because of their improved immunity to induced hum and noise. A properly shielded and wired balanced input stage on any audio product will reject most unwanted noise (RFI, EMI) picked up by the cable, as well as minimize ground loop problems. Therefore it is always advantageous to use balanced connections when running signal more than ten or fifteen feet, although particularly noisy environments may require that even short patch cables be balanced.

Unbalanced connections are used mostly for short distance, high level signals (0dBu nominal). Most external EMI noise pick-up will be masked under the noise floor of the signal, assuming there is little or no gain following the unbalanced signal. If a gain stage does follow a signal, or if externally sourced noise persists, use balanced connectors.

7.2 Inputs and Outputs

The DPX-200 uses two different audio connector types. 1/4" TRS (tip-ring-sleeve) phone jacks, and three pin XLR connectors will allow interfacing to most professional audio products. Ashly TRS balanced connections use the tip as (+) and the ring as (-) signal, with sleeve used for ground. Ashly XLR connectors use pin 2 (+) and pin 3 (-) with pin 1

ground. Inputs are 20KΩ active balanced using precision 1% metal film resistors, outputs are 200Ω "pseudo-balanced", which means they have balanced impedance with a single-ended signal source, and can be wired balanced or unbalanced. When possible, we recommend balanced connections between all components in your system.

If inputs are used unbalanced, the signal should be on the (+) connection and the (-) connection *must* be tied to ground, or signal loss will result. While a mono phone plug used as an unbalanced connection will automatically ground the (-) ring of the jack, XLR's will not automatically do this, so attention must be given to proper wiring.

7.3 Chain Switch

The chain switch on the back panel allows the output of the parametric equalizer to be fed directly to the input of the compressor/limiter, with no external cable required. When the chain switch is in, the input connectors to the compressor/limiter are removed from the circuit, while the equalizer outputs remain functional.

7.4 Compressor/Limiter Detector Loop - Ducking

The DPX-200 compressor/limiter has a TRS Insert DETECTOR PATCH point which can be used as a "ducking" input, or in conjunction with an equalizer to produce frequency-sensitive limiting. Various uses of the detector patch are discussed under TYPICAL APPLICATIONS.

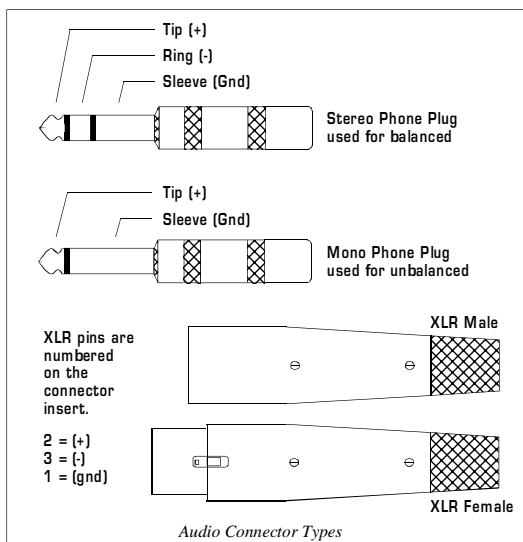

8. TYPICAL APPLICATIONS

By itself, a parametric equalizer is useful for general tone control, feedback control, room resonance correction, individual microphone voicing, and many other applications. The compressor/limiter provides many solutions where dynamic signal level processing is required. The combination of a parametric EQ and a compressor/limiter allows for additional applications, such as a full range speaker processor, 70 volt distributed system processor, mixing console channel insert, and frequency sensitive limiting, just to name a few. In most cases, the DPX-200 should be the last device before the power amp or crossover, or right before a recording device or transmitter.

8.1 Parametric Equalizer Applications

General Tone Control

Like a graphic EQ, the parametric equalizer is a very useful device for general tone shaping because the filter's center frequency, bandwidth and level are all continuously variable. To use the power of the equalizer effectively, you need to translate your idea of the tone you want to produce into a range of numerical frequencies. This is simple after a little practice. Here are a few references which are useful for starting points:

- Very low bass (the "wind" in a kick drum, almost felt as much as heard -40Hz-80Hz.
- The low register of a male voice - 200Hz
- The low register of a female voice - 350Hz
- Lower midrange ("warmth" frequencies) - 400Hz-1KHz
- Upper midrange ("harshness", snare drum "bite", "hot" sound) -2.5KHz-4KHz.
- Sibilance ("sss" sounds, cymbal "sizzle") - 8KHz-15KHz.

Try using these starting points as a guide when you want more or less of these types of sounds. Adjust by ear from there. It is always a good idea to remember that a little equalization usually works out much better than a lot, and that there are many audio problems which cannot be solved with equalization alone.

Feedback Control

The parametric equalizer is a powerful tool when applied to eliminating feedback problems. On a traditional graphic equalizer, the fixed filter center frequen-

cies are insufficient when the frequency of feedback occurs between two slide faders, or is extremely narrow. The continuously variable center frequency and bandwidth of a parametric equalizer allows very sharp notching of feedback frequencies.

The following procedure outlines how to use a parametric equalizer to suppress feedback frequencies:

1. Start with all the EQ switches out except the master EQ switch in and the gain at 0.
2. With the entire PA hooked up and turned on, slowly increase the sound level at the mixer until feedback is heard, then lower the level by about 3 dB so that feedback does not continue.
3. Start with one of the two parametric filters by setting the level at 0, bandwidth set fairly sharp (about .3 oct.), and adjust the frequency control to where you estimate the predominate feedback frequency to occur.
4. Push in the filter's EQ switch and increase its level control by about +6 dB. Now "sweep" the frequency around where you have estimated the feedback frequency until feedback occurs. Once you have induced the feedback by boosting its frequency, quickly turn down the filter's level control to about -6 dB to suppress or "notch out" the feedback frequency.
5. Again slowly increase the master level at the mixer until feedback is heard. If a new feedback frequency is heard, then repeat step 3 with the other parametric filter to find and suppress the new frequency. If the original feedback frequency is still heard, then adjust the first filter's level even lower. The bandwidth control may be adjusted full clockwise to produce a very sharp notch so that a severe feedback frequency can be attenuated by as much as 15 dB without degrading the frequency response with noticeable notches. *Note: Very sharp bandwidth lowers the maximum equalizer input level because of the high filter gain necessary to obtain such a narrow bandwidth. Only use bandwidth control full CW (.05 Octave) in severe cases.*

Console Channel Equalization

Many mixing consoles provide only simple equalization for individual channels. If your console has channel inserts, you can patch your parametric equalizer into

a channel that's being used for something important and use it to tailor the sound of this channel exactly the way you want.

Large Room Equalization

Large rooms tend to suffer from multiple reflections with long time delays, long reverberation times, and "ring-modes", all of which lead to reduced intelligibility and a generally "muddy" sound. As sound travels long distances through the air, high frequencies are attenuated more than low frequencies. In general, large rooms benefit from some low frequency roll-off, high frequency boost, and attenuation of ring mode frequencies.

8.2 Compressor - Limiter Applications

As the functional name implies, a compressor/limiter can be divided into two basic categories, limiting and compressing. When used as a protective device to prevent audio levels from overloading systems such as tape recorders, power amplifiers, speakers, or transmitters, it is generally referred to as a limiter.

It may also be used to create special effects and unusual sounds for recording and musical performance by deliberately reducing the dynamic range of a signal, creating a much louder or fuller sounding signal without increasing the loudness peaks, in which case it is referred to as a compressor.

The Limiter As A Protective Device

The DPX-200 compressor/limiter section provides fast and accurate gain control for the prevention of sound system overload due to unexpected transients. Sound system distortion is usually the result of amplifiers running out of power, in which case nice round waveforms turn into harsh sounding squared-off waveforms. Looking at it from the perspective of the speaker diaphragm, this means that, whereas in normal operation the diaphragm is required to accelerate, slow down, smoothly change direction, and accelerate again, distorted operation requires an instant acceleration, instant stop, a change of direction, and instant acceleration again.

Since speaker diaphragms are subject to the laws of physics, they won't take this kind of punishment for long. The diaphragm may shatter, or its voice coil may overheat. In addition to the damage caused by sustained overload, the speaker may also be damaged by occasional, one-shot high level overload, for example, the sound of a microphone falling face-first onto a hardwood floor. Even if this type of transient doesn't destroy a speaker outright, it may damage the speaker surround in such a way as to cause mechanical abrasion and future failure.

Alternatives For Sound Installations

To install a compressor/limiter in a sound system using a passive crossover, insert it between your mixing console output and the power amplifier input. For systems using electronic crossovers, there are two ways to use a compressor/limiter. It may be inserted between the mixer output and the crossover input, in which case it will act on the entire audio frequency spectrum. Alternately, if the limiter is inserted between an output of the electric crossover and the input of a power amp, it will only affect a specific band of frequencies.

Recording

The Ashly limiter can be used to prevent tape saturation in analog recording. Also, with modern trends toward inexpensive digital recording, it remains necessary to protect against input overload. With digital recording, the information stored on tape, hard disk, optical disk, etc., is either a 1 or 0, so actual signal level on the tape is not the concern it is with analog recordings, in fact it is not even a user controllable parameter. What is of concern however, is the signal level applied to the A-D (analog to digital) converters. If clipping occurs at the converter input stage, the resulting distortion is most unpleasant, and will be recorded digitally as if they were part of the original audio signal, forever mixed with the audio. To prevent converter distortion while preserving the extended dynamic range of digital recording, look up the max input level of your recorder/converter and set up the limiter as follows:

1. Set Gain to 0.
2. Set Threshold to 2-3 dB below max converter input.
3. Set Ratio to 10.
4. Set Attack to 2 mS.
5. Set Release to .2 Sec.
6. Set Output level to 0.

If you are exceeding threshold frequently, your input signal is probably too high and should be turned down. Of course, every situation is different, so experimentation before final recording is always a good idea, but this is a good starting point.

To obtain a gentler limiting action at the expense of some dynamic range, decrease the threshold to -15 and the ratio to 3-5. This is also a good starting point for analog recording.

Broadcasting



Compression has long been used as a tool to make an audio signal appear louder. A good example is in broadcasting, where competing stations with identical transmitters and power attempt to sound louder than each other. Since they are all restricted with respect to maximum audio level (modulation), their best tactic is to squeeze the dynamic range of their programs to just a few dB. The audio output level of the station virtually never changes, and the listener perceives this continuous high-level sound as being louder than the same material in an uncompressed form. Although both compressed and uncompressed programs reach the same peak levels, the compressed signal stays near peak level more of the time, and thus sounds louder. This technique makes the broadcast more intelligible over ambient noise, and increases the geographical area over which the broadcast is audible to the listener. Additionally, this compression technique is extremely useful for FM and infrared transmission systems for the hearing impaired.

8.3 Special Effects

Compression For Feedback Control

A common ritual in sound system set-up is equalizing the room to remove feedback. This is generally accomplished by turning up system gain to purposely induce feedback, searching for the center frequency of the feedback, and then equalizing at that frequency to remove the feedback. Once this frequency has been cut, system gain is again increased to induce another feedback point, and the whole procedure is repeated until the engineer is satisfied that the significant problem frequencies have been corrected. The major problem with this approach is that the feedback can easily get out control, and the engineer ends up dashing back and forth between the mixer volume controls and the equalizer controls, while everyone in the room plugs their ears and prays it will end soon. The Ashly DPX-200 can turn this procedure into a fast, painless job, eliminating loud feedback levels and the possibility of speaker or ear damage.

Procedure:

1. Set up the DPX-200 limiter controls as follows:
 - a. Output level control to -20dB.
 - b. Input Gain control to 0dB.
 - c. Threshold control to -30dB.
 - d. Ratio control to infinity (∞)
 - e. Attack time to 5mS.
 - f. Release time to 1 Sec.
 - g. Limit switch IN

2. Using a 1/3 octave (31 band) or parametric equalizer, set the EQ controls to a flat setting, and if the equalizer has an overall volume control, boost it by 10 to 15 dB.

3. Open up several microphone input channels to a normal operating level, with typical EQ settings, and turn the console master fader up to a louder than normal setting. At this point, the system should be well into feedback, but the room volume will be constant due to the action of the limiter. You can listen to the feedback at any level you like by simply varying the limiter output level control, although below a certain monitoring level, the feedback will stop.

4. Try to determine the feedback frequency, and then equalize it by adjusting the center frequency, bandwidth, and boost/cut controls of your parametric equalizer. (Note: a graphic equalizer can also be used, although with less accuracy.) After eliminating the problem frequency, try to further define it by sharpening up the bandwidth, reattacking the frequency control, and making the cut shallower, if possible.

5. As soon as the first feedback frequency has been removed, the compressor/limiter will automatically bring up system gain until another feedback point is induced. Repeat the equalization procedure until it becomes impossible to distinguish individual, predominant feedback frequencies.

6. Write down EQ marks for safekeeping if necessary, and return all mixer, EQ master gain, and compressor/limiter gain controls to normal operational settings.

Altering the Texture of Musical Instruments

It would be impossible to mention here all the ways that compression is used to create new sounds with familiar instruments. Some typical uses are:

1. Creating a "fatter" kick drum or snare sound.
2. "Thickening" acoustic guitars.
3. Adding punch and sustain to electric bass or guitar.

In general, use a gentle compression ratio, say 4:1, with a 10 mS attack time, 0.1 Sec. release time, and a low enough threshold to cause 6 to 10dB of Gain Reduction. Try using this effect to help bring out a lead vocal or instrumental solo in a cluttered mix. The compressor is also a great corrective tool when working with

singers whose own dynamic control is less than perfect. A little compression helps to keep their quieter lines from becoming buried in the mix. Experimentation is highly recommended.

Voice-Over Compression (“Ducking”)

The compressor/limiter can be used to automatically reduce music to a background level when an announcer is speaking. In this scheme, only the music signal is actually gain-reduced by the limiter. However, the detector is connected to respond to an announcer’s voice instead of the music’s peaks. Voice-Over compression assumes you are already using some sort of mixer to combine the music and mic signals. Use the direct out (send) of the mic channel to feed the detector input on the DPX-200. Note: Be sure to use a mono plug for the detector input. Then use the Threshold and Ratio controls to determine when and by how much the announcer’s voice affects the music level.

De-Essing

A special type of saturation problem often encountered in recording is the sibilant (Ssss) sound of the human voice. High frequency, sibilant sounds can reach very high energy levels, so that a voice that is otherwise undistorted breaks up on the esses, producing a raspy, undesirable sound. With analog recording to magnetic tape, high frequencies tend to saturate the tape sooner, and combined with the internal high frequency boost (record pre-emphasis) on standard tape decks, the need to control sibilants becomes apparent.

The solution is frequency-dependent limiting, which is easily accomplished with the DPX-200. By inserting an equalizer into the Detector Patch point and boosting the equalizer at high frequencies in the vicinity of the sibilant, the limiter’s detector circuit becomes more sensitive to this particular range of frequencies, and so will limit the bothersome sibilants more than other frequencies.

Realize that this technique is very different from simple equalization. Equalizing a sibilant vocal by cutting high frequencies would result in a loss of important high frequency information at all times, whereas de-essing has no effect whatsoever on the signal except at the instant of the sibilant. At that moment, the Ashly limiter will reduce overall gain. Frequency response is unaffected, and the sibilant is controlled.

9. DESIGN THEORY

Parametric Equalizers

The heart of Ashly parametric equalizers is a unique bandpass filter circuit. Basically a “state-variable” type, this filter is trimmed and optimized to provide excellent transient response and a wide range of frequency and bandwidth adjustment. Each filter can be tuned over a 100:1 frequency range (about 6.6 octaves) and a 70:1 bandwidth range with no more than a 2 dB amplitude error at center frequency. At its sharpest setting, the filter has a “Q” of about 35 and generates a response curve with 3 dB points only 1/20 octave apart, making feedback control possible with no audible side effects. Each filter is placed in the feedback loop of a summing amplifier to produce the desired frequency response. Since a separate summing amplifier is used for each band, no interaction between bands occurs.

Compressor/Limiters: The Need For Gain Control

The human ear excels in its ability to detect an extremely wide range of loudness levels, from the quietest whisper to roar of a jumbo jet. When we attempt to reproduce this dynamic range, by means of amplifiers, tape recorders, CD players, or radio transmitters, we run into one of the fundamental limitations of these electronic media: limited dynamic range. Amplifier dynamic range is quite good, and is adequate for most musical program material. However, some types of audio equipment, such as cassette tape recorders, have a very narrow useful dynamic range.

What is it that compromises the dynamic range of this equipment? The useful operating region of a piece of audio equipment is squeezed in between noise and distortion. As program level decreases, it approaches what is known as the “noise floor”, and if the volume of the program material goes lower still, it is engulfed by the noise. The noise floor, or minimum constant noise level, will consist of hiss, hum, transistor noise, tape hiss, buzz and whatever noises are inherent in the medium. When the program level is considerably higher than the noise floor, our hearing masks the noise, and it is not a problem. However, when listening to very quiet sections of a program for example, a pause between movements of a string quartet the noise can become very bothersome.

At the other end of the loudness spectrum, the limitation on dynamic range is usually distortion, either in the form of amplifier overload, tape saturation, or A to D clipping. In most transistorized equipment, the transition from clean, undistorted operation to severe distortion is very abrupt. Therefore, it is common practice to operate a piece of equipment at a level that is somewhat below the distortion point, leaving a margin of safety for

unexpected, transient volume peaks in the music. This safety margin is known as headroom, and may range from 10 to 25 dB. Lowering our standard operating level to leave ourselves some headroom helps prevent distortion, but at the same time it moves our average program level closer to the noise floor, thereby compromising signal-to-noise performance. It becomes apparent that to get most out of an audio system, you have to keep your standard operating level as high as possible without risking distortion.

Gain Riding

One solution to the noise vs. distortion trade-off is to keep your hand on the level control and manually adjust gain to suit the program. Indeed, there are times when this approach is entirely satisfactory. However, in most types of music there are instantaneous, short duration volume peaks, or transients, which would be difficult to anticipate and impossible to respond to with manual gain riding, you simply could not bring the level down fast enough. In many situations, this can present real problems. For example, in recording, an extra burst of enthusiasm from a lead singer might overload the capabilities of your recording tape, causing ragged distortion and necessitating another take. In sound reinforcement, a sudden burst of energy through the system can blow fuses or even damage loudspeakers.

In addition to the problem of response time with manual gain riding, it also requires your constant attention, which takes you away from more important jobs. The need for a fast-acting, reliable, automatic gain control is answered by limiters and compressors.

What Compressors and Limiters Do

Limiting

In any musical program are constant changes in loudness. It is the job of a limiter to detect when the volume has exceeded a predetermined maximum safe level, and to then turn down the volume. When the incoming signal returns to its original level, the limiter should respond by restoring the gain to normal. Thus, when the level is within a specified "safe" range, the limiter has no effect. When an occasional peak occurs, the limiter responds. This situation is completely analogous to manual gain riding, except that it occurs faster and more consistently.

Compression

A very significant difference in dynamic range is achieved simply by changing the relationship between nominal signal level and threshold, as a result of either increasing the GAIN and/or decreasing the THRESHOLD control. The most interesting effect to be noted, however, is seen by comparing the original input signal with the output signal.

The quietest portions of the original signal will be effectively increased in volume while the loudest portions of the original signal will be decreased. In effect, both ends of the dynamic spectrum will be pushed toward the "middle". This is quite different from simple limiting, where only loud peaks are subjected to gain reduction. More than anything else, it is this double-ended effect which distinguishes compression from limiting. Compression is further differentiated from limiting by careful selection of attack and release times. When limiting is employed to protect an audio system against transient volume peaks and possible overload, attack time is usually set as fast as possible, consistent with distortion-free performance. Release time would also be relatively short, so that the output signal would be restored to normal as quickly as possible after the transient.

Compression is frequently used to keep overall signal level within a specific dynamic range, and for this application, slower attack and release times are usually chosen. This approach is analogous to our manual gain riding example, where our operator is fading the music up and down to keep it fairly constant, but is doing it slowly enough so that the listener is unaware that the gain is being altered.

Voltage Controlled Amplifiers

Early VCA's were based on vacuum tubes with a "remote cutoff" characteristic. The tube would simply change its gain in response to a changing bias voltage. Tubes developed for this purpose did an excellent job, in fact they could exceed the noise and distortion performance of today's best solid state VCA's. Unfortunately, they also had some serious disadvantages peculiar to tubes - change of gain and matching as aging took place, heat, microphonics, high cost, and the need for both high-voltage and filament power supplies.

Over the years the need for good, low-cost, solid state VCA brought about many innovative approaches. A good example is the electro-optical attenuator where a photocell is used as one leg of a potentiometer. Since the photocell behaves as a true resistor, distortion and noise are very low. Unfortunately, the response time of photocells is slow and unpredictable so their use in a fast peak-limiter is really not feasible. Also, the matching between units is very poor so that stereo tracking is not possible without tedious hand-matching of photocells.

Another approach uses a field-effect transistor (FET) as a variable resistor. Here, at least, the response time is fast (in the nanosecond range), but matching between units is still poor, requiring hand matching for stereo. An additional problem is that a

FET will only act as a pure resistor with very small signals applied so it is necessary to attenuate an input signal before the gain control FET and then amplify it again. Of course this results in less than ideal noise performance and imposes a frustrating trade-off: less noise = more distortion.

A number of VCA's based on the exponential voltage-current characteristic of a bipolar junction transistor have been used. One of the most common is called a "transconductance amplifier". Using the inherent matching obtained by integrated circuit technology, these devices have very predictable control characteristics. Tracking within 1dB over a 40dB range is common. Not only do the control characteristics match well from unit to unit, but they can easily be made exponential (logarithmic) so that even increments of control voltage produce even increments of gain change in decibels. The response time is also very fast.

The problem with simple transconductance amplifiers is that, like FET VCA's, they can handle only very small signals so the noise performance is poor. A number of linearizing circuits have been devised to minimize this problem, but even the best transconductance amplifiers have an equivalent input noise of about -80dBv, which compares poorly to straight linear amplifiers.

The best analog compromise to date is the "class AB current ratio multiplier." Early implementation of this circuit used two matched pairs of transistors, one pair of NPN's and one pair of PNP's. The problem here is that excellent matched integrated NPN pairs were available, but integrated PNP's were not. The PNP's had to be hand-tested and matched. Careful trimming was necessary for low distortion and even minor temperature changes made re-trimming necessary because of differing characteristics between the two types.

The Ashly VCA

The Ashly VCA is an integrated current ratio multiplier circuit. It has low noise (-90dBv), low distortion (.05%), excellent response time and tracking and does not suffer from thermal drift. The noise and distortion are at state-of-the-art levels and the circuit is consistent in mass production with minimal trimming and no hand-selection of transistors.

Detectors

It would seem that, of the two components in a compressor/limiter, the VCA is the more critical since the audio passes through it and the detector only provides it with a control voltage. Experience showed us that both are crucial to the overall sound and that, if anything, the detector's performance is the harder to judge by conven-

tional measuring techniques. While the VCA is doing its job if it has low noise and distortion, the detector must constantly adjust the gain of the audio path in a manner which keeps the level under control while sounding acceptable to the listener. This constantly changing gain is a dynamic action, while conventional audio measurements like noise and distortion checks are Static (at a constant level). We became painfully aware of this problem with some of our earlier limiter prototypes which measured fine and sounded terrible. This led us to use a purely subjective approach in the design of the detector - we did a lot of listening to determine what sounded good and what didn't.

Two important features emerged from this research:

1. We designed the detector to let the attack and release times speed up as more and more limiting occurs. The compression ratio also increases. This lets us maintain peaks fairly close to a constant ceiling level, but allows the illusion of increasing loudness as input level increases, thereby preventing complete loss of dynamics when limiting.

2. We incorporate a double release time constant. When release time was set slow with a single time constant, transients such as mic "pops" caused a quick reduction in gain and a slow fade-up, making the action of the limiter very obvious. With the double time constant, release from gain reduction after a brief transient is always fast, with a slower release after a sustained overdrive.

When choosing a compressor/limiter, you can see that it is very important to listen to it in your particular application and see that it sounds the way you want. There are lots of these devices with seemingly excellent specs which sound very different with real program material applied to them.

Peak Or RMS

There are several ways of looking at a signal to determine its level. A peak detector looks at the maximum voltage a signal reaches regardless of its waveform, while an RMS (root mean square) detector looks at the energy in a signal regardless of the short term voltage levels. This makes a peak detector the correct choice for preventing clipping, overmodulation, or tape saturation, while an RMS detector can be used to restrict material to a given loudness. When an RMS limiter is used to prevent clipping, the result is unpredictable. For instance, a flute and a snare drum which are limited to the same RMS level might have peak levels as much as 30dB apart! Use peak limiters to prevent clipping.

10. BLOCK DIAGRAM

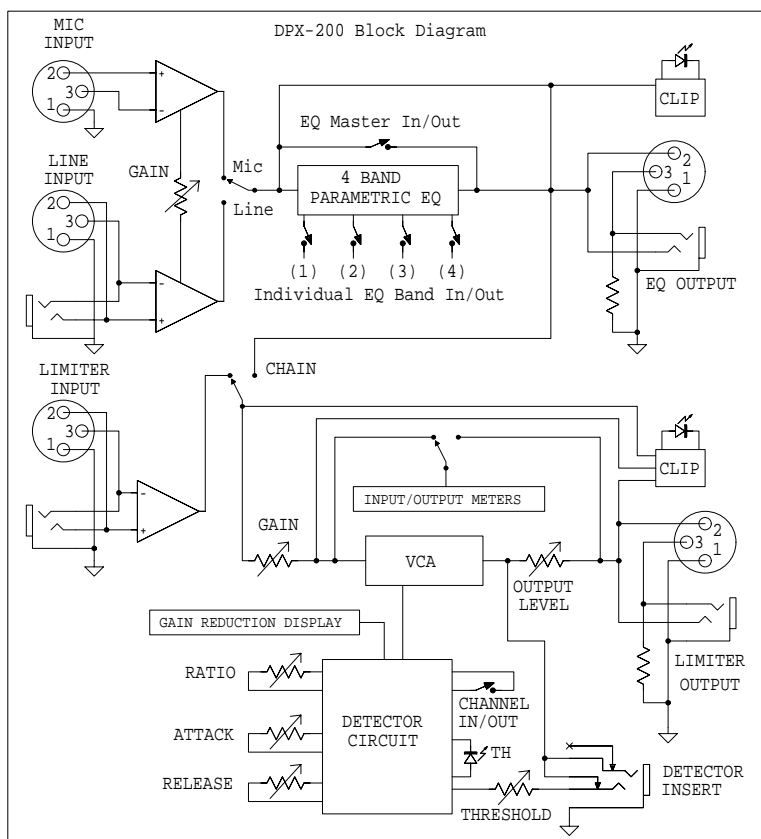

11. Equalizer Troubleshooting Tips

No Audio Output

- Check AC power - is the pilot light on?
- Check in/out connections - are they reversed?
- Are you sure you have an input signal?
- Is the correct input selected?
- Is the gain control turned all the way off?

EQ Controls Do Nothing

- Is the individual filter or master EQ switch in?
- Is the bandwidth set too narrow to be heard?
- The lowest and highest frequency filters may be beyond the range of the program material or speakers and may produce little or no audible effect.

Peak Light Flashes or Stays On All the Time

If the peak light flashes, the signal level to the equalizer is too high, or a particular filter is boosted too much. Turn down the gain or switch the EQ filters. If it is on all the time, disconnect the input and output cables. If it is still on, the unit must be returned for service.

Distorted Sound

This will only be caused by too much signal which will show on the Clip LED. If the LED is not flashing, there is an overload within another product in the signal path. Adjust the relative gain of each component in your chain to keep everything at a comfortable level.

Excessive Hum or Noise

Hum will usually be caused by a ground loop between components. Try using the suggested balanced input and output hook-ups if the other pieces of equipment used in conjunction with your equalizer have balanced inputs and outputs.

Noise (excessive hiss) can be caused by insufficient drive signal. Make sure you are sending a nominal 0 dBu line level signal to the equalizer. Most noise problems occur because gain is applied to audio signals too late in the chain. For best performance, apply gain to individual source signals as early as possible, like at the mixer input preamp section. As gain increases, it also boosts the noise content of that signal. Any cumulative noise built up in a mixed signal will only be increased by using an equalizer as a gain device, so make every attempt to operate the equalizer with as little gain as possible.

Note: Unshielded cables, improperly wired connectors, and cables with broken strands of wire are very common problems. Use quality cables with quality, correctly wired connectors.

11.1 Compressor/Limiter Troubleshooting Tips

No Output

Check AC power. Is the power switch on? Check input and output connections - are they reversed? Are you sure you have an input signal?

Controls Have No Effect

Is the limiter in/out switch in? Perhaps the ratio control is set too low to produce an audible effect or the input level is below threshold. Is the threshold LED lighting up? If not, lower the threshold setting or increase the gain. Do not expect to hear any effect when the input level is below threshold, since the unit is simply a linear amplifier at those levels.

When Using Heavy Compression, Background Noise Is Noticeable During Quiet Sections Of The Program

As defined in the section on compression, quiet program material is effectively made louder while loud peaks are made quieter. When the program source is thus raised in volume, its noise floor is also raised in volume by a proportionate amount. This is not a defect in the compressor/limiter, but an unavoidable side effect of the gain altering process. If the noise becomes a problem, the solutions are to either decrease noise at the program source, or use less compression.

Excessive Hum Or Noise

Hum is often caused by a “ground loop” between components. Try using the suggested balanced input and output hookups if the other pieces of equipment used in conjunction with the DPX-200 have balanced inputs and outputs. Noise can also be caused by insufficient drive levels. Make sure you are sending a nominal 0 dBV line level signal to the unit.

12. WARRANTY INFORMATION

Thank you for your expression of confidence in Ashly products. The unit you have just purchased is protected by a five-year warranty. To establish the warranty, be sure to fill out and mail the warranty card attached to your product. Fill out the information below for your records.

Model Number _____ *Serial Number* _____
Dealer _____ *Date of Purchase* _____

13. SPECIFICATIONS - Parametric EQ:

<p><i>Input Connection, Line in</i> ... 1/4" Phone Jack, XLR 20KΩ Active Balanced 10KΩ Unbalanced</p> <p><i>Gain, Line input</i> -∞ to +15dB</p> <p><i>Input Connection, Mic in</i> Low Z Balanced XLR</p> <p><i>Mic Input Pad Attenuator</i> ... 0dB out / -20dB In</p> <p><i>Gain, Mic input</i> +20dB to +55dB</p> <p><i>Shelving Filter Frequency Range (midpoint of slope)</i></p> <p><i>Low</i> 40Hz-400Hz</p> <p><i>High</i> 1.6KHz-16KHz</p> <p><i>Shelving Filter Amplitude</i> ... ±15dB</p> <p><i>Peak Filter Freq. Range</i> 20Hz-20KHz</p> <p><i>Peak Filter Bandwidth</i> 3 1/3 to 1/20 Octave</p> <p><i>Peak Filter Amplitude</i> ±15dB</p> <p><i>Max. Level - All Filters In,</i> <i>All Level Controls at Unity</i> .. +23dBu</p> <p><i>Max Level - One Peak Filter at Max Boost</i> <i>"Q" 0.3 octave or greater</i> ... +7dBu</p>	<p><i>Output Connections</i> 1/4" Phone Jack, XLR 200Ω Pseudo-Balanced* 100Ω Unbalanced</p> <p><i>Max Output Level</i> +23dBu</p> <p><i>Frequency Response</i> ±.2dB 20Hz-20kHz</p> <p><i>THD (20Hz-20KHz)</i> <.03% @+4dBu</p> <p><i>Output Noise</i> 20Hz-20KHz unweighted All controls at unity gain</p> <p><i>EQ Out</i> <-109dBu</p> <p><i>EQ Peak Filters In</i> <-93dBu</p> <p><i>EQ Peak and Shelving</i> Filters In <-90dBu</p> <p>(0dBu = 0.775 volts rms, balanced input)</p> <p><i>*Pseudo-balanced output is single ended signal with balanced impedance.</i></p>
---------------------------------------------------------------------------------------------------------------------------------------------------------------------------------------------------------------------------------------------------------------------------------------------------------------------------------------------------------------------------------------------------------------------------------------------------------------------------------------------------------------------------------------------------------------------------------------------------------------------------------------------------------------------------------------------------------------------------------------------------------------------------------------------------------------------------------------------------------------------------------------------------------------------------------------------------------	-----------------------------------------------------------------------------------------------------------------------------------------------------------------------------------------------------------------------------------------------------------------------------------------------------------------------------------------------------------------------------------------------------------------------------------------------------------------------------------------------------------------------------------------------------------------------------------------------------------------------------------------------------------------------------------------------------------------------------------------------

SPECIFICATIONS (continued): Compressor/Limiter

Gain:	±15dB	Frequency Response:	±0.2dB 20Hz-20KHz
Ratio:	2:1 → ∞	Distortion:	<.01% THD, 0dBu, 1KHz
Attack Time:	200µS-20mS		<0.15% THD, +15dBu,
Release Time:	100mS-3Sec		20Hz-20KHz
Output:	-∞ to +18dB	Output Hum and Noise: ...	<-95dBu
Maximum Input Level:	+23dBu	DPX-100 Power Requirements:	
Maximum Output Level: ..	+23dBu		93VAC-120VAC, 50-60Hz, 10W
Input Impedance:	20KΩ balanced	Size and Shipping Weight:	
Output Impedance:	200Ω Pseudo-Balanced		19"L x 1.75"H x 6"D (8 lbs.)

14. DIMENSIONS

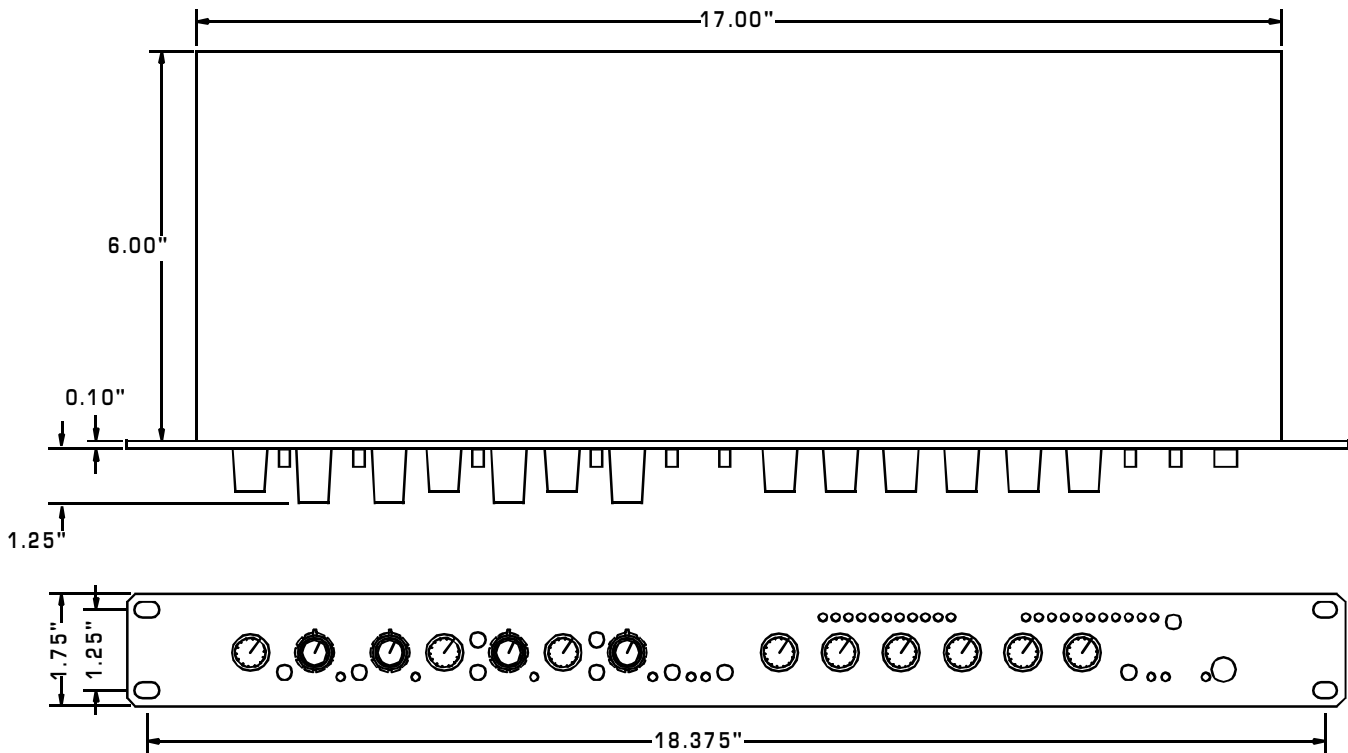

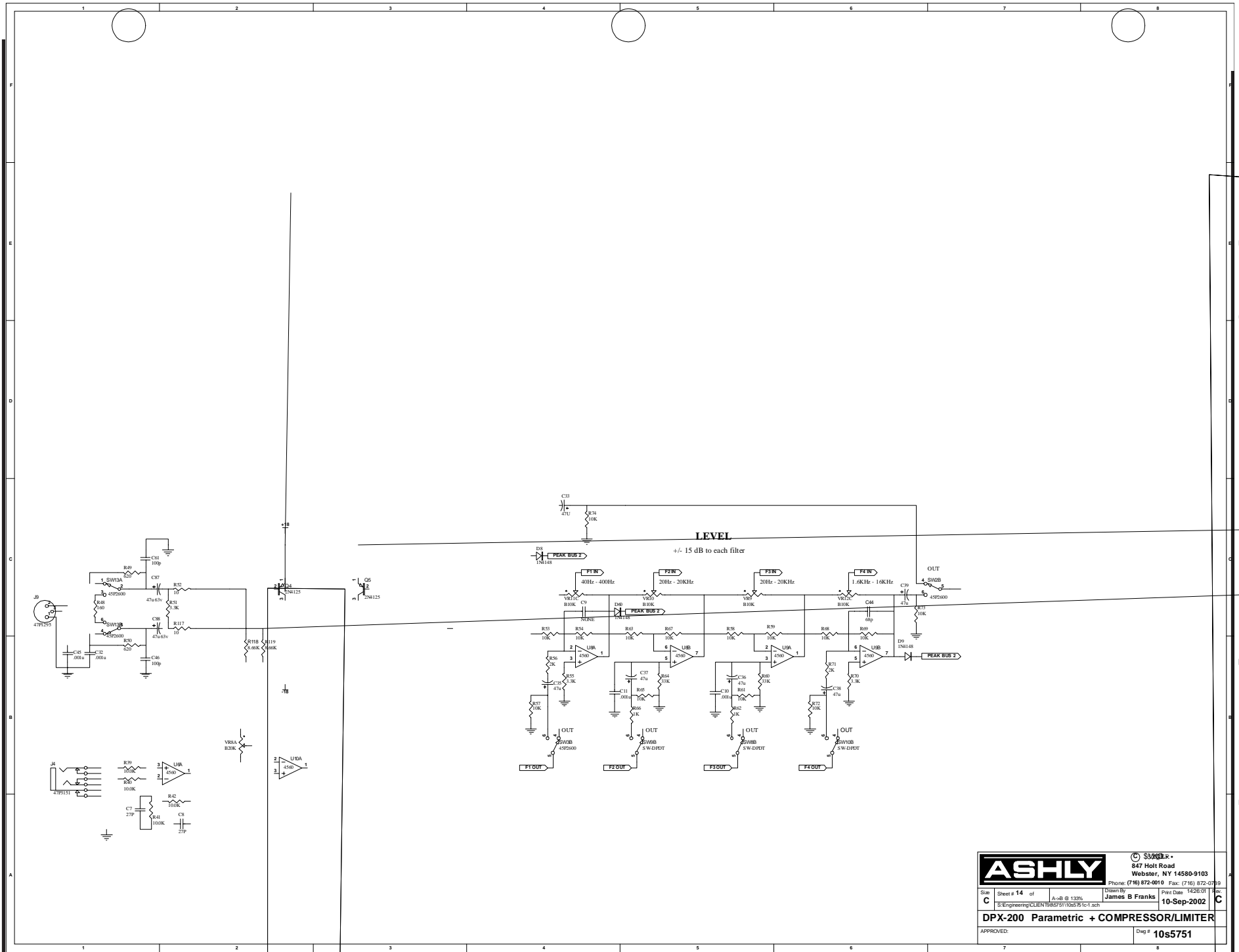

		S.M.K.L.R. 847 Holt Road Webster, NY 14580-9103 Phone: (716) 872-0010 Fax: (716) 872-0789	
		Sheet # 14 of C S:\Engineering\CUEN\890751\025\5.tcr1.sch	Drawn by James B Franks
DPX-200 Parametric + COMPRESSOR/LIMITER			
APPROVED:			Dwg # 10s5751

15. SCHEMATICS

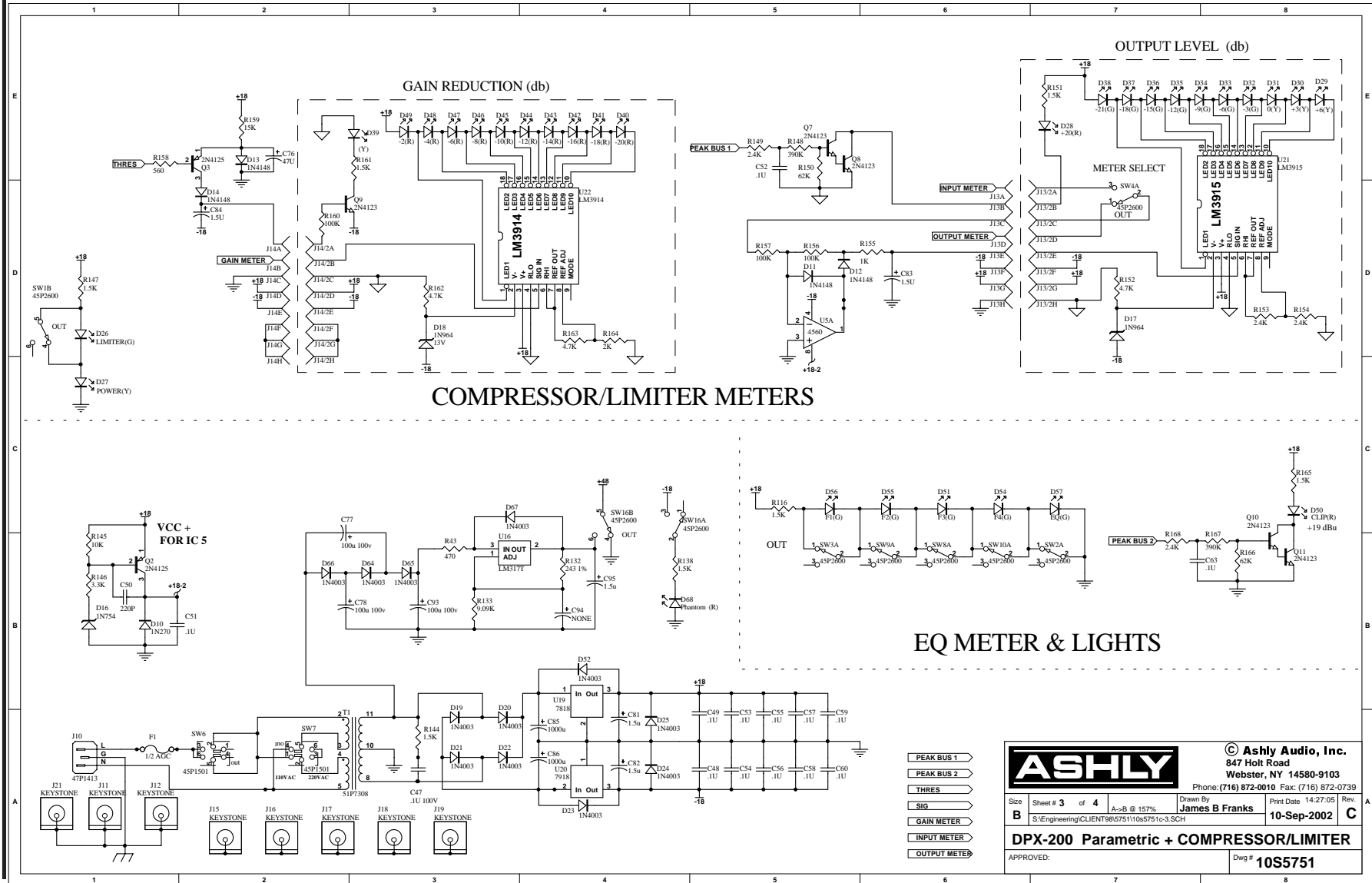

		© Ashly Audio, Inc. 847 Holt Road Webster, NY 14580-9103 Phone: (716) 872-0010 Fax: (716) 872-0739	
		Size Sheet # 3 of 4 A>B @ 157% S:\Engineering\CLIENT\985751\1065751c-3.SCH	Drawn By James B Franks Print Date 14-27-05 10-Sep-2002
DPX-200 Parametric + COMPRESSOR/LIMITER			
APPROVED:		Dwg # 10S5751	

ASHLY

ASHLY AUDIO INC. 847 Holt Road Webster, NY 14580-9103

Phone: (585) 872-0010 Fax: (585) 872-0739

Toll Free (800) 828-6308 Internet: www.ashly.com

© 2002 by Ashly Audio Corporation. All rights reserved worldwide.

Free Manuals Download Website

<http://myh66.com>

<http://usermanuals.us>

<http://www.somanuals.com>

<http://www.4manuals.cc>

<http://www.manual-lib.com>

<http://www.404manual.com>

<http://www.luxmanual.com>

<http://aubethermostatmanual.com>

Golf course search by state

<http://golfingnear.com>

Email search by domain

<http://emailbydomain.com>

Auto manuals search

<http://auto.somanuals.com>

TV manuals search

<http://tv.somanuals.com>