

Antec
Believe it.



ISK 300-65

USER'S MANUAL

TABLE OF CONTENTS

INTRODUCTION

1.1	Case Specifications.....	3
1.2	Diagram.....	3
1.3	Power Supply Specifications.....	4

HARDWARE INSTALLATION GUIDE

2.1	Removing the Top Panel.....	5
2.2	Removing the Drive Tray Assembly.....	5
2.3	Motherboard Installation.....	5
2.4	Internal 2.5" Device Installation.....	5
2.5	External Slim 5.25" Device Installation.....	6

CONNECTING THE FRONT I/O PORTS

3.1	USB 2.0 Ports.....	7
3.2	eSATA Port.....	7
3.3	AC'97 / HD Audio Ports.....	7
3.4	Switch and LED Connectors.....	8
3.5	Rewiring Motherboard Header Connections.....	8

COOLING SYSTEM

4.1	TriCool™ Exhaust Fan.....	9
-----	---------------------------	---

ISK 300-65 USER'S MANUAL

At Antec, we continually refine and improve our products to ensure the highest quality. It's possible that your new case will differ slightly from the descriptions in this manual. This isn't a problem; it's simply an improvement. As of the date of publication, all features, descriptions, and illustrations in this manual are correct.

Disclaimer

This manual is intended only as a guide for Antec's computer enclosures. For more comprehensive instructions on installing the motherboard and peripherals, please refer to the user's manuals that come with those components.

Although care has been taken to prevent sharp edges in your Antec case, we strongly recommend taking the appropriate time and care when working with it. Avoid hurried or careless motions. Please use reasonable precaution.

This manual is not designed to cover CPU, RAM, or expansion card installation. Please consult the motherboard manual for specific mounting instructions and troubleshooting. Before proceeding, check the manual for your CPU cooler to find out if there are steps you must take before installing the motherboard. While installing hardware, keep your case on a flat, stable surface.

1.1 CASE SPECIFICATIONS

Case Type	Mini-ITX Desktop
Color	Black
Dimensions	96mm (H) X 222mm (W) X 328mm (D) 3.8" (H) x 8.7" (W) x 12.9" (D)
Net Weight	5.5 lbs / 2.5 kg
Cooling	1 x Side 80mm TriCool™ fan
Drive Bays	3 Drive Bays: - 1 x External 5.25" slim drive bay - 2 x Internal 2.5" drive bays
Expansion Slots	1 x Half-height slot
Motherboard Size	Mini-ITX
Front I/O Panel	2 x USB 2.0 1 x eSATA AC'97 / HD Audio In and Out
Power Adapter	EP-65 power adapter and PCB

1.2 DIAGRAM

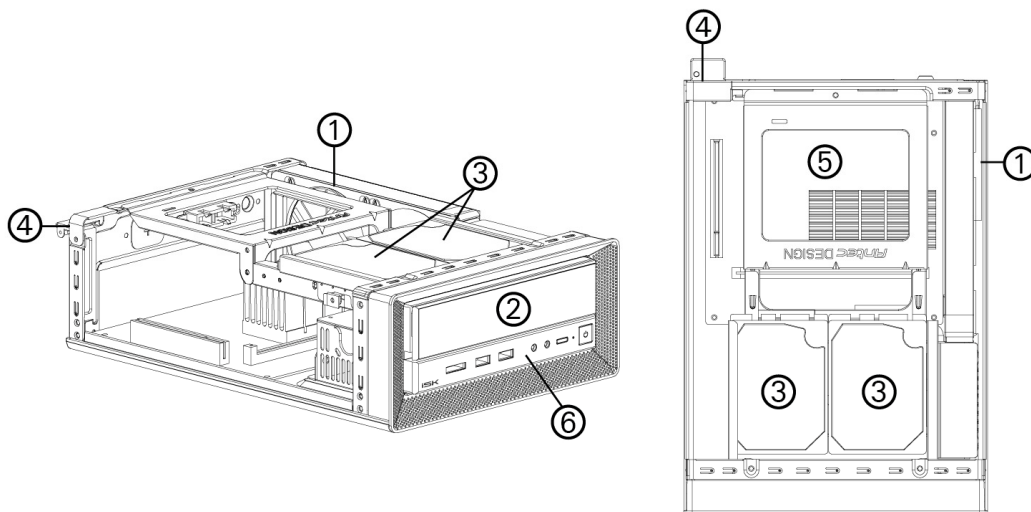

1. Side 80mm TriCool™ fan
2. External slim optical 5.25" drive bay
3. Internal 2 x 2.5" HDD bays
4. Half-height expansion slot
5. Motherboard mount – Mini-ITX
6. Front I/O panel
7. EP-65 power adapter (not pictured)

1.3 POWER SUPPLY SPECIFICATIONS

The ISK 300-65 is powered by an EP-65 power adapter.

Input characteristics:

Rated Voltage	Input Voltage Range	Frequency Range
100 VAC ~ 240 VAC	90 VAC ~ 264 VAC	50 Hz ~ 60 Hz

Output characteristics:

Rated Power	Rated Voltage	Voltage Range	Output Current	Ripple & Noise
65W	19V	18.4V ~ 20.0V	0A ~ 3.42A	< 350mV

A variety of industrial-grade safety circuitry will help protect your computer: OVP (Over Voltage Protection), SCP (Short Circuit Protection), OTP (Over Temperature Protection), and OCP (Over Current Protection). Sometimes the PSU will “latch” into a protected shutdown state. This means that you will need to power off the adapter and clear the fault before it will function again.

There are no user-replaceable fuses in the EP-65.

HARDWARE INSTALLATION GUIDE

2.1 REMOVING THE TOP PANEL

Place the case flat on an even, stable surface.

1. Remove the three thumbscrews from the rear of the top panel.
2. Grip the top panel and slide it back several inches until it stops.
3. Grip the panel from the sides and lift it up until it pulls completely free of the main chassis.

Note: Do not use your fingernails to pry or lift the panels.



2.2 REMOVING THE DRIVE TRAY ASSEMBLY

Remove the top panel as detailed in section 2.1.

1. Using a Phillips-head screwdriver, remove the three screws on the top of the tray that attach it to the chassis.
2. Grip the tray in the middle and pull it a few inches toward the rear of the case until it pulls loose.
3. Pull the drive tray assembly up and completely free of the chassis.

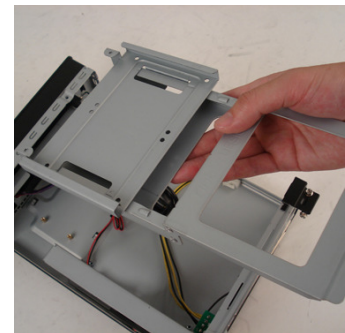

2.3 MOTHERBOARD INSTALLATION

Remove the top panel and remove the drive tray assembly as detailed in sections 2.1 and 2.2.

1. Lay the case down, with the open side facing up. The drive cages and power supply should be visible.
2. Make sure you have the correct I/O panel for your motherboard. If the panel provided with the case isn't suitable, please contact your motherboard manufacturer for the correct I/O panel. Install the I/O panel at the rear of the case.
3. Align your motherboard with the motherboard standoff holes located at the rear of the case.
4. Screw in your motherboard to the standoffs with the provided Phillips-head screws.



Your motherboard is now installed.

2.4 INTERNAL 2.5" DEVICE INSTALLATION

Remove the top panel as described in section 2.1. Included at the top of the drive tray assembly is a HDD tray that can support up to two 2.5" devices.

1. On the right side of the drive tray assembly, remove the thumbscrew holding the HDD tray to the rest of the device.
2. Slide the HDD tray back a centimeter so the locking hinges unhook.
3. Pull the HDD tray away from the drive tray assembly.
4. Align your 2.5" device with the HDD tray. Invert the tray so the lower screw holes are accessible, then secure the device to the tray with the provided Phillips-head screws.
5. Reattach the HDD tray to the drive tray assembly and replace the thumbscrew.
6. Connect the data and power connectors from the motherboard and power adapter to the device.

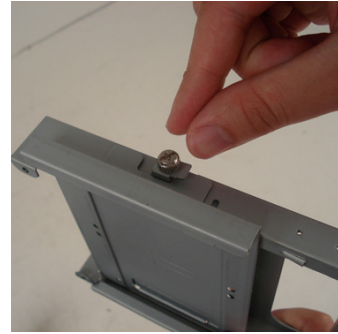

2.5 EXTERNAL SLIM 5.25" DEVICE INSTALLATION

Remove the top panel and drive tray assembly as described in sections 2.1 and 2.2. There is one externally accessible 5.25" drive bay that is compatible with a slim 5.25" optical drive.

1. While facing the front of the case, press on the upper right of the front of the 5.25" drive bay cover until it clicks, then release to allow the cover to unhinge.
2. Remove the drive bay face plate by applying pressure to the inside of the plate until it pops free of the bezel.
3. Install your slim optical drive in the drive bay assembly by sliding it into position from the rear of the assembly. Secure the device in place by attaching the included small screw on the right-hand side of the tray.
4. Connect the data and power connectors from the motherboard and power adapter to the device.
5. Replace the drive tray assembly in the chassis.

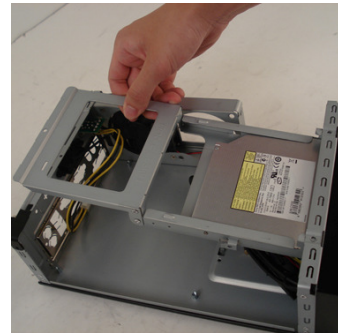

CONNECTING THE FRONT I/O PORTS

3.1 USB 2.0

Connect the front I/O panel USB cable to the USB header pin on your motherboard. Check the motherboard manual to ensure that it matches the table below:

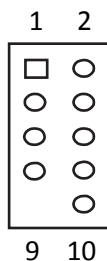

Pin	Signal Names	Pin	Signal Names
1	USB Power 1	2	USB Power 2
3	Negative Signal 1	4	Negative Signal 2
5	Positive Signal 1	6	Positive Signal 2
7	Ground 1	8	Ground 2
9	Key (No Connection)	10	Empty Pin

3.2 eSATA

You will find a SATA connector on a cable attached to the front ports. This internal SATA connector is designed to connect to a standard SATA connector on your motherboard. This will allow high-speed external hard disk enclosures such as the Antec MX-1 to run at the same speeds as internally installed hard disks.

3.3 AC'97 / HD AUDIO PORTS

There is an Intel® standard 10-pin AC'97 connector and an Intel® 10-pin HDA (High Definition Audio) connector linked to the front panel of the case.

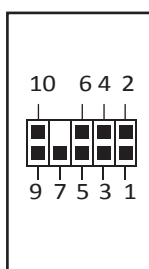

Pin	Signal Names (HDA)	Pin	Signal Names (AC'97)
1	MIC2 L	1	MIC In
2	AGND	2	GND
3	MIC2 R	3	MIC Power
4	AVCC	4	NC
5	FRO-R	5	Line Out (R)
6	MIC2_JD	6	Line Out (R)
7	F_IO_SEN	7	NC
8	Key (no pin)	8	Key (no pin)
9	FRO-L	9	Line Out (L)
10	LINE2_JD	10	Line Out (L)

You can connect either the AC'97 or the HDA connector, depending on your motherboard. Locate the internal audio connectors from your motherboard or sound card and connect the corresponding audio cable. Consult your motherboard or sound card manual for the pin-out positions. Even if your system supports both standards, only use one connector.

3.4 POWER SWITCH / RESET SWITCH / HARD DISK DRIVE LED CONNECTORS

Connected to your front panel are LED and switch leads for power, reset, and HDD LED activity. Attach these to the corresponding connectors on your motherboard. Consult your motherboard user's manual for specific pin header locations. For LEDs, colored wires are positive (+). White or black wires are negative (-). If the LED does not light up when the system is powered on, try reversing the connection. For more information on connecting LEDs to your motherboard, see your motherboard user's manual.

Note: Polarity (positive and negative) does not matter for switches.

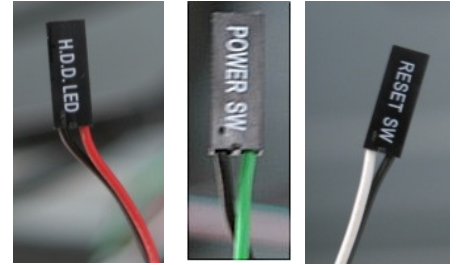

3.5 REWIRING MOTHERBOARD HEADER CONNECTIONS

There may come a time when you need to reconfigure the pin-out of a motherboard header connector. Examples could be for your USB header, audio input header, or some other front panel connector such as the Power Button connector.

Before performing any work, please refer to your motherboard user's manual or your motherboard manufacturer's website to be sure of the pin-out needed for your connector. We strongly recommend making a notated drawing before beginning work so that you can recover if your work gets disturbed.

1. Determine which wires you need to remove in order to rewire your plug to match the USB pin-outs on your motherboard (refer to your motherboard user's manual). Working on one connector at a time, use a very small flathead screwdriver or similar tool to lift up on the black tab located beside the gold posts (squares). This will allow you to easily slide out the pins from the USB plug.
2. Working carefully so as not to damage the wires, connectors, or pins, slowly remove the pin from the connector. Repeat these steps for each wire you need to change.
3. Working carefully so as not to damage the wires, connectors or pins, slowly reinsert the pin into the correct slot of the connector then snap closed the black tab that was lifted in step 1. Repeat these steps for each wire you need to change.



COOLING SYSTEM

4.1 TRI-COOL™ EXHAUST FAN

There is a 80 x 25mm TriCool™ fan pre-installed on the right-hand side of the case. It has an external, three-speed switch that allows you to choose between quiet performance, or maximum cooling. The default speed setting is Low. The fan is mounted so that air blows out of the case. There are externally accessible switches for these fans located at the rear of your case.

Size: 80 x 25mm TriCool™ fan
Rated Voltage: 12V
Operating Voltage: 10.2V - 13.8V

Speed (RPM)	Input Current	Airflow	Static Pressure	Acoustic Noise	Input Power
High 2600	0.2A (Max.)	0.96 m ³ / min (34 CFM)	3.04mm-H2O (0.12 inch-H2O)	30 dBA	2.4W
Medium 2000	0.15A	0.74 m ³ / min (26 CFM)	1.79mm-H2O (0.07 inch-H2O)	24.3 dBA	1.8W
Low 1500	0.1A	0.55 m ³ / min (20 CFM)	1.0mm-H2O (0.03 inch-H2O)	18.05 dBA	1.2W

Note: The minimum voltage to start a TriCool™ fan is 5V. We recommend that you set the fan speed switch to High if you choose to connect the fan(s) to a fan control device. A fan control device regulates the fan speed by varying the voltage, which may start as low as 4.5V to 5V. Connecting a TriCool™ fan set on Medium or Low to a fan-control device may result in the fan not being able to start because the already lowered voltage from the fan control device will be further reduced by the TriCool™ circuitry below 5V.

Antec, Inc.
47900 Fremont Blvd.
Fremont, CA 94538
USA
tel: 510-770-1200
fax: 510-770-1288

Antec Europe B.V.
Stuttgartstraat 12
3047 AS Rotterdam
Netherlands
tel: +31 (0) 10 462-2060
fax: +31 (0) 10 437-1752

Customer Support: US & Canada
1-800-22ANTEC
customersupport@antec.com

Europe
+31 (0) 10 462-2060
europe.techsupport@antec.com

www.antec.com

© Copyright 2009 Antec, Inc. All rights reserved.
All trademarks are the property of their respective owners. Reproduction in whole or in part
without written permission is prohibited.

Free Manuals Download Website

<http://myh66.com>

<http://usermanuals.us>

<http://www.somanuals.com>

<http://www.4manuals.cc>

<http://www.manual-lib.com>

<http://www.404manual.com>

<http://www.luxmanual.com>

<http://aubethermostatmanual.com>

Golf course search by state

<http://golfingnear.com>

Email search by domain

<http://emailbydomain.com>

Auto manuals search

<http://auto.somanuals.com>

TV manuals search

<http://tv.somanuals.com>