

APC Back-UPS®

Uninterruptible Power Source

User's Manual

230VAC

Models BK250EI,
BK400EI, BK600EI

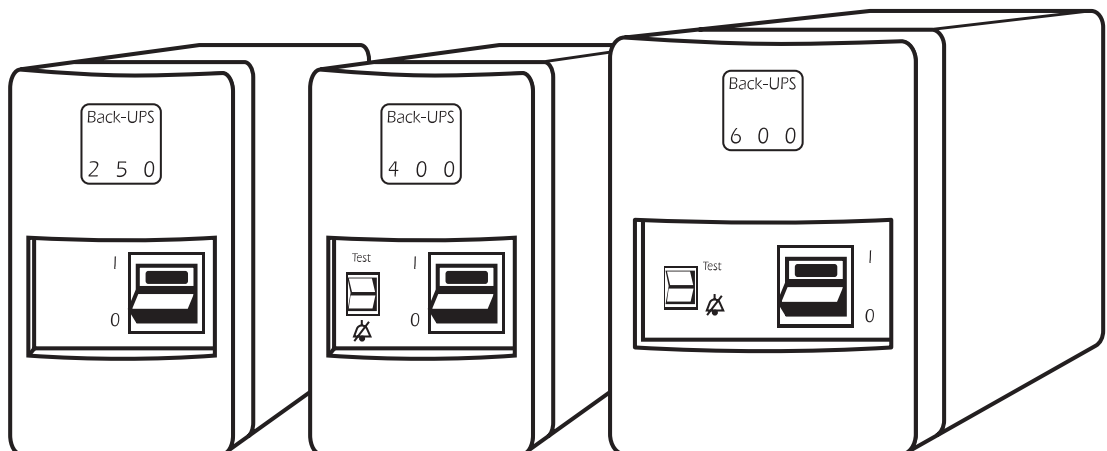

APC®

AMERICAN POWER CONVERSION

Download from www.Somanuals.com. All Manuals Search And Download.

Important Safety Instructions!

Please read this manual!

Veillez lire ce manuel!

Bitte lesen Sie dieses Anleitungshandbuch!

¡Se ruega leer este manual de instrucciones!

Thank you for selecting this American Power Conversion Uninterruptible Power Source (UPS). It has been designed for many years of reliable, maintenance free service. American Power Conversion is dedicated to the development of high performance electrical conversion and control products and we hope that you will find this UPS a valuable, convenient addition to your computing system.

This manual provides safety, installation and operating instructions that will help you derive the fullest performance and service life that the UPS has to offer. In addition, the manual describes the inner workings of the UPS and how they relate to providing superior protection from utility power problems such as blackouts, brownouts, sags, swells, EMI/RFI noise and surges.

Please save this manual!

It includes important instructions for the safe use of this UPS and for obtaining factory service should the proper operation of the UPS come into question. In the future, service or storage issues may arise and require reference to this manual.

Please save or recycle the packaging materials!

The UPS's shipping materials were designed with great care to provide protection from transportation related damage. The shipping materials will become useful to you in case the UPS must be returned to the factory for service (damages sustained in transit when shipped from the user are not covered under warranty).

Entire contents copyright © 1996 American Power Conversion. All rights reserved; reproduction in whole or in part without permission is prohibited. Back-UPS and PowerChute are registered trademarks of APC. All other trademarks are the property of their respective owners.

Part# 990-2030 10/96

Table of Contents

1.0 Introduction	2
2.0 Safety!	4
Sécurité! (Français)	5
Sicherheit! (Deutsch)	6
Seguridad! (Español)	7
3.0 Installation	8
4.0 Principles of Operation	13
5.0 Controls and Indicators	18
6.0 UPS monitoring	21
7.0 Difficulty	23
Difficulté (Français)	24
Schwierigkeit (Deutsch)	25
Dificultad (Español)	26
8.0 Storing the UPS	31
9.0 Run Time Versus Load	32
10.0 Specifications	33
Declaration of Conformity	35

1.0 Introduction

1.1 Overview

The UPS is a high performance standby uninterruptible power source designed to protect computers and peripheral devices such as monitors, modems, tape drives, etc. from utility line failures which could result in the loss or corruption of valuable data. In the event of a utility failure such as a blackout, brownout, or sag, the UPS rapidly transfers loads (computer equipment) to an alternative power source. This alternative power is derived from a battery within the UPS and provides the user with ample time to save files and properly close operations. A chart in section 9.0 shows how much time your equipment can remain operating during a utility failure before the UPS's batteries are drained. Under normal conditions when the utility voltage is within proper limits, the UPS maintains the battery in a charged condition and serves to isolate your equipment from surges and high frequency electrical noise.

After following the installation procedures and reading all the safety instructions, your computer equipment will be protected from hardware damage and loss of data caused by power problems.

1.2 User replaceable battery

The UPS provides user-safe access to the batteries for quick, easy replacement. The UPS's Test function (400VA and 600VA models) helps you determine when the battery is weak and requires replacement. New battery kits can be obtained from your dealer or the factory — simply call the Customer Service number on the cover of this manual. Your UPS's old, worn battery can be returned in the new battery kit's packaging for recycling.

1.3 Option switches

Option switches allow you to adjust the UPS for applications where frequent utility voltage fluctuations cause the UPS to transfer to on-battery operation too often. Audible alarm functions can be altered so that warning of utility failure or low battery conditions are given when desired.

1.4 Test / Alarm Disable switch

A dual function Test / Alarm Disable switch (400VA and 600VA models) allows you to check for proper operation by initiating a transfer to on-battery operation. This test ensures that the UPS is not overloaded and will support the system load during an actual power disturbance. By using the Test function throughout the life of the UPS, you can estimate when the UPS's battery should be replaced. During a utility failure, the Alarm Disable portion of the switch can be pressed to silence the audible alarm.

1.5 Surge suppression and EMI/RFI filtering

The UPS provides high performance surge suppression and EMI/RFI (electromagnetic and radio frequency interference) filtering. The UPS suppresses surges defined by the IEC 801-5 standard to levels well below that which is compatible with your computer.

1.6 Remote interface

The 600VA model is equipped with a remote computer interface port that is capable of signalling utility failure and low battery conditions. It also allows for unattended shutdown of computer operations. When teamed with PowerChute UPS monitoring software, you may select operation of power event logging, power event notification, automatic restart upon power restoration, and battery conservation features.

2.0 Safety!



Caution!

- *To reduce the risk of electric shock, disconnect the Uninterruptible Power Source from the mains before installing a computer interface signal cable (when used). Reconnect the power cord only after all signalling interconnections have been made.*
- *Connect the Uninterruptible Power Source to a two-pole, three-wire grounding mains receptacle. The receptacle must be connected to appropriate branch protection (fuse or circuit breaker). Connection to any other type of receptacle may result in a shock hazard and may violate local electrical codes.*
- *This Uninterruptible Power Source has an internal energy source (the battery) that cannot be de-energized by the user. **The output may be energized when the unit is not connected to a mains supply.***
- *To properly de-energize the Uninterruptible Power Source in an emergency, move the I/O switch to the O (off) position and disconnect the power cord from the mains.*
- *Avoid installing the Uninterruptible Power Source in locations where there is water or excessive humidity.*
- *Do not allow water or any foreign object to get inside the Uninterruptible Power Source. Do not put objects containing liquid on or near the unit.*
- *To reduce the risk of overheating the Uninterruptible Power Source, avoid exposing the unit to the direct rays of the sun. Avoid installing the unit near heat emitting appliances such as a room heater or stove.*
- *The Protective Earth conductor of this UPS carries the Leakage Current from the load devices (computer equipment). This UPS generates approximately 0.75 mA of leakage current. To ensure a safe limit of 3.5 mA, the total leakage current of the load devices should be limited to 2.75 mA. If you are unsure of the leakage current from the load devices, ensure that this product is plugged into a 3-wire receptacle that has a reliable (low impedance) Protective Earth connection to provide a safe path for the leakage current, and replace the powercord to the UPS with one that has a locking type plug (IEC 309) rated a minimum of 10 A. This powercord may require the services of a professional electrician for the installation of the matching wall receptacle.*

Attention!

- *Pour réduire le risque d'électrocution, débranchez la prise principale de la source d'alimentation permanente (Uninterruptible Power Source), avant d'installer le câble d'interface allant à l'ordinateur (si utilisé). Ne rebranchez le bloc d'alimentation qu'après avoir effectué toutes les connexions.*
- *Branchez la source d'alimentation permanente (UPS) dans une prise de courant à 3 dérivations (deux pôles et la terre). Cette prise doit être munie d'une protection adéquate (fusible ou coupe-circuit). Le branchement dans tout autre genre de prise pourrait entraîner un risque d'électrocution et peut constituer une infraction à la réglementation locale concernant les installations électriques.*
- *Cette source d'alimentation permanente (UPS) est munie d'une source d'énergie interne (accumulateur) qui ne peut pas être désactivée par l'utilisateur. La prise de sortie peut donc être sous tension même lorsque l'appareil n'est pas branché.*
- *En cas d'urgence, pour désactiver correctement la source d'alimentation permanente (UPS), poussez l'interrupteur sur la position O (Off) et débranchez le cordon d'alimentation principal.*
- *Ne pas installer la source d'alimentation permanente (UPS) dans un endroit où il y a de l'eau ou une humidité excessive.*
- *Ne pas laisser de l'eau ou tout objet pénétrer dans la source d'alimentation permanente (UPS). Ne pas placer de récipients contenant un liquide sur cet appareil, ni à proximité de celui-ci.*
- *Pour éviter une surchauffe de la source d'alimentation permanente (UPS), conservez-la à l'abri du soleil. Ne pas installer à proximité d'appareils dégageant de la chaleur tels que radiateurs ou appareils de chauffage.*
- *Le conducteur de terre de protection de cette UPS (Alimentation ininterrompue en courant) achemine le courant de fuite provenant des dispositifs de charge (équipement d'ordinateur). Cette UPS crée environ 0,75 mA de courant de fuite. Pour garantir une limite de sécurité de 3,5 mA, le courant total de fuite des dispositifs de charge doit être limité à 2,75 mA. Si vous n'êtes pas sûr du courant de fuite provenant des dispositifs de charge, assurez que ce produit soit enfiché dans une prise à 3 fils ayant une connexion de terre de protection fiable (à basse impédance) procurant un chemin sûr au courant de fuite, et remplacez le cordon secteur allant à l'UPS par un qui ait une fiche du type à verrouillage (IEC 309) et à valeur nominale de 10 A. Ce cordon secteur peut exiger les services d'un électricien professionnel pour l'installation de la prise murale correspondante.*

Vorsicht!

- *Um die Gefahr eines elektrischen Schlages auf ein Minimum zu reduzieren, die unterbrechungsfreie Stromversorgung vom Stromnetz trennen, bevor ggf. ein Computer-Schnittstellensignalkabel angeschlossen wird. Das Netzkabel erst nach Herstellung aller Signalverbindungen wieder einstecken.*
- *Die unterbrechungsfreie Stromversorgung an eine geerdete zweipolige Dreiphasen-Netzsteckdose anschließen. Die Steckdose muß mit einem geeigneten Abzweigschutz (Sicherung oder Leistungsschalter) verbunden sein. Der Anschluß der unterbrechungsfreien Stromversorgung an einen anderen Steckdosentyp kann zu Stromschlägen führen und gegen die örtlichen Vorschriften verstoßen.*
- *Diese unterbrechungsfreie Stromversorgung besitzt eine interne Energiequelle (Batterie), die vom Benutzer nicht abgeschaltet werden kann. Der Ausgang kann eingeschaltet werden, wenn das Gerät nicht an das Stromnetz angeschlossen ist.*
- *Um die unterbrechungsfreie Stromversorgung im Notfall ordnungsgemäß abzuschalten, den I/O-Schalter an der Rückseite auf O (Aus) stellen und das Netzkabel aus der Steckdose ziehen.*
- *Die unterbrechungsfreie Stromversorgung nicht an einem Ort aufstellen, an dem sie mit Wasser oder übermäßig hoher Luftfeuchtigkeit in Berührung kommen könnte.*
- *Darauf achten, daß weder Wasser noch Fremdkörper in das Innere der unterbrechungsfreien Stromversorgung eindringen. Keine Objekte, die Flüssigkeit enthalten, auf oder neben die unterbrechungsfreie Stromversorgung stellen.*
- *Um ein Überhitzen der unterbrechungsfreien Stromversorgung zu verhindern, das Gerät vor direkter Sonneneinstrahlung fernhalten und nicht in der Nähe von wärmeabstrahlenden Haushaltsgeräten (z.B. Heizgerät oder Herd) aufstellen.*
- *Der Erdableitstrom des Verbrauchers (Computer) fließt über den Schutzleiter des UPS-Netzgerätes ab. Das UPS-Netzgerät selbst erzeugt einen Erdableitstrom von ca 0,75 mA. Um den Sicherheitsgrenzwert von 3,5 mA nicht zu überschreiten, sollte der Erdableitstrom sämtlicher Verbraucher auf 2,75 mA begrenzt sein. Wenn Ihnen die Höhe des Ableitstromes von den Verbrauchern nicht bekannt ist, dann sorgen Sie dafür, daß dieses Gerät an eine Steckdose mit Schutzkontakt angeschlossen wird, der eine zuverlässige (geringe Impedanz) Schutzleiterverbindung hat, um einen sicheren Strompfad für den Erdableitstrom zu gewährleisten. Ersetzen Sie zudem die Netzanschlußleitung des UPS-Netzgerätes durch eine Netzanschlußleitung mit einer verriegelbaren, industriellen Steckvorrichtung (nach IEC 309), die für mindestens 10 Ampere ausgelegt ist. Eine derartige Netzanschlußleitung erfordert eventuell die Installation einer entsprechenden Netzsteckdose in der Wand durch einen Elektriker.*



¡Atencion!

- *Para reducir el riesgo de descarga eléctrica, desconecte de la red la Fuente de energía ininterrumpible antes de instalar el cable de señalización de interfaz de la computadora (si se usa). Vuelva a conectar el conductor flexible de alimentación solamente una vez efectuadas todas las interconexiones de señalización.*
- *Conecte la Fuente de energía ininterrumpible a un tomacorriente bipolar y trifilar con neutro de puesta a tierra. El tomacorriente debe estar conectado a la protección de derivación apropiada (ya sea un fusible o un disyuntor). La conexión a cualquier otro tipo de tomacorriente puede constituir peligro de descarga eléctrica y violar los códigos eléctricos locales.*
- *Esta Fuente de energía ininterrumpible tiene una fuente de energía interna (la batería) que no puede ser desactivada por el usuario. La salida puede tener corriente aun cuando la unidad no se encuentre conectada al suministro de red.*
- *Para desactivar correctamente la Fuente de energía ininterrumpible en una situación de emergencia, coloque el interruptor I/O en la posición O (Off -desconectado) y desconecte de la red el conductor flexible de alimentación.*
- *No instale la Fuente de energía ininterrumpible en lugares donde haya agua o humedad excesiva.*
- *No deje que en la Fuente de energía ininterrumpible entre agua ni ningún objeto extraño. No ponga objetos con líquidos encima de la unidad ni cerca de ella.*
- *Para reducir el riesgo de sobrecalentamiento, no exponga la unidad a los rayos directos del sol ni la instale cerca de artefactos que emiten calor, como estufas o cocinas.*
- *El conductor de protección a tierra conduce las corrientes de fuga de esta fuente ininterrumpible de potencia (UPS) generadas en los componentes de carga (equipos de computadora). La fuente ininterrumpible de potencia genera aproximadamente 0,75 mA de corriente de fuga. Para garantizar un límite de seguridad de 3,5 mA, el total de la corriente de fuga de los componentes de carga deberá limitarse a 2,75 mA. Si usted no está seguro del total de las corrientes de fuga de los componentes, asegúrese de que este producto esté conectado a un receptáculo de tres conductores que tenga una conexión de protección a tierra que sea confiable (impedancia baja) para proveer un camino seguro para la corriente de fuga. También asegúrese de reemplazar el cable que va a la fuente ininterrumpible de potencia con uno que tenga un enchufe con dispositivo de cierre (IEC 309) con capacidad para un mínimo de 10A. Este cable pudiera requerir los servicios de un electricista profesional para la instalación del receptáculo en la pared.*

3.0 Installation

3.1 Receiving inspection

Once the UPS has been removed from its shipping container, it should be inspected for damage that may have occurred while in transit. Immediately notify the carrier and place of purchase if any damage is found. Two output jumper cords are provided with the UPS. The packing materials are recyclable. Save for reuse or disposed of them properly.

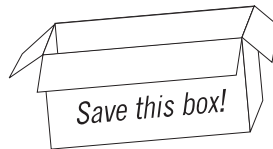

3.2 Placement

The UPS may be installed in any protected environment. The location should provide adequate air flow around the unit, in an atmosphere free from excessive dust, corrosive fumes or conductive contaminants. Do not operate the UPS in an environment where the ambient temperature or humidity is outside the limits given in the **Specifications** section of this manual.

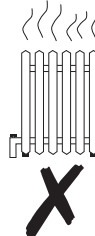
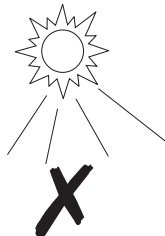

3.3 Load types

The UPS is designed to power all modern computer loads and associated peripheral devices such as monitors, modems, cartridge tape drives, external floppy drives, etc. The UPS is not rated to power life support equipment (as described on the rear cover of this manual).

Caution: The output waveform of this UPS is a sine wave approximation suitable for use with modern computer power supplies. Other load types may malfunction. In particular,

ferroresonant type regulating transformers are not recommended. Use of a surge suppressor connected to the output of this UPS may unnecessarily load the UPS when on-battery. This UPS contains high performance surge suppression - additional suppression components are not required and are not recommended. If in doubt, please consult the equipment manufacturer or the factory.

3.4 Connecting to the Utility

The UPS is furnished with two 1.8 meter output power cords for connection to computer equipment having "IEC 320" male appliance couplers at their input. However, due to the variety of plug connectors required for connection to electrical service in countries where the UPS may be operated, an input line cord is not supplied from the factory. In most cases this will not be a problem as the input cord which currently powers your computer equipment may be swapped with one of the supplied output cords. Hence, the swapped out line cord can be used instead as the input line cord for the UPS. If this is not the case, ask your local dealer or the factory about obtaining an input line cord for your application. Extra output power cords are also available from the factory.

The UPS is compatible with all 220, 230 and 240 Vac mains voltages. During a mains failure, the UPS powers your load at a nominal voltage of 225 Vac.

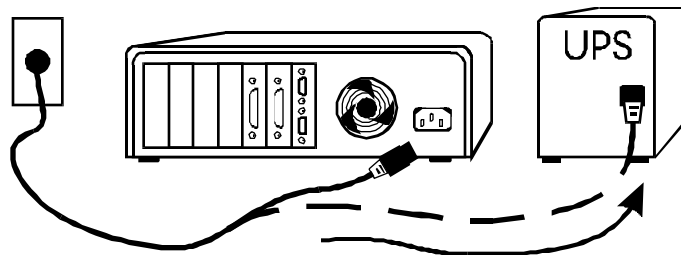

3.5 Battery charging

The UPS is shipped from the factory with its internal battery in a fully charged state. However, the battery may lose some charge during shipping and storage. The battery

should be recharged before conducting the following **Test for proper operation** (section 3.7) and to ensure that the UPS will provide expected run time. The UPS may be used immediately upon receipt, but may not provide expected run time in the event of a utility failure. The battery will recharge to full capacity within 6 hours when the UPS is plugged in and switched on. Once the battery has obtained a full charge, the UPS will maintain the charge as long as the UPS is plugged in, regardless of the position of the power I/O switch.

3.6 Connecting Your Equipment to the UPS

To ensure that your computer equipment will be protected during a utility failure and that you receive expected run time, it is important that you determine the total power needs of the equipment you wish to protect with the UPS. The power requirements of your equipment should be less than or equal to the capacity of the UPS. The capacity rating of the UPS, in both Volt-Amperes (VA) and Watts (W), is given in the **Specifications** section of this manual.

The power demands of your equipment can be read from the **Run Time Verses Load** (section 9.0) chart or may be deduced from the equipment name plates. The **Run Time Versus Load** chart gives equipment power requirements (load) in VA for computer systems common in the office environment today. If your equipment is not listed in the chart, the following instructions will help you to determine their power needs.

3.6.1 Computer equipment manufacturers must provide a load rating for their products. Usually, the rating is written on a name plate or label near the line cord. The rating may be given in units of Amps (A or Amax), Volt-Amperes (VA) or Watts (W). Jot down the load rating of all the equipment you wish to protect.

3.6.2 All noted load ratings should be converted to Volt-Amperes (VA) so that all equipment power requirements can be added using the same units of measure.

3.6.3 If load ratings are given in Watts (W), convert to an estimate of power requirements in VA by multiplying the value in Watts by 1.4.

3.6.4 If load ratings are given in Amps (A or Amax), convert to an estimate of power requirements in VA by multiplying the value in Amps by 230. Unfortunately, many computer manufacturers overrate the power requirements of their equipment in order to be conservative and to cover the extra power demand of user added expansion boards. If the VA requirement that you have computed seems high or is already greater than the

capacity of the UPS, don't worry. The next section describes a test that you can perform to determine whether or not your equipment and the UPS are compatible, even if the computed power requirement of your equipment is 50% greater than the capacity of the UPS!

3.6.5 Once all power requirement figures have been converted to VA units and added together, simply determine whether the power requirements of your equipment is less than or equal to the capacity of the UPS. If this is not the case, then it must be decided which equipment should be left unprotected by the UPS. See section 3.8 covering overloads.

3.6.6 An example of how to determine the power requirements of a computer system is given below.

Example - labels found at system equipment rear panels

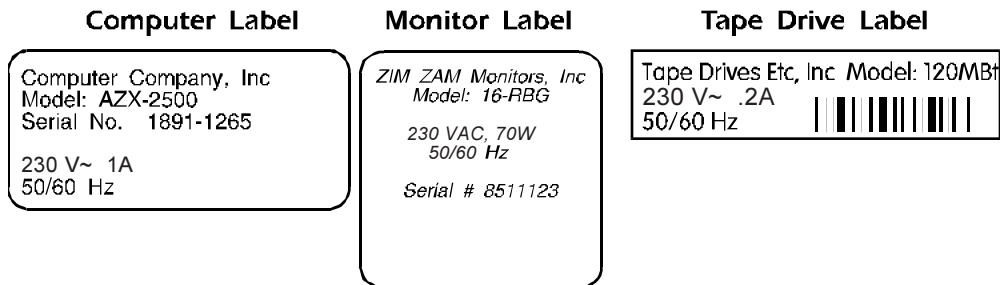

The power requirements of the example computer, monitor and external tape drive may be calculated as follows:

Computer VA	=	230 x 1 A	=	230 VA
Monitor VA	=	70 x 1.4	=	98 VA
Tape Drive VA	=	230 x .2A	=	46 VA
			<hr style="width: 20%; margin: 0 auto;"/>	
Total	=		=	374 VA

In this example, a UPS with at least 374 VA capacity can be employed to protect the computer, monitor and external tape drive. However, a UPS with somewhat lower capacity may still be used if the following test for proper operation is successful.

3.6.7 Once you have determined that your equipment and the UPS are compatible, plug your equipment into the UPS's rear panel output receptacles.

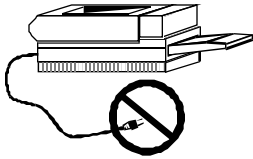

Note: Do not plug laser printers into this UPS! The power requirements of a typical laser printer are much larger than the requirements of other computer peripherals and may trip the UPS's rear panel circuit breaker. Plug laser printers into a quality surge suppressor. Remember that print jobs can be re-queued when the power is restored!

3.7 Test for Proper Operation

After the UPS has had a chance to recharge its battery, turn on the UPS's power I/O control and switch on your computer equipment. The indicator within the switch should be illuminated and your equipment should operate normally.

To test the operation of the UPS, simply unplug its input cord or press and hold the Test switch (on units so equipped) to simulate a utility blackout. The lamp within the power I/O switch will flash and UPS will immediately transfer your equipment to power derived from the UPS's internal battery. During this time, the UPS will emit one beep once every 5 seconds to remind you that your equipment is operating from a source of power that is limited in duration. Restore normal operation by releasing the Test control or by plugging in the line cord. Observe that your equipment operates normally during both transfer from utility power to UPS power and back again. Repeat this test four or five times to ensure proper operation. See the following section covering **Overloads** if abnormal operation is encountered. The power I/O control switches power to your equipment. If you leave your equipment power switches on, the I/O power control can be used as a master on/off switch!

3.8 Overloads

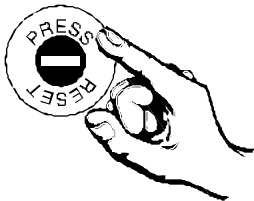

If the total power requirement of your equipment is much greater than the capacity of the UPS, the UPS's rear panel circuit breaker may trip. This is called an overload situation. Once the circuit breaker trips, the UPS will attempt to operate the load using its internal power source. This may result in an unexpectedly short run time or, if the overload is severe, the UPS will immediately shut down and cease to power the load. In this case, the UPS will emit a loud tone to alert you of the overload. If this occurs during your test, turn off the UPS and decide which equipment will be left unprotected by the UPS. The circuit breaker may be reset (press button) when the overload is removed.

4.0 Principles of Operation

Below is a block diagram showing the major components of your UPS. These blocks are described on the following pages, and are labelled accordingly.

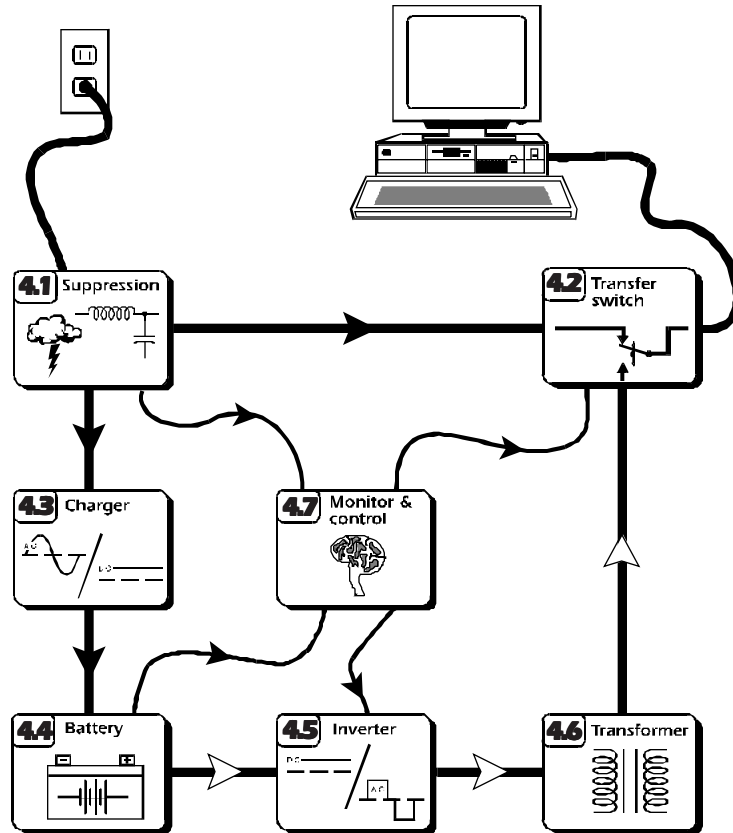

Block diagram showing all major components of your UPS.

4.1 Noise and surge suppression

The UPS contains high performance EMI/RFI (Electro-Magnetic and Radio Frequency Interference) noise and surge suppression circuitry to protect your computer equipment. The UPS provides this suppression continuously, whether or not it is turned on. Normally, the UPS will continuously filter surges and electrical noise without using the battery charge. The suppression circuitry will reduce the amplitude of these power disturbances to conform to the strict requirements of all modern computing equipment.

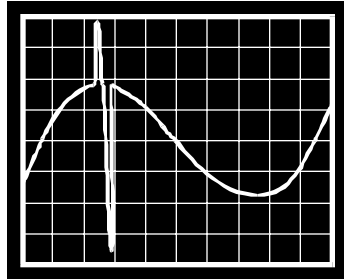

Surge

The illustration above shows what a typical “medium” amplitude surge or spike looks like when present on the utility voltage. Surges up to 15 times larger than this are easily suppressed by the UPS. Surges are commonly caused by nearby lightning activity and motor load switching created in air conditioners, elevators and heat pumps.

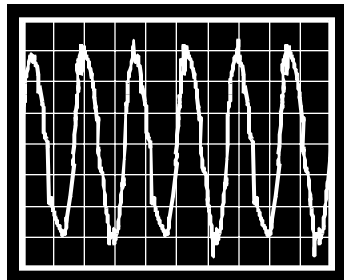

EMI/RFI Noise

The illustration above shows what EMI/RFI noise looks like when present on the utility voltage. The UPS “filters” out this noise with components whose electrical resistance is very high at radio frequencies. EMI/RFI noise is commonly created by the same activity which produces surges but can also be caused by nearby radio transmitters and blinking neon bulbs and signs.

4.2 Load transfer switch

The load transfer switch is actually an electro-dynamic relay which serves to rapidly transfer your computer equipment (load) from the utility to the UPS's alternate power source in the event of a utility failure. When the utility is restored to within safe limits, the switch acts to re-transfer the load to the utility. The time required for the relay to transfer your load to either power source is much, much faster than that which is required by any modern computer or computer peripheral device.

4.3 Battery Charger

The UPS's battery charger converts the alternating current (AC) supplied by the utility to a direct current (DC) which is compatible with the battery. The charger maintains the battery at a constant voltage to ensure that the battery will have the capacity to support your load as often as possible. This charging method, known as "float" charging, provides maximum battery service life and minimal internal heating. The battery is charged whenever the UPS is plugged in, whether or not it is switched on.

4.4 Battery

The UPS's battery is an energy source much like the battery in an automobile. Also, like most automobile batteries, the UPS's battery is a modern maintenance free lead-acid type; it is sealed and leakproof. The battery has a typical service life of 3 to 6 years. The service life is extended when the UPS is kept in a cool environment, below 30°C or 86°F.

4.5 Inverter

The UPS must convert the battery's energy into a form that your computer equipment can rely upon during a utility failure. This is the job of the UPS's inverter. The UPS converts the battery's DC to AC using solid state devices (transistors), controlled using a technique known technically as "pulse width modulation". This technique is highly efficient which means that little battery power is wasted in the conversion process. Hence, your equipment can run for long periods from the UPS before the battery's capacity is spent.

4.6 Transformer

The UPS's transformer is an electrical component which "steps up" the output voltage of the inverter to the normal utility line voltage. In addition, it serves to isolate the UPS from equipment failures.

4.7 Monitoring and control electronics

This block is the "brain" of the UPS. The monitoring and control circuitry detects utility failures such as blackouts, sags and brownouts; synchronizes the inverter's output frequency and phase to that of the utility; detects low battery voltage conditions; directs the load transfer switch; and governs all user controls, indicators and computer interface functions.

4.8 Operation during a utility failure

In anticipation of a utility failure such as a blackout, sag or brownout, the UPS continuously monitors the utility voltage and readies the inverter for "synchronous" transfer. This means the inverter's phase and frequency is adjusted to match the phase and frequency of the utility. If the utility voltage falls outside acceptable limits, the UPS rapidly transfers your equipment to power derived from the UPS's battery via the inverter and transformer described earlier. This transfer typically takes place within 8 milliseconds. Once operating in this mode, the UPS will beep once every 5 seconds to alert the user that there is limited time available to save files and shut down the computer. If the utility power is not restored to normal, the UPS will eventually sound continuous beeps to alert you that less than two minutes remain before the UPS shuts down and ceases to power your equipment. This is called a low battery condition which means that the UPS's usable battery capacity is nearly spent. The UPS will automatically shut down if the UPS is not turned off during the low battery alarm.

If the UPS detects the return of normal utility voltages at any time during operation using its alternate power source, the inverter voltage will be smoothly re-synchronized to match the phase and frequency of the utility. Once synchronized, the load transfer switch will re-transfer your equipment to power supplied by the utility. After an extended utility outage, the battery charger resupplies the battery with energy at a pace which is consistent with maximizing the service life of the battery (the battery could be charged faster, but wouldn't last as long).

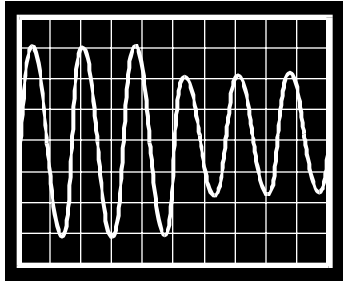

Brownout

Utility voltage sags are temporary amplitude reductions of the normal line voltage level. Utility voltage sags can be caused by local high power demand equipment such as elevators, air conditioners, shop tools and electric heaters. Brownouts, defined as long lasting utility voltage reductions, are sometimes initiated by the power company itself. During the hot season, the utility may choose to reduce the line voltage in order to cope with the huge power requirements of home and commercial use air conditioners.

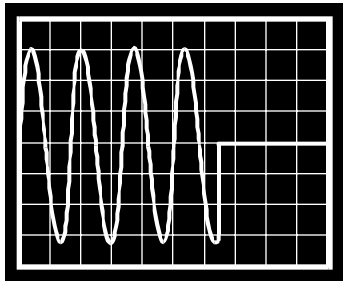

Blackout

Blackouts are defined by a complete loss of power. Often, blackouts are caused by accidents or acts of nature. However, they can also be created by overloaded “branch” circuits (building wiring segregated by fuses or circuit breakers), faulty circuit breakers or even a tripped-over line cord!

5.0 Controls and indicators

5.1 Power I/O switch

The power I/O switch controls power to the UPS and its output receptacles. When the switch is on, the UPS operates and your computer equipment will be powered. When the switch is off, the UPS is de-energized and your equipment is unpowered. If your equipment switches are left on, the entire system can be operated by using just the power I/O switch! The lamp within the power I/O switch illuminates whenever normal voltages are present at the output receptacles. When the switch is in the on position and the lamp is extinguished, the UPS has shut down due to overload or low battery.

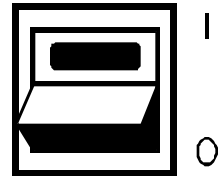

5.2 Test/Alarm Disable switch (on units so equipped)

When operating during a utility power outage, the UPS will emit a beep once every five seconds. This beep can be silenced by pressing the Alarm Disable control (bottom of toggle switch.) However, the UPS's low battery warning will still sound in the event of an extended utility outage.

When the Test portion of the Test/Alarm Disable switch is pressed, (top of toggle switch) the UPS simulates a power outage and transfers your load to the alternate power source. This feature allows you to determine that computer equipment protected by the UPS operates normally during transfers. It also provides a convenient means of testing the UPS's battery. If the Test control is held depressed, the UPS will operate your equipment from power derived from the battery continuously. If during the test the low battery warning is sounded prematurely and the load is known to be normal, then the battery is weak and requires extended recharge or replacement (see section 7.0).

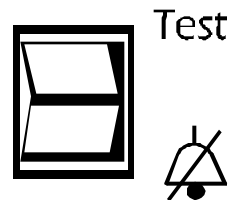

5.3 Audible alarm

During a utility failure, the UPS emits a beep once every five seconds to warn you that your equipment is operating from a source of power which is limited in duration. The alarm can be defeated using the Alarm Disable switch (on units so equipped) or, in advance of the outage, via option switch #1. In the event of an extended utility failure, the UPS will

sound a loud tone 2 minutes in advance of shut down due to battery capacity exhaustion. Once shut down, the UPS will return to the periodic beep. The UPS should be turned off at this point to cease the alarm. In the event the UPS encounters a severe overload, the UPS will shut down and emit a loud tone. The alarm is reset when the UPS is turned off.

5.4 Option Switches

The option switches are located on the rear panel and are set to the down (off) position as supplied from the factory.

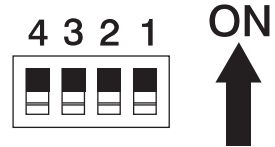

5.4.1 Option Switch #1

When option switch #1 is set to the up (on) position in advance of a utility failure, the UPS's audible utility failure alarm is defeated. When the switch is set to the down position (this is the factory setting), the UPS beeps once every five seconds when the utility voltage has fallen outside acceptable limits. Regardless of the position of this control, the UPS will still sound a loud tone during the low battery conditions. This feature is convenient where brief power interruptions are common and the audible alarm becomes an annoyance.

5.4.2 Option Switch #2 and #3

Option switches #2 and #3 adjust the utility voltage at which the UPS will transfer your computer equipment to the UPS's alternate power source. Adjustment of the "transfer voltage" is desirable where frequent line voltage excursions or line voltage distortion cause the UPS to transfer many times a day. The switches may be set according to the following charts if it is known that your equipment will operate normally under such line voltage conditions. Normally, the switches should be left in the down position (this is the factory setting).

Option Switch #2	Option Switch #3	Undervoltage Transfer
Down (OFF)	Down (OFF)	196 Vac
Up (ON)	Down (OFF)	184 Vac
Down (OFF)	Up (ON)	172 Vac
Up (ON)	Up (ON)	160 Vac

5.4.3 Option Switch #4

Option switch #4 sets the internal operating frequency of the inverter. It should be set to match the local line frequency. When in the down (off) position, the UPS will operate properly with a 50 Hz line. If your local line frequency is 60 Hz, set the option switch #4 in the up (On) position.

6.0 UPS monitoring

6.1 Overview

A UPS system alone provides excellent protection from brief power problems. However, during an extended power outage an unattended computer system will eventually shut down due to battery capacity exhaustion. To prevent data corruption when the UPS shuts down, the computer must be informed by the UPS of impending shut down and take appropriate file-saving measures. This important function is called "UPS monitoring." The UPS's computer interface port is the means by which your UPS communicates with a computer system.

Some computer operating systems have built-in UPS monitoring. These systems require various hardware interfaces. Interface kits for all operating systems that support UPS monitoring are available from your dealer. In addition, your dealer also offers PowerChute software which enhances such built-in UPS monitoring. Versions of PowerChute are available which add the UPS monitoring function to the many operating systems which do not inherently provide UPS monitoring.

6.2 PowerChute Software (600 VA only)

PowerChute software provides complete data protection for most operating systems. This software is a background process that monitors the UPS through a RS-232 serial port on the host. PowerChute offers user notification of impending shutdown, power event logging, auto-restart upon power return and UPS battery conservation features. PowerChute is available for many platforms including Novell, LAN Manager, AppleShare, most UNIX-based operating systems, and DEC VAX/VMS. Please visit APC's Web site at <http://www.apcc.com> for further information.

Caution: *Use only factory supplied or authorized UPS monitoring cables!*

6.3 Computer Interface Port (600 VA only)

The computer interface port is diagramed below for your reference. Those with technical abilities wishing to use this port in a special application should be aware of the following limitations and capabilities of the interface.

6.4.1 Outputs at pins 3, 5 and 6 are actually open collector outputs which must be pulled up to a common referenced supply no greater than +40 Vdc. The transistors are capable of a maximum non-inductive load of 25 mAdc. Use only Pin 4 as the common.

6.4.2 The output at Pin 2 will generate a LO to HI RS-232 level upon transfer of the output load to power derived from the UPS's battery. The pin is normally at a LO RS-232 level.

6.4.3 The UPS will shut down when a HI RS-232 level, sustained for 0.5 s, is applied to Pin 1. The UPS responds to this signal, following a delay, only during utility failures (load is operating from the UPS's internal power source).

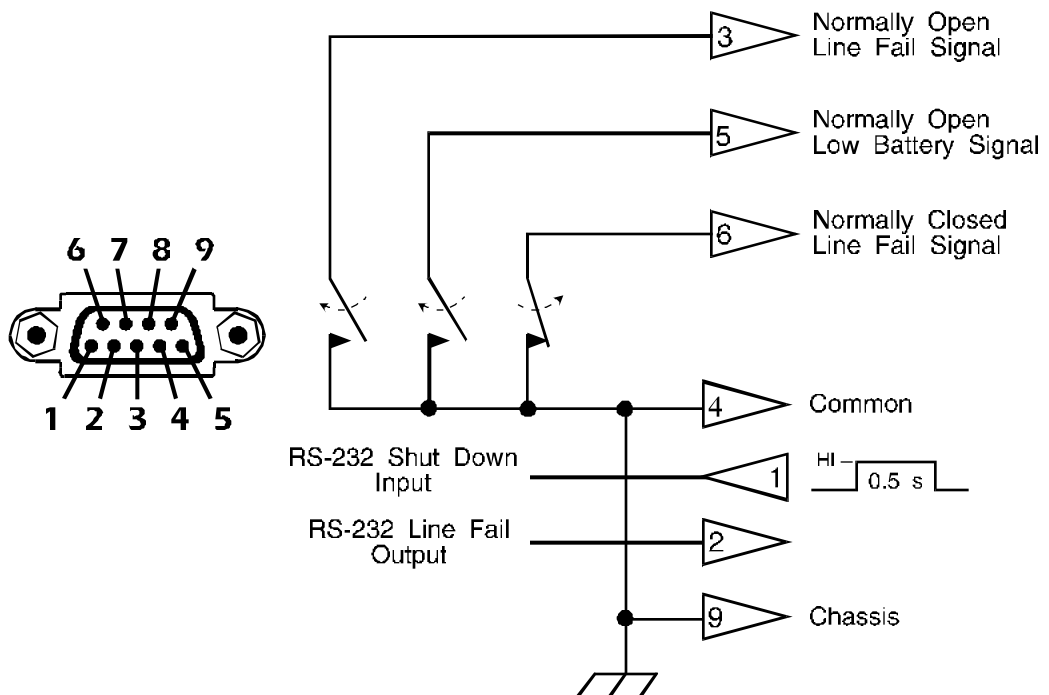



Caution!

- *This Uninterruptible Power Source contains potentially hazardous voltages. Do not attempt to disassemble the unit. Repairs are performed only by factory trained service personnel. The unit contains no user serviceable parts except for a replaceable battery.*
- *This Uninterruptible Power Source uses batteries. The batteries will eventually become too weak to provide rated autonomous operation. To obtain battery replacement or repair service, please call the Customer Service telephone number on the back cover of this manual for information on the Service Center nearest you.*



- **The batteries used by this Uninterruptible Power Source are recyclable. Proper disposal of the batteries is required. The batteries contain lead and pose a hazard to the environment and human health if not disposed of properly. Please refer to local codes for proper disposal requirements or return the battery to a factory authorized Service Center.**
- *Battery replacement should be performed or supervised by personnel familiar with the danger of batteries and the required precautions. Keep unauthorized personnel away from batteries. When replacing batteries, use the same number and type of sealed lead acid batteries as were originally contained in your UPS.*
- **CAUTION - Do not dispose of batteries in a fire. The batteries may explode.**
- **CAUTION - Do not open or mutilate a UPS battery. They contain an electrolyte which is toxic and harmful to the skin and eyes.**
- **CAUTION - A battery can present a risk of electrical shock and high short circuit current. When replacing batteries, wrist watches and jewelry such as rings should be removed. Use tools with insulated handles.**

Attention!

- Cette source d'alimentation permanente (UPS) contient des circuits haute tension présentant un danger. Ne jamais essayer de le démonter. Il n'y a aucun composant qui puisse être réparé par l'utilisateur. Toutes les réparations doivent être effectuées par du personnel qualifié et agréé par le constructeur.
- Cette source d'alimentation permanente (UPS) contient des accumulateurs. Ces accumulateurs deviendront un jour trop faibles pour pouvoir assurer un fonctionnement autonome correct. Pour toute réparation ou remplacement des accumulateurs, composez le numéro du Service à la clientèle inscrit sur la couverture de ce manuel afin d'obtenir les coordonnées du Centre de Service le plus proche.



- Les accumulateurs contenus dans cette source d'alimentation sont recyclables. L'élimination des batteries est réglementée. Consulter les codes locaux à cet effet. Ils contiennent du plomb et représentent donc un risque pour l'homme et pour l'environnement si les règles de mise au rebut ne sont pas respectées. Veuillez retourner l'unité à un Centre de Service agréé lorsque vous désirerez remplacer ou vous débarrasser des accumulateurs usagés.
- Le remplacement de batterie doit être effectué ou surveillé par du personnel au courant du danger des batteries et des précautions à prendre exigées. Quand vous remplacez les batteries, utilisez le même numéro et le même type de batteries au plomb étanches que celles contenues à l'origine dans votre UPS.
- ATTENTION - Ne jetez pas les batteries dans un feu. Les batteries peuvent exploser.
- ATTENTION - N'ouvrez pas ni ne mutilez la batterie ou les batteries. Elles contiennent un électrolyte qui est toxique et dangereux pour la peau et les yeux.
- ATTENTION - Une batterie peut présenter un risque de choc électrique, de brûlure par transfert d'énergie. Suivre les précautions qui s'imposent. Quand vous remplacez des batteries, il faut retirer les montres-bracelets et la bijouterie comme les bagues. Utilisez des outils ayant des manches isolés.

Vorsicht!

- *Im Inneren dieser unterbrechungsfreien Stromversorgung herrschen potentiell gefährliche Spannungen. Nicht versuchen, das Gerät zu öffnen. Es enthält keine vom Benutzer reparierbaren Teile. Reparaturen dürfen nur von ausgebildetem Kundendienstpersonal durchgeführt werden.*
- *Diese unterbrechungsfreie Stromversorgung enthält Batterien, die nach einer bestimmten Zeit so schwach werden, daß der autonome Nennbetrieb nicht mehr gewährleistet ist. Aufgrund der potentiellen Gesundheits- und Umweltgefahren, die von den Batterien ausgehen, dürfen sie nur in einem vom Werk autorisierten Kundendienstzentrum ausgewechselt werden. Dort teilt man Ihnen mit, welches Kundendienstzentrum für Sie zuständig ist.*



- *Die Batterien in dieser unterbrechungsfreien Stromversorgung sind wiederverwertbar. Sie sind bleihaltig und stellen eine Gefahr für die Umwelt und die Gesundheit dar, wenn sie nicht ordnungsgemäß entsorgt werden. Das Gerät an ein vom Werk autorisiertes Kundendienstzentrum einsenden, um die Batterien auszuwechseln oder entsorgen zu lassen.*
- *Der Austausch der Batterien sollte von oder unter der Aufsicht von Personen durchgeführt werden, die mit den Gefahren von Batterien und den erforderlichen Vorsichtsmaßnahmen vertraut sind. Halten Sie nicht autorisierte Personen von den Batterien fern. Wenn Sie die Batterien ersetzen wollen, verwenden Sie die gleiche Anzahl und den gleichen Typ (geschlossene Bleiakkumulatoren) der ursprünglich mit dem Gerät geliefert wurde.*
- **VORSICHT!** *Werfen Sie die Batterien nicht ins Feuer. Es besteht Explosionsgefahr.*
- **VORSICHT!** *Die Batterien nicht öffnen oder zerstören. Sie enthalten einen giftigen Elektrolyten der für Augen und Haut gesundheitsschädlich ist.*
- **VORSICHT!** *Eine Batterie stellt eine Gefahr in bezug auf elektrischen Schlag und hohe Kurzschlussströme dar. Tragen Sie daher keine Armbanduhr oder Ringe, wenn Sie die Batterien ersetzen. Benutzen Sie Werkzeuge mit isolierten Griffen.*

¡Cuidado!

- *Esta Fuente de energía ininterrumpible contiene niveles de voltaje peligrosos en potencia. No intente desarmar la unidad, pues no contiene piezas que puedan ser reparadas por el usuario. Las reparaciones deben efectuarse únicamente por parte del personal de mantenimiento capacitado en la fábrica.*
- *Esta Fuente de energía ininterrumpible contiene baterías. Con el tiempo las baterías se gastan demasiado para poder sustentar el funcionamiento autónomo a la capacidad nominal. Para solicitar el reemplazo de baterías o servicio de reparaciones, se ruega llamar al número telefónico de Atención a los Clientes indicado en la tapa de este manual y averiguar el Centro de Servicio más cercano.*



- *Las baterías que se encuentran en esta Fuente de energía ininterrumpible son reciclables. Las baterías contienen plomo y constituyen un peligro para el medio ambiente y para la salud de las personas si no se las desechan como corresponde. Se ruega devolver la unidad a un Centro de Servicio autorizado por la fábrica para el reemplazo o la eliminación de las baterías.*
- *El reemplazo de baterías deberá ser hecho o supervisado por profesionales familiarizados con los daños y precauciones relacionadas con ellas. Mantenga a las personas no autorizadas alejadas de las baterías. Cuando cambie las baterías, use del mismo número y tipo de baterías de ácido de plomo selladas que las originales dentro de su fuente ininterrumpible de potencia.*
- **ADVERTENCIA** - *No eche las baterías en el fuego. Pudieran explotar.*
- **ADVERTENCIA** - *No abra o mutile la(s) batería(s). Contienen un electrolito que es tóxico y dañino a la piel y a los ojos.*
- **ADVERTENCIA** - *Las baterías representan un riesgo de impacto eléctrico y de altas corriente de corto circuito. Cuando reemplace las baterías deberá quitarse todos los relojes y las joyas tales como anillos. Use herramientas que tengan los mangos aislados.*

7.1 Troubleshooting Chart

PROBLEM	POSSIBLE CAUSE	ACTION TO TAKE
UPS will not turn on (lamp within power I/O switch is not illuminated), but beeps when power I/O switch is on.	1. Line cord plug is loose.	1. Check fit of line cord plug.
	2. Rear panel circuit breaker is tripped.	2. Circuit breaker is tripped when button is extended. Unplug excessive loads and reset breaker (press button).
	3. Dead wall socket.	3. Check wall socket with a table lamp.
UPS occasionally emits beep, computer equipment operates normally.	The UPS is briefly transferring your equipment to its alternate power source due to utility voltage sags or spikes.	This operation is normal. The UPS is protecting your computer equipment from abnormal utility voltages.
UPS emits beep very often, more than once or twice an hour. Computer equipment operates normally.	Utility voltage is distorted or branch circuits are heavily loaded.	Have your line voltage checked by an electrician. Operating your UPS from an outlet which is wired to a different branch fuse or circuit breaker may help.
UPS does not provide expected run time. Low battery warning is sounded prematurely.	1. Excessive loads connected at UPS's output receptacles.	1. Unplug excessive loads from UPS. Recheck computer system power requirements as described in installation instructions.
	2. Battery is weak due to wear or recent operation during utility power outage.	2. The battery should be recharged by leaving the UPS plugged in for 6 hours - do not operate Test control during recharge. If UPS sounds low battery warning prematurely when retested, battery should be replaced.
UPS emits loud tone during utility failure. Power I/O switch is on but computer equipment is not powered. Rear panel circuit breaker is not tripped.	UPS has shut down due to overload.	Turn off UPS and unplug excessive loads. Recheck computer system power requirements as described in installation instructions. UPS may be turned on when utility has been restored.

7.1 Troubleshooting Chart (continued)

PROBLEM	POSSIBLE CAUSE	ACTION TO TAKE
UPS emits loud tone. Power I/O switch is on but computer equipment is not powered. UPS's rear panel circuit breaker is tripped (button is extended). Normal utility voltages are known to be present.	UPS has shut down due to severe overload.	Turn off UPS and unplug excessive loads. Laser printers will overload the UPS and should be plugged into a quality surge suppressor. See the section covering Overloads. Once overload is removed, reset the circuit breaker (press button).
UPS beeps continuously. Lamp within I/O power switch is illuminated. Utility is not failed.	1. Line cord plug is loose.	1. Check fit of line cord plug.
	2. Circuit breaker is tripped.	2. Unplug excessive loads and reset circuit breaker (press button).
UPS does not shut down when RS-232 HI level is applied to computer interface port pin 1.	1. Signal not applied during utility failure.	1. The UPS responds to this signal only during utility failures (load is operating from the UPS's internal power source).
	2. Signal is not referenced to UPS common.	2. Signal must be referenced to the UPS's common at DB-9F pins 4 or 9.
Low battery warning interval is shorter than 2 minutes.	1. Excessive loads connected at UPS's output receptacles.	1. Excessive loading may shorten run time to below 2 minute low battery warning interval - remove excessive loads.
	2. Battery capacity low due to consecutive utility failures.	2. Consecutive utility failures may not allow time for the battery to recharge thereby causing shortened run time.
Low battery warning interval is much longer than 2 minutes.	UPS is loaded to much less than full rated capacity.	This operation is normal. The low battery warning interval is extended when operated under light load.

7.2 Replacing the Battery

You can expect to receive 3 to 6 years of service life from the UPS's battery when installed in a cool, dry location. If you suspect the battery is weak, allow the UPS to charge the battery for at least 6 hours and perform the **Test for proper operation** described in section 3.7. If after repeating the test you find that the run time is still too short, follow the procedures below to replace the battery.

Note: Please read the cautions at the beginning of this section.

7.2.1 Turn off the UPS and unplug it from service. Lay the UPS on its left side and remove the two battery door screws. Remove only the screws indicated on the battery door.

7.2.2 Gently pull out the battery by grasping the white tab.

7.2.3 Remove the two wires connecting the battery to the UPS. To loosen the wire connectors, gently wiggle the connectors side-to-side while pulling straight back from the mating battery connector.

7.2.4 Connect the battery wires to the new battery. The red wire is positive (+), the black wire is negative (-).

7.2.5 Position the new battery as shown below and place it into the UPS. Arrange the wires so that they will not interfere with the battery installation.

7.2.6 Close the battery door and fasten the two battery door screws.

7.2.7 Return the worn battery to the factory for recycling.

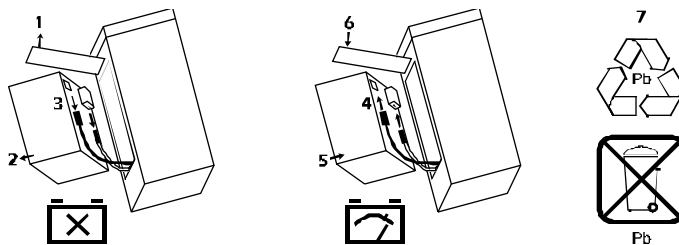

7.3 Obtaining Service

The troubleshooting chart in section 7.1 covers most of the difficulties that a user may encounter under conditions other than a failure of the UPS itself. For problems not covered in the chart, follow the below listed instructions.

- *See the troubleshooting chart and eliminate the obvious. A tripped UPS circuit breaker is the most common problem encountered and is user resettable once excessive loads are unplugged from the UPS.*
- *If the circuit breaker is OK, note your UPS model, serial number and date of purchase. Contact the Customer Service Department at the phone number given on the cover of this manual.*
- *Be prepared to provide a description of the problem. A technician will help you solve the problem over the phone if possible, or will give you a Return Material Authorization Number (RMA#).*
- *If the UPS is within the warranty period, repairs will be performed free of charge. If it is not within the warranty period, there will be a charge for repair.*
- *Pack the UPS in its original packaging. If you no longer have the original shipping materials, ask the technician about obtaining a new set. It is very important that you pack the UPS properly to avoid damage in transit. Never use styrofoam beads for packing because the UPS will settle through beads and become damaged. Damages sustained in transit are not covered under warranty. Enclose a letter in the package with your name, RMA#, address, copy of sales receipt, description of trouble, phone number and check (if necessary).*
- *Mark your RMA# on the outside of the package. The factory cannot accept any package without this marking.*
- *Return your UPS via insured, prepaid carrier to the address on the rear of this booklet.*

8.0 Storing the UPS

8.1 Storage Conditions

The UPS should be covered and stored in an upright position, in a cool, dry location. The UPS should be stored with the battery in a fully charged state. This means that the UPS should be allowed to charge the battery for at least 6 hours before the UPS is switched off for storage.

8.2 Extended Storage

To achieve expected run time following extended storage, the UPS should be allowed to refresh the battery for 12 hours once every 6 months in environments where the ambient temperature is -15°C to $+30^{\circ}\text{C}$ (5°F to 86°F). For extended storage in environments where the ambient temperature is $+30^{\circ}\text{C}$ to $+45^{\circ}\text{C}$ (86°F to 113°F), the UPS should be allowed to refresh the battery for 12 hours once every month.

9.0 Run Time Versus Load

Load	Model 250	Model 400	Model 600	Typical computer load
75 VA	29 min	72 min	105 min	Typical monochrome mainframe terminal
100 VA	23 min	47 min	79 min	Small desktop system with 12" monitor
150 VA	14 min	30 min	54 min	Point of sale system (cash registers)
200 VA	8 min	19 min	41 min	Desktop 486 system with 14" monitor
250 VA	5 min	13 min	31 min	Desktop Pentium or PowerMac with 15" monitor
400 VA		5 min	13 min	Multimedia system with 17" monitor (including external CD-ROM & modem)

Note: Run times are given at 25°C (77°F). Load values given in VA (Volt-Amps).

10.0 Specifications

10.1 Input

Nominal input voltage: *single phase 230 Vac.*

Nominal input frequency: *50 or 60 Hz, selected by option switch #4.*

10.2 Transfer Characteristics

Frequency limits for on-line operation: *±5% of the nominal 50 or 60 Hz.*

Low input voltage limit for on-line operation: *196 Vac., may be set lower.*

10.3 Output Characteristics

Maximum load: *250 VA or 170 W, 400 VA or 250 W, and 600 VA or 400 W for models 250, 400 and 600 respectively.*

Nominal output voltage: *225 Vac, ±5%. When verifying UPS on-battery output voltage, use only a true rms responding voltmeter.*

Frequency regulation: *50 or 60 Hz, ±3% unless synchronized to the utility.*

Waveshape: *stepped approximation to sine wave; peak and rms values equivalent to the utility.*

Protection: *electronically overcurrent and short circuit protected, overload shutdown is latched.*

10.4 Battery and charger

Battery type: *maintenance free lead-acid, sealed and leakproof.*

Typical service life: *3-6 years, dependent on number of discharges, temperature.*

Low battery signalling: *≥ 2 minute audible tone, interface port signal.*

Recharge time: *6 to 10 hours, dependent on load and length of utility outage.*

10.5 Surge and noise suppression

Surge energy rating: 320 Joules (one time, 10/1000 μ s waveform).

Surge current capability: 6500 Amp peak (one time, 8/20 μ s waveform).

Surge response time: 0 ns (instantaneous) normal mode.

Noise filter: full time EMI/RFI suppression, 100 kHz to 10 MHz.

10.6 Operating environment and physical dimensions

Operating environment: 0°C - 40°C (32°F - 104°F), 0 to 95% RH, non condensing.

Size: 250 and 400 VA models: 6.0" H x 3.4" W x 13.1" D (15cm x 9cm x 33cm).

600 VA model: 6.6" H x 4.7" W x 14.2" D (17cm x 12cm x 36cm).

Weight: 250 VA model: 13.9 lb (6.3 kg).

400 VA model: 15.3 lb (7.0 kg).

600 VA model: 24.3 lb (11.0 kg).

Add 3 lb (1.5 kg) for shipping.

Declaration of Conformity

Application of Council Directives: 89/336/EEC,73/23/EEC,92/31/EEC,
93/68/EEC,91/157/EEC

Standards to which conformity is declared: EN55022, EN50082-1, EN50091, EN60950

Manufacturer's Name and Address: American Power Conversion
132 Fairgrounds Road
West Kingston, Rhode Island, 02892, USA
-or-
American Power Conversion (A. P. C.) b. v.
Ballybritt Business Park
Galway, Ireland
-or-
American Power Conversion Phillipines
Second Street
Caivte EPZA
Rosario, Cavite Phillipines

Importer's Name and Address: American Power Conversion (A. P. C.) b. v.
Ballybritt Business Park
Galway, Ireland

Type of Equipment: Uninterruptible Power Source

Model Numbers: Back-UPS 250EI, 400EI, 600EI

Serial Numbers: X9601 000 0000 — X9699 999 9999*
X9701 000 0000 — X9799 999 9999*

Years of Manufacture: 1996, 1997

Note: Where X = B, O, W, or D

We, the undersigned, hereby declare that the equipment specified above conforms to the above directives.

Billerica, MA 1/1/96
Place *Date*



Bill Burks
Regulatory Compliance Engineer

Galway, Ireland 1/1/96
Place *Date*



Gerard Rutten
Managing Director, Europe

Limited Warranty

American Power Conversion (APC) warrants its products to be free from defects in materials and workmanship for a period of two years from the date of purchase. Its obligation under this warranty is limited to repairing or replacing, at its own sole option, any such defective products. To obtain service under warranty you must obtain a Returned Material Authorization (RMA) number from APC or an APC service center. Products must be returned to APC or an APC service center with transportation charges prepaid and must be accompanied by a brief description of the problem encountered and proof of date and place of purchase. This warranty does not apply to equipment which has been damaged by accident, negligence, or mis-application or has been altered or modified in any way. This warranty applies only to the original purchaser who must have properly registered the product within 10 days of purchase.

EXCEPT AS PROVIDED HEREIN, AMERICAN POWER CONVERSION MAKES NO WARRANTIES, EXPRESS OR IMPLIED, INCLUDING WARRANTIES OF MERCHANTABILITY AND FITNESS FOR A PARTICULAR PURPOSE.

EXCEPT AS PROVIDED ABOVE, IN NO EVENT WILL APC BE LIABLE FOR DIRECT, INDIRECT, SPECIAL, INCIDENTAL, OR CONSEQUENTIAL DAMAGES ARISING OUT OF THE USE OF THIS PRODUCT, EVEN IF ADVISED OF THE POSSIBILITY OF SUCH DAMAGE. Specifically, APC is not liable for any costs, such as lost profits or revenue, loss of equipment, loss of use of equipment, loss of software, loss of data, costs of substitutes, claims by third parties, or otherwise. This warranty gives you specific legal rights and you may also have other rights which vary from state to state.

Toll free technical support:
Numéro vert de l'assistance technique:
Número de telefono sin costo para
apoyo técnico:

United States and Canada: 1-800-800-4272
Ireland: 1-800-702000
U.K. 0800-132990

Others/Autres/Otras:
+1 401 789 5733 (USA) or
+353 91 702020 (Ireland)

Return shipment addresses:
Adresse d'expédition des renvois:
Direcciones para devolver mercadería:

American Power Conversion Corporation
132 Fairgrounds Road
P.O. Box 278
West Kingston, Rhode Island 02892
USA

American Power Conversion Corporation
(A.P.C.) b.v.
Ballybritt Business Park
Galway
Ireland

Internet/WWW/E-Mail

Internet: <http://www.apcc.com>
E-Mail: apctech@apcc.com
Compuserve: GO APCSUPPORT

Note: *The troubleshooting chart in section 7.0 offers solutions for most of the difficulties you may encounter with this UPS. Before calling the customer service number, please have available your UPS's serial number (see the label at the rear of the UPS).*

Serial number: _____



AMERICAN POWER CONVERSION

The world's most reliable
power protection

Free Manuals Download Website

<http://myh66.com>

<http://usermanuals.us>

<http://www.somanuals.com>

<http://www.4manuals.cc>

<http://www.manual-lib.com>

<http://www.404manual.com>

<http://www.luxmanual.com>

<http://aubethermostatmanual.com>

Golf course search by state

<http://golfingnear.com>

Email search by domain

<http://emailbydomain.com>

Auto manuals search

<http://auto.somanuals.com>

TV manuals search

<http://tv.somanuals.com>