

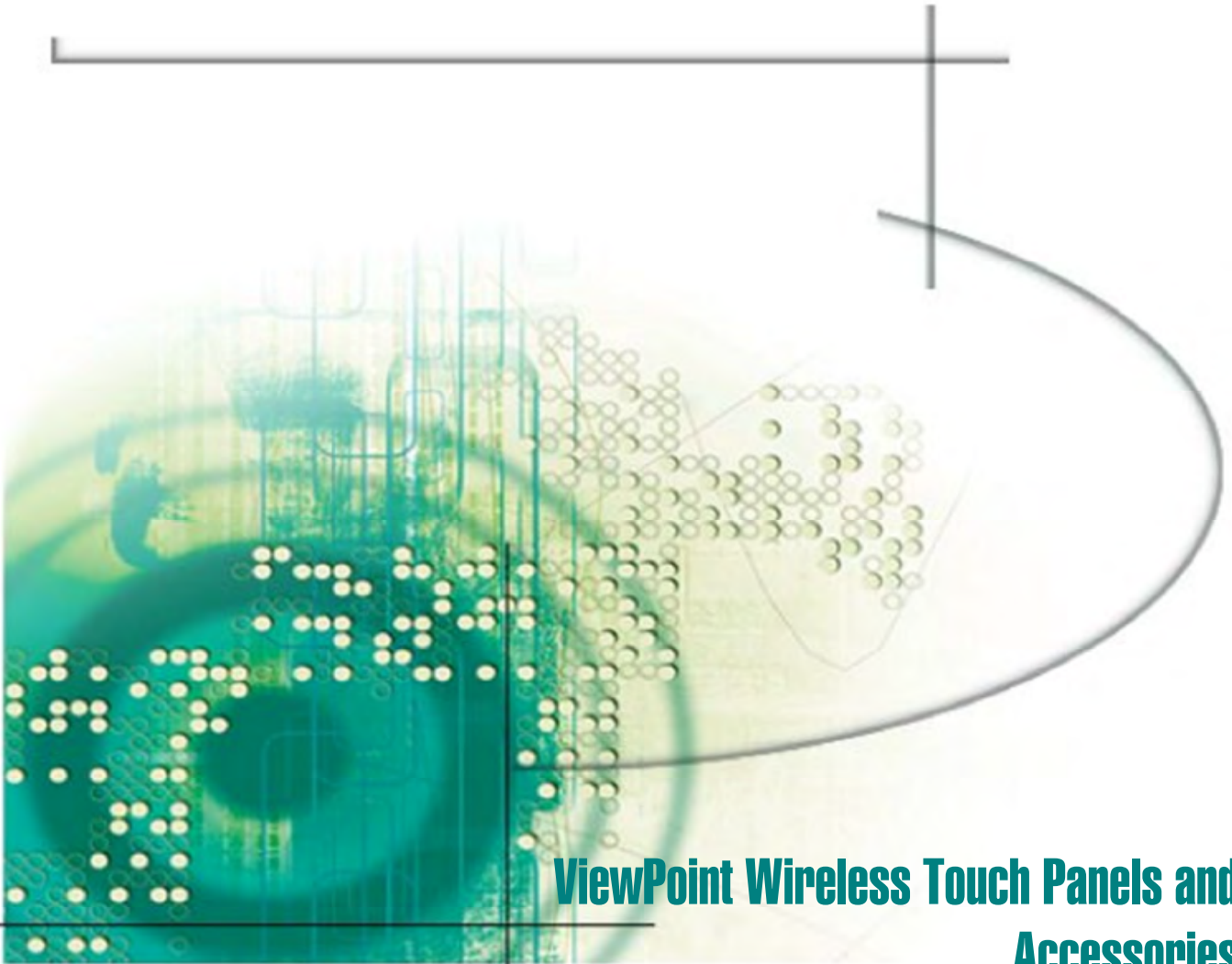

ViewPoint

Wireless Touch Panels (Wave Server)

Instruction Manual



**ViewPoint Wireless Touch Panels and
Accessories**



Limited Warranty and Disclaimer

AMX Inc. warrants its products to be free from defects in material and workmanship under normal use for a period of three years from date of purchase from AMX Inc., with the following exceptions. Electroluminescent and LCD control panels are warranted for a period of three years, except for the display and touch overlay components which are warranted for a period of one year. Disk drive mechanisms, pan/tilt heads, power supplies, modifications, MX Series products, and KC Series products are warranted for a period of one year. Unless otherwise specified, OEM and custom products are covered for a period of one year. AMX, Incorporated software products are warranted for a period of 90 days. Batteries and incandescent lamps are not covered.

This warranty extends to products purchased directly from AMX Incorporated or an authorized AMX Inc. dealer. Consumers should inquire from selling dealer as to the nature and extent of the dealer's warranty, if any.

AMX Inc. is not liable for any damages caused by its products or for the failure of its products to perform, including any lost profits, lost savings, incidental damages, or consequential damages. AMX Inc. is not liable for any claim made by a third party or made by you for a third party.

This limitation of liability applies whether damages are sought, or a claim is made, under this warranty or as a tort claim (including negligence and strict product liability), a contract claim, or any other claim. This limitation of liability cannot be waived or amended by any person. This limitation of liability will be effective even if AMX Inc. or an authorized representative of AMX Inc. has been advised of the possibility of any such damages. This limitation of liability, however, will not apply to claims for personal injury.

Some states do not allow a limitation of how long an implied warranty lasts. Some states do not allow the limitation or exclusion of incidental or consequential damages for consumer products. In such states, the limitation or exclusion of the Limited Warranty may not apply to you. This Limited Warranty gives you specific legal rights. You may also have other rights that may vary from state to state. You are advised to consult applicable state laws for full determination of your rights.

EXCEPT AS EXPRESSLY SET FORTH IN THIS WARRANTY, AMX INC. MAKES NO OTHER WARRANTIES, EXPRESS OR IMPLIED, INCLUDING ANY IMPLIED WARRANTIES OF MERCHANTABILITY OR FITNESS FOR A PARTICULAR PURPOSE. AMX Inc. EXPRESSLY DISCLAIMS ALL WARRANTIES NOT STATED IN THIS LIMITED WARRANTY. ANY IMPLIED WARRANTIES THAT MAY BE IMPOSED BY LAW ARE LIMITED TO THE TERMS OF THIS LIMITED WARRANTY.

Table of Contents

Introduction	1
Overview	1
ViewPoint Models	1
Features	2
Related Instruction Manuals	2
What's in this Manual	3
What's New	3
Connections, Cleaning, and Charging	5
Overview	5
Application	5
Connectors	6
Multiple ViewPoints in an Installation	6
Cleaning the Touch Overlay	7
ViewPoint Rechargeable Battery	7
Power Supply	8
VPA-CHG FastCycle Battery Charger for VPA-BP	8
ViewPort Docking Station	10
Battery Charging	11
Touch Panel Basics	13
Overview	13
Touch Panel Pages	14
Standard Buttons	14
General Buttons	14
Selection buttons	15
Information buttons	15
Adjustment buttons	15
Keypad buttons	15
Decision buttons	16
Status buttons	16
Operation bars	16
Touch to Continue buttons	17

Designing Touch Panel Pages.....	19
Overview	19
Activating the Edit button	19
Creating a Page	23
Adding a page	23
Setting the page color	24
Creating a Button	25
Adding a button	25
Resizing a button	26
Button Properties	27
Setting the button properties	27
Setting the button type	28
Setting the button border	28
Setting the channel code	29
Setting the variable text code	30
Setting the page flip	31
Setting the button colors for channel-off conditions	32
Adding text to a button	33
Adding an icon to a button	34
Adding a bitmap to a button	35
Using TPDesign3 to Download Bitmaps, Icons, and Fonts	37
Button Properties for External Pushbuttons	39
Creating an IR Macro Button	39
Pulse command	40
Wait command	41
What happens when the example macro executes	43
Creating a Joystick	44
Adding a joystick to a page	44
Setting the joystick properties	45
Setting the channel code	46
Setting the level code	47
Setting the joystick colors/shades for channel-off conditions	47
Creating a Bargraph	48
Adding a bargraph to a page	49
Setting the bargraph properties	50
Setting the channel code	50
Setting the level code	51

Setting the bargraph colors/shades for channel-off conditions	51
Linking the New Page to the Main Page	52
Exiting Edit Mode	55

Touch Panel Program Reference 59

Overview	59
Setup Page	59
Beep	60
Display timer	60
Set time and date	61
Double beep	62
AXlink, output resolution, vX.XX, and serial number	62
Setting brightness	62
Protected setup	63
Show palette	64
Wireless status (optional WAV-PK)	64
Wireless status (optional SMT-PK)	66
Wireless settings for VPT-CP and VPT-GS	67
Wireless Status for VPW-CP and VPW-GS	68
Wave-Pak not locked	69
Module version	69
Server version	69
RSSI	69
Network Eff.	69
Device Eff.	69
Device range	70
Server devices	70
Protected Setup Page	70
Baud	71
Device base	71
Device used	72
Setup password	72
Power up page	72
Wake up message	73
Auto assign	73
Page password	74
Calibrate	74
Power up message	74
System page	75

Editor	78
Page tracking	79
Sleep message	79
Function show	79
Wireless Settings for VPW-CP and VPW-GS	80
Wave-Pak not locked	81
RSSI	81
Network Eff.	81
Device Eff.	81
Device range	81
Server devices	81
Wireless settings (optional SMT-PKM)	81
Edit button	82
Edit Bar - Button Menu Options	84
Add	84
Copy image	85
Move	85
Resize	85
Delete	86
Text/image	86
Properties	90
Save	98
Paste	98
Save default	98
Set default	99
Put on top	99
Properties Page - Button Types	99
General	100
Joystick	104
Vertical Bargraph	106
Horizontal Bargraph	107
Brightness	109
Time	111
Date	112
Keypad	113
Keyboard	114
Setup	114
Video Setup	115
Video Window	116
Video Joystick	116

RGB Setup	118
Protected	119
Properties Page - External Buttons	120
External buttons	121
Setting external button properties	123
Page Menu Options	124
Add	124
Copy	125
Rename	126
Delete	126
Page color	126
Go to	127
Popup on	127
Popup off	128
Move edit	129
Snap grid	129
Edit Bar - Quit Editor option	130

AXCESS Programming 133

Overview	133
PC to ViewPoint Connections	133
Programming the ViewPoint	134
AXCESS Programming Changes	134
System Send_Commands	135
Gray Scale and Programming Numbers	141
Colors/Shades of Gray and Programming Numbers	142
Font Styles and Programming Numbers	142
Border Styles and Programming Numbers	142
Shorthand Send Commands	143
Color/Gray Scale Send_Commands	148
Variable Text Send Commands	151
Shorthand Variable Text Commands	153
Buttons String Commands	157
Button Macro Commands	158

Loading Infrared (IR) Files 161

Overview	161
IRLIBX	161
Loading an IR File	163
IR Memory Check	167

Upgrading the Firmware	169
Overview	169
Configuration	170
Downloading the Firmware	170
Specifications	173
Overview	173
VPA-BP ViewPoint Rechargeable Battery	175
VPA-CHG Fast-Cycle Battery Charger for VPA-BP	176
ViewPort Docking Station	177
Contacting Sales and Technical Support.....	179
Overview	179
U.S. Sales and Technical Support Teams	179
AMX International Offices	180
Technical Support	180
Index.....	183

Introduction

Overview

The ViewPoint Wireless Touch Panels and ViewPoint WAVE Touch Panels are handheld, liquid crystal display (LCD) panels that allow you to control devices remotely. Figure 1 shows some of the available ViewPoints.

Figure 1

ViewPoint touch panels



ViewPoint Models

There are four models of the ViewPoint touch panels:

- ViewPoint Color Wireless Touch Panel - (VPT-CP)
- ViewPoint Grayscale Wireless Touch Panel - (VPT-GS)
- ViewPoint Color WAVE Touch Panel - (VPW-CP)
- ViewPoint Grayscale WAVE Touch Panel - (VPW-GS)

The VPT panels are one-way infrared (IR) and radio frequency (RF) only. The VPW panels are two-way digital Spread Spectrum RF and one-way IR.

Features

The other features of the ViewPoint touch panels are:

- All panels have 6-inch diagonal (153.9 mm), 320 x 240 (HV) pixel screens
- VPW-CP has a 256 color passive-matrix LCD screen
- VPW-GS has a 16-shade grayscale LCD screen
- Four external programmable push buttons
- Programmable firmware via programming port connection
- Programming port for uploading/downloading touch panel data
- Panel programming, pages, and drawings are uploaded and downloaded using TPDesign (Windows[®]) 16-bit or TPDesign3 (Windows) 32-bit touch panel design programs
- One-way RF or IR transmission (VPT-CP/VPT-GS only)
- Two-way digital spread spectrum RF (VPW-CP/VPW-GS only)
- Onboard battery-charging circuitry
- Unicode[®] character support for far-eastern languages such as Chinese
- Hand-held or desktop usage
- Battery life of 6 continuous hours with full back-lighting (VPT-CP/VPT-GS)
- Battery life of 4 continuous hours (VPW-CP/VPW-GS)

Note

TPDesign3 is used to convert G2 or lower panel pages into G3 firmware compatible pages.

Note

Characters for Middle Eastern languages such as Arabic are *not* supported within the Unicode fonts because they are bi-directional. Buttons with Unicode fonts can only be created and edited using TPDesign3 Touch Panel Design Program.

Related Instruction Manuals

These instruction manuals contain additional information that relates to the Color Passive-Matrix mini-touch panels.

- [TPDesign3 Touch Panel Program](#)
- [WAVE 2-Way Wireless Accessories and Adapters for Touch Panels](#)
- [AXCESS Programming Language](#)
- [OpenAXCESS Configuration and Diagnostic Program](#)
- [Color Passive-Matrix LCD Mini-Touch Panels \(Firmware version G3 or higher\)](#)
- [Color Passive-Matrix LCD Touch Panel \(Firmware version G3 or higher\)](#)

- [PowerTilt and PowerTouch Panels \(Firmware version G3 or higher\)](#)

What's in this Manual

This manual contains the following sections:

- **Installation** Contains cabling, connections, and connectors as well as cleaning of the touch panel overlay, power supply, and battery information.
- **Touch Panel Basics** Contains descriptions and illustration examples of touch panel pages.
- **Touch Panel Program Reference** Describes touch panel operations, flowcharts, and button options.
- **Designing a Touch Panel Page** Contains step-by-step instructions to create a touch panel page, button, joystick, bargraph, and set a page color/shade.
- **Firmware Upgrade** Explains how to connect the ViewPoint to your PC for ViewPoint firmware upgrade using SOFTROM.
- **Specifications** Describes the physical and operating characteristics of the touch panels.
- **Contacting Sales and Technical Support** Identifies contact information for technical support and technical publications, including phone numbers, e-mail addresses, and Internet locations.

What's New

Additions and revisions to this release of the manual include:

- Added ViewPort Docking Station and instructions for creating an IR macro button
- Added and updated graphics

Revisions are identified with vertical margin bars on the outside margin, as shown adjacent to this paragraph

Connectors

All ViewPoints have two connectors, as shown in Figure 3. The power jack is for connecting an external 12 VDC power supply for ViewPoint operation and charging. The programming jack is a three-wire, 2.5 mm stereo jack. The required cable and power supply comes furnished with the ViewPoint.

Figure 3

ViewPoint connectors



Multiple ViewPoints in an Installation

Note

RF operating frequencies *cannot* be user-adjusted. Operating frequencies must be factory-set.

The ViewPoint transmits data via RF or IR. The VPT-CP and VPT-GS ViewPoint Wireless Touch Panels are shipped to operate on a standard frequency of 418 MHz RF and user-selectable 38 KHz or 455 KHz IR frequencies. The ViewPoints can be ordered for different RF operating frequencies that must be set when the unit is manufactured.

Note

The 2-way ViewPoints do not support AMX IR codes (38 KHz and 455 KHz) but do support other manufacturers IR codes. The 1-way ViewPoints support all IR codes.

The VPW-CP/VPW-GS operates on 2.4 GHz for two-way RF communications with the AXR-WAVES Server. It also provides one-way IR using other manufacturers IR codes.

If you plan to use multiple one-way ViewPoints within the same locals, it is strongly recommended that each unit be ordered for operation on different RF frequencies. This will prevent erroneous data being received by the respective AXCESS Central Controller.

Cleaning the Touch Overlay

You should clean the touch screen overlay after each day's use. Materials required are:

- Two clean, soft texture cotton cloths
 - Spray bottle of cleaning solution consisting of 50% isopropyl alcohol and 50% water.
1. Turn the ViewPoint off.
 2. Spray a small amount of the cleaning solution onto one of the cloths.
 3. Clean the touch panel overlay with the damp cloth.
 4. Wipe the touch panel overlay with the dry cloth.

ViewPoint Rechargeable Battery

The ViewPoint requires use of a VPA-BP ViewPoint Rechargeable Battery. Figure 4 shows the VPA-BP and placement in the ViewPoint.

Figure 4

VPA-BP ViewPoint
Rechargeable Battery
placement

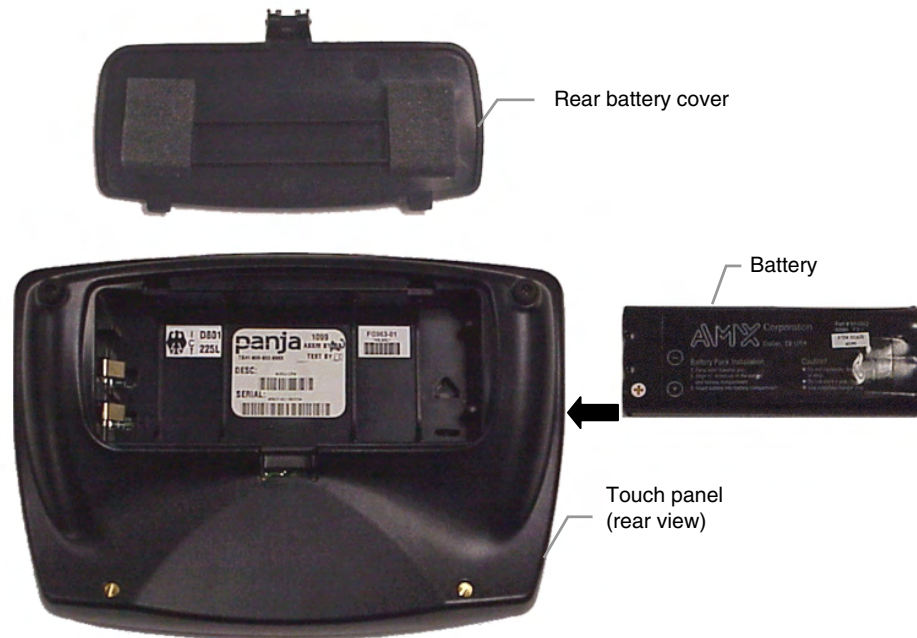

Power Supply

Note

A 220 VAC power supply is also available.

ViewPoints are furnished with a modular wart type Power Supply (Figure 5), which requires an input of 110 VAC and provides an output of 12 VDC at 1500 mA. The power supply can be used separately from the VPA-CHG to operate the ViewPoint.

VPA-CHG FastCycle Battery Charger for VPA-BP

The VPA-CHG FastCycle Battery Charger for VPA-BP includes a Power Supply as shown in Figure 5. The power supply can be used for primary power or charging of the VPA-BP ViewPoint Rechargeable Battery. The power supply barrel connector plugs into the side of the ViewPoint.

When charging the VPA-BP, if the battery is inserted incorrectly (backward) into the charger, a buzzer will sound. While the battery is charging, the red LED lights. When the battery is fully charged, the green LED lights. If there is no battery in the charger, neither of the LEDs light up.

Figure 5

VPA-CHG (power supply and
VPT-CP Fast-Cycle Battery
Charger for VPA-BP)



ViewPort Docking Station

The ViewPort Docking Station (Figure 6) provides a built-in battery charger and an angled desk docking station to cradle your ViewPoint touch panel. When a ViewPoint is placed in the docking station's cradle, the ViewPoint makes contact with the charging pins and the docking station then supplies power.

When a touch panel is not cradled on the docking station, a battery can be charged when placed within the charging compartment. When a touch panel is cradled on the docking station, all power is fed to the touch panel. A battery that was charging will no longer be supplied with power until the ViewPoint is removed from the docking station's cradle.

Figure 6

ViewPort Docking Station



Battery Charging

Note

When inserting or removing a battery, insert or remove the battery slowly to avoid false indications on the LEDs.

When a ViewPoint touch panel is not cradled on the docking station, an optional extra battery can be placed in the charging compartment. The optional battery is fully charged in four hours when the optional power supply is plugged-in to the rear of the docking station (Figure 7). The ViewPort Docking Station provides trickle-charging of the battery inside the ViewPoint when the ViewPoint is cradled in the ViewPort.

Figure 7

Rear view



Status LEDs (Figure 6) are located on the bottom front of the docking station. There are three LEDs; yellow indicates a ViewPoint connection to the docking station; red shows a battery being charged in the charging compartment; green indicates that the battery in the charging compartment is fully charged.

Touch Panel Basics

Note

Refer to the *TPDesign3 Instruction Manual* for detailed Touch Panel design information or to the *ViewPoint VPXpress System Design/Programming Software Instruction Manual*

Overview

This section contains descriptions and illustration examples of Touch panel pages (Figure 8), buttons, message bars, and keypads. You can use the TPDesign3 software program to create custom pages and download them to the touch panel. Or you can use the ViewPoint VPXpress System Design/Programming Software.

Figure 8

Sample touch panel page



TPDesign3 page example



VPXpress page example

Touch Panel Pages

You can download objects like buttons and drawings to a touch panel page. The number of objects depends on the type and quantity of external devices you want to control with the touch panel and ACCESS Control System. When you create multiple pages, you must link them with buttons. Figure 9 shows how five touch panel pages are linked to the Main page. Note that each page contains one button that goes to the next page, and one that goes to the previous page.

Figure 9

Touch Panel pages with linked buttons

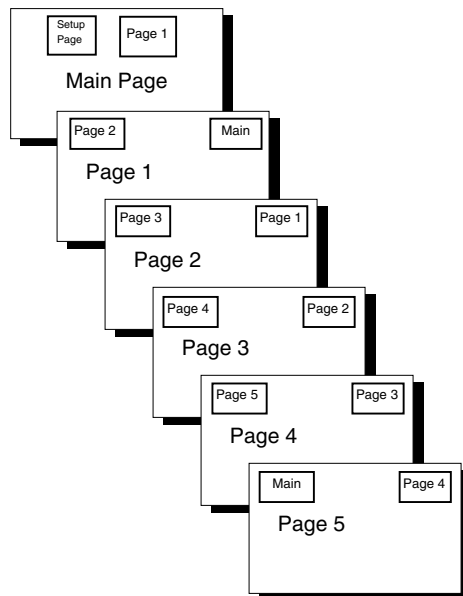

Standard Buttons

Standard buttons types are rectangles, rectangle variations, and other geometric shapes that you can create with the touch panel editor. Buttons are set with attributes, which means there is feedback for the Central Controller when you touch the button.

General Buttons

General buttons are part of the mini-touch panel program and cannot be changed. You use general buttons to specify panel communication parameters and create or revise pages. Button examples include selection buttons, information buttons, adjustment buttons, and operation bars. Each type of General button is described in the following paragraphs.

Selection buttons

Selection buttons (Figure 10) appear on touch panel pages and set communication parameters.

Figure 10

Selection button example



Note

These button types will be displayed in black and yellow to indicate that they are only for information and can't be changed.

Information buttons

Information buttons contain serial numbers and firmware version information. The properties of these buttons cannot be changed. Figure 11 shows the serial number information button in the Setup page.

Figure 11

Information button example



Adjustment buttons

You can use the UP and DN buttons to set adjustment buttons. The adjustment button example in Figure 12 sets the baud rate for the RS-232 connector on the touch panel.

Figure 12

Adjustment button example

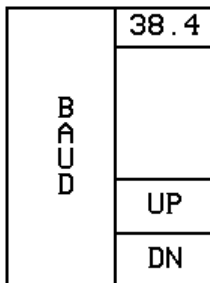

Keypad buttons

The keypad button opens a keypad (Figure 13) so you can enter a password or value assignment. All keypad buttons are interactive except for the entry display.

Figure 13

Keypad example

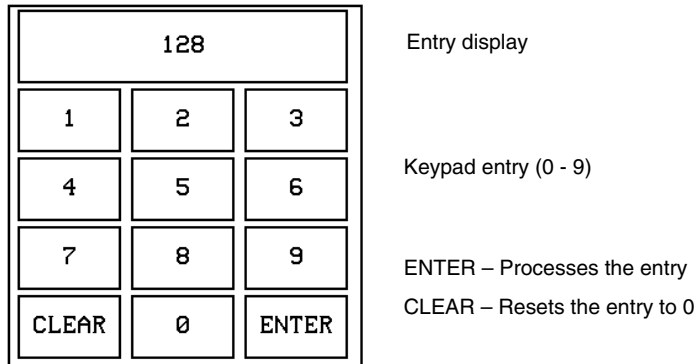

Decision buttons

Decision buttons (Figure 14) appear when an operation has two options and requires you to verify the action before it is performed.

Figure 14

Decision button example

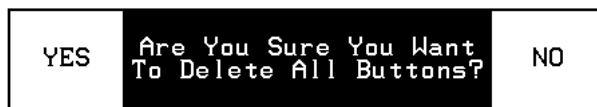

Decision buttons appear when you exit the Editor bar, send or receive a drawing, designate a communication protocol, or make an operation error.

Status buttons

Status buttons (Figure 15) appear when you try to perform operations that do not function correctly.

Figure 15

Status button example

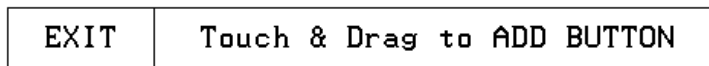

Operation bars

Operation bars (Figure 16) appear in the place of the Editor bar when you have selected a button or page edit operation. The operation bar indicates which edit function is currently active. When an edit operation is selected, it remains active until you press EXIT on the operation bar.

Figure 16

Operation bar example



Touch to Continue buttons

Touch to Continue buttons (Figure 17) appear when an operation requires user acknowledgement. An example of an operation that requires user acknowledgement is resetting the factory defaults.

Figure 17

Touch to Continue button
example

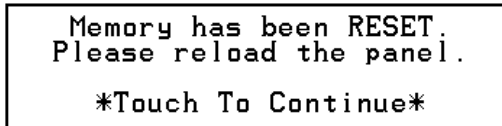

Designing Touch Panel Pages

Note

Information within this section applies to all ViewPoint models except as noted.

Overview

These step-by-step instructions describe creating touch panel pages, buttons, joysticks, bargraphs, and setting page color attributes. For in-depth information on all the operations available on the touch panel, read through the *Touch Panel Program Reference* section to learn about all the operations and techniques you can use to design touch panel pages.

The VPT-CP and VPT-GS ViewPoint one-way models do not support bargraphs, joysticks, VGA, or Video. These functions are available on the EDIT dropdown menus and can be setup. However, the functions are not operational.

The VPW-CP and VPW-GS are two-way RF and supports bargraphs and joysticks.

Activating the Edit button

Before designing a touch panel page, activate the EDIT button that contains options to add and configure touch panels and buttons. When powering up the mini-touch panel, the first page is the Main page shown in Figure 18. Refer to *Edit button* and *Go to* information in *Touch Panel Program Reference* if the Main page does not appear.

Note

If you have a pre-programmed panel, you may not see the Main page.

Figure 18

Main page

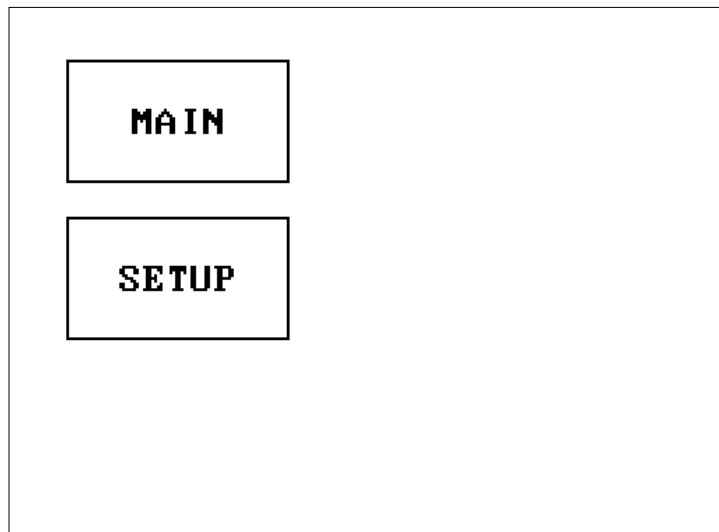

1. Press SETUP in the Main page to open the Setup page shown in Figure 19.

Figure 19

Setup page

Note

Viewpoint touch panel information buttons are displayed with a black fill. These buttons can't be altered and are only used to display information. Examples of these are the AXlink, WIRELESS STATUS, OUTPUT RESOLUTION, vX.XX, and SERIAL # buttons.

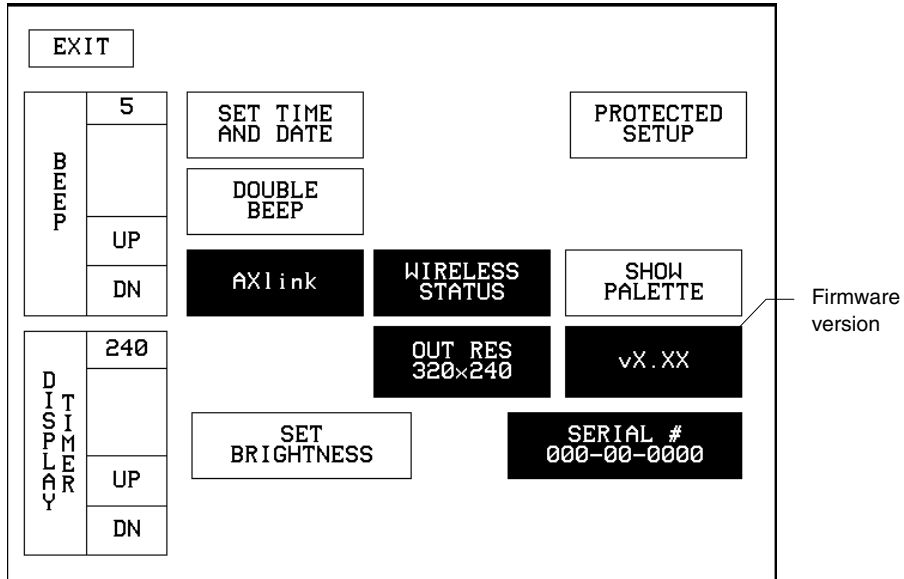

2. Press PROTECTED SETUP to open the password keypad shown in Figure 20.

Figure 20

Setup page and password keypad

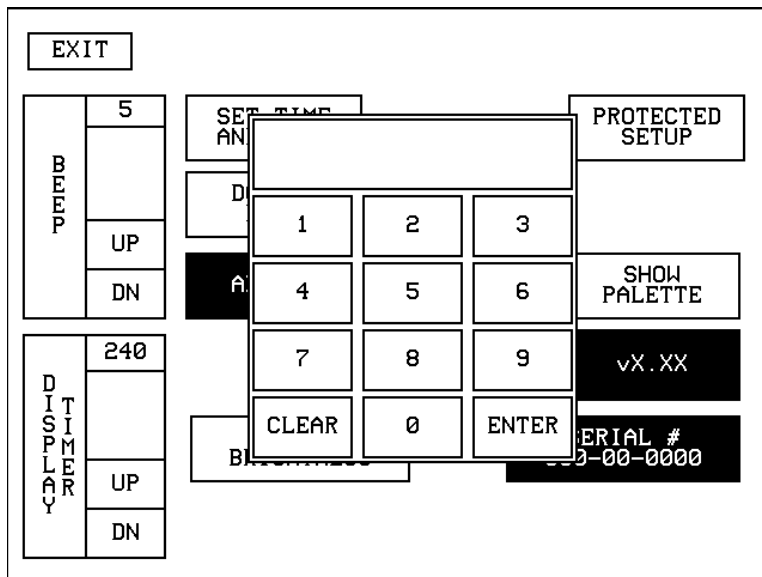

Note

If you press ENTER after typing in an incorrect password, you are immediately returned to the current page.

Figure 21

Protected Setup page with the active EDITOR button

3. Enter **1988** in the keypad and press ENTER to open Protected Setup page (Figure 21). For information on changing the password, refer to *Touch Panel Program Reference* section. If you enter a wrong number, press CLEAR and re-enter the number.

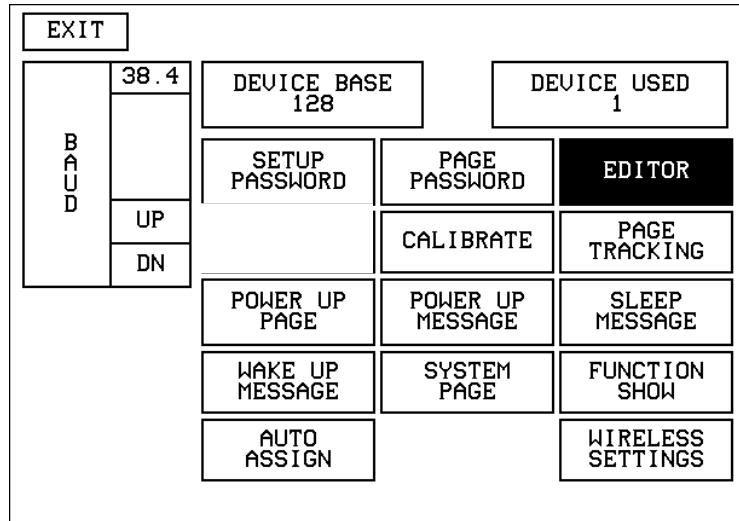

4. Press EDITOR to enable the Edit mode. The EDITOR button is highlighted when enabled (Figure 21).
5. Press EXIT to close the Protected Setup page and return to the Setup page in Edit mode.
6. Press EXIT again to return to the Main page. The EDIT button appears at the top of the Main page indicating that Edit mode is active (Figure 22).

Figure 22

Main page with EDIT button

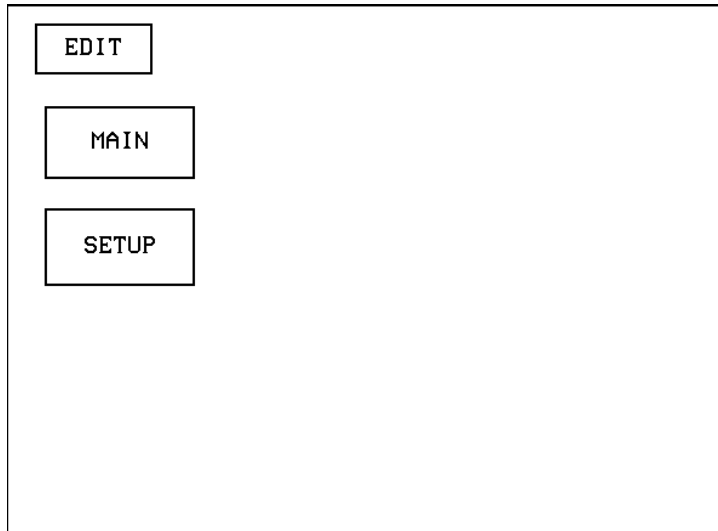

7. Press EDIT to open the Edit bar. BUTTON and PAGE in the Edit bar (Figure 23) are used to design and modify button and page settings.

Figure 23

Main page and Edit bar

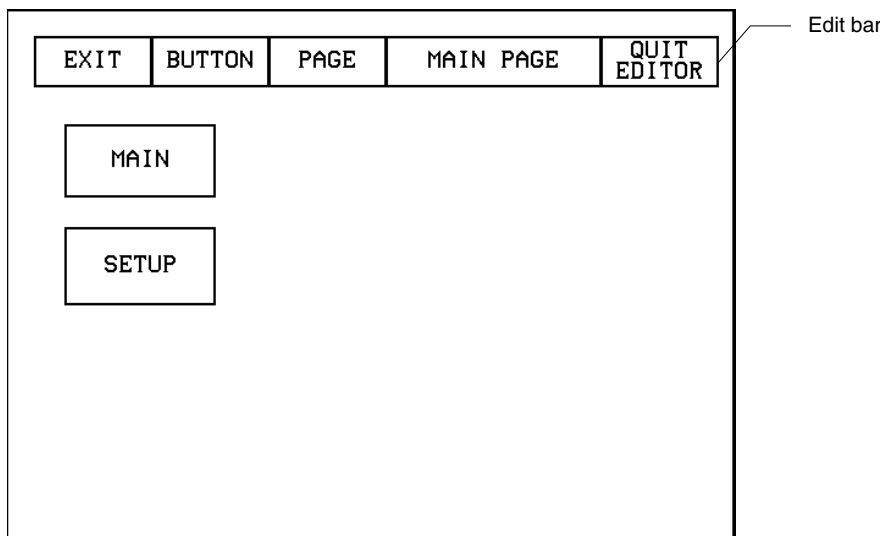

Creating a Page

Use the PAGE menu in the Edit bar to create touch panel pages.

Adding a page

1. Press PAGE on the Edit bar to open the PAGE menu shown in Figure 24.

Figure 24

PAGE menu

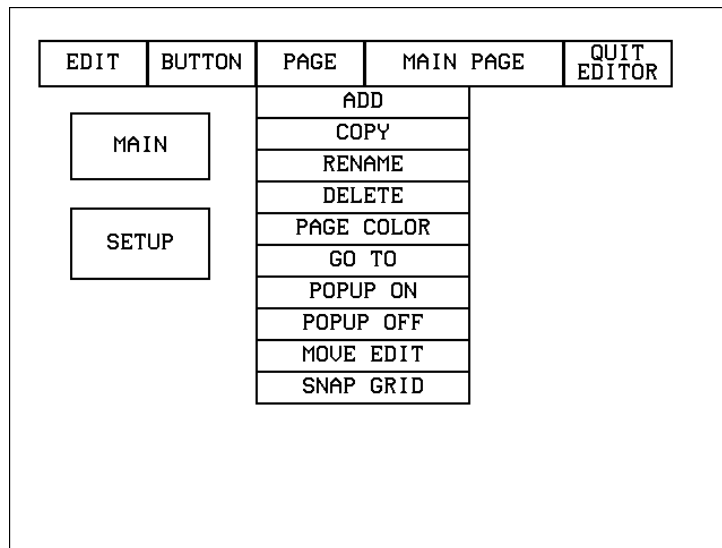

2. ADD to open the keyboard.
3. Enter *NEW PAGE* (Figure 25) using the keyboard. Page names can be up to 20 characters.

Figure 25

Keyboard

Note

Page naming does not allow you to change the font type, as is only available for buttons.

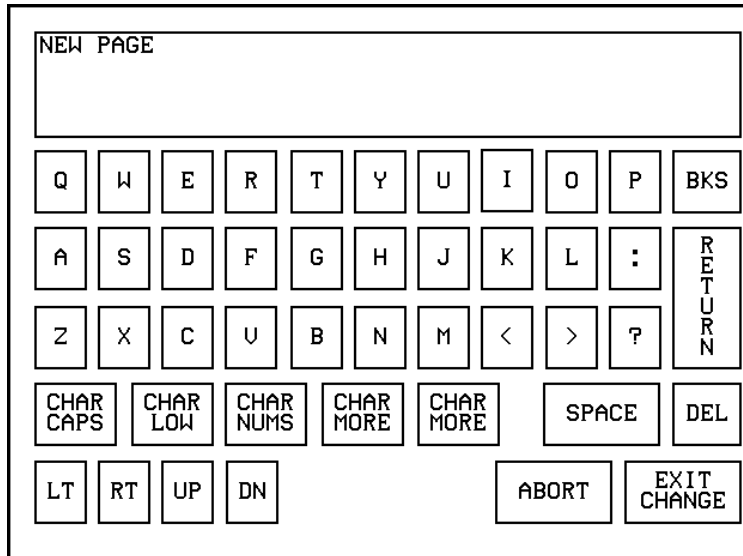

4. Press EXIT CHANGE to add **NEW PAGE** to touch panel memory, close the keyboard, and return to the new page.

Setting the page color

1. Press the EDIT button to open the Edit bar on the newly created page.
2. Press PAGE on the Edit bar to open the PAGE menu.
3. Press PAGE COLOR to open the color palette shown in Figure 26.

Figure 26

Color palette

Note

The VPT-GS will display gray scale options.

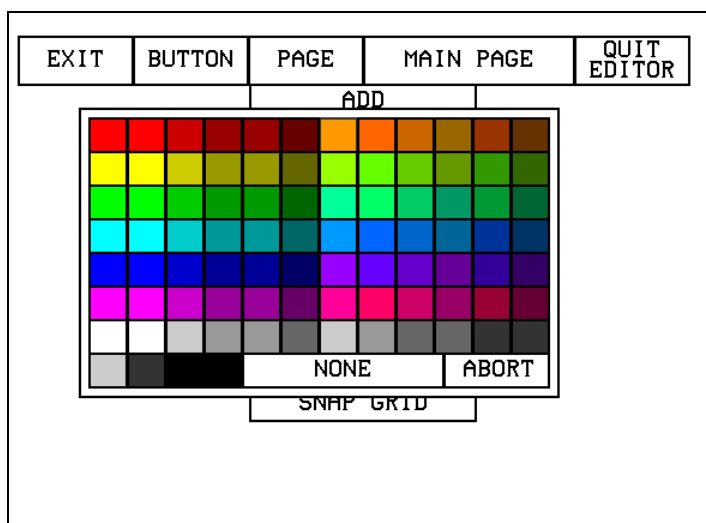

4. Select a page color from the palette. The page automatically changes to the new color.

Creating a Button

Use the BUTTON menu in the Edit bar to create touch panel buttons.

Adding a button

1. Press EDIT to open the Edit bar.
2. Press BUTTON on the Edit bar to open the BUTTON menu shown in Figure 27.

Figure 27

BUTTON menu

EXIT	BUTTON	PAGE	NEW PAGE	QUIT EDITOR
	ADD			
	COPY IMAGE			
	MOVE			
	RESIZE			
	DELETE			
	TEXT/IMAGE			
	PROPERTIES			
	SAVE			
	PASTE			
	SAVE DEFAULT			
	SET DEFAULT			
	PUT ON TOP			

3. Press ADD to open the ADD BUTTON operation bar (Figure 28).

Figure 28

ADD BUTTON operation bar

EXIT	Touch & Drag to ADD BUTTON
------	----------------------------

4. Touch and drag your finger horizontally down the LCD screen to create the button as shown in Figure 29. The first touch point is the upper-left corner of the button.

Figure 29

Add a button example

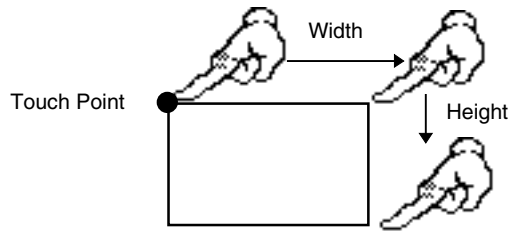

5. Release your finger from the panel to store the button dimensions into panel memory.
6. Press EXIT to close the Edit bar.

Resizing a button

1. Press EDIT to open the Edit bar.
2. Press BUTTON on the Edit bar to open the BUTTON menu.
3. Press RESIZE to open the RESIZE BUTTON operation bar (Figure 30).

Figure 30

RESIZE BUTTON operation bar

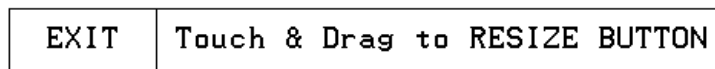

4. Push the edge of the button, and drag your finger horizontally across the screen and down to resize the button (Figure 31).

Figure 31

Resizing a button

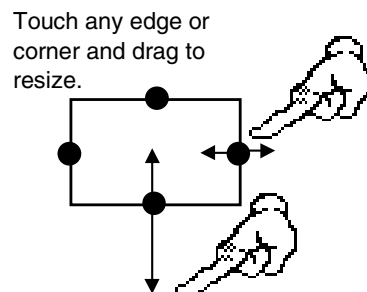

5. Release your finger from the panel to store the button dimensions into the panel memory.
6. Press EXIT in the Edit bar to exit Resize mode.

Note

One-way ViewPoints do not support bargraphs, sliders, joysticks, VGA, or video.

Note

The same steps apply to setting properties for external buttons.

Button Properties

Use the PROPERTIES option of the BUTTON menu in the Edit bar to set button borders, page flips, button colors for channel on and off conditions, and channel and variable text codes.

Setting the button properties

1. Press EDIT to open the Edit.
2. Press BUTTON on the Edit bar to open the BUTTON menu options.
3. Press PROPERTIES to open the PROPERTIES operation bar shown in Figure 32.

Figure 32

PROPERTIES message bar

EXIT	Touch for PROPERTIES
------	----------------------

4. Press the button you just added to open the Button Properties page shown in Figure 33. This page lists the properties for the active button.

Figure 33

Button Properties page

Note

The contents of the Button Properties page will change according to the type of button selected. The example shown here is for a GENERAL type button.

BORDER	CHANNEL		VAR TEXT		
	DEV: 1		DEV: 1		
	CHAN: 0		CHAN: 0		
BUTTON TYPE: GENERAL					
BUTTON OPTIONS: NONE					
FLIP STANDARD			NONE		
STRING:					
CHANNEL OFF		COLOR		CHANNEL ON	
BORDER	FILL	TEXT	BORDER	FILL	TEXT
EXIT SAVE CHANGE			EXIT NO CHANGE		

Setting the button type

1. Press **BUTTON TYPE** in the Button Properties page. This opens the **BUTTON TYPE** menu, shown in Figure 34. Press **MORE** at the bottom of the first page of Button Types options to view the next page of options. Press **PREV** to view the first page.

Figure 34

Button Types menu

BUTTON TYPE	**BUTTON TYPE**
GENERAL	TIME
JOYSTICK	DATE
VERTICAL BARGRAPH	KEYPAD
HORIZONTAL BARGRAPH	KEYBOARD
BRIGHTNESS	SETUP
TIME	VIDEO SETUP
DATE	VIDEO WINDOW
KEYPAD	VIDEO JOYSTICK
KEYBOARD	RGB SETUP
SETUP	PROTECTED
MORE	PREV
ABORT	ABORT

2. Select a button type for the selected button to open the associated Button Properties page for the selected button type. Each button type has its own Button Properties page with settings specific to the button type. For example, select **GENERAL** from the menu to set the selected button as a general button. This opens the **GENERAL** Button Properties page, shown in Figure 33.

Setting the button border

1. Press **BORDER** in the Button Properties page to open the **BUTTON BORDER** pages shown in Figure 35. These menu pages appear individually and can all be viewed by using the **MORE** and **PREV** buttons.

Figure 35

BUTTON BORDER menu pages

BUTTON BORDER	**BUTTON BORDER**	**BUTTON BORDER**
NO BORDER	DOUBLE LINE 2	3D RECTANGLE 1
NO BORDER SPECIAL	DOUBLE LINE 3	3D RECTANGLE 2
SINGLE LINE	DOUBLE SHADOW	3D ROUND 1
DOUBLE LINE	3D RECTANGLE 1	3D ROUND 2
TRIPLE LINE	3D RECTANGLE 2	3D NEON 1
SINGLE ROUNDED	3D ROUND 1	3D NEON 2
DOUBLE ROUNDED	3D ROUND 2	3D NEON BLUE
SINGLE RAISED	3D NEON 1	3D NEON GREEN
DOUBLE RAISED	3D NEON 2	SINGLE DIAMOND
TRIPLE RAISED	3D NEON BLUE	DOUBLE DIAMOND
MORE	MORE PREV ABORT	PREV ABORT

2. Press 3D RECTANGLE 1 to set the button border to 3D RECTANGLE 1 style and return to the Button Properties page. The BORDER button in the Button Properties page changes to show the active border type. In this case, the button changes to the 3D-rectangle border.

Note

If DEVICE USED is set to 4 and Base Device Number is 128, the Central Controller recognizes bus devices 128, 129, 130, and 131.

Figure 36

CHANNEL code buttons

Setting the channel code

The channel buttons that set the device and button channel codes for the touch panels are shown in Figure 36. Refer to Figure 143 for more information on DEV and CHAN.

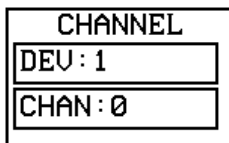

Note

The panel will not allow you to enter a device number greater than the DEVICE USED without first displaying a decision box. This box asks you to decide whether you accept the new selection or default to the previous value.

1. Press DEV to open the keypad and set the touch panel's device number.
2. Enter 1, 2, 3, or 4 in the keypad. The ACCESS software program uses device codes 1 through 4 to identify the touch panel. Refer to the *Touch Panel Program Reference* section for detailed information.
 - a. For 1-way ViewPoints, use device number 1 for AMX IR and RF. Use device numbers 2, 3, and 4 for other manufacturer's IR codes.

Note

If DEVICE USED is set to 4 and Base Device Number is 128, the Central Controller recognizes bus devices 128, 129, 130, and 131.

Note

The channel code for non-active buttons is 0 and for active buttons is 1 through 255.

Note

One-way ViewPoint touch panels do not support variable text.

Figure 37

VAR TEXT code button

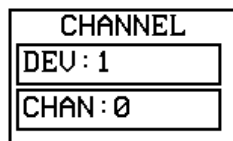

Note

The panel will not allow you to enter a device number greater than the DEVICE USED without first displaying a decision box. This box asks you to decide whether you accept the new selection or default to the previous value.

Note

The channel codes for non-active buttons is 0, and active buttons is 1 through 255.

b. For 2-way ViewPoints, AMX IR is not supported (38 KHz and 455 KHz) but other manufacturer's IR codes are supported by assigning ViewPoint device numbers 2, 3, and 4 for IR codes.

3. Press ENTER to store the device number into memory, close the keypad, and return to the Button Properties page.
4. Press CHAN to open a keypad and enter a channel value of 1 through 255 in the keypad. The AXCESS software program uses the channel code number to identify the button and its' programmed operations.
5. Enter 1 through 255 in the keypad. The AXCESS software program uses the channel code number to identify the button and its operations.
6. Press ENTER to store the channel number in memory, close the keypad, and return to the Button Properties page.

Setting the variable text code

The variable text buttons that set the device and button channel codes for the touch panels are shown in Figure 37.

1. Press DEV to open a keypad and set the device number.
2. Enter 1, 2, 3, or 4 in the keypad. The AXCESS software program uses device codes 1 through 4 to identify the touch panel. Refer to the *Touch Panel Program Reference* section in this manual for detailed information.
3. Press ENTER to store the device number in memory, close the keypad, and return to the Button Properties page.
4. Press CHAN to open a keypad and set the channel number.
5. Enter a channel value of 1 through 255 in the keypad. The AXCESS software program uses the channel code number to identify the button and its operations.
6. Press ENTER to store the channel number into memory, close the keypad, and return to the Button Properties page.

Setting the page flip

1. Press the left PAGE FLIP box in the Button Properties page (Figure 38) to open the Page Flip Type list (Figure 39).

Figure 38

Page FLIP boxes

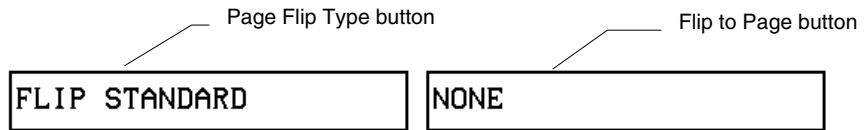

2. Press FLIP STANDARD to select a standard page flip.
3. Press the right PAGE FLIP box (Figure 38) to open the PAGE FLIP TYPE menu (Figure 39).

Figure 39

PAGE FLIP TYPE menu

Note

When selecting FLIP PREVIOUS in the Page FLIP type button, the PAGE menu appears.

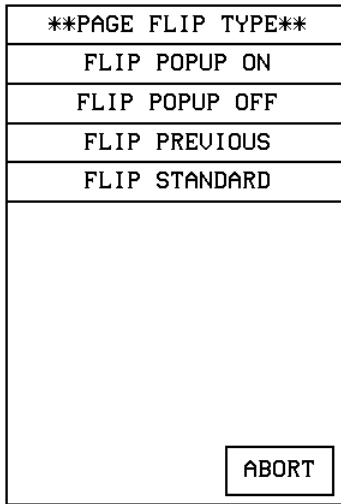

4. Press the right FLIP to Page to open a list of all the touch panel pages stored into memory. If the desired page is not present in the PAGE flip destination menu (Figure 40), check to verify that the page has been saved.

Figure 40

PAGE flip destination menu

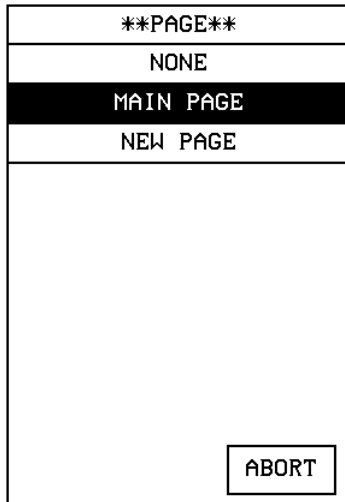

5. Press MAIN PAGE to set the page flip to the Main page.

Setting the button colors for channel-off conditions

1. Press the target button to open the Button Properties page
2. Press BORDER in the CHANNEL OFF subsection of the Button Properties page (Figure 41).

Figure 41

CHANNEL OFF/ON COLOR settings box

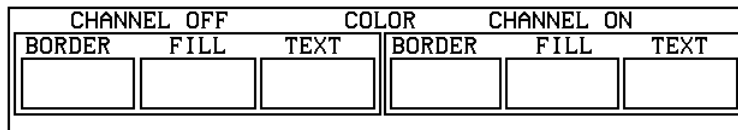

3. The color palette (Figure 42) appears.

Figure 42

Color palette

Note

The VPT-GS will display gray shades for selection.

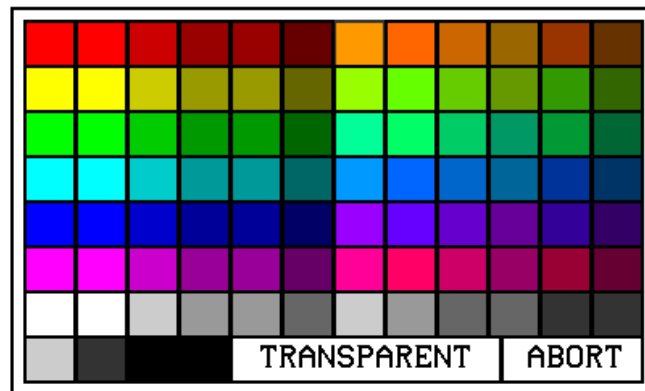

4. Press black to set the border color.
5. Press the FILL button in the Button Properties page to open the color palette.
6. Press white to set the fill color.
7. Press the TEXT button to open the palette
8. Press red to set the text color
9. Press EXIT SAVE CHANGE in the Button Properties page to store the new button properties into memory and return to the current page
10. Press EXIT on the PROPERTIES operation bar

Adding text to a button

Use the BUTTON option in the Edit bar to add text to buttons, joysticks, and bargraphs.

1. Press EDIT to open the Edit bar.
2. Press BUTTON on the Edit bar to open the BUTTON menu.
3. Press TEXT/IMAGE to add text into the button. The TEXT/IMAGE operation bar shown in (Figure 43) appears.

Figure 43

TEXT/IMAGE operation bar

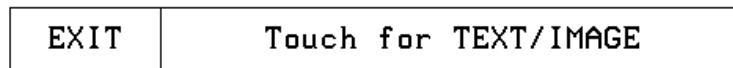

4. Press the target button to open the Text/Image page shown in Figure 44.

Figure 44

Text/Image page

TEXT OFF:

TEXT ON:

ICON OFF:

ICON ON:

BITMAP OFF:

BITMAP ON:

SET TEXT ALIGNMENT

MAKE ON SAME AS OFF

EXIT SAVE CHANGE

EXIT NO CHANGE

Note

The CHANGE FONT button only appears when changing the font of a function button and does not apply to popup pages.

Note

You can't create or edit buttons with Unicode fonts within the on-board editor. Any use of the TEXT/IMAGE button to alter or create Unicode font supported buttons must be done in TPDesign3 Touch Panel Design Program.

5. Press TEXT OFF to open the keyboard.
6. Enter **MAIN PAGE** in the keyboard. The text appears in the message box at the top of the keyboard. If you exceed the space in the button, the touch panel edits the message to fit in the space provided. Change the size of the button or reduce the font size to compensate.
7. Press EXIT CHANGE to close the keyboard and return to the Text/Image page
8. Press MAKE ON SAME AS OFF to set the text for both TEXT ON and TEXT OFF states of the button.
9. Press EXIT SAVE CHANGE to close the Text/Image page and return to the Main page.
10. Press EXIT in the Edit bar to exit Edit TEXT/IMAGE mode.

Adding an icon to a button

Use the BUTTON option in the Edit bar to add icons to buttons, joysticks, bargraphs, and video windows. Refer to

Using TPDesign3 to Download Bitmaps, Icons, and Fonts for more information on importing icons into your touch panel.

1. Press EDIT to open the Edit bar.
2. Press BUTTON on the Edit bar to open the BUTTON menu.
3. Press TEXT/IMAGE to add text to the button. The TEXT/IMAGE operation bar appears.
4. Press the target button to open the Text/Image page.
5. Press ICON OFF to set the icon for the OFF state of the selected button. This opens the ICONS menu (Figure 45), which contains a list of all the icons currently available to the project

Figure 45

ICONS menu example

ICONS	
NONE	
Cass	
CDP	
LDP	
UCR	
DSS (Blank)	
DUD (Blank)	
Tuner	
Phono	
DAT (Blank)	
MORE	ABORT

6. Select an icon from the menu. This sets the icon for the selected button's Off state
7. On the Text/Image page, press MAKE ON SAME AS OFF to set the icon for both On and Off states of the button.
8. Press EXIT SAVE CHANGE to set the button text and close the Text/Image page and return to the NEW page.
9. Press EXIT in the Edit bar to exit Edit Text/Image mode and close the Edit bar.

Adding a bitmap to a button

Use the BUTTON option in the Edit bar to add bitmaps to buttons, joysticks, bargraphs, and video windows. Refer to

Using TPDesign3 to Download Bitmaps, Icons, and Fonts

TPDesign3 allows you to import bitmaps, icons and fonts into your touch panel from an existing touch panel program. Use the Download to Panel command to download a project file.

To download bitmaps, icons and/or fonts from an existing TPDesign3 project file:

1. Launch the TPDesign3 software program and open a project file that contains the desired bitmaps, icons, and fonts.
2. Select File from the menu bar to open the File menu.
3. In the File menu, click on Download to Panel. This opens the Download to Panel-Comm Settings tab shown in Figure 47. Use this tab to set the communications port, baud rate, and other communication settings.

Figure 47

Download to Panel dialog box: Comm Settings tab

Note

The Comm Settings tab is the first tab in the Download To Panel dialog that opens.

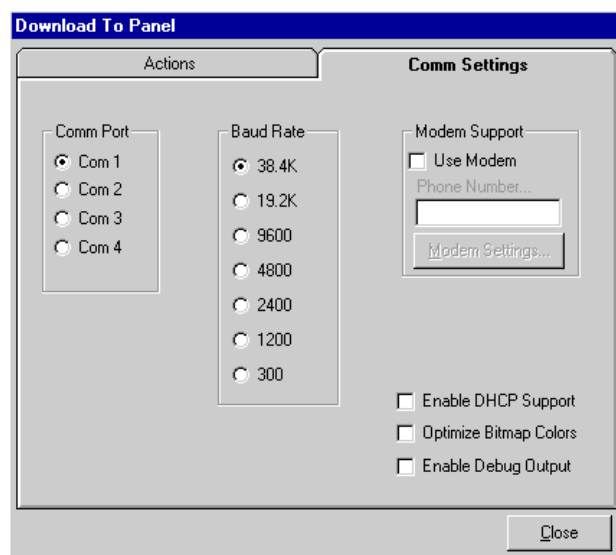

4. Use the Actions tab (Figure 48) to set the communication mode with the touch panel and to select which elements of the project file you want to download to the touch panel.

Figure 48

Sample Download To Panel dialog box: Actions tab

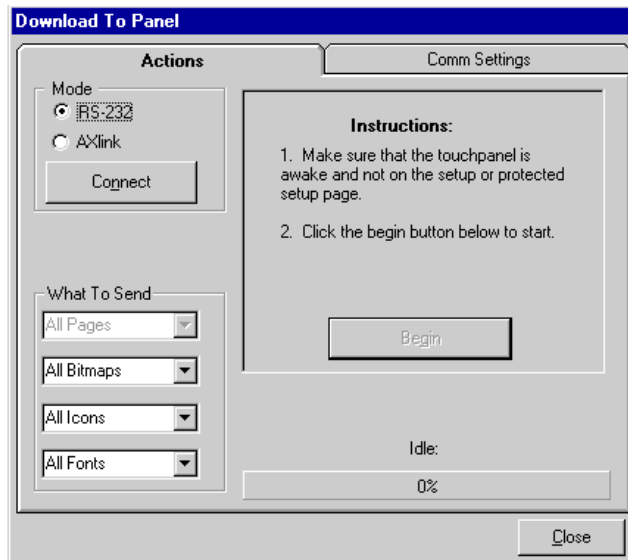

5. In the What To Send area, select one or more of the available options (Bitmaps, Icons, Fonts).
6. Select the mode of communication with the touch panel. After clicking on Connect, the AXlink window opens, as shown in Figure 49. The AXlink window displays the AXlink ID and Available Panels fields.
7. The AXlink ID field displays the selected AXlink address. The Available Panels field the device addresses that are available.
8. Once you have selected which elements to download, and set the communications mode and AXlink device settings, click Begin to begin downloading the project file into the touch panel. The bargraph at the bottom of the Download To Panel dialog box indicates the progress (in percent) of the download.

Figure 49

Sample Download To Panel dialog box with AXlink window

Note

Although these pushbuttons don't appear on-screen, their functionality can be set just as any other button on the touch panel. Refer to the *Button Properties* subsection for further information on the Properties' page features.

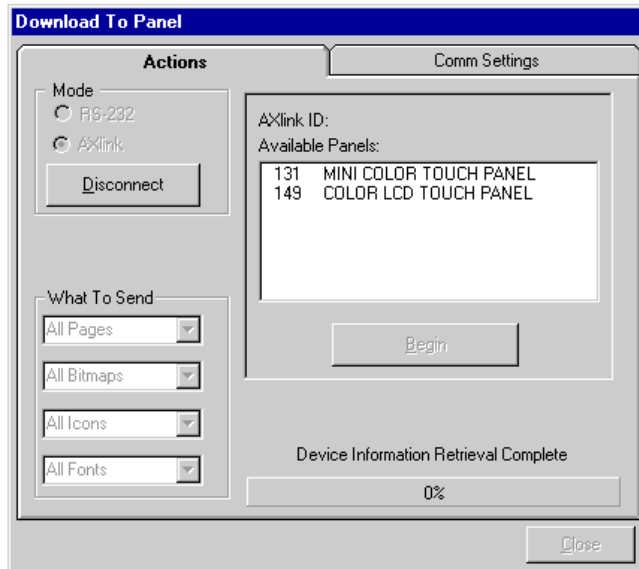

9. After completing the download, cut, copy and paste buttons as needed. The bitmaps, icons and fonts that were downloaded are now accessible via the BITMAPS, ICONS and FONTS menus.

Button Properties for External Pushbuttons

If your touch panel comes with external pushbuttons, these can be configured with features similar to on-screen buttons. Refer to *Creating a Button*, *Button Properties*, and *Properties Page – External Buttons* for detailed information. Use the PROPERTIES operation bar to assign properties to external pushbuttons. The BUTTON options and VARIABLE TEXT features within the Properties page will not appear. Although the Border and Color sections of this page appear, they are of no use to external pushbuttons since they do not appear on-screen.

Creating an IR Macro Button

Creating an IR macro button allows controlling multiple devices with a single touch panel button. You are only limited by touch panel IR memory (16 Kb). The following steps provide an example of creating an IR macro button controlling a television, VCR, and a satellite tuner. Syntax for a macro command is (refer to the *AXCESS Programming* section):

The IR macro button will perform the following processes when pushed.

- Turn On a Television and set the audio volume.

- Turn On a VCR and select TV.
- Turn On a satellite receiver.

Pulse command

Figure 50 shows a sample pulse command format and description of the variables.

Figure 50

Sample Pulse command format and variable description

- **Sample Format:** `$P <device number> <channel number> <time pulse on> <time delay after pulse><CR>`
- **Variables:**
 - <device number>*: This number represents an AXlink device that is associated with 255 channels. The device number must be 2, 3, or 4.
 - <channel number>*: This number represents one of 255 particular control functions associated with a device. The channel number must lie within the range of 1 and 255. For example, a button programmed on a touch panel with device 3, channel number 15 would be directly associated with the IR code programmed at device 3, channel 15. When that button is pressed, the touch panel transmits the IR code programmed at device 3, channel 15.
 - <time pulse on>*: This parameter represents the length of time that the pulse will remain on. This number is a time in tenths of seconds. For example, to keep the IR pulse on for 1 second, the required parameter is 10. The largest number for this parameter is 65535 or approximately 109 minutes.
 - <time delay after pulse>*: This parameter represents the length of time between pulses. This number is a time in tenths of seconds. For example, to add a delay between pulses for 10 seconds, the required parameter is 100. The largest number for this parameter is 65535 or approximately 109 minutes.
 - <CR>*: This character indicates the end of the statement (carriage return is pressing the RETURN key on the touch panel keyboard).
- **Example:** `$P 3 15 10 100<CR>`

This command will transmit the IR code at device 3, channel 15 for 1 second. Then, the macro will pause 10 seconds before executing the next command or before finishing the macro if no other commands exist.

Wait command

The wait command is used as a delay between pulses. This command should be used sparingly because the final parameter of the pulse command contains a delay between instructions. Usually, this command will be necessary for the case where a time delay is desired before starting any IR pulse sequences.

Figure 51 shows a sample pulse command format and description of the variables.

Figure 51

Sample Pulse command format and variable description

- **Sample**

Format: `$W <time delay before pulse><CR>`

- **Variables:**

<time delay

before pulse>:

This parameter represents the length of time between pulses. This number is a time in tenths of seconds. For example, to add a delay between pulses for 100 seconds, the required parameter is 1000. The largest number for this parameter is 65535 or approximately 109 minutes.

<CR>:

This character indicates the end of the statement (carriage return is pressing the RETURN key on the touch panel keyboard).

- **Example:** `$W 455<CR>`

This command will wait 45.5 seconds before executing the next macro command.

Before you create an IR macro button, make sure that you have your equipment IR files loaded into the ViewPoint. Refer to the section *Loading Infrared (IR) Files*. Load the IR files in the order of satellite IR first, VCR IR second, and TV IR file last. This loading order places the satellite file as ViewPoint device 4, the VCR as device 3, and the TV as device 2.

Figure 52 lists the IR code numbers for each device used in the following steps.

Figure 52

IR codes and functions

IR codes and functions			
IR code #	Television	VCR	Satellite
1-8			
9	Power		Power
10	0	Input select	0
11	1		1
12	2		2
13	3		3
14	4		4
15	5		5
16	6		6
17	7		7
18	8		8
19	9		9
21			Enter
22	Channel up ^		Channel up ^
23	Channel down v		Channel down v
24	Volume v	Main volume ^	Volume up ^
25	Volume ^	Main Volume	Volume down v
26	Mute	Rcvr mute	Mute
27		Main power on	
28		Main power off	
29	TV/Video	VCR1 tv/vcr	
30		TV	
31		VCR1	Sat
32		VCR2	
33		Id	
34		Tape	Audio
35		DCC	
36		CD	
37		Tuner am/fm	
38			
39		Aux	
45			Chan sel

1. Create a button and label it **Video Start**.
2. Select EDIT, BUTTON, PROPERTIES.
3. In the PROPERTIES dialog, select BUTTON TYPE, and then select GENERAL.
4. In the BUTTON OPTIONS field, select NONE.
5. In the CHANNEL dialog, set DEV to 1 and CHAN to 0.
6. In the STRING field enter the following using the keyboard:

Note

You must select the CHAR NUMS button on the Keyboard in order to enter the adjacent text. There is a space between the different sets of numbers and between the last number and the <CR>.

```
$P 2 9 5 1 <CR>
$P 2 24 5 1 <CR>
$P 3 27 5 1 <CR>
$P 4 9 5 1 <CR>
```

7. Press EXIT CHANGE, EXIT SAVE CHANGE, and then EXIT.

What happens when the example macro executes

Using the example in step 6, the following occurs when the macro is executed.

- **\$P 2 9 5 1** An IR push is sent to device 2 (TV) on channel 9 (Power on) for a period of 5 tenths of a second and a one tenth of a second pause. The <CR> indicates an end to the command string.
- **\$P 2 24 5 1** An IR push is sent to device 2 (TV) on channel 24 (increase volume) for a period of 5 tenths of a second and a one tenth of a second pause. The <CR> indicates an end to the command string. This command is repeated for one more command string.
- **\$P 3 27 5 1** An IR push is sent to device 3 (VCR) on channel 27 (Main power on) for period of 5 tenths of a second and a one tenth of a second pause. The <CR> indicates an end to the command string.
- **\$P 4 9 5 1** An IR push is sent to device 4 (satellite receiver) on channel 9 (Power) for period of 5 tenths of a second and a one tenth of a second pause. The <CR> indicates an end to the command string.

While the macro is executing, a touch to Continue button example (Figure 53) is shown on the touch panel screen.

Figure 53

Touch to Continue button example

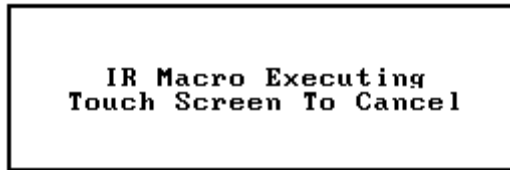

If the screen is touched to cancel macro execution, all touch panel activity stops until another button press occurs.

Creating a Joystick

Note

Joystick will function on VPW-CP/VPW-GS only.

You can create a joystick with the BUTTON TYPE operation bar in the Button Properties page. Joysticks (Figure 54) are vertical and horizontal direction controllers you can use for camera operations such as pan and tilt.

Figure 54

Joystick

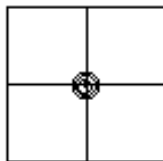

Before you start, make sure to connect the touch panel system to your Central Controller. Otherwise, the joystick may not work properly. Refer to the *Touch Panel Program Reference* section in this manual for more information.

Note

Joystick will function on VPW-CP/VPW-GS only.

Adding a joystick to a page

Create a new button using the ADD operation bar in the BUTTON menu as described in the *Creating a Button* subsection.

1. Press BUTTON on the Edit bar to open the Button menu.
2. Press PROPERTIES to open the PROPERTIES operation bar shown in Figure 55.

Figure 55

PROPERTIES operation bar

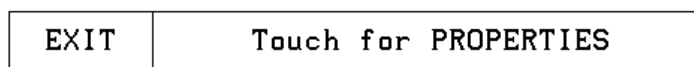

3. Press the target button to open the Button Properties page for the selected button.
4. Press BUTTON TYPE to open the BUTTON TYPE menu.

5. Press JOYSTICK to set the target button as a joystick.
6. Press BUTTON OPTIONS on the Button Properties page to open the BUTTON OPTION menu for Joysticks shown in Figure 56.

Figure 56

BUTTON OPTION menu for Joysticks

BUTTON OPTION
JOYSTICK NON-CENTER
JOYSTICK CENTER
CROSSHAIR NON-CENTER
CROSSHAIR CENTER
<div style="text-align: right; margin-right: 20px;"> <input type="button" value="ABORT"/> </div>

7. Press CROSSHAIR CENTER to set a crosshair in the center of the joystick button and return to the Button Properties page.
8. Press EXIT SAVE CHANGE to return to the Main page.
9. Press EXIT to exit from the PROPERTIES operation bar.

Setting the joystick properties

Note

Joystick will function on VPW-CP/VPW-GS only.

1. Press EDIT, BUTTON, and the PROPERTIES operation bar.
2. Press the target button to open the Button Properties page.
3. Press BUTTON TYPE to open the BUTTON TYPE menu (Figure 34).
4. Press JOYSTICK in the BUTTON TYPE menu to open the Button Properties page shown in Figure 57.

Figure 57

Button Properties page for Joysticks

Note

If you followed the instructions for *Adding a joystick to a page* subsection, this button's Properties page appears.

Note

If DEVICE USED is set to 4 and Base Device Number is 128, the Central Controller recognizes bus devices 128, 129, 130, and 131.

BORDER	CHANNEL	LEVEL			
	DEV: 1	DEV: 1			
	CHAN: 0	NUM: 0			
BUTTON TYPE: JOYSTICK					
BUTTON OPTIONS: JOYSTICK CENTER					
STRING:					
CHANNEL OFF COLOR CHANNEL ON					
BORDER	FILL	TEXT	BORDER	FILL	TEXT
EXIT SAVE CHANGE			EXIT NO CHANGE		

Setting the channel code

The channel buttons that set the device and button channel codes for the touch panels are shown in Figure 58.

Figure 58

CHANNEL code buttons

CHANNEL
DEV: 1
CHAN: 0

Note

The panel will not allow you to enter a device number greater than the DEVICE USED without first displaying a decision box. This box asks you to decide whether you accept the new selection or default to the previous value.

Note

The channel code for non-active buttons is 0 and for active buttons is 1 through 255.

1. Press DEV to open a keypad and set the joystick's device number.
2. Enter 1, 2, 3, or 4 in the keypad. The device number specifies the device number that the selected channel's feedback displays.
3. Press ENTER to store the device number into memory, close the keypad, and return to the Button Properties page.
4. Press CHAN to open the keypad and enter a channel value of 1 through 255 in the keypad. The AXCESS software program uses the channel code number to identify the button and its' programmed operations.
5. Press ENTER to store the channel number in memory, close the keypad, and return to the Button Properties page.

Setting the level code

The level buttons that set the device and number codes for the touch panels are shown in Figure 59.

Figure 59

LEVEL code buttons

LEVEL
DEV: 1
NUM: 0

Note

The panel will not allow you to enter a device number greater than the DEVICE USED without first displaying a decision box. This box asks you to decide whether you accept the new selection or default to the previous value.

Note

Joysticks actually use two level numbers. The first is for the X-axis and the second is for the Y-axis. You only need to specify the first level.

1. Press DEV to open a keypad and set the device number.
2. Enter 1, 2, 3, or 4 in the keypad. The AXCESS software program uses device codes 1 through 4 to identify the touch panel. Refer to the *Touch Panel Program Reference* section for detailed information.
3. Press ENTER to store the level device number in memory, close the keypad, and return to the Button Properties page.
4. Press NUM to open a keypad and set the level number assigned to the device.
5. Enter 1 in the keypad.
6. Each device can have from 1 through 8 levels except for joysticks where the range is from 1 through 7

Setting the joystick colors/shades for channel-off conditions

1. Press the target button to open the Button Properties page.
2. Press BORDER in the CHANNEL OFF COLOR section of the Button Properties page (Figure 60).

Figure 60

CHANNEL OFF/ON COLOR settings box

CHANNEL OFF			COLOR	CHANNEL ON		
BORDER	FILL	TEXT	BORDER	FILL	TEXT	
<input type="text"/>	<input type="text"/>	<input type="text"/>	<input type="text"/>	<input type="text"/>	<input type="text"/>	

Note

Joystick will function on VPW-CP/VPW-GS only.

3. The color palette (Figure 42) appears.

Figure 61

Color palette

Note

The VPT-GS will display gray shades for selection.

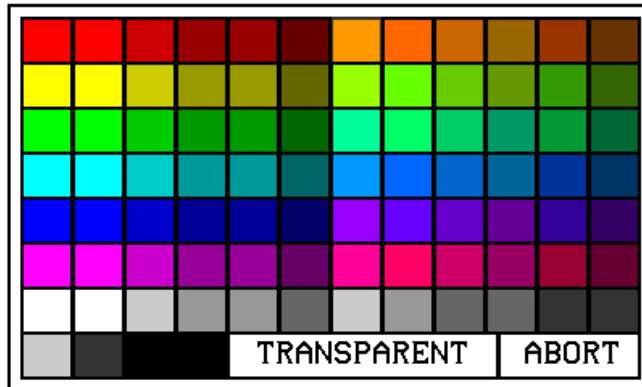

4. Press black to set the border color.
5. Press the FILL button in the Button Properties page to open the color palette.
6. Press white to set the fill color.
7. Press the TEXT button to open the palette.
8. Press red to set the text color.
9. Press EXIT SAVE CHANGE in the Button Properties page to store the new button properties into memory and return to the current page
10. Press EXIT on the PROPERTIES operation bar

Note

Joysticks actually use two level numbers. The first is for the X-axis and the second is for the Y-axis. You only need to specify the first level.

Creating a Bargraph

Bargraphs (Figure 62) are level monitors and adjustable level controls. These levels can be configured to monitor audio outputs, lighting levels, and adjust audio or light levels. Before you start, make sure to connect the touch panel to your Central Controller; otherwise, the bargraph may not work properly. Refer to the *Touch Panel Program Reference*.

Note

Bargraphs will function on VPW-CP/VPW-GS only.

Figure 62

Bargraph



Adding a bargraph to a page

Note

Bargraphs will function on VPW-CP/VPW-GS only

1. Press EDIT to open the Edit bar.
2. Create a new button using the ADD operation bar in the BUTTON menu.
3. Press BUTTON in the Edit bar to open the BUTTON menu.
4. Press PROPERTIES in the BUTTON menu to open the PROPERTIES operation bar shown in Figure 63.

Figure 63

PROPERTIES operation bar

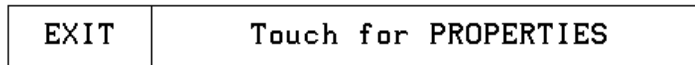

5. Press the target button to open the Button Properties page.
6. Press BUTTON TYPE to open the BUTTON TYPE menus shown in Figure 64.

Figure 64

BUTTON TYPE menus

Note

Bargraphs joysticks will function on VPW-CP/VPW-GS only.

BUTTON TYPE	**BUTTON TYPE**				
GENERAL	TIME				
JOYSTICK	DATE				
VERTICAL BARGRAPH	KEYPAD				
HORIZONTAL BARGRAPH	KEYBOARD				
BRIGHTNESS	SETUP				
TIME	VIDEO SETUP				
DATE	VIDEO WINDOW				
KEYPAD	VIDEO JOYSTICK				
KEYBOARD	RGB SETUP				
SETUP	PROTECTED				
<table border="1" style="width: 100%; border-collapse: collapse;"> <tr> <td style="width: 50%; text-align: center; padding: 2px;">MORE</td> <td style="width: 50%; text-align: center; padding: 2px;">ABORT</td> </tr> </table>	MORE	ABORT	<table border="1" style="width: 100%; border-collapse: collapse;"> <tr> <td style="width: 50%; text-align: center; padding: 2px;">PREV</td> <td style="width: 50%; text-align: center; padding: 2px;">ABORT</td> </tr> </table>	PREV	ABORT
MORE	ABORT				
PREV	ABORT				

7. Select VERTICAL BARGRAPH to open the Button Properties page for Vertical Bargraphs shown in Figure 65.

Figure 65

Button Properties page for Vertical Bargraphs

BORDER	CHANNEL	LEVEL			
	DEV: 1	DEV: 1			
	CHAN: 0	NUM: 0			
BUTTON TYPE: VERTICAL BARGRAPH					
BUTTON OPTIONS: BARGRAPH ACTIVE					
STRING:					
CHANNEL OFF COLOR CHANNEL ON					
BORDER	FILL	TEXT	BORDER	FILL	TEXT
EXIT SAVE CHANGE			EXIT NO CHANGE		

Setting the bargraph properties

Use the Button Properties page for Vertical Bargraphs shown in Figure 65 to set channel, level, and button colors.

Note

Bargraphs will function on VPW-CP/VPW-GS only.

Setting the channel code

The channel buttons that set the device and button channel codes for the touch panels are shown in Figure 66.

Figure 66

Bargraph CHANNEL code buttons

CHANNEL
DEV: 1
CHAN: 0

Note

The panel will not allow you to enter a device number greater than the DEVICE USED without first displaying a decision box. This box asks you to decide whether you accept the new selection or default to the previous value

1. Press DEV to open the keypad and set the device number.
2. Enter 1, 2, 3, or 4 in the keypad. The AXCESS software program uses device codes 1 through 4 to identify the touch panel. Refer to the *Touch Panel Program Reference* section for detailed information.
3. Press ENTER to store the device number into memory, close the keypad, and return to the Button Properties page.

4. Press CHAN to open a keypad and enter a channel value of 1 through 255 in the keypad. The AXCESS software program uses the channel code number to identify the button and its' operations
5. Press ENTER to store the channel number into memory, close the keypad, and return to the Button Properties page.

Note

The channel code for non-active buttons is 0 and for active buttons is 1 through 255.

Setting the level code

The level buttons that set the device and number codes for the touch panels are shown in Figure 67.

Figure 67

LEVEL code buttons

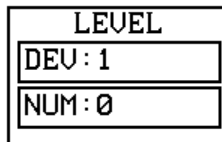

Note

The panel will not allow you to enter a device number greater than the DEVICE USED without first displaying a decision box. This box asks you to decide whether you accept the new selection or default to the previous value.

1. Press DEV to open a keypad and set the device number.
2. Enter 1, 2, 3, or 4 in the keypad. The AXCESS software program uses device codes 1 through 4 to identify the touch panel. Refer to the *Touch Panel Program Reference* in this manual for detailed information.
3. Press ENTER to store the level device number into memory, close the keypad, and return to the Button Properties page.
4. Press NUM to open a keypad and set the level number assigned to the device.
5. Enter 1 in the keypad.
6. Press ENTER to store the level number into memory, close the keypad, and return to the Button Properties page.
7. Press EXIT SAVE CHANGE, then EXIT to return to the New page with the EDIT button.

Setting the bargraph colors/shades for channel-off conditions

Note

Bargraphs will function on VPW-CP/VPW-GS only.

1. Press the target button to open the Button Properties page.
2. Press BORDER in the CHANNEL OFF COLOR section of the Button Properties page (Figure 60).

Figure 68

CHANNEL OFF/ON COLOR settings box

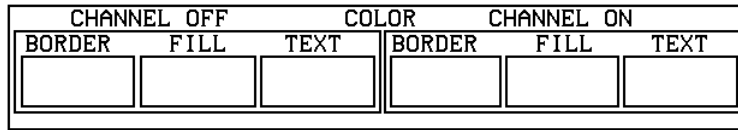

3. The color palette (Figure 42) appears.

Figure 69

Color palette

Note

The VPT-GS will display gray shades for selection.

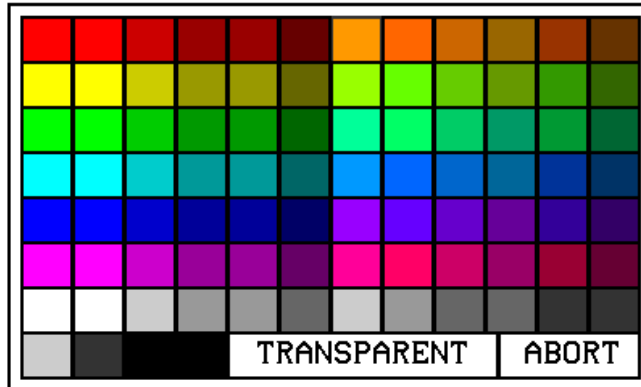

4. Press black to set the border color.
5. Press the FILL button in the Button Properties page to open the color palette.
6. Press white to set the fill color.
7. Press the TEXT button to open the palette.
8. Press red to set the text color.
9. Press EXIT SAVE CHANGE in the Button Properties page to store the new button properties into memory and return to the current page.
10. Press EXIT on the PROPERTIES operation bar.

Linking the New Page to the Main Page

Use the Attributes page to link buttons to pages. This operation requires changing the button text and setting a page flip. Refer to *Adding a page*, *Creating a Button*, *Go to*, and *Setting the page flip* for detailed information.

1. Open the Edit bar, press the active page button shown in Figure 70. Refer to the *Go to* subsection for information on the use of the active page button

Figure 70

Edit bar with active page button

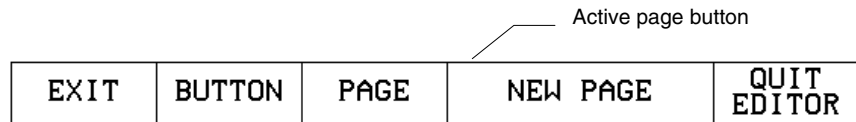

2. Press MAIN PAGE from the PAGE GOTO menu.
3. Press EDIT to open the Edit bar.
4. Press BUTTON on the Edit bar to open the BUTTON menu.
5. Press TEXT/IMAGE to change the Main page button text. The TEXT/IMAGE operation bar (Figure 71) appears.

Figure 71

TEXT/IMAGE operation bar

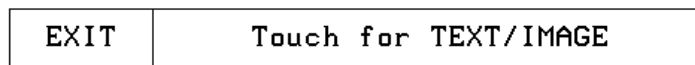

6. Press the MAIN button to open the Text/Image page.
7. Press TEXT OFF to open the keyboard and delete MAIN.
8. Enter *NEW PAGE*. The text appears in the keyboard window.
9. Press EXIT CHANGE to close the keyboard and return to the Text/Image page.
10. Press MAKE ON SAME AS OFF to set the text for the button's TEXT ON and TEXT OFF states.
11. Press EXIT SAVE CHANGE to close the Text/Image page and return to the Main page.
12. Press EXIT to exit the TEXT/IMAGE mode.
13. Press EDIT to open the Edit bar.
14. Press BUTTON to open the BUTTON OPTIONS menu.
15. Press PROPERTIES in the BUTTON OPTIONS menu to open the PROPERTIES operation bar shown in Figure 72.

Figure 72

PROPERTIES operation bar

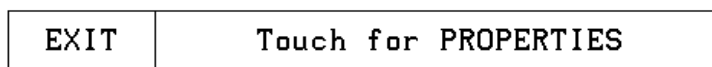

16. Press the NEW PAGE button to open the Button Properties page.
17. Press the page FLIP buttons (Figure 73) to set the page flip properties for the button.

Figure 73

Page FLIP buttons

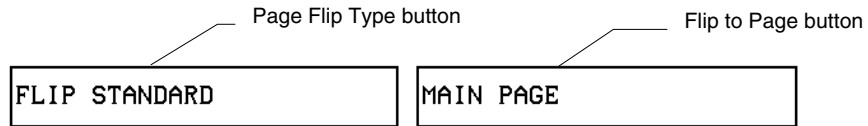

18. Press the left Flip Type box in the Button Properties page to open the PAGE FLIP TYPE menu (Figure 74).

Figure 74

PAGE FLIP TYPE menu

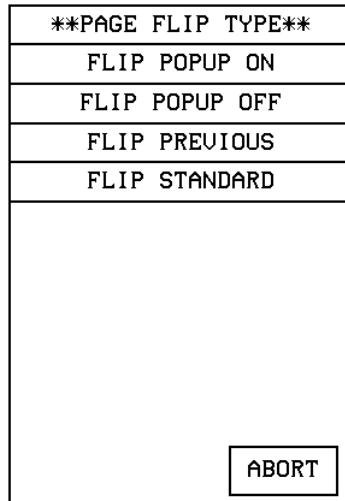

19. Press FLIP STANDARD to select a standard page flip and return to the Button Properties page.
20. Press the right Page Flip box to set the destination page (Figure 75).

Figure 77

Setup page

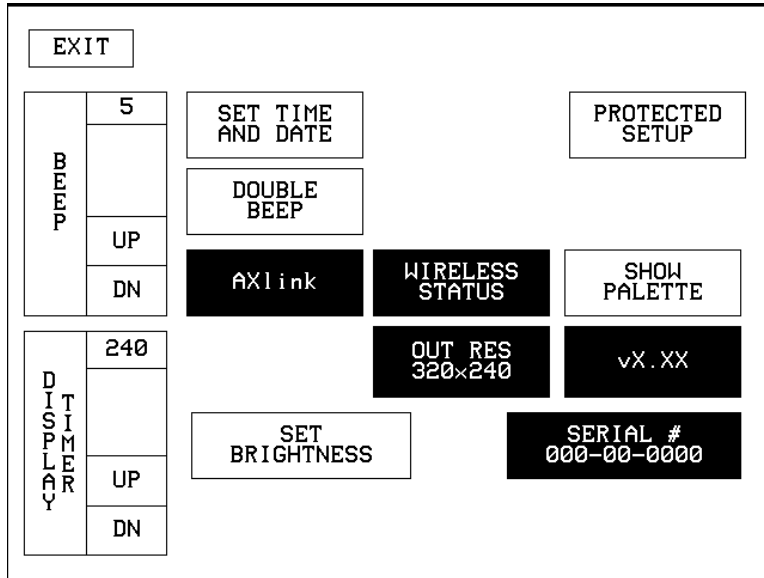

3. Press PROTECTED SETUP to open the Protected Setup page shown in Figure 78.

Figure 78

Protected Setup page

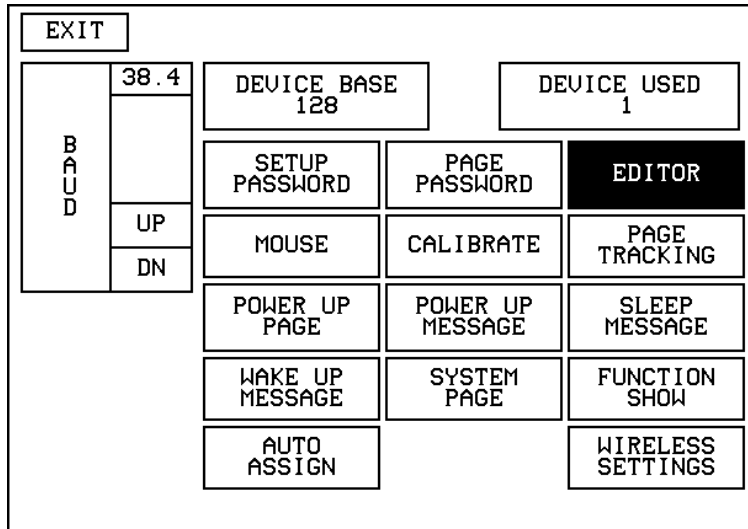

4. Press EDITOR to toggle EDIT mode Off.
5. Press EXIT to close the Protected Setup page and return to the Setup page (Figure 77).
6. Press EXIT to close the Setup page and return to the Main page.

Another method of exiting the EDIT mode is to use the QUIT EDITOR button on the Edit bar. Refer to the *Edit Bar - Quit Editor option* subsection for detailed information on exiting the EDIT mode using this method.

- 1.** Press EXIT to open the Edit bar shown in Figure 76.
- 2.** Press the QUIT EDITOR button to open the Quit the On-Board Editor decision button.
- 3.** If you select YES, the current page will appear without the Edit bar.

Touch Panel Program Reference

Overview

This section contains operation flowcharts, instructions, and menu option descriptions. The buttons shown in Figure 79 appear when you power up the touch panel.

Figure 79

Main page

Note

The information within this section applies to all ViewPoint models.

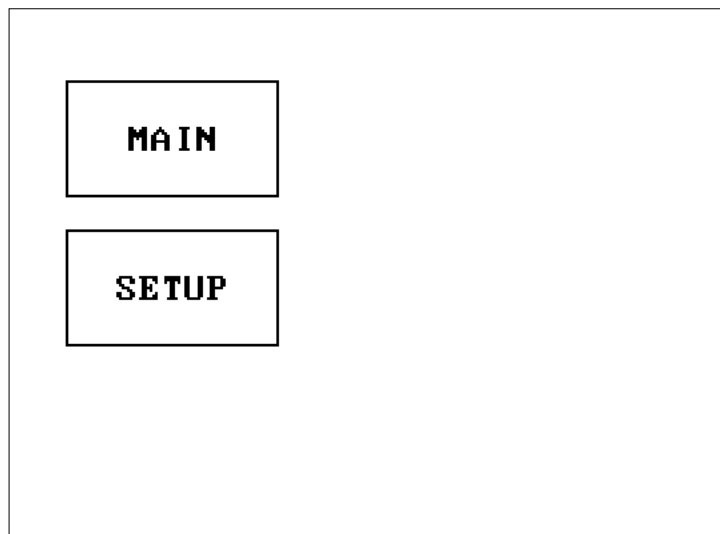

Setup Page

Press the **SETUP** button from the Main page, to open the Setup page shown in Figure 80. Use the Setup and Protected Setup pages to configure how the touch panel operates.

Figure 80

Setup page

Note

The WIRELESS STATUS button appears when a WAV-PK or SMT-PK is attached to the touch panel.

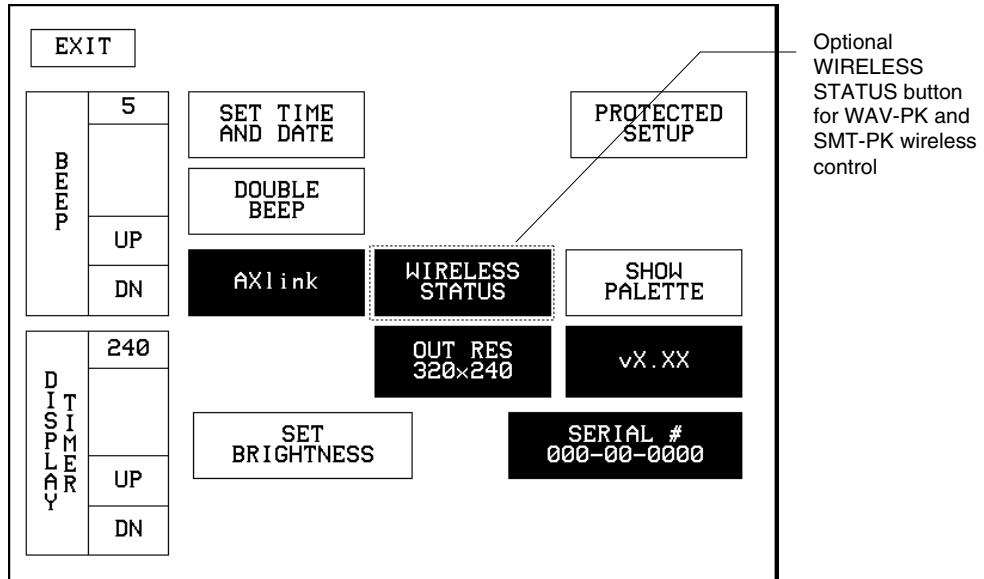

Beep

The Beep button sets the duration of the audible beep provided by the touch panel. The values are 0 to 5. Using 0 turns the beep tone off and 1 through 5 provide the audible beep and gradually increase the beep duration.

Figure 81

BEEP button

Note

You can set the beep value using the 'ABEEP' and 'ADBEEP' Send_ Commands described in the *AXCESS Programming* section. The 'QBEEP' command is used for overriding.

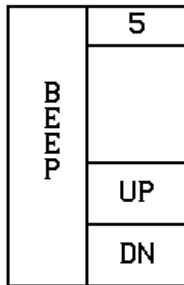

Display timer

The DISPLAY TIMER button (Figure 82) sets the length of time the touch panel can be idle before activating screen-saver sleep mode.

Figure 82

DISPLAY TIMER button

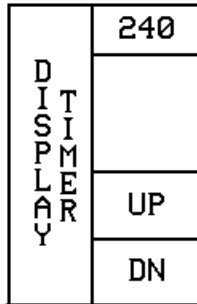

When the touch panel goes into screen-saver mode, the LCD is powered-down. With a setting of 5, the panel goes into screen-saver mode if there is no activity for 5 minutes. Press the UP and DN buttons to set the DISPLAY TIMER. The minimum time is 1 minute and the maximum is 240 minutes.

Set time and date

Press SET TIME AND DATE to open the page shown in Figure 83.

Figure 83

Set Time And Date page

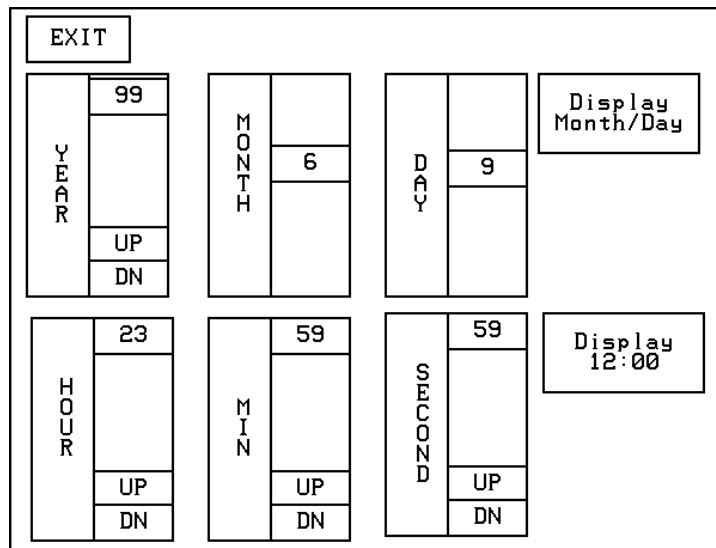

Use this page to set the year, hour, month, minute, day, second, day/month, and clock display.

- **YEAR** Press the UP and DN buttons to set the year.
- **HOUR** Press the UP and DN buttons to set the hour.
- **MONTH** Press the UP and DN buttons to set the month.

- **MIN** Press the UP and DN buttons to set the minute.
- **DAY** Press the UP and DN buttons to set the day.
- **SECOND** Press the UP and DN buttons to set the seconds.
- **DISPLAY MONTH/DAY, DAY/MONTH** Press to toggle the order of the month and day display.
- **DISPLAY 12:00/24:00** Press to toggle the clock display to a 12- or 24-hour format. For example, the 12-hour clock format changes from 12:00 to 1:00, and the 24-hour clock changes from 12:00 to 13:00.

Double beep

Press the DOUBLE BEEP button (Figure 84) to toggle the double beep ON or OFF. The double beep sounds each time you press the screen.

Figure 84

DOUBLE BEEP button



Note

You can set the beep value using the 'ABEEP' and 'ADBEEP' Send_ Commands described in the *AXCESS Programming* section. The 'QBEEP' command is used for overriding.

Set the BEEP button (described earlier) to 0 to disable the double-beep sound.

AXlink, output resolution, vX.XX, and serial number

The AXlink, OUTPUT RESOLUTION, vX.XX, and SERIAL # buttons shown in Figure 85 are information buttons (display only).

Figure 85

AXlink, OUTPUT RESOLUTION, vX.XX, and SERIAL # button examples



The AXlink button is an AXCESS communication indicator that blinks once every second when the Central Controller is connected to the touch panel. The OUTPUT RESOLUTION button shows the screen resolution. The vX.XX button shows the current firmware version installed in the touch panel. The SERIAL # button shows the serial number for the touch panel.

Setting brightness

Press the SET BRIGHTNESS button in the Setup page to open the page shown in Figure 86.

Figure 86

SET BRIGHTNESS page

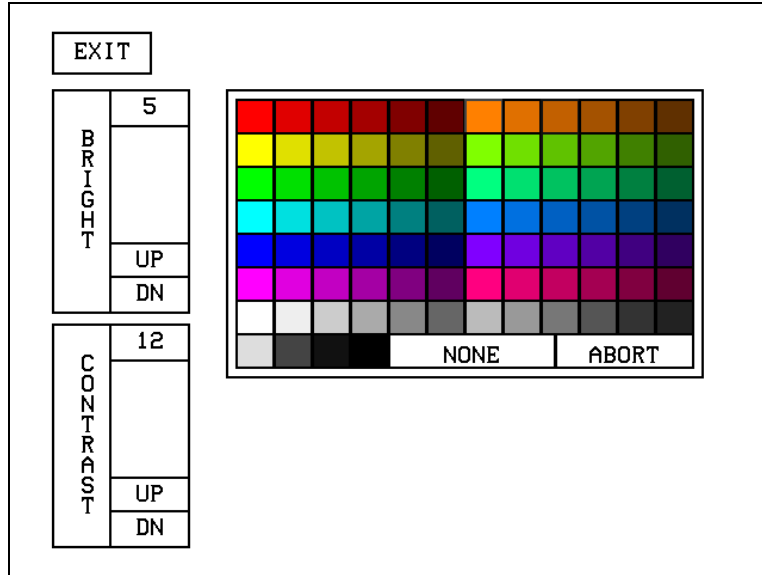

Note

A lower brightness settings information button appears in the lower right-hand of the screen when the brightness setting exceeds 5

Press the UP and DN buttons to set the LCD brightness and contrast on the touch panel. The maximum brightness level is 5 and the maximum contrast level is 12. The TRANSPARENT and ABORT buttons are disabled for this page. When an optional WavePack/SmartPack is attached to the panel, a lower brightness message (Figure 87) will appear to suggest brightness settings for longer battery life.

Figure 87

Lower brightness information message



Protected setup

The PROTECTED SETUP button opens the Protected Setup page where you set touch panel passwords, mouse control, communications parameters, etc. The PROTECTED SETUP button is highlighted when enabled, as shown in Figure 88. Because there are many operations associated with Protected Setup page, they are described in the *Error! Reference source not found.* subsection.

Figure 88

PROTECTED SETUP button (highlighted)



Show palette

Press SHOW PALETTE to open the color palette. Pressing the screen again will cause you to leave the Show Palette page.

Wireless status (optional WAV-PK)

Note

The WAV-PK page provides read-only information about the Wave-Pack. The only setting that can be changed is the SLEEP TIMEOUT value.

The WIRELESS STATUS button appears on the Setup page when an AXR-WAVES Wireless AXlink Virtual Emulator Server is connected to the touch panel. The WAV-PKM provides wireless two-way RF spread-spectrum touch panel control and contains a lead-acid rechargeable battery that supplies independent power to the panel. Refer to the *WAVE 2-Way Wireless Accessories and Adapters for Touch Panels* instruction manual for detailed setup information. Press the WIRELESS STATUS button to open the WAV-PK page shown in Figure 89.

Figure 89

WAV-PK page

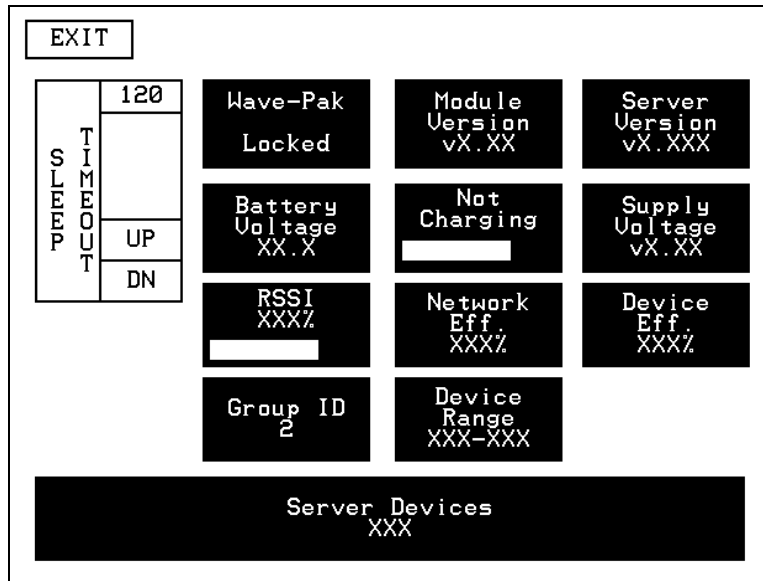

The Wave-Pack page shows the following information:

- **SLEEP TIMEOUT** Press the UP and DN buttons to set the sleep time-out. The minimum time-out is 1 minute and maximum is 120 minutes. When the touch panel goes to sleep, all communication and battery discharge stops. If the time-out is set to 5, the panel goes into sleep mode if there is no activity for 5 minutes. The touch panel automatically wakes up when you touch the screen for more than 0.5 seconds.

- **Wave-Pak Not Locked/Locked** Appears when an optional WAV-PKM is connected to the touch panel. Not locked indicates the touch panel is not communicating with the AXR-WAVES. Locked indicates the touch panel is locked on (communicating) to the AXR-WAVES connected to the Central Controller.
- **Battery Voltage XX.X** Shows the voltage level of the lead-acid rechargeable battery in the WAV-PK.
- **RSSI XXX%** Shows the strength of the AXR-WAVES signal received by the touch panel. The signal strength fluctuates between 0% and 100% as shown by a horizontal gauge moving from left to right.
- **GROUP ID** Shows the GROUP ID number on the touch panel used to communicate with the wireless AXR-WAVES with the same group ID number. The group ID range is 0 - 15. The group ID setting overrides the DIP switch setting on the WAV-PK.
- **Module Version vX.XX** Shows the firmware version installed in the WAV-PK.
- **Fully Charged/Not Charging/Charging** Fully Charged appears when the battery in the WAV-PK is fully charged. Not Charging appears when the lead-acid battery is not charging. Charging appears when the lead-acid battery is charging. The shaded area is a horizontal gauge moving from left to right as the battery voltage level increases.
- **Network Eff. XXX%** Shows the communication efficiency of bidirectional RF transmissions between the touch panel and AXR-WAVES. The efficiency percentage (0-100%) is determined by the number of retries required to complete a panel operation.
- **Device Range** Shows the device range that your server can recognize. Devices outside that range will not be recognized.
- **Server Devices XXX** Shows the group address for the AXR-WAVES communicating with the touch panel.
- **Server Version** Shows the firmware version installed in the AXR-WAVES.
- **Supply Voltage vX.XX** Shows the voltage level of the external power supply (optional) connected to the WAV-PK.
- **Device Eff. XXX%** Shows the strength of the AXR-WAVES signal received by the touch panel. The shaded area in the horizontal gauge moves

Note

The GROUP ID number can be set from the Wireless Settings page in the Protected Setup page. Refer to the *Wireless settings* subsections for detailed information.

Note

The Network Eff. XXX% and Device Eff. XXX% information buttons are the best indicators of communication.

from left to right as the RF signal intensity increases. The shaded area fluctuates between 0% and 100%.

Note

This SMT-PK page provides read-only information about the Smart Pack. The only setting that can be changed is the SLEEP TIMEOUT value.

Wireless status (optional SMT-PK)

The WIRELESS STATUS button appears on the Setup page when a SmartPack is connected to the touch panel. Press the WIRELESS STATUS button to open the optional page shown in Figure 91.

Figure 90

SMT-PKM page

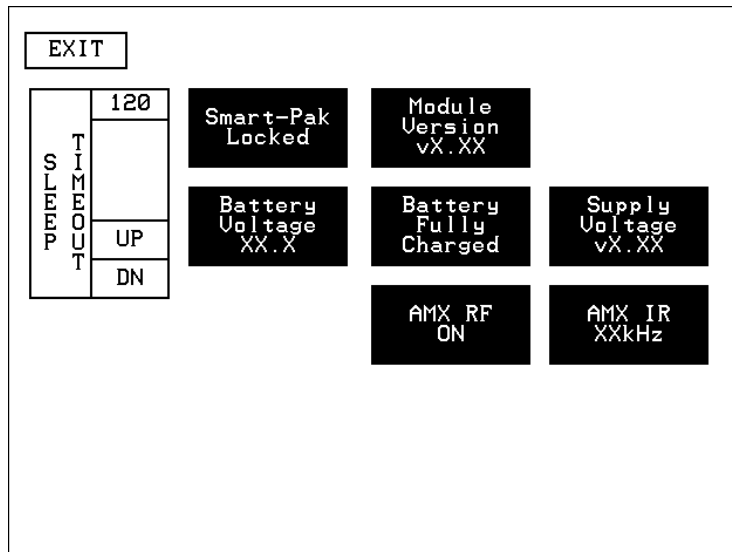

Refer to the *SmartPacks for TiltScreen Touch Panels* instruction manual for detailed information. The SmartPack page shows the following information:

- **SLEEP TIMEOUT** Press the UP and DN buttons to set the time-out. The minimum time-out is 1 minute and maximum is 120 minutes. When the panel goes to sleep, all communication and battery discharge stops. If the time-out is set to 5, the panel goes into sleep mode if there is no activity for 5 minutes. The panel wakes up when you touch the screen.
- **Smart-Pak Not Locked/Locked** Appears when an optional SMT-PK is connected to the panel. Not locked indicates the panel is not communicating with the AXR-RF RF receiver. Locked indicates the panel is locked on to the AXR-RF connected to the Central Controller.
- **Battery Voltage XX.X** Shows the voltage level of the lead-acid rechargeable battery in the SMT-PK.

Note

Refer to the *Wireless status (optional WAV-PK)* subsection for information on how to set the RF and IR.

- **Module Version vX.XX** Shows the firmware version installed in the SMT-PK.
- **Fully Charged/Not Charging/Charging** Fully Charged appears when the battery in the SMT-PK is fully charged. Not Charging appears when the lead-acid battery is not charging. Charging appears when the lead-acid battery is charging. The shaded area is a horizontal gauge moving from left to right as the battery voltage level increases.
- **AMX RF ON/OFF** Shows RF transmission on or off.
- **Supply Voltage vX.XX** Shows the voltage level of the external power supply (optional) connected to the SMT-PK.
- **AMX IR 38 kHz/455 kHz/OFF** Shows the IR transmitting frequency to 38 kHz, 455 kHz, or OFF.

Wireless settings for VPT-CP and VPT-GS

The WIRELESS SETTINGS button appears on the Setup page. The VPT-CP and VPT-GS provide one-way touch panel control, and transmits RF and high or low-frequency IR signals. The ViewPoint contains a Nickel Metal Hydride rechargeable battery that supplies independent power to the touch panel. Press the WIRELESS SETTINGS button to open the page shown in Figure 91.

Figure 91

WIRELESS SETTINGS page
(VPT-CP and VPT-GS)

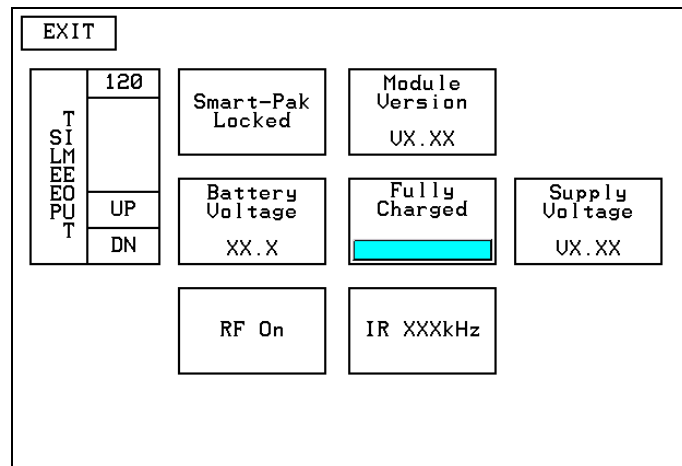

- **SLEEP TIMEOUT** Press the UP and DN buttons to set the sleep time. The minimum sleep time is 0 (off) and maximum is 120 minutes. When the touch panel goes to sleep, all communication and battery discharge stops. If the sleep time is set to 5, the panel goes into sleep mode if there is no activity for

5 minutes. The touch panel wakes up when you touch the screen for more than .5 seconds.

- **ViewPoint Module** Not functional at this time.
- **Module Version VX.XX** Shows the ROM firmware version installed in the ViewPoint.
- **Battery Voltage XX.X** Shows the voltage level of the Nickel Metal Hydride rechargeable battery.
- **Battery Not Charging/Battery Charging** Battery Not Charging appears when the Nickel Metal Hydride battery is not charging. Battery Charging appears when the Nickel Metal Hydride battery is charging. The shaded area in the horizontal gauge button moves from left-to-right as the battery voltage level increases.
- **Supply Voltage VX.XX** Shows the voltage level of the external power supply connected to the ViewPoint.
- **AMX RF ON / OFF** Toggles RF transmission on or off.
- **AMX IR 38 kHz/455 kHz/OFF** Toggles the IR transmitting frequency to 38 kHz, 455 kHz, or off.

Wireless Status for VPW-CP and VPW-GS

The WIRELESS STATUS button appears on the Setup page. The ViewPoint provides two-way RF control and provides one-way IR signaling. The ViewPoint contains a Nickel Metal Hydride rechargeable battery that supplies independent power to the touch panel. Press the WIRELESS SETTINGS button to open the page shown in Figure 92.

Figure 92

Wireless status for VPW-CP and VPW-CP touch panels.

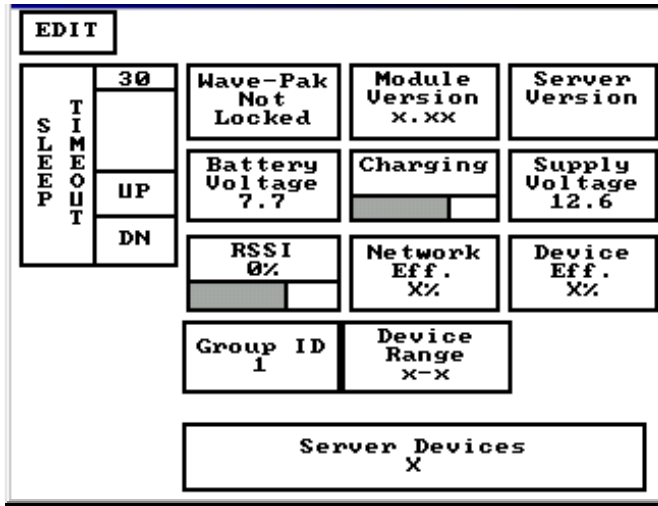

Wave-Pak not locked

Does not apply to the VPW-CP or VPW-GS touch panels.

Module version

Does not apply to the VPW-CP or VPW-GS touch panels.

Server version

Identifies the operating version of the AXR-WAVES WaveServer firmware.

RSSI

Radio signal strength indicator showing the relative signal strength in percent and visual horizontal bargraph.

Network Eff.

Operating efficiency (shown in percentage) of the current network that the VPW-CP or VPW-GS is a part of.

Device Eff.

Operating efficiency (shown in percentage) of the VPW-CP or VPW-GS.

Device range

Indicates the assignable device number range (for RF operation) available for the VPW-CP or VPW-GS.

Server devices

Identifies the device numbers of the devices communicating with the AXR-WAVES WaveServer.

Protected Setup Page

The Protected Setup page allows you to set passwords, mouse controls, and communications parameters. The flowchart in Figure 93 shows how to access the Protected Setup page, which is password-protected. When you press the PROTECTED SETUP button on the Setup page, a number keypad appears.

Figure 93

Protected Setup page flowchart

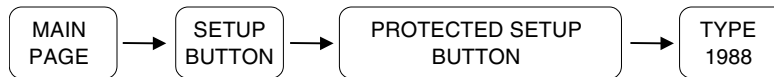

Note

When the Edit bar is enabled, you do not have to enter the password when opening the Protected Setup page.

Type **1988**, which is the system default password, and press ENTER to open the Protected Setup page. (You can change the password, as explained in the *Setup Password* subsection.) If you enter a wrong number, press CLEAR and re-enter the number. The Protected Setup page (Figure 94) appears when you enter the correct password.

Figure 94

Protected Setup page

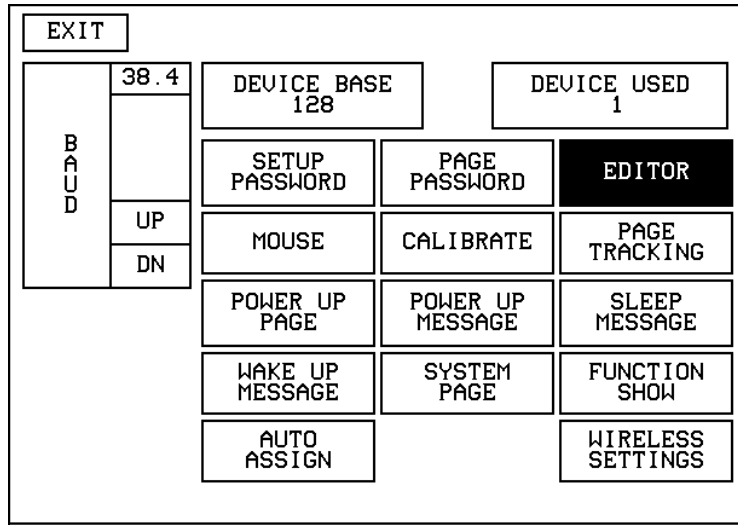

Baud

The BAUD button (Figure 95) sets the baud rate. The baud rate is automatically set to 38.4. The BAUD rate is for communicating with your PC when downloading a program or new firmware.

Figure 95

BAUD button

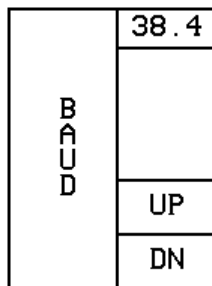

Note

Make sure to match the baud rate for communications with TPDesign3.xx.

- **BAUD** Press the UP and DN buttons to set the data communication speed with the . Available baud rates are 300, 600, 1200, 2400, 4800, 9600, 19.2, and 38.4.

Device base

Press the DEVICE BASE button (Figure 96) to open a keypad and set the base address for the touch panel. The base address range is from 1 through 255.

Figure 96

DEVICE BASE button

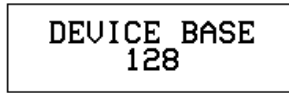

Note

If four devices are used, and the base address is 128, then the touch panel will consecutively use device numbers 128, 129, 130, and 131.

Device used

Press the DEVICE USED button (Figure 97) to open a keypad and set the panel's device number from 1 through 4. Each device number supports up to 255-channel code button assignments. The multiple device settings allow you to create up to four unique touch panel buttons and/or pages. This value is used to determine the current device being used by the panel.

Figure 97

DEVICE USED button

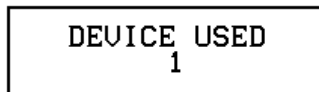

Setup password

Press the SETUP PASSWORD button (Figure 98) to open a keypad and set the numeric SETUP password.

Figure 98

SETUP PASSWORD button



Warning

If you change the password number, record the new number and keep it in a secure place. If you change the password, AMX cannot provide you with the password.

The password number range is 1 through 5,999. (Do not use zero.) Do not change the Setup page password unless you are concerned about unauthorized access to the touch panel pages.

- **CLEAR** Press to clear the number in the keypad display.
- **ENTER** Press to enter the new password into touch panel memory and close the keypad.

Power up page

Press the POWER UP PAGE button to open the PAGE menu (Figure 99).

Figure 99

POWER UP PAGE button
and example PAGE menu

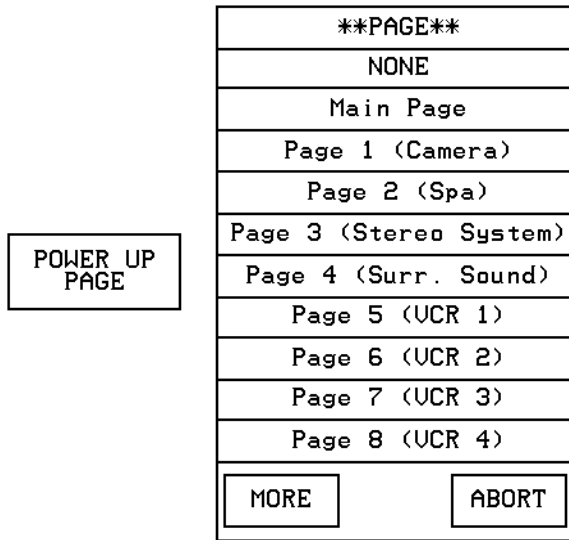

Select a page to designate as the first page to appear when you power up the touch panel. Select NONE to disable this option. If none is selected, the last selected page will be the first active page the next time the touch panel is used.

Wake up message

Press WAKE UP MESSAGE (Figure 100) to open the touch panel keyboard, and enter an ASCII string to be sent to the Central Controller when the touch panel wakes up. You can program the Central Controller to perform specific operations when the message is received. Refer to the *AXCESS Programming* section for detailed programming information.

Figure 100

WAKE UP MESSAGE button



Auto assign

Press AUTO ASSIGN (Figure 101) to enable the automatic channel assignment. This option sets the touch panel to prompt you to manually or automatically assign a channel number (1 through 255) to a new button. Once selected, the touch panel assigns the lowest unused channel number to the button. Press AUTO ASSIGN again to disable.

Figure 101

AUTO ASSIGN button



Page password

Press the PAGE PASSWORD button (Figure 102) to open a keypad and assign a page's numeric password.

Figure 102

PAGE PASSWORD button



Note

This numeric password applies to the touch panel pages only, and is separate from the SETUP PASSWORD button that sets up the numeric password for access to the Protected Setup page.

If you try to open a password-protected page, the keypad appears, and you must enter the correct password number to open the new page. The page password range is 1-5,999.

- **CLEAR** Clears the number in the keypad display.
- **ENTER** Sets the page password number, closes the keypad, and returns to the Protected Setup page.

Note

Press and hold for 2 seconds to enter Calibration mode

Calibrate

Press CALIBRATE to open the CALIBRATE decision button shown in Figure 103 and reset the vertical and horizontal touch points on the LCD.

Figure 103

CALIBRATE decision button



Note

The crosshair for calibration is first shown at the top-left corner of the touch panel screen.

- **YES** Starts the calibration process. Carefully press each crosshair that appears using your finger or dull pointer. When the calibration process is complete, press the screen to return to the Protected Setup page.
- **NO** Cancels the calibration process.

Power up message

Press POWER UP MESSAGE (Figure 104) to open the keyboard, and enter an ASCII string to be sent to the Central Controller when the touch panel is powered up. The Central Controller can be programmed to perform specific operations when the

message is received. Refer to the *AXCESS Programming* section for detailed programming information.

Figure 104

POWER UP MESSAGE button



System page

Press the SYSTEM PAGE button (Figure 105) to open the System page (Figure 106).

Figure 105

SYSTEM PAGE button

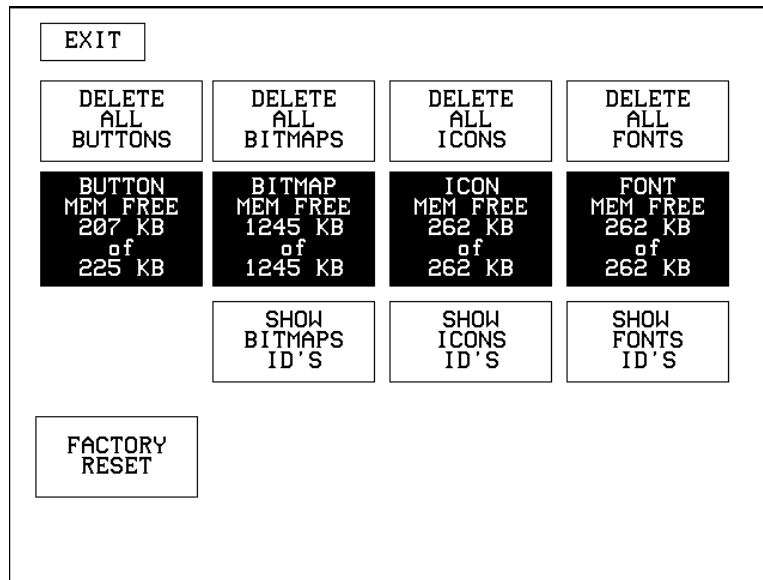

Figure 106

System page

Warning

The System page should only be used to purge unwanted buttons, bitmaps, icons, fonts, and stored touch panel settings. Before using this page, make sure you have a backup copy of the touch panel program stored in the TPDesign3 software program. If you press YES on any of the DELETE buttons, the stored data is *permanently* erased from panel memory.



- **DELETE ALL BUTTONS** Opens the decision button shown in Figure 107. Press YES to clear all touch panel buttons or NO to cancel the operation.

Figure 107

Delete All Buttons decision button

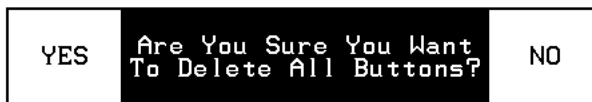

- **BUTTON MEM FREE** Shows the memory available to store buttons in 1,024-byte increments.
- **DELETE ALL BITMAPS** Opens the decision button shown in Figure 108. Press YES to clear all the bitmaps or NO to cancel the operation.

Figure 108

Delete All Bitmaps decision button

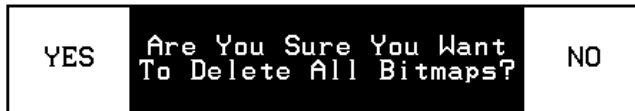

- **BITMAP MEM FREE** Shows the memory available to store bitmap graphics in 1,024-byte increments.
- **DELETE ALL ICONS** Opens the decision button shown in Figure 109. Press YES to clear all the icons or NO to cancel the operation.

Figure 109

Delete All Icons decision button



- **ICON MEM FREE** Shows the memory available to store icons in 1,024-byte increments.
- **DELETE ALL FONTS** Opens the decision button shown in Figure 110. Press YES to clear all the fonts or NO to cancel the operation.

Figure 110

Delete All Fonts decision button



- **FONT MEM FREE** Shows the memory available to store fonts in 1,024-byte increments.
- **SHOW BITMAPS ID'S** Opens the BITMAPS menu (Figure 111) that lists bitmap files stored in touch panel memory.

Figure 111

BITMAPS menu

BITMAPS	
NONE	
Pffds32.bmp	
Wfds32.bmp	
P32.bmp	
Cass.bmp	
Cdp.bmp	
Ldp.bmp	
Ucr.bmp	
Tuner.bmp	
Phone.bmp	
MORE	ABORT

- **SHOW ICONS ID'S** Opens the ICONS menu (Figure 112) that lists icons stored in touch panel memory.
 - MORE Forwards the menu listing.
 - ABORT Cancels the menu process and returns to the current page.

Figure 112

ICONS menu

ICONS	
NONE	
Cass	
CDP	
LDP	
UCR	
DSS (Blank)	
DUD (Blank)	
Tuner	
Phone	
DAT (Blank)	
MORE	ABORT

- **SHOW FONTS ID'S** Opens the FONTS menu (Figure 113) that lists fonts stored in touch panel memory.

Figure 116

Edit bar

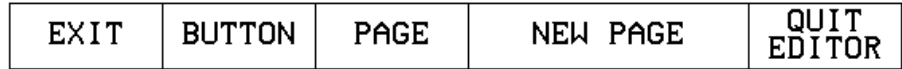

Page tracking

Press PAGE TRACKING (Figure 117) to toggle the page tracking ON or OFF. When page tracking is enabled, the touch panel sends page data back to the Central Controller or vice versa, depending on how you set the touch panel. Page tracking data can be used to control pages in multiple touch panels.

Figure 117

PAGE TRACKING button



Sleep message

Press SLEEP MESSAGE (Figure 118) to open a keyboard and enter a message to appear when the touch panel goes into sleep mode. Refer to *Display Timer* to set the touch panel's screen-saver mode.

Figure 118

SLEEP MESSAGE button



Function show

Press FUNCTION SHOW (Figure 119) to display channel code numbers and variable text code numbers on touch panel buttons, joysticks, sliders, and bargraphs.

Figure 119

FUNCTION SHOW button



As shown in Figure 120, the upper-left corner of a button shows a base device number followed by a channel code number. The bottom-right corner of a button shows the variable text number followed by the variable text channel.

Figure 120

Function show button and slider example

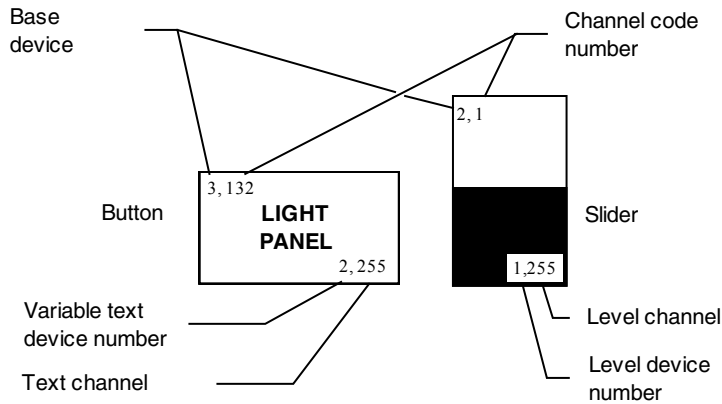

Wireless Settings for VPW-CP and VPW-GS

The WIRELESS STATUS button appears on the Setup page. The ViewPoint provides two-way RF control and provides one-way IR signaling. The ViewPoint contains a Nickel Metal Hydride rechargeable battery that supplies independent power to the touch panel. Press the WIRELESS SETTINGS button to open the page shown in Figure 121.

Figure 121

ViewPoint 2-way Wireless Settings

Note

The GROUP ID can be altered. Once changed, the value is reflected in the GROUP ID button located in the WAV-PKM page. Refer to the *Wireless status (optional WAV-PKM)* subsection for detailed information.

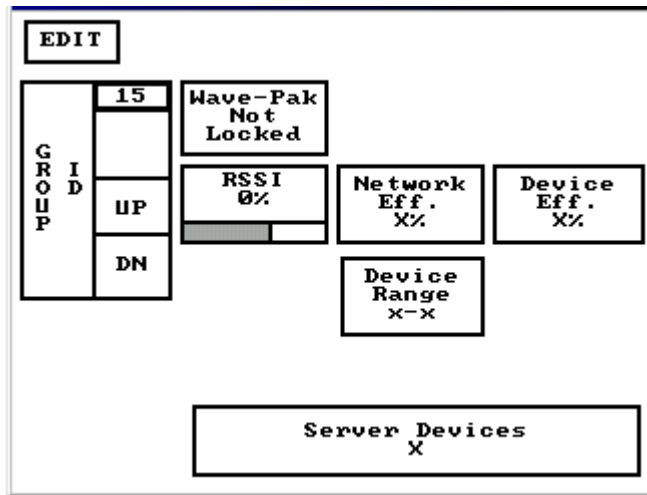

Wave-Pak not locked

Does not apply to the VPW-CP or VPW-GS touch panels.

RSSI

Radio signal strength indicator showing the relative signal strength in percent and visual horizontal bargraph.

Network Eff.

Operating efficiency (shown in percentage) of the current network which the VPW-CP or VPW-GS is a part of.

Device Eff.

Operating efficiency (shown in percentage) of the VPW-CP or VPW-GS.

Device range

Indicates the assignable device number range (for RF operation) available for the ViewPoint.

Server devices

Identifies the device numbers of the devices communicating with the AXR-WAVES WaveServer.

Wireless settings (optional SMT-PKM)

Press the WIRELESS SETTINGS button that appears in the Protected Setup page to opens the Wireless Settings page (Figure 122) for the Smart-Pack. The radio frequency and infrared buttons can be modified on-screen and can work together. Refer to the *Wireless status* subsection for detailed information of the buttons in Figure 122.

Figure 122

Wireless Settings page for SMT-PKM

Note

The AMX RF and AMX IR can function simultaneously. Refer to the *Wireless status (optional SMT-PKM)* subsection for detailed information.

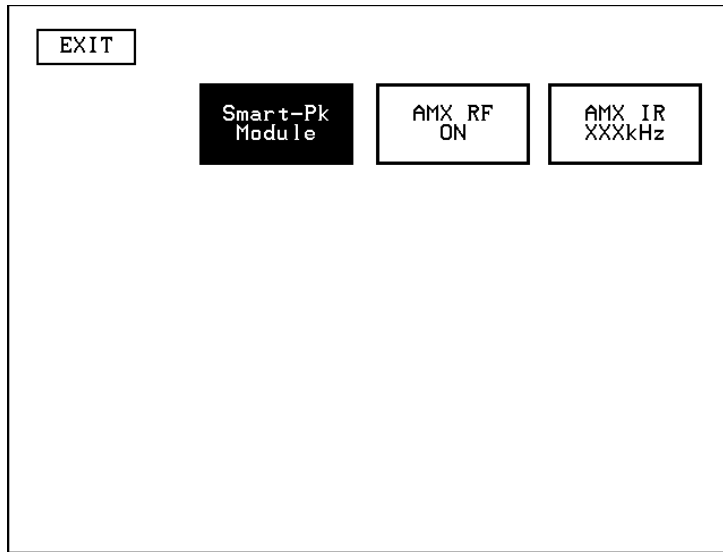

Edit button

Press EDITOR in the Protected Setup page to enable EDIT mode. The Protected Setup page remains open until you press EXIT. Then, the EDIT button appears on every page. The flowchart in Figure 123 shows the sequence to activate EDIT mode.

Figure 123

EDIT mode activation flowchart

Note

You can use the QUIT EDITOR button to exit the Edit mode and avoid re-entering the Protected Setup page.



Press EDITOR to activate Edit mode (Figure 124). Press EXIT twice to return to the Main page.

Figure 124

Enabled EDITOR button in the Protected Setup page

Note

The position of the EDIT button depends on whether you have, at any time, selected MOVE EDIT from the PAGE menu. Refer to the *Move edit* subsection for detailed information.

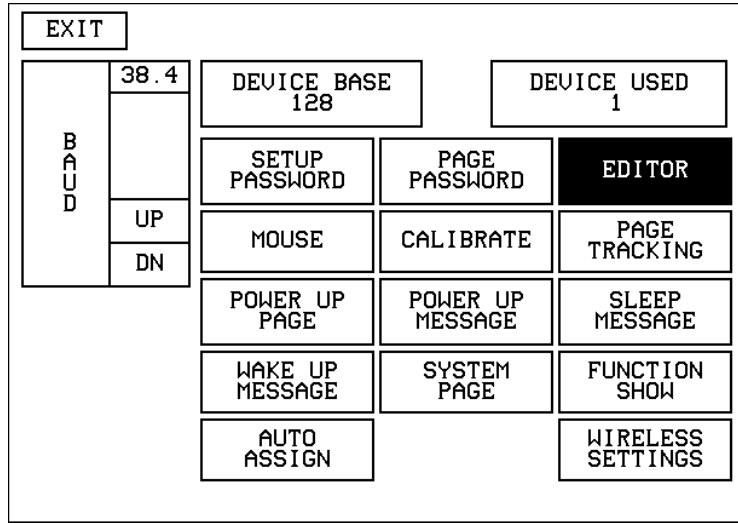

When the Edit mode is enabled, the EDIT button (Figure 125) appears on the top or bottom of each touch panel page.

Figure 125

Edit mode

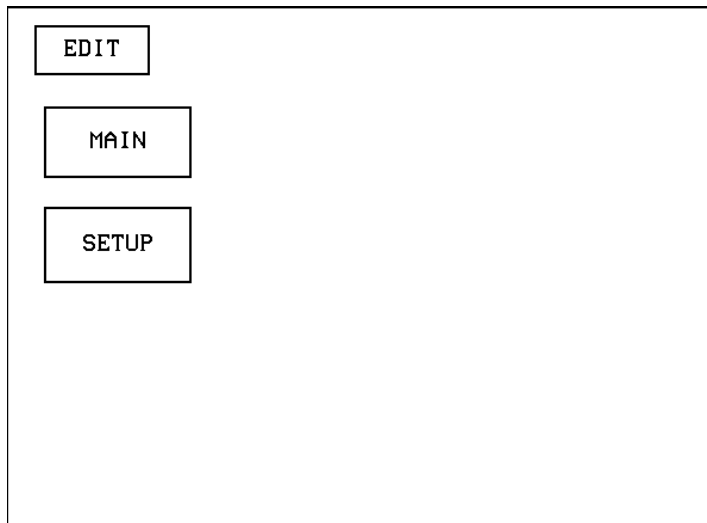

Edit Bar - Button Menu Options

Press EDIT to open the Edit bar and press BUTTON to open the Button menu shown in Figure 126.

Figure 126

Edit bar — BUTTON menu

EXIT	BUTTON	PAGE	NEW PAGE	QUIT EDITOR
	ADD			
	COPY IMAGE			
	MOVE			
	RESIZE			
	DELETE			
	TEXT/IMAGE			
	PROPERTIES			
	SAVE			
	PASTE			
	SAVE DEFAULT			
	SET DEFAULT			
	PUT ON TOP			

Note

Buttons with Unicode fonts can only be created and edited within TPDesign3, then imported to the touch panel.

You can use the BUTTON menu to create, configure, and revise touch panel button settings. Buttons containing usable fonts cannot have their text or images altered because their code is locked. The Edit bar also shows the current page name. The Edit bar in Figure 126 shows New page is the current page.

Add

Press ADD to add a button when the ADD BUTTON operation bar (Figure 127) appears on the LCD. The first touch point is the upper-left corner of the button.

Figure 127

ADD BUTTON operation bar

EXIT	Touch & Drag to ADD BUTTON
------	----------------------------

Note

You can adjust the button position with the MOVE and RE-SIZE operation bars.

Drag your finger horizontally across the screen and down to set the height and width of the button. When the new button appears on the page, the message bar shows you the X/Y page-position coordinates and the X/Y resolution size.

Press the EXIT button in the Edit bar to exit. Use the PROPERTIES operation bar to set the button color, border style, and configuration settings.

Copy image

Press COPY IMAGE to copy an existing button onto a touch panel page when the COPY BUTTON operation bar (Figure 128) appears.

Figure 128

COPY BUTTON operation bar

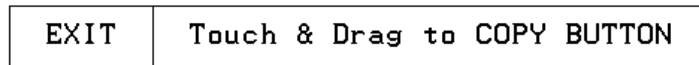

Touch the target button and drag the new button to another position. When you start dragging the new button, the message bar shows you the current X/Y page-position coordinates and the X/Y resolution size. Press EXIT on the COPY BUTTON operation bar to exit.

Move

Press MOVE to move a button when the MOVE BUTTON operation bar (Figure 129) appears. Then, drag the button to the new position. When you start moving the button, the message bar shows you the current X/Y page-position coordinates and the X/Y resolution size. Press EXIT on the MOVE BUTTON operation bar to exit.

Figure 129

MOVE BUTTON operation bar

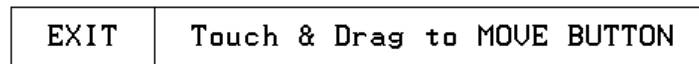

Resize

Press RESIZE to resize a button when the RESIZE BUTTON operation bar (Figure 130) appears.

Figure 130

RESIZE BUTTON operation bar

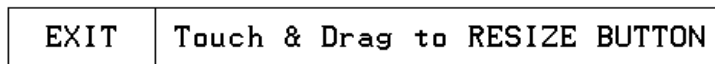

Drag your finger horizontally across the screen and down to resize the height and width of the button.

Press EXIT on the RESIZE BUTTON operation bar to exit. When you resize a button, the operation bar shows the current X/Y page-position coordinates and the X/Y resolution size. If you add text to a button, the button size must be large enough to accommodate the text string.

Delete

Press DELETE to delete a button when the DELETE BUTTON operation bar (Figure 131) appears.

Figure 131

DELETE BUTTON operation bar

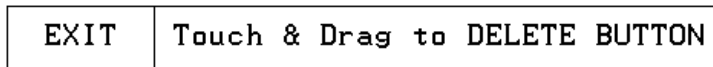

Then, touch the button you want to delete, which opens the decision box shown in Figure 132.

Figure 132

DELETE button decision box



- **YES** Deletes the button and returns to the current page.
- **NO** Cancels the deletion process and returns to the current page.

Text/image

Press TEXT/IMAGE to add text into a button. The TEXT/IMAGE operation bar shown in Figure 133 appears.

Figure 133

TEXT/IMAGE operation bar

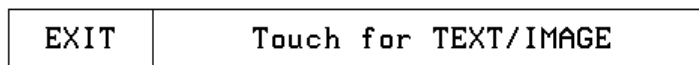

Then, press the target button to open the Text/Image page shown in Figure 134. This feature allows you to set the text, icons, and bitmap files for the current button.

Figure 134

Text/Image page

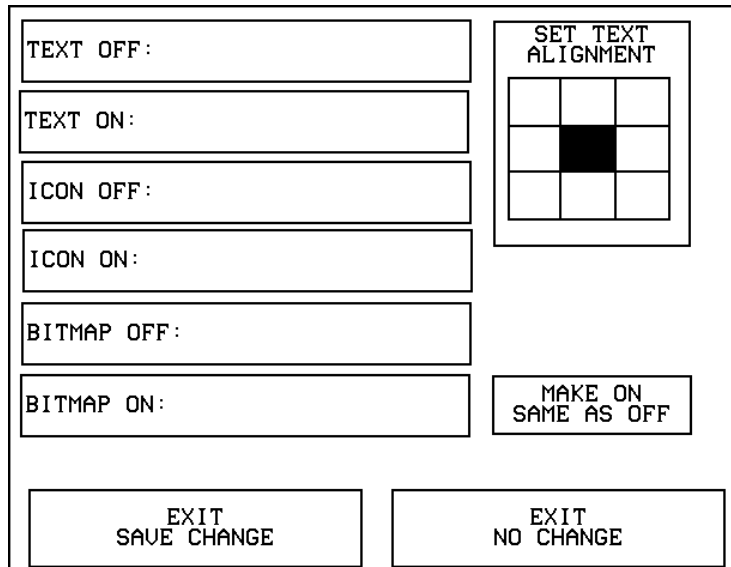

- **TEXT OFF** Opens the keyboard (Figure 135) where you enter the text to appear on the Off-state of the button.
- **TEXT ON** Opens the keyboard (Figure 135) where you enter the text to appear on the On-state of the button.

Figure 135

Keyboard

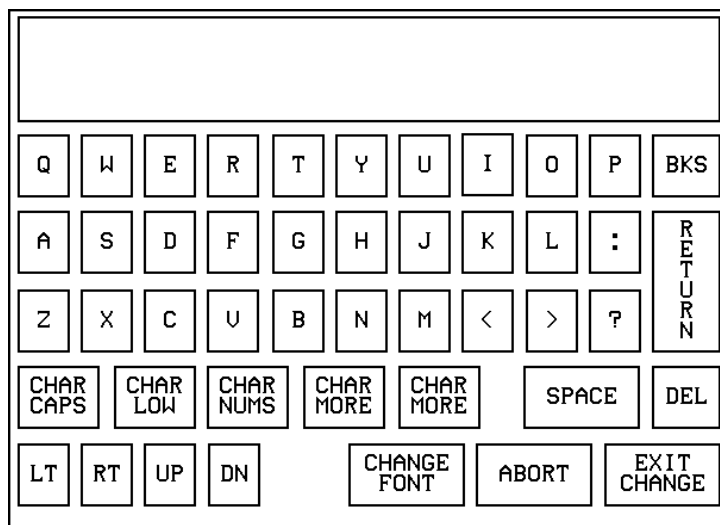

The text appears in the window at the top of the keyboard. If you exceed the space in the button, the touch panel edits the message to fit in the space provided. Change the size of the button or reduce the font size to compensate.

- CHAR CAPS Sets the keyboard to uppercase characters.
- CHAR LOW Sets the keyboard to lowercase characters.
- CHAR NUMS Sets the keyboard to numeric characters.
- CHAR MORE Toggles the keypad to special characters.
- SPACE Enters a blank space.
- DEL Deletes a space or character where the flashing cursor appears.
- LT, RT, UP, DN Moves the flashing cursor position left, right, up, and down.
- CHANGE FONT Opens the FONTS menu (Figure 136) where you can select a text font (typeface).

Figure 136

FONTS menu

Note

You can use the TPDesign3 software program to import variable fonts into the panel.

FONTS
AMX Extra Small
AMX Small
AMX Medium
AMX Large
AMX Extra Large
AMX Hollow Large
AMX Hollow Extra Large
<div style="border: 1px solid black; padding: 5px; display: inline-block;"> ABORT </div>

- ABORT Closes the FONTS menu and returns to the Text/Image page.
- EXIT CHANGE Saves current settings, closes the keyboard, and returns to the Text/Image page.
- **ICON OFF** Opens the ICONS menu (Figure 137) where you can select an icon to appear on the Off-state button. Select MORE to view more icons or ABORT to exit and return to the Text/Image page.
- **ICON ON** Opens the ICONS menu (Figure 137) where you can select the icon to appear on the On-state button. Select MORE to view more icon files, or the ABORT button to exit and return to the Text/Image page.

Figure 137

ICONS menu

ICONS	
NONE	
Cass	
CDP	
LDP	
UCR	
DSS (Blank)	
DUD (Blank)	
Tuner	
Phone	
DAT (Blank)	
MORE	ABORT

- **BITMAP OFF** Opens the BITMAPS menu (Figure 138) where you can select the bitmap to appear on the Off-state of the button. Select MORE to view more bitmap files or ABORT to exit and return to the Text/Image page.
- **BITMAP ON** Opens the BITMAPS menu (Figure 138) where you can select the bitmap to appear on the On-state of the button. Select MORE to view more bitmap files or ABORT to exit and return to the Text/Image page.

Figure 138

BITMAPS menu

BITMAPS	
NONE	
Pffds32 . bmp	
Wfds32 . bmp	
P32 . bmp	
Cass . bmp	
Cdp . bmp	
Ldp . bmp	
Ucr . bmp	
Tuner . bmp	
Phone . bmp	
MORE	ABORT

- **SET TEXT ALIGNMENT** Sets the text alignment on a button. Figure 139 shows the SET TEXT ALIGNMENT menu textually for each button. The text references do not appear on the actual Set Text Alignment page.

Figure 139

Set Text Alignment page

SET TEXT ALIGNMENT		
-Top- Left	-Top- Center	-Top- Right
-Middle- Left	-Middle- Center	-Middle- Right
-Bottom- Left	-Bottom- Center	-Bottom- Right

- **MAKE ON SAME AS OFF** Copies the Off-state text, icon, and/or bitmap settings to the On-state buttons.
- **EXIT SAVE CHANGE** Saves the current settings, exits the Text/Image page, and returns to the current page.
- **EXIT NO CHANGE** Cancels the current settings and returns to the current page.

Properties

Select PROPERTIES and a button to open the Properties page (Figure 140). Then, you can set the border style, channel/variable options, button type, button options, flip type, string, and channel Off/On attributes.

Figure 140

Properties page

BORDER	CHANNEL	VAR TEXT
	DEV: 1	DEV: 1
	CHAN: 0	CHAN: 0
BUTTON TYPE: GENERAL		
BUTTON OPTIONS: NONE		
FLIP STANDARD	NONE	
STRING:		
CHANNEL OFF		
BORDER	FILL	TEXT
COLOR		
BORDER	FILL	TEXT
CHANNEL ON		
BORDER	FILL	TEXT
EXIT SAVE CHANGE		EXIT NO CHANGE

- **BORDER** Opens the BUTTON BORDER menus (Figure 141) where you can select the border style. Figure 142 shows border names and styles.

Figure 141

BUTTON BORDER menus











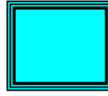

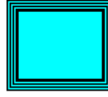









Note

This feature doesn't apply to external pushbuttons.

BUTTON BORDER		**BUTTON BORDER**			**BUTTON BORDER**	
NO BORDER		DOUBLE LINE 2			3D RECTANGLE 1	
NO BORDER SPECIAL		DOUBLE LINE 3			3D RECTANGLE 2	
SINGLE LINE		DOUBLE SHADOW			3D ROUND 1	
DOUBLE LINE		3D RECTANGLE 1			3D ROUND 2	
TRIPLE LINE		3D RECTANGLE 2			3D NEON 1	
SINGLE ROUNDED		3D ROUND 1			3D NEON 2	
DOUBLE ROUNDED		3D ROUND 2			3D NEON BLUE	
SINGLE RAISED		3D NEON 1			3D NEON GREEN	
DOUBLE RAISED		3D NEON 2			SINGLE DIAMOND	
TRIPLE RAISED		3D NEON BLUE			DOUBLE DIAMOND	
<input type="button" value="MORE"/> <input type="button" value="ABORT"/>		<input type="button" value="MORE"/> <input type="button" value="PREV"/> <input type="button" value="ABORT"/>			<input type="button" value="PREV"/> <input type="button" value="ABORT"/>	

Figure 142

Border names and styles

Border names and styles					
Name	Style	Name	Style	Name	Style
No border		Double line 2		3D rectangle 1	
No border special		Double line 3		3D rectangle 2	
Single line		Double shadow		3D round 1	
Double line		3D rectangle 1		3D round 2	
Triple line		3D rectangle 2		3D neon 1	
Single rounded		3D round 1		3D neon 2	
Double rounded		3D round 2		3D neon blue	
Single raised		3D neon 1		3D neon green	

Border names and styles (Cont.)

Name	Style	Name	Style	Name	Style
Double raised		3D neon 2		Single diamond	
Triple Raised		3D neon blue		Double diamond	

Note

All new buttons are automatically set to Double-Raised.

The channel code allows a button to have ACCESS code statements like Push and Release associated with specific functions. Figure 143 shows the relationship between the device and channel numbers. Each device can have a channel range from 1 to 255 per device.

Figure 143

Device and channel assignments

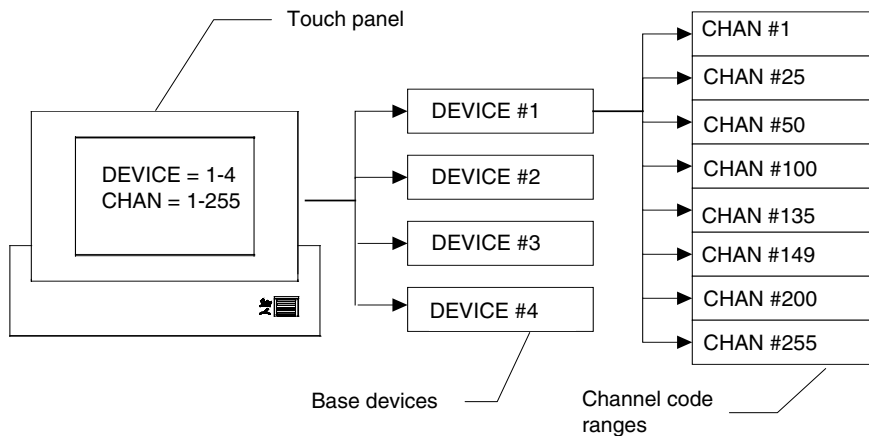

Note

To use channels for DEV 2 through 4, DEVICE USED on the Protected Setup page must be set to 2 through 4 respectively. Refer to the Protected Setup Page: Device used subsection for more information.

Note

If the value in the DEVICE USED button is set to 4 and Base Device Number is 128, the Central Controller recognizes bus devices 128, 129, 130, and 131.

- CHANNEL – DEV** Opens the keypad where you set the device number for the current button or touch panel page. Referred to as the Base device number, the device range (from 1-4) doesn't represent actual hardware devices but instead provides up to four different touch panel bus devices that can be assigned with channel values from 1 through 255..
- CHANNEL – CHAN** Opens the keypad where you set the channel code for the current button. The channel code range is from 1 through 255. Record the channel code settings if you want to create duplicate buttons and functions on another page. If AUTO ASSIGN is enabled in the Protected Setup page, the touch panel prompts you to automatically or manually assign the channel code. Select YES to allow the touch panel to assign the lowest unused channel number. Referred to as the channel code number and represents the button channel assignments recognized by the Central Controller.

As shown in Figure 144, the upper-left corner of a button shows a base device number followed by a channel code number. The bottom-right corner of a button shows the variable text number followed by the variable text channel.

Figure 144

Function show button and slider example

Note

Refer to the *Function show* subsection for more information.

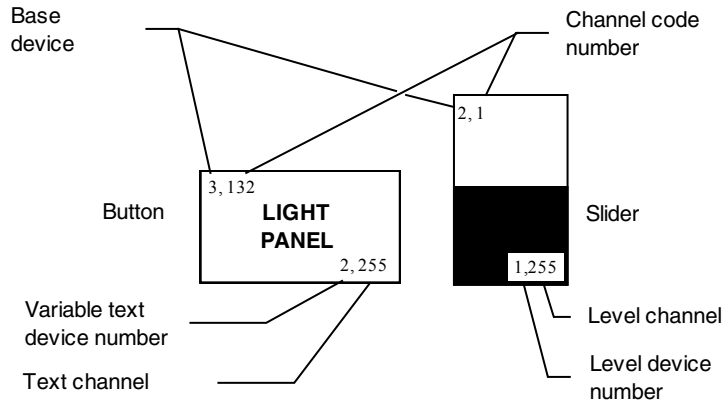

Note

G3 firmware allows up to 1020 button combinations.

The G3 firmware is designed to allow you up to 255 channels per device layer.

- **VAR TEXT – DEV** Opens the keypad where you set the device number for the current button and touch panel page. The device range is 1 through 4.
- **VAR TEXT – CHAN** Opens the keypad where you set the variable text channel code for the current button. The channel code range is from 1 through 255. Record the channel code settings if you want to create duplicate buttons and their functions on another page. If AUTO ASSIGN is enabled in the Protected Setup page, the touch panel prompts you to automatically or manually assign the channel code. Select YES to allow the touch panel to automatically assign the lowest available channel number.
- **LEVEL – DEV** Opens the keypad where you set the device number for the current button and touch panel page. The device range is 1 through 4.
- **LEVEL – NUM** Opens the keypad where you set the number codes for the current button. The number code range is 1 through 8 except for bargraphs and joysticks, where the range is from 1 through 7. Joysticks actually use two level numbers. The first is for the X-axis and the second is for the Y-axis. You only need to specify the first level. Record the channel code settings if you want to create duplicate buttons and their functions on another page.
- **BUTTON TYPE** Opens the BUTTON TYPE menus (Figure 145) where you select the button type. After you select a button type, the Properties page resets with specific options according to that button type. For example, if you

Note

Level settings apply only to Joystick buttons (Joystick and Video Joystick button types), and Bargraph buttons (Horizontal and Vertical Bargraph button types).

select the button type GENERAL, the BUTTON OPTIONS, FLIP, and STRING operation bars appear in the Properties page.

Figure 145

BUTTON TYPE menus

BUTTON TYPE		**BUTTON TYPE**	
GENERAL		TIME	
JOYSTICK		DATE	
VERTICAL BARGRAPH		KEYPAD	
HORIZONTAL BARGRAPH		KEYBOARD	
BRIGHTNESS		SETUP	
TIME		VIDEO SETUP	
DATE		VIDEO WINDOW	
KEYPAD		VIDEO JOYSTICK	
KEYBOARD		RGB SETUP	
SETUP		PROTECTED	
<input type="button" value="MORE"/> <input type="button" value="ABORT"/>		<input type="button" value="PREV"/> <input type="button" value="ABORT"/>	

For a description of each button type, refer to the *Properties Page-Button Types* subsection.

- BUTTON OPTIONS** Opens the BUTTON OPTION menu, in which you set the button feedback. The contents of the BUTTON OPTION menu will change depending on the type of button selected. For example, the options for a joystick button include parameters that are associated specifically with using a joystick button. Figure 146 shows the BUTTON OPTION menu for a General button.

Figure 146

BUTTON OPTION - General menu

BUTTON OPTION
NONE
CHANNEL
INVERTED CHANNEL
GREY CHANNEL
ALWAYS ON
MOMENTARY
BLINK
<input type="button" value="ABORT"/>

- NONE Sets the button feedback off. This selection also sets the button border, fill, or text colors to match the CHANNEL OFF color palette in the Properties page.
- CHANNEL Sets the button border, fill, or text colors to match the CHANNEL ON color palette in the Attributes page when the assigned button function is on.
- INVERTED CHANNEL Sets the button border, fill, or text colors to match the CHANNEL ON color palette in the Properties page when the assigned button function is off.
- GREY CHANNEL Sets button feedback color to gray.
- ALWAYS ON Sets the button feedback on. This selection also sets the button border, fill, or text colors to match the CHANNEL ON color palette in the Properties page.
- MOMENTARY Sets the button border, fill, or text colors to match the CHANNEL ON color palette in the Properties page when you touch the button regardless of the assigned function.
- BLINK Sets the button to toggle between on and off states.
- **FLIP <FLIP TYPE>** Opens the PAGE FLIP TYPE menu (Figure 147) where you set the page flip action for the button. Press ABORT to close the menu.

Figure 147

PAGE FLIP TYPE menu

Note

You must use the TPDesign3 program to create and download popup pages to the touch panel.

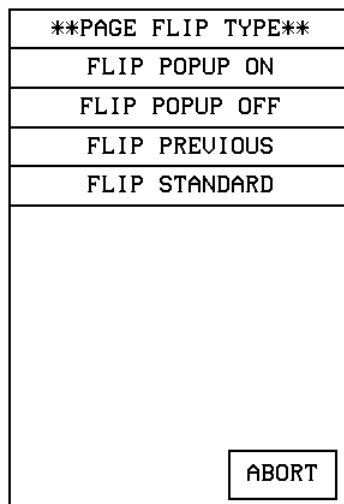

- FLIP POPUP ON Sets the button action to open a popup page. Select the FLIP menu button (Figure 148) to open the POPUP PAGE menu (Figure 149) and select a popup page.

Figure 148

Page FLIP menu buttons



- FLIP POPUP OFF Sets the button action to close a popup page. Select the FLIP menu button (Figure 148) to open the POPUP PAGE menu (Figure 149) and select a popup page to close.

Figure 149

POPUP PAGE menu

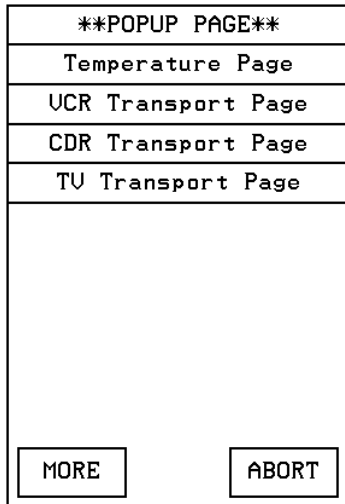

- FLIP PREVIOUS Sets the button action to open the previous touch panel page on the panel.
- FLIP STANDARD Sets the button action to open a touch panel page. Use the FLIP menu button to open the PAGE menu (Figure 150), and select the target touch panel page.

Figure 150

PAGE menu

PAGE	
NONE	
Main Page	
Page 1 (Camera)	
Page 2 (Spa)	
Page 3 (Stereo System)	
Page 4 (Surr. Sound)	
Page 5 (UCR 1)	
Page 6 (UCR 2)	
Page 7 (UCR 3)	
Page 8 (UCR 4)	
MORE	ABORT

- **STRING** Opens the keyboard where you enter the data string to be sent to the Central Controller via AXlink or RF communications. The data string appears in the STRING button. Press ABORT to close the menu.
- **CHANNEL OFF and CHANNEL ON COLOR** Sets the border, fill, and text colors for the button's Off and On states. Press the BORDER, FILL, and TEXT buttons to open the color palette shown in Figure 151. Select a color to set the channel colors and return to the PROPERTIES page. The new color appears on the associated button attribute on the PROPERTIES page.

Figure 151

Color palette

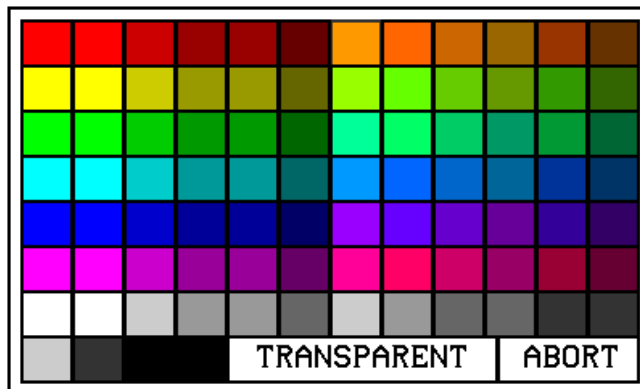

- **TRANSPARENT** Sets the button to appear transparent on the touch panel page.
- **ABORT** Closes the color palette and returns to the PROPERTIES page.

- **EXIT SAVE CHANGE** Closes the PROPERTIES page, saves the new settings, and returns to the current touch panel page.
- **EXIT NO CHANGE** Closes the PROPERTIES page, ignores the new settings, and returns to the current touch panel page.

Save

Press SAVE and a button to copy the button attributes into memory. You can then paste the button in the current page or on another page.

Paste

Press PASTE and the touch panel screen to paste the button saved with the Save option.

Save default

Press SAVE DEFAULT to open the EFFECT WHAT menu shown in Figure 152. Then, select a default option to store in touch panel memory. The stored default settings are automatically used for all new buttons, and can be applied to existing buttons using the SET DEFAULT option.

Figure 152

EFFECT WHAT menu

EFFECT WHAT	
COLOR	
BORDER	
SIZE	
COLOR & BORDER	
ALL	
<table border="1"> <tr> <td>ABORT</td> </tr> </table>	ABORT
ABORT	

Note

The non-color ViewPoint will display gray shades for selection.

- **COLOR** Select this option and a button to store the default color in touch panel memory. The default color is automatically applied to all new buttons.

- BORDER Select this option and a button to store the default border in touch panel memory. The default border is automatically applied to all new buttons.
- SIZE Select this option and a button to store the button size in touch panel memory. Then, use the SET DEFAULT option to automatically resize a button to the default size.
- COLOR & BORDER Select this option and a button to store the default color and border in touch panel memory. The default color and border is automatically applied to all new buttons.
- ALL Select this option and a button to store the default color, border, and size in touch panel memory. These default settings are automatically applied to all new buttons.

Set default

Press the SET DEFAULTS option and a button to automatically reset the button's color, border, and size according to the default settings stored in touch panel memory. You can use the SAVE DEFAULTS option to store new default settings in touch panel memory.

Put on top

Press PUT ON TOP and a select button to place the button in front of another button on the current panel page. This option is useful when constructing multi-layered buttons.

Properties Page - Button Types

The following paragraphs describe the Button Properties page for each button type. The available button types and a brief description of each are listed in Figure 153.

Note

Video applications do not apply to the MCP touch panels.

Figure 153

Button Types and descriptions

Button Types	
Button Type	Description
General	Sets the button to automatically send a message to the Central Controller via the AXlink connector, PC via the RS-232 connector, or with WAVE wireless communication.
Joystick	Sets the button to a joystick that includes a control stick. When you move the control stick, the touch panel sends feedback (data) to the Central Controller and to the external device to perform a pre-programmed operation.

Button Types (Cont.)

Button Type	Description
Vertical Bargraph	Sets the button to a vertical bargraph or slider. Feedback for bargraph or slider response comes from the Central Controller.
Horizontal Bargraph	Sets the button to a horizontal bargraph or slider. Feedback for bargraph or slider response comes from the Central Controller.
Brightness	Sets the button to open the BRIGHTNESS page. This page shows the color palette and brightness/contrast buttons.
Time	Displays the current time supplied by the Central Controller on the button.
Date	Displays the current date supplied by the Central Controller on the button.
Keypad	Sets the button to open the keypad so you can enter a password or value assignment.
Keyboard	Sets the button to open the keyboard so you can enter a name or string.
Setup	Sets the button to open the Setup page.
Video Setup	Sets the button to open the Video Setup page so you can set the incoming video display on the touch panel.
Video Window	Sets the button to a video window to display the incoming video signal.
Video Joystick	Sets the button to a video joystick that displays the incoming video signal, and a control stick. When you move the control stick, the touch panel sends feedback (data) to the Central Controller and to the external device to perform a pre-programmed operation.
RGB Setup	Sets the button to open the RGB Setup page so you can adjust the incoming video signal on the touch panel.
Protected	Sets the button to require correct page password entry before performing the assigned page flip.

Note

The VIDEO SETUP, VIDEO WINDOW, VIDEO JOYSTICK, AND RGB SETUP button types are not available on the MCP.

Note

A NO RGB HW button appears on this touch panel because it is not video compatible.

General

Select GENERAL from the Button Types menu to set the selected button as a General button. A General button automatically sends a message to the AXCESS Central Controller via the AXlink connector, to the PC via the RS-232 connector, or wireless receiver. The button type General and associated options appear in the PROPERTIES page as shown in Figure 154.

Figure 154

Button Properties page for a General button

BORDER	CHANNEL	VAR TEXT																											
	DEV: 1	DEV: 1																											
	CHAN: 0	CHAN: 0																											
BUTTON TYPE: GENERAL																													
BUTTON OPTIONS: NONE																													
FLIP STANDARD		NONE																											
STRING:																													
<table border="1"> <thead> <tr> <th colspan="3">CHANNEL OFF</th> <th colspan="3">COLOR</th> <th colspan="3">CHANNEL ON</th> </tr> <tr> <th>BORDER</th> <th>FILL</th> <th>TEXT</th> <th>BORDER</th> <th>FILL</th> <th>TEXT</th> <th>BORDER</th> <th>FILL</th> <th>TEXT</th> </tr> </thead> <tbody> <tr> <td></td> <td></td> <td></td> <td></td> <td></td> <td></td> <td></td> <td></td> <td></td> </tr> </tbody> </table>			CHANNEL OFF			COLOR			CHANNEL ON			BORDER	FILL	TEXT	BORDER	FILL	TEXT	BORDER	FILL	TEXT									
CHANNEL OFF			COLOR			CHANNEL ON																							
BORDER	FILL	TEXT	BORDER	FILL	TEXT	BORDER	FILL	TEXT																					
EXIT SAVE CHANGE		EXIT NO CHANGE																											

- **BUTTON OPTIONS** Opens the BUTTON OPTION menu, shown in Figure 155. Use this menu to set the feedback type. Press ABORT to close the menu.

Figure 155

BUTTON OPTION menu - General button

BUTTON OPTION	
NONE	
CHANNEL	
INVERTED CHANNEL	
GREY CHANNEL	
ALWAYS ON	
MOMENTARY	
BLINK	
<table border="1"> <tr> <td>ABORT</td> </tr> </table>	ABORT
ABORT	

- NONE Sets the button feedback Off. This option also sets the button border, fill, and text colors to match the CHANNEL OFF color palette in the PROPERTIES page.

- CHANNEL Sets the button border, fill, and text colors to match the CHANNEL ON color options in the Attributes page when the assigned button function is on.
- INVERTED CHANNEL Sets the button border, fill, and text colors to match the CHANNEL ON color options in the Properties page when the assigned button function is off.
- GREY CHANNEL Sets button feedback color to grey.
- ALWAYS ON Sets the button feedback On. This option also sets the button border, fill, and text colors to match the CHANNEL ON color options in the PROPERTIES page.
- MOMENTARY Sets the button border, fill, and text colors to match the CHANNEL ON color options in the Properties page when you touch the button regardless of the assigned function.
- BLINK Sets the button to toggle between On and Off states.
- ABORT Press ABORT to close the menu.
- **FLIP <FLIP TYPE>** Opens the PAGE FLIP TYPE menu (Figure 156) where you set the page flip action for the button. Press ABORT to close the menu.

Figure 156

PAGE FLIP TYPE menu

PAGE FLIP TYPE
FLIP POPUP ON
FLIP POPUP OFF
FLIP PREVIOUS
FLIP STANDARD
<div style="text-align: right; margin-right: 20px;"> <div style="border: 1px solid black; padding: 2px 10px;">ABORT</div> </div>

Note

You must use the TPDesign3 program to create and download popup pages to the touch panel.

- FLIP POPUP ON Sets the button action to open a popup page. Select the FLIP menu buttons (Figure 157) to open the POPUP PAGE menu (Figure 158) and select a popup page.

Figure 157

Page FLIP menu buttons

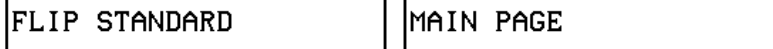

- FLIP POPUP OFF Sets the button action to close a popup page. Select the FLIP menu buttons (Figure 157) to open the POPUP PAGE menu (Figure 158) and select a popup page to close.

Figure 158

POPUP PAGE menu

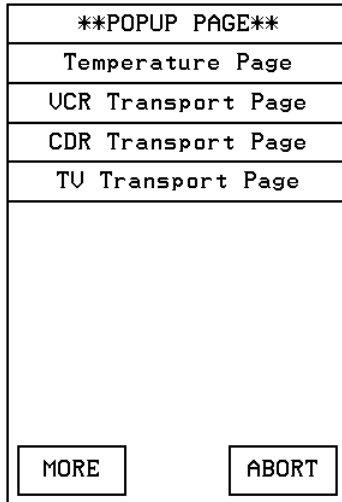

- FLIP PREVIOUS Sets the button action to open the previous touch panel page on the panel.
- FLIP STANDARD Sets the button action to open a touch panel page. Use the FLIP menu button to open the PAGE menu (Figure 159), and select the target touch panel page.

Figure 159

PAGE menu

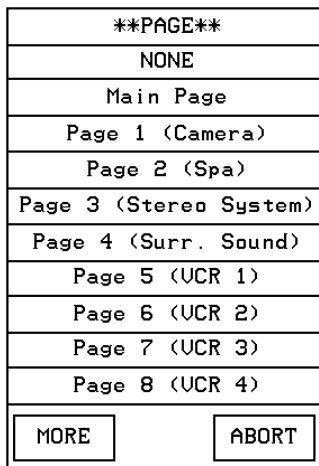

- **STRING** Opens the keyboard where you enter the data string to be sent to the Central Controller via AXlink or RF communications. The data string appears in the STRING button. Press ABORT to close the menu.

For a description of the other items in the Button Properties: GENERAL page, refer to the *Properties* subsection.

Joystick

Select JOYSTICK from the Button Types menu to set the selected button as a Joystick button. The button type JOYSTICK and associated options appear in the Button Properties page as shown in Figure 160.

Figure 160

Button Properties page for a Joystick button

Note

One-way ViewPoints do not support bargraphs, sliders, joysticks, VGA, video, variable text, or variable text.

BORDER	CHANNEL		LEVEL		
	DEV: 1		DEV: 1		
	CHAN: 0		NUM: 0		
BUTTON TYPE: JOYSTICK					
BUTTON OPTIONS: JOYSTICK CENTER					
STRING:					
CHANNEL OFF		COLOR	CHANNEL ON		
BORDER	FILL	TEXT	BORDER	FILL	TEXT
EXIT SAVE CHANGE			EXIT NO CHANGE		

- **BUTTON OPTIONS** Opens the BUTTON OPTION menu(Figure 161) where you set the joystick button type. Press ABORT to close the menu.

Vertical Bargraph

Select VERTICAL BARGRAPH from the Button Types menu to set the selected button as a Vertical Bargraph button (VPW-CP/VPW-GS only). The button type VERTICAL BARGRAPH and associated options appear in the Button Properties page as shown in Figure 162.

Figure 162

Button Properties page for a Vertical Bargraph button

BORDER	CHANNEL			LEVEL		
	DEV: 1			DEV: 1		
	CHAN: 0			NUM: 0		
BUTTON TYPE: VERTICAL BARGRAPH						
BUTTON OPTIONS: BARGRAPH ACTIVE						
STRING:						
CHANNEL OFF		COLOR		CHANNEL ON		
BORDER	FILL	TEXT	BORDER	FILL	TEXT	
EXIT SAVE CHANGE				EXIT NO CHANGE		

Note

One-way ViewPoints do not support bargraphs, sliders, joysticks, VGA, video, variable text, or variable text.

- **BUTTON OPTIONS** Opens the BUTTON OPTION menu (Figure 163) where you set the button type. Press ABORT to close the menu.

Figure 163

BUTTON OPTION menu

BUTTON OPTION	
BARGRAPH DISPLAY	
BARGRAPH ACTIVE	
BARGRAPH CENTERING	
SLIDER DISPLAY	
SLIDER ACTIVE	
SLIDER CENTERING	
BATTERY VOLTAGE	
<table border="1"> <tr> <td>ABORT</td> </tr> </table>	ABORT
ABORT	

- BARGRAPH DISPLAY Sets the bargraph as a vertical indicator for external devices. Indicator levels must be defined in the AXCESS software program.
- BARGRAPH ACTIVE Sets the bargraph as a vertical controller for external devices. Indicator levels must be defined in the AXCESS software program. When a control level is set on the vertical bargraph, control data is sent to the Central Controller to control an external device.
- BARGRAPH CENTERING Sets the bargraph as a vertical controller with a default control level. Levels must be defined in the AXCESS software program. When a control level change is sent to the Central Controller, the external device changes accordingly until the control data input stops. Then the control level on the vertical bargraph returns to the default position and the external device returns to a default control position.
- SLIDER DISPLAY Sets the slider as a horizontal status indicator for external devices. Levels must be defined in the AXCESS software program.
- SLIDER ACTIVE Sets the slider as a controller for external devices. Control levels must be defined in the AXCESS software program. When a control level is set on the vertical bargraph, data is sent to the Central Controller to control an external device.
- SLIDER CENTERING Sets the slider as a horizontal controller with a default control level. Control levels must be defined in the AXCESS software program. When a control level change is sent to the Central Controller, the external device changes accordingly until the control data input stops. Then the control level on the bargraph returns to the default position and the external device returns to its default control position.
- BATTERY VOLTAGE Sets the button to show the voltage level of the battery (if equipped).
- **STRING** Opens the keyboard where you enter the data string to be sent to the Central Controller via AXlink or RF communications. The data string appears in the STRING button. Press ABORT to close the menu.

For a description of the other items in this page, refer to the *Properties* subsection.

Horizontal Bargraph

Select HORIZONTAL BARGRAPH from the Button Types menu to set the selected button as a Horizontal Bargraph button (VPW-CP/VPW-GS only). The button type HORIZONTAL BARGRAPH and associated options appear in the Button Properties page as shown in Figure 164.

When a control level is set on the horizontal bargraph, control data is sent to the Central Controller to control an external device.

- **BARGRAPH CENTERING** Sets the bargraph as a vertical controller with a default control level. Levels must be defined in the AXCESS software program. When a control level change is sent to the Central Controller, the external device changes accordingly until the control data input stops. Then the control level on the horizontal bargraph returns to the default position and the external device returns to a default control position.
- **SLIDER DISPLAY** Sets the slider as a horizontal status indicator for external devices. Levels must be defined in the AXCESS software program.
- **SLIDER ACTIVE** Sets the slider as a controller for external devices. Control levels must be defined in the AXCESS software program. When a control level is set on the horizontal bargraph, data is sent to the Central Controller to control an external device.
- **SLIDER CENTERING** Sets the slider as a horizontal controller with a default control level. Control levels must be defined in the AXCESS software program. When a control level change is sent to the Central Controller, the external device changes accordingly until the control data input stops. Then the control level on the bargraph returns to the default position and the external device returns to its default control position.
- **BATTERY VOLTAGE** Sets the button to show the voltage level of the battery (if equipped).
- **STRING** Opens the keyboard where you enter the data string to be sent to the Central Controller via AXlink, RS-232, or RF communications. The data string appears in the STRING button. Press ABORT to close the menu.

For a description of the other items in this page, refer to the *Properties* subsection.

Brightness

Select BRIGHTNESS from the Button Types menu to set the selected button as a Brightness button. The button type BRIGHTNESS and associated options appear in the Button Properties page as shown in Figure 166.

Figure 166

Button Properties page for a Brightness button

BORDER	CHANNEL		
	DEV: 1		CHAN: 0
BUTTON TYPE: BRIGHTNESS			
STRING:			
CHANNEL OFF		COLOR	CHANNEL ON
BORDER	FILL	TEXT	BORDER
EXIT SAVE CHANGE		EXIT NO CHANGE	

Note

When the panel is attached to an optional battery source, a lower brightness settings information button appears in the lower right-hand of the screen.

Note

For a description of the other items in the Button Properties: Brightness page, refer to the *Properties* subsection.

Press the UP and DN buttons to set the LCD brightness and contrast on the touch panels. The Brightness page allows you to set the touch panel's LCD light level.

This sets the button to open the BRIGHTNESS page shown in Figure 167. The BRIGHTNESS page displays the color palette.

Figure 167

Brightness page

EXIT	
B R I G H T	8
	UP
	DN
C O N T R A S T	13
	UP
	DN

Note

When the panel is attached to an optional battery source, a lower brightness settings information button appears in the lower right-hand of the screen when the brightness setting exceeds 5.

The maximum Brightness level is 8 and a the maximum Contrast level is 13. The TRANSPARENT and ABORT buttons are disabled for this page.

Time

Select TIME from the Button Types menu to set the selected button as a Time button. A Time button sets the button to display the current time. The time is supplied to the button by the Central Controller. The button type TIME and associated options appear in the Button Properties page as shown in Figure 168.

Figure 168

Button Properties page for a Time button

BORDER			CHANNEL		
			DEV: 1		
			CHAN: 0		
BUTTON TYPE: TIME					
BUTTON OPTIONS: COLON BLINK					
STRING:					
CHANNEL OFF			CHANNEL ON		
BORDER	FILL	TEXT	BORDER	FILL	TEXT
EXIT SAVE CHANGE			EXIT NO CHANGE		

Set the time in the Time/Date page. To open the Time/Date page, press SET TIME AND DATE in the Setup page. Refer to *Set time and date* described in this section for more information.

- **BUTTON OPTIONS** Opens the BUTTON OPTION menu (Figure 169) that lets you set the colon blink option.

Figure 169

BUTTON OPTION menu
(Time button)

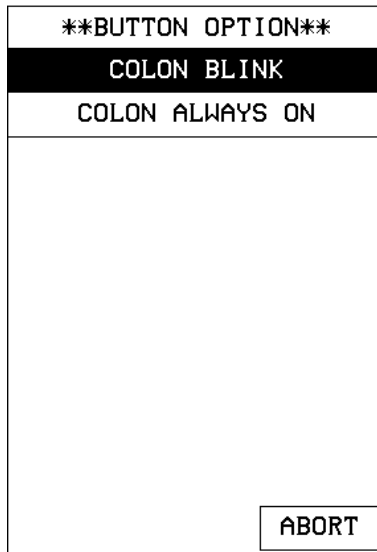

- COLON BLINK Sets the colon in the displayed time to blink once/second.
- COLON ALWAYS ON Sets the colon in the displayed time to never blink.

For a description of the other items in this page, refer to the *Properties* subsection.

Date

Select DATE from the Button Types menu to set the selected button as a Date button. A Date button displays the current date. The date is supplied to the button by the Central Controller. The button type DATE and associated options appear in the Button Properties page as shown in Figure 170.

Set the date in the Time/Date page. To open the Time/Date page, press SET TIME AND DATE in the Setup page. Refer to *Set time and date* described in this section for more information.

Figure 170

Button Properties page for a Date button

BORDER	CHANNEL					
	DEV: 1			CHAN: 0		
BUTTON TYPE: DATE						
STRING:						
CHANNEL OFF		COLOR			CHANNEL ON	
BORDER	FILL	TEXT	BORDER	FILL	TEXT	
EXIT SAVE CHANGE			EXIT NO CHANGE			

For a description of the other items in this page, refer to the *Properties* subsection.

Keypad

Select KEYPAD from the Button Types menu to set the selected button as a Keypad button. The button type KEYPAD and associated options appear in the Button Properties page as shown in Figure 171.

Figure 171

Button Properties page for a Keypad button

BORDER	CHANNEL					
	DEV: 1			CHAN: 0		
BUTTON TYPE: KEYPAD						
STRING:						
CHANNEL OFF		COLOR			CHANNEL ON	
BORDER	FILL	TEXT	BORDER	FILL	TEXT	
EXIT SAVE CHANGE			EXIT NO CHANGE			

This sets the button to open the keypad so you can enter a password or value assignment. All the keypad buttons are interactive except for the entry field.

For a description of the other items in the Button Properties: Keypad page, refer to the *Properties* subsection.

Keyboard

Select KEYBOARD from the Button Types menu to set the selected button as a Keyboard button. The button type KEYBOARD and associated options appear in the Button Properties page as shown in Figure 172.

Figure 172

Button Properties page for a Keyboard button

BORDER		CHANNEL			
		DEV: 1			
		CHAN: 0			
BUTTON TYPE: KEYBOARD					
CHANNEL OFF		COLOR		CHANNEL ON	
BORDER	FILL	TEXT	BORDER	FILL	TEXT
EXIT SAVE CHANGE			EXIT NO CHANGE		

Note

For a description of the other items in the Button Properties: Keyboard page, refer to the *Properties* subsection.

This sets the button to open the keyboard so you can enter a name or string. All the keyboard buttons are interactive except for the message field.

For a description of the keyboard page, refer to the *Keyboard* subsection.

Note

The VIDEO SETUP, VIDEO WINDOW, VIDEO JOYSTICK, AND RGB SETUP button types are not available on these touch panels.

Setup

Select SETUP from the Button Types menu to set the selected button as a Setup button. This sets the button to open the Setup page. Refer to *Setup Page* in this section for more information.

Video Setup

Select VIDEO SETUP from the Button Types menu to set the selected button as a Video Setup button. The button type VIDEO SETUP and associated options appear in the Button Properties page as shown in Figure 173.

Figure 173

Button Properties page for a Video Setup button

Note

For a description of the other items in the Button Properties: Video Setup page, refer to the *Properties* subsection.

Note

One-way ViewPoints do not support bargraphs, sliders, joysticks, VGA, video, variable text, or variable text.

BORDER	CHANNEL	
	DEV: 1	CHAN: 0
BUTTON TYPE: VIDEO SETUP		
STRING:		
CHANNEL OFF		
BORDER	FILL	TEXT
CHANNEL ON		
BORDER	FILL	TEXT
EXIT SAVE CHANGE		EXIT NO CHANGE

This sets the button to open the Video Setup page shown in Figure 174.

Figure 174

Video Setup page

Note

Without support for video, this page displays the NO VID HW button.

EXIT

NO VID HW

Video Window

Select VIDEO WINDOW from the Button Types menu to set the selected button as a Video Window button. The button type VIDEO WINDOW and associated options appear in the Button Properties page as shown in Figure 175.

Figure 175

Button Properties page for a Video Window button

BORDER	CHANNEL					
	DEV: 1			CHAN: 0		
BUTTON TYPE: VIDEO WINDOW						
FLIP STANDARD				MAIN PAGE		
STRING :						
CHANNEL OFF			COLOR	CHANNEL ON		
BORDER	FILL	TEXT	BORDER	FILL	TEXT	
EXIT SAVE CHANGE				EXIT NO CHANGE		

Note

If video capable, the incoming signal is displayed through a button, while graphics are displayed as a background color option on the page.

Note

The VIDEO SETUP, VIDEO WINDOW, VIDEO JOYSTICK, and RGB SETUP button types are not available on these touch panels.

This sets the button to display an incoming video signal; only one video input source is available.

For a description of the other items in this page, refer to the *Properties* subsection.

Video Joystick

Select VIDEO JOYSTICK from the Button Types menu to set the selected button as a Video Joystick button. The button type VIDEO JOYSTICK and associated options appear in the Button Properties page as shown in Figure 176.

Note

One-way ViewPoints do not support bargraphs, sliders, joysticks, VGA, video, variable text, or variable text.

Figure 176

Button Properties page for a Video Joystick button

BORDER	CHANNEL			LEVEL				
	DEV: 1			DEV: 1				
	CHAN: 0			NUM: 0				
BUTTON TYPE: VIDEO JOYSTICK								
BUTTON OPTIONS: JOYSTICK CENTER								
STRING:								
CHANNEL OFF			COLOR			CHANNEL ON		
BORDER	FILL	TEXT	BORDER	FILL	TEXT	BORDER	FILL	TEXT
EXIT SAVE CHANGE				EXIT NO CHANGE				

Note

The VIDEO SETUP, VIDEO WINDOW, VIDEO JOYSTICK, and RGB SETUP button types are not available on these touch panels.

Note

If the panel is video capable, the video is displayed behind the joystick display.

Sets the button to a video joystick that displays the incoming video signal, and a control stick. When you move the control stick, the touch panel sends feedback (data) to the Central Controller and to the external device to perform a pre-programmed operation, depending on the slot attribute.

- **BUTTON OPTIONS** Opens the JOYSTICK BUTTON OPTION menu, shown in Figure 177. Use this menu to set the joystick button type. Press ABORT to close the menu.

Figure 177

BUTTON OPTION menu (Video Joystick button)

BUTTON OPTION
JOYSTICK NON-CENTER
JOYSTICK CENTER
CROSSHAIR NON-CENTER
CROSSHAIR CENTER
ABORT

- JOYSTICK NON-CENTER Sets the button to a four-quadrant joystick with a control stick. When you move the control stick, the touch panel sends feedback (data) to the Central Controller and to the external device to perform a pre-programmed operation. When you release the mouse button (or other touch device), the control stick and external device stay in that position.
- JOYSTICK CENTER Sets the button to a four-quadrant joystick with a control stick located in the center. When you move the control stick, the touch panel sends feedback (data) to the Central Controller and to the external device to perform a pre-programmed operation. When you release the mouse button (or other touch device), the control stick returns to the center of the icon and the external device returns to its default position.
- CROSSHAIR NON-CENTER Sets the button to a four-quadrant crosshair with a control stick located in the center. When you move the control stick, the touch panel sends feedback (data) to the Central Controller and to the external device to perform a pre-programmed operation. When you release the mouse button (or other touch device), the control stick returns to the center of the icon and the external device returns to its default position.
- CROSSHAIR CENTER Sets the button to a four-quadrant crosshair with a control stick. When you move the control stick, the touch panel sends feedback (data) to the Central Controller and to the external device to perform a pre-programmed operation. When you release the mouse button (or other touch device), the control stick and external device stay in that position.

For a description of the other items in this page, refer to the *Properties* subsection.

RGB Setup

Select RGB SETUP from the Button Types menu to set the selected button as an RGB Setup button. The button type RGB SETUP and associated options appear in the Button Properties page as shown in Figure 178.

Figure 178

Button Properties page for a RGB Setup button

Note

For a description of the other items in the Button Properties: RGB Setup page, refer to the *Properties* subsection.

Note

The RGB Setup page acts the same as the Video Setup page, and adapts to the specific (RGB) input module.

BORDER	CHANNEL				
	DEV: 1	CHAN: 0			
BUTTON TYPE: RGB SETUP					
STRING:					
CHANNEL OFF		COLOR	CHANNEL ON		
BORDER	FILL	TEXT	BORDER	FILL	TEXT
EXIT SAVE CHANGE			EXIT NO CHANGE		

This sets the button to open the RGB Setup page so that you can adjust the incoming video signal on the touch panel.

Without RGB support, the PGB Setup page displays a NO RGB HW button (Figure 179).

Figure 179

NO RGB HW button



Protected

Select PROTECTED from the Button Types menu to set the selected button as a Protected button. The button type PROTECTED and associated options appear in the Button Properties page as shown in Figure 180.

Figure 180

Button Properties page for a Protected button

BORDER	CHANNEL				
	DEV: 1	CHAN: 0			
BUTTON TYPE: PROTECTED					
BUTTON OPTIONS: CHANNEL					
FLIP STANDARD	NONE				
STRING:					
CHANNEL OFF COLOR CHANNEL ON					
BORDER	FILL	TEXT	BORDER	FILL	TEXT
EXIT SAVE CHANGE		EXIT NO CHANGE			

This sets the button as a Protected button. Protected buttons are similar to General type buttons, except that they require the user to enter a password to flip to the specified destination page. Pressing a Protected button opens the Keypad. Use the Keypad to enter the correct password. If the correct password is entered, the page flips to the specified destination page. If the correct password is not entered, no page flip occurs.

To set the Page Password, open the Protected Setup page, and press PAGE PASSWORD. This opens the keypad. Enter the password (up to 5 digits) and press ENTER to set the Page Password. For more information on passwords, refer to the *Protected Setup Page* section.

Properties Page - External Buttons

The following paragraphs describe how to configure the External buttons in the Button Properties page. Certain features on the BUTTON menu are not applicable to external pushbuttons because they are not created by the firmware but rather are a part of the panel hardware itself. The only features that are applicable from the BUTTON menu are the TEXT/IMAGE and PROPERTIES buttons. The steps used to configure the external pushbutton's text/image are identical to those for the buttons created using the panel's firmware. Refer to the *Text/image* subsection for detailed information about associating text with a button.

External buttons

Note

You must press the external button on the panel rather than pressing a displayed button on the LCD.

External buttons are recognized by the touch panel as external button numbers. The panel recognizes eight buttons per side for total of 16 buttons. Refer to the *Button Properties* subsection for detailed information about external pushbuttons. The **BUTTON TYPE** button (Figure 181) is set to the number assigned to the external button which was pressed after the **PROPERTIES** operation bar appears. Refer to the *Setting the channel code*, *Setting the variable text code*, and *Setting the level code* subsections for detailed information on setting the device and channel numbers.

Figure 181

Button Properties page for External buttons

CHANNEL	
DEV: 1	
CHAN: 0	
BUTTON TYPE: EXTERNAL BUTTON 2	
FLIP STANDARD	NONE
STRING:	
EXIT SAVE CHANGE	EXIT NO CHANGE

- **FLIP <FLIP TYPE>** Opens the PAGE FLIP TYPE menu (Figure 182) where you set the page flip action for the button. Press **ABORT** to close the menu.

- FLIP PREVIOUS Sets the button action to open the previous touch panel page on the panel.
- FLIP STANDARD Sets the button action to open a touch panel page. Use the FLIP menu button to open the PAGE menu (Figure 185), and select the target touch panel page.

Figure 185

PAGE menu

PAGE	
NONE	
Main Page	
Page 1 (Camera)	
Page 2 (Spa)	
Page 3 (Stereo System)	
Page 4 (Surr. Sound)	
Page 5 (UCR 1)	
Page 6 (UCR 2)	
Page 7 (UCR 3)	
Page 8 (UCR 4)	
<input type="button" value="MORE"/>	<input type="button" value="ABORT"/>

- **STRING** Opens the keyboard where you enter the data string to be sent to the Central Controller via AXlink or RF communications. The data string appears in the STRING button. Press ABORT to close the menu.

Setting external button properties

1. Press EDIT, BUTTON, and PROPERTIES to open the PROPERTIES operation bar.
2. Press the target button to open the Button Properties page. The BUTTON TYPE: EXTERNAL BUTTON appears in the Properties page and can't be altered.

Refer to the *Button Properties* and *Creating a Joystick* subsections for detailed information about setting up button's properties such as channels code, flip type, and string information.

Page Menu Options

Press EDIT and PAGE to open the PAGE menu as shown in Figure 186.

Figure 186

Page menu

EXIT	BUTTON	PAGE	NEW PAGE	QUIT EDITOR
		ADD		
		COPY		
		RENAME		
		DELETE		
		PAGE COLOR		
		GO TO		
		POPUP ON		
		POPUP OFF		
		MOVE EDIT		
		SNAP GRID		

The PAGE menu includes operations to add, copy, rename, delete, change the page color, go to a page, turn popup pages on/off, move the Edit button, and snap to a grid. Press EXIT on the Edit bar to close the menu.

Add

Press ADD to add a new touch panel page. This command opens the keyboard (Figure 187) so you can name the page. The text appears in the window at the top of the keyboard. If you exceed the space in the button, the touch panel edits the message to fit in the space provided. Change the size of the button or reduce the font size to compensate.

Note

The new page must have a button with assigned attributes before it can be used.

Figure 187

Keyboard

Note

Page naming does not allow you to change the font type, as for such things as buttons.

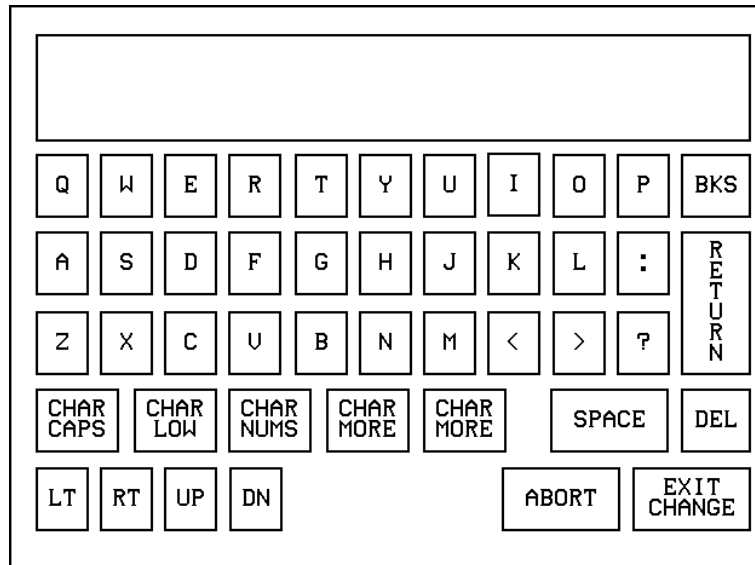

- **CHAR CAPS** Sets the keyboard to uppercase characters.
- **CHAR LOW** Sets the keyboard to lowercase characters.
- **CHAR NUMS** Sets the keyboard to numeric characters.
- **CHAR MORE** Toggles the keypad to special characters.
- **SPACE** Enters a blank space.
- **DEL** Deletes a space or character where the flashing cursor appears.
- **LT, RT, UP, DN** Moves the flashing cursor position left, right, up, and down.
- **ABORT** Cancels the current task and returns you to the previous screen.
- **EXIT CHANGE** Returns you to the previous screen while effecting the change that was made within the keyboard.

Copy

Press COPY to make a copy of the active page. This command opens the keyboard. Use the keyboard to give the copied page a new name. Press EXIT CHANGE to store the new page name in memory.

Rename

Press RENAME to rename the active page. This command opens the keyboard. Use the keyboard to rename the current page. Press EXIT CHANGE to store the new page name in memory.

Delete

Press DELETE to delete the current page. This command opens the delete message shown in Figure 188. You cannot delete the Main page or Page 1.

Figure 188

DELETE decision message



- **YES** Deletes the page and returns to the Main page.
- **NO** Cancels the deletion process and returns to the current page.

Page color

Press PAGE COLOR to open the color palette shown in Figure 189 and set the page color.

Figure 189

Color palette

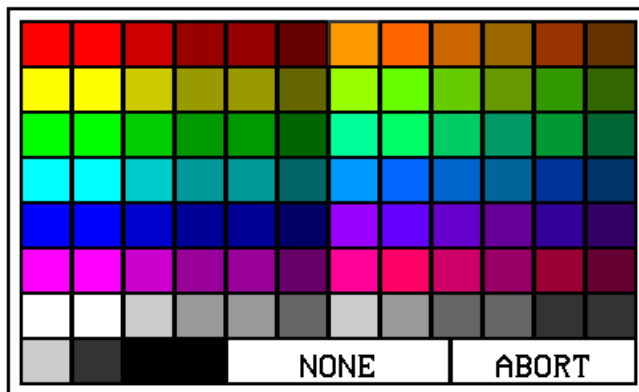

- **NONE** Sets the page color to no color.
- **ABORT** Cancels the color selection process and returns to the current page.

Go to

Press GO TO to open the PAGE GOTO menu (Figure 190) and select the target page.

Figure 190
PAGE GOTO menu

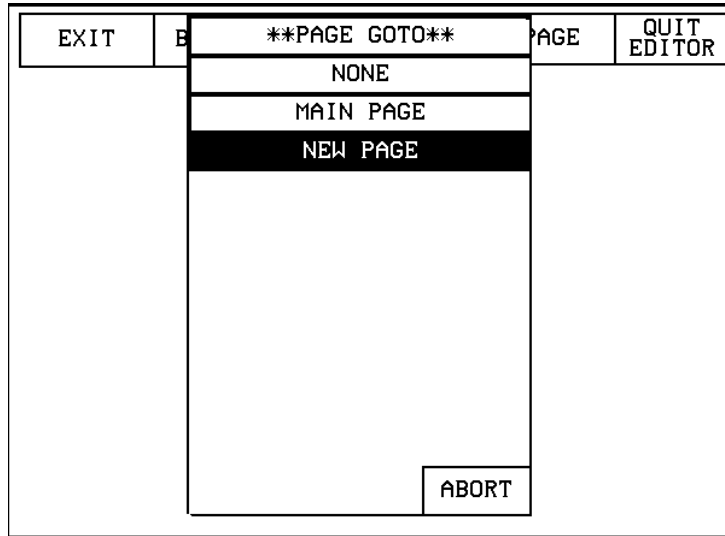

- **ABORT** Cancels the Go To process and returns to the current page.

Pressing the active page button (Figure 191) in the Edit bar will display the PAGE GOTO menu (Figure 190) where you can select a target page.

Figure 191
Edit bar showing the active page button

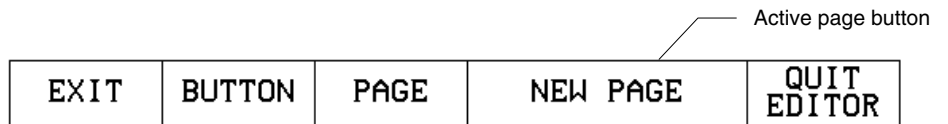

After selecting the target page, the active page button will display the current page.

Popup on

Press POPUP ON to open the POPUP ON menu shown in Figure 192. Press a popup page in the menu to open the Popup page and return to the current page.

Figure 192

POPUP ON menu

Note

Popup pages are created in TPDesign3 then downloaded into the touch panel. For detailed information on popup pages, refer to the *TPDesign3 Touch Panel Program* instruction manual.

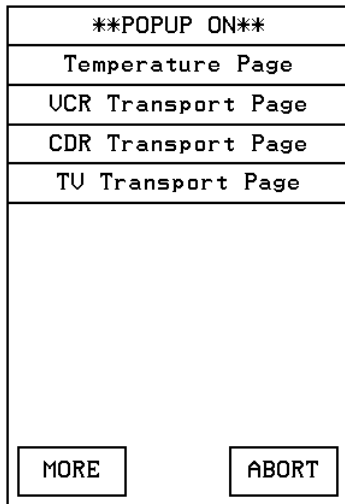

- **MORE** Provides more Popup On page choices.
- **ABORT** Cancels the POPUP ON process and returns to the current page.

Popup off

Press POPUP OFF to open the POPUP OFF menu shown in Figure 193.

Press a popup page in the menu to close the selected Popup page and return to the current page.

- **MORE** Provides more Popup Off page choices.
- **ABORT** Cancels the POPUP OFF process and returns to the current page.

Figure 193

POPUP OFF menu

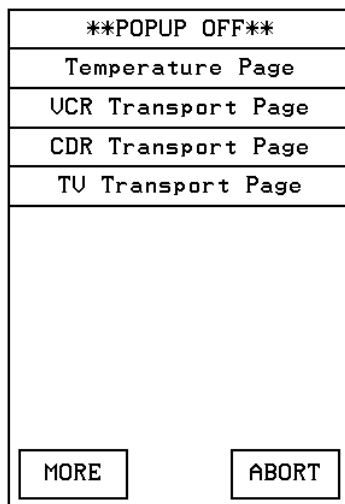

Move edit

Press MOVE EDIT in the PAGE menu to move the Edit button to the bottom of the page. Press the EDIT button to open the Edit bar as shown in Figure 194.

Figure 194

Main page after using the
MOVE EDIT button

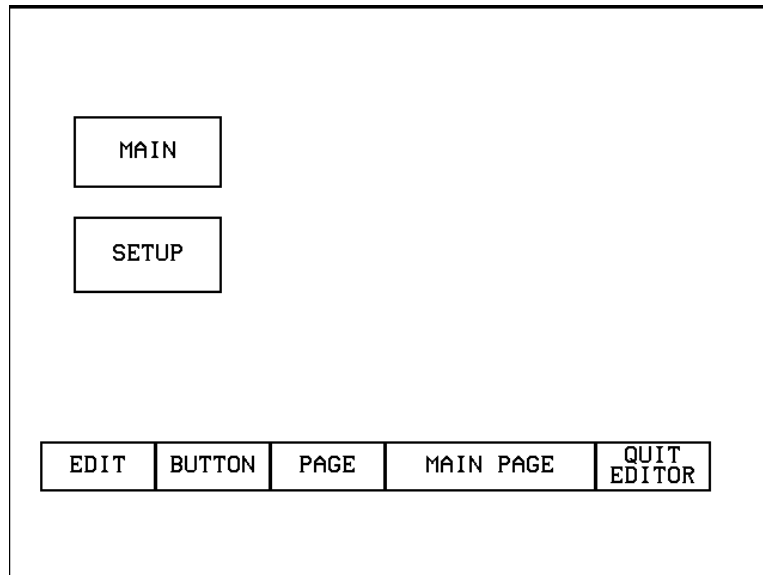

Press MOVE EDIT again to move the EDIT button back to its original position at the top of the page.

Snap grid

Press SNAP GRID to set up an invisible grid on the page. The grid allows you to easily align buttons on the page. This command opens the SNAP GRID menu shown in Figure 195.

Figure 195

SNAP GRID menu

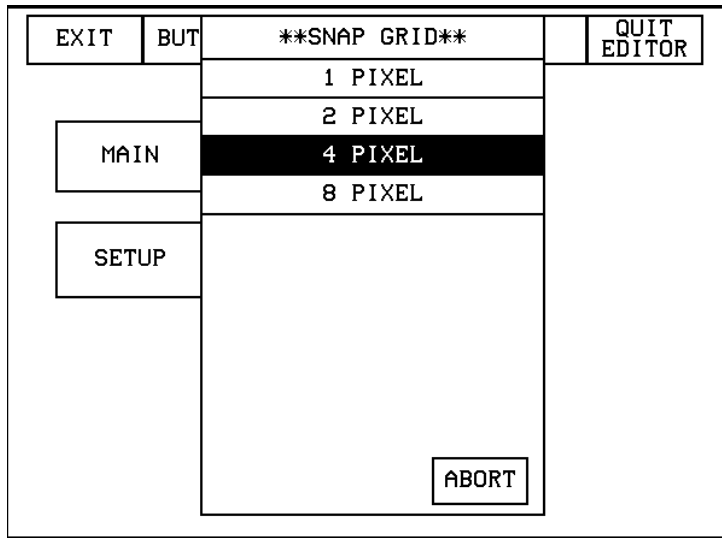

Note

The touch panel contains pixels throughout the screen. By selecting 1, 2, 4, or 8 PIXEL, the object will move by the pixel increment selected in the SNAP GRID menu.

Set the movement increment in pixels. Select 1, 2, 4, or 8 PIXEL to set the grid and return to the current page.

- **ABORT** Cancels the SNAP GRID process and returns to the current page.

Edit Bar - Quit Editor option

The QUIT EDITOR button is located on the Edit bar. This button allows you to exit the EDIT mode without having to open the Setup page, access the Protected Setup page and deactivate the EDITOR button.

1. Press EXIT to open the Edit bar shown in Figure 196.

Figure 196

Edit bar showing the QUIT EDITOR button



2. Press the QUIT EDITOR button to open the decision button shown in Figure 197.

Figure 197

Quit the On-Board Editor decision button



3. If you select YES, the page will appear as shown in Figure 198 without the Edit bar.

Figure 198

Main page without Edit bar

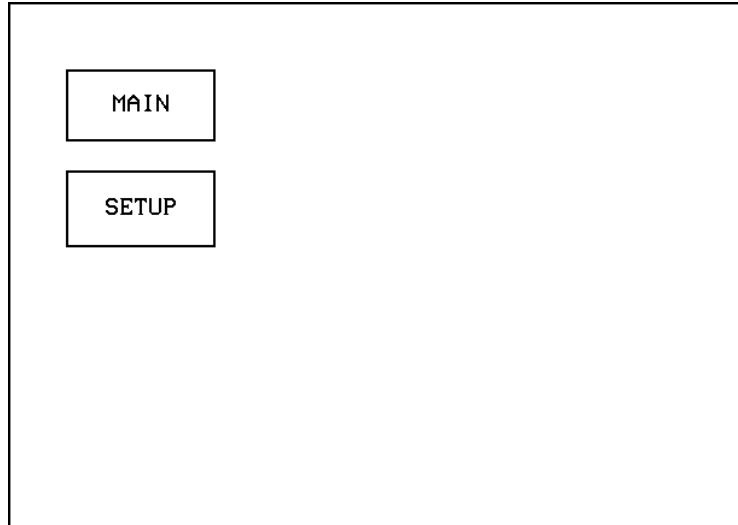

AXCESS Programming

Note

There are no programming differences between the VPT-CP and VPT-GS.

Overview

This section outlines how to connect your PC to the ViewPoint for programming the ViewPoint. Also, programming commands for the new AMX G3 software is included.

PC to ViewPoint Connections

Figure 199 shows the connections required for connecting the ViewPoint to your PC.

Figure 199

Connecting the ViewPoint to your PC

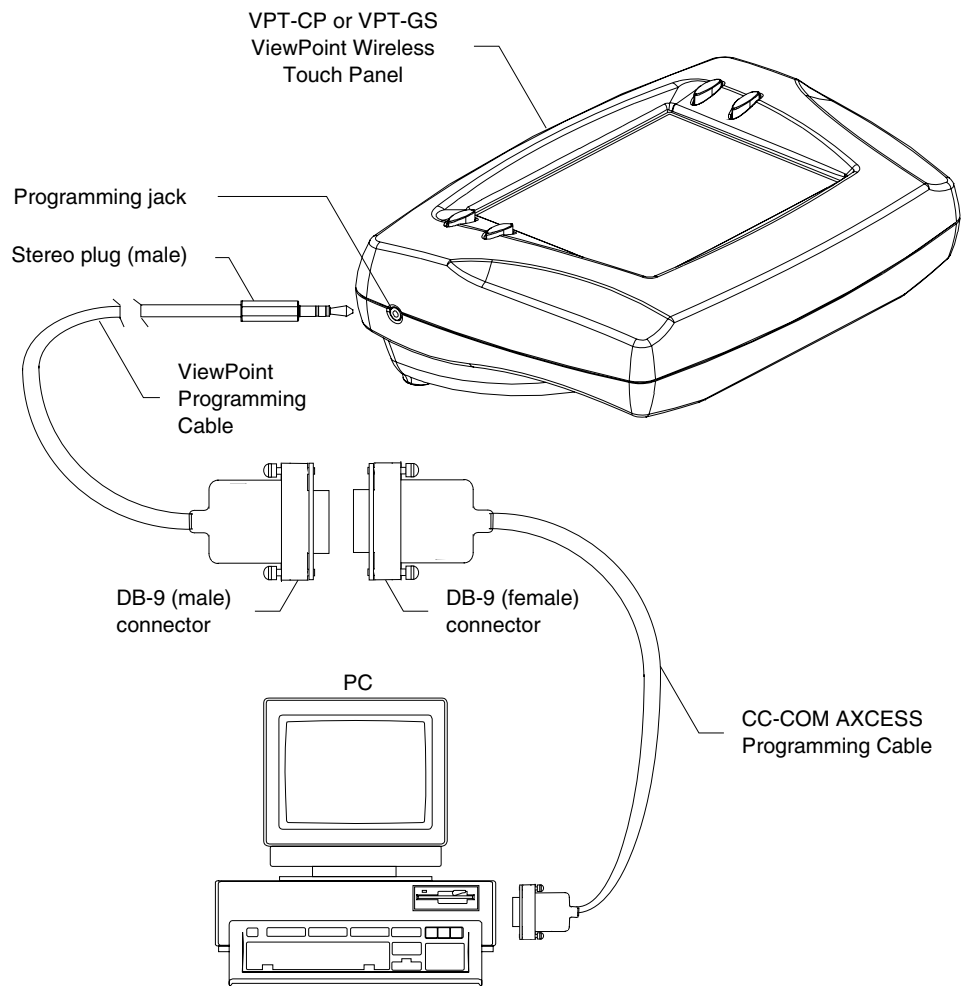

Programming the ViewPoint

You can program the ViewPoint to perform a wide variety of operations using AXCESS Send_Commands and variable text commands. Use the commands described in this section along with the *AXCESS Programming Language* instruction manual to program the ViewPoint.

AXCESS Programming Changes

The AXCESS program may need to be modified to conform to those ranges and variables set in the new version 3.xx firmware.

The following describes those version 2.xx features that have either been modified or are no longer supported within the new version 3.xx firmware:

- **E - Timer** The elapsed timer feature is not supported by the version 3.xx firmware. AXCESS code can be written to simulate this feature.
- **ICONS features** Some features within the Icons drop-down menu in the version 2.xx firmware, such as the E-Timer, 16 and 32 Char Term, are also not supported in version 3.xx.
- **SEND_COMMANDS** Figure 200 is a list of some commands that need to be adapted to conform with the new parameters and enhanced functionality present in the version 3.xx firmware.

Figure 200

Affected Send_Commands

Affected Send_Commands	
Command	Description
!C	Sets the border, font, and text in one command
!F	Shorthand version of 'FONT' command
!I	Shorthand version of 'ICON' command
CBON	Sets the ON feedback border color to the specified color
CBOFF	Sets the OFF feedback border color to the specified color
FONT	Changes the font size (or style) of the text in a specific button
ICON	Changes border style of a specific button

All other AXCESS Color and Variable text Send_Commands are listed in this section. They should be checked to verify that they comply with version 3.xx parameters and functionality.

System Send_Commands

System Send_Commands (Figure 201) are stored in the AXCESS Control System and direct the Touch Panel to perform various operations.

Figure 201

System Send_Commands

System Send_Commands	
Command	Description
" 'ABEEP' "	<p>Output one panel beep even if the Beep value is set to 0 in the Setup page.</p> <p>Example:</p> <pre>SEND_COMMAND TP, " 'ABEEP' "</pre> <p>Beeps the panel.</p>
" 'ADBEEP' "	<p>Output a double-beep even if the double beep value is set to 0 in the Setup page.</p> <p>Example:</p> <pre>SEND_COMMAND TP, " 'ADBEEP' "</pre> <p>Double-beeps the panel.</p>
" 'AKEYB-<text string>' "	<p>Open the touch panel keyboard and initialize the text string entry. The keyboard string is set to null during power-up and is stored until power-down.</p> <p><text string> = 0 - 59 characters</p> <p>Example:</p> <pre>SEND_COMMAND TP, " 'AKEYB-TOUCH HERE' "</pre> <p>Opens the touch panel keyboard with TOUCH HERE in the display.</p>
" 'AKEYP-<number string>' "	<p>Open the touch panel keypad and initialize the number string entry. The keypad string is set to null during power-up and is stored until power-down.</p> <p><number string> = 0 - 9999</p> <p>Example:</p> <pre>SEND_COMMAND TP, " 'AKEYP-1988' "</pre> <p>Opens the touch panel keypad with 1988 in the display.</p>

System Send_Commands (Cont.)

Command	Description
" 'AKEYR' "	<p>Close the touch panel keyboard or keypad opened with the 'AKEYB', 'AKEYP', or 'PKEYP' commands.</p> <p>Example:</p> <pre>SEND_COMMAND TP, " 'AKEYR' "</pre> <p>Closes the keyboard or keypad opened using the 'AKEYB', 'AKEYP', or 'PKEYP' commands.</p>
" 'BEEP' "	<p>Output one beep. The Beep button in the Protected Setup page must be set from 1 through 10 for this command.</p> <p>Example:</p> <pre>SEND_COMMAND TP, " 'BEEP' "</pre> <p>Beeps the panel if the Beep button is not set to 0.</p>
" 'BRIT-<level>' "	<p>Adjust brightness of display. The brightness range is 1 (minimum) to 5 (maximum).</p> <p><level> = 1 - 5</p> <p>Example:</p> <pre>SEND_COMMAND TP, " 'BRIT-5' "</pre> <p>Sets to highest brightness level.</p>
" 'CONT-<level>' "	<p>Adjust brightness of display. The brightness range is 1 (minimum) to 12 (maximum).</p> <p><level> = 1 - 12</p> <p>Example:</p> <pre>SEND_COMMAND TP, " 'CONT-12' "</pre> <p>Sets to highest brightness level.</p>
" 'CALIBRATE' "	<p>Start touch panel calibration.</p> <p>Example:</p> <pre>SEND_COMMAND TP, " 'CALIBRATE' "</pre> <p>Starts the calibration operation on the touch panel.</p>

System Send_Commands (Cont.)

Command	Description
<code>''CLOCK <mm-dd-yy> <hh:mm:ss>' ''</code>	<p>Set the time and date.</p> <p><mm = 01 - 12, dd = 01 - 31, yy = 00 - 99</p> <p>hh = 00 - 23, mm = 00 - 59, ss = 00 - 59></p> <p>Example:</p> <pre>SEND_COMMAND TP, ''CLOCK 02-08-98 19:16:00'</pre> <p>Sets the touch panel's date to February 8, 1998, and time to 7:16 p.m.</p>
<code>''DBEEP' ''</code>	<p>Output a double-beep. This command works only if the Double Beep value in the Protected Setup page is set to ON.</p> <p>Example:</p> <pre>SEND_COMMAND TP, ''DBEEP' ''</pre> <p>Double-beeps the panel.</p>
<code>''PAGE-<page name>' ''</code>	<p>Flip to page with specified page name.</p> <p><page name> = 1 - 50 ASCII characters</p> <p>Example:</p> <pre>SEND_COMMAND TP, ''PAGE-MAIN PAGE' ''</pre> <p>Flips the touch panel to the page named MAIN PAGE.</p>
<code>''PKEYP-<number string>' ''</code>	<p>Display asterisks (*) for keypad entries.</p> <p><number string> = 0 - 9999</p> <p>Example:</p> <pre>SEND_COMMAND TP, ''PKEYP-1988' ''</pre> <p>Displays the touch panel keypad with **** instead of 1988.</p>

System Send_Commands (Cont.)

Command	Description
''PPOFF - <page name>' "	<p>Close a specific popup page.</p> <p><page name> = 1 - 50 ASCII characters</p> <p>Example:</p> <pre>SEND_COMMAND TP, ''PPOFF-Popup Page 1''</pre> <p>Closes Popup Page 1.</p>
''PPON - <page name>' "	<p>Open a specific popup page.</p> <p><page name> = 1 - 50 ASCII characters</p> <p>Example:</p> <pre>SEND_COMMAND TP, ''PPON-Popup Page 1''</pre> <p>Opens Popup Page 1.</p>
''QBEEP' "	<p>Stop all beeps, including "ABEEP", "ADBEEP" and AXlink beeps.</p> <p>Example:</p> <pre>SEND_COMMAND TP, ''QBEEP''</pre> <p>Stops <i>all</i> beeps.</p>
''RESET' "	<p>Clear panel status (same as power up). Data stored in memory is not cleared.</p> <p>Example:</p> <pre>SEND_COMMAND TP, ''RESET''</pre> <p>Resets the touch panel.</p>
''SETUP' "	<p>Go to the Setup page.</p> <p>Example:</p> <pre>SEND_COMMAND TP, ''SETUP''</pre> <p>Flips the touch panel to the Setup page.</p>
''SLEEP' "	<p>Force the touch panel to screen-saver mode.</p> <p>Example:</p> <pre>SEND_COMMAND TP, ''SLEEP''</pre> <p>Activates the screen-saver mode.</p>

System Send_Commands (Cont.)

Command	Description
" 'TPAGEOFF' "	<p>Deactivates page tracking.</p> <p>Example:</p> <pre>SEND_COMMAND TP, " 'TPAGEOFF' "</pre> <p>Deactivate the page tracking option.</p>
" 'TPAGEON' "	<p>Activate page tracking.</p> <p>Example:</p> <pre>SEND_COMMAND TP, 'TPAGEON' DEFINE_DEVICE TP1 = 128 (*AMX Touch Panel*) TP2 = 129 (*AMX Touch Panel*) DEFINE_VARIABLE TP1_BUFFER[100] (*Buffer for TP1*) TP2_BUFFER[100] (*Buffer for TP2*) TRASH[50] (*For Parsing Above*) DEFINE_START CREATE_BUFFER TP1, TP1_BUFFER</pre>

System Send_Commands (Cont.)

Command	Description
	<pre>CREATE_BUFFER TP2,TP2_BUFFER SEND_COMMAND TP1, 'TPAGEON' SEND_COMMAND TP2, 'TPAGEON' DEFINE_PROGRAM IF(LENGTH_STRING(TP1_BUFFER)) { IF(FIND_STRING(TP1_BUFFER, 'PAGE-',1)) { TRASH=REMOVE_STRING(TP1_BUFFER, 'PAGE-',1) SEND_COMMAND TP2, "'PAGE-', TP1_BUFFER" CLEAR_BUFFER TP1_BUFFER } } IF((FIND_STRING(TP1_BUFFER, 'PPON-',1) OR(FIND_STRING(TP1_BUFFER', (PPOF-',1))) { SEND_COMMAND TP2,TP1_BUFFER CLEAR_BUFFER TP1_BUFFER } } IF (LENGTH_STRING(TP2_BUFFER)) { } } IF (LENGTH_STRING(TP2_BUFFER)) { IF(FIND_STRING(TP2_BUFFER, 'PAGE-',1)) { TRASH=REMOVE_STRING(TP2_BUFFER, 'PAGE-',1) SEND_COMMAND TP1, "'PAGE-', TP2_BUFFER" CLEAR_BUFFER TP2_BUFFER } } }</pre>
	<p>In this program, the command string is sent to the Central Controller in the 'PAGE-(page name)' format. The string can be captured with the CREATE_BUFFER command for one panel and sent to another panel.</p>

System Send_Commands (Cont.)

Command	Description
" 'WAKE' "	<p>Deactivate screen-saver mode and reset sleep timer.</p> <p>Example:</p> <pre>SEND_COMMAND TP, " 'WAKE' "</pre> <p>Deactivates the touch panel screen-saver mode and resets the sleep timer.</p>
" 'XMT0 <number>' "	<p>Set the new network communication delay for the panel and SOFTROM.</p> <p><number> = 4-30 ASCII characters</p> <p>Example:</p> <pre>SEND_COMMAND TP, " 'XMT0 5' "</pre> <p>Sets the new delay time to 5 seconds.</p>
" 'XMRT <number>' "	<p>Set the new network communication retry value for the panel and SOFTROM.</p> <p><number> = 1-15 ASCII characters</p> <p>Example:</p> <pre>SEND_COMMAND TP, " 'XMRT 9' "</pre> <p>Sets the number of retries to 9.</p>
" 'ZAP!' "	<p>Clear all memory and erase buttons, pages, drawings, and symbols.</p> <p>Example:</p> <pre>SEND_COMMAND TP, " 'ZAP!' "</pre> <p>Clears all memory and erases all buttons, pages, drawings, and symbols.</p>

Warning

You should only use the ZAP! command to erase all the stored data in the touch panel. The data cannot be recovered after it is erased.

Gray Scale and Programming Numbers

Gray scale shades for the VPT-GS are obtained by using color programming numbers 72-86. These numbers correspond to the basic 16 shades of gray.

Colors/Shades of Gray and Programming Numbers

The colors and their programming numbers are listed in Figure 202, and can be used to set the colors on buttons, sliders, gauges, and pages. The lowest color number represents the lightest color-specific display, and the highest number represents the darkest display. For example, the color number 0 is light red, and 5 is dark red.

Figure 202

Colors and programming numbers

Colors and programming numbers			
Color	No.	Color	No.
Red	0 - 5	Purple	54 - 59
Orange	6 - 11	Magenta	60 - 65
Yellow	12 - 17	Pink	66 - 71
Lime	18 - 23	White	72 - 77
Green	24 - 29	Gray	78 - 83
Aqua	30 - 35	More Gray	84 - 86
Cyan	36 - 41	Black	87
Royal	42 - 47	Transparent	255
Blue	48 - 53		

Font Styles and Programming Numbers

Figure 203 lists the font styles and their numbers you can use to program the text fonts on buttons, sliders, gauges, and pages. The programming numbers are assigned consecutively when they are downloaded to the touch panel. For more information on variable fonts, see the *Setting the variable text code* subsection.

Figure 203

Font styles and programming numbers

Note

You must import variable text fonts into a TPDesign3 project file, and download the project file containing the fonts to the Touch Panel. The variable fonts are assigned programming numbers by the Touch Panel during the download process.

Font styles and programming numbers			
No.	Font styles	No.	Font styles
1	Extra small	5	Extra large
2	Small	6	Hollow medium
3	Medium	8	Hollow extra large
4	Large	32-255	Variable fonts

Border Styles and Programming Numbers

Figure 204 lists border styles and their numbers you can use to program borders on buttons, sliders, and gauges.

Figure 204

Border styles and programming numbers

Border styles and programming numbers			
No.	Border styles	No.	Border styles
0	No border	11	Double shadow
1	No border special	20	3-dimensional rectangle 1
2	Single line	21	3-dimensional rectangle 2
3	Double line	22	3-dimensional round 1
4	Triple line	23	3-dimensional round 2
5	Single rounded	24	3-dimensional neon 1
6	Double rounded	25	3-dimensional neon 2
7	Single raised	26	3-dimensional neon blue
8	Double raised	27	3-dimensional neon green
9	Triple raised	40	Single diamond
10	Double-line two single	41	Double diamond

Shorthand Send Commands

Figure 205 lists the shorthand Send_Commands you can use with the VPT-CP Touch Panels. The shorthand command data is 1-byte, non-ASCII format except for pages, passwords, text, and bitmap names.

Figure 205

Shorthand Send_Commands

Note

Shorthand commands were designed by AMX to streamline receiving, processing, and transmitting AXCESS control system data. The shorthand commands operate control equipment just like the standard Send_Commands still used in a wide variety of AMX products, but they are simply smaller byte-for-byte, and thus processed more efficiently.

Shorthand Send_Commands	
Command	Description
<code>"@CBF',<variable text address>,<color_number>"</code>	<p>Set the OFF feedback border color to the specified color.</p> <p><variable text address> = 1 - 255 <color_number> = see Figure 202</p> <p>Example: SEND_COMMAND TP,"@CBF',1,0"</p> <p>Sets the OFF feedback border color to Red for the variable text button 1.</p>
<code>"@CBN',<variable text address>,<color_number>"</code>	<p>Set the ON feedback border color to the specified color.</p> <p><variable text address> = 1 - 255 <color_number> = see Figure 202</p> <p>Example: SEND_COMMAND TP,"@CBN',2,78"</p> <p>Sets the ON feedback border color to Gray for variable text button 2.</p>

Shorthand Send_Commands (Cont.)

Command	Description
" '@CFF', <variable text address>, <color_number> "	<p>Set the OFF feedback fill color to the specified color.</p> <p><variable text address> = 1 - 255</p> <p><color_number> = see Figure 202</p> <p>Example:</p> <p>SEND_COMMAND TP, " '@CFF', 1, 72 "</p> <p>Sets the OFF feedback fill color to White for variable text button 1.</p>
" '@CFN', <variable text address>, <color_number> "	<p>Set the ON feedback fill color to the specified color.</p> <p><variable text address> = 1 - 255</p> <p><color_number> = see Figure 202</p> <p>Example:</p> <p>SEND_COMMAND TP, " '@CFN', 1, 30 "</p> <p>Sets the ON feedback fill color to Aqua for variable text button 1.</p>
" '@CPG', <color_number>, '<page name>' "	<p>Set the page with specified page name background color to the specified color.</p> <p><color_number> = see Figure 202</p> <p><page name> = 1 - 50 ASCII characters</p> <p>Example:</p> <p>SEND_COMMAND TP, " '@CPG', 87, 'Main Page' "</p> <p>Sets the page title to Main Page, and the color to Black.</p>
" '@CPP', <color_number>, '<pop-up page name>' "	<p>Set the page with specified page name background color to the specified color.</p> <p><color_number> = see Figure 202</p> <p><pop-up page name> = 1 - 50 ASCII characters</p> <p>Example:</p> <p>SEND_COMMAND TP, " '@CPP', 54, 'Audio Page' "</p> <p>Sets the popup page title to Audio Page, and the color to Purple.</p>

Shorthand Send_Commands (Cont.)

Command	Description
" '@CTF',<variable text address>,<color_number>"	<p>Set the OFF feedback text color to the specified color.</p> <p><variable text address> = 1 - 255</p> <p><color_number> = see Figure 202</p> <p>Example:</p> <pre>SEND_COMMAND TP, "'@CTF',1,48"</pre> <p>Sets the OFF feedback text color to Blue for variable text button 1.</p>
" '@CTN',<variable text address>,<color_number>"	<p>Set the ON feedback text color to the specified color.</p> <p><variable text address> = 1 - 255</p> <p><color_number> = see Figure 202</p> <p>Example:</p> <pre>SEND_COMMAND TP, "'@CTN',1,72"</pre> <p>Sets the ON feedback text color to White for variable text button 1.</p>
" '@IDF' "	<p>Query the touch panel to return a string with the MS-DOS filename of the touch panel.</p> <p>Example:</p> <pre>SEND_COMMAND TP, "'@IDF' "</pre> <p>The touch panel returns its MS-DOS file name in a string.</p>
" '@IDP' "	<p>Query the touch panel to return a string with the TPDesign3 project name.</p> <p>Example:</p> <pre>SEND_COMMAND TP, "'@IDP' "</pre> <p>The touch panel returns a string that contains its TPDesign3 project name.</p>

Shorthand Send_Commands (Cont.)

Command	Description
" '@PPA-<page name>' "	<p>Remove all popup pages from a specified page. If no page is specified, the current page is used.</p> <p>Example:</p> <pre>SEND_COMMAND TP," '@PPA-Main Page' "</pre> <p>If there were several popup pages on 'MAIN PAGE' that are active, sending the previous command would remove them all from 'MAIN PAGE'.</p>
" '@PPF-<popup page name>;<page name>' "	<p>Deactivate a popup page on a touch panel page.</p> <p><popup page name> = target popup page name <page name> = target touch panel page name</p> <p>Example:</p> <pre>SEND_COMMAND TP," '@PPF-Laser Disc 2 Transport Control;Laser Disc Control Page' "</pre> <p>Deactivates the Laser Disc 2 Transport Control popup page on the Laser Disc Control Page.</p>
" '@PPK-<popup page name>' "	<p>Deactivate a popup page on <i>all</i> touch panel pages.</p> <p><popup page name> = target popup page name <page name> = target Touch Panel page name</p> <p>Example:</p> <pre>SEND_COMMAND TP," '@PPK-Laser Disc 2 Transport Control' "</pre> <p>Deactivates the Laser Disc 2 Transport Control popup page on <i>all</i> touch panel pages.</p>
" '@PPN-<popup page name>;<page name>' "	<p>Activate a popup page on a touch panel page.</p> <p><popup page name> = Popup page name <page name> = Page name</p> <p>Example:</p> <pre>SEND_COMMAND TP," '@PPN-Laser Disc 2 Transport Control;Laser Disc Control Page' "</pre> <p>Activates the Laser Disc 2 Transport Control popup page on the Laser Disc Control Page.</p>

Shorthand Send Commands (Cont.)

Command	Description
" '@PPX-<popup page>' "	<p>Remove all popup pages from all pages in a panel. The group that needs to be turned Off must contain the popup page given.</p> <p>Example:</p> <pre>SEND_COMMAND TP, "'@PPX-POP VCR2' "</pre> <p>The popup page 'POP VCR' must be in a popup group. If so, then any popup page in that group will be turned off on all pages.</p>
" '@PWD-<page flip password>' "	<p>Set the password for the Page Flip on the touch panel.</p> <p><page flip password> = 0 through 9999</p> <p>Example:</p> <pre>SEND_COMMAND TP, "'@PWD-1988' "</pre> <p>Sets the page flip password to 1988.</p>
" '@SSL-<string>' "	<p>Change the Sleep string sent to the Central Controller when the touch panel activates sleep mode.</p> <p><string> = alphanumeric characters</p> <p>Example:</p> <pre>SEND_COMMAND TP, "'@SSL-Touch Panel Deactivated' "</pre> <p>Sends Touch Panel Deactivated to the Central Controller.</p>
" '@SST-<string>' "	<p>Change the Startup string sent to the Central Controller when the touch panel powers up.</p> <p><string> = alphanumeric characters</p> <p>Example:</p> <pre>SEND_COMMAND TP, "'@SST-Touch Panel Power On' "</pre> <p>Sends touch panel Power On to the Central Controller when the touch panel powers up.</p>

Shorthand Send_Commands (Cont.)

Command	Description
" '@SWK-<string>' "	<p>Change the Wakeup string sent to the Central Controller when the touch panel is activated.</p> <p><string> = alphanumeric characters</p> <p>Example:</p> <pre>SEND_COMMAND TP," '@SWK-Touch Panel Activated'"</pre> <p>Sends Touch Panel Activated to the Central Controller.</p>

Color/Gray Scale Send_Commands

Use the color Send_Commands (Figure 206) to set the colors for text, buttons, and pages. Use the same command for setting gray scale values only change the color number value to reflect the gray scale (72-86) value.

Figure 206

Color Send_Commands

Color Send_Commands

Command	Description
" 'CALL<variable text address>-<data>' "	<p>Set the colors for a variable text button. See Figure 202 for color numbers.</p> <p><variable text address> = 1 - 255</p> <p><data> = 6 color_number series for:</p> <ul style="list-style-type: none"> FILL COLOR ON FILL COLOR OFF BORDER COLOR ON BORDER COLOR OFF TEXT COLOR ON TEXT COLOR OFF <p>Example:</p> <pre>SEND_COMMAND TP," 'CALL1-1 3 0 0 72 74' "</pre> <p>Sets variable text button 1 to:</p> <ul style="list-style-type: none"> FILL COLOR ON = Red one shade from brightest FILL COLOR OFF = Red three shades from brightest

Note

You must use the variable text assignments to change button colors.

Color Send Commands (Cont.)

Command	Description
	BORDER COLOR ON = Red brightest
	BORDER COLOR OFF = Red brightest
	TEXT COLOR ON = White brightest
	TEXT COLOR OFF = White two shades from brightest
"'CB0FF<variable text address>-<color_number>' "	<p>Set the OFF feedback border color to the specified color.</p> <p><variable text address> = 1 - 255</p> <p><color_number> = see Figure 202</p> <p>Example:</p> <pre>SEND_COMMAND TP, "'CB0FF1-0' "</pre> <p>Sets the OFF feedback border color to Red for the variable text button 1.</p>
"'CB0N<variable text address>-<color_number>' "	<p>Set the ON feedback border color to the specified color.</p> <p><variable text address> = 1 - 255</p> <p><color_number> = see Figure 202</p> <p>Example:</p> <pre>SEND_COMMAND TP, "'CB0N1-48' "</pre> <p>Sets the ON feedback border color to Blue for variable text button 1.</p>
"'CF0FF<variable text address>-<color_number>' "	<p>Set the OFF feedback fill color to the specified color.</p> <p><variable text address> = 1 - 255</p> <p><color_number> = see Figure 202</p> <p>Example:</p> <pre>SEND_COMMAND TP, "'CF0FF1-72' "</pre> <p>Sets the OFF feedback fill color to White for variable text button 1.</p>

Color Send Commands (Cont.)

Command	Description
"'CFON<variable text address>-<color _number>' "	<p>Set the ON feedback fill color to the specified color.</p> <p><variable text address> = 1 - 255</p> <p><color _number> = see Figure 202</p> <p>Example:</p> <p>SEND_COMMAND TP, "'CFON1-48' "</p> <p>Sets the ON feedback fill color to Blue for variable text button 1.</p>
"'CPAGE<color_number>-<page name>' "	<p>Set the background page color to the specified color.</p> <p><color_number> = see Figure 202</p> <p><page name> = 1 - 50 ASCII characters</p> <p>Example:</p> <p>SEND_COMMAND TP, "'CPAGE48-MAIN PAGE' "</p> <p>Sets the background color on the MAIN PAGE to Blue.</p>
"'CTOFF<variable text address>-<color _number>' "	<p>Set the OFF feedback text color to the specified color.</p> <p><variable text address> = 1 - 255</p> <p><color _number> = see Figure 202</p> <p>Example:</p> <p>SEND_COMMAND TP, "'CTOFF1-48' "</p> <p>Sets the OFF feedback text color to Blue for variable text button 1.</p>
"'CTON<variable text address>-<color _number>' "	<p>Set the ON feedback text color to the specified color.</p> <p><variable text address> = 1 - 255</p> <p><color _number> = see Figure 202</p> <p>Example:</p> <p>SEND_COMMAND TP, "'CTON1-72' "</p> <p>Sets the ON feedback text color to White for variable text button 1.</p>

Note

Page names are case-sensitive.

Variable Text Send Commands

Use variable text Send_Commands (Figure 207) to set the borders, fonts, and text.

Figure 207

Variable text
Send_Commands

Variable text Send_Commands	
Command	Description
"!B',<variable text address 1-255>,<ON/OFF 0-1>"	<p>Set a specific button to on or off.</p> <p><variable text address> = 1 - 255</p> <p><ON> = 0 and <OFF> = 1</p> <p>Example:</p> <p>SEND_COMMAND TP,"!B',128, 1"</p> <p>Sets button 128 off.</p>
"BTOF,<variable text address>"	<p>Set a specific button's active state to Off.</p> <p><variable text address> = 1 - 255</p> <p>Example:</p> <p>SEND_COMMAND TP,"BTOF',255'"</p> <p>Sets the state for button 255 to Off.</p>
"BTON',<variable text address>"	<p>Set a specific button's active state to On.</p> <p><variable text address> = 1 - 255</p> <p>Example:</p> <p>SEND_COMMAND TP,"BTON',128"</p> <p>Sets the state for button 128 to On.</p>

Variable text Send_Commands (Cont.)

Command	Description
"!C',<variable text address>,<border style>,,<new button text>"	<p>Set the border, font, and text in one command.</p> <p><variable text address> = 1 - 255</p> <p><border style> = See Figure 204</p> <p> = See Figure 203</p> <p><button text> = Enter button text to appear on button</p> <p>Example:</p> <p>SEND_COMMAND TP, "!C',1,6,6,'VCR PLAY'"</p> <p>Sets the variable text button one title to VCR PLAY using a hollow medium font, and changes the border attribute to double rounded.</p>
"!F',<variable text address>,"	<p>Shorthand version of 'FONT' command.</p> <p><variable text address> = 1 - 255</p> <p> = See Figure 203</p> <p>Example:</p> <p>SEND_COMMAND TP, "!F',1,6"</p> <p>Changes variable text button one font to hollow medium.</p>
"!FONT,<variable text address>-"	<p>Change the font size (or style) of the text in a specific button.</p> <p><variable text address> = 1 - 255</p> <p> = See Figure 203</p> <p>Example:</p> <p>SEND_COMMAND TP, "!FONT,1-6'"</p> <p>Changes variable text button one font to hollow medium.</p>
"!I',<variable text address>,<border style>"	<p>Shorthand version of 'ICON' command.</p> <p><variable text address> = 1 - 255</p> <p><border style> = See Figure 204</p> <p>Example:</p> <p>SEND_COMMAND TP, "!I',1,'6'"</p> <p>Changes the variable text button one border style to double rounded.</p>

Variable text Send_Commands (Cont.)

Command	Description
<code>"'ICON,<variable text address>-<border style>' "</code>	<p>Change the border style of a specific button.</p> <p><code><variable text address> = 1 - 255</code></p> <p><code><border style> = See Figure 204</code></p> <p>Example:</p> <pre>SEND_COMMAND TP, "'ICON,25-6' "</pre> <p>Changes the variable text button 25 border style to double-rounded.</p>
<code>"'!T',<variable text address>,<new button text>' "</code>	<p>Shorthand version of 'TEXT' command.</p> <p><code><variable text address> = 1 - 255</code></p> <p><code><new button text> = 1 - 60 characters</code></p> <p>Example:</p> <pre>SEND_COMMAND TP, "'!T',1,'VCR PLAY' "</pre> <p>Changes the variable text button one title to VCR PLAY.</p>
<code>"'TEXT,<variable text address>-<new button text>' "</code>	<p>Enter text on a button. Use the character to display text on multiple lines.</p> <p><code><variable text address> = 1 - 255</code></p> <p><code><button text> = Enter button text to appear on button</code></p> <p>Example:</p> <pre>SEND_COMMAND TP, "'TEXT2-VCR PLAY' "</pre> <p>Sets the VCR and PLAY text on variable button 2. The character places VCR above PLAY on the button.</p>

Shorthand Variable Text Commands

Figure 208 lists the shorthand variable text commands you can use with the Touch Panel. The shorthand command data is one-byte, non-ASCII format except for pages, passwords, text, and bitmap names.

Figure 208

Shorthand variable text commands

Note

Shorthand commands were created by AMX designers to streamline receiving, processing, and transmitting Central Controller data. The short-hand commands operate Control Equipment just like the standard Send_Commands still used in a wide variety of AMX products, but they are simply smaller byte-for-byte, and thus processed more efficiently.

Shorthand variable text commands

Command	Description									
<code>" '@BMF',<variable text address>,'<attribute data>' "</code>	<p>Set multiple attributes to a button, slider, or gauge. This command allows you to program up to 12 attributes on one command line.</p> <p><variable text address> = 1 - 255</p> <p><optional data> = See below</p> <p>Optional data:</p> <p>'%B',<border styles> = See Figure 204</p> <p>'%F', = See Figure 203</p> <p>'%T',<button text > = ASCII characters (empty is clear)</p> <p>'%P',<bitmap> = Bitmap filename (empty is clear)</p> <p>'%I',<icon> = 1 - 255 (icon numbers are assigned in TPDesign3 project file)</p> <p>'%J',<text alignment> = 1 - 9 as shown the following alignment chart</p> <table border="1"><tr><td>1</td><td>2</td><td>3</td></tr><tr><td>4</td><td>5</td><td>6</td></tr><tr><td>7</td><td>8</td><td>9</td></tr></table> <p>'%C1',<on-state fill color> = See Figure 202 for color numbers</p> <p>'%C2',<off-state fill color> = See Figure 202 for color numbers</p> <p>'%C3',<on-state border color> = See Figure 202 for color numbers</p> <p>'%C4',<off-state border color> = See Figure 202 for color numbers</p> <p>'%C5',<on-state text color> = See Figure 202 for color numbers</p> <p>'%C6',<off-state text color> = See Figure 202 for color numbers</p> <p>Example:</p> <pre>SEND_COMMAND TP," '@BMF',255,'%T POWER ON '%B',4',,%C1',72' "</pre> <p>Sets the text on button 255 to POWER ON (appears on two lines), adds a triple-line border, and sets the On-state color to White.</p>	1	2	3	4	5	6	7	8	9
1	2	3								
4	5	6								
7	8	9								

System Send_Commands (Cont.)

Command	Description
"@BMP',<variable text address>,'<bitmap>'"	<p>Add a bitmap file to a button. The bitmap files are imported into the TPDesign3 software program, and their numbers are assigned by the touch panel during the download process.</p> <p><variable text address> = 1 - 255</p> <p><bitmap> = Bitmap</p> <p>Example:</p> <pre>SEND_COMMAND TP, "@BMP',85,'Bitmap1'"</pre> <p>Adds the Bitmap1 file to button 85.</p>
"@BOR',<variable text address>,<border style>"	<p>Set the border style on a button.</p> <p><variable text address> = 1 - 255</p> <p><border style> = See Figure 204</p> <p>Example:</p> <pre>SEND_COMMAND TP, "@BOR',65 ,11"</pre> <p>Sets the border style to Double shadow on button 65.</p>
"@ENA',<variable text address>,<button state on/off>"	<p>Set a specific button's active state to On or Off.</p> <p><variable text address> = 1 - 255</p> <p><1> = button off and <0> = button on</p> <p>Example:</p> <pre>SEND_COMMAND TP, "@ENA',128,1"</pre> <p>Sets the state for button 128 on.</p>
"@FON',<variable text address>,"	<p>Set the text font on a button.</p> <p><variable text address> = 1 - 255</p> <p> = See Figure 203</p> <p>Example:</p> <pre>SEND_COMMAND TP, "@FON',56,32"</pre> <p>Sets the text on button 56 to variable font style 32.</p>

System Send_Commands (Cont.)

Command	Description									
"@ICO',<variable text address>,<icon>"	<p>Assign an icon to a button. The icon files are imported into the TPDesign3 software program, and their numbers are assigned by the touch panel during the download process.</p> <p><variable text address> = 1 - 255</p> <p><icon file number> = 1 - 255</p> <p>Example:</p> <p>SEND_COMMAND TP, "'@ICO',16,12"</p> <p>Adds icon 12 on button 16.</p>									
"@JUS',<variable text address>,<text alignment>"	<p>Set the text alignment on a button.</p> <p><variable text address> = 1 - 255</p> <p><text alignment> = 1 - 9 as shown in the following alignment chart</p> <table border="1"> <tr> <td>1</td> <td>2</td> <td>3</td> </tr> <tr> <td>4</td> <td>5</td> <td>6</td> </tr> <tr> <td>7</td> <td>8</td> <td>9</td> </tr> </table> <p>Example:</p> <p>SEND_COMMAND TP, "'@JUS',9,5"</p> <p>Centers the text on button 9.</p>	1	2	3	4	5	6	7	8	9
1	2	3								
4	5	6								
7	8	9								
"@SH0',<variable text address>,<button on/off>"	<p>Set a specific button to on or off.</p> <p><variable text address> = 1 - 255</p> <p><0> = button off and <1> = button on</p> <p>Example:</p> <p>SEND_COMMAND TP, "'@SH0',128,0"</p> <p>Sets button 128 off.</p>									

System Send_Commands (Cont.)

Command	Description
" '@TXT', <variable text address>, '<text>' "	<p>Add text on a button. Use the character to display text on multiple lines.</p> <p><variable text address> = 1 - 255</p> <p><button text> = Enter button text to appear on button</p> <p>Example:</p> <pre>SEND_COMMAND TP, "'@TXT', 2, 'VCR PLAY' "</pre> <p>Sets the VCR and PLAY text on variable button 2. The character places VCR above PLAY on the button.</p>
" '@UNI', <variable text address>, '<text>' "	<p>Add Unicode text on a button.</p> <p><variable text address> = 1 - 255</p> <p><button text> = Enter button text to appear on button</p> <p>Example:</p> <pre>SEND_COMMAND TP, "'@UNI', 2, '(Foreign Text)'"</pre> <p>Sets the Foreign Text on variable button 2. The character places VCR above PLAY on the button.</p>

Note

Characters for Middle Eastern languages such as Arabic are *not* supported within the Unicode fonts because they are bi-directional. Buttons with Unicode fonts can only be created and edited using TPDesign3 Touch Panel Design Program.

Buttons String Commands

Figure 209 lists string commands you can assign to buttons using the Touch Panel editor. You select the PROPERTIES option in the Edit bar, press the target button, and enter the string command with the Touch Panel keyboard. Then, the string command is sent to the control system when you press the button. Refer to the *Touch Panel Reference* section for detailed editing information.

Figure 209

Buttons string commands

Buttons string commands

Command	Description
<code>''\$ID<group ID>' '</code>	Set the WAV-PK group ID number on VPW panels. <group ID > = 0 (off) - 15 Example: \$ID15 Sets the touch panel button group ID to 15.
<code>''\$SL' '</code>	Activate sleep mode on the touch panel. Example: \$SL Activates sleep mode on the touch panel.
<code>''#ST<sleep time>' '</code>	Set the idle time to activate sleep mode for a touch panel in 1-minute increments. When the touch panel's input time matches the sleep time, the panel goes to sleep. <sleep time> = 0 (off) - 120 minutes Example: #ST5 Sets the touch panel's sleep time to 5 minutes.

Note

At present, VGA and video are not supported by the ViewPoint.

Button Macro Commands

Only one macro can run at a time and the panel will be "locked" for the duration of the macro. A message will appear in the center of the touch panel signifying that a macro is executing and will not disappear until the completion of the macro. In addition, the touch panel must be pointed at the IR receivers during the entire macro execution cycle. Otherwise, some transmitted IR signals from the touch panel may not reach the receiver.

An unsupported feature, at this time, is the mixture of other strings within IR macro string blocks. However, other string types may occur before and after the macro blocks as long as the strings are separated from the macro block with a <CR> and the macro command exists at the beginning of the line.

The two commands are identified and defined in Figure 210.

Figure 210

Macro Commands

Macro Commands

Command	Description
<code>\$P <dn> <cn> <tpo> <tdp><CR></code>	<p>Send a pulse command for a specified period of time.</p> <p>dn = device number 2, 3, or 4</p> <p>cn = channel number 1-255</p> <p>tp = time pulse on in tenths of a second (max. 65535)</p> <p>tdp = time delay after pulse in tenths of a second (max. 65535)</p> <p><cr> = end of statement (Enter key pressed)</p> <p>Example</p> <pre>\$P 3 15 10 100<CR></pre> <p>Transmit the IR code at device 3, channel 15 for 1 second. Then, the macro will pause 10 seconds before executing the next command or before finishing the macro if no other commands exist.</p>
<code>\$W <tdbp><CR></code>	<p>Used as a delay between pulses</p> <p>tdbp = time delay before pulse in tenths of a second (max.65535)</p> <p><cr> = end of statement (Enter key pressed)</p> <p>Example:</p> <pre>\$W 455<CR></pre> <p>This command will wait 45.5 seconds before executing the next macro command.</p>

Loading Infrared (IR) Files

Overview

This section provides instructions for loading IR files in your ViewPoint touch panel using IRLIBX.EXE. The ViewPoint has 32 kB of memory specifically for IR file storage. To load IR files, you need a copy of the AMX Control Disk CD-ROM containing AMX's IRLIB files or access to the AMX Bulletin Board on the Internet.

IRLIBX

The IRLIB files (Figure 211) are the library files that AMX has constructed to program IR control devices. You will find the listing of IR files on your AMX Control Disc. The listing is in .pdf format and you require an installed copy of Adobe Acrobat to read the listing.

Note

IR files can be loaded into the ViewPoint touch panels when used as stand-alone units. If the ViewPoint is loaded with a VPXpress program, you should not load IR files for stand-alone operation.

Figure 211
IRLIB file listings

Manufacturers	Hand Controls	Model Numbers	IR Filenames
3M	*3m1*	mp8650 (vp)	3M000001.IRL
3M	*3M2*	VCS3000/VCS3100	3M000004.IRL
3M	3M9A2A	MP8730 (VP)	3M000007.IRL
3M	ACS3000	VCS3000 (VID CONF)	3M000006.IRL
3M	mp8020	mp8020 (vp)	3M000000.IRL
3M	MP8630	MP8630 (VP)	3M000002.IRL
3M	MP8640	MP8640 (VP)	3M000003.IRL
3M	MP8660	MP8660 (vp)	3M000005.IRL
ADA (AUDIO DESIGN ASSOC)	MC009BR	MASTER FOR ADA	ADA.IRL
ADA (AUDIO DESIGN ASSOC)	VS3	VS3 (SW)	ADA00000.IRL
ADAPTIVE MICRO SYSTEMS	ALPHA	215C (SIGN)	ADAPTIVE.IRL
ADC (AUTOMATIC DEVICES CO)	OMAC M30	OMAC M30 (DRAP)	OMAC.IRL
ADCOM	*ADC1*	GCD575 (cd)	ADCOM003.IRL
ADCOM	*ADCOM1*	GSF560 (SS)	ADCOM001.IRL
ADCOM	*ADCOM2*	GTP740 (TUN)	ADCOM005.IRL
ADCOM	GFB800	GFT555 (RCV)	ADCOM002.IRL
ADCOM	GTP500II	GTP500II/GR500	ADCOM.IRL
ADCOM	RC45II	GTP450 (PAMP)	ADCOM000.IRL
ADCOM	RC600CD	GCD600 (CD)	ADCO2.IRL
ADCOM	RC65 (ALL M)	GTP600 (PAMP)	ADCO0.IRL
ADCOM	RC65 (TUN M)	(TUN)	ADCO1.IRL
ADMIRAL	*AD1*	JKY67215 (CD)	ADMIRAL0.IRL
ADMIRAL	*AD2*	(CD)	ADMIRAL1.IRL
ADMIRAL	GO797GE	JSJ20401 (VCR)	ADMIRAL2.IRL
ADS	*ADS1*	CHANNEL SURFER BX	ADS00000.IRL
AETHRA	TCH384	VEGA 383 (codec)	AETHRA00.IRL
AIWA	RC6AS14	NSAV2100 (CD)	AIWA0004.IRL
AIWA	RC7VR23	HVMX1000 (VCR)	AIWA0005.IRL
AIWA	RCC201	XT6 (CD)	AIWA0000.IRL
AIWA	RCS106	ADF850 (CAS)	AIWA0002.IRL

To use the IRLIB Files listing:

1. Choose Start, then Programs and follow the pathway shown in Figure 212.

Figure 212

Pathway to IR Library Database List

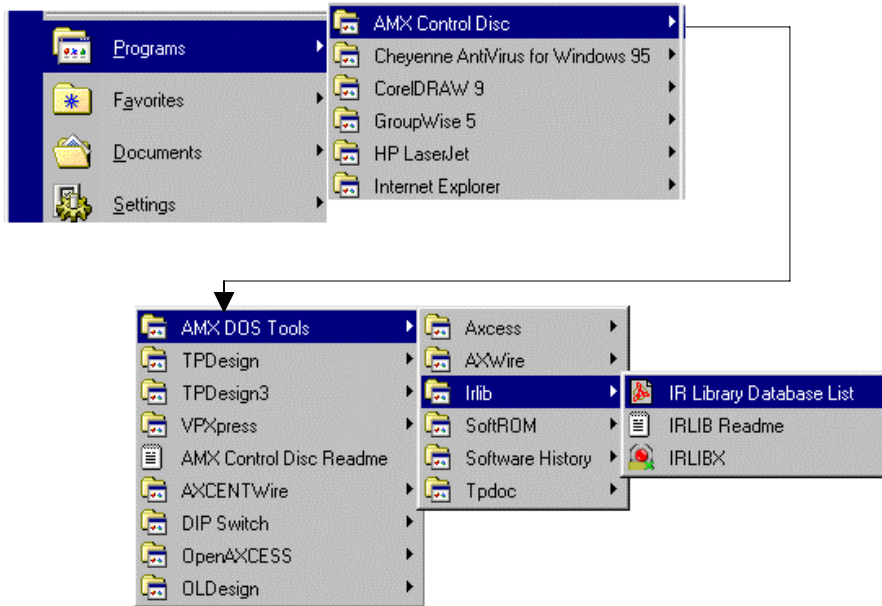

2. Click IR Library Database List to open the IRLIB infrared library program PDF. The Adobe Acrobat Reader will then launch itself and open the PDF file (Figure 213).

Figure 213

IR Library Files listing

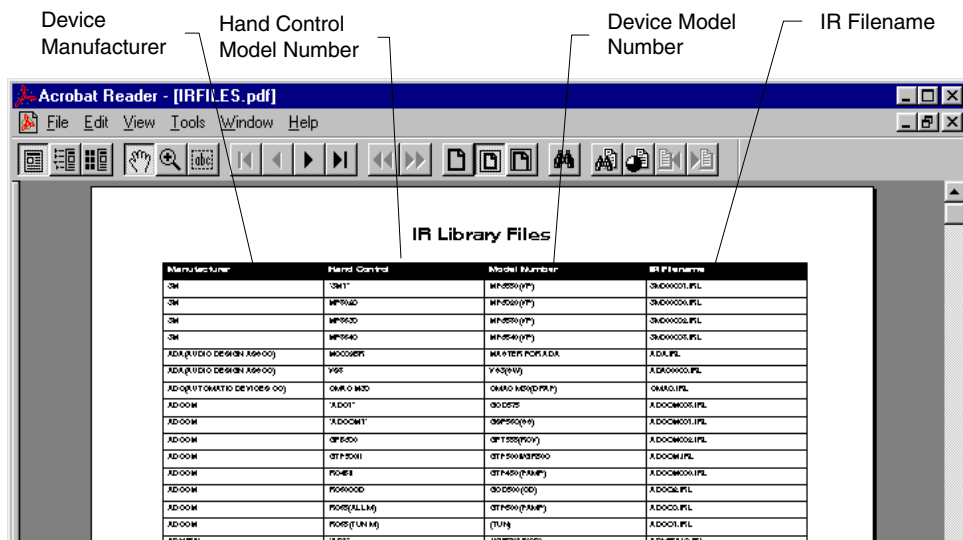

3. Scan through the listing and select the manufacturer and model number of the device you want to control. Make note of the data provided.

Note

IR files can be loaded into the ViewPoint touch panels when used as stand-alone units. If the ViewPoint is loaded with a VPXpress program, you should not load IR files for stand-alone operation.

Loading an IR File

The following steps guide you through the process of loading an IR file into a ViewPoint touch panel. To aid you, a Sony DVD Player (Model DVPC600D) will be used as an example. Also, IRLIB.EXE is used as the executable file.

1. Select Start/Programs from the Windows Main menu taskbar and follow the pathway shown in Figure 214.

Figure 214

Pathway to open IRLIB

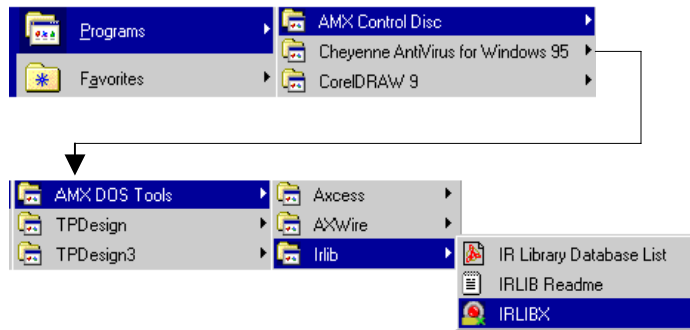

2. Click IRLIBX to open the IRLIB infrared library program.
3. Press **Alt-. (period button) + ENTER** to view the IRLIB program in a smaller window on your Windows Desktop. IRLIB opens and Figure 215 is shown.

Figure 215

IRLIB screen

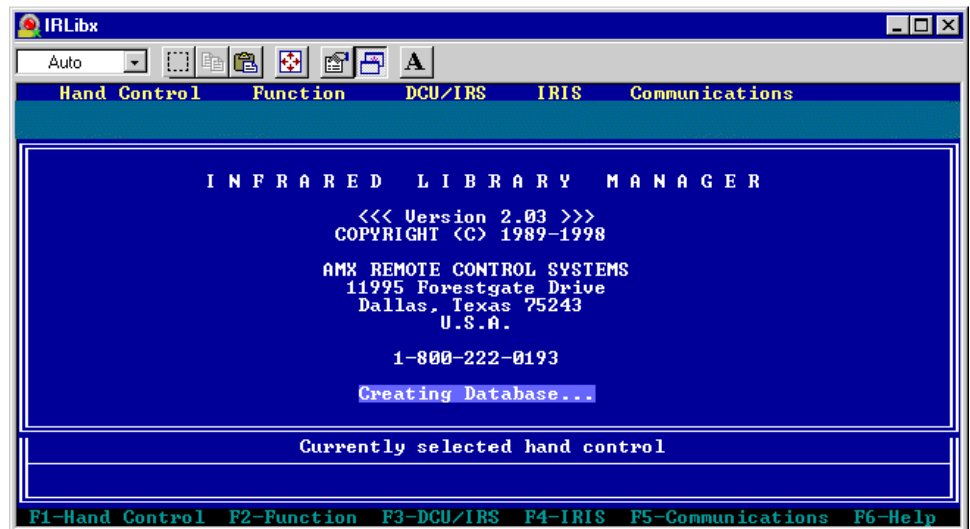

- After the Database has been created, press F5 and select Configure. Figure 216 appears.

Figure 216

Communications settings

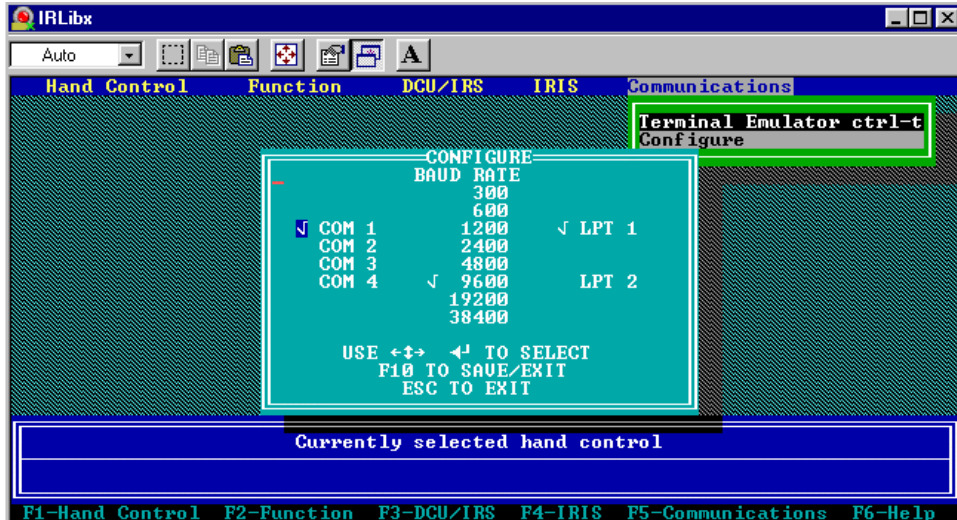

Note

Make sure that the ViewPoint touch panel is set to the same Baud rate as your computer.

- Select your computer's Com port and baud rate that you wish to communicate with the ViewPoint touch panel.
- Then, press F10.
- When the Communications screen has disappeared, press F1 on your computer keyboard. Use the up/down arrow keys and select Change Directory. The dialog in Figure 217 will appear.

Figure 217

Change Directory dialog

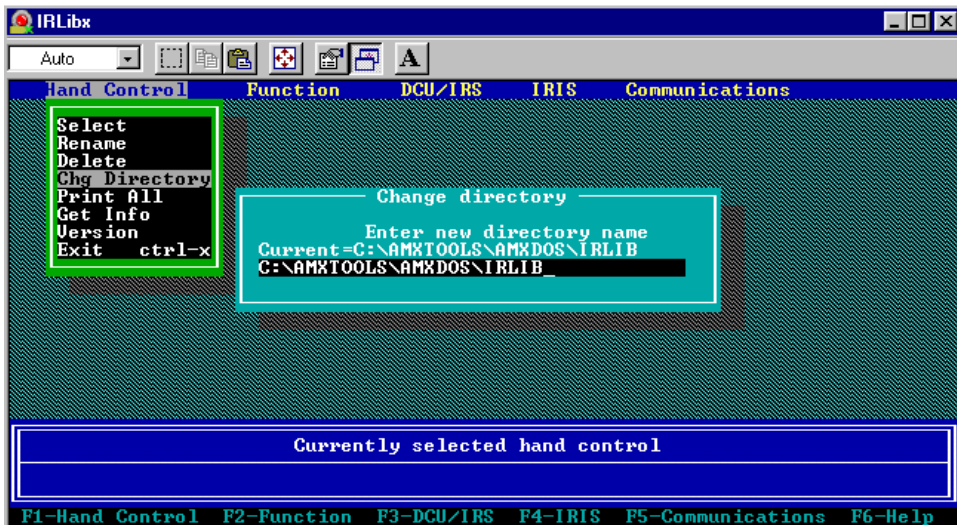

8. Type in the directory path and name for the location of the IRLIB files on your computer. Press Enter on your keyboard. The IRLIB program locates the IRLIB directory and compiles a database of all IR files available.
9. After the Creating Database dialog in Figure 218 disappears, press F1 and choose Select using the up/down arrow keys and the IR database is shown (Figure 219).

Figure 218
Creating Database

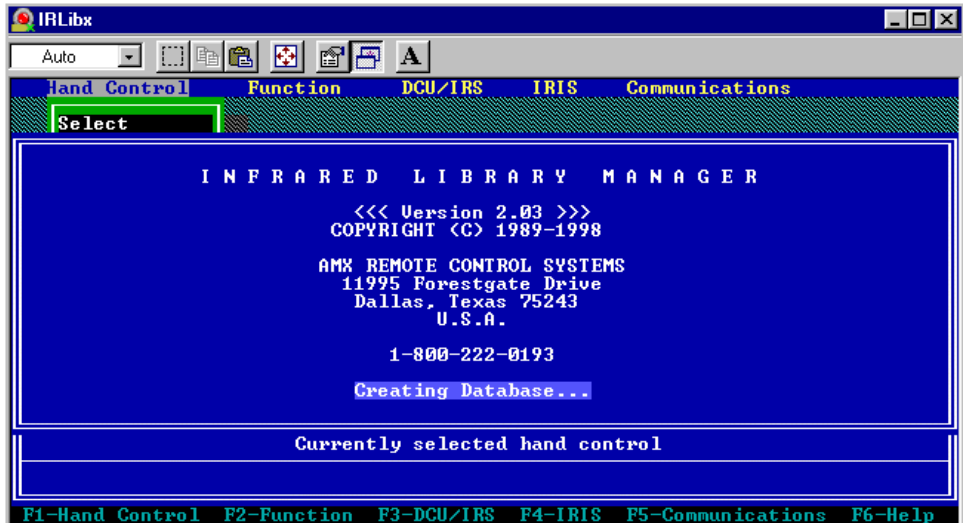
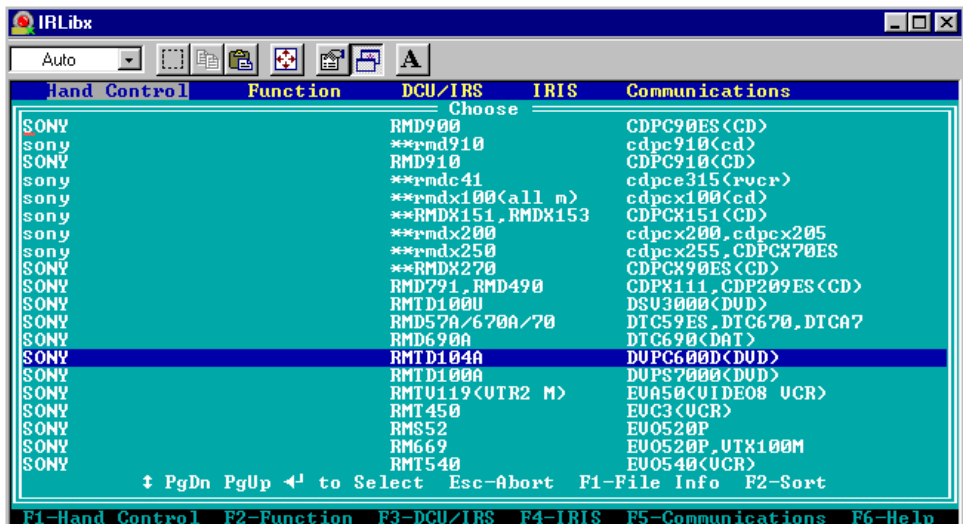

Figure 219
IRLIB Database



10. Locate the Manufacturer and model in the database and press ENTER on your keyboard. You then see a dialog that says the computer is loading your IRL file.

- Once the IR file has loaded into your computer and the loading dialog disappears, press F3. Click Modify and press ENTER. The Modify dialog will appear (Figure 220).

Figure 220

Modify dialog screen

Note

The IR file loading is the file you identified for your equipment.

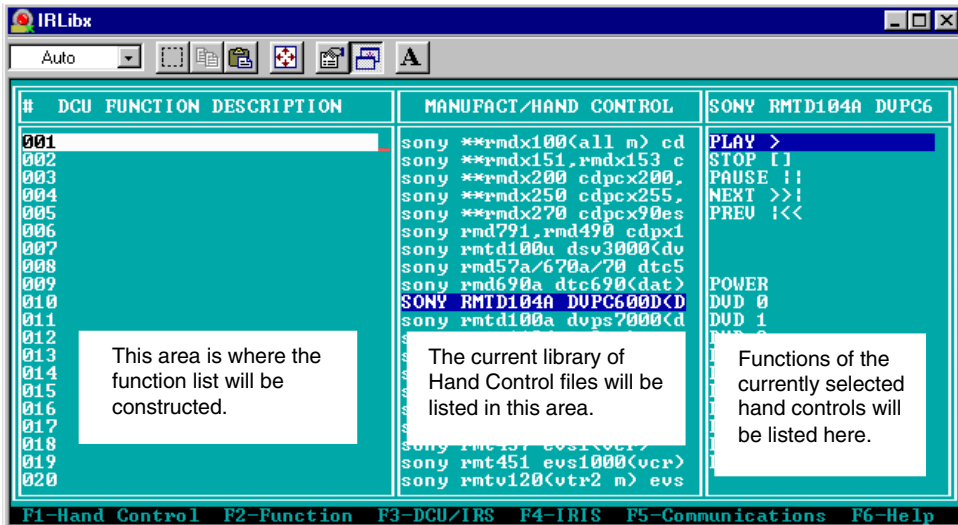

- Enter Alt D and then enter Alt C. You have cleared the DCU Function Description and have copied the Sony RMT 104A<DVP> IR settings into the DCU Function column (Figure 221).

Figure 221

IR commands loaded into DCU

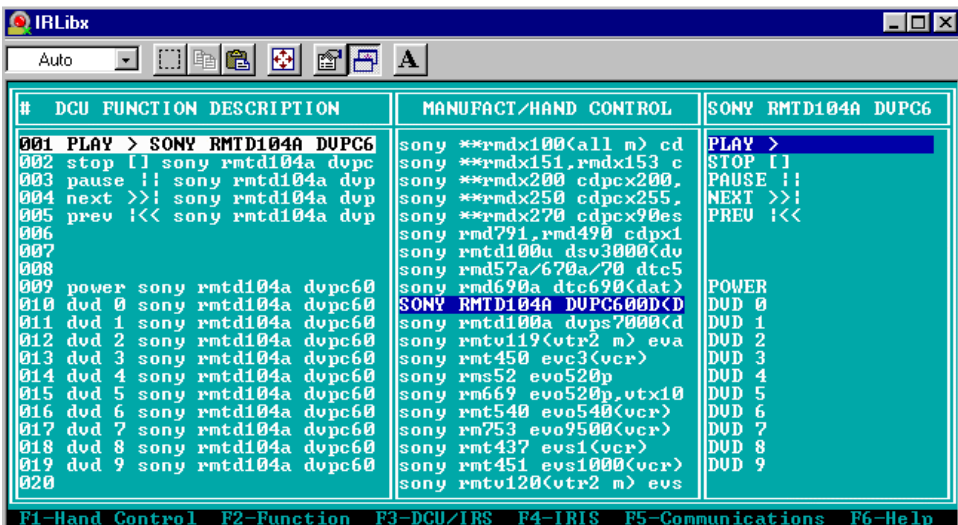

13. Press **Esc** on your keyboard (exits the Modify dialog) and press **F3** (shows menu selections for **DCU/IRS**). Select **Program** and press **Enter** on your keyboard. The IR file is downloaded to your touch panel.

IR Memory Check

To verify the amount of memory available for IR files, when using IRLIB:

1. Press **F4** and select **Memory** from the drop-down menu. The dialog in Figure 222 appears.

Figure 222

Enter Device Number



2. Enter the device number (2, 3, or 4) and press **ENTER**.
3. The ViewPoint is queried by the IRLIB program, and you then see a memory dialog similar to Figure 223.

Figure 223

Device reports

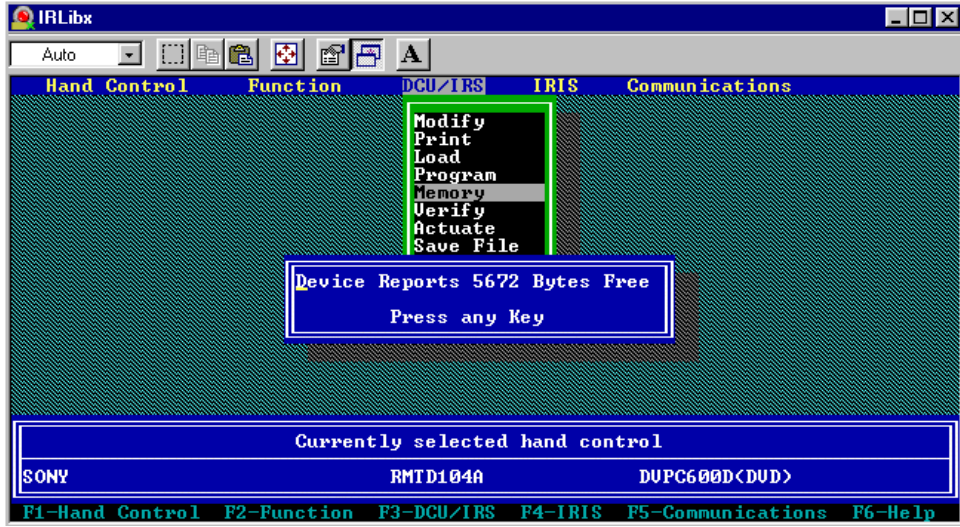

Upgrading the Firmware

Overview

In this section, you'll see how to upgrade the firmware in the PosiTrack 30 using the SOFTROM software program. Your PC must be connected to the PROGRAM DB-9 connector on the Central Controller or camera control unit connector using a Programming Cable.

Caution

Power loss during SOFTROM download can seriously affect the PosiTrack 30 and any previously stored information.

Note

These steps follow the installation of this software from the AMX Control Disc.

If power is lost during the download process, the unit will power up with the same set of code it had prior to the download. There is a small window during which a loss of power can be catastrophic. If power is lost between the erase of flash memory and the completion of copying the new boot code from RAM to flash memory, the unit will not operate at all when power returns.

To update the firmware in the touch panels:

1. Place the AMX Control Disc into the Compact Disc player of your PC.
2. From the Start menu, go to Programs\AMX Control Disc\AMX DOS Tools\SOFTROM.
3. Click the SOFTROM program. A screen similar to the screen shown in Figure 224 appears on your computer.

Figure 224

SOFTROM.EXE screen

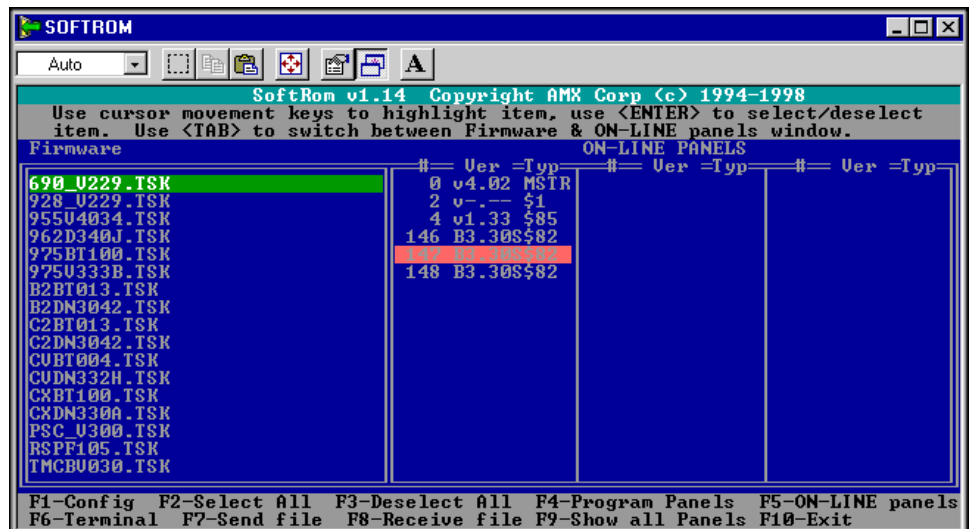

Configuration

To configure the communication setting for the SOFTROM program:

1. Press F1 and the screen in Figure 225 appears.

Figure 225

Configuration screen

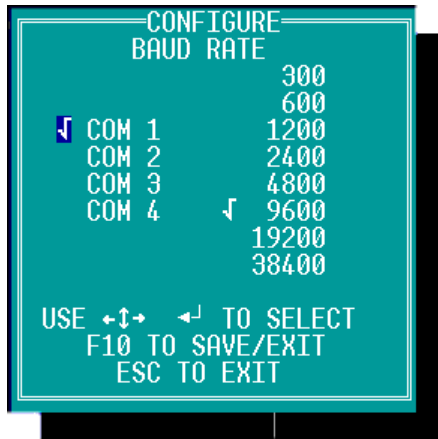

2. Using the up/down arrow keys, select the communications port you are using to interface with the controller and press ENTER.
3. Using the right arrow key, move to the BAUD RATE column. Then use the up/down arrow keys to select the interface communications speed.
4. Press ENTER.
5. Press F10 to save the communication settings and to exit the CONFIGURE screen.

Note

Make sure that the BAUD RATE selections match the setting on the AXCESS System Central Controller.

Downloading the Firmware

To download the firmware:

1. Press F5 to acquire the list of online programmable devices.
2. Using the up/down arrow keys, select your firmware versions listed in the Firmware column of the screen, and press ENTER.
3. Using the Tab key, switch to the ONLINE MASTERS list.
4. Using the up/down arrow keys, select the device to be programmed. Press ENTER for each device as it is selected
5. Press F4 to program the selected device; a loading message (Figure 226) appears on the screen

Note

You can press F2 to select all ONLINE programmable devices and F3 to clear all devices.

Figure 226

Loading message

Note

Firmware can be downloaded to multiple device numbers automatically. If multiple devices are selected, the bottom half of the loading bar indicates the percentage complete for the selected devices.

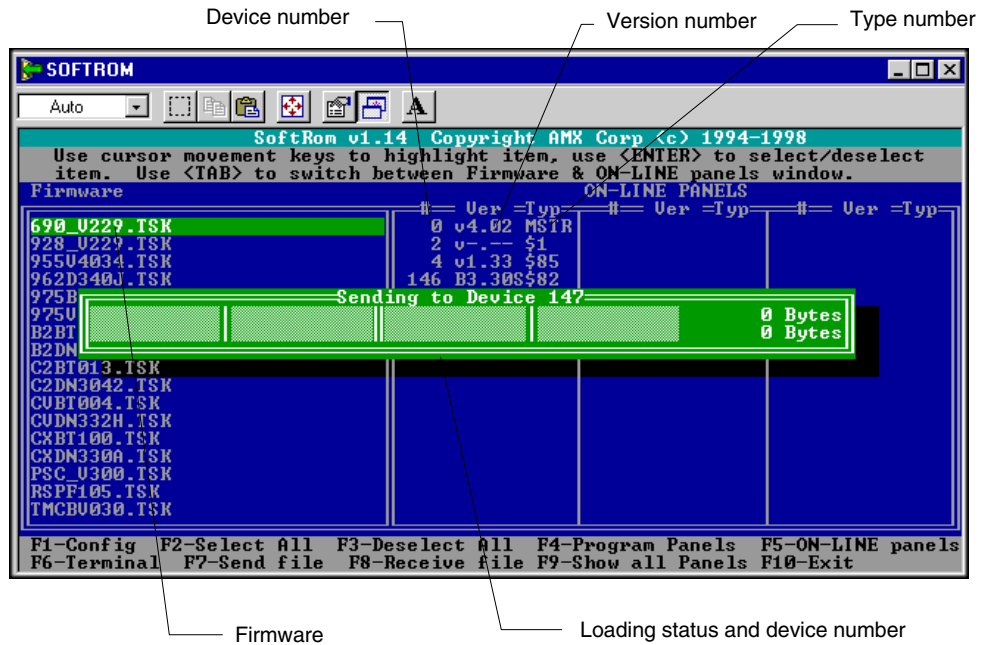

6. Press F5 to refresh the screen. Verify that the selected device has the correct firmware version. If any devices still appear with an old version of the firmware, repeat steps 3 through 5 until it appears with the correct version.
7. Press F10 to exit the SOFTROM program.

Specifications

Overview

Figure 227 shows a ViewPoint touch panel and Figure 228 lists the specifications for the ViewPoint models.

Figure 227

ViewPoint Wireless touch panel



Figure 228

ViewPoint specifications

ViewPoint specifications

Weight:

VPT-CP/VPT-GS	1.8 lbs (0.8 kg) with battery, 1.6 lbs (0.7 kg) without battery
VPW-CP/VPW-GS	1.9 lbs (0.9 kg) with battery, 1.7 lbs (0.8 kg) without battery

Dimensions (HWD)

5.99" x 8.75" x 2.78" (153.6 mm x 224.4 mm x 71.3 mm)

Operating temperature

+50°F to +95°F (+10.0°C to +35.0°C)

Operating humidity

5% to 95% non-condensing

Operating Frequency:

RF (VPT-CP/VPT-GS)	418 MHz standard (other frequencies available upon request)
RF (VPW-CP/VPW-GS)	2.4 GHz two-way digital spread spectrum
IR (VPT-CP/VPT-GS)	38 KHz or 455 KHz
IR (VPW-CP/VPW-GS)	38 KHz or 455 KHz

Enclosure

High impact molded, matte black crinkle finish

Power:

VPA-BP	7.2 VDC NMH (nickel metal hydride) rechargeable battery
Power supply	12 VDC @ 1500 mA

ViewPoint specifications (Cont.)

Display:

VPT-CP/VPW-CP	6" LCD (diagonal), 256 colors (153.9 mm)
VPT-GS/VPW-GS	6" LCD (diagonal), 16 gray shades (153.9 mm)

Connectors:

External power	3/16" (6 mm) coax female power jack
Programming	1/8" (2.5 mm) three conductor female jack

Memory Available:

IR files	32 KB
Buttons	225 KB
Bitmaps	1245 KB
Icons	262 KB
Fonts	262 KB

Assignable devices:

VPT-CP/VPT-GS

ViewPoint RF	Device 1
AMX IR	Device 1
IR other than AMX	Device 2, 3, and/or 4

VPW-CP/VPW-GS

Device ID	0-255
Group ID	0-16
ViewPoint	Device 1, 2, 3, and/or 4
IR	Device 2, 3, and/or 4

Accessories:

VPA-BP	ViewPoint Rechargeable Battery
Power supply	12 VDC, 1500 mA
Cables	FG-817 (all models) and FG10-727 (VPT-CP and VPT-GS only)

Optional Accessories:

VPA-BP	ViewPoint Rechargeable Battery
VPA-CHG	Fast-Cycle Battery Charger for VPA-BP
Power Supply	12 VDC, 1500 mA
AXR-RF	RF Receiver (VPT-CP/VPT-GS only)
AXR-WAVES	WaveServer (VPW-CP/VPW-GS only)

VPA-BP ViewPoint Rechargeable Battery

Figure 229 shows the VPA-BP ViewPoint Rechargeable Battery. Figure 230 shows the specifications.

Figure 229

VPA-BP ViewPoint
Rechargeable Battery



Figure 230

VPA-BP ViewPoint
Rechargeable Battery
specifications

VPA-BP ViewPoint Rechargeable Battery specifications

Battery voltage	7.2 VDC
Type	Rechargeable nickel metal hydride (NiMH)
Amp hour (Ah)	6-cell NiMH, 3.7 Ah minimum
Weight	11.7 oz (331.7 g)
Dimensions	5.34" x 2.02" x 0.69" (136 mm x 51 mm x 17.5 mm)

VPA-CHG Fast-Cycle Battery Charger for VPA-BP

Figure 231 shows the VPA-CHG Fast-Cycle Battery Charger (charging stand and PS2.4 Power Supply) for VPA-BP and Figure 232 lists the specifications.

Figure 231

VPA-CHG Fast-Cycle
Battery Charger (charging
stand and PS2.4 Power
Supply) for VPA-BP

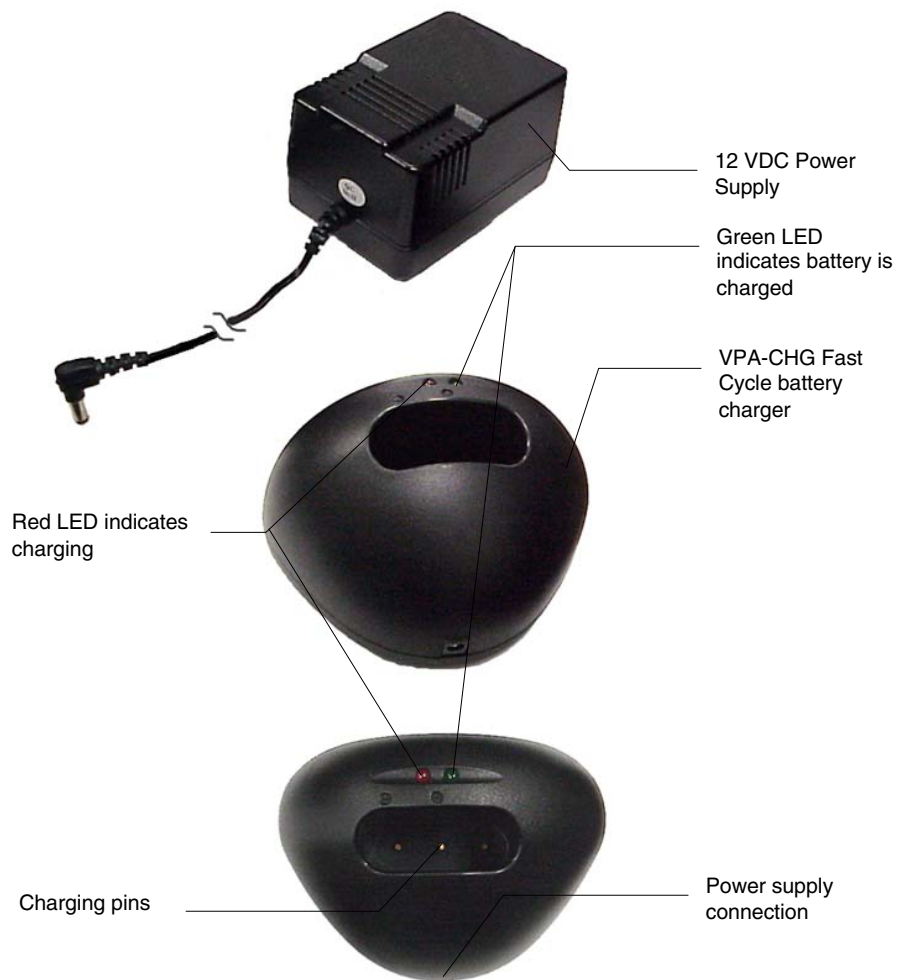

Figure 232

VPA-CHG Fast-Cycle Battery
Charger for VPA-BP
Specifications

VPA-CHG Fast-Cycle Battery Charger for VPA-BP Specifications

Power supply:

Input	110 VAC, 60 Hz
Output	12 VDC, 1500 mA

Indicators:

Red LED	Indicates battery is charging
Green LED	Indicates battery is fully charged
Buzzer	Indicates battery is inserted incorrectly

Enclosure High-impact, black matte molded composite

Dimensions (HWD):

Charging stand	3.15"x 5.15" x 3.74" (80.61 mm x 131.92 mm x 95.90 mm)
----------------	--

Weight:

Charging stand	0.379 lbs. (127 g)
Power supply	1.427 lbs. (476 g)

ViewPort Docking Station

Figure 233 shows the ViewPort Docking Station and Figure 234 lists the specifications.

Figure 233

ViewPort Docking Station



Figure 234

ViewPort Docking Station specifications

ViewPort Docking Station specifications

Dimensions (HWD)	4.83" x 8.26" x 7.62" (122.7 mm x 209.8 mm x 193.4 mm)
Environmental operating range:	
Temperature	50 F to 95 F (10 C to 35 C)
Humidity	0% to 95% non-condensing
Power requirement	12 VDC at 1.5 amp
Indicators	
Yellow LED	Indicates ViewPoint connected to ViewPort Docking Station
Green LED	Indicates spare battery is fully charged
Red LED	Indicates spare battery is charging
Options	
Power supply	ViewPoint 12 VDC @ 1.5 amp power supply
Battery	VPA-BP ViewPoint Rechargeable Battery (NiMH, 7.2 VDC @ 3.7 Amp hours)

Contacting Sales and Technical Support

Overview

Customer service and satisfaction is our highest priority here at AMX Incorporated. If you are experiencing any problems or have a question about your product, please contact Technical Support or your regional Sales and Support Team for assistance.

U.S. Sales and Technical Support Teams

To identify your regional Sales and Support Team, refer to the map shown in Figure 235.

Figure 235

U.S. Sales and Support Team map



Figure 236

U.S. Sales and Support Teams

U.S. Sales and Support Teams			
U.S. Team	Telephone	Fax	E-mail
West Team	800-552-6955	972-907-6222	West_Team@AMX.com
Mid-West Team	800-852-6985	972-907-6224	Midwest_Team@AMX.com
South Team	800-752-6975	972-907-6220	South_Team@AMX.com
East Team	800-462-6946	215-643-2808 or 215-657-8799	AMX_East@AMX.com

Figure 237

Other AMX contacts: Special Projects, Synergy and International Team contacts

Other AMX contacts			
	Telephone	Fax	E-mail
Special Projects	800-452-6945	972-907-6200	Special_projects@AMX.com
Synergy	800-952-6995	972-644-1291	Synergy@AMX.com
PHAST	800-979-9637	801-264-8271	Michael.taylor@AMX.com
International Team	+1 972-907-6247 or +1 800-222-0193	+1 972-907-6213	International_Team@AMX.com

AMX International Offices

Figure 238 lists AMX International offices.

Figure 238

AMX International Offices

AMX International Offices		
	Telephone	Fax
AMX Singapore	+65 221-2045	+65 221-2089
AMX Canada - Calgary	+1 403-256-2232 +1 888-222-0193	+1 403-256-6106
AMX Canada - Toronto	+1 905-304-1839 +1 888-250-3983	+1 905-304-6783
AMX Mexico	+525-638-0007	+525-638-0825

Technical Support

AMX Inc. provides technical support by telephone, fax, E-mail, or bulletin board system (BBS). For the fastest possible service, please have the following information ready, or provide it in your fax or E-mail message:

- Your name, company name, mailing address, and telephone number
- The name of your authorized Distributor or Dealer
- Dealer ID
- Job Title
- Purchase Order #
- Sales Order #

In addition to the general information listed above, it is necessary for your Technical Support representative to know the nature of your service problem. The more information you provide initially, the faster your representative can resolve the problem. With this in mind, please have the following information at hand.

- **If you are having a problem with hardware** — identify the equipment/ firmware version you are using, what you were doing when the problem occurred, and any troubleshooting you've tried (if any).
- **If your problem is with a software program** — identify the program you are using and the version number, the operating system on your PC, what you were doing when the problem occurred, and any troubleshooting you've tried (if any).

Figure 239 lists the contact numbers for Technical Support

Figure 239

Technical Support

Technical Support		
	Telephone	Fax
U.S. and Canada (Dallas Office)	800-932-6993	972-907-6214
U.S. East Coast region (Philadelphia office)	800-462-6946	215-643-2808 215-657-8799
Technical Support BBS	972-907-2884	bbs.AMX.com

Index

A

- Activate the Editor Bar, 19
- Add, 84, 124
- Add a button, 25
- Add a joystick on a page, 44
- Add a page, 23
- Adding a bargraph to a page, 49
- Adding a bitmap to a button, 35
- Adding an icon to a button, 34
- Adding text to a button, 33
- Adobe Acrobat, 161
- Affected Send_Commands, 134
- Auto assign, 73
- ACCESS, 152, 153
- ACCESS Control System, 14
- ACCESS Programming
 - '!B', <variable text address 1-255>, <ON/OFF 0-1>, 151
 - '!C', <variable text address>, <border style>, , <new button text>, 152
 - '!F', <variable text address>, ', 152
 - '#ST<sleep time>', 158
 - '\$ID<group ID>', 158
 - '\$SL', 158
 - '@BMF', <variable text address>, <attribute data>', 154
 - '@BMP', <variable text address>, <bitmap>', 155
 - '@BOR', <variable text address>, <border style>, 155
 - '@CBF', <variable text address>, <color_number >', 143
 - '@CBN', <variable text address>, <color_number >', 143
 - '@CFF', <variable text address>, <color_number >', 144
 - '@CFN', <variable text address>, <color_number >', 144
 - '@CPG', <color_number>, <page name >', 144
 - '@CPP', <color_number>, <pop-up page name >', 144
 - '@CTF', <variable text address>, <color_number >, 145
 - '@CTN', <variable text address>, <color_number >, 145
 - @ENA', <variable text address>, <button state on/off>, 155
 - '@FON', <variable text address>, , 155
 - '@ICO', <variable text address>, <icon>, 156
 - '@IDAP ', 145
 - '@IDF', 145
 - '@JUS', <variable text address>, <text alignment>, 156
 - '@PPA-<page name>', 146
 - '@PPK-<popup page name>', 146
 - '@PPX-<popup page>', 147
 - '@PWD-<page flip password>', 147
 - '@SHO', <variable text address>, <button on/off>, 156
 - '@SSL-<string>', 147
 - '@SST-<string>', 147
 - '@SWK-<string>', 148
 - '@TXT', <variable text address>, <text>', 157
 - @PPF-<popup page name>, 146
 - '@PPN-<popup page name>, 146
 - 'ABEEP', 135
 - 'ADBEEP', 135
 - 'AKEYB-<text string>', 135
 - 'AKEYP-<number string>', 135
 - 'AKEYR', 136
 - 'BEEP', 136
 - 'BRIT-<level>', 136
 - 'BTOF', <variable text address>', 151
 - 'BTON', <variable text address>', 151

'CALIBRATE', 136
 'CALL<variable text address>-
 <data>', 148
 'CBOFF<variable text address>-
 <color _number >', 149
 'CBON<variable text address>-
 <color _number>', 149
 'CFOFF<variable text address>-
 <color _number>', 149
 'CFON<variable text address>-
 <color _number>', 150
 'CLOCK <mm-dd-yy> <hh
 mm
 ss>', 137
 'CONT-<level>', 136
 'CPAGE<color _number>-<page
 name>', 150
 'CTOFF<variable text address>-
 <color _number>', 150
 'CTON<variable text address>-
 <color _number>', 150
 'DBEEP', 137
 'FONT,<variable text address>-
 ', 152
 'PAGE-<page name>', 137
 'PKEYP-<number string>', 137
 'PPOF - <page name>', 138
 'PPON - <page name>', 138
 'QBEEP', 138
 'RESET', 138
 'SETUP', 138
 'SLEEP', 138
 'TPAGEOFF', 139
 'TPAGEON ', 139
 'WAKE', 141
 'XMRT <number>', 141
 'XMTO <number>', 141
 'ZAP!', 141
 ACCESS Programming
 Color Numbers, 142
 Color Send_Commands, 148
 System Send_Commands, 135, 143,
 153
 ACCESS Programming Changes, 134
 AXlink, output resolution, vX.XX, and
 serial number, 62

B

Battery, 7
 Battery Charging, docking station, 11
 Baud, 71
 Beep, 60
 Border names and styles, 91, 92
 Brightness, 109
 Brightness button parameters for
 touch panels, 110
 Brightness page, 110
 Button Macro Commands, 158
 BUTTON OPTIONS, 94
 Button Properties, 27
 Button Properties for External
 Pushbuttons, 39
 BUTTON TYPE, 93
 BUTTON TYPE menus, 94
 Button Types, 99, 100
 Buttons String Commands, 157

C

Calibrate, 74
 Channel Color OFF and ON, 97
 CHANNEL-CHAN, 92
 CHANNEL-DEV, 92
 Cleaning the Touch Overlay, 7
 Color palette, 97
 Connectors
 VPT-CP/VPT-GS -VPW-CP/VPW-
 GS, 5, 6
 VPT-CP/VPT-GS -VPW-CP/VPW-
 GS, 6, 7
 VPT-CP/VPW-CP, 6, 7
 Copy, 125
 Copy image, 85
 Create a Page, 23
 Creating a Bargraph, 48
 Creating a Button, 25
 Creating a Joystick, 44
 Creating a Macro Button
 Pulse command, 40
 Wait command, 41
 Creating an IR Macro Button, 39

D

Date, 112

Delete, 86, 126
Designing a Touch Panel Page, 19
Device and channel assignments, 92
Device base, 71
Device Eff., 69, 81
Device range, 70, 81
Device used, 72
Display timer, 60
Double beep, 62

E

Edit Bar – Button Menu Options, 84
Edit Bar – Quit Editor option, 130
Edit button, 82
Editor, 78
Exiting Edit Mode, 55
External buttons, 121

F

Function show, 79

G

General, 100
General Buttons, 14
Go to, 127
Gray Scale and Programming
Numbers, 141

H

Horizontal Bargraph, 107

I

Introduction, 1
Connectors, 6
Features, 2
liquid crystal display (LCD), 1
Overview, 1
IR Memory Check, 167
IRLIB, 161
IRLIB files, 161
IRLIB.EXE, 163

J

Joystick, 104

K

Keyboard, 114
Keypad, 113

L

LEVEL-DEV, 93
LEVEL-NUM, 93
Linking the New Page to the Main
Page, 52
Loading an IR File, 163
Loading Infrared (IR) Files, 161

M

Module version, 69
Move, 85
Move edit, 129

N

Network Eff., 69, 81

O

Operation bars, 16

P

Page Color, 126
Page Menu Options, 124
Page password, 74
Page tracking, 79
Paste, 98
Popup off, 128
Popup on, 127
Power Supply, 8
Power up message, 74
Power up page, 72
Programming, 133
Overview, 133
PC to VPT-CP/VPW-CP
Connections, 133
Programming the VPT-CP/VPW-
CP, 134
Properties, 90
Properties Page – Button Types, 99
Properties Page – External Buttons,
120

Protected, 119
Protected setup, 63
Put on top, 99

R

Related Instruction Manuals, 2
Rename, 126
Resize, 85
Resizing a button, 26
RGB Setup, 118
RGB Setup page without hardware support, 119
RSSI, 69, 81

S

Save, 98
Save default, 98
Server devices, 70, 81
Server version, 69
Set default, 99
Set the channel code, 29
Set the joystick colors for channel off conditions, 47
Set the page color, 24
Set time and date, 61
Setting external button properties, 123
Setting the bargraph colors/shades for channel-off, 51
Setting the bargraph properties, 50
Setting the button border, 28
Setting the button colors for channel off-conditions, 32
Setting the button properties, 27
Setting the button type, 28
Setting the channel code, 29, 46
Setting the joystick properties, 45
Setting the level code, 47, 51
Setting the page flip, 31
Setting the variable text code, 30
Setup, 114
Setup Page, 59
Show palette, 64
Sleep message, 79
SMT-PKM page, 66
Snap grid, 129
SOFTROM.EXE screen, 169
Specifications, 173

VPT-CP Specifications, 173
Standard Buttons, 14
System page, 75
System Send_Commands, 135

T

Text/image, 86
Time, 111
Touch Panel Basics, 13
 General Buttons
 Adjustment button, 15
 Decision buttons, 16
 Information button, 15
 Keypad buttons, 15
 Selection button, 15
 Status buttons, 16
 Overview, 13
 Touch Panel Pages, 14
Touch Panel Program Reference, 59
 Protected Setup Page, 70
 Setup Page
 Buttons
 Brightness, 62
Touch to Continue buttons, 17
TPDesign 3, 13
TPDesign3, 17

U

Upgrading the Firmware
 Configuration, 170
 Downloading the Firmware, 170
Upgrading the Firmware, 169
Using TPDesign3 to Download
 Bitmaps, Icons, and Fonts, 37

V

VAR TEXT-CHAN, 93
VAR TEXT-DEV, 93
Variable Text Send_Commands, 151
Vertical Bargraph, 106
Video Joystick, 116
Video Setup, 115
Video Setup page, 115
Video Window, 116

ViewPoint Color Wireless Touch
Panels, 1
ViewPoint Models, 1
ViewPoint Specifications, 173
ViewPoint WAVE Touch Panels, 1
ViewPort Docking Station, 10
Specifications, 177
VPA-BP ViewPoint Rechargeable
Battery
Specifications, 175
VPA-CHG, 8
VPA-CHG FastCycle Battery Charger,
8
VPA-CHG Fast-Cycle Battery Charger
for VPA-BP
Specifications, 176
VPT-CP ViewPoint Wireless Touch
Panel, 173

W

Wake up message, 73
Wave-Pak not locked, 69, 81
WAV-PKM page, 64
What's in this Manual, 3
What's New, 3
Wireless settings (optional SMT-
PKM), 81
Wireless settings for VPT-CP and
VPT-GS, 67
Wireless Settings for VPW-CP and
VPW-GS, 68, 80
Wireless Settings page for SMT-PKM,
82
Wireless status (optional SMT-PKM),
66
Wireless status (optional WAV-PKM),
64



036-004-1752 03/00 ©2000 AMX, Inc. All rights reserved.

The AMX logo is a registered trademark of AMX Incorporated. All other trademarks contained in this document are the properties of their respective owners. AMX Incorporated reserves the right to alter specifications without notice at any time.

11995 Forestgate Drive 972/644-3048 800/222-0193
Dallas, Texas USA 75243 Fax 972/907-2053 www.AMX.com
Dallas Los Angeles Philadelphia Calgary Toronto Mexico City Singapore

Free Manuals Download Website

<http://myh66.com>

<http://usermanuals.us>

<http://www.somanuals.com>

<http://www.4manuals.cc>

<http://www.manual-lib.com>

<http://www.404manual.com>

<http://www.luxmanual.com>

<http://aubethermostatmanual.com>

Golf course search by state

<http://golfingnear.com>

Email search by domain

<http://emailbydomain.com>

Auto manuals search

<http://auto.somanuals.com>

TV manuals search

<http://tv.somanuals.com>