

AIPTEK®



POCKET DV 4500

Users Manual

Welcome

Dear user, thanks for purchasing this product.

Much investment in time and effort has gone into its development, and it is our hope that it will give you many years of trouble-free service.

Safety Notice

1. Do not drop, puncture or disassemble the camera; otherwise the warranty will be voided.
2. Avoid all contact with water, and dry hands before using.
3. Do not expose the camera to high temperature or leave it in direct sunlight. Doing so may damage the camera.
4. Use the camera with care. Avoid pressing hard on the camera body.
5. For your own safety, avoid using the camera when there is a storm or lightning.
6. Avoid using batteries of different brands or types at the same time. This may lead to the potential for serious damage.
7. Remove batteries during long periods between usage, as deteriorated batteries may affect the functionality of the camera.
8. Remove batteries if they show signs of leaking or distortion.
9. Use only the accessories supplied by the manufacturer.
10. Keep the camera out of the reach of children.



Table of Contents

Welcome	1
Safety Notice	1
Table of Contents	2
Camera Parts	5
<hr/>	
Getting Started	6
Loading the batteries	6
Inserting the SD/MMC card (optional)	7
Attaching the wrist strap (optional)	8
How to hold your camera	9
How to open the connector cover	9
Using the tripod (optional)	10
<hr/>	
Basic Operations	12
Turning on your camera	12
Turning off your camera	12
Setting the language	13
Recording a video clip	14
- How to record a video clip	14
- Setting the focus	15
- Zooming	15
- Selecting metering modes	16
Taking a still picture	17
- How to take a still picture	17
- Using flash strobe	18
- Zooming	18
- Selecting metering mode	18
Recording a voice clip	19
Playing back your recordings	20
- Full-screen view	20
- Thumbnail view	21
- Reviewing a still picture	22
- Playing back a video or audio clip	23
Switching on/off the OSD display	24
Connecting the camera to your TV	25

Table of Contents

Advanced Operations	26
Menu access and operations	26
Digital Video Camcorder menu	27
- Changing the video resolution	27
- Adjusting exposure compensation	28
- Applying special effects to video clips	29
Digital Still Camera menu	30
- Changing picture resolution	30
- Using the self-timer	31
- Adjusting the white balance	32
- Adjusting exposure compensation	33
- Applying special effects to still pictures	34
- Using the date stamp	35
Playback menu	36
- Deleting files	36
- Viewing file information	37
- Locking files	38
- Sorting files	39
Playing MP3 music	40
- Copying MP3 files to the camera	40
- Playing MP3 files	41
MP3 menu	42
- Repeat playing	42
- Setting 3D enhancement	43
- Setting bass effect	44
- Viewing MP3 info	45
- Deleting MP3 files	46
- Holding button settings	47
<hr/>	
Camera Settings	48
Switching to Settings mode	48
Setting the date and time	48
Setting the beep sound	49
Setting the flicker	49
Setting the language	50
Setting auto-off	50

Table of Contents

Formatting media	51
Restoring default settings	51
<hr/>	
Copying Files to Your PC	52
Installing the DV 4500 Driver on your PC	52
Connecting the camera to your PC	54
Copying files to the PC	55
Viewing/Playing files on your PC	57
File location	58
<hr/>	
Using PC Camera	60
Installing DV 4500 software	60
Starting the application	60
Using the DV 4500 PC Camera	63
- Recording an AVI movie	64
- Taking a snapshot	64
- Configuring Format options	64
- Configuring Properties options	65
- Configuring Flicker options	65
<hr/>	
Addenda	66
Flicker Settings Table	66
LED Event Table	66
Storage Capacity Table	67
Battery Life Table	68
System Message Table	69
Specifcatoins	70
Troubleshooting	71
Troubleshooting on USB	74
Aiptek Service	84

Camera Parts

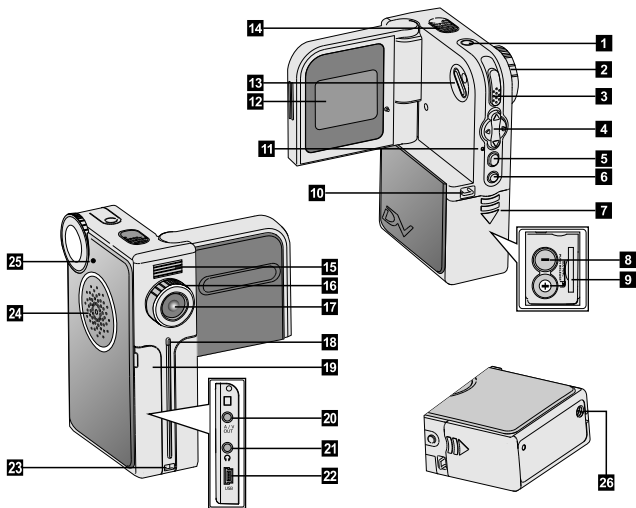

- | | |
|---|------------------------------|
| 1 Power button | 14 Microphone |
| 2 Mode Dial | 15 Flash strobe |
| 3 Record/Shutter/Play/Pause button () | 16 Focus switch |
| 4 Direction buttons () | 17 Lens |
| 5 Menu/OK button () | 18 Self-timer LED |
| 6 INDEX button (INDEX) | 19 Connector cover |
| 7 Battery compartment cover | 20 A/V out connector |
| 8 Battery compartment | 21 Earphone connector |
| 9 Memory card slot | 22 USB connector |
| 10 Strap hook (1) | 23 Strap hook (2) |
| 11 Status LED | 24 Speaker |
| 12 LCD panel | 25 Mode Dial pointer |
| 13 LCD display switch () | 26 Tripod socket |

Getting Started

Loading the batteries

1. Slide the battery compartment cover open in the direction as indicated.

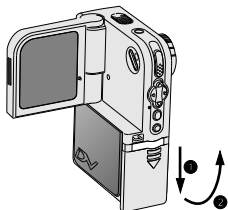

2. Place the batteries into the compartment. Note that the positive(+) and negative(-) ends cannot be reversed.

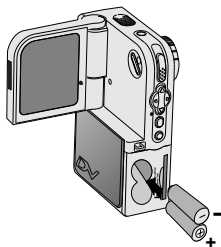

3. After the batteries are properly installed, replace the battery compartment cover.

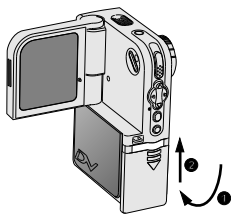

- ⚠** Do not use different types or brands of batteries at the same time.
- ⚠** Alkaline batteries or rechargeable NiMH batteries are recommended for high performance.

Inserting the SD/MMC card (optional)

In addition to 16MB (128Mbits) of built-in flash memory, your camera can store data on a Secure Digital (SD) card or a MultiMedia card (MMC). The supported memory size ranges from 8MB to 512MB.

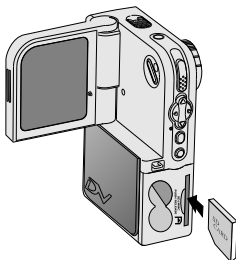

To insert a SD/MMC card, gently push the card as indicated until the card reaches the end of the slot. To remove the card, first gently push the card. After the card pops up, pull the card out of the slot.

The SD card comes with a write-protect switch. When the write-protect switch is set to the **Lock** position, the card will become non-writable. To ensure that the camera can operate normally, you should set the write-protect switch to the **Unlock** position before inserting the SD card.

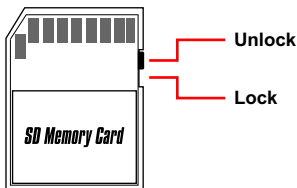

- ⚠ Do not remove the SD/MMC card while the camera is processing data (when the LED indicates red light).
- ⚠ When a SD/MMC card is inserted, the camera will use the card as the main storage media. Files stored in the camera's built-in memory will become inaccessible until the SD/MMC card is removed.

Attaching the wrist strap (optional)

1. Unfasten and separate the strap into two parts.

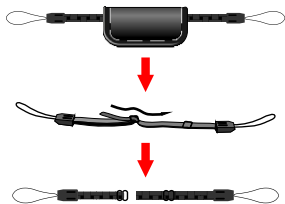

2. Thread one part of the strap into the hook (1) on the back side of the camera.

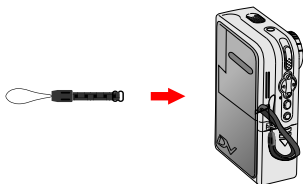

3. Thread the other part of the strap into the hook (2) on the front side of the camera.

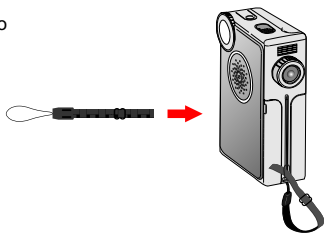

4. Fasten the wrist strap as indicated. Moving the ring on the strap to the right will tighten the strap, and vice versa. Then use the leather wrap to hold the strap.

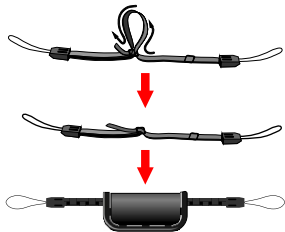

How to hold your camera

Please put your hand through the wrist strap and firmly hold the camera as illustrated. While taking still pictures or recording video clips, avoid blocking the lens to retain the best result.

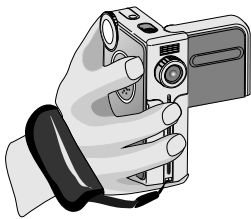

Avoid blocking the lens.

How to open the connector cover

When you want to connect the camera to your PC, TV or earphone, you need to open the connector cover. Please open the cover gently in the direction as illustrated below.



Gently pull up the cover.

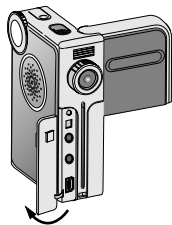

Open the connector cover.

Using the tripod (optional)

Use a tripod to minimize camera movement and ensure optimal image quality, especially while shooting self-portraits or video conferencing.

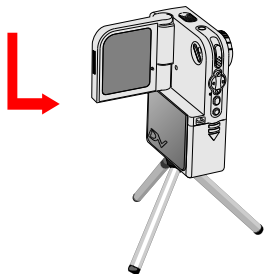
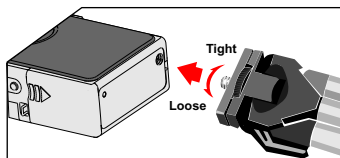

Basic Operations



Basic Operations

Turning on your camera

Press and hold down the power button for 1 second to turn on the camera.

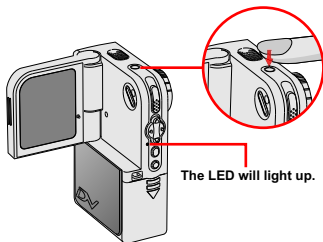

⚠ If the camera is not turned on after pressing the power button, please check:

1. There are two AA batteries installed in the camera.
2. The batteries have enough power left.
3. The polar(+ -) directions of the installed batteries are correct.

Turning off your camera

Press and hold down the power button for 1 second to turn off the camera.

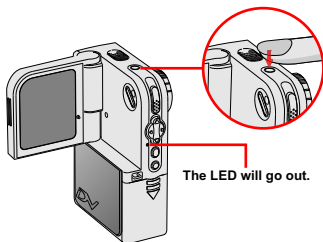

Setting the language

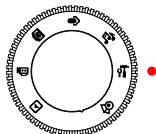

When you power on the camera for the first time, the LCD display may not be shown in your local language. You can set the LCD display language using the method below:

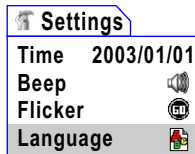

1. Set the **Mode Dial** to the Settings mode, and the Settings menu will display as illustrated.

2. Use the **Up** or **Down** () button to highlight the Language item.



3. When the Language item is highlighted, press the **Menu/OK** () button to enter the sub-menu. In the sub-menu, use the **Up** or **Down** () button to select a suitable language, and then press the **Menu/OK** () button to adopt.



4. After all settings are done, you are ready to use the camera. Set the **Mode Dial** to other modes according to your purpose.

Recording a video clip

How to record a video clip

1. Set the **Mode Dial** to Digital Video Camcorder mode. The LCD display will show the screen below:



LCD Display

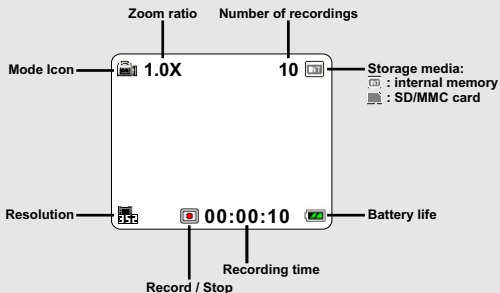

3. Press the **Record/Shutter** () button to start recording.

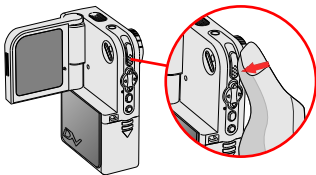

4. Press the **Record/Shutter** () button again to stop recording.

Recording a video clip (continued)

Setting the focus

You can adjust the focus by setting the **Focus Switch**. Normally, you should set the focus to (▲) for most shooting conditions. Select (🌸) only for close-ups. The focus is adjustable during recording.

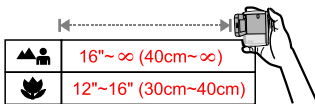

Zooming

While recording, you can press the **Up** or **Down** (⬆) button to zoom in or zoom out the picture.

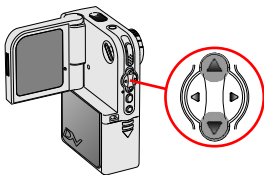

Recording a video clip (continued)

Selecting metering modes

Under normal condition, the light is automatically measured based on overall lighting. If the subject of shooting appears too dark and the background too bright, you can manually select a proper metering mode according to the subject's position.

Pressing the **Right** (▶) button repeatedly will switch the metering mode in the following order:
Auto → Average → Center → Center-low → Auto.

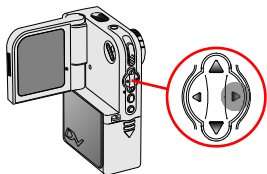

Auto mode (no indicator): When the camera is in Auto mode, the camera will automatically select the best metering method for the overall conditions.

Average mode: When in Average mode, the camera will measure the lighting condition within the bracketed area.

Center mode: When under Center mode, the camera will measure the lighting condition within the central area.

Center-low mode: The camera will focus the metering on the center-low area.

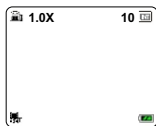

Auto Mode

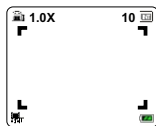

Average Mode

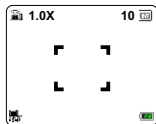

Center Mode

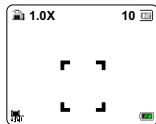

Center-low Mode

Taking a still picture

How to take a still picture

1. Set the **Mode Dial** to Digital Still Camera mode.

The LCD display will show the screen below:

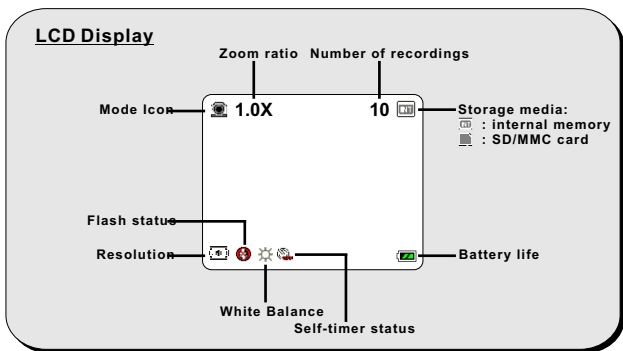
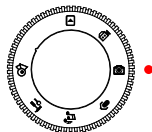

2. Use the **Focus Switch** to set focus as appropriate.

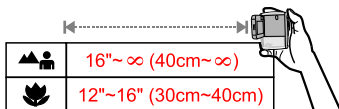

3. Press the **Record/Shutter** button to take a still picture.

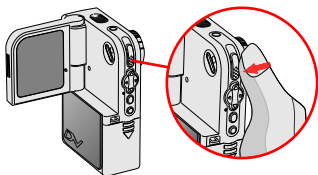

Taking a still picture (continued)

Using the flash strobe

Before taking a still picture, you can set to use the flash strobe if the lighting is not sufficient for your shooting environment.

Pressing the **Left** (◀) button repeatedly will switch the flash mode in the following order:
Off → Auto → Off.

Off (🚫): The flash is disabled.

Auto (🌿): The flash automatically fires when the lighting is insufficient.

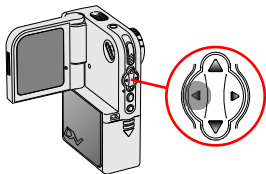

- ▲ 1. If the battery life icon indicates , the flash strobe may be disabled due to insufficient voltage. Please change batteries immediately.
- 2. You cannot take pictures when the flash strobe is recharging.

Zooming

Before taking a still picture, you can press the **Up** or **Down** (⬆) button to zoom in or zoom out the picture.

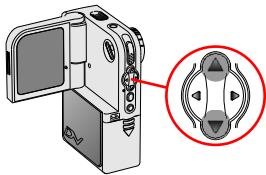

Selecting metering modes

Before taking a still, you can press the **Right** (▶) button to select a metering mode. The metering mode changes in the following order:
Auto → Average → Center → Center-low → Auto.

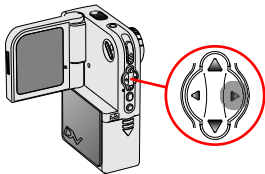

For a detailed description of each metering mode, please see page 16.

Recording a voice clip

1. Set the **Mode Dial** to Voice Recording mode.

The LCD display will show the screen below:

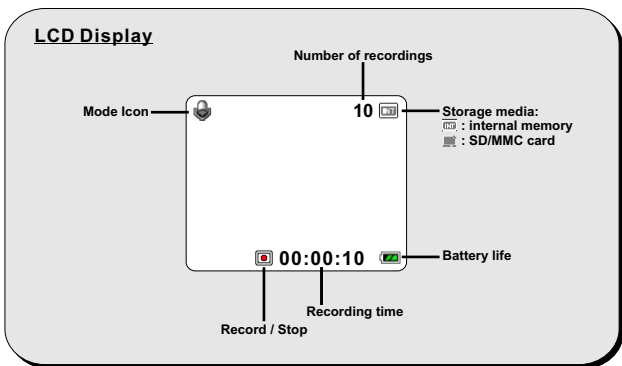

2. Press the **Record/Shutter** (📷) button to start recording.

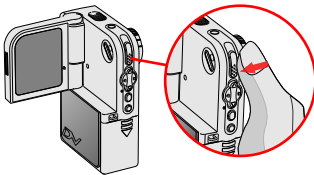

3. Press the **Record/Shutter** (📷) button again to stop recording.

Playing back your recordings

Full-screen view

The Playback mode allows you to review the files stored in the SD/MMC card or internal memory.

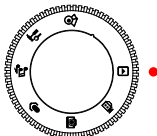

1. Set the **Mode Dial** to Playback mode.

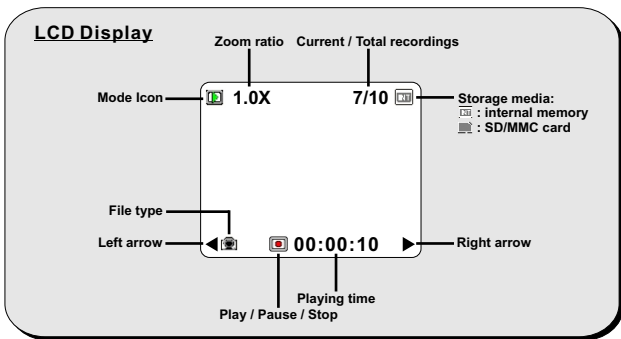

2. When you set the **Mode Dial** to Playback mode, the last recorded file will be automatically played.

3. If you want to view other files stored in the camera, you can use the **Right** and **Left** buttons (◀▶) to shift between files.

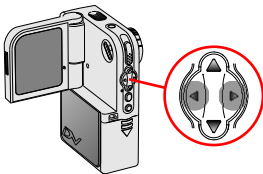



Playing back your recordings (continued)

Thumbnail view

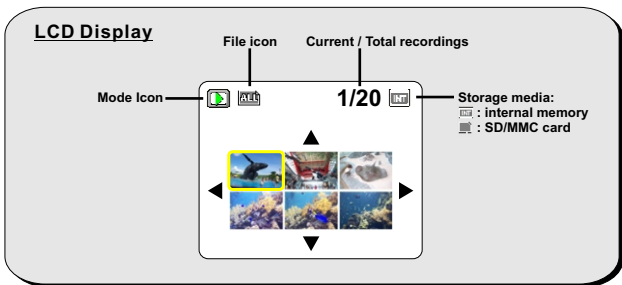
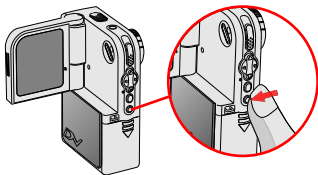
If you press the **INDEX** (**INDEX**) button under playback mode, the camera will be switched to thumbnail view. Then you can use the four direction (**◀▶**) buttons to select the file you want to view. Once you select the target file, press either the **Record/Shutter** (**⏏**) button or the **INDEX** (**INDEX**) button to view the file.



There are three file types that you can identify by the icons on the thumbnails:

-  : JPG format pictures
-  : ASF format video clips
-  : WAV format audio clips

For detailed operations on viewing a still picture, please see page 22. For detailed operations on playing a video or audio clip, please see page 23.

Playing back your recordings (continued)

▶ Reviewing a still picture

While viewing the picture in full-screen mode, you can use the **Up** or **Down** (▲▼) button to zoom in or zoom out the picture.

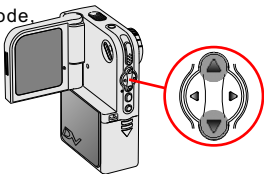

If you zoom in the picture and then press the **Record/Shutter** (⏻) button, the zoom ratio will be locked. You can then browse the picture using the direction (◀▶) buttons. To unlock the zoom ratio, press the **Record/Shutter** (⏻) button again.



Full Screen



Zoom-lock Screen

While viewing a still picture, the available function buttons are as follows:

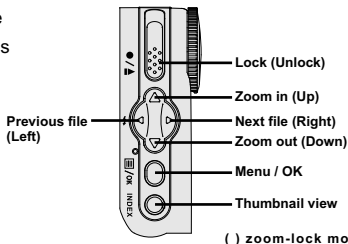

Playing back your recordings (continued)

▶ Playing back a video or audio clip

When playing back the video or audio clip, pressing the **Record/Shutter** (⏏) button can pause the playing. To resume playing, press the same button again.

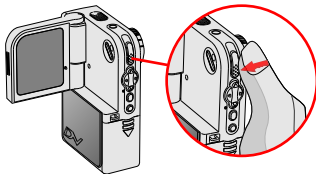

While playing the file, pressing the **Up** or **Down** (▲/▼) button can adjust the sound volume. If you press the **Right** or **Left** (▶/◀) button during playing, you can fast wind or rewind the video or audio clip.



Playing a video clip



Adjusting volume

While playing a video or audio clip, the available function buttons are as follows:

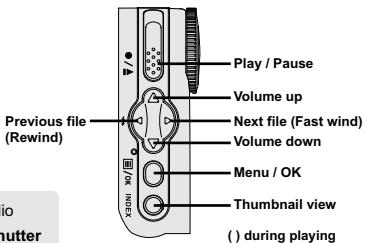

▲ While playing back an video or audio clip, you must press the **Record/Shutter** (⏏) button to pause or stop the playing. Then can you use the **Right** or **Left** (▶/◀) button to shift between files.

Switching on/off the OSD display

When playing back a video clip or reviewing a still picture, you can press the LCD display switch () to disable the OSD display, thus gaining a clearer view for your display. Press the same button again will switch on the display.

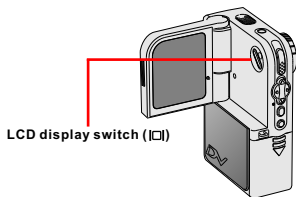

Connecting the camera to your TV

Connect your camera and TV via an AV cable for real-time display. You can display your video clips, still pictures, audio recordings, as well as the MP3 files you uploaded, directly on your TV screen to share them with friends and family members.

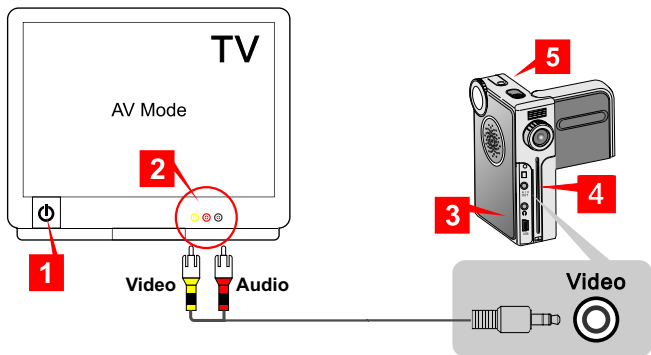

- 1** Turn on your TV and switch to AV mode.
- 2** Connect the audio and video ends of the AV cable to your TV.
- 3** Open the connector cover of your camera. (page 9)
- 4** Connect the other end of the video cable to your camera.
- 5** Turn on the camera.



Advanced Operations



Menu access and operations

In several modes, you can bring up the menu to fine tune the camera settings by changing the menu items. The following describes how you can bring up the menu and perform normal operations to complete an action:

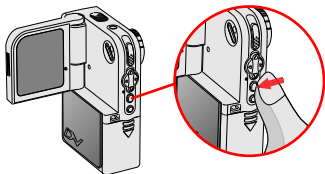

1. Set the **Mode Dial** to your target mode.

Press the **Menu/OK** ( /OK) button to bring up the menu.

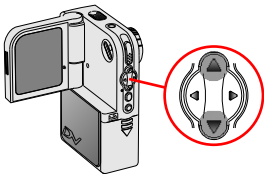

2. Press the **Up or Down** () button to select the target item. Once the target item is selected, press the **Menu/OK** ( /OK) button to confirm the selection.



3. If you want to exit a menu screen, you can select the **Exit** () item and press the **Menu/OK** ( /OK) button, or you can press the **Record/Shutter** () button to quick-exit the menu.

⚠ In the Voice Recording mode, the **Menu/OK** ( /OK) button has no function.

Digital Video Camcorder menu



Changing the video resolution

Before recording a video clip, you can change the resolution to suit your viewing preferences.

To change the video resolution:



1. While in Digital Video Camcorder mode, press the **Menu/OK** ( /OK) button.

2. A menu as illustrated on the right will appear.

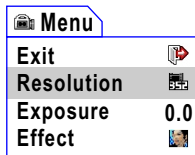
Press the **Up** or **Down** () button to highlight the Resolution item. Once the Resolution item is highlighted, press the **Menu/OK** ( /OK) button.



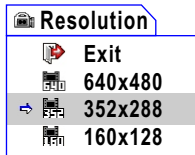

3. A sub-menu as illustrated on the right will appear.

Press the **Up** or **Down** () button to select a resolution setting, and then press the **Menu/OK** ( /OK) button to apply.



The three items you can choose from are:

-  **640x480**: best resolution, suitable for shooting stable subjects.
-  **352x288**: suitable for viewing on TV. The display quality is similar to VCD.
-  **160x128**: low resolution with the smoothest flow.

Digital Video Camcorder menu (continued)

Adjusting exposure compensation



You can manually adjust the exposure to gain better effect when the previewed image appears too bright or too dark.

To adjust exposure compensation:

1. While in Digital Video Camcorder mode, press the **Menu/OK** (☰/OK) button.

2. A menu as illustrated on the right will appear.

Press the **Up** or **Down** (▲/▼) button to highlight the Exposure item. Once the Exposure item is highlighted, press the **Menu/OK** (☰/OK) button.

Menu	
Exit	
Resolution	
Exposure	0.0
Effect	

3. A sub-menu as illustrated on the right will appear.

Press the **Up** or **Down** (▲/▼) button to select an item and then press the **Menu/OK** (☰/OK) button to apply.

Exposure	
	+0.3
	0.0
	-0.3
	-0.6

The applicable value ranges from -1.5 to +1.5. A positive value indicates the display will be brighter than usual; while a negative value makes the display dimmer. The default setting is 0.0.

Digital Video Camcorder menu (continued)



Applying special effects to movie clips

When recording a video clip, you can apply a special effect to the clip to add a personal touch.

To select a special effect:



1. While in Digital Video Camcorder mode, press the **Menu/OK** ( /OK) button.

2. A menu as illustrated on the right will appear.

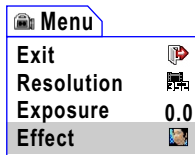
Press the **Up** or **Down** () button to highlight the Effect item. Once the Effect item is highlighted, press the **Menu/OK** ( /OK) button.



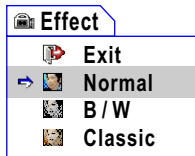

3. A sub-menu as illustrated on the right will appear.

Press the **Up** or **Down** () button to highlight an item, and then press the **Menu/OK** ( /OK) button to apply.



The three effects you can choose from are:

-  **Normal:** This option allows you to record the movie in natural color. It is also the default setting.
-  **B / W:** This option allows you to record the movie in black and white.
-  **Classic:** With this option selected, the movie will be sepia-toned, making the movie look like an old classic film.

Digital Still Camera menu

Changing picture resolution

Changing the resolution will affect the number of pictures that can be taken. The higher the resolution, the more memory-demanding the images will be.

To change the video resolution:

1. While in Digital Still Camera mode, press the **Menu/OK** (M/OK) button.

2. A menu as illustrated on the right will appear.

Press the **Up** or **Down** (▲/▼) button to highlight the Resolution item. Once the Resolution item is highlighted, press the **Menu/OK** (M/OK) button.

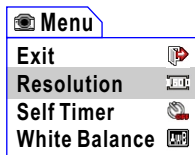



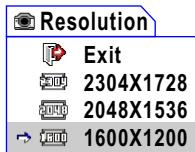

3. A sub-menu as illustrated on the right will appear.

Press the **Up** or **Down** (▲/▼) button to select an item and then press the **Menu/OK** (M/OK) button to apply.



The three items you can choose from are:

-  **2304X1728**: the most memory-demanding option. This resolution is ideal for developing 4x6 pictures.
-  **2048X1536**: the above-average option. This resolution is ideal for developing 3x5 or 4x6 pictures.
-  **1600X1200**: the mediocre option. This resolution is also suitable for developing 3x5 or 4x6 pictures.
-  **640X480**: the most memory-saving option. This resolution is suitable for viewing on the computer.

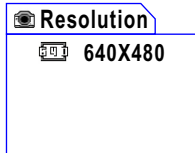

Digital Still Camera menu (continued)

Using the self-timer

This function comes in handy when you want to take a self-portrait picture.
To enable the self timer:

1. While in Digital Still Camera mode, press the **Menu/OK** (M/OK) button.

2. A menu as illustrated on the right will appear.

Press the **Up** or **Down** (▲/▼) button to highlight the Self Timer item. Once the Self Timer item is highlighted, press the **Menu/OK** (M/OK) button.

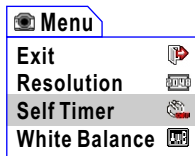

3. A sub-menu as illustrated on the right will appear.

Press the **Up** or **Down** (▲/▼) button to select On and press the **Menu/OK** (M/OK) button to apply.

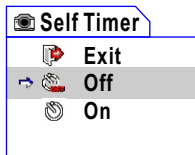

After the self timer is turned on, the camera will have ten seconds delay before taking a picture when the **Record/Shutter** (S) button is pressed. After the shutter fires, the self timer will be automatically disabled.



Digital Still Camera menu (continued)

Adjusting the white balance



You can manually select the white balance setting to suit the shooting environment.

To select a white balance setting:

1. While in Digital Still Camera mode, press the **Menu/OK** () button.

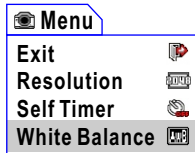



2. A menu will appear. Press the **Up** or **Down** () button to highlight the White Balance item. Once the White Balance item is highlighted, press the **Menu/OK** () button.

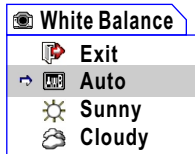

3. Press the **Up** or **Down** () button to scroll page and select an item. Then press the **Menu/OK** () button to apply.



There are five effects you can choose from:

-  **Auto:** The camera will determine the best white balance setting for your shooting environment.
-  **Sunny:** suitable for normal outdoor shooting in sunny weather.
-  **Cloudy:** suitable for shooting under cloudy weather or shady environments.
-  **Tungsten:** suitable for indoor shooting with incandescent lamp lighting, or environments with low color temperature.
-  **Fluorescent:** suitable for indoor shooting with fluorescent lamp lighting, or environments with high color temperature.

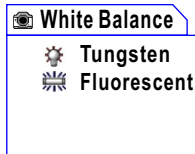

Digital Still Camera menu (continued)

Adjusting exposure compensation

You can manually adjust the exposure to gain better effects when the previewed image appears too bright or too dark.

To adjust exposure compensation:

1. While in Digital Still Camera mode, press the **Menu/OK** (M/OK) button.

2. A menu will appear. Press the **Up** or **Down** (▲/▼) button to scroll page and highlight the Exposure item. Once the Exposure item is highlighted, press the **Menu/OK** (M/OK) button.

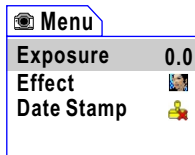

3. A sub-menu as illustrated on the right will appear.
Press the **Up** or **Down** (▲/▼) button to select an item and then press the **Menu/OK** (M/OK) button to apply.

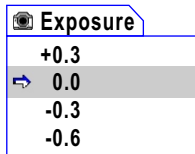

The applicable value ranges from -1.5 to +1.5. A positive value indicates the display will be brighter than usual; while a negative value makes the display dimmer. The default setting is 0.0.

Digital Still Camera menu (continued)

Applying special effects to still pictures

You can apply special effects to your pictures to add a personal touch.

To select a special effect:

1. While in Digital Still Camera mode, press the **Menu/OK** (M/OK) button.

2. A menu will appear. Press the **Up** or **Down** (▲/▼) button to scroll page and highlight the Effect item. Once the Effect item is highlighted, press the **Menu/OK** (M/OK) button.

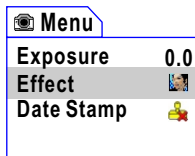

3. A sub-menu as illustrated on the right will appear. Press the **Up** or **Down** (▲/▼) button to select an item and then press the **Menu/OK** (M/OK) button to apply.

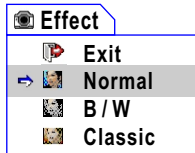

The three effects you can choose from are:

- Normal:** This option allows you to take the picture in natural color. It is also the default setting.
- B / W:** This option allows you to take the picture in black and white.
- Classic:** With this option selected, the picture will be sepia-toned, making the image look like an old photo.

Digital Still Camera menu (continued)

Using the date stamp

Enabling the date stamp will print the date of shooting on the picture.

To enable the date stamp:

1. While in Digital Still Camera mode, press the **Menu/OK** (M/OK) button.

2. A menu as illustrated on the right will appear.

Press the **Up** or **Down** (▲/▼) button to highlight the Date Stamp item. Once the Date Stamp item is highlighted, press the **Menu/OK** (M/OK) button.

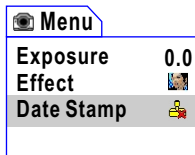

3. A sub-menu as illustrated on the right will appear.

Press the **Up** or **Down** (▲/▼) button to select On and press the **Menu/OK** (M/OK) button to apply.

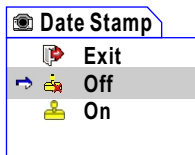

After the date stamp is turned on, a date mark will be printed on the pictures taken.

▲ Before enabling this function, please make sure that the date and time are correctly set up. See page 48 for more information.



Playback menu

Deleting files



While reviewing your recordings, you can delete the files that you do not want to preserve.

To delete a file or all files:

1. While in Playback mode, press the **Menu/OK** () button.

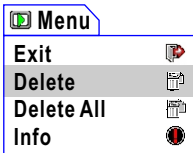
2. A menu will appear. Press the **Up** or **Down** () button to highlight the Delete or Del All item depending on your purpose. Once the desired item is selected, press the **Menu/OK** () button.



3. Depending on the item you select, the corresponding sub-menu will appear. If you select Delete to delete one file, you can use the **Left** or **Right** () button to shift between files in the sub-menu. Press the **Up** or **Down** () button to select the check mark and then press the **Menu/OK** () button to confirm the deletion.

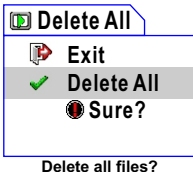

 You can not delete a file that has been locked. Please see page 38 for more information.



Playback menu (continued)

Viewing file information



The file information provides you data such as date of recording, file size, and lock status.

To view the file information:

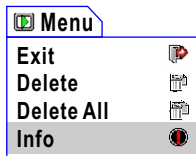

1. While in Playback mode, press the **Menu/OK** () button.

2. A menu will appear. Press the **Up** or **Down** () button to highlight the Info item. Once the Info item is highlighted, press the **Menu/OK** () button.

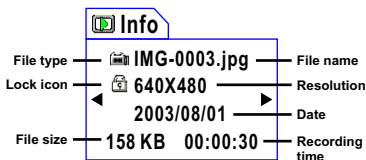

3. An info page of the file will then appear. Note that the actual display shown depends on the file type. You can also press the **Right** or **Left** () button to shift between files. When you want to exit, press the **Menu/OK** () button.



 If there is a lock icon () on the screen, it indicates the file has been locked.

Playback menu (continued)

Locking files

The locking file function can prevent files from being accidentally erased.

To lock a file or all files:

1. While in Playback mode, press the **Menu/OK** (≡/OK) button.

2. A menu will appear. Press the **Up** or **Down** (⬆/⬇) button to scroll page and highlight the **Lock** or **Lock All** item. Once the desired item is selected, press the **Menu/OK** (≡/OK) button.

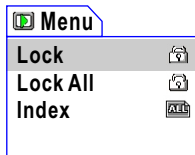

3. Depending on the item you select, the corresponding sub-menu will appear. If you select **Lock** to lock one file, you can use the **Left** or **Right** (◀▶) button to shift between files in the sub-menu. Press the **Up** or **Down** (⬆/⬇) button to select the check mark and then press the **Menu/OK** (≡/OK) button to confirm the lock action.

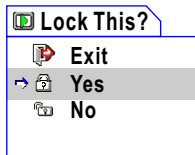

Lock current file?

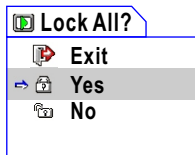

Lock all files?

Playback menu (continued)

Sorting files

The sorting file function allows you to select the file type you want the camera to display in the thumbnail mode.

To enable the sorting file function:

1. While in Playback mode, press the **Menu/OK** (☰/OK) button.

2. A menu will appear. Press the **Up** or **Down** (▲/▼) button to scroll page and highlight the Index item. Once the Index item is selected, press the **Menu/OK** (☰/OK) button.

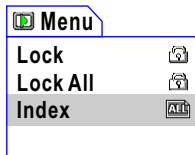

3. A sub-menu as illustrated on the right will appear. Press the **Up** or **Down** (▲/▼) button to select a file type and then press the **Menu/OK** (☰/OK) button to confirm the selection. After the file type is determined, only files of the selected type will be displayed in the thumbnail mode.

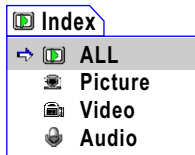

Playing MP3 music

Copying MP3 files to the camera

Before you can play MP3 music, you need to copy MP3 files to the camera.

1. To upload MP3 files to the camera, you need to connect the camera to a PC using the USB cable. For details on connecting the camera to your PC, please see page 54.

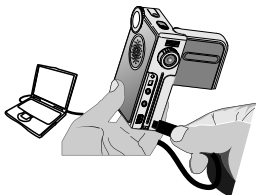

2. After the camera is connected to the PC, double-click on **My Computer** and you will find a removable disk. Inside the removable disk you can locate a **MP3** folder. Then you can copy the desired MP3 files into the folder for playing.

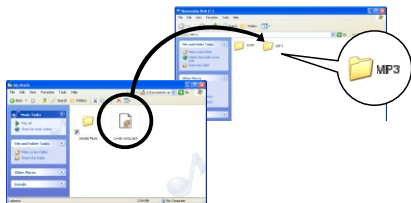

- ⚠** To take advantage of the removable disk function, Windows 98SE users may need to install the USB Mass Storage Driver. For details on the installation, please refer to page 52-53.

Playing MP3 music (continued)

▶ Playing MP3 files

1. Set the **Mode Dial** to MP3 mode, and you are ready to play MP3 music. The LCD display will show the screen as below:

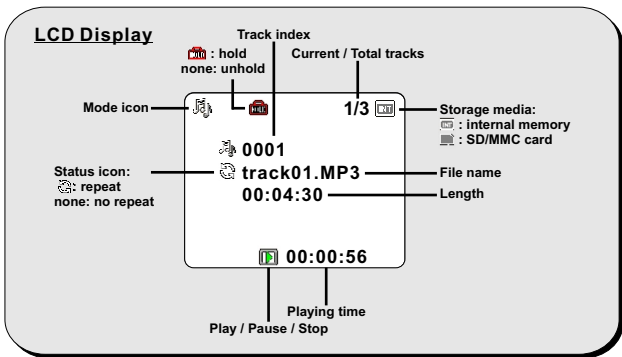
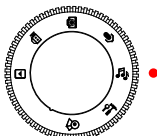

2. The available function buttons in MP3 mode are as illustrated on the right.

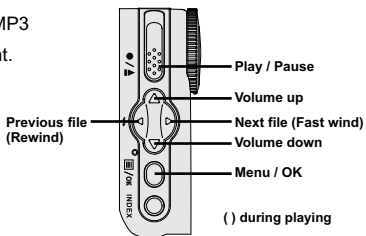

MP3 menu

You can use several functions provided by the MP3 menu. Note that there are no MP3 files in the camera, the menu cannot be activated.



Repeat playing

You can repeat playing to save the trouble of pressing the play button.

To repeat playing MP3 music:



1. While in MP3 mode, press the **Menu/OK** ( /OK) button.

2. A menu as illustrated on the right will appear.

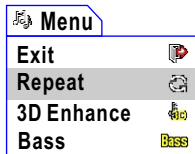
Press the **UP** or **Down** () button to select Repeat item. Once the Repeat item is selected, press the **Menu/Ok** ( /OK) button.



3. A sub-menu as illustrated on the right will appear.

Press the **Up** or **Down** () button to select Yes, and then press the **Menu/OK** ( /OK) button to confirm the selection.

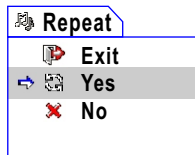

MP3 menu (continued)

Setting 3D enhancement

You can enable the 3D enhancement effect to enrich the sound quality.
To enable the 3D enhancement effect:

1. While in MP3 mode, press the **Menu/OK** (☰/OK) button.

2. A menu as illustrated on the right will appear.

Press the **UP** or **Down** (▲/▼) button to select 3D Enhance item. Once the 3D Enhance item is selected, press the **Menu/Ok** (☰/OK) button.

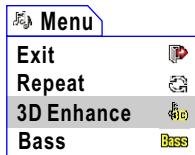

3. A sub-menu as illustrated on the right will appear.

Press the **Up** or **Down** (▲/▼) button to select a desired item, and then press the **Menu/OK** (☰/OK) button to confirm the selection:

Strong: The 3D effect is the strongest.

Low: The 3D effect is moderate.

Off: The 3D effect is disabled.

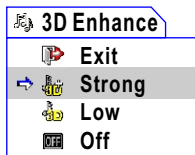

MP3 menu (continued)

Setting bass effect

You can enhance the sound quality by enabling the bass effect.

To enable the bass effect:

1. While in MP3 mode, press the **Menu/OK** (☰/OK) button.

2. A menu will appear. Press the **Up** or **Down** (▲/▼) button to highlight the Bass item. Once the Bass item is selected, press the **Menu/OK** (☰/OK) button.

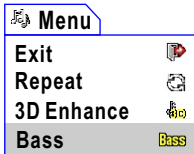

3. A sub-menu as illustrated on the right will appear. Press the **Up** or **Down** (▲/▼) button to select a desired item, and then press the **Menu/OK** (☰/OK) button to confirm the selection:

Strong: The Bass effect is the strongest.

Low: The Bass effect is moderate.

Off: The Bass effect is disabled.



MP3 menu (continued)

Viewing MP3 info

This item enables you to view the MP3 file information.

To enable the bass effect:

1. While in MP3 mode, press the **Menu/OK** (☰/OK) button.

2. A menu will appear. Press the **Up** or **Down** (⬆/⬇) button to scroll page and highlight the Info item. Once the Info item is selected, press the **Menu/OK** (☰/OK) button.

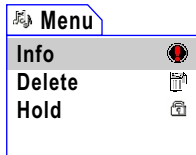

3. A sub-menu as illustrated on the right will appear. The information of the selected file will be displayed on the screen. You can also press the **Right** or **Left** (◀▶) button to shift between files. When you want to exit, press the **Menu/OK** (☰/OK) button.

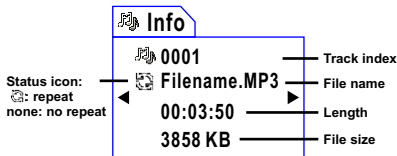

MP3 menu (continued)

Deleting MP3 files

Deleting MP3 files can free some memory space for other purposes.

To delete MP3 files:

1. While in MP3 mode, press the **Menu/OK** (☰/OK) button.

2. A menu will appear. Press the **Up** or **Down** (▲/▼) button to scroll page and highlight the Delete item. Once the Delete item is selected, press the **Menu/OK** (☰/OK) button.

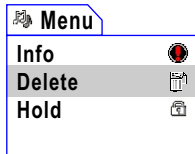

3. A sub-menu as illustrated on the right will appear. Press the **Up** or **Down** (▲/▼) button to select Delete, and then press the **Menu/OK** (☰/OK) button to confirm the deletion.





MP3 menu (continued)



Holding button settings

Holding the button settings can prevent current status from being changed, so that you can carry the camera without worrying about the settings being changed. To hold button settings:

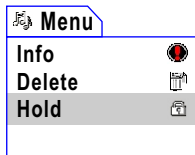

1. While in MP3 mode, press the **Menu/OK** (/OK) button.

2. A menu will appear. Press the **Up** or **Down** () button to scroll page and highlight the Hold item. Once the Hold item is selected, press the **Menu/OK** (/OK) button.

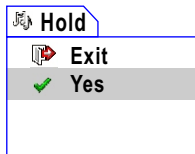

3. A sub-menu as illustrated on the right will appear. Press the **Up** or **Down** () button to select Yes, and then press the **Menu/OK** (/OK) button to confirm the selection.



4. To unlock the status, press any button except the power button, and a menu will pop up as indicated. Press the **Up** or **Down** () button to select Yes, and then press the **Menu/OK** (/OK) button to confirm.

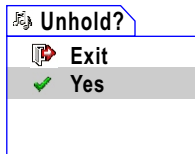

⚠ Make sure the settings are correctly configured before activating this function.

Camera Settings

Switching to Settings mode

Set the **Mode Dial** to Settings mode, and you can fine tune several functions of the camera.

When you set the **Mode Dial** to the Settings mode, the menu as illustrated will display. For details on each setting, please refer to the corresponding page.

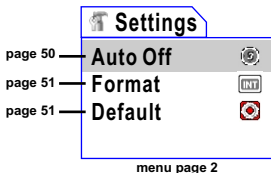
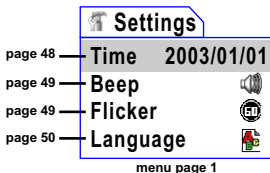
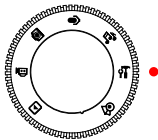





Setting the date and time

1. While in Settings mode, use the **Up** and **Down** (▲▼) buttons to highlight the Time item, and then press the **Menu/Ok** (⏏/OK) button to enter the sub-menu.

2. Use the **Right** and **Left** (◀▶) buttons to shift between items. Use the **Up** and **Down** (▲▼) buttons to adjust the value. When the settings are done, press the **Menu/OK** (⏏/OK) button to confirm.





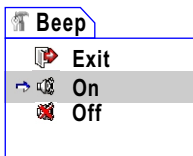

Setting the beep sound

1. While in Settings mode, use the **Up** and **Down** () buttons to highlight the Beep item, and then press the **Menu/Ok** () button to enter the sub-menu.
2. Use the **Up** and **Down** () buttons to select On or Off. When the desired item is selected, press the **Menu/Ok** () button to confirm.





Setting the flicker

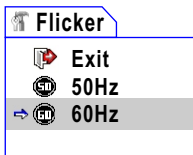

1. While in Settings mode, use the **Up** and **Down** () buttons to highlight the Flicker item, and then press the **Menu/Ok** () button to enter the sub-menu.
2. Use the **Up** and **Down** () buttons to select the desired flicker setting. When the desired item is selected, press the **Menu/Ok** () button to confirm.



 If you travel to another country, the flicker setting may not suit the country you are staying in. For more details on flicker settings, please refer to page 66.



Setting the language

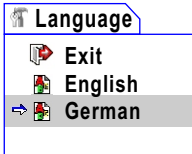

1. While in Settings mode, use the **Up** and **Down** () buttons to highlight the Language item, and then press the **Menu/Ok** () button to enter the sub-menu.

2. Use the **Up** and **Down** () buttons to select a suitable language. When the desired item is selected, press the **Menu/OK** () button to confirm.





Setting auto-off

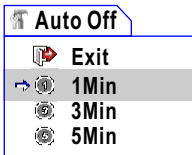

1. While in Settings mode, use the **Up** and **Down** () buttons to highlight the Auto Off item, and then press the **Menu/Ok** () button to enter the sub-menu.

2. Use the **Up** and **Down** () buttons to select a desired item. When the desired item is selected, press the **Menu/OK** () button to confirm.



Formatting media



1. While in Settings mode, use the **Up** and **Down** () buttons to highlight the **Format** item, and then press the **Menu/Ok** () button to enter the sub-menu.

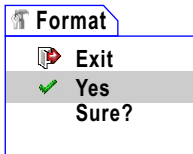

2. Use the **Up** and **Down** () buttons to select **Yes**, and then press the **Menu/OK** () button to confirm.



⚠ Formatting the media will erase all files stored in the SD/MMC card or internal memory. Note that locked files will also be erased.

Restoring default settings

1. While in Settings mode, use the **Up** and **Down** () buttons to highlight the **Default** item, and then press the **Menu/Ok** () button to enter the sub-menu.

2. Use the **Up** and **Down** () buttons to select **Yes**, and then press the **Menu/OK** () button to confirm.

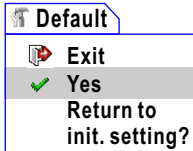

⚠ Restoring default settings will override your current settings.



Copying Files to Your PC

Installing the DV 4500 Driver on your PC

You need to install **DV 4500 Driver** to ensure that video clips can be played back on your PC. To install the software:

1. Turn on your computer. Then place the accessory CD into the CD-ROM drive.

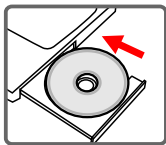

- ⚠ Do not connect the USB cable to your computer now.
- ⚠ Shut down all other applications running on your computer.
- ⚠ If the title screen does not appear automatically, please double-click on **My Computer** and then the CD-ROM drive. Then browse to the folder "DV 4500 Driver" and start the **Setup.exe** program manually.

2. Click on the  icon to launch the installation of **DV 4500 Driver**.

⚠ Notice for Windows 2000 users:

During the installation process, the warning message regarding digital signature may appear twice or more. Please click **Yes** to continue the process. The software is fully compatible with Windows 2000 operation system.

Installing the DV 4500 Driver on your PC (continued)

3. The **Install Shield Wizard** will then appear and automatically install the program. Please click on **Next** and follow the on-screen instructions to complete the installation.

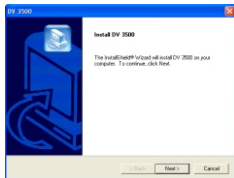

4. After the driver installation is completed, the program will prompt you to install **Windows Media Player Codecs**. If you are not sure if the codec has been installed in your computer, please click **Yes** and follow the on-screen instructions to complete the installation.



5. After the codec installation is completed, the program will prompt you to install **Direct X 8.0** or above. If you are not sure if this program has been installed in your computer, please click **Yes** to continue.



⚠ Windows Media Player Codecs and **Direct X 8.0** or above are necessary for viewing the video clips recorded by the camera.

6. After the installation is completed, you may need to restart your computer for the driver to take effect.

Connecting the camera to your PC

1. Turn on your computer, and then connect the USB cable to the USB port of your computer. Make sure the cable and the port are correctly aligned.

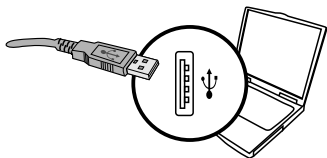

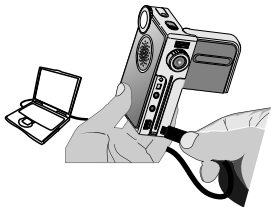

2. Set the camera to any mode except Live (👤) mode, and then connect the other end of the USB cable to your camera.



⚠ Notice for Windows 2000/XP/ME users:

If you select **DISK** mode and then want to disconnect the camera from your computer, please follow these steps:

1. Double-click  on the system tray.
2. Click , and then click **Stop**.
3. Select the camera when the confirmation screen appears and click **OK**.
4. Follow the on-screen instructions to safely disconnect the camera from your computer.

Copying files to the PC

1. This step varies depending on your operation system:

For Windows XP users:

After the camera is connected to your computer, a dialogue window will appear automatically. Please select the item **Open folder to view files using Windows Explorer** and click **OK**.

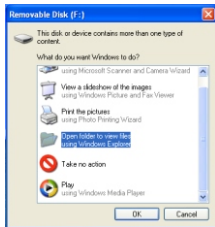

For Windows 2000/ME/98SE users:

Double-click on **My Computer**. Then double-click on the icon of the removable disk that has just appeared.

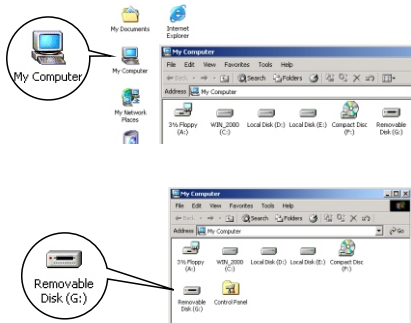

⚠ Some users may find two removable disks appear under **My Computer**, that is because the OS detects two storage media in the camera (the internal memory and the SD/MMC card). If you can not find your files in one of the disks, please try to find them in the other disk.

Copying files to the PC (continued)

2. Double-click on the **DCIM** file folder.

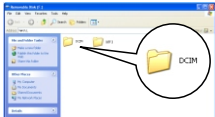

Windows XP

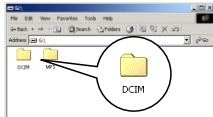

Windows 2000/ME/98 SE

3. Double-click on the **100MEDIA** file folder.

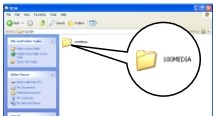

Windows XP



Windows 2000/ME/98 SE

4. Drag the target file into **My Documents** or the destination folder.

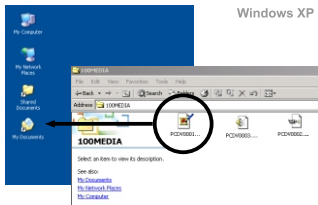

Windows XP



Windows 2000/ME/98 SE

Viewing/Playing files on your PC

1. Double-click on **My Documents** or any other folder that stores your files.

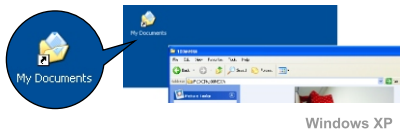

2. Double-click on the desired file, and the file will be opened by the program matching the file's type.

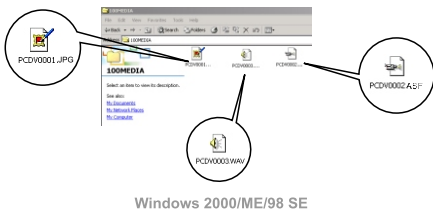

File location

After connecting the camera to your computer, a removable disk will appear in your computer. Under the disk you can find all files stored in your camera. See the figure in the right to see where different types of files are located. Note that MP3 format files must be copied into the MP3 folder, or the camera will not be able to locate the MP3 files.

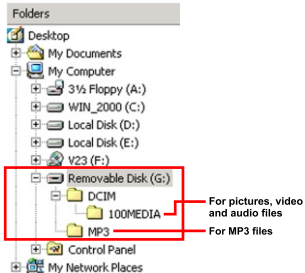

Using PC Camera

Using PC Camera

Installing DV 4500 software

You need to install **DV 4500** software to take advantage of the PC camera function. If you have not yet installed the software, please refer to page 52 for details on installing the package.

Starting the application

1. Set the **Mode Dial** to Live (👤) mode.

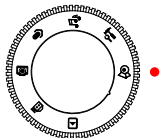

2. Connect the camera to your computer.

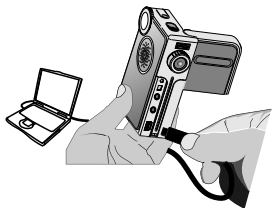

! If you want to use the Video Conferencing function, please install programs such as **Netmeeting** to serve the purpose.

Notice for Windows ME users:

When the following screen appears, please select **Automatic search for a better driver** and click **Next** to continue.



Starting the application (continued)

Notice for Windows 98SE users:

1. Click **Next** when the following screen appears.



2. When the following screen appears, please select **Search for the best driver for your device** and click **Next** to continue.



3. During the installation process, some users might be asked to insert a licensed 98SE CD into the CD-ROM drive to copy the needed files.
4. Follow the on-screen instructions to finish the installation.

Notice for Windows 2000 users:

When using the PC camera function for the first time, the following warning message may appear twice or more. Please click **Yes** to continue the process. The camera is fully compatible with Windows 2000 operation system.

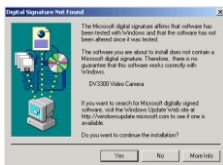
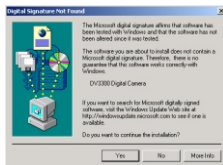

Starting the application (continued)

3. Double-click the **DV 4500** icon on the Desktop to start the program. After the program is started, you can begin to use the PC camera function.

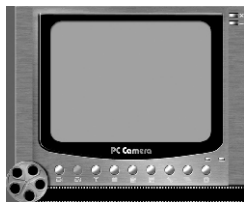

- !** If you cannot find the program shortcut on the desktop, you can start the program from the **Programs** menu.

Using the DV 4500 PC Camera

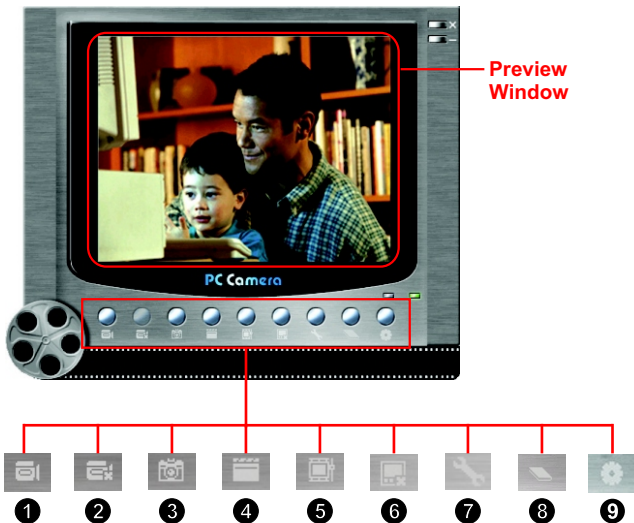



- 1 Start recording a video clip
 - 2 Stop recording
 - 3 Snapshot
 - 4 Format *
 - 5 Properties *
 - 6 Start/Stop preview window
 - 7 Setting *
 - 8 Open album (where files are stored)
 - 9 Select video source
- * Sub-menu is available.

⚠ To view pictures taken by DV 4500 PC Camera, please click on  to open the photo album. Or, as an alternate option, go to the "Work Temp" folder to find files taken by the program. The full path is as following:
C:\Program Files\DV 4500\Work Temp

Using the DV 4500 PC Camera (continued)

Recording an AVI movie

1. Click on the  icon.
2. Press  to specify the path and name of the AVI file.
3. Set the frame rate and recording time according to your needs.
4. Press the **Start Record** button to begin recording.
5. To stop recording, click on the  icon.

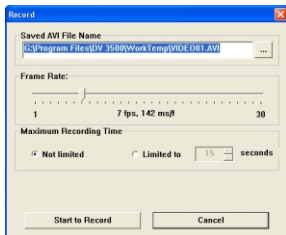

Taking a snapshot

Click on the  icon to take a snapshot.

Configuring Format options

● Color Space:

Select one of the following functions according to your needs.

- RGB 24: This item is for retaining better quality.
- I420: This item indicates the AVI movie will be more compressed to gain the advantage of faster processing speed.

● Output Size:

Set output size to change the size of the preview window. The default size is 320x240. Select larger pixels when you need a larger preview window.

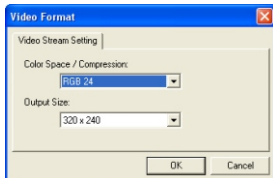

Using the DV 4500 PC Camera (continued)

Configuring Properties options

● Video setting:

- Banding Filter: If the screen of your computer flickers when using PC Camera function, change this setting to avoid noise.

- Bandwidth: If the network bandwidth is congested when using PC Camera, select a smaller value in the "Bandwidth" item to avoid this problem.

● Custom setting:

You can use the default settings, or change the settings (such as brightness, contrast, saturation, and sharpness) on your own.

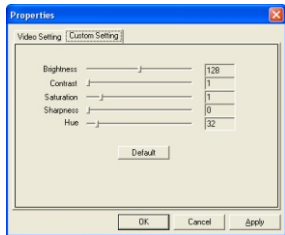
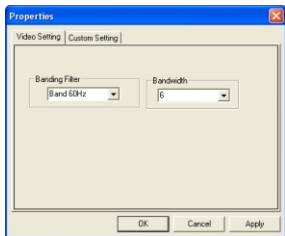

Configuring Flicker options

If you take your camera abroad, and find the screen of your computer flickers when using PC Camera function, please check the **Cancel Flicker** box to prevent noises from appearing on the screen. Or, you can refer to the **Flicker Settings Table** (p. 66) for proper flicker value that suits the country you are staying.

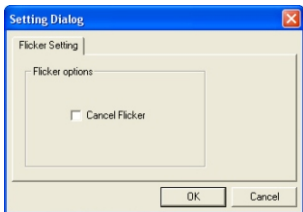

Addenda

Flicker Settings Table

Country	England	Germany	France	Italy	Spain	Netherlands
Setting	50Hz	50Hz	60Hz	50Hz	50Hz	50Hz
Country	Portugal	America	Taiwan	China	Japan	Korea
Setting	50Hz	60Hz	60Hz	50Hz	50/60Hz	60Hz

* The flicker setting is based on the frequency standard of your local power supply.

LED Event Table

Condition	LED color	Meanings
Status (Status LED)	Red	Busy (storage, or capture)
	Green	Ready (waiting for command)
Flash (Status LED)	Red	Charging flash
	Green	Ready (waiting for command)
Data transformation (Status LED)	Red	Data transformation
	Green	Ready (waiting for command)
Self-Timer (Self-Timer LED)	Red (regularly)	Counting
	Red (rapidly)	Capturing the picture

Addenda

Storage Capacity Table





Memory	Still picture				Video Clip	Audio Clip
	2304x1728	2048x1536	1600x1200	640x480	All resolutions	Maximum
Flash memory (16MB)	10	20	30	48	3-7 min	1 hr
SD/MMC card (32MB)	20	40	60	96	6-14 min	2 hr
SD/MMC card (64MB)	40	80	120	192	12-28 min	4 hr
SD/MMC card (128MB)	80	160	240	384	24-56 min	8 hr
SD/MMC card (256MB)	160	320	480	768	48-112 min	16 hr
SD/MMC card (512MB)	320	640	960	1536	96-224 min	32 hr

- * 1. The actual number of pictures stored may vary (up to $\pm 30\%$) depending on the resolution and color saturation.
- * 2. The video test result applies to all resolutions.

Addenda

Battery Life Table

>> Battery indicator status

Icon	Description
	Full battery life
	Moderate battery life
	Low battery life
	Empty battery life

Note: The following tests are conducted based on the following conditions:

1. Alkaline batteries are used.
2. Temperature: 25°C.
3. LCD display is always on.

>> Shooting still pictures (pics)

Still picture		
2048x1536	1600x1200	640x480
110	120	130

- * 1. Shooting interval: 30 seconds.
- 2. The flash strobe is used for every other image.

>> Continuous shooting (pics)

Still picture		
2048x1536	1600x1200	640x480
500	600	700

- * 1. Shooting interval: 4 seconds.
- 2. Flash strobe is disabled.

>> Recording video clips (continuous recording, mins)

Video clips		
640x480	352x288	160x128
60	60	60

Addenda

System Message Table

Message	Description
Recording	The camera is recording a file.
Please Unlock SD Card	If you insert a SD card and the card is set to "Protected", this message will show up when the camera tries to write data into the card.
No Files To Play	When the camera is set to Playback or MP3 mode without any existing file to play, this message will show up.
Please Change Batteries	The camera is under the status of low power. You should change the batteries immediately.
Memory Full	The storage memory is full and can not store any more files. Please change the SD/MMC card or delete some files to free some memory space.
Card Error	The inserted card is not compatible with the camera. Please change the card or try formatting the card.
Memory Error	The camera can not access data in the internal memory. Please format the media to solve this problem.
Strobe Is Charging	The flash strobe is charging.
File Format Error	The file being played is not compatible with the camera.
Deleting	The camera is performing file deletion.
Formatting	The camera is formatting the storage media.
File Is Locked	The current file is locked and can not be deleted.
Locking	The current file is being locked to protect it from deletion.
Unlocking	The current file is being unlocked.
Setting	The camera is performing a setting action.

Addenda

Specifications

Sensor effective resolution	2MP (1600x1200 pixels)
Interpolated resolution	4MP (2304x1728 pixels)
Internal memory	16 MB flash memory (storage)
External memory	Built-in SD/MMC slot (maximum: 512 MB)
Digital video camcorder	MPEG4 (.ASF) Format VGA (640x480 pixels) / up to 11 fps CIF (352x288 pixels) / up to 30 fps 160x128 pixels / up to 30 fps
Digital still camera	JPEG (.JPG) Format 4MP (2304x1728 pixels) 3.1MP (2048x1536 pixels) 2MP (1600x1200 pixels) VGA (640x480 pixels)
Digital voice recorder	WAVE (.WAV) Format with 16MB memory Recording time: approximately 1 hour
MP3 player	Support all kinds of sample rate
PC Camera	VGA (640x480 pixels) / up to 10 fps QVGA (320x240 pixels) / up to 20 fps
LCD display	1.5" Color TFT LCD
Digital zoom	4X (real-time)
TV-out	Yes (NTSC system)
Built-in microphone	Yes
Built-in speakers	Yes
Built-in flash strobe	Yes
Built-in headset connector	Yes
Lens	F=3.5 / 8.5mm
Self Timer	10 seconds
Interface	USB 2.0 (USB 1.1 compatible)
Power saving	1min/3min/5min (auto power-off if idle for over selected time)
Battery	AAx2 (alkaline recommended)
Dimension	3.86"x2.57"x1.28" (98x67x33 mm)

* 1. Specification is subject to change without notification.

Troubleshooting

When using the camera:

Q1 The camera can not be switched on normally.

- A: 1) The batteries may be out of power. Please change the batteries.
2) Make sure the batteries are correctly installed.

Q2 The camera is still powered on, but the LCD screen does not display.

- A: If the camera stays idle for over one minute, the LCD screen will automatically shut down to save power. You can press any button except the power button to reactivate the display.

Q3 Can not take pictures or video clips when pressing the Record/Shutter button.

- A: 1) The storage media may be full. Please free some space from the SD/MMC card or the internal memory.
2) Check if the camera is recharging the flash strobe.
3) If you are using a SD card, check if the card is set to "protected".
4) If the LCD screen displays "MEMORY ERROR" or "CARD ERROR" message, please set the camera to Settings mode and format the storage media.

Q4 I did not delete the pictures and video clips, but can not find them in the memory.

- A: 1) Check if you take pictures and video clips and then insert a SD/MMC card. The camera will use the card as the main storage media and files previously stored in the internal memory will be inaccessible until the card is removed.
2) Check if the "Index" option (see page 39) is set to displaying a particular file type. If yes, you can set the option to "All" or restart the camera to access other files.

Troubleshooting

Q5 I cannot use the flash strobe.

A: If the battery life icon indicates , the flash strobe may be disabled due to insufficient voltage. Please change batteries immediately.

Q6 The pictures taken appear too blurred.

A: Please adjust the focus as appropriate.

Q7 The pictures or video clips taken appear too dark.

A: Make sure the environment of shooting or recording has adequate light. Or you may consider using flash strobe when taking pictures.

Q8 Noises occur when viewing images on the LCD screen or on the computer.

A: Check if the flicker setting matches the place you are staying. For more information, please refer to the "Flicker Settings Table" on page 66.

Q9 I cannot play MP3 and the title displays strange characters.

A: This problem is probably caused by double-byte characters (such as Chinese, Korean...etc.). Please rename these files before copying them to the camera.

Troubleshooting

When connecting the camera to the computer or TV:

Q1 I can not view the video clips on my computer.

A: Please install Direct X 8.0 or above and Windows Media 9.0 Codecs to solve this problem. See page 52 for details on installing the driver, or go to <http://www.microsoft.com> to download the required files.

Q2 The driver installation failed.

- A: 1) Please remove the driver and other related programs. Follow the installation steps in the manual to reinstall the driver.
2) Make sure you install the driver before plugging in the USB cable.

Q3 The TV screen does not display after connecting the camera to the TV.

- A: 1) Check if the camera is correctly connected to the TV.
2) Make sure the TV is switched to AV mode.

Q4 A conflict with other installed camera or capture device occurred.

A: If you have any other camera or capture device installed in your computer, please completely remove the camera and its driver from the computer to avoid the conflict.

Q5 Noises occur on my computer screen when using Video Conferencing.

A: Please set the flicker filter to match the place you are staying. See "Configuring Flicker options" on page 65 for more details.

Troubleshooting on USB

1. If you connect your camera to the USB 2.0 port on your computer and find that your computer cannot correctly detect camera, please read the following text for solution:

1. Windows 98SE/ME users:

Windows 98SE/ME does not fully support USB 2.0 port connection. Please consider using another port for connection. Or you may upgrade your system to Windows 2000 or XP, and then proceed with the following steps to download and install the service pack and driver.

2. Windows XP/2000 users:

After connecting your camera to the USB 2.0 port on your computer, if the computer does not work, or you cannot use your camera and the computer displays a "Hardware not found" message, it is probably because your current operation system does not fully support USB 2.0 port. Please consider using another port for connection, or follow step 1 to install the necessary software:

STEP 1. Download the OS Update software from the Internet

Please go to <http://v4.windowsupdate.microsoft.com/en/default.asp> to download the latest OS Update software:

- Windows XP users: please download Service Pack 1.
- Windows 2000 users: please download Service Pack 4.

After you download and install the software, proceed with step 2.

STEP 2. Update the Driver provided by the OS

Please note that the installation display may differ according to your computer mainboard, language, and operation system. The screen shots in the following case are for reference only.

Windows 2000 users:

- 1) Launch "Device Manager" and unfold the "Universal Serial Bus controllers" container.

Troubleshooting on USB

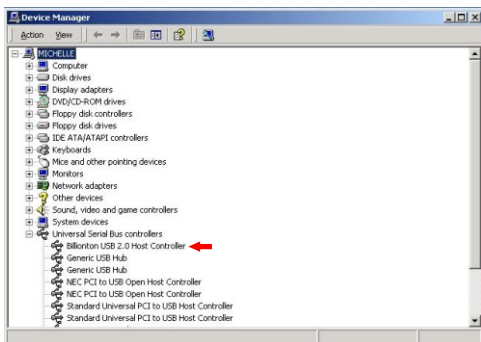

2) Highlight the USB 2.0 controller ("Billionton USB 2.0 Host Controller" in this case) and right-click the mouse, a menu should pop up:

- Click on "Properties", and a sub-menu as the following should show up.
- Click on the "Driver" tab. Then click on the "Update Driver..." button.

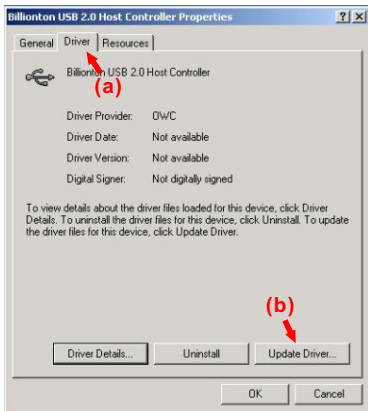

Troubleshooting on USB

3) When the following dialogue window appears, click on "Next >" to continue.



4) When the following dialogue window appears:

- Check the item "Search for a suitable driver for my device".
- Click on "Next >" to continue.

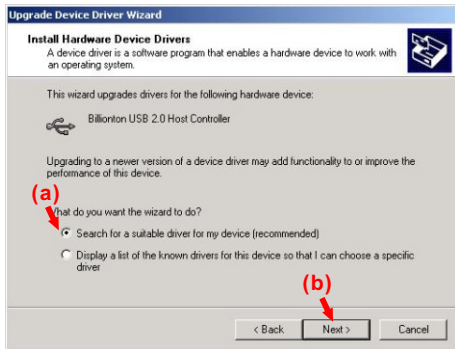

Troubleshooting on USB

- 5) When the following dialogue window appears, select none of the items and click on "Next >" to continue.

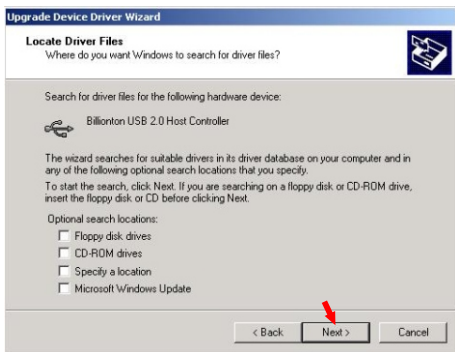

- 6) When the following dialogue window appears:
- Check the item "Install one of the other drivers".
 - Click on "Next >" to continue.

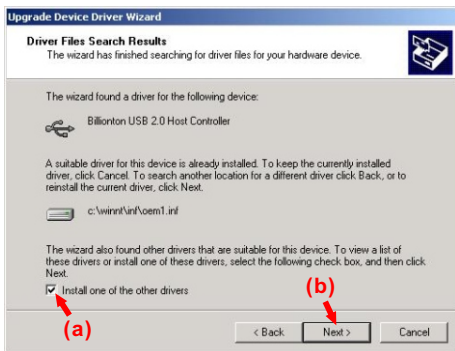

Troubleshooting on USB

- 7) When the following dialogue window appears:
- Select the correct USB driver. In this case, you should select the USB 2.0 driver provided by Microsoft to replace the original driver.
 - Click on "Next >" to continue.

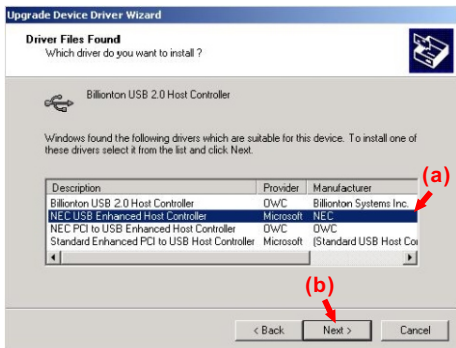

- 8) When the following dialogue window appears, click on "Finish" to complete the installation.



Troubleshooting on USB

- 9) Launch "Device Manager" and unfold the "Universal Serial Bus controllers" container again. If the old driver has been replaced by the new one, the installation is successfully completed.

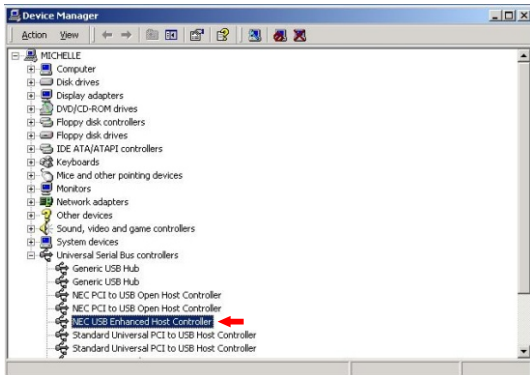

- 10) After all the above steps are completed, reconnect the camera to the USB 2.0 port. Make sure that the PC Camera (Live mode) function can operate normally.

Troubleshooting on USB

Windows XP users:

- 1) Launch "Device Manager" and unfold the "Universal Serial Bus controllers" container.

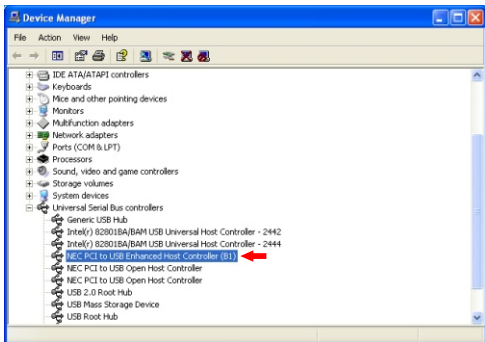

- 2) Highlight the USB 2.0 controller ("NEC PCI to USB Enhanced Host Controller (B1)" in this case) and right-click the mouse, a menu should pop up. Select the "Update Driver..." item and the following window will appear. Check the "Install from a list or specific location (Advanced)" item and then click on "Next >" to continue.



Troubleshooting on USB

- 3) Check the item "Don't search. I will choose the driver to install." Then click on "Next >" to continue.

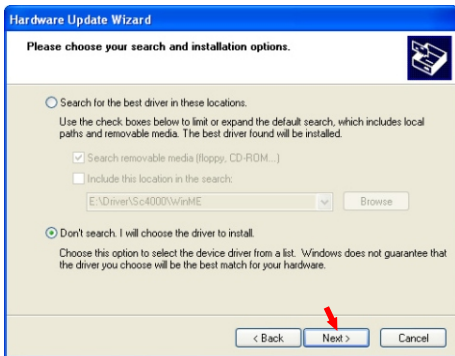

- 4) Select "Standard Enhanced PCI to USB Host Controller" and click on "Next >" to continue.

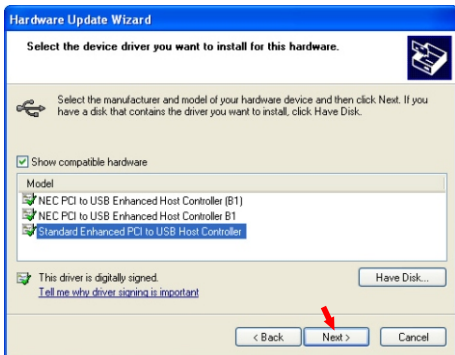

Troubleshooting on USB

5) The driver installation process is complete. Click on "Finish" to continue.



6) Launch "Device Manager" and unfold the "Universal Serial Bus controllers" container. Make sure the USB 2.0 driver has been updated.

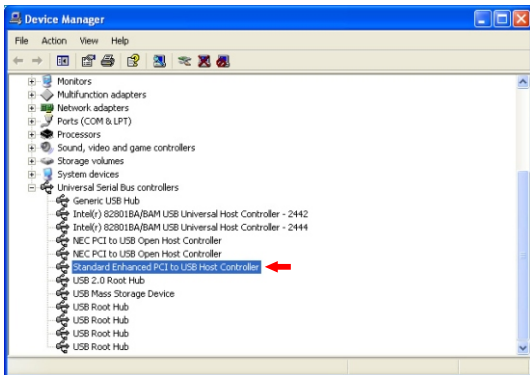

Troubleshooting on USB

- 2.** When you use your computer to view the video clips stored on the camera, the bigger the file size is, the longer it would take to load the file. If you encounter problems related to taking a long time loading video clips, we recommend you:
- 1) Copy the video clips to your computer and then view them on the computer.
 - 2) Upgrade your media player to Media Player 9.0 or above, so that you can benefit from the more efficient playing speed.

Aiptek Service

If you have any problems about the product, please contact AIPTEK office located in the United States:

AIPTEK, Inc.

51 Discovery, Suite 100

Irvine, CA 92618, USA

TEL: 949-585-9600

FAX: 949-585-9345

<http://www.aiptek.com>

Online registration website:

<Http://www.aiptek.com/registration/registration.htm>

(Online registration entitles you to special services, downloads, and promotions.)

Free Manuals Download Website

<http://myh66.com>

<http://usermanuals.us>

<http://www.somanuals.com>

<http://www.4manuals.cc>

<http://www.manual-lib.com>

<http://www.404manual.com>

<http://www.luxmanual.com>

<http://aubethermostatmanual.com>

Golf course search by state

<http://golfingnear.com>

Email search by domain

<http://emailbydomain.com>

Auto manuals search

<http://auto.somanuals.com>

TV manuals search

<http://tv.somanuals.com>