

ÖKO-LAVAMAT 84760 update

The Environmentally-Friendly Washing Machine

User Information



Dear customer,

Please read this user information carefully.

In particular, pay attention to the section "Safety" on the first pages. Keep this user information in a safe place for later reference. Pass it on to any subsequent owners of the unit.



Points which are necessary for your safety or which are important for the unit's functional capability are highlighted by a warning triangle and/or signal words (**Warning!**, **Caution!**, **Attention!**). Always remember.



1. This symbol guides you step by step in operating the unit.

2. ...



After this symbol you will find detailed information on operation and practical use of the unit.



The clover leaf indicates tips and information on the economical and environmentally-responsible use of the unit.

This user information contains information on remedying any faults which may occur, see the section "What to do if ...".

If these instructions are not sufficient, our After-Sales Service is at your disposal at any time:

ELGROEP & AEG SERVICE

Bergensesteenweg 719

1502 Lembeek

Tel.: 02/3630444

Here you will receive an answer to any question concerning the features and use of your unit. Of course, we are also pleased to receive any requests, suggestions and criticism. Our aim is to further improve our products and services for the benefit of our customers.

In the event of technical problems, our factory customer service in your area is at your disposal at all times. Also refer to the section "Service".

Printed on recycled paper.

Those who think ecologically act ecologically ...

Contents

Instructions for use	6
Safety	6
Disposal	8
Environmental Tips	8
Unit Description	9
Front View	9
Drawer for Washing Powder and Care Agent	9
Control Panel	10
Programme knob	10
Additional programme buttons	12
Programmable functions	13
Consumption values and time requirements	14
Wash Time Display	15
What does "UPDATE" mean?	16
Water Protection Aqua Control + Aqua Alarm	16
Before the first wash	17
Preparing a Wash Load	17
Sorting and preparing a wash load	17
Types of washing and care symbols	18
Washing Detergents and Care Agents	19
Which washing detergent and care agent?	19
How much washing detergent and care agent?	19
Water Softener	19
Carrying out a wash cycle	20
Brief instructions	20
Setting the wash programme	21
Change Spin Speed / Select Rinse Hold	22
Setting the delay timer/soaking time	23
Opening and Closing the Filling Door	24
Putting in the washing	24
Add Washing Detergent/Care Agent	25
Starting the wash program	26

Sequence of the programme	27
Wash cycle ended/Remove washing	28
Programme tables	30
Wash	30
Separate Rinsing/Conditioner/Starching/Impregnation	32
Separate Spinning	32
Cleaning and Care	33
Control Panel	33
Washing Detergent Drawer	33
Washing Drum	34
Filling Door	34
What to do if	35
Remedying Faults	35
If the washing result is not satisfactory	39
Carry Out an Emergency Emptying Operation	40
Drain pump	41
Emergency Unlocking of the Filling Door	42
Additional rinse cycle (RINCAGE+)	43
Water cooling	44
Additional rinse cycle and water cooling	45
Variomatic-loose spinning	46
Programme security	47
Child Safety Feature	48
Setting up and connection instructions	49
Safety Instructions for Installation	49
Setting Up the Unit	50
Transporting the Unit	50
Remove the Transport Safeguard	50
Prepare the Installation Location	52
Setting Up on a Concrete Pedestal	52
Setting Up on a Vibrating floor	52
Compensate for Floor Unevenness	53

Electrical Connection	54
Water Connection	54
Permissible Water Pressure	54
Water Inflow	55
Water Drainage	56
Delivery Heads over 1 m	57
Technical Data	58
Dimensions	58
Guarantee conditions	59
Customer services	61
Index	62
Service	63

Instructions for use



Safety

The safety of AEG electrical appliances conforms to the recognised technical regulations and the legislation covering the safety of appliances. However, as manufacturers, we still regard it as our responsibility to inform you of the following safety information.

Before Putting into Operation for the First Time

- Refer to the **"Installation and Connection Instructions"** later in this user information.
- When the unit is delivered in winter months with minus temperatures: Store the washing machine for 24 hours at room temperature before putting it into operation.

Correct Use

- The washing machine is only designed for normal domestic washing. If the unit is used for purposes other than that for which it is designed, the manufacturer can accept no liability for any resulting damages.
- For safety reasons, conversions or modifications to the washing machine are not permissible.
- Use only detergents which are suitable for washing machines. Follow the washing detergent manufacturer's instructions.
- The washing must not contain any flammable solvents. Also remember this when washing pre-cleaned washing.
- Do not use the washing machine for chemical cleaning.
- Dyes/dye removers may only be used in washing machines if the manufacturer expressly allows these products. We cannot be held liable for any resulting damage.
- Use only water from the water mains. Use rainwater or service water only if it meets the requirements outlined in DIN 1986 and DIN 1988.
- Frost damage is not covered by the warranty! If the washing machine is in a room which is at risk from frost, an emergency emptying operation must be carried out when there is a frost risk (see the section "Carry Out Emergency Emptying").

Child Safety

- Packaging components (e.g. films, polystyrene) can be hazardous to children. Risk of suffocation! Keep packaging away from children.
- Children often cannot recognise the hazards associated with handling electrical appliances. Therefore, ensure the necessary supervision during operation and do not allow children to play with the washing machine – there is a risk that children can get trapped inside.
- Ensure that children or small animals cannot climb into the washing machine's drum.
- When disposing of the washing machine: Pull out the mains plug, destroy the door lock, cut off the electrical supply lead and throw away the plug and the left-over cable. This means that children at play cannot shut themselves inside and in so doing be in danger.

General Safety

- Repairs to the washing machine may only be carried out by skilled persons. Incorrect repairs can cause significant hazards. If repairs are necessary, consult our Customer Service or your specialist dealer.
- Never put the washing machine into operation if the mains cable is damaged or if the control panel, work top or base area are damaged in such a way that the inside of the unit is open and accessible.
- Switch off the washing machine before carrying out cleaning, care and maintenance work. Also pull the mains plug out of the socket or, – if it is permanently connected, – switch off the LS switch in the fuse box or completely unscrew the screw-in fuse.
- If operation is stopped, disconnect the appliance from the mains supply and shut off the tap.
- Never pull the cable to remove the plug from the socket. Always pull the plug itself.
- Multiple connectors, couplings and extension cables must not be used. **There is a fire risk with overheating!**
- Do not spray down the washing machine with a water jet. Electric shock risk!
- The glass in the filling door becomes hot in the case of washing programs with high temperatures. Do not touch!
- Allow the washing solution to cool down before emergency emptying of the unit, before cleaning or before emergency opening of the filling door.

- Small animals can chew the power cables and water hoses. Risk of electric shock and danger of water damage! Keep small animals away from the washing machine.



Disposal

Dispose the packing material!

Dispose of your washing machine's packaging correctly. All the packaging materials used are harmless to the environment and can be recycled.

- Plastic parts are marked with standard international abbreviations:
 - >PE< for polyethylene, e.g. sheet wrapping material
 - >PS< for polystyrene, e.g. padding material (always CFC-free)
 - >POM< for polyoxymethylene, e.g. plastic clips
- Cardboard packaging is manufactured from recycled paper and should be deposited in the waste paper collection for recycling.

Dispose the old appliance!

When you finally put your appliance out of operation, please bring it to your nearest recycling centre or to your dealer.



Environmental Tips

- You do not need to use a pre wash cycle or soak for washing with average soiling. This saves detergent, water and time (and protects the environment).
- When loaded to the capacities indicated the washing machine is especially efficient.
- For small loads, use only one half to two thirds of the recommended quantity of detergent.
- By pre-treating stains and marks you will be able to wash at a lower temperature.
- It is often possible to wash without using softener. Give it a try! If you use a drier, your washing will be soft and fluffy even without a softener.
- For medium to high water hardness (from hardness range II, see "Detergents and Conditioners") you should use water softener. The detergent can then always be dosed as for hardness range I (= soft).

Unit Description

Front View

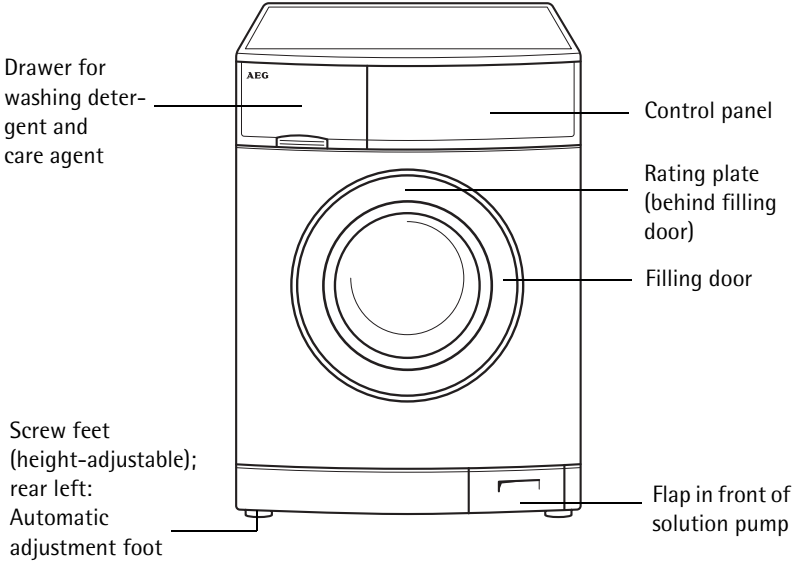

Drawer for Washing Powder and Care Agent

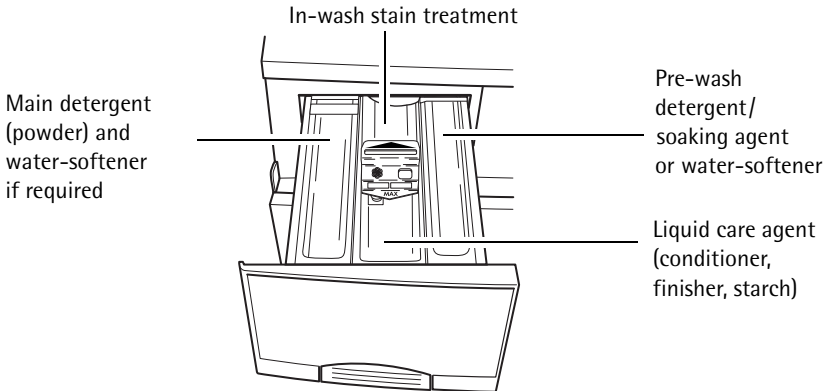

Control Panel

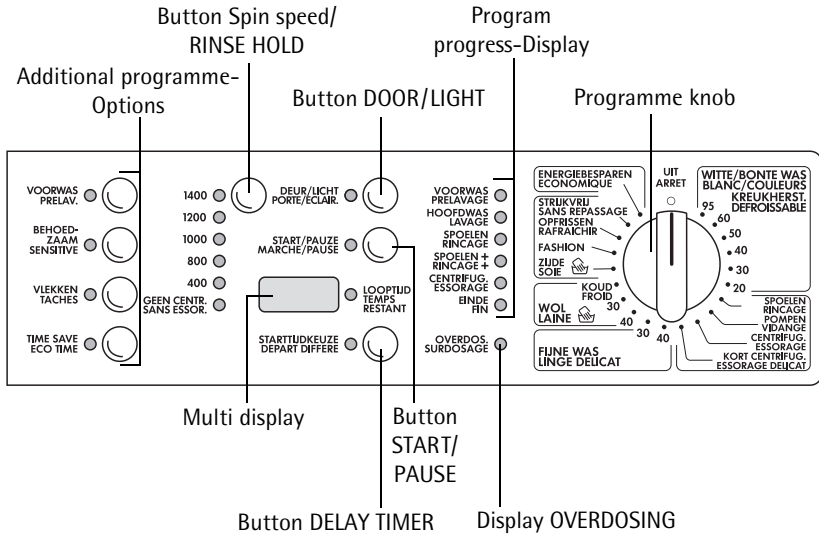

Programme knob

The programme knob determines the type of the washing cycle (e. g. water level, drum movement, number of rinse cycles, spinspeed) depending on the type of washing to be handled, as well as the water temperature.

OFF (UIT, ARRET)

switches the washing machine Off; in all other positions the machine is switched On.

For correcting accidentally selected programme settings, turn the programme knob to the OFF position. The washing machine returns to the Off condition again.

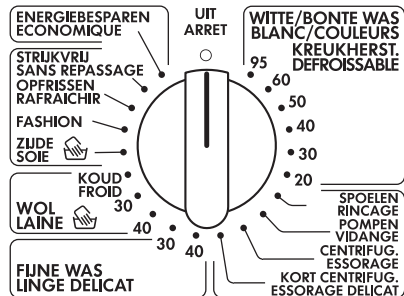

**COTTONS/LINEN, EASY-CARE
(WITTE/BONTE WAS, BLANC/COULEURS,
KREUKHERSTELLEND, DEFROISSABLE)**

Wash programme from 20 °C to 95 °C can be used universally for cotton/linen, easy-care (e.g. cotton/polyester) and synthetics. The washing programme adapts itself to the various types of types of weaves and amount of filling. For mostly cotton/linen, the programme for cotton/linen will be carried out; for mostly synthetics, a programme for easy-care washing. For purely easy-care loading, the amount of filling should not exceed 2.5 kg in order to prevent increased creasing build-up.

RINSING (SPOELEN, RINCAGE)

Separate rinse, separate Conditioning, separate impregnation of wet washing (1 rinse cycle, fluid conditioner from the compartment  is rinsed in, spin).

Do not pour conditioner into the compartment if a separate spin cycle is to be carried out.

PUMP OUT (POMPEN, VIDANGE)

Pumping out the water after a rinse stop (without spinning).



Rinse stop means: the washing remains in the last rinse water, it is not spun.

SPIN (CENTRIFUG., ESSORAGE)

Pumping out the water after a rinse stop and spin, or separate spinning of hand washed cotton/linen and easy-care washing.

GENTLE SPIN (KORT CENTRIFUG., ESSORAGE DELICAT)

Pumping out the water after a rinse stop and gentle spin or separate gentle spin of delicate textiles (delicate washing, wool) at low speed.

DELICATE WASHING (FIJNE WAS, LINGE DELICAT)

Wash program for delicate washing at 30 °C or 40 °C.

WOOL (WOL, LAINE)/  (Hand wash program)

Wash programme (cold to 40 °C) for machine machine-washable wool as well as for handwashable wool textiles with the easy-care symbol  (Handwash programme).

SILK (ZIJDE, SOIE)/ (handwash)

Wash programme at 30 °C for hand- and machine-washable silk.



As silk is a very delicate textile, we recommend washing only one article of clothing, if possible, and on no account washing it together with other textiles. For extremely delicate silk textiles, it is possible to obtain an even more gentle handling by using the TIME SAVE button.

FASHION

Especially gentle programme at 40 °C for modern textiles such as Viskose, Modal, Cupro, Lyocell, with more gentle handling than with the DELICATE (FIJNE WAS, LINGE DELICAT) programme and more intensive cleaning effect than with the hand wash programme.

REFRESH (OPFRISSEN, RAFRAICHIR)

Ca. 20-minute special programme at 30 °C for short wash cycle washing of textiles, such as sports clothing that has only been worn once and is only lightly soiled.

EASY IRON (STRIJKVRIJ, SANS REPASSAGE)

Wash programme at 40 °C for easy-care textiles that will only need to be lightly ironed or not at all after this programme.



ENERGY SAVING (ENERGIEBESPAREN, ECONOMIQUE)

Special energy and water saving programme at ca. 60 °C for lightly or normally soiled cotton/linen with increased washing time.

Additional programme buttons

The purpose of the additional programme buttons is to adapt the washing programme to the degree of soiling of the washing. For normally soiled washing, additional programs such as PREWASH (VOORWAS, PRELAV.) and STAINS (VLEKKEN, TACHES) are not necessary.

Depending on the programme, various functions can be combined.



PRE WASH (VOORWAS, PRELAV.)

(Pre wash/Soaking)

Cold pre wash before the subsequent automatic main wash cycle. With button DELAY TIMER (STARTTIJDKEUZE, DEPART DIFFERE) will soak the pre wash for heating.

DELICATE (BEHOEDZAAM, SENSITIVE)

Special additional programme with significantly higher rinse effect (special spin cycle) with simultaneously improved weave care (reduced drum movement). Ideal, if washing is to be carried out often, e.g. for over-sensitive skin. RINSE+ (SPOELEN+, RINCAGE+) can additionally be selected.

STAINS (VLEKKEN, TACHES)

For handling strongly soiled or stained washing. (Stainssalt or tabs are rinsed in a time optimized manner during the programme cycle).



When setting WOOL (WOL, LAINE) /  (handwash programme) the additional programmes cannot be selected with the buttons.

TIME SAVE

Shortened washing programme for less soiled washing can be selected in three levels for the programme COTTON/LINEN, EASY CARE (WITTE/BONTE WAS, BLANC/COULEURS, KREUKHERSTELLEND, DEFROISSABLE) and in two levels for other programmes.

Programme	Programme duration		
	Without TIME SAVE	With TIME SAVE	
		Press button 1x	Press button 2x
COTTON/LINEN,EASYCARE (WITTE/BONTE WAS, BLANC/COULEURS, KREUKHERSTELLEND, DEFROISSABLE) at 60 °C	119 Min	91 Min	63 Min
Other programmes, e.g. DELICATE WASH (FIJNE WAS, LINGE DELICAT) at 30 °C	68 Min	52 Min	-

Programmable functions

The programmable functions of additional rinsing (RINSE+/SPOELEN+, RINCAGE+), water cooling and Variomatic-lightspinning are described in the chapter „What to do if...“.

Consumption values and time requirements

The values for selected programmes in the following table were determined under normal conditions. Besides the selected settings (additional functions), the consumption values also depend on other conditions such as water temperature or the washing powder/liquid used. However, they provide a helpful guide for operation in the household

Programme knob (Temperature)	Type of textile	Filling quantity in kg	Water in Litres	Energy in kWh	Time in minutes
ENERGY SAVING ¹⁾ (ENERGIEBESPAREN, ECONOMIQUE)	Cotton	6	42	1,02	120
COTTON/LINEN, EASY CARE 95 (WITTE/BONTE WAS, BLANC/COULEURS, KREUKHERSTELLEND, DEFROISSABLE)	Cotton	6	50	2,05	148
COTTON/LINEN, EASY CARE 60 (WITTE/BONTE WAS, BLANC/COULEURS, KREUKHERSTELLEND, DEFROISSABLE)	Cotton	6	50	1,08	119
COTTON/LINEN, EASY CARE 40 (WITTE/BONTE WAS, BLANC/COULEURS, KREUKHERSTELLEND, DEFROISSABLE)	Cotton	6	58	0,66	116
COTTON/LINEN, EASY CARE 60 (WITTE/BONTE WAS, BLANC/COULEURS, KREUKHERSTELLEND, DEFROISSABLE) ECO TIME press 1x ¹⁾	Synthetics	3	56	0,95	91
COTTON/LINEN, EASY CARE 40 (WITTE/BONTE WAS, BLANC/COULEURS, KREUKHERSTELLEND, DEFROISSABLE) ECO TIME press 1x ¹⁾	Synthetics	3	52	0,55	88
COTTON/LINEN, EASY CARE 40 (WITTE/BONTE WAS, BLANC/COULEURS, KREUKHERSTELLEND, DEFROISSABLE) ECO TIME press 2x	Synthetics	3	50	0,58	59
DELICATES (FIJNE WAS, LINGE DELICAT) 30	Synthetics	3	56	0,36	68
WOOL (WOL, LAINE)  (Handwash) 30		2	42	0,18	35

1) **Remarks:** Programme setting for testing in accordance with or in similarity to EN 60 456 and IEC 60 456.

Wash Time Display



The wash times for the wash programmes depend on the usual washing practice and the ambient conditions at the place of installation. The washing type and quantity, the type of washing detergent, the water temperature and the room temperature etc. can influence the duration of the wash programme.



What does "UPDATE" mean?

The wash programmes in your washing machine are controlled by software.

New types of fabric or new detergents may require new wash programmes in the future. In most cases, the software can be adapted to this.

For further information on a possible "update" please contact customer service.

Water Protection Aqua Control + Aqua Alarm

In the event of damage to the supply hose, the system blocks the further supply of water to the unit directly at the water tap.

If water escapes elsewhere, the drainage pump automatically pumps off – even if the unit is switched off. The washing machine merely has to be connected to the electricity mains. When the water protection system responds, a warning signal sounds at the same time.

Before the first wash

- ☞ Carry out a wash cycle without washing; Programme COTTON/LINEN (WITTE/BONTE WAS, BLANC/COULEURS) 95, with half the washing powder/liquid quantity. In this way, manufacturing remains in the drum and water container will be removed.

Preparing a Wash Load

Sorting and preparing a wash load

- Sort the washing according to care symbol (see "Washing Types and Care Symbols").
- Empty all pockets.
- Remove metal objects (paper clips, safety pins etc.).
- In order to prevent the washing tangling and being damaged: close zippers, button up duvet covers and pillow cases, and tie up loose straps such as from aprons.
- Turn articles with double layered fabric inside out (sleeping bags, anoraks etc.).
- In the case of knitted coloured fabrics and also wool and fabrics with jewellery attached: turn inside out.
- Place small and delicate articles (baby booties, stockings, bras etc.) into a washing net, a pillow case with zipper, or in large socks before washing.
- Handle curtains with particular care. Metal fittings or burred, plastic fittings must be removed or tied into a net or bag. We cannot accept liability for damage.
- Do not wash coloured and white washing together. This could transfer colour to white washing or turn it grey.
- New coloured items often have an excess of colour. It is better to wash such items separately the first time.
- Mix small and large items of washing. This improves the wash efficiency and the washing is more evenly distributed during the spin cycle.
- Shake out washing before placing into the washing machine.
- Do not place folded washing into the drum.
- Observe such washing instructions as "wash separately" and "wash separately several times"!

Types of washing and care symbols

The care symbols help in the selection of the correct wash programmes. The washing should be sorted according to type and care symbols. The temperature information on the care symbols are always maximum values.

Cottons

Textiles of Cotton and Linens with this care symbol are resistant to mechanical loading and high temperatures. For this type of washing the programme COTTON/LINEN EASY-CARE (WITTE/BONTE WAS, BLANC/COULEURS, KREUKHERSTELLEND, DEFROISSABLE) is suitable.

Linen

Textiles of cotton and linen with this care symbol are resistant to mechanical loading. For this type of washing the programme COTTON/LINEN EASY-CARE (WITTE/BONTE WAS, BLANC/COULEURS, KREUKHERSTELLEND, DEFROISSABLE) is suitable.

Easy-care washing

Textiles such as reinforced cotton, cotton-wool mixtures and synthetics with this care symbol demand a mechanically milder handling. For these type of washing the programmes COTTON/LINEN, EASY CARE (WITTE/BONTE WAS, BLANC/COULEURS, KREUKHERSTELLEND, DEFROISSABLE) and LIGHT IRON (STRIJKVRIJ, SANS REPASSAGE) are available.



Delicates

Textiles such as layered fibres, micro-fibres, synthetics and Curtains with this care symbol need a caring handling. For these types of washing the programme DELICATE (FIJNE WAS, LINGE DELICAT) is suitable.

Viskose

Modern textiles such as viskose, cupro, lyocell, modal, among others require a particularly caring handling. For these types of washing the programme FASHION is suitable.

Wool, Silk and specially delicate wash

Textiles such as wool, wool mixtures and silk with this care symbol are particularly sensitive to mechanical loading. For textiles of this sort the programme WOOL (WOL, LAINE)/ (handwash) and SILK (ZIJDE, SOIE)/ (handwash) are suitable.

Caution! Textiles with care symbols  (Do not wash!) must not be washed in the washing machine!

Washing Detergents and Care Agents

Which washing detergent and care agent?

Use only washing detergents and care agents which are suitable for use in washing machines. Always follow the manufacturer's instructions.

How much washing detergent and care agent?

The amount to be used depends on:

- the dirtiness of the washing
- the hardness category of the mains water supply
- the filling quantity



If the detergent manufacturer gives no details of the dosing quantities for minimum loads, add one third less for half loads and, in the case of very small loads and for EASY IRON (STRIJKVRIJ, SANS REPASSAGE), only half the amount of detergent recommended for a full load.

Refer to the detergent/care agent manufacturer's instructions on use and dosage.

Water Softener

For medium to high water hardness (hardness category II or higher) you should use water softener. Pay attention to the manufacturer's instructions. Always then meter detergent for hardness category I (= soft). The responsible water works can provide information on the local water hardness.



Since the water softener is added before the main washing detergent, (water pre-softening), eighty percent of the softener quantity stated on the package is sufficient.

Water Hardness Details

Hardness Category	Water Hardness °dH (degrees German hardness)	Water Hardness in mmol/l (millimol per litre)
I – soft	0 - 7	up to 1.3
II – medium hard	7 - 14	1.3 - 2.5
III – hard	14 - 21	2.5 - 3.8
IV – very hard	over 21	over 3.8

Carrying out a wash cycle

Brief instructions

A wash cycle is carried out in the following steps:

1. Setting the correct wash programme:
 - Set programme and temperature with the programme knob,
 - If necessary, select additional programme.
2. Possibly Change spin speed, select /RINSE STOP (GEEN CENTR., SANS ESSOR.).
3. Possibly set DELAY TIMER (STARTTIJDKEUZE, DEPART DIFFERE).
4. Open door, put in washing,
5. Close door.
6. Washing-/Add conditioner.
7. Start the wash programme with the START/PAUSE (START/PAUZE, MARCHE/PAUSE) button.

After completion of the wash programme:

Caution! if the wash cycle ends with Rinse Stop, carry out PUMP OUT (POMPEN, VIDANGE), SPIN (CENTRIFUG., ESSORAGE) or SHORT SPIN (KORT CENTRIFUG., ESSORAGE DELICAT) before opening the door.

8. Open door, remove washing.
9. Switch washing machine Off: Set programme knob to OFF (UIT, ARRET).

Setting the wash programme

i For suitable programme, correct temperature and possible additional programs for the respective type of washing, see „Programme tables“.

- 1.** With the programme knob, set the desired wash programme and temperature.

In the multi-display the probable duration of the set programmes will be shown in minutes.

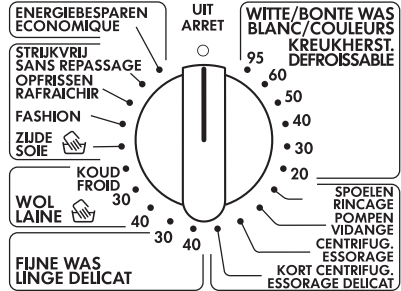

- 2.** Possible Press additional programme button(s):

The display of the selected additional programme is displayed.

- For changing to another selection, press another button.
- For resetting, press button again.



Change Spin Speed / Select Rinse Hold



If necessary, change the spin speed for the final spin / select RINSE HOLD (GEEN CENTR., SANS ESSOR.):

Press the button Spin speed/RINSE HOLD (GEEN CENTR., SANS ESSOR.) as often as necessary until the display for the required spin speed (or of RINSE HOLD/GEEN CENTR., SANS ESSOR.) lights up.

If RINSE HOLD (GEEN CENTR., SANS ESSOR.) is selected, the washing remains in the last rinsing water and is not spun.

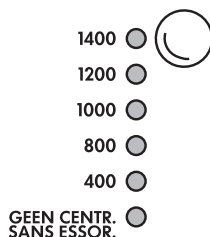

If you do not change the spin speed, the final spin is automatically adapted depending on the washing program:

- | | |
|---|--------------------------------|
| – COTTON/LINEN, EASY-CARE
(WITTE/BONTE WAS, BLANC/COULEURS,
KREUKHERSTELLEND, DEFROISSABLE) | 1400 revolutions
per minute |
| – ENERGY SAVING
(ENERGIEBESPAREN, ECONOMIQUE) | 1400 revolutions
per minute |
| – DELICATES
(FIJNE WAS, LINGE DELICAT) | 1200 revolutions
per minute |
| – WOOL
(WOL, LAINE)/ (Handwash) | 1200 revolutions
per minute |
| – SILK
(ZIJDE, SOIE)/ (Handwash) | 1200 revolutions
per minute |
| – FASHION | 1200 revolutions
per minute |
| – EASY IRON
(STRIJKVRIJ, SANS REPASSAGE) | 1200 revolutions
per minute |

The speed of the intermediate spin depends on the selected program and cannot be changed.

Setting the delay timer/soaking time

Delay timer

The DELAY TIMER (STARTTIJDKEUZE, DEPART DIFFERE) button makes it possible to delay the start of a wash programme by 1 to a maximum of 19 hours.

1. Select wash programme.
2. Press DELAY TIMER (STARTTIJDKEUZE, DEPART DIFFERE) button.
3. Press START/PAUSE (START/PAUZE, MARCHE /PAUSE) button.



With a delay in the start, the DELAY TIMER (STARTTIJDKEUZE, DEPART DIFFERE) display lights up.

Depress the DELAY TIMER (STARTTIJDKEUZE, DEPART DIFFERE) button until the desired start delay appears, e. g. in the form of **12h** for a delay of the programme start of 12 hours. If **19h** is displayed and the button is pressed again, then the delay timer is annulled. There will appear the duration of the set wash programme (display in minutes, e. g. **120**).

The set delay timer can also be annulled in that the programme knob is set to the OFF position.

Soaking duration

With depressed PRE WASH (VOORWAS, PRELAV.) button, by pressing the DELAY TIMER (STARTTIJDKEUZE, DEPART DIFFERE)

button, the duration of soaking can be extended by 1 to a maximum of 19 hours.

1. Press the PRE WASH (VOORWAS, PRELAV.) button.
2. Press DELAY TIMER (STARTTIJDKEUZE, DEPART DIFFERE) button. Soaking is set, the DURATION (LOOPTIJD, TEMPS RESTANT) display lights up. The soaking time is now ca. 1 hour.
3. By repeated pressing of the DELAY TIMER (STARTTIJDKEUZE, DEPART DIFFERE) button, the soaking times can be extended in steps of an hour. The DURATION (LOOPTIJD, TEMPS RESTANT) and DELAY TIMER (STARTTIJDKEUZE, DEPART DIFFERE) displays light up.

Opening and Closing the Filling Door

 Open: Press the button DOOR/LIGHT (DEUR/LICHT, PORTE/ECLAIR.). The filling door springs open.



 Close: Press the filling door firmly closed.

When the unit is switched on, the display DOOR/LIGHT (DEUR/LICHT, PORTE/ECLAIR.) shows whether the filling door can be opened:

- green: The door can be opened (not when the program saving function is activated, for details see the section "Program Saving")
- off: The door cannot be opened at present
- red: The door is open

 The washing drum is illuminated when the filling door is open. The light goes out automatically after approx. 3 minutes.

Putting in the washing

 For maximum filling quantity see „Programme tables“. For information on the correct preparation of the washing see „sorting and preparing the washing“.

-  1. Sort and prepare washing according to type and colour.
2. Open door: Press DOOR/LIGHT (DEUR/LICHT, PORTE/ECLAIR.) button. Door springs open.

3. Put in washing.

Caution! Do not jam items of washing when closing the door! Both textiles and appliance can be damaged!

4. Close door tightly.

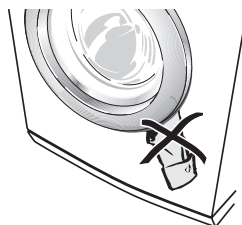

Add Washing Detergent/Care Agent

i For information on wash and care agent, see chapter „Washing powder and care agent“.

- 1.** Open the washing detergent drawer: Reach into the flap at the bottom of the drawer (1), pull drawer out up to the stop (2).
- 2.** Fill with washing detergent/care agent.

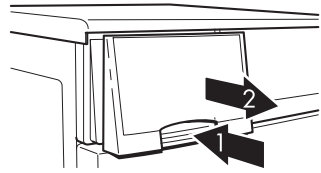

Compartment for In-wash stain treatment/-tabs

(only for additional programme STAINS/VLEKKEN, TACHES)

Compartment for powdered washing agent/Tabs

(If you are using water softener and need the right hand compartment for the pre-wash/softening agent, add the water softener to the main washing detergent in this compartment).

Compartment for liquid care agent

(Softener, shape rinse, starch)

Caution! Do not fill compartment above MAX mark. Thick fluid medium possibly thin to MAX mark, dissolve powdered starch.

Remarks: A small amount of remaining water in the compartment for fluid care agent is normal and does not affect the rinse results.

Compartment for pre-wash agent/soaking agent

(only for additional programme PRE WASH/VOORWAS, PRELAV.)
or for water softener

- 3.** Push drawer all the way in.

i When using liquid washing agent/Tabs:

liquid washing agent or Tabs with the dosing container provided by the detergent industry. More instructions on the washing agent packing.

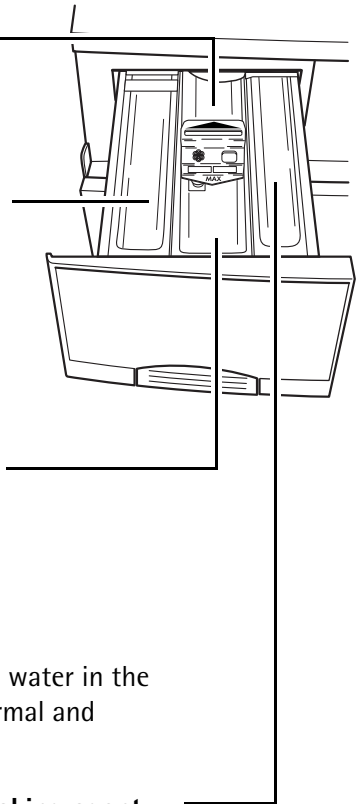

Starting the wash program

1. Checking whether the water tap is open.
2. Starting the wash programme: Press the START/PAUSE (START/PAUZE, MARCHE /PAUSE) button.



The wash programme is started or starts after end of the set delay time.



If the DOOR/LIGHT (DEUR/LICHT, PORTE/ECLAIR.) display lights up red when pressing the START/PAUSE (START/PAUZE, MARCHE /PAUSE) button, then the door is not properly closed. Press the door firmly closed and press the START/PAUSE (START/PAUZE, MARCHE /PAUSE) button again.

For a set delay time:

the set delay time runs out, in the multi-display the remaining time up to the start of the programme is displayed (always in full hours). During this time, you can add washing or change the delay time or abort.

- Adding washing: Press the START/PAUSE (START/PAUZE, MARCHE / PAUSE) button. The door can be opened. Then close the door and press the START/PAUSE (START/PAUZE, MARCHE /PAUSE) button again.
- Changing the delay time or aborting: Press the DELAY TIMER (START-TIJDKEUZE, DEPART DIFFERE) button until the desired time is displayed; With a display of the programme duration (display in minutes, e. g. 120) the wash programme starts immediately.

Sequence of the programme

Programme sequence – display

Before the start, the programme steps to be carried out will be displayed by the Programme sequence display. During the washing cycle, the current programme step is displayed.



Multi display

The expected The remaining wash time (in minutes) up to the programme end is displayed in the Multi display.



During the wash cycle, the remaining wash time can lengthen or remain static for a short time as the washing programme adapts itself to the different conditions during washing, (e.g. type of washing or quantity, imbalance recognition during spinning, special rinse cycle, etc.).

Changing speed of spinning

During the wash programme, the spin speed can still be changed or SPIN STOP (GEEN CENTR., SANS ESSOR.) can be set. Other settings cannot be changed.

Abort programme



For early aborting of the wash programme, turn the programme knob to OFF (UIT, ARRET).



The programme can be interrupted at any time with the START/PAUSE (START/PAUZE, MARCHE/PAUSE) button and can be continued by means of a repeated pressing of the button.

Wash cycle ended/Remove washing

After the wash programme has been ended, END (EINDE, FIN) is displayed on the Programme cycle display.

- If programme EASY IRON (STRIJKVRIJ, SANS REPASSAGE) has been selected, then a crease guard programme of ca. 30 minutes is carried out after the programme end. The multi-display then additionally shows a rest time of 1 minute and the display END (EINDE, FIN) lights up. During the crease guard programme, the door can be opened at any time and the washing can be removed.
- If RINSE STOP (GEEN CENTR., SANS ESSOR.) has been selected, the display next to the START/PAUSE (START/PAUZE, MARCHE /PAUSE) button blinks.

-  1. After a rinse stop, the water must first be pumped out:
- Either press the START/PAUSE (START/PAUZE, MARCHE /PAUSE) button (water is pumped out and the washing is spun according to the position of the programme; with the RINSE STOP (GEEN CENTR., SANS ESSOR.) spin speed, the speed of spinning can also still be changed during spinning),
 - or
 - Turn Programme knob to PUMP (POMPEN, VIDANGE) and press the START/PAUSE (START/PAUZE, MARCHE /PAUSE) button (the water is pumped off without spinning),
 - or
 - Turn programme knob to SPIN (CENTRIFUG., ESSORAGE) or SHORT SPIN (KORT CENTRIFUG., ESSORAGE DELICAT) and press START/PAUSE (START/PAUZE, MARCHE /PAUSE) button (water is pumped out and the washing is spun or short spun).

After the end of this programme step, the END (EINDE, FIN) display lights up.

2. Open filling door.

As soon as the display next to the DOOR/LIGHT (DEUR/LICHT, PORTE/ECLAIR.) lights green, the door can be opened (not when the programme security is activated. For this see „Programme security,“).

3. Remove washing.

4. Turn programme knob to OFF (UIT, ARRET).

5. After washing, pull the washing agent drawer out a little so that it can dry out. Lean door only against frame do that the washingmachine can vent out.



If the display OVER DOSING (OVERDOS., SURDOSAGE) lights up, too much washing detergent was used in the washing program just ended. During the next wash, pay attention to the dosing information of the washing detergent manufacturer and pay attention to the filling quantity!



OVERDOS.
SURDOSAGE 







Attention! If the washing machine is not used for a long time: Close the water tap and disconnect the washing machine from the electricity mains. (Aqua Control water protection with Aqua Alarm does not operate if the power supply is interrupted.)

Programme tables

Wash

In the following, there are shown, not all the possible, but only the commonly used and best settings.

Type of washing, Cleaning symbol	max. Filling quantity ¹⁾ (dryweight) ²⁾	Programme knob temperature [in °C]	possible Additional programmes
Cotton/linen ³⁾ 	6 kg	ENERGY SAVING 60 (ENERGIEBESPAREN, ECONOMIQUE)	PRE WASH (VOORWAS, PRELAV.) DELICATE (BEHOEDZAAM, SENSITIVE) STAINS (VLEKKEN, TACHES) TIME SAVE
Cotton/Linen 	6 kg	COTTON/LINEN, EASY-CARE (WITTE/BONTE WAS, BLANC/COULEURS, KREUKHERSTELLEND, DEFROISSABLE) 20 to 95	PRE WASH (VOORWAS, PRELAV.) DELICATE (BEHOEDZAAM, SENSITIVE) STAINS (VLEKKEN, TACHES) TIME SAVE
	3 kg	REFRESH (OPFRISSEN, RAFRAICHIR) 30	

Type of washing, Cleaning symbol	max. Filling quantity ¹⁾ (dryweight) ²⁾	Programme knob temperature [in °C]	possible Additional programmes
Easy-care ³⁾ 	3 kg	COTTON/LINEN, EASY-CARE (WITTE/BONTE WAS, BLANC/COULEURS, KREUKHERSTELLEND, DEFROISSABLE) 20 to 60	PRE WASH (VOORWAS, PRELAV.) DELICATE (BEHOEDZAAM, SENSITIVE) STAINS (VLEKKEN, TACHES) TIME SAVE
	1 kg	EASY IRON (STRIJKVRIJ, SANS REPASSAGE) ⁴⁾ 40	PRE WASH (VOORWAS, PRELAV.) STAINS (VLEKKEN, TACHES) TIME SAVE
	3 kg	REFRESH (OPFRISSEN, RAFRAICHIR) 30	
Delicates 	3kg (or. 15-20 m ² curtainings)	DELICATES (FIJNE WAS, LINGE DELICAT) 30, 40	PRE WASH (VOORWAS, PRELAV.) STAINS (VLEKKEN, TACHES) TIME SAVE
	3kg	FASHION 40	TIME SAVE
Wool/HandWashing 	2 kg	WOOL (WOL, LAINE) /  (handwash) COLD(KOUD, FROID) to 40	
Silk/ HandWashing 	1 kg	SILK (ZIJDE, SOIE) /  (handwash) 30	TIME SAVE

1) The load amount inquiry operates in accordance with the EN 60456 standard load.

2) A 10 litre bucket holds around 2.5kg of dry clothes (cotton).

3) Programme settings for checking according to, or in similarity to EN 60 456 and IEC 60 456, are described in chapter „consumption values and time requirements“.

4) Only by adhering to the filling quantity of 1 kg (about 5 to 7 men's easy-careshirts) will crease folds in the wash mostly be avoided.

Separate Rinsing/Conditioner/Starching/Impregnation

Type of washing	Max. Filling quantity (dry weight)	Programme knob
Cotton-/Linen	6kg	RINSING (SPOELEN, RINCAGE)
Wool/Hand wash programme	2kg	RINSE (SPOELEN, RINCAGE) + button TIME SAVE

Separate Spinning

Type of washing	Max. Filling quantity (dry weight)	Programme knob
Cotton-/Linen	6kg	SPIN (CENTRIFUG., ESSORAGE)
Easy-care	3kg	
Delicates	3kg	SHORT SPIN (KORT CENTRIFUG., ESSORAGE DELICAT)
Wool/Hand wash programme	2kg	
Silk	1kg	

Cleaning and Care

Control Panel

Attention! For cleaning panels and control parts, do not use furniture polish or any aggressive cleaning agents.

- ☞ Wipe off control panels with a damp cloth. Use warm water to do this.

Washing Detergent Drawer

The washing detergent drawer should be cleaned from time to time.

- ☞ 1. Pull out the washing detergent drawer as far as it will go.
- 2. Remove the washing detergent drawer with a firm pull.
- 3. Remove the softener insert from the middle compartment.

- 4. Clean the softener insert under running water.

- 5. Clean the compartments from the rear with warm water. It is best to use a bottle brush.

- 6. Push on the softener insert as far as it will go so that it is secure.

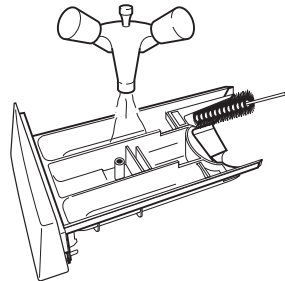
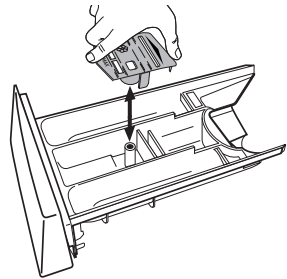

7. Use a brush to clean the entire rinsing-in part of the washing machine, especially the nozzles on the top side of the rinsing-in chamber.

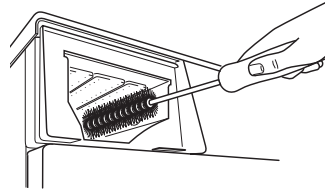

8. Insert the washing detergent drawer into the guide rails and push it in.

Washing Drum

The washing drum is made of high-quality stainless steel. Rust deposits on the drum can occur due to foreign bodies in the washing which can cause rust.

Attention! Do not clean the stainless steel drum with acidic antiliming agents, scouring agents containing chlorine or iron or steel wool. Our Customer Service Department has suitable agents available.

- ☞ Remove any rust deposits on the drum using a stainless steel cleaning agent.

Filling Door

- ☞ Check regularly whether there are deposits or foreign bodies in the rubber sleeve behind the filling door and, if so, remove them.

What to do if ...

Remedying Faults

In the event of a fault, try to solve the problem yourself with the aid of the information provided here. If you call Customer Service to deal with one of the faults listed here or to remedy an operating fault, the customer service technician's visit will not be free of charge, even during the warranty period.

- If the fault code **E1** or **E2** appears in the multi display, you may be able to remedy the fault yourself (see the fault table below).



When you have remedied the fault, press the **START/PAUSE (START/PAUZE, MARCHE/PAUSE)** button.

- With all other displayed faults (**E** plus number or letter): switch appliance off and on again. Reset the wash programme and press the **START/PAUSE** button.

If the fault code is displayed again, please contact the Customer Service department quoting the fault code.

Problem	Possible cause	Remedy
Washing machine does not function.	Electric plug not inserted.	Insert electric plug.
	Fuse of the mains installation is not correct.	Replace fuse.
	Door is not properly closed.	Close door; Lock must engage audibly .
	Button: START/PAUSE (START/PAUZE, MARCHE / PAUSE) has not been pressed long enough.	Press START/PAUSE (START/PAUZE, MARCHE /PAUSE) button until the programme starts.
Door cannot be closed.	Child safety feature is switched On.	Cancel child safety feature (see section „Childsafety feature“).

Problem	Possible cause	Remedy
Water is not entering. Error code E1 appears.	Water tap is switched Off	Open water tap.
	Filter in the socket of the in-flow hose connection is blocked.	Close water tap. Disconnect hose from water tap, remove filter and clean under running water.
	Water tap is full of lime or defective.	Check water tap, if necessary have it repaired.
Washing machine vibrates during operation or is unsteady.	Transport safeguard has not been removed.	Remove transport safeguard according to setting up and connection instructions.
	The height adjustable threaded feet are not correctly adjusted.	Align feet according to setting up and connection instructions.
	There is very little washing in the drum (e.g. only a dressing gown).	Function is not affected by this.
	Water could not be fully pumped out before spinning because drainage hose is kinked or water pump is blocked.	Move the path of the hose and, if necessary, remove kink or clean water pump and, if necessary, remove foreign body from pump housing.
Wash water of the mainwashing foams strongly.	Probably too much washing agent has been filled in.	Dose washing agent exactly according to manufacturers instructions.

Problem	Possible cause	Remedy
Water leaks out of the washing machine.	Connection to the inflow hose is leaking.	Tighten inflow hose connection.
	Drainage hose is leaking.	Check drainage hose and, if necessary, replace.
	Cover of the water pump is not properly closed.	Close cover properly.
	Washing is jammed in the door.	Abort programme, remove washing from door. Start programme again.
	Emergency emptying hose is not properly closed off or is leaking.	Close off emergency emptying hose (see section „Carry out emergency emptying operation“). In the case of a leaking emergency emptying hose, call the customer service.
The emptying pump runs continuously - also when the appliance is switched off.	Anti-flood system Aqua Control has displayed.	Close water tap, remove electric plug and inform customer service.
Conditioner has not rinsed, compartment  for care agent is filled with water.	Conditioner insert in the compartment for care agent is not properly placed on or is blocked.	Clean detergent drawer, seat conditioner insert properly.
Washing is badly creased.	Probably too much washing has been put in.	Note maximum filling quantity (see programme tables). For easy-care textiles select the EASY IRON (STRIJKVRIJ, SANS REPASSAGE) programme.
The washing has not been spun as dry as usual.	The washing was not able to be distributed evenly in the drum prior to spinning.	Always load the drum as full as possible with a combination of large and small items.

Problem	Possible cause	Remedy
Washing is not spun. Remaining water is visible in the drum. Error code E2 appears.	There is a kink in the drainage hose.	Remove kink.
	Maximum pump height (emptying height 1 m from base surface of the appliance) is exceeded.	Refer to the customer service. For pumping heights over 1 m, they have a supplementary set as special spares available.
	Water pump is blocked.	Switch off appliance and pull out electric plug. Clean water pump.
	At the siphon connection: Siphon is blocked.	Clean siphon.
Door cannot be opened when appliance is switched on.	Door is locked for safety reasons (display DOOR/LIGHT is Off).	Wait till display DOOR/LIGHT (DEUR/LICHT, PORTE/ECLAIR.) lights up green.
	Programme security is switched On.	Cancel programme security (see section „Programme security“).
Detergent remains form in the washing powder/liquid drawer.	Water tap is not fully opened.	Open water tap fully.
	Filter in the socket of the inflow hose at the water tap or the appliance is blocked.	Close water tap. Disconnect inflow pipe from water tap and from the appliance and clean filter.
Rinse water is cloudy.	The reason is probably a detergent with a high silicate content.	No negative effect on the rinse results; possibly use a liquid detergent.
When pressing an additional programme button, the corresponding display does not light up.	The selected additional programme cannot be combined with the set programme.	Make another selection.
Programme cycle display blinks constantly.	Programme security is switched On; during the wash cycle the programme knob has been moved.	Turn programme knob back to its original position (see „Programme security“).

If the washing result is not satisfactory

If the washing is grey and limescale forms in the drum

- Not enough washing detergent added.
- The right washing detergent was not used.
- Special types of stain were not pretreated.
- Program or temperature incorrectly set.
- If binary washing detergents were used, the individual components were not added in the correct ratio.

If there are still grey stains on the washing

- Washing contaminated with creams, grease or oils was washing with too little detergent.
- Washing at too low temperature.
- A frequent cause is that conditioner – particularly concentrated form, ended up on the washing. Wash out such stains as quickly as possible and carefully use the right conditioner.

If foam is still visible after the final rinse

- Modern washing detergents can still produce foam, even in the final rinse. The washing is still sufficiently rinsed.

If there are white residues on the washing

- These are the insoluble components of modern detergents. They are not the result of an insufficient rinsing effect. Shake or brush off the washing. Perhaps in future you should turn the washing before washing it. Check the choice of detergent and use a liquid detergent if necessary.

Carry Out an Emergency Emptying Operation

- When the washing machine no longer pumps off the washing solution, an emergency emptying operation must be carried out.
- When the washing machine is in a room where there is a frost risk, an emergency emptying operation must be carried out when there is a frost risk.

Also: Unscrew the intake hose from the water tap and lay it on the floor. Empty the drainage hose.



Warning! Switch off the washing machine before carrying out an emergency emptying operation and pull out the mains plug.

Caution! The washing solution running out of the emergency emptying hose can be hot. Risk of scalding! Allow the washing solution to cool down before carrying out emergency emptying.

 **1.** Provide a flat collecting vessel to catch the washing solution as it runs out.

2. Open the flap downwards in the right part of the base panel and pull it off.

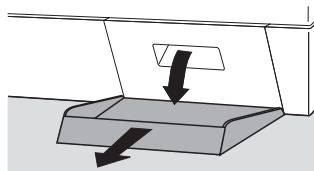

3. Remove the emergency emptying hose from the holder.

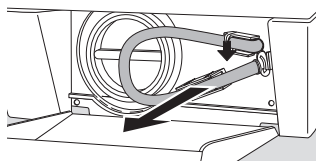

4. Place the collecting vessel underneath.

5. Release and pull out the plug of the emergency emptying hose by turning it anticlockwise.

The washing solution drains off. Depending on the amount of solution, it may be necessary to empty the collecting vessel several times. To do this, temporarily close the emergency emptying hose again with the plug.

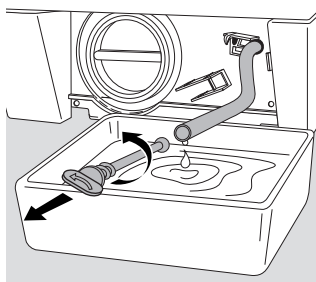

When all the washing solution has drained off:

6. Firmly push the plug into the emergency emptying hose and turn it tight clockwise.
7. Put the emergency emptying hose back into the holder.
8. Insert the flap into the base panel and close.

Drain pump

The drain pump is maintenance free. The cover of the drain pump must only be opened in the event of a malfunction when no more water is being pumped out, e.g. if the pump is blocked.

Before loading the machine, please always ensure that there are no foreign objects left in the pockets or in between the items to be washed. Paper clips, nails etc. which may find their way into the washing machine along with the washing will remain in the drain pump housing.

To restart the drain pump when it is blocked, please proceed as follows:



Warning! Switch off the washing machine and remove the mains plug before cleaning the drain pump!

1. First carry out an emergency emptying procedure (see section "Carrying out emergency emptying").
2. Place a cloth on the floor in front of the cover of the drain pump. Residual water may run out.
3. Unscrew the drain pump cover in an anti-clockwise direction and pull it out.

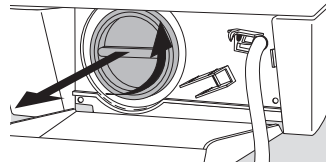

4. Remove any foreign objects and fabric lint from the pump housing.

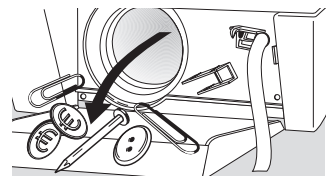

5. Replace the pump cover. Laterally insert the webs on the cover into the guide slots and screw on the cover in a clockwise direction.

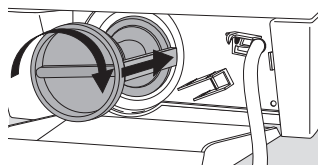

6. Close the emergency emptying hose and place it in the holder.

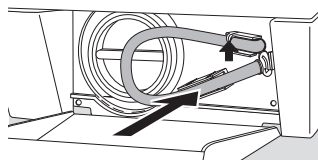

7. Close the flap.

Emergency Unlocking of the Filling Door

When the filling door can no longer be opened, it can be opened with the aid of the emergency unlocking facility.



Warning! Switch off the washing machine before operating the emergency unlocking and remove the plug from the mains!



1. If you can see water in the viewing window of the filling door, first carry out an emergency emptying operation (see Section "Carry out an emergency emptying operation").
2. Open the flap downwards in the right part of the base panel.
3. Turn the rotary knob clockwise with the aid of a coin. The filling door springs open.

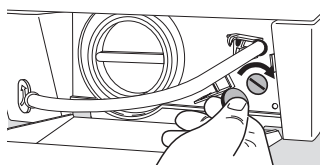

Additional rinse cycle (RINCAGE+)

The washing machine is set to very economical water consumption. However for people who suffer from an allergy, it can be helpful to rinse with more water.





When this function is set, an additional rinse takes place for the programmes COTTON/LINEN, EASY-CARE (WITTE/BONTE WAS, BLANC/COULEURS, KREUKHERSTELLEND, DEFROISSABLE) as well as EASY IRON (STRIJKVRIJ, SANS REPASSAGE) and DELICATES (FIJNE WAS, LINGE DELICAT).

On delivery of the machine, no additional rinse cycle is set.

Set additional rinse cycle:

1. Turn programme knob to SHORT SPIN (KORT CENTRIFUG., ESSORAGE DELICAT).
2. Keep button DELICATES (BEHOEDZAAM, SENSITIVE) depressed for at least 5 seconds.
After the button has been pressed for 5 seconds RINSE+ (SPOELEN+, RINCAGE+) will blink for 5 seconds.
3. Whilst RINSE+ (SPOELEN+, RINCAGE+) blinks, release DELICATE (BEHOEDZAAM, SENSITIVE) button.
when the blinking has stopped, the additional rinse cycle is set. It is available until it is canceled again.
When the additional rinse cycle is set, the RINSE+ (SPOELEN+, RINCAGE+) display will be lit on the programme cycle display before programme start and during the additional rinse cycle.
4. If you want to check whether the additional rinse cycle is set:
 - Turn the programme knob to SHORT SPIN (KORT CENTRIFUG., ESSORAGE DELICAT).
 - Press the DELICATES (BEHOEDZAAM, SENSITIVE) button briefly.
 If RINSE+ blinks on the programme cycle display, then the additional rinse cycle is set.

Cancel additional rinse cycle

-  1. Turn programme knob to SHORT SPIN (KORT CENTRIFUG., ESSORAGE DELICAT).
 2. Keep button DELICATES (BEHOEDZAAM, SENSITIVE) depressed for at least 5 seconds.
Immediately on pressing the button, RINSE+ (SPOELEN+, RINCAGE+) blinks on the programme cycle display. After 5 seconds RINSE+ (SPOELEN+, RINCAGE+) will stop blinking and lights up constantly for a further 5 seconds.
 3. Whilst RINSE+ is lit up constantly, release the DELICATES (BEHOEDZAAM, SENSITIVE) button.
After RINSE+ (SPOELEN+, RINCAGE+) has stopped lighting up, the additional rinse cycle is canceled.
-  With the use of the additional rinse cycle, the water consumption and programme duration increases.

Water cooling

It may be necessary to cool the wash water before pumping out in order to prevent damage to plastics draining pipes.

-  The wash water is cooled before pumping out at the end of the main wash cycle (by the addition of cold water).
(This setting is only effective for the programme COTTON/LINEN, EASY-CARE (WITTE/BONTE WAS, BLANC/COULEURS, KREUKHERSTELLEND, DEFROISSABLE) with a temperature over 40 °C.)
When supplying the appliance, no water cooling is set except for the additional programme DELICATES (BEHOEDZAAM, SENSITIVE).

Setting water cooling:

-  1. Turn programme knob to SHORT SPIN (KORT CENTRIFUG., ESSORAGE DELICAT).
2. Keep the PRE WASH (VOORWAS, PRELAV.) button depressed for at least 5 seconds.
After the button has been depressed for 5 seconds, the MAIN WASH (HOOFDWAS, LAVAGE) will blink on the programme cycle display for 5 seconds.
3. Whilst MAIN WASH (HOOFDWAS, LAVAGE) blinks, release PRE WASH (VOORWAS, PRELAV.) button.
When the blinking has stopped, the water cooling is set. It remains set until it is canceled.

4. if you want to check whether the water cooling is set:
 - Turn the programme knob to SHORT SPIN (KORT CENTRIFUG., ESSORAGE DELICAT).
 - Press the PRE WASH (VOORWAS, PRELAV.) button briefly.If the MAIN WASH (HOOFDWAS, LAVAGE) blinks on the programme cycle display, then the water cooling is set.

Cancel water cooling:

-  1. Turn programme knob to SHORT SPIN (KORT CENTRIFUG., ESSORAGE DELICAT).
2. Keep the PRE WASH (VOORWAS, PRELAV.) button depressed for at least 5 seconds.
Immediately after the button is pressed, MAIN WASH (HOOFDWAS, LAVAGE) will blink on the programme cycle display. After 5 seconds MAIN WASH (HOOFDWAS, LAVAGE) will stop blinking and will remain lit constantly for 5 seconds.
3. Whilst MAIN WASH (HOOFDWAS, LAVAGE) is constantly lit, release the PRE WASH (VOORWAS, PRELAV.) button. The water cooling is canceled after MAINWASH (HOOFDWAS, LAVAGE) stops blinking,



Due to the water cooling the water consumption and the programme duration increase .

Additional rinse cycle and water cooling

Additional rinse cycle and water cooling can be combined. Setting as for „Additional Rinse Cycle“ and „Water Cooling“.

Variomatic-loose spinning

Adjustable spin integrated into the end spin. The washing adheres less to the drum wall and can be removed easier. Can be selected to COTTON/LINEN, EASY-CARE (WITTE/BONTE WAS, BLANC/COULEURS, KREUKHERSTELLEND, DEFROISSABLE).

Set loose spin:

-  1. Turn programme knob to SHORT SPIN (KORT CENTRIFUG., ESSORAGE DELICAT).
2. Keep button STAINS (VLEKKEN, TACHES) depressed for at least 5 seconds.
After the button has been depressed for 5 seconds, the END (EINDE, FIN) on the programme cycle display blinks for 5 seconds.
3. Whilst END (EINDE, FIN) blinks, release the STAINS (VLEKKEN, TACHES) button. Loose spin is set when the blinking stops. It is available until it is canceled again.
4. If you want to check whether loose spin is set:
 - Turn programme knob to SHORT SPIN (KORT CENTRIFUG., ESSORAGE DELICAT).
 - Press the STAINS (VLEKKEN, TACHES) button briefly.If END blinks on the programme cycle display, then loose spin is set

Cancel loose spin:

-  1. Turn programme knob to SHORT SPIN (KORT CENTRIFUG., ESSORAGE DELICAT).
2. Keep button STAINS (VLEKKEN, TACHES) depressed for at least 5 seconds.
Immediately after pressing the button, END (EINDE, FIN) on the programme cycle display. After 5 seconds END (EINDE, FIN) stops blinking and lights up constantly for 5 seconds.
3. Whilst END (EINDE, FIN) is constantly lit, release the STAINS (VLEKKEN, TACHES) button. Loose spin is canceled after END (EINDE, FIN) has stopped lighting up.

Programme security

In order to secure a programme from undesirable changes (e. g. Over-rotating programme knob, additional pressing of buttons, etc.), it is possible to set the programme security. This will prevent damage to your washing.

 Setting and releasing the Programme security is possible at any time during a programme.

Setting programme security:

-  1. Set the desired washing programme.
2. Press the START/PAUSE (START/PAUZE, MARCHE/PAUSE) button to start the programme.
3. Simultaneously press the PREWASH (VOORWAS, PRELAV.) and DELICATE (BEHOEDZAAM, SENSITIVE) buttons for 5 seconds. Programme cycle display blinks for 5 seconds; Programme security is switched On.

 As long as the programme security is switched On, no other settings can be made. The door cannot be opened with the DOOR/LIGHT (DEUR/LICHT, PORTE/ECLAIR.) button. Also, the programme security must first be removed after the wash cycle is ended before the door can be opened.

If an attempt is made during the wash cycle to change the selected setting by pressing a button, then the programme cycle display will blink for 5 seconds.

If an attempt is made to change the selected setting by turning the programme knob, then the programme cycle display will blink until the programme knob is reset to the original setting. The washing cycle is not influenced.

 The programme knob must be in the original position before the programme security can be released.

Releasing the programme security:

-  Keep the PREWASH (VOORWAS, PRELAV.) and DELICATE (BEHOEDZAAM, SENSITIVE) buttons depressed simultaneously for 5 seconds. Programme cycle display blinks for 5 seconds, then lights up constantly for 5 seconds. The programme security is released.

Child Safety Feature

When the child safety feature is used, the filling door can no longer be closed and no more washing programs can be started.

Setting the Child Safety Feature:

- ☞ Use a coin to turn the rotary knob (on the inside of the filling door) clockwise as far as it will go.

⚠ **Warning!** The rotary knob must not be pressed in following adjustment, otherwise the child safety feature is not active. The rotary knob must project as shown in the diagram.

Cancelling the Child Safety Feature:

- ☞ Turn the rotary knob anticlockwise as far as it will go.

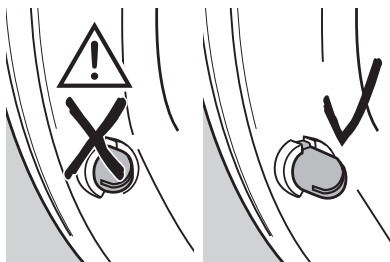
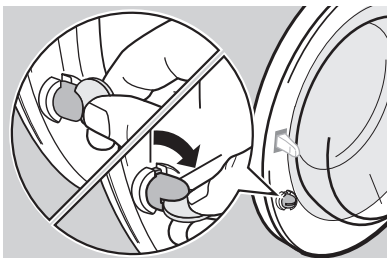

Setting up and connection instructions

Safety Instructions for Installation

- Do not tilt the washing machine onto its front or onto its right side (looking from the front). Electrical components could get wet!
- Check the washing machine for transport damage. Never connect a damaged unit. Consult your supplier in the event of damage.
- Ensure that all parts of the transport safeguard have been removed and that the splash guard is fitted to the unit, see "Removing the Transport Safeguard". Otherwise, damage to the unit or to adjacent furniture could occur during spinning.
- Always insert the plug into a correctly installed PE socket.
- In the case of permanent installation: A permanent installation may only be made by an authorised specialist.
- Before putting the unit into operation, ensure that the rated voltage and current type shown on the unit's rating plate are the same as the mains voltage and current type at the installation location. The required electrical fuse is also shown on the rating plate.
- Should work be carried out on the water supply installations in order to allow the machine to be connected properly to the water supply, this work must be carried out by an authorised installer.
- Should work be carried out on the mains supply in order to allow the machine to be connected properly to the electricity supply, this work must be carried out by an authorised electrician.
- The mains cable may only be replaced by the Customer Service or by an authorised specialist.

Setting Up the Unit

i Washing machines with curved panels are **not suitable for substructures**.

Transporting the Unit

- Do not place the washing machine on its front side or on its right side (looking from the front). Otherwise the electrical components can get wet.
- Never transport the unit without using the transport safeguard. Do not remove the transport safeguard until you reach the installation site. Transporting the unit without the transport safeguard can result in damage to the unit.
- Never lift the unit by the open filling door or by its base.

When transporting the unit with a sack trolley:

- Attach the sack trolley only at the side. The scoop of the sack trolley must not be longer than 24cm, otherwise the float switch can be destroyed.

Remove the Transport Safeguard

Attention! It is essential to remove the transport safeguard before putting the unit into operation! Keep all parts of the transport safeguard in a safe place for possible later transport (moving house).

- i** 1. Open both hose holders on the rear of the unit and remove the hoses and the mains cable.

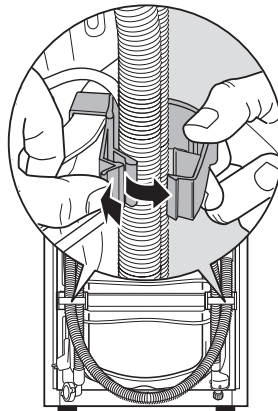

2. Firmly pull both hose holders off the unit.

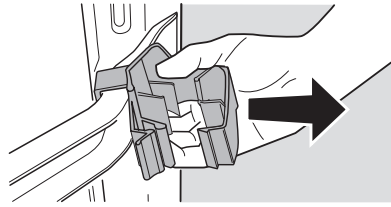

i The special button A and the plug caps B (2 ea.) and C (1 ea.) are supplied with the unit.

3. Remove the screw D, including the compression spring with the special button A.

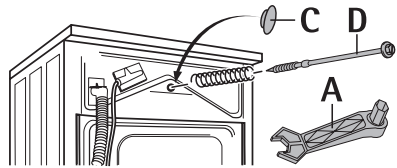

4. Close off the hole with the plug cap C.

Attention! Push in the plug cap so firmly that it engages in the rear panel (this protects the inside of the unit against splash water).

5. Unscrew the two screws E using the special button A.
6. Unscrew the four screws F using the special button A.
7. Remove the transport rail G.
8. Screw the four screws F back in.
9. Close off the two large holes with the plug caps B.

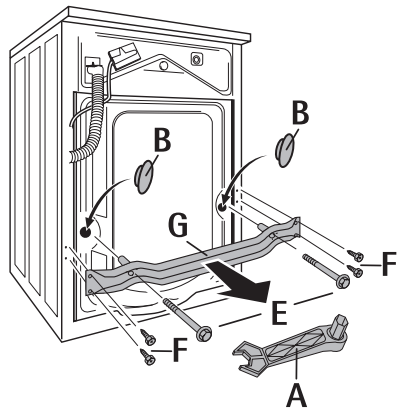

Attention! Push in the plug caps so firmly that they engage in the rear panel (this protects the inside of the unit against splash water).

Prepare the Installation Location

- The installation surface must be clean, dry and free of floor wax residue and other lubricating coatings so that the unit does not slide away. Do not use any lubricants as sliding aids.
- It is not recommended to set up the washing machine on deep-pile carpets or on floor coverings with soft foam underlays, as this would mean that the stability of the unit would not be guaranteed.
- Use ordinary rubber mats as underlays in locations with small-format tiles.
- Never use wood, card or similar underlays to compensate for minor floor unevenness. Always use the adjustable screw-type feet of the machine.
- If, for reasons of space, it is not possible to avoid setting up the unit next to a gas cooker or coal stove: Insert a thermally-insulating panel between the washing machine and the cooker (85 x 57 cm). This panel must have an aluminium foil on the side against the cooker.
- The washing machine must not be set up in a room where there is a danger of frost. Frost damage!
- The intake and drainage hoses must not be bent or pinched.

Setting Up on a Concrete Pedestal

When setting up the washing machine on a concrete pedestal, it is essential for safety reasons to fit stand plates in which the washing machine is then adjusted. The stand plates are available from the Customer Service under spare part number 645 425 058.

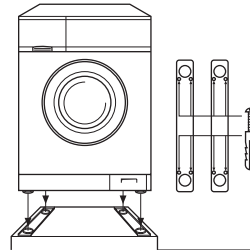

Setting Up on a Vibrating floor

In the case of vibrating floors, especially wooden beam floors with flexible boards, securely screw a water-resistant wooden panel at least 15mm thick onto at least 2 of the floor beams. If possible, set up the unit in a corner of the room where the wooden floor is best firmly installed and is therefore least likely to be susceptible to vibrations.

Compensate for Floor Unevenness

i **Automatic Adjustment Foot:** Your washing machine's rear left foot is of a spring leg design. This guarantees good stability of the unit, even at high spinning speeds.

If the washing machine still does not stand firmly enough during spinning, proceed as follows:

1. Adjust the three adjustment feet to the setpoint 10mm. To do this, use the supplied special button to remove the transport safeguard.

If the automatic adjustment foot still does not reach the floor:

2. Manually extend the automatic adjustment foot (rear left) by the necessary amount.
3. If necessary, check the setting with a spirit level.

Attention! Never use wood, card or similar underlays to compensate for minor floor unevenness. Always use the adjustable screw-type feet of the machine.

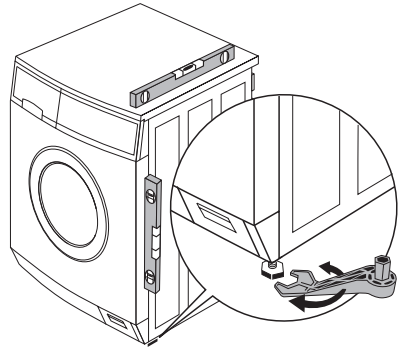

Electrical Connection

Refer to the rating plate for details of the mains voltage, current type and the necessary fuses. The rating plate is located at the top behind the filling door.

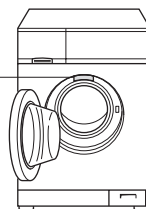
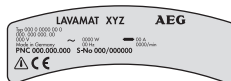

CE This unit conforms to the following EU directives:

- the "Low Voltage Directive" 73/23/EU with changes
- the "EMC Directive" 89/336/EEG with changes

Water Connection

i The washing machine has safety features which prevent contamination of the drinking water and which conform to the legal regulations of the water authorities (e.g. for Germany: DVGW regulations). Other protection measures in the installation are therefore not necessary.

Attention!

- Units for connection to cold water must not be connected to hot water!
- Use only new sets of hoses for connection!

Permissible Water Pressure

The water pressure must be at least 1 bar (= 10N/cm² = 0.1 MPa), maximum 10bar (= 100N/cm² = 1 MPa).

- In the case of more than 10bar: Connect a pressure-reducing valve upstream.
- In the case of less than 1 bar: Unscrew the intake hose on the unit side on the inlet solenoid valve and remove the flow regulator (to do this, remove the filter with pointed pliers and remove the rubber washer behind). Replace the filter.

Water Inflow

A pressure hose 1.5m in length is supplied.

If a longer inflow hose is required, only a VDE-approved, complete set of hoses with fitted hose screw connections offered by our Customer Service is permissible.

- Sets of hoses in lengths of 2.2 m, 3.5 m and 5 m are available for washing machines without Aqua-Control.
- Sets of hoses in lengths of 2.0 m, 2.9 m and 3.9 m are available for washing machines with Aqua-Control.

Attention! Never cut into pieces in order to extend the hoses!



Sealing rings are supplied either in the plastic nuts of the hose screw connection or in the enclosed pack. Do not use other seals!



1. Connect the hose with the angled connection to the machine.

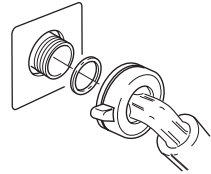

Attention!

- Do not lay the supply hose vertically downwards. Rather, turn it to the right or left as shown in the diagram.
- Only tighten the screw connection manually.

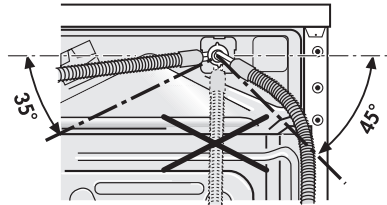

2. Connect the hose with the straight connection to a water tap with a screw thread of R 3/4 (inches).

Attention! Only tighten the screw connection manually.

3. By slowly opening the water tap before putting the washing machine into operation, check whether the connection is free of leaks.

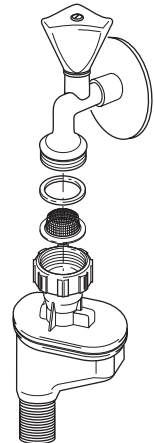

Water Drainage

The drainage hose can either be connected to a siphon or hung in a wash basin or bath tub.

Only original hoses may be used for extension purposes (max. 3m on the floor and then up to 80cm high). The Customer Service stocks hoses in lengths of 2.7 and 4 m.

Attention! It is absolutely essential to install the drainage hose free of pinches.

Water Drainage into a Siphon

The grommet on the end of the hose fits all commonly used siphon types.



Secure the grommet/siphon connecting point with a hose clamp.

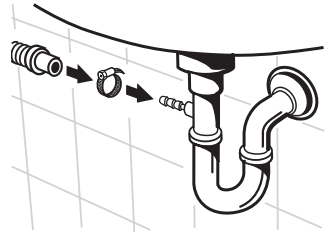

Draining the water into a basin

Attention!

– Small basins are not suitable for draining the water into them.
Water could overflow!

– It is not permitted to submerge the end of the drainage hose into the pumped-off water. Water could be sucked up into the hose!

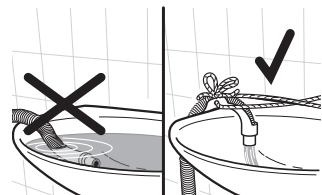

– When hooked into a wash-basin or a bath tub the drainage hose must be protected from slipping out of place by the supplied slip-on elbow. Otherwise the repelling power of the draining water can press the hose out of the sink.



Fix the elbow to the water tap or to the wall with string.

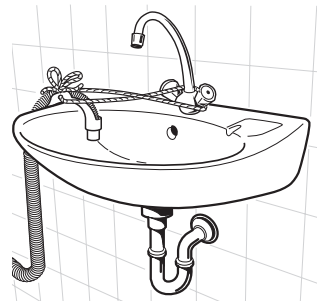

Delivery Heads over 1 m

To pump off the washing / rinsing agent, every washing machine has a pump which transports liquids via the drainage hose up to a height of 1 m, calculated from the machine's floor.

For delivery heads over 1 m, consult the Customer Service.

Technical Data

Height adjustment
Filling quantity
(program-dependent)
Use
Drum speed, spin
Water pressure

Approx. +10/-5 mm
max. 6kg

Domestic
see rating plate
1-10bar
(=10-100N/cm² = 0.1-1.0MPa)

Dimensions

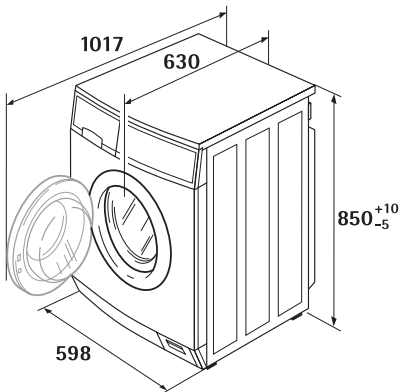

(Measurements in mm)

Guarantee conditions

Belgium

DECLARATION OF GUARANTEE TERMS.

Our appliances are produced with the greatest of care. However, a defect may still occur. Our consumer services department will repair this upon request, either during or after the guarantee period. The service life of the appliance will not, however, be reduced as a result.

This declaration of guarantee terms is based on European Union Directive 99/44/EC and the provisions of the Civil Code. The statutory rights that the consumer has under this legislation are not affected by this declaration of guarantee terms.

This declaration does not affect the vendor's statutory warranty to the end user. The appliance is guaranteed within the context of and in adherence with the following terms:

1. In accordance with provisions laid down in paragraphs 2 to 15, we will remedy free of charge any defect that occurs within 24 months from the date the appliance is delivered to the first end user.
These guarantee terms do not apply in the event of use for professional or equivalent purposes.
2. Performing the guarantee means that the appliance is returned to the condition it was in before the defect occurred. Defective parts are replaced or repaired. Parts replaced free of charge become our property.
3. So as to avoid more severe damage, the defect must be brought to our attention immediately.
4. Applying the guarantee is subject to the consumer providing proof of purchase showing the purchase and/or delivery date.
5. The guarantee will not apply if damage caused to delicate parts, such as glass (vitreous ceramic), synthetic materials and rubber, is the result of inappropriate use.
6. The guarantee cannot be called on for minor faults that do not affect the value or the overall reliability of the appliance.
7. The statutory warranty does not apply when defects are caused by:
 - a chemical or electrochemical reaction caused by water,
 - abnormal environmental conditions in general,
 - unsuitable operating conditions,
 - contact with harsh substances.
8. The guarantee does not apply to defects due to transport which have occurred outside of our responsibility. Nor will the guarantee cover those caused by inadequate installation or assembly, lack of maintenance or failure to respect the assembly instructions or directions for use.
9. Defects that result from repairs or measures carried out by people who are not qualified or expert or defects that result from the addition of non-original accessories or spare parts are not covered by the guarantee.
10. Appliances that are easy to transport may be delivered or sent to the consumer services department. Home repairs are only anticipated for bulky appliances or built-in appliances.
11. If the appliances are built-in, built-under, fixed or suspended in such a way that removing and replacing them in the place where they are fitted takes more than half an hour, the costs that result therefrom will be charged for. Connected damage caused by these removal and replacement operations will be the responsibility of the user.

12. If, during the guarantee period, repairing the same defect repeatedly is not conclusive, or if the repair costs are considered disproportionate, in agreement with the consumer, the defective appliance may be replaced with another appliance of the same value. In this event, we reserve the right to ask for a financial contribution calculated according to the length of time it has been used.
13. A repair under guarantee does not mean that the normal guarantee period will be extended nor that a new guarantee period begins.
14. We give a twelve month guarantee for repairs, limited to the same defect.
15. Except in the event where liability is legally imposed, this declaration of guarantee terms excludes any compensation for damage outside the appliance for which the consumer wishes to assert his rights. In the event of legally admitted liability, compensation will not exceed the purchase price paid for the appliance.

These guarantee terms are only valid for appliances purchased and used in Belgium. For exported appliances, the user must first make sure that they satisfy the technical conditions (e.g.: voltage, frequency, installation instructions, type of gas, etc.) for the country concerned and that they can withstand the local climatic and environmental conditions. For appliances purchased abroad, the user must first ensure that they meet the qualifications required in Belgium. Non-essential or requested adjustments are not covered by the guarantee and are not possible in all cases.

Our consumer services department is always at your disposal, even after the guarantee period has expired.

Address for our consumer services department:

ELECTROLUX HOME PRODUCTS BELGIUM
Bergensesteenweg, 719 - 1502 LEMBEEK
Tel.: 02.363.04.44

Customer services

Belgium

	Tel.:	Fax.:
Electrolux Home Products Belgium ELECTROLUX SERVICE Bergensesteenweg 719 1502 Lembeek	Consumer services 02/363.04.44	02/363.04.00 02/363.04.60

Province de Liège: S.D.E. Rue Gaucet 26 4020 Liege	04/343.11.60	04/343.47.68
---	--------------	--------------

Index

A

- Aborting the programme 27
- Additional programme - buttons 12, 30
- Aqua Control 16, 29, 37
- Automatic adjustment foot 9, 53

C

- Care agent 9, 19, 25
- Child safety feature 35, 48
- Conditioner 9, 11, 20, 32
- Correcting the programme 10
- Cottons 18, 30, 32
- Cottons/linen, easy-care 10, 30
- Curtains 17
- Customer service 16, 34, 35, 61, 63

D

- Delay timer 10, 12, 23, 26
- Delicates 11, 12, 18, 31
- Detergent 9, 19, 25
- Detergent dispenser drawer 9, 25
- Drain pump 41

E

- Easy iron 12, 31, 37
- Easy-care 18, 31
- Emergency emptying 40
- Emergency unlocking 42
- Energy saving programme 12, 30

F

- Fashion 11, 30, 31
- Filling quantity 14, 30
- Frost hazard 6, 40

G

- Gentle spin 11

H

- Hand wash 11, 31

I

- In-wash stain treatment 9, 25

L

- Linen 18, 30, 32

M

- Multidisplay 10, 26, 27, 35, 63

O

- Opening the door 24, 28, 38, 42, 47
- Over-dosed 28

P

- Pre-wash 12, 21, 25, 30
- Pre-wash detergent 9, 25
- Program saving 24
- Programme progress display 10, 27
- Programme security 28, 47
- Pumping out 11, 28

R

- Rating plate 9, 54, 63
- Refresh 12, 30
- Rinse + 43
- Rinse hold 11, 22, 28
- Rinsing 11, 32

S

- Silk 11, 18, 31
 - hand washable 11, 31
- Soaking 12, 23
- Soaking agent 9, 25
- Softener 8, 25
- Solution pump 9
- Spin 11, 20, 22, 24, 27, 32
- Stains 12, 21, 30, 39
- Starching 32

T

- Time save 13, 30

U

- Update 16

W

- Warranty 6, 35, 59
- Wash time 15
- Washing detergent 9, 19
- Washing powder/liquid 20
- Water
 - hardness 8, 19
 - pumping out 11, 28
 - softener 8, 9, 19, 25
- Woollens 11, 18, 31
 - hand washable 11, 31

Service

In the section "What to do if ..." there is a list of some faults which you can remedy yourself. Look there first if a fault occurs. If you find no information there, please consult your Customer Service Centre.

Always prepare in advance for the discussion. By doing so you will simplify the diagnosis and the decision on whether customer service is necessary.

Note the PNC-number and the S-number. Both can be found on the rating plate on the inside of the door on your washing machine.

PNC

S-No.

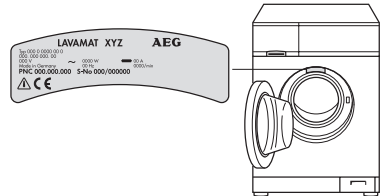

Answer as precisely as possible:

- What form does the fault take?
- Under what circumstances does the fault occur?
- Does the multi display show an error message?

When do you incur costs even during the warranty period?

- if you could have dealt with the fault yourself with the aid of the Faults Table (see the section "What to do if ...") ,
- if several trips by the customer service technician are necessary because he had not received all the necessary information before his visit and must now e.g. fetch spare parts. These multiple trips can be avoided if you prepare your phone call as described above.

 **From the Electrolux Group. The world's No. 1 choice.**

The Electrolux Group is the world's largest producer of powered appliances for kitchen, cleaning and outdoor use. More than 55 million Electrolux Group products (such as refrigerators, cookers, washing machines, vacuum cleaners, chain saws and lawn mowers) are sold each year to a value of approx. USD 14 billion in more than 150 countries around the world.

AEG Hausgeräte GmbH
Postfach 1036
D-90327 Nürnberg

<http://www.aeg.hausgeraete.de>

© Copyright by AEG

822 943 419-01-250403-02

Subject to change without notice

Free Manuals Download Website

<http://myh66.com>

<http://usermanuals.us>

<http://www.somanuals.com>

<http://www.4manuals.cc>

<http://www.manual-lib.com>

<http://www.404manual.com>

<http://www.luxmanual.com>

<http://aubethermostatmanual.com>

Golf course search by state

<http://golfingnear.com>

Email search by domain

<http://emailbydomain.com>

Auto manuals search

<http://auto.somanuals.com>

TV manuals search

<http://tv.somanuals.com>