

K8N-DL



Motherboard

E1905

**First Edition V1
February 2005**

Copyright © 2005 ASUSTeK COMPUTER INC. All Rights Reserved.

No part of this manual, including the products and software described in it, may be reproduced, transmitted, transcribed, stored in a retrieval system, or translated into any language in any form or by any means, except documentation kept by the purchaser for backup purposes, without the express written permission of ASUSTeK COMPUTER INC. ("ASUS").

Product warranty or service will not be extended if: (1) the product is repaired, modified or altered, unless such repair, modification or alteration is authorized in writing by ASUS; or (2) the serial number of the product is defaced or missing.

ASUS PROVIDES THIS MANUAL "AS IS" WITHOUT WARRANTY OF ANY KIND, EITHER EXPRESS OR IMPLIED, INCLUDING BUT NOT LIMITED TO THE IMPLIED WARRANTIES OR CONDITIONS OF MERCHANTABILITY OR FITNESS FOR A PARTICULAR PURPOSE. IN NO EVENT SHALL ASUS, ITS DIRECTORS, OFFICERS, EMPLOYEES OR AGENTS BE LIABLE FOR ANY INDIRECT, SPECIAL, INCIDENTAL, OR CONSEQUENTIAL DAMAGES (INCLUDING DAMAGES FOR LOSS OF PROFITS, LOSS OF BUSINESS, LOSS OF USE OR DATA, INTERRUPTION OF BUSINESS AND THE LIKE), EVEN IF ASUS HAS BEEN ADVISED OF THE POSSIBILITY OF SUCH DAMAGES ARISING FROM ANY DEFECT OR ERROR IN THIS MANUAL OR PRODUCT.

SPECIFICATIONS AND INFORMATION CONTAINED IN THIS MANUAL ARE FURNISHED FOR INFORMATIONAL USE ONLY, AND ARE SUBJECT TO CHANGE AT ANY TIME WITHOUT NOTICE, AND SHOULD NOT BE CONSTRUED AS A COMMITMENT BY ASUS. ASUS ASSUMES NO RESPONSIBILITY OR LIABILITY FOR ANY ERRORS OR INACCURACIES THAT MAY APPEAR IN THIS MANUAL, INCLUDING THE PRODUCTS AND SOFTWARE DESCRIBED IN IT.

Products and corporate names appearing in this manual may or may not be registered trademarks or copyrights of their respective companies, and are used only for identification or explanation and to the owners' benefit, without intent to infringe.

Contents

Notices	vi
Safety information	vii
About this guide	viii
Typography	ix
K8N-DL specifications summary	x

Chapter 1: Product introduction

1.1	Welcome!	1-1
1.2	Package contents	1-1
1.3	Special features	1-2
1.3.1	Product highlights	1-2
1.3.2	Innovative ASUS features	1-4

Chapter 2: Hardware information

2.1	Before you proceed	2-1
2.2	Motherboard overview	2-3
2.2.1	Placement direction	2-3
2.2.2	Screw holes	2-3
2.2.3	Motherboard layout	2-4
2.2.4	Layout Contents	2-5
2.3.2	Installing the CPU	2-7
2.3	Central Processing Unit (CPU)	2-7
2.3.1	Overview	2-7
2.3.3	Installing the heatsink and fan	2-9
2.4	System memory	2-11
2.4.1	Overview	2-11
2.4.2	Memory Configurations	2-12
2.4.3	Installing a DIMM	2-13
2.4.4	Removing a DIMM	2-13
2.5	Expansion slots	2-14
2.5.1	Installing an expansion card	2-14
2.5.2	Configuring an expansion card	2-14
2.5.3	Interrupt assignments	2-15
2.5.4	PCI slots	2-16
2.5.5	PCI Express x16 slot	2-16
2.5.6	PCI Express x1 slot	2-16
2.6	Jumpers	2-17
2.7	Connectors	2-20
2.7.1	Rear panel connectors	2-20
2.7.2	Internal connectors	2-22

Contents

Chapter 3: Powering up

- 3.1 Starting up for the first time 3-1
- 3.2 Powering off the computer 3-2
 - 3.2.1 Using the OS shut down function 3-2
 - 3.2.2 Using the dual function power switch 3-2
- 3.3 ASUS POST Reporter™ 3-3
 - 3.3.1 Vocal POST messages 3-3
 - 3.3.2 Winbond Voice Editor 3-5

Chapter 4: BIOS setup

- 4.1 Managing and updating your BIOS 4-1
 - 4.1.1 Creating a bootable floppy disk 4-1
 - 4.1.2 Updating the BIOS 4-2
 - 4.1.3 Saving the current BIOS file 4-4
 - 4.1.4 ASUS CrashFree BIOS 2 utility 4-5
 - 4.1.5 ASUS EZ Flash utility 4-7
 - 4.1.6 ASUS Update utility 4-8
- 4.2 BIOS setup program 4-11
 - 4.2.1 BIOS menu screen 4-12
 - 4.2.2 Menu bar 4-12
 - 4.2.3 Legend bar 4-13
 - 4.2.4 Menu items 4-13
 - 4.2.5 Sub-menu items 4-13
 - 4.2.6 Configuration fields 4-13
 - 4.2.7 Pop-up window 4-14
 - 4.2.8 General help 4-14
- 4.3 Main menu 4-15
 - 4.3.1 System Time 4-15
 - 4.3.2 System Date 4-15
 - 4.3.3 Legacy Diskette A 4-15
 - 4.3.4 Floppy 3 Mode Support 4-15
 - 4.3.5 Base/Extended/Total Memory 4-15
 - 4.3.6 Primary IDE Master 4-16
 - 4.3.7 Primary IDE Slave 4-18
 - 4.3.8 Secondary IDE Master 4-18
 - 4.3.9 Secondary IDE Slave 4-18
 - 4.3.10 Third IDE Master 4-19
 - 4.3.11 Fourth IDE Master 4-19
 - 4.3.12 IDE Channel 4 Master 4-19
 - 4.3.13 IDE Channel 5 Master 4-19

Contents

4.4	Advanced menu	4-20
4.4.1	CPU Configuration	4-20
4.4.2	Memory Configuration	4-21
4.4.3	Chipset	4-23
4.4.4	Onboard Device	4-26
4.4.5	PCIPnP	4-30
4.4.6	USB Configuration	4-32
4.5	Power menu	4-33
4.5.1	APM Configuration	4-34
4.5.2	Hardware Monitor	4-36
4.6	Boot menu	4-39
4.6.1	Boot Device Priority	4-39
4.6.2	Hard Disk Boot Priority	4-40
4.6.3	Removable Device Priority	4-40
4.6.4	Boot Settings Configuration	4-41
4.6.5	Security	4-43
4.7	Exit menu	4-45

Appendix: Reference information

A.1	K8N-DL block diagram	A-1
-----	----------------------------	-----

Notices

Federal Communications Commission Statement

This device complies with Part 15 of the FCC Rules. Operation is subject to the following two conditions:

- This device may not cause harmful interference, and
- This device must accept any interference received including interference that may cause undesired operation.

This equipment has been tested and found to comply with the limits for a Class B digital device, pursuant to Part 15 of the FCC Rules. These limits are designed to provide reasonable protection against harmful interference in a residential installation. This equipment generates, uses and can radiate radio frequency energy and, if not installed and used in accordance with manufacturer's instructions, may cause harmful interference to radio communications. However, there is no guarantee that interference will not occur in a particular installation. If this equipment does cause harmful interference to radio or television reception, which can be determined by turning the equipment off and on, the user is encouraged to try to correct the interference by one or more of the following measures:

- Reorient or relocate the receiving antenna.
- Increase the separation between the equipment and receiver.
- Connect the equipment to an outlet on a circuit different from that to which the receiver is connected.
- Consult the dealer or an experienced radio/TV technician for help.



The use of shielded cables for connection of the monitor to the graphics card is required to assure compliance with FCC regulations. Changes or modifications to this unit not expressly approved by the party responsible for compliance could void the user's authority to operate this equipment.

Canadian Department of Communications Statement

This digital apparatus does not exceed the Class B limits for radio noise emissions from digital apparatus set out in the Radio Interference Regulations of the Canadian Department of Communications.

This class B digital apparatus complies with Canadian ICES-003.

Safety information

Electrical safety

- To prevent electrical shock hazard, disconnect the power cable from the electrical outlet before relocating the system.
- When adding or removing devices to or from the system, ensure that the power cables for the devices are unplugged before the signal cables are connected. If possible, disconnect all power cables from the existing system before you add a device.
- Before connecting or removing signal cables from the motherboard, ensure that all power cables are unplugged.
- Seek professional assistance before using an adapter or extension cord. These devices could interrupt the grounding circuit.
- Make sure that your power supply is set to the correct voltage in your area. If you are not sure about the voltage of the electrical outlet you are using, contact your local power company.
- If the power supply is broken, do not try to fix it by yourself. Contact a qualified service technician or your retailer.

Operation safety

- Before installing the motherboard and adding devices on it, carefully read all the manuals that came with the package.
- Before using the product, make sure all cables are correctly connected and the power cables are not damaged. If you detect any damage, contact your dealer immediately.
- To avoid short circuits, keep paper clips, screws, and staples away from connectors, slots, sockets and circuitry.
- Avoid dust, humidity, and temperature extremes. Do not place the product in any area where it may become wet.
- Place the product on a stable surface.
- If you encounter technical problems with the product, contact a qualified service technician or your retailer.

About this guide

This user guide contains the information you need when installing and configuring the motherboard.

How this guide is organized

This manual contains the following parts:

- **Chapter 1: Product introduction**
This chapter describes the features of the motherboard and the new technologies it supports.
- **Chapter 2: Hardware information**
This chapter lists the hardware setup procedures that you have to perform when installing system components. It includes description of the switches, jumpers, and connectors on the motherboard.
- **Chapter 3: Powering up**
This chapter describes the power up sequence and ways of shutting down the system.
- **Chapter 4: BIOS setup**
This chapter tells how to change system settings through the BIOS Setup menus. Detailed descriptions of the BIOS parameters are also provided.
- **Appendix: Reference information**
This appendix includes additional information that you may refer to when configuring the motherboard.

Where to find more information

Refer to the following sources for additional information and for product and software updates.

1. ASUS websites

The ASUS website provides updated information on ASUS hardware and software products. Refer to the ASUS contact information.

2. Optional documentation

Your product package may include optional documentation, such as warranty flyers, that may have been added by your dealer. These documents are not part of the standard package.

Conventions used in this guide

To make sure that you perform certain tasks properly, take note of the following symbols used throughout this manual.



DANGER/WARNING: Information to prevent injury to yourself when trying to complete a task.



CAUTION: Information to prevent damage to the components when trying to complete a task.



IMPORTANT: Instructions that you **MUST** follow to complete a task.



NOTE: Tips and additional information to help you complete a task.

Typography

Bold text

Indicates a menu or an item to select.

Italics

Used to emphasize a word or a phrase.

<Key>

Keys enclosed in the less-than and greater-than sign means that you must press the enclosed key.

Example: <Enter> means that you must press the Enter or Return key.

<Key1+Key2+Key3>

If you must press two or more keys simultaneously, the key names are linked with a plus sign (+).

Example: <Ctrl+Alt+D>

Command

Means that you must type the command exactly as shown, then supply the required item or value enclosed in brackets.

Example: At the DOS prompt, type the command line: **format A:/S**

K8N-DL specifications summary

CPU	Dual Socket 940 for AMD Opteron™ 64 processors Supports AMD 64 architecture that enables simultaneous 32-bit and 64-bit computing
Chipset	NVIDIA® CK8-04 Professional
System Bus	1600/2000 MT per second
Memory	Dual-channel memory architecture 6 x 184-pin DIMM sockets support registered ECC 400/333/266 MHz DDR memory modules Supports up to 24 GB system memory <i>(tested only up to 12 GB on this motherboard due to 4 GB DDR availability)</i>
Expansion slots	1 x PCI Express x16 slot 1 x PCI Express x1 slot 2 x PCI slots
Storage	NVIDIA® CK8-04 Professional chipset supports: <ul style="list-style-type: none"> - 2 x Ultra DMA 133/100/66/33 - 4 x SATA-II 3Gb/s drives - RAID 0, RAID 1, RAID 1+0 configurations Silicon Image 3114R RAID controller supports: <ul style="list-style-type: none"> - 4 x SATA-I 150 MB/s - RAID 0, RAID 1, RAID 1+0, and S/W RAID 5
LAN	BROADCOM® BMC5751 Gigabit PCI-E LAN controller
Audio	Realtek® ALC850 8-channel CODEC 1 x Coaxial S/PDIF out port 1 x Optical S/PDIF out port Supports Universal Audio Jack (UAJ®) Technology Supports Audio Sensing and Enumeration Technology
IEEE 1394	TI 1394a controller supports: <ul style="list-style-type: none"> - 1 x IEEE 1394 port (on the rear panel) - 1 x IEEE 1394 connector (on board)
USB	4 x USB 2.0 ports (on the rear panel) 3 x USB 2.0 connectors (on board; supports 6 ports)
Special features	ASUS Post Reporter™ ASUS EZFlash ASUS Smart Fan Technology ASUS CrashFree BIOS 2 ASUS MyLogo2

(continued on the next page)

K8N-DL specifications summary

Internal connectors	<ul style="list-style-type: none"> 1 x Floppy disk drive connector 2 x IDE connectors 4 x Serial ATA connectors 4 x RAID Serial ATA connectors 2 x CPU fan connectors 2 x front fan connector 2 x rear fan connector 1 x Chipset fan connector 1 x 24-pin ATX power connector 1 x 8-pin ATX 12 V power connector 3 x USB 2.0 connectors for 6 additional USB 2.0 ports 1 x Internal audio connectors (CD/AUX) 1 x IEEE 1394 connector 1 x GAME/MIDI connector 1 x Chassis intrusion connector 1 x Front panel audio connector 1 x System panel connector
Rear panel	<ul style="list-style-type: none"> 1 x Parallel port 1 x Serial port (COM1) 1 x IEEE 1394 port 1 x LAN (RJ-45) port 4 x USB 2.0 ports 1 x Optical S/PDIF out port 1 x Coaxial S/PDIF out port 1 x PS/2 keyboard port 1 x PS/2 mouse port 8-channel audio ports
BIOS features	4 Mb Flash ROM, Phoenix-Award BIOS, PnP, DMI2.0, WfM2.0, SM BIOS 2.3
Power Requirement	ATX power supply (with 24-pin and 8-pin 12 V plugs) ATX 12 V 2.0 compliant
Form Factor	ATX form factor: 12 in x 10.5 in (30.5 cm x 26.7 cm)
Support CD contents	<ul style="list-style-type: none"> Device drivers Silicon Image® RAID Utility NVIDIA® RAID utility ASUS Live Update utility Norton Internet Security 2005 Winbond Voice Editor

This chapter describes the motherboard features and the new technologies it supports.

Product introduction



Chapter summary

1.1	Welcome!	1-1
1.2	Package contents	1-1
1.3	Special features	1-2

1.1 Welcome!

Thank you for buying an ASUS® K8N-DL motherboard!

The motherboard delivers a host of new features and latest technologies, making it another standout in the long line of ASUS quality motherboards!

Before you start installing the motherboard, and hardware devices on it, check the items in your package with the list below.

1.2 Package contents

Check your motherboard package for the following items.

Motherboard	ASUS K8N-DL motherboard
I/O modules	IEEE1394 (1 port) module USB 2.0 + GAME port module
Cables	4 x Serial ATA signal cables (dual plugs) 4 x Serial ATA power cables (dual plugs) 2 x 40-conductor IDE cable Floppy disk drive cable
Accessories	I/O shield
Application CD	ASUS motherboard support CD
Documentation	User guide



If any of the above items is damaged or missing, contact your retailer.

1.3 Special features

1.3.1 Product highlights

Latest processor technology



The motherboard comes with dual 940-pin sockets for the AMD Opteron™ 64 processors. The processors are based on AMD's 64-bit and 32-bit architecture, which represents the landmark introduction of the industry's first x86-64 technology, provide a dramatic leap forward in compatibility, performance, investment protection, and reduced total cost of ownership and development.

PCI Express™ interface



The motherboard fully supports PCI Express, the latest I/O interconnect technology that speeds up the PCI bus. PCI Express features point-to-point serial interconnections between devices and allows higher clockspeeds by carrying data in packets. This high speed interface is software compatible with existing PCI specifications. See page 2-16 for details.

HyperTransport™ Technology



HyperTransport™ Technology is a high-speed, low latency, point-to-point link designed to increase the communication speed between integrated circuits in computers, networking and telecommunications equipment up to 48 times faster than other existing technologies.

Dual Channel DDR memory support



Employing the Double Data Rate (DDR) memory technology, the motherboard supports up to 4GB of system memory using DDR400/333/266 DIMMs. The ultra-fast 400MHz memory bus delivers the required bandwidth for the latest 3D graphics, multimedia, and Internet applications. See page 2-11.

Serial ATA 3Gb/s technology



The motherboard supports the next-generation Serial ATA 3Gb/s technology through the Serial ATA interfaces and the NVIDIA® nForce4® PRO chipset. The SATA 3Gb/s specification provides twice the bandwidth of the current Serial ATA products. Additionally, Serial ATA allows thinner, more flexible cables with lower pin count, and reduced voltage requirement. See pages 2-23.

Dual RAID solution

Onboard RAID controllers provide the motherboard with dual-RAID functionality that allows you to select the best RAID solution using IDE or Serial ATA devices.

The NVIDIA® nForce4® PRO allows RAID 0, RAID 1, RAID 0+1 and JBOD configuration for four SATA and two PATA connectors. See page 2-23 for details.

The Sil3114R controller supports four additional SATA connectors and allows RAID 0, RAID 1, RAID 0+1, and a software patch to support RAID 5. See pages 2-24 for details.

Audio technology

The motherboard supports 8-channel audio through the onboard ALC850 CODEC with 16-bit DAC, a stereo 16-bit ADC, and an AC97 2.3 compatible multi-channel audio designed for PC multimedia systems. It also provides Jack-Sensing function, S/PDIF out support, interrupt capability and includes the Realtek® proprietary UAJ® (Universal Audio Jack) technology. See pages 2-21 for details.

S/PDIF digital sound ready

The motherboard supports the S/PDIF Out function through the S/PDIF interfaces on the rear panel. The S/PDIF technology turns your computer into a high-end entertainment system with digital connectivity to powerful audio and speaker systems. See page 2-21 for details.

IEEE 1394a support

The IEEE 1394a interface provides high-speed and flexible PC connectivity to a wide range of peripherals and devices compliant to the IEEE 1394a standard. The IEEE 1394a interface allows up to 400 Mbps transfer rates through simple, low-cost, high-bandwidth asynchronous (real-time) data interfacing between computers, peripherals, and consumer electronic devices such as camcorders, VCRs, printers, TVs, and digital cameras. See pages 2-20 and 2-26 for details.

USB 2.0 technology

The motherboard implements the Universal Serial Bus (USB) 2.0 specification, dramatically increasing the connection speed from the 12 Mbps bandwidth on USB 1.1 to a fast 480 Mbps on USB 2.0. USB 2.0 is backward compatible with USB 1.1. See pages 2-21 and 2-26 for details.

Temperature, fan, and voltage monitoring

The CPU temperature is monitored by the ASIC (integrated in the Winbond Super I/O) to prevent overheating and damage. The system fan rotations per minute (RPM) is monitored for timely failure detection. The ASIC monitors the voltage levels to ensure stable supply of current for critical components. See section “4.5.2 Hardware Monitor” on page 4-37.

1.3.2 Innovative ASUS features

CrashFree BIOS 2

This feature allows you to restore the original BIOS data from the support CD in case when the BIOS codes and data are corrupted. This protection eliminates the need to buy a replacement ROM chip. See details on page 4-5.

ASUS MyLogo2™

This new feature present in the motherboard allows you to personalize and add style to your system with customizable boot logos.

ASUS Smart Fan technology

The ASUS Smart Fan technology smartly adjusts the fan speeds according to the system loading to ensure quiet, cool, and efficient operation. See page 4-38 for details.

ASUS POST Reporter™

The motherboard offers a new exciting feature called the ASUS POST Reporter™ to provide friendly voice messages and alerts during the Power-On Self-Tests (POST) informing you of the system boot status and causes of boot errors, if any. The bundled Winbond Voice Editor software lets you to customize the voice messages in different languages. See page 3-3 for details.

This chapter lists the hardware setup procedures that you have to perform when installing system components. It includes description of the jumpers and connectors on the motherboard.

Hardware information



Chapter summary

2.1	Before you proceed	2-1
2.2	Motherboard overview	2-3
2.3	Central Processing Unit (CPU)	2-7
2.4	System memory	2-11
2.5	Expansion slots	2-14
2.6	Jumpers	2-17
2.7	Connectors	2-20

2.1 Before you proceed

Take note of the following precautions before you install motherboard components or change any motherboard settings.



- Make sure that your power supply unit (PSU) can provide at least the minimum power required by your system. See “8. ATX power connectors” on page 2-25 for details.
- Unplug the power cord from the wall socket before touching any component.
- Use a grounded wrist strap or touch a safely grounded object or to a metal object, such as the power supply case, before handling components to avoid damaging them due to static electricity
- Hold components by the edges to avoid touching the ICs on them.
- Whenever you uninstall any component, place it on a grounded antistatic pad or in the bag that came with the component.
- **Before you install or remove any component, ensure that the ATX power supply is switched off or the power cord is detached from the power supply.** Failure to do so may cause severe damage to the motherboard, peripherals, and/or components.

Onboard LEDs

1. Standby power LED

The motherboard comes with a green standby power LED that lights up to indicate that the system is ON, in sleep mode, or in soft-off mode. This is a reminder that you should shut down the system and unplug the power cable before removing or plugging in any motherboard component.

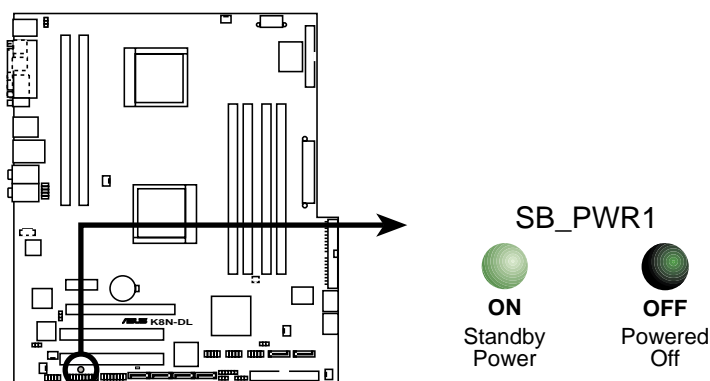

K8N-DL Standby power LED

2. CPU warning LED

The CPU warning LED lights up to indicate that CPU1 has not been installed properly. If this LED stays off, this means that CPU has been installed properly.

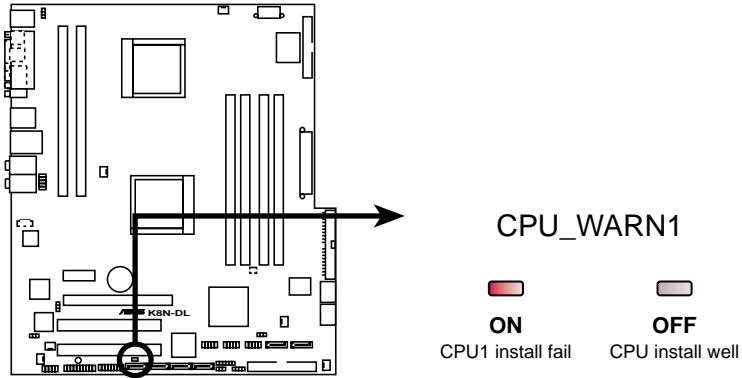

K8N-DL CPU warning LED

2.2 Motherboard overview

Before you install the motherboard, study the configuration of your chassis to ensure that the motherboard fits into it.



Make sure to unplug the power cord before installing or removing the motherboard. Failure to do so can cause you physical injury and damage motherboard components.

2.2.1 Placement direction

When installing the motherboard, make sure that you place it into the chassis in the correct orientation. The edge with external ports goes to the rear part of the chassis as indicated in the image below.

2.2.2 Screw holes

Place ten (10) screws into the holes indicated by circles to secure the motherboard to the chassis.



Do not overtighten the screws! Doing so can damage the motherboard.

Place this side towards
the rear of the chassis

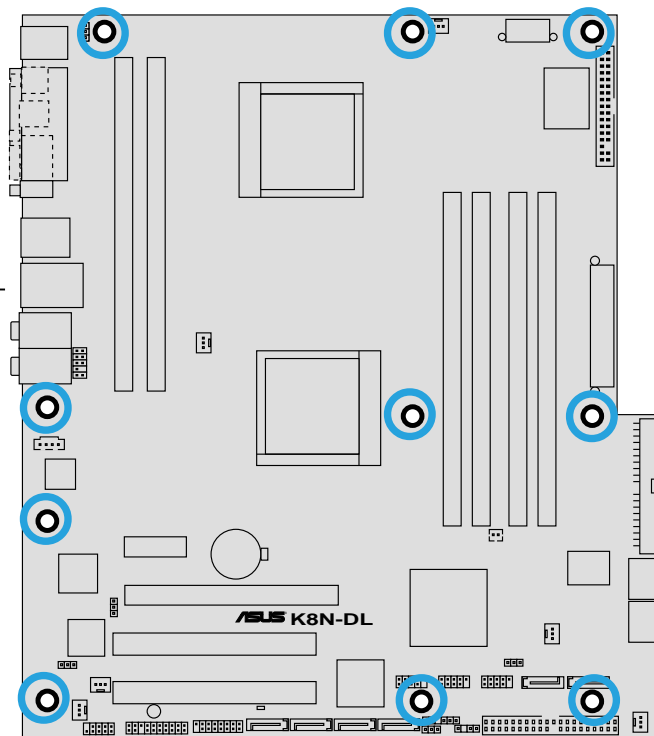

2.2.3 Motherboard layout

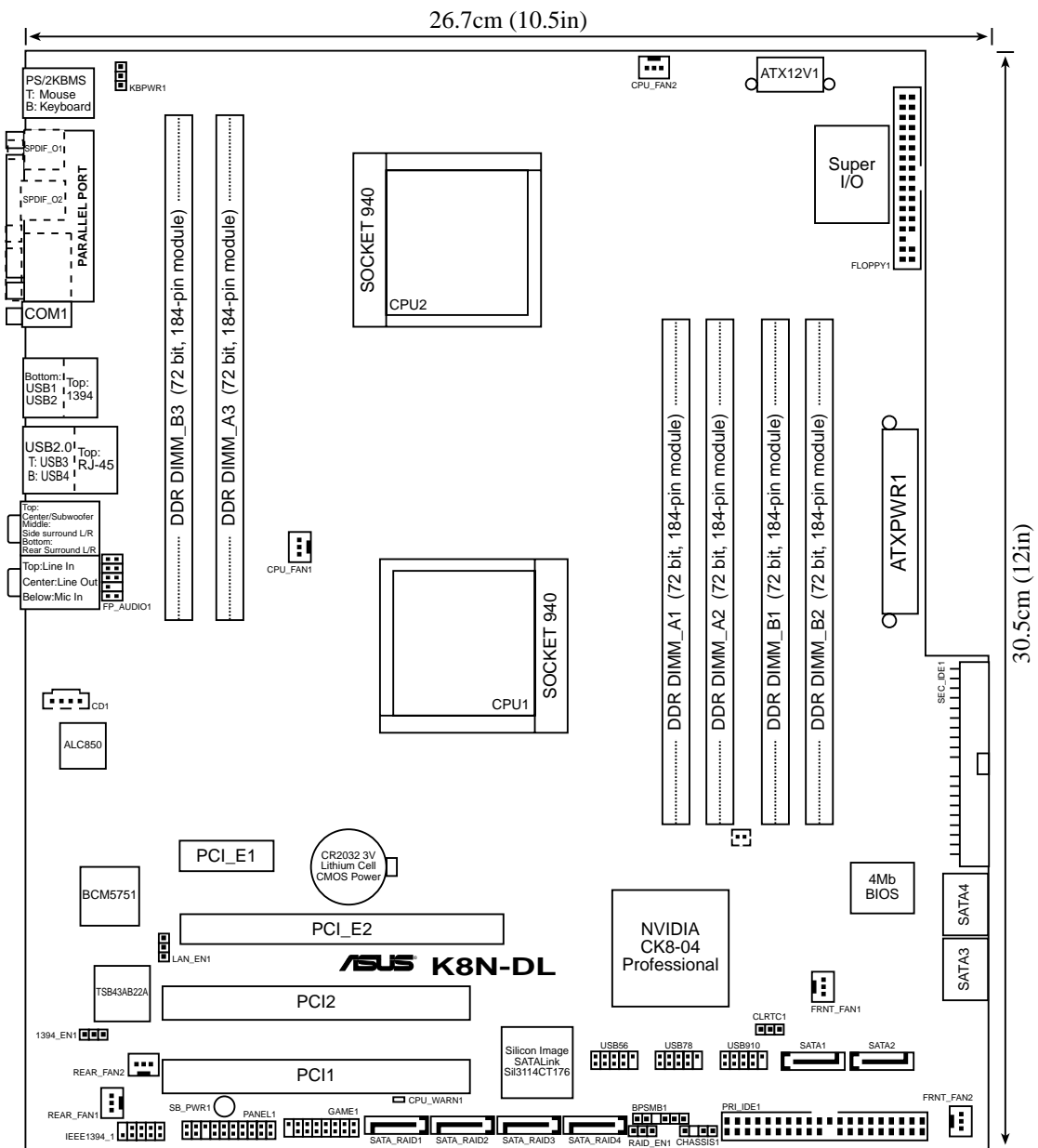

2.2.4 Layout Contents

Slots/Sockets	Page
1. CPU sockets	2-6
2. DDR DIMM sockets	2-11
3. PCI/PCI Express slots	2-16

Jumpers	Page
1. Clear RTC RAM (CLRTC1)	2-17
2. Keyboard power (3-pin KBPWR1)	2-18
3. 1394 controller setting (3-pin 1394_EN1)	2-18
4. Gigabit LAN controller setting (3-pin LAN1_EN1)	2-19
5. RAID controller setting (3-pin RAID_EN1)	2-19

Rear panel connectors	Page
1. PS/2 mouse port (green)	2-20
2. Parallel port	2-20
3. IEEE 1394a port	2-20
4. LAN 1 (RJ-45) port	2-20
5. Side Speaker Out port (gray)	2-20
6. Rear Speaker Out port (black)	2-20
7. Line In port (light blue)	2-20
8. Line Out port (lime)	2-20
9. Microphone port (pink)	2-21
10. Center/Subwoofer port (yellow orange)	2-21
11. USB 2.0 ports 3 and 4	2-21
12. USB 2.0 ports 1 and 2	2-21
13. Serial (COM 1) port	2-21
14. Optical S/PDIF Out port	2-21
15. Coaxial S/PDIF Out port	2-21
16. PS/2 keyboard port (purple)	2-21

Internal connectors	Page
1. Floppy disk drive connector (34-1 pin FLOPPY1)	2-22
2. Primary IDE connectors (40-1 pin PRI_IDE, SEC_IDE)	2-22
3. Serial ATA connectors (7-pin SATA1, SATA2, SATA3, SATA4)	2-23
4. Serial ATA RAID connectors (7-pin SATA_RAID1, SATA_RAID2, SATA_RAID3, SATA_RAID4)	2-24
5. CPU, front, and rear fan connectors (3-pin CPU_FAN1, CPU_FAN2, FRNT_FAN1, FRNT_FAN2, REAR-FAN1, REAR_FAN2)	2-25
6. Backplane SMBus connector (6-1 pin BPSMB1)	2-25
7. USB connectors (10-1 pin USB56, USB78, USB910)	2-26
8. IEEE 1394 connector (10-1 pin IE1394_1)	2-26
9. ATX power connectors (24-pin EATXPWR1, 8-pin ATX12V1)	2-27
10. GAME/MIDI port connector (16-1 pin GAME1)	2-28
11. Internal audio connectors (4-pin CD1)	2-28
12. Chassis intrusion connector (4-1 pin CHASSIS1)	2-29
13. Front panel audio connector (10-1 pin FP_AUDIO1)	2-29
14. System panel connector (20-pin PANEL1)	2-30

2.3 Central Processing Unit (CPU)

2.3.1 Overview

The motherboard comes with dual surface mount 940-pin Zero Insertion Force (ZIF) sockets designed for AMD Opteron™ 64 processors.

The 128-bit-wide data paths of these processors can run applications faster than processors with only 32-bit or 64-bit wide data paths.

Take note of the notched corner on the CPU. This corner should match a specific corner on the socket to ensure correct installation.



Notched corner

2.3.2 Installing the CPU

To install a CPU:

1. Locate the CPU socket on the motherboard.

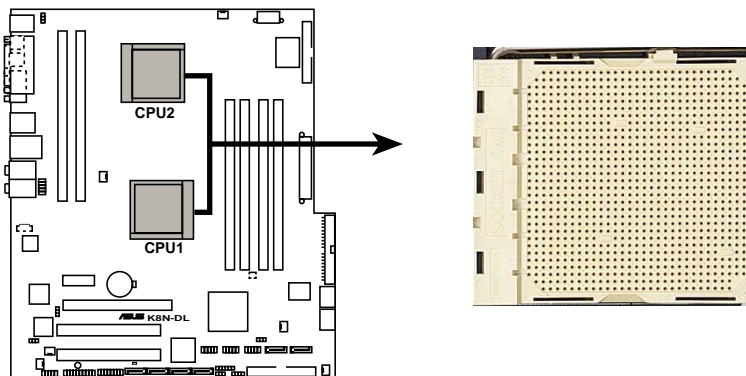

K8N-DL CPU Socket 940



- Before installing the CPU, make sure that the socket box is facing towards you and the load lever is on your left.
- If installing only one CPU, use the CPU socket marked CPU1.

2. Unlock the socket by pressing the lever sideways, then lift it up to a 90°-100° angle.

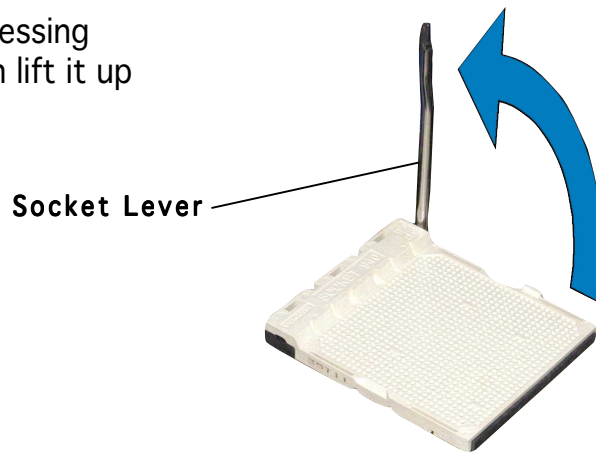

Make sure that the socket lever is lifted up to 90°-100° angle, otherwise the CPU does not fit in completely.

3. Position the CPU above the socket such that the notched corner matches the socket corner with a triangle mark.
4. Carefully insert the CPU into the socket until it fits in place.

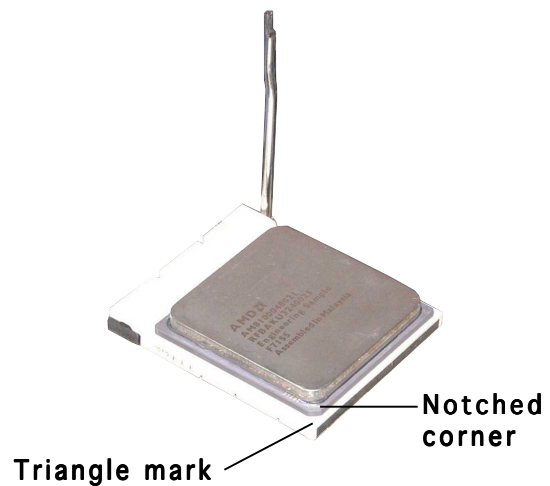

The CPU fits only in one correct orientation. DO NOT force the CPU into the socket to prevent bending the pins and damaging the CPU!

5. When the CPU is in place, push down the socket lever to secure the CPU. The lever clicks on the side tab to indicate that it is locked.

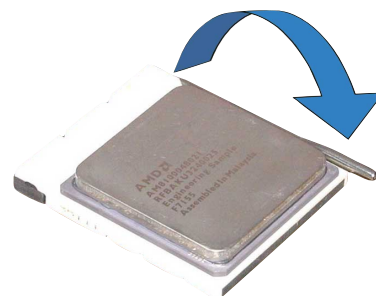

2.3.3 Installing the heatsink and fan

The AMD Opteron™ 64 processors require a specially designed heatsink and fan assembly to ensure optimum thermal condition and performance.



Make sure that you use only qualified heatsink and fan assembly.

Follow these steps to install the CPU heatsink and fan.

1. Place the heatsink on top of the installed CPU, making sure that the heatsink fits properly on the retention module base.



- The retention module base is already installed on the motherboard upon purchase.
 - You do not have to remove the retention module base when installing the CPU or installing other motherboard components.
 - If you purchased a separate CPU heatsink and fan assembly, make sure that a Thermal Interface Material is properly applied to the CPU heatsink or CPU before you install the heatsink and fan assembly.
-

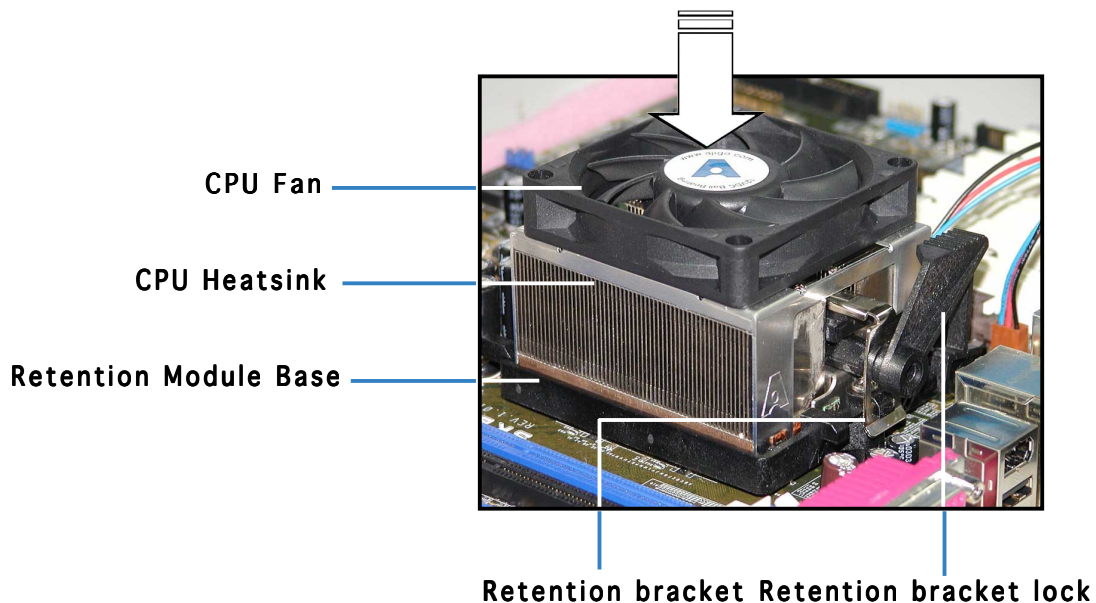

Your boxed CPU heatsink and fan assembly should come with installation instructions for the CPU, heatsink, and the retention mechanism. If the instructions in this section do not match the CPU documentation, follow the latter.

2. Attach one end of the retention bracket to the retention module base.

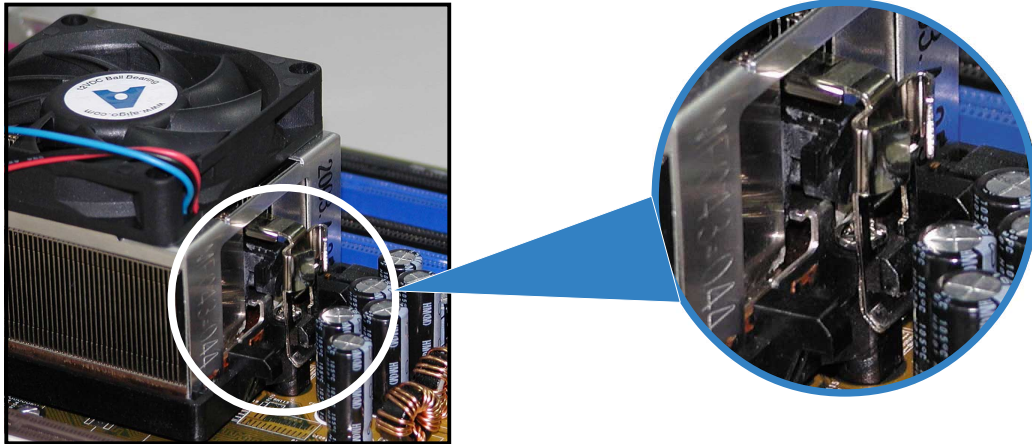

3. Align the other end of the retention bracket (near the retention bracket lock) to the retention module base. A clicking sound denotes that the retention bracket is in place.



Make sure that the fan and heatsink assembly perfectly fits the retention mechanism module base, otherwise you cannot snap the retention bracket in place.

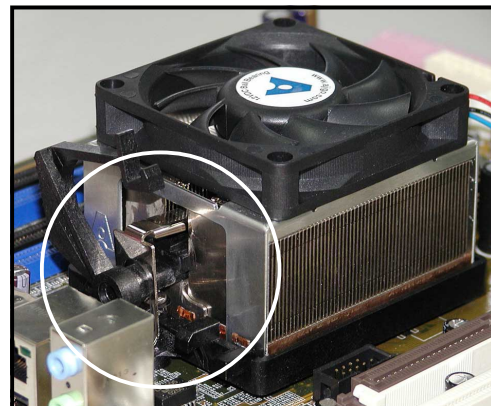

4. Push down the retention bracket lock on the retention mechanism to secure the heatsink and fan to the module base.

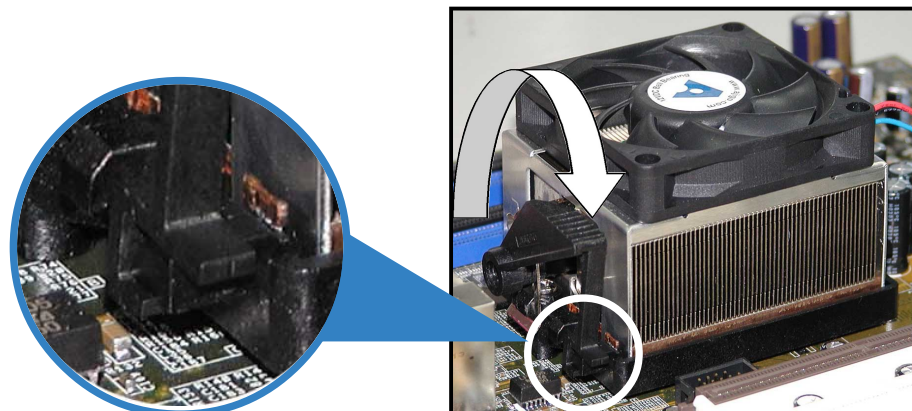

- When the fan and heatsink assembly is in place, connect the CPU fan cable to the appropriate connector on the motherboard, CPU_FAN1 or CPU_FAN2.

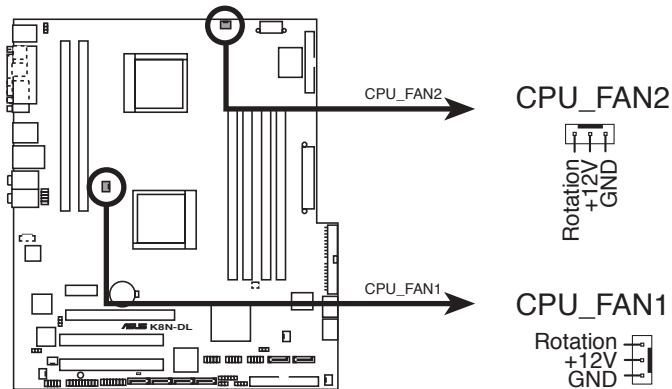

K8N-DL CPU fan connectors



Do not forget to connect the CPU fan connector! Hardware monitoring errors can occur if you fail to plug this connector.

2.4 System memory

2.4.1 Overview

The motherboard comes with six 184-pin Double Data Rate (DDR) Dual Inline Memory Modules (DIMM) sockets.

The following figure illustrates the location of the sockets:

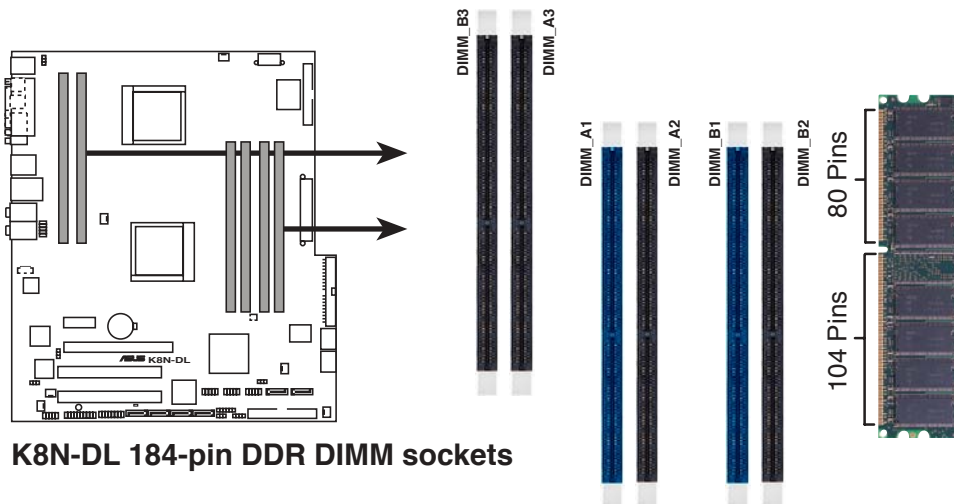

K8N-DL 184-pin DDR DIMM sockets

For CPU 1		Sockets
Channel A	DIMM_A1 and DIMM_A2	
Channel B	DIMM_B1 and DIMM_B2	
For CPU 2		Sockets
Channel A	DIMM_A3	
Channel B	DIMM_B3	

2.4.2 Memory Configurations

You may install 256 MB, 512 MB, 1 GB, 2 GB, or 4 GB registered ECC DDR DIMMs into the DIMM sockets using the memory configurations in this section.



-
- For dual-channel configuration, the total size of memory module(s) installed per channel must be the same for better performance.

Single CPU:

$$\text{DIMM_A1} + \text{DIMM_A2} = \text{DIMM_B1} + \text{DIMM_B2}$$

Dual CPU:

$$\text{DIMM_A1} + \text{DIMM_A2} = \text{DIMM_B1} + \text{DIMM_B2} = \text{DIMM_A3} + \text{DIMM_B3}$$

- When using one DDR DIMM module, install into DIMM_A1 slot only.
 - When using two DDR DIMM modules, install into DIMM_A1 and DIMM_A2 slots only.
 - Always install DIMMs with the same CAS latency. For optimum compatibility, it is recommended that you obtain memory modules from the same vendor. Refer to the DDR400 Qualified Vendors List on the next page for details.
 - 4 GB DDR400 registered ECC DIMMs operate in 2000SER, 2003SER, or 64-bit operating systems.
-

2.4.3 Installing a DIMM



Make sure to unplug the power supply before adding or removing DIMMs or other system components. Failure to do so may cause severe damage to both the motherboard and the components.

1. Unlock a DIMM socket by pressing the retaining clips outward.
2. Align a DIMM on the socket such that the notch on the DIMM matches the break on the socket.

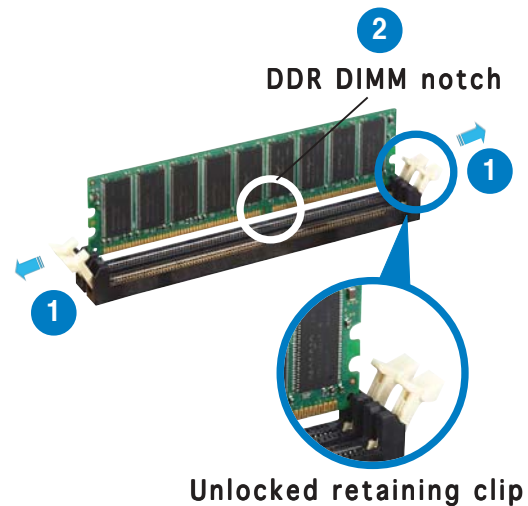

A DDR DIMM is keyed with a notch so that it fits in only one direction. DO NOT force a DIMM into a socket to avoid damaging the DIMM.

3. Firmly insert the DIMM into the socket until the retaining clips snap back in place and the DIMM is properly seated.

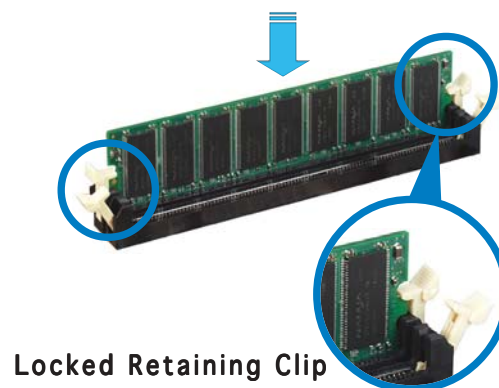

2.4.4 Removing a DIMM

Follow these steps to remove a DIMM.

1. Simultaneously press the retaining clips outward to unlock the DIMM.

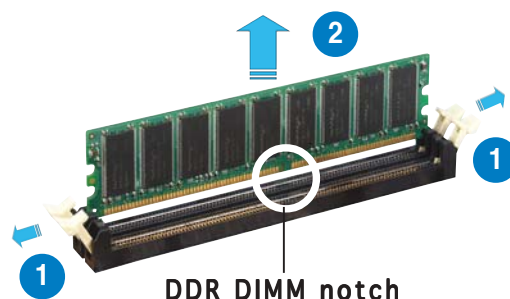

Support the DIMM lightly with your fingers when pressing the retaining clips. The DIMM might get damaged when it flips out with extra force.

2. Remove the DIMM from the socket.

2.5 Expansion slots

In the future, you may need to install expansion cards. The following sub-sections describe the slots and the expansion cards that they support.



Make sure to unplug the power cord before adding or removing expansion cards. Failure to do so may cause you physical injury and damage motherboard components.

2.5.1 Installing an expansion card

To install an expansion card:

1. Before installing the expansion card, read the documentation that came with it and make the necessary hardware settings for the card.
2. Remove the system unit cover (if your motherboard is already installed in a chassis).
3. Remove the bracket opposite the slot that you intend to use. Keep the screw for later use.
4. Align the card connector with the slot and press firmly until the card is completely seated on the slot.
5. Secure the card to the chassis with the screw you removed earlier.
6. Replace the system cover.

2.5.2 Configuring an expansion card

After installing the expansion card, configure it by adjusting the software settings.

1. Turn on the system and change the necessary BIOS settings, if any. See Chapter 4 for information on BIOS setup.
2. Assign an IRQ to the card. Refer to the tables on the next page.
3. Install the software drivers for the expansion card.

2.5.3 Interrupt assignments

Standard interrupt assignments

IRQ	Priority	Standard Function
0	1	System Timer
1	2	Keyboard Controller
2	-	Re-direct to IRQ#9
4	12	Communications Port (COM1)*
5	13	IRQ holder for PCI steering*
6	14	Floppy Disk Controller
7	15	Printer Port (LPT1)*
8	3	System CMOS/Real Time Clock
9	4	IRQ holder for PCI steering*
10	5	IRQ holder for PCI steering*
11	6	IRQ holder for PCI steering*
12	7	PS/2 Compatible Mouse Port*
13	8	Numeric Data Processor
14	9	Primary IDE Channel
15	10	Secondary IDE Channel

* These IRQs are usually available for ISA or PCI devices.

2.5.4 PCI slots

The PCI slots support cards such as a LAN card, SCSI card, USB card, and other cards that comply with PCI specifications. The figure shows a LAN card installed on a PCI slot.

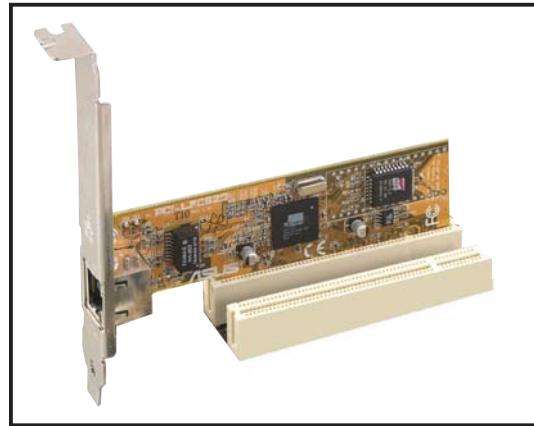

2.5.5 PCI Express x16 slot

This motherboard supports one PCI Express x16 graphics card that complies with the PCI Express specifications. The figure shows a graphics card installed on the PCI Express x16 slot.

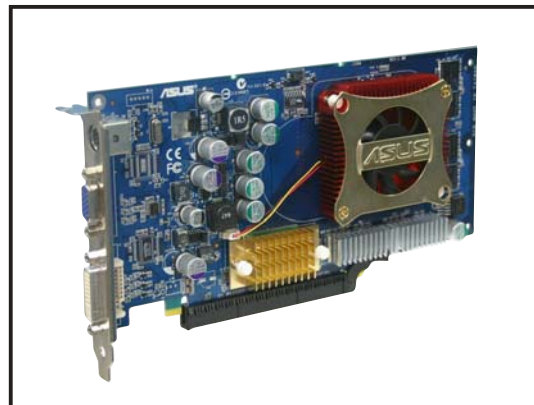

In Normal mode, only the PCI Express black slot can be used for PCI Express x16 graphics cards. The PCI Express white slot functions as a PCI Express x1 slot.

2.5.6 PCI Express x1 slot

This motherboard supports PCI Express x1 network cards, SCSI cards, and other cards that comply with the PCI Express specifications. The figure shows a network card installed on the PCI Express x1 slot.

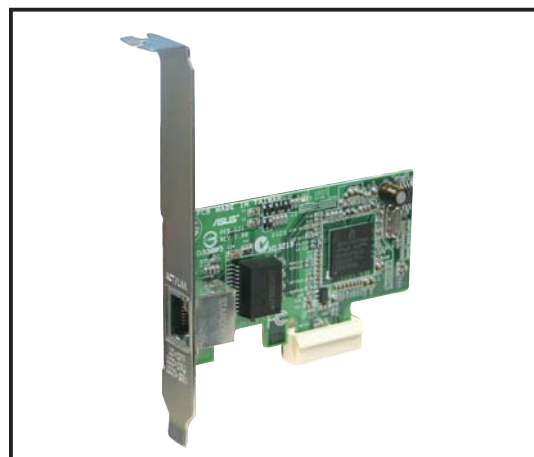

2.6 Jumpers

1. Clear RTC RAM (CLRTC1)

This jumper allows you to clear the Real Time Clock (RTC) RAM in CMOS. You can clear the CMOS memory of date, time, and system setup parameters by erasing the CMOS RTC RAM data. The onboard button cell battery powers the RAM data in CMOS, which include system setup information such as system passwords.

To erase the RTC RAM:

1. Turn OFF the computer and unplug the power cord.
2. Remove the onboard battery.
3. Move the jumper cap from pins 1-2 (default) to pins 2-3. Keep the cap on pins 2-3 for about 5~10 seconds, then move the cap back to pins 1-2.
4. Re-install the battery.
5. Plug the power cord and turn ON the computer.
6. Hold down the key during the boot process and enter BIOS setup to re-enter data.



Except when clearing the RTC RAM, never remove the cap on CLRTC jumper default position. Removing the cap will cause system boot failure!

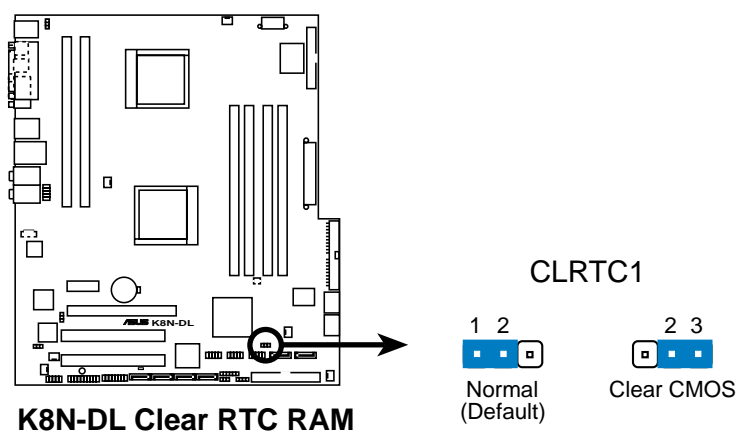

You do not need to clear the RTC when the system hangs due to overclocking. For system failure due to overclocking, use the C.P.R. (CPU Parameter Recall) feature. Shut down and reboot the system so the BIOS can automatically reset parameter settings to default values.

2. Keyboard power (3-pin KBPWR1)

This jumper allows you to enable or disable the keyboard wake-up feature. Set this jumper to pins 2-3 (+5VSB) to wake up the computer when you press a key on the keyboard (the default is the Space Bar). This feature requires an ATX power supply that can supply at least 1A on the +5VSB lead, and a corresponding setting in the BIOS.

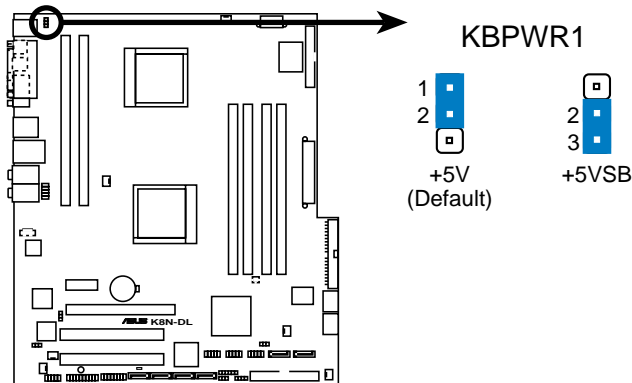

K8N-DL Keyboard power setting

3. 1394 controller setting (3-pin 1394_EN1)

This jumper allows you to enable or disable the onboard TI 1394a IEEE 1394 controller. Set to pins 1-2 to activate the 1394 feature.

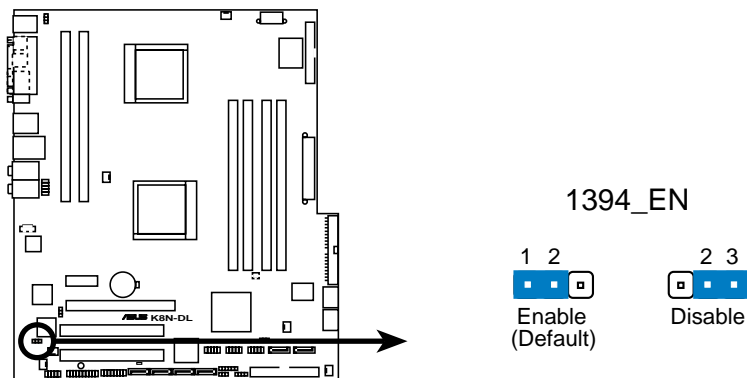

K8N-DL 1394 function setting

4. Gigabit LAN controller setting (3-pin LAN1_EN1)

This jumper allows you to enable or disable the onboard Broadcom® BCM5751 Gigabit LAN1 controller. Set to pins 1-2 to activate the Gigabit LAN feature.

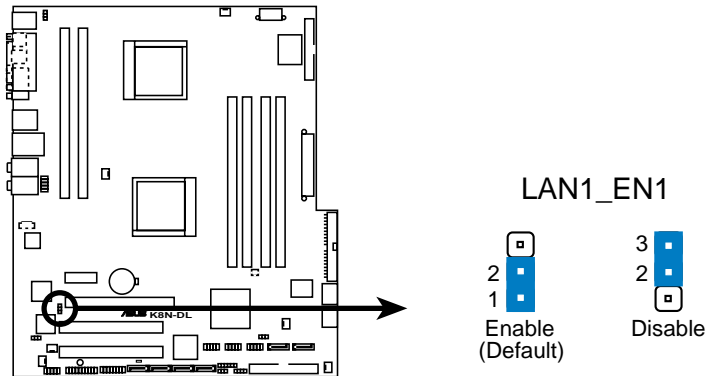

K8N-DL CPU LAN1_EN setting

5. RAID controller setting (3-pin RAID_EN1)

This jumper allows you to enable or disable the onboard Silicon Image® 3114R RAID controller. Set to pins 1-2 to activate the RAID feature.

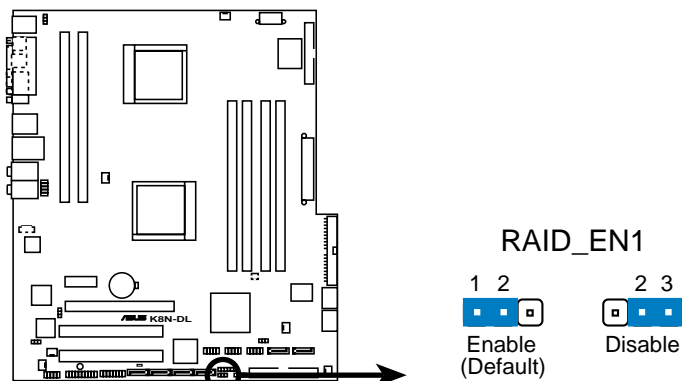

K8N-DL RAID controller setting

2.7 Connectors

2.7.1 Rear panel connectors

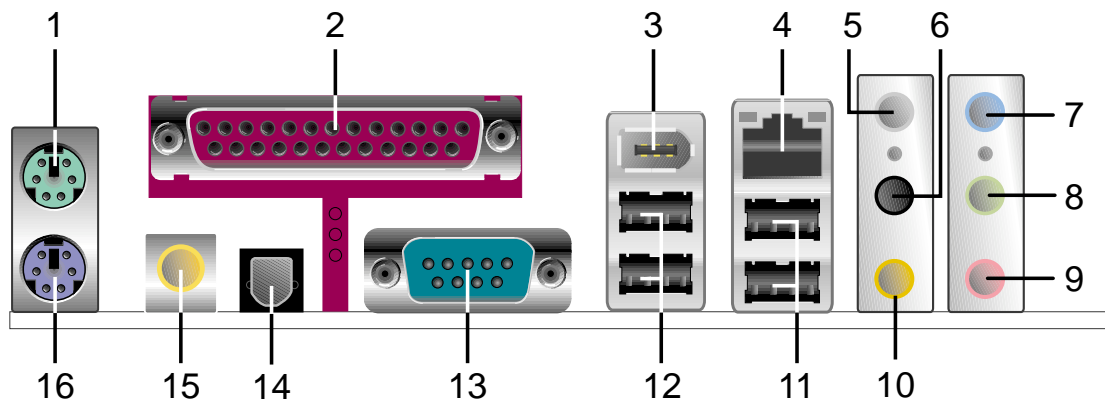

1. **PS/2 mouse port (green).** This port is for a PS/2 mouse.
2. **Parallel port.** This 25-pin port connects a parallel printer, a scanner, or other devices.
3. **IEEE 1394a port.** This 6-pin IEEE 1394 port provides high-speed connectivity for audio/video devices, storage peripherals, PCs, or portable devices.
4. **LAN 1 (RJ-45) port.** Supported by the BROADCOM® BCM5751 Gigabit LAN controller, this port allows Gigabit connection to a Local Area Network (LAN) through a network hub. Refer to the table below for the LAN port LED indications.

LAN port LED indications

ACT/LINK LED		SPEED LED	
Status	Description	Status	Description
OFF	No link	OFF	10 Mbps connection
GREEN	Linked	ORANGE	100 Mbps connection
BLINKING	Data activity	GREEN	1 Gbps connection

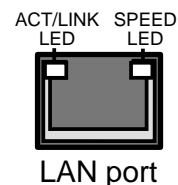

5. **Side Speaker Out port (gray).** This port connects the side speakers in an 8-channel audio configuration.
6. **Rear Speaker Out port (black).** This port connects the rear speakers on a 4-channel, 6-channel, or 8-channel audio configuration.
7. **Line In port (light blue).** This port connects the tape, CD, DVD player, or other audio sources.
8. **Line Out port (lime).** This port connects a headphone or a speaker. In 4-channel, 6-channel, and 8-channel configuration, the function of this port becomes Front Speaker Out.

- 9. **Microphone port (pink).** This port connects a microphone.
- 10. **Center/Subwoofer port (yellow orange).** This port connects the center/subwoofer speakers.



Refer to the audio configuration table below for the function of the audio ports in 2, 4, 6, or 8-channel configuration.

Audio 2, 4, 6, or 8-channel configuration

Port	Headset 2-channel	4-channel	6-channel	8-channel
Light Blue	Line In	Line In	Line In	Line In
Lime	Line Out	Front Speaker Out	Front Speaker Out	Front Speaker Out
Pink	Mic In	Mic In	Mic In	Mic In
Black	•	Rear Speaker Out	Rear Speaker Out	Rear Speaker Out
Gray	•	•	•	Side Speaker Out
Yellow Orange	•	•	Center/Subwoofer	Center/Subwoofer

- 11. **USB 2.0 ports 3 and 4.** These two 4-pin Universal Serial Bus (USB) ports are available for connecting USB 2.0 devices.
- 12. **USB 2.0 ports 1 and 2.** These two 4-pin Universal Serial Bus (USB) ports are available for connecting USB 2.0 devices.
- 13. **Serial (COM 1) port.** This 9-pin communication port is for pointing devices or other serial devices.
- 14. **Optical S/PDIF Out port.** This port connects an external audio output device via an optical S/PDIF cable.
- 15. **Coaxial S/PDIF Out port.** This port connects an external audio output device via a coaxial S/PDIF cable.
- 16. **PS/2 keyboard port (purple).** This port is for a PS/2 keyboard.

2.7.2 Internal connectors

1. Floppy disk drive connector (34-1 pin FLOPPY1)

This connector is for the provided floppy disk drive (FDD) signal cable. Insert one end of the cable to this connector, then connect the other end to the signal connector at the back of the floppy disk drive.

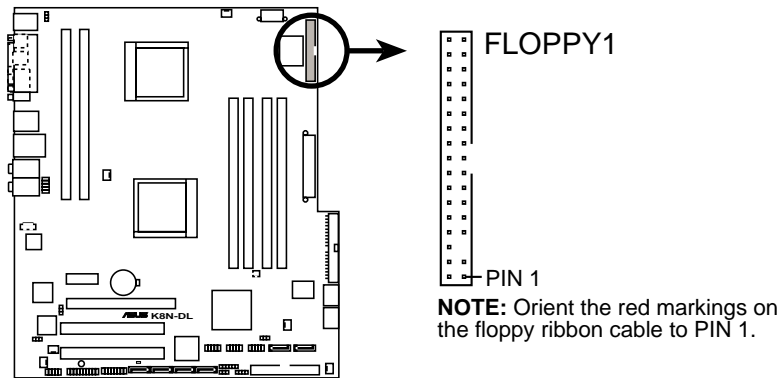

K8N-DL Floppy disk drive connector

2. IDE connectors (40-1 pin PRI_IDE1, SEC_IDE1)

These connectors are for Ultra DMA 133/100/66 signal cables. The Ultra DMA 133/100/66 signal cable has three connectors: a blue connector for the primary IDE connector on the motherboard, a black connector for an Ultra DMA 133/100/66 IDE slave device (optical drive/hard disk drive), and a gray connector for an Ultra DMA 133/100/66 IDE master device (hard disk drive). If you install two hard disk drives, you must configure the second drive as a slave device by setting its jumper accordingly. Refer to the hard disk documentation for the jumper settings.



- The Pin 20 on the IDE connector is removed to match the covered hole on the Ultra DMA cable connector. This prevents incorrect insertion when you connect the IDE cable.
- Use the 80-conductor IDE cable for UltraDMA133/100/66 IDE devices.

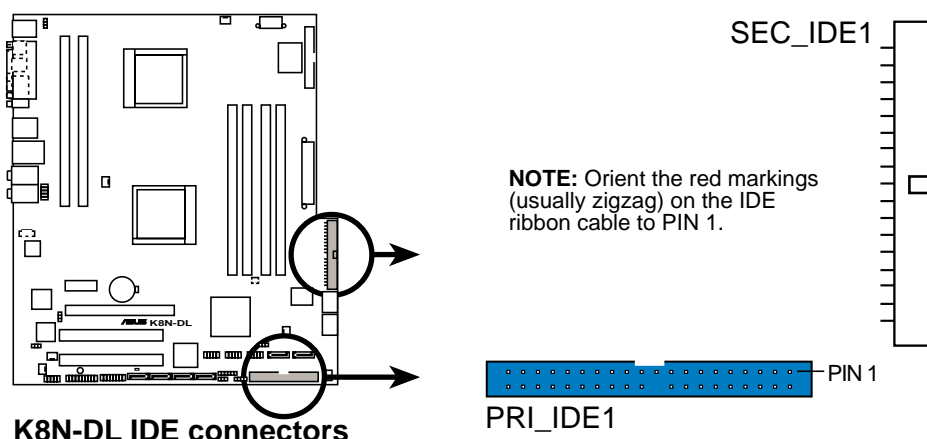

K8N-DL IDE connectors

3. Serial ATA connectors (7-pin SATA1, SATA2, SATA3, SATA4)

Supported by the NVIDIA® nForce4™ chipset, these connectors are for the Serial ATA signal cables for Serial ATA hard disk drives that allows up to 3Gb/s of data transfer rate.

If you installed Serial ATA hard disk drives, you can create a RAID 0, RAID 1, RAID 1+0, or S/W RAID 5 configuration.

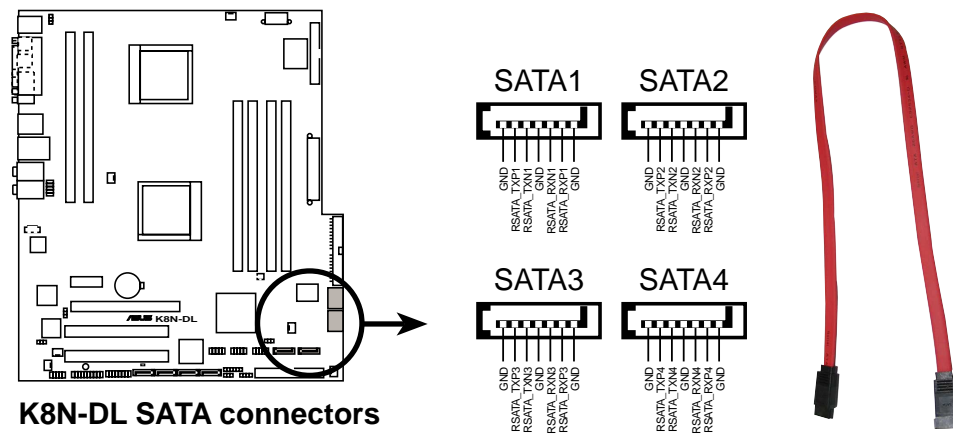

Important notes on Serial ATA

- The actual data transfer rate depends on the speed of Serial ATA hard disks installed.
- See Appendix for instructions on how to install the Serial ATA extension module.

4. Serial ATA RAID connectors (7-pin SATA_RAID1, SATA_RAID2, SATA_RAID3, SATA_RAID4)

Supported by the Silicon Image® Sil3114 RAID controller, these connectors are for Serial ATA signal cables. These connectors support up to four Serial ATA hard disk drives that can be configured as a disk array through the onboard Silicon Image Sil3114 SATA RAID controller.

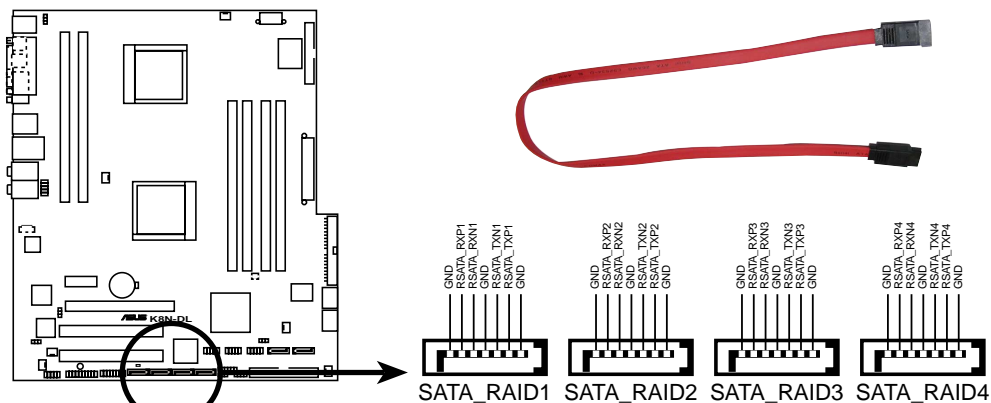

K8N-DL SATA RAID connectors



- Before creating a RAID configuration, make sure that you have connected the Serial ATA cables to these connectors and have installed the Serial ATA hard disk drives; otherwise, you cannot enter the Silicon Image RAID utility and Serial ATA BIOS setup during POST.
- The RAID 5 driver is not Windows Hardware Quality Labs (WHQL) certified.
- See Appendix for instructions on how to install the Serial ATA extension module.

5. CPU, front, and rear fan connectors (3-pin CPU_FAN1, CPU_FAN2, FRNT_FAN1, FRNT_FAN2, REAR_FAN1, REAR_FAN2)

The fan connectors support cooling fans of 350mA~2000mA (24 W max.) or a total of 1A~3.48A (41.76 W max.) at +12V. Connect the fan cables to the fan connectors on the motherboard, making sure that the black wire of each cable matches the ground pin of the connector.



- Do not forget to connect the fan cables to the fan connectors. Lack of sufficient air flow inside the system may damage the motherboard components. These are not jumpers! DO NOT place jumper caps on the fan connectors!
- The ASUS Smart Q-Fan function is supported using the CPU fans (CPU_FAN1, CPU_FAN2) connectors.
- The chipset fan is synchronized with the CPU fans.

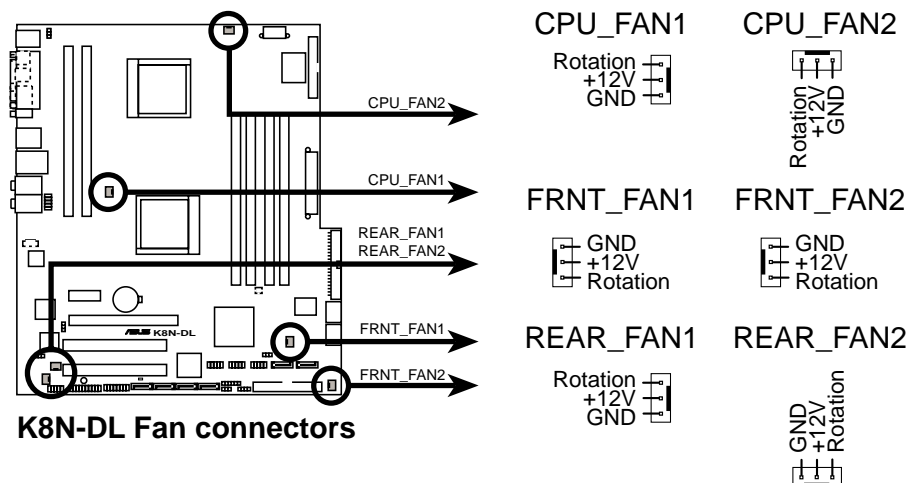

6. Backplane SMBus connector (6-1 pin BPSMB1)

This connector allows you to connect SMBus (System Management Bus) devices. Devices communicate with an SMBus host and /or other SMBus devices using the SMBus interface.

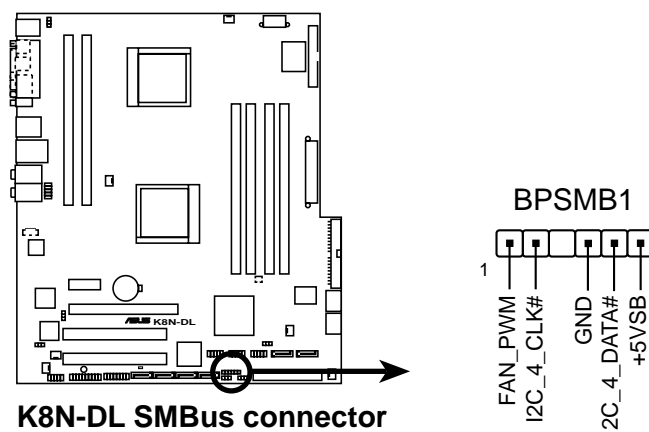

7. USB connectors (10-1 pin USB56, USB78, USB910)

These connectors are for USB 2.0 ports. Connect the USB cable from the USB/GAME port module to any of these connectors, then install the module to a slot opening at the back of the system chassis. These USB connectors comply with USB 2.0 specification that supports up to 480 Mbps connection speed.

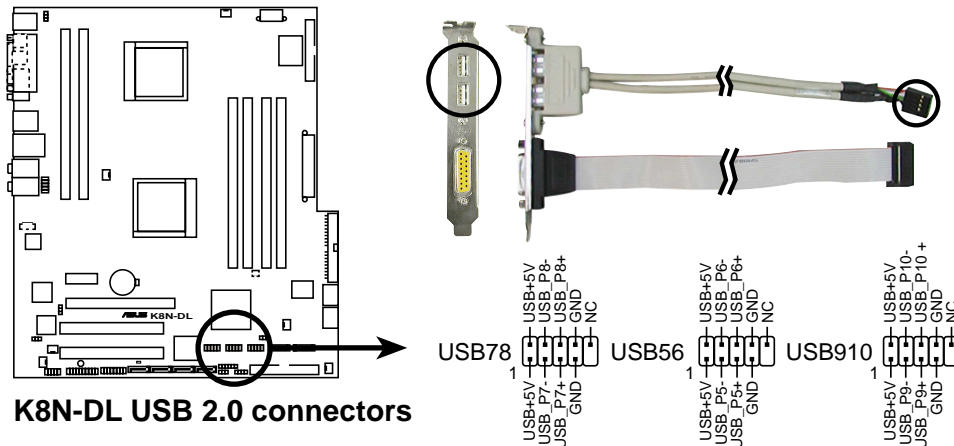

Never connect a **1394 cable** to the USB connectors. Doing so will damage the motherboard!

8. IEEE 1394 connector (10-1 pin IE1394_1)

This connector is for the IEEE 1394a module. Connect the IEEE 1394 module cable to this connector, then install the module to a slot opening at the back of the system chassis.

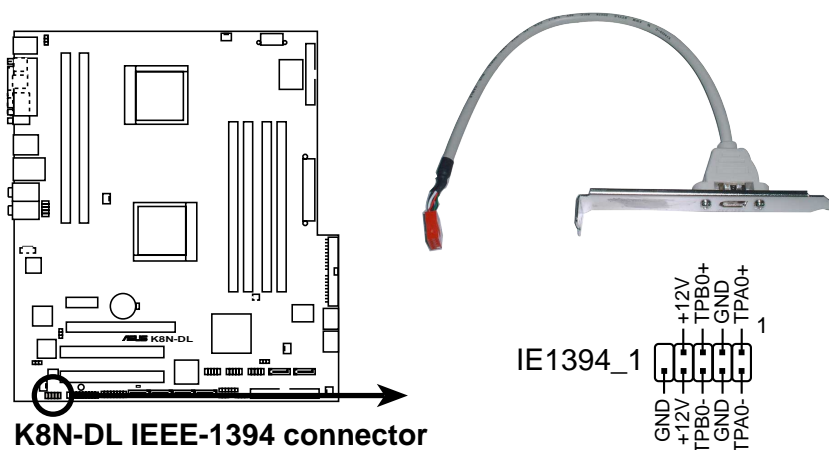

Never connect a **USB cable** to the IEEE 1394 connectors. Doing so will damage the motherboard!

9. ATX power connectors (24-pin EATXPWR1, 8-pin ATX12V1)

These connectors are for an ATX power supply plugs. The power supply plugs are designed to fit these connectors in only one orientation. Find the proper orientation and push down firmly until the connectors completely fit.



- Do not forget to connect the 8-pin ATX +12 V power plug; otherwise, the system will not boot.
- Use of a PSU with a higher power output is recommended when configuring a system with more power-consuming devices. The system may become unstable or may not boot up if the power is inadequate.
- Make sure that your power supply unit (PSU) can provide at least the minimum power required by your system. See the table below for details.

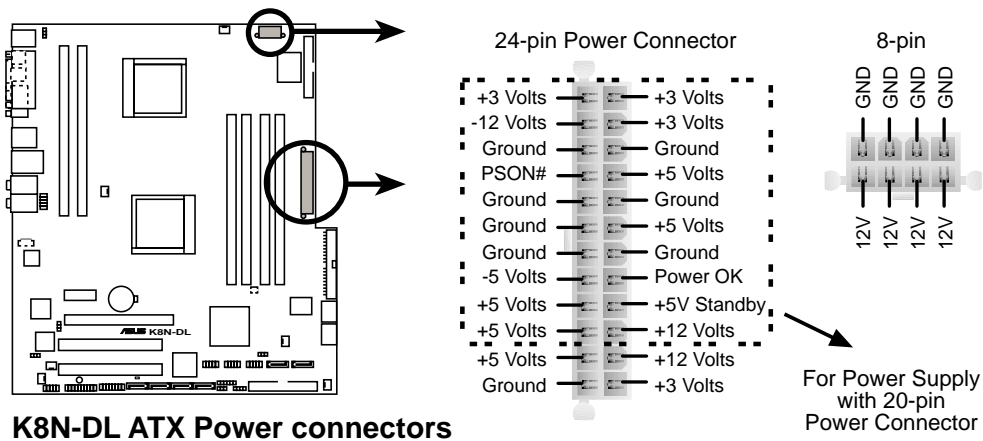

10. GAME/MIDI port connector (16-1 pin GAME1)

This connector is for a GAME/MIDI port. Connect the GAME cable from the USB/GAME port module to this connector, then install the module to a slot opening at the back of the system chassis. The GAME/MIDI port connects a joystick or game pad for playing games, and MIDI devices for playing or editing audio files.

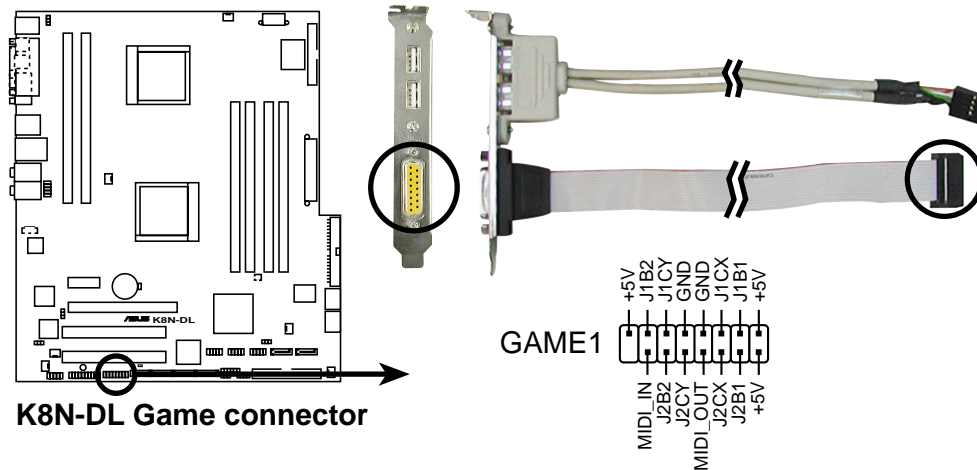

11. Internal audio connector (4-pin CD1)

These connectors allow you to receive stereo audio input from sound sources such as a CD-ROM.

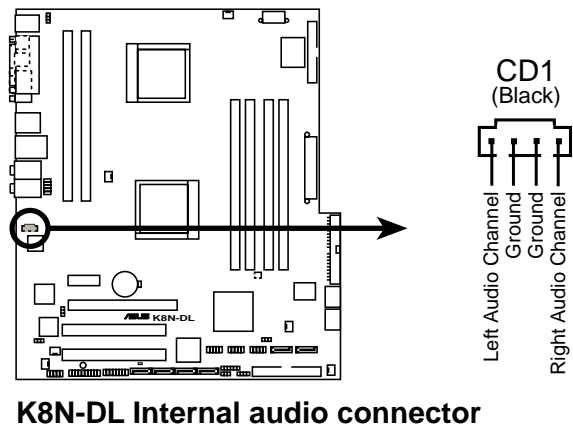

The function of this connector is disabled in 8-channel mode.

12. Chassis intrusion connector (4-1 pin CHASSIS1)

This connector is for a chassis-mounted intrusion detection sensor or switch. Connect one end of the chassis intrusion sensor or switch cable to this connector. The chassis intrusion sensor or switch sends a high-level signal to this connector when a chassis component is removed or replaced. The signal is then generated as a chassis intrusion event.

By default, the pins labeled “Chassis Signal” and “Ground” are shorted with a jumper cap. Remove the jumper caps only when you intend to use the chassis intrusion detection feature.

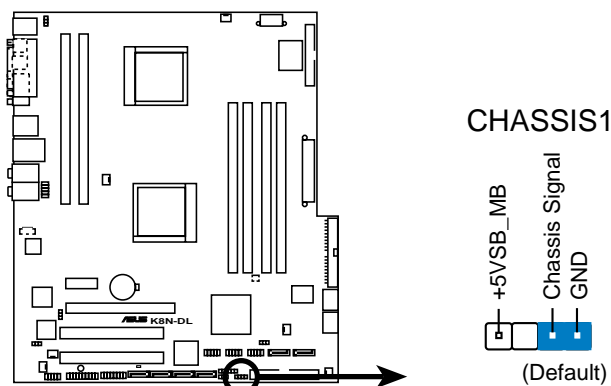

K8N-DL Chassis intrusion connector

13. Front panel audio connector (10-1 pin FP_AUDIO1)

This connector is for a chassis-mounted front panel audio I/O module that supports legacy AC '97 audio standard. Connect one end of the front panel audio I/O module cable to this connector.

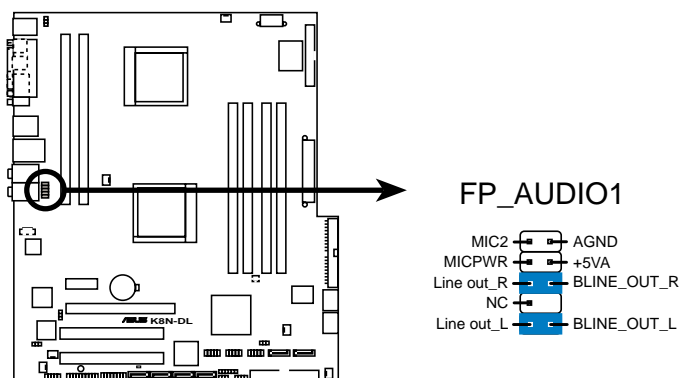

K8N-DL Front panel audio connector

14. System panel connector (20-pin PANEL1)

This connector supports several chassis-mounted functions.

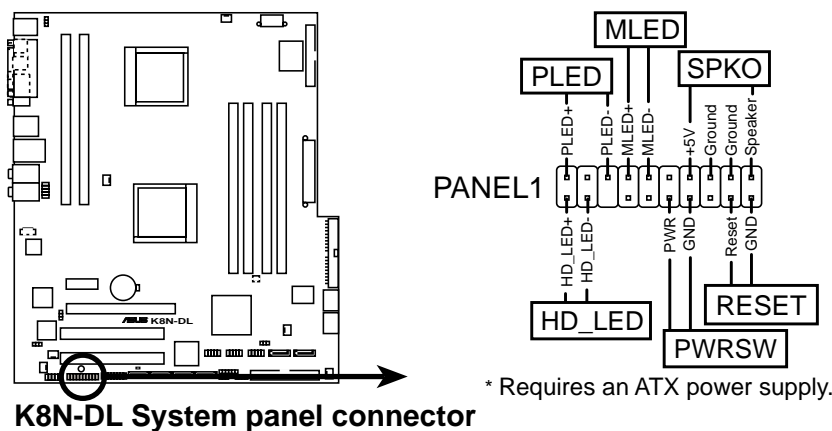

The system panel connector is color-coded for easy connection. Refer to the connector description below for details.

- **System power LED (Green 3-pin PLED)**
This 3-pin connector is for the system power LED. Connect the chassis power LED cable to this connector. The system power LED lights up when you turn on the system power, and blinks when the system is in sleep mode.
- **Hard disk drive activity (Red 2-pin HDD_LED)**
This 2-pin connector is for the HDD Activity LED. Connect the HDD Activity LED cable to this connector. The IDE LED lights up or flashes when data is read from or written to the HDD.
- **System warning speaker (Orange 4-pin SPKO)**
This 4-pin connector is for the chassis-mounted system warning speaker. The speaker allows you to hear system beeps and warnings.
- **Power/Soft-off button (Yellow 2-pin PWRSW)**
This connector is for the system power button. Pressing the power button turns the system ON or puts the system in SLEEP or SOFT-OFF mode depending on the BIOS settings. Pressing the power switch for more than four seconds while the system is ON turns the system OFF.
- **Reset button (Blue 2-pin RESET)**
This 2-pin connector is for the chassis-mounted reset button for system reboot without turning off the system power.

This chapter describes the power up sequence, the vocal POST messages, and ways of shutting down the system.

Powering up

Chapter summary

3.1	Starting up for the first time	3-1
3.2	Powering off the computer	3-2
3.3	ASUS POST Reporter™	3-3

3.1 Starting up for the first time

1. After making all the connections, replace the system case cover.
2. Be sure that all switches are off.
3. Connect the power cord to the power connector at the back of the system chassis.
4. Connect the power cord to a power outlet that is equipped with a surge protector.
5. Turn on the devices in the following order:
 - a. Monitor
 - b. External SCSI devices (starting with the last device on the chain)
 - c. System power
6. After applying power, the system power LED on the system front panel case lights up. For systems with ATX power supplies, the system LED lights up when you press the ATX power button. If your monitor complies with “green” standards or if it has a “power standby” feature, the monitor LED may light up or switch between orange and green after the system LED turns on.

The system then runs the power-on self tests or POST. While the tests are running, the BIOS beeps (see BIOS beep codes table below) or additional messages appear on the screen. If you do not see anything within 30 seconds from the time you turned on the power, the system may have failed a power-on test. Check the jumper settings and connections or call your retailer for assistance.

7. At power on, hold down the <Delete> key to enter the BIOS Setup. Follow the instructions in Chapter 4.

3.2 Powering off the computer

3.2.1 Using the OS shut down function

If you are using Windows® 2000:

1. Click the **Start** button then click **Shut Down...**
2. Make sure that the **Shut Down** option button is selected, then click the **OK** button to shut down the computer.
3. The power supply should turn off after Windows® shuts down.

If you are using Windows® XP:

1. Click the **Start** button then select **Turn Off Computer.**
2. Click the **Turn Off** button to shut down the computer.
3. The power supply should turn off after Windows® shuts down.

3.2.2 Using the dual function power switch

While the system is ON, pressing the power switch for less than four seconds puts the system to sleep mode or to soft-off mode, depending on the BIOS setting. Pressing the power switch for more than four seconds lets the system enter the soft-off mode regardless of the BIOS setting. Refer to section “4.5 Power Menu” in Chapter 4 for details.

3.3 ASUS POST Reporter™

This motherboard includes the Winbond speech controller to support a special feature called the ASUS POST Reporter™. This feature lets you hear vocal messages during POST that alerts you of system events and boot status. In case of a boot failure, you will hear the specific cause of the problem.

These POST messages are customizable using the Winbond Voice Editor software that came with your package. You can record your own messages to replace the default messages.

3.3.1 Vocal POST messages

Following is a list of the default POST messages and the corresponding actions you can take:

POST Message	Action
No CPU installed	<ul style="list-style-type: none">• Install a supported processor to the CPU socket. See section “2.3 Central Processing Unit (CPU)” for details.
System failed CPU test	<ul style="list-style-type: none">• Check the CPU if properly installed.• Call ASUS technical support for assistance. See the ASUS contact information on the inside front cover of this user guide.
System failed memory test	<ul style="list-style-type: none">• Install supported DDR DIMMs into the memory sockets.• Check if the DIMMs on the DIMM sockets are properly installed.• Make sure that your DIMMs are not defective.• Refer to section “2.4 System memory” for instructions on installing a DIMM.
System failed VGA test	<ul style="list-style-type: none">• Install a PCI graphics card into one of the PCI slots, or a PCI Express VGA card into the PCI Express x16 slot.• Make sure that your graphics card is not defective.
System failed due to CPU	<ul style="list-style-type: none">• Check your CPU overclocking settings in the BIOS setup and restore the default CPU parameters.
No keyboard detected	<ul style="list-style-type: none">• Check if your keyboard is properly connected to the purple PS/2 connector on the rear panel.• See section “2.7.1 Rear panel connectors” for the location of the connector.
No IDE hard disk detected	<ul style="list-style-type: none">• Make sure you have connected an IDE hard disk drive to one of the IDE connectors on the motherboard.

POST Message	Action
CPU temperature too high	<ul style="list-style-type: none"> • Check if the CPU fan is working properly.
CPU fan failed	<ul style="list-style-type: none"> • Check the CPU fan and make sure it turns on after you apply power to the system. • Make sure that your CPU fan supports the fan speed detection function.
CPU voltage out of range	<ul style="list-style-type: none"> • Check your power supply and make sure it is not defective. • Call ASUS technical support for assistance. See the “ASUS contact information” on the inside front cover of this user guide.
Computer now booting from operating system	<ul style="list-style-type: none"> • No action required



You can enable or disable the ASUS POST Reporter™ in the **Speech IC Reporter** item in the BIOS setup. See section 4.4.4 for details.

3.3.2 Winbond Voice Editor

The Winbond Voice Editor software allows you to customize the vocal POST messages. You can install this application from the support CD.



To avoid conflicts, do not run the Winbond Voice Editor while running the ASUS PC Probe application.

Launching the Voice Editor

You can launch the program from the Windows® desktop by clicking **Start > All Programs > Winbond Voice Editor > Voice Editor**.

The Winbond Voice Editor screen appears.

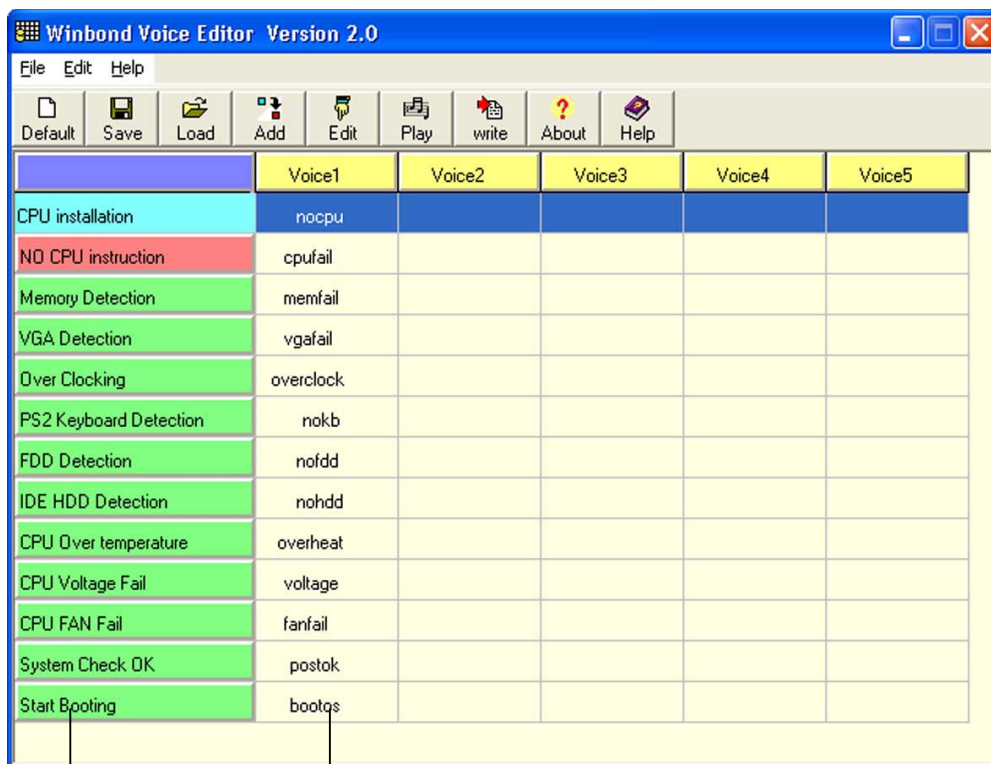

POST Events Default Messages

Playing the default wave files

To play the default wave files, simply click on a POST event on the left side of the screen, then click the Play button.



The default language setting is English.

Changing the default language

To change the default language:

1. Click the **Load** button from the Voice Editor main window. A window with the available languages appears.

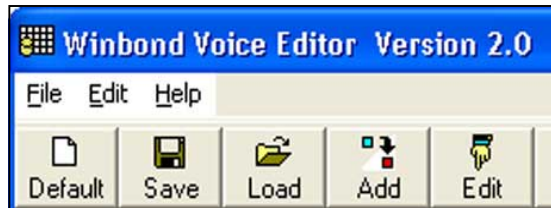

2. Select your desired language, then click **Open**.

The event messages for the language you selected appear on the Voice Editor main window.

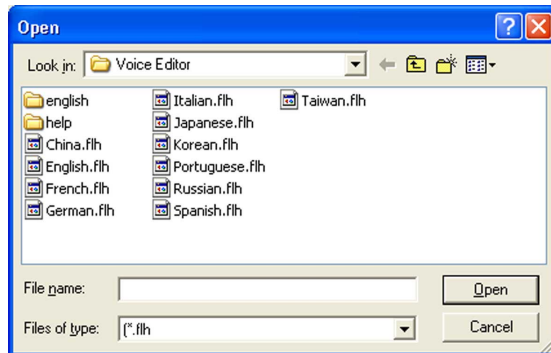

Not all events on some languages have a corresponding message due to file size constraints.

3. Click the **Write** button from the Voice Editor main window to update the EEPROM.
4. Click **Yes** to confirm.

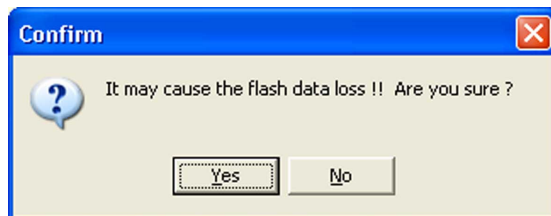

The next time you boot your computer, the ASUS Post Reporter announces the messages in the selected language.

Customizing your POST messages

The Voice Editor application allows you to record your own POST messages if your language is not supported or if you wish to replace the pre-installed wave files.

To customize your POST messages.

1. Launch the Voice Editor application and note the list of POST events on the leftmost column of the screen.
2. Prepare your message for each event.
3. Use a recording software (e.g. Windows® Recorder) to record your messages, then save the messages as wave files (.WAV).



- The total compressed size for all the wave files must not exceed 1Mbit, so keep your messages as short as possible.
- To keep file sizes small, save your files at a low quality. For example, use 8-bit, mono quality at 22Khz sampling rate.
- Create a separate folder for your wave files so you can locate them easily.

4. From the Voice Editor screen, click the **Add** button to display the **Add Wave File** window.
5. Copy the wave files that you recorded to the database, then close the window when done.

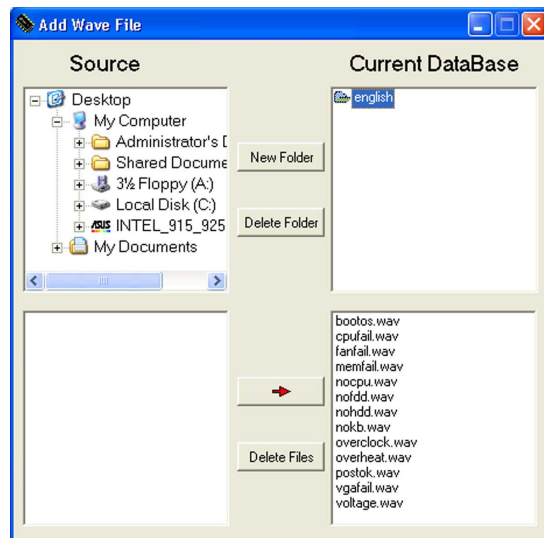

6. Select a POST event on the Voice Editor main window, then click the **Edit** button. The **Event Sound Editor** window appears.
7. Locate and select your wave file for the event, then click on the arrow opposite Voice1. The file you select appears on the space next to it.
8. Click **OK** to return to the Voice Editor main window.
9. Do steps 6 to 8 for the other events.

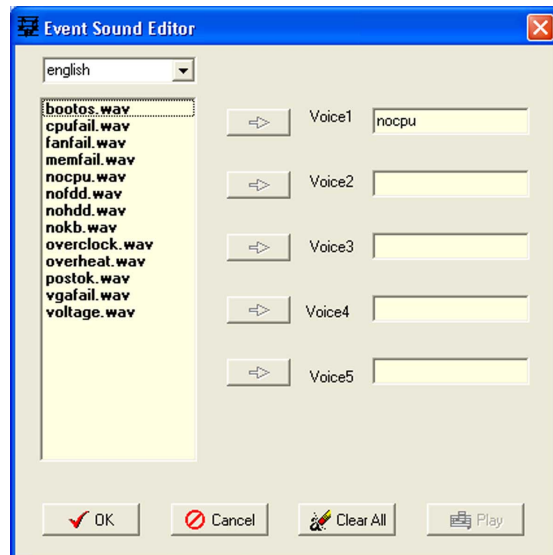

10. When done, click **Save**. A window appears prompting you to save your configuration.
11. Type a file name with an **.flh** extension, then click Save.

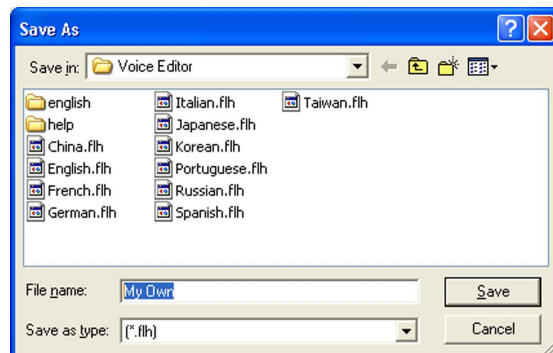

12. Click the **Write** button to compress the file and copy into the EEPROM.
13. Click **Yes** on the confirmation window that appears.

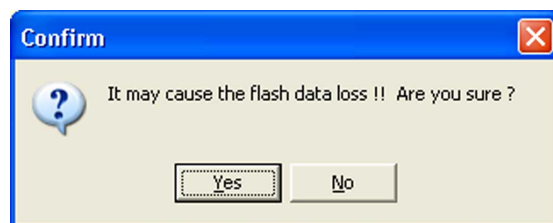

If you receive an error message telling you that the files exceed the total allowable size, do any or all of the following:

- Shorten your messages.
- Save the wave files at a lower quality
- Do not include seldom-used events like FDD Detection, IDE HDD Detection, etc.

This chapter tells how to change the system settings through the BIOS Setup menus. Detailed descriptions of the BIOS parameters are also provided.

BIOS setup

4.1	Managing and updating your BIOS	4-1
4.2	BIOS setup program	4-11
4.3	Main menu	4-15
4.4	Advanced menu	4-20
4.5	Power menu	4-33
4.6	Boot menu	4-39
4.7	Exit menu	4-45

4.1 Managing and updating your BIOS

The following utilities allow you to manage and update the motherboard Basic Input/Output System (BIOS) setup.

1. **Award BIOS Flash Utility** (Updates the BIOS in DOS mode using a bootable floppy disk.)
2. **ASUS CrashFree BIOS 2** (Updates the BIOS using a bootable floppy disk or the motherboard support CD when the BIOS file fails or gets corrupted.)
3. **ASUS EZ Flash** (Updates the BIOS in DOS using a floppy disk or the motherboard support CD.)
4. **ASUS Update** (Updates the BIOS in Windows® environment.)

Refer to the corresponding sections for details on these utilities.



Save a copy of the original motherboard BIOS file to a bootable floppy disk in case you need to restore the BIOS in the future. Copy the original motherboard BIOS using the ASUS Update or AwardBIOS Flash utilities.

4.1.1 Creating a bootable floppy disk

1. Do either one of the following to create a bootable floppy disk.

DOS environment

- a. Insert a 1.44MB floppy disk into the drive.
- b. At the DOS prompt, type **format A:/S** then press <Enter>.

Windows® XP environment

- a. Insert a 1.44 MB floppy disk to the floppy disk drive.
- b. Click **Start** from the Windows® desktop, then select **My Computer**.
- c. Select the 3 1/2 Floppy Drive icon.
- d. Click **File** from the menu, then select **Format**. A **Format 3 1/2 Floppy Disk** window appears.
- e. Select **Create an MS-DOS startup disk** from the format options field, then click **Start**.

Windows® 2000 environment

To create a set of boot disks for Windows® 2000:

- a. Insert a formatted, high density 1.44 MB floppy disk into the drive.
- b. Insert the Windows® 2000 CD to the optical drive.

- c. Click **Start**, then select **Run**.
 - d. From the Open field, type
D:\bootdisk\makeboot a:
assuming that D: is your optical drive.
 - e. Press <Enter>, then follow screen instructions to continue.
2. Copy the original or the latest motherboard BIOS file to the bootable floppy disk.

4.1.2 Updating the BIOS

The Basic Input/Output System (BIOS) can be updated using the AwardBIOS Flash Utility. Follow these instructions to update the BIOS using this utility.

1. Download the latest BIOS file from the ASUS web site. Rename the file to **K8N-DL.BIN** and save it to a floppy disk.



Save only the updated BIOS file in the floppy disk to avoid loading the wrong BIOS file.

2. Copy the AwardBIOS Flash Utility (awdfash.exe) from the Software folder of the support CD to the floppy disk with the latest BIOS file.
3. Boot the system in DOS mode using the bootable floppy disk you created earlier.
4. When the **A:>** appears, replace the bootable floppy disk with the floppy disk containing the new BIOS file and the Award BIOS Flash Utility.
5. At the prompt, type **awdfash** then press <Enter>. The Award BIOS Flash Utility screen appears.

```
AwardBIOS Flash Utility for ASUS V1.01
(C) Phoenix Technologies Ltd. All Rights Reserved

For NF-KC804-K8N-DL-00      DATE: 02/01/2005
Flash Type - SST 49LF004A/B /3.3V

File Name to Program: 

Message: Please input File Name!
```

4.1.3 Saving the current BIOS file

You can use the AwardBIOS Flash Utility to save the current BIOS file. You can load the current BIOS file when the BIOS file gets corrupted during the flashing process.



Make sure that the floppy disk has enough disk space to save the file.

To save the current BIOS file using the AwardBIOS Flash Utility:

1. Follow steps 1 to 6 of the previous section.
2. Press <Y> when the utility prompts you to save the current BIOS file. The following screen appears.

```
AwardBIOS Flash Utility for ASUS V1.01
(C) Phoenix Technologies Ltd. All Rights Reserved

For NF-KC804-K8N-DL-00      DATE: 02/01/2005
Flash Type - SST 49LF004A/B /3.3V

File Name to Program: 1001.bin
Save current BIOS as: _____

Message:
```

3. Type a filename for the current BIOS file in the **Save current BIOS as** field, then press <Enter>.

```
AwardBIOS Flash Utility for ASUS V1.01
(C) Phoenix Technologies Ltd. All Rights Reserved

For NF-KC804-K8N-DL-00      DATE: 02/01/2005
Flash Type - SST 49LF004A/B /3.3V

File Name to Program: 1001.bin
Checksum: DAD6H
Save current BIOS as: old.bin

Message: Please Wait!
```

4. The utility saves the current BIOS file to the floppy disk, then returns to the BIOS flashing process.

```
AwardBIOS Flash Utility for ASUS V1.01
(C) Phoenix Technologies Ltd. All Rights Reserved

For NF-KC804-K8N-DL-00      DATE: 02/01/2005
Flash Type - SST 49LF004A/B /3.3V

File Name to Program: 1001.bin
Now Backup System BIOS to
File!
_____
_____

Message: Please Wait!
```

4.1.4 ASUS CrashFree BIOS 2 utility

The ASUS CrashFree BIOS 2 is an auto recovery tool that allows you to restore the BIOS file when it fails or gets corrupted during the updating process. You can update a corrupted BIOS file using the motherboard support CD or the floppy disk that contains the updated BIOS file.



Prepare the motherboard support CD or the floppy disk containing the updated motherboard BIOS before using this utility.

Recovering the BIOS from the support CD

To recover the BIOS from the support CD:

1. Turn on the system.
2. Insert the motherboard support CD to the optical drive.
3. The utility displays the following message and automatically checks the CD for the BIOS file.

```
Award BootBlock BIOS v1.0
Copyright (c) 2000, Award Software, Inc.

BIOS ROM checksum error
Detecting IDE ATAPI device...
```

When found, the utility reads the BIOS file and starts flashing the corrupted BIOS file.

```
Award BootBlock BIOS v1.0
Copyright (c) 2000, Award Software, Inc.

BIOS ROM checksum error
Detecting IDE ATAPI device...
Found CDRom, try to Boot from it... Pass
```



DO NOT shut down or reset the system while updating the BIOS! Doing so can cause system boot failure!

4. Restart the system after the utility completes the updating process.

Recovering the BIOS from a floppy disk

To recover the BIOS from the support CD:

1. Remove any CD from the optical drive, then turn on the system.
2. Insert the floppy disk with the original or updated BIOS file to the floppy disk drive.
3. The utility displays the following message and automatically checks the floppy disk for the original or updated BIOS file.

```
Award BootBlock BIOS v1.0
Copyright (c) 2000, Award Software, Inc.

BIOS ROM checksum error
Detecting IDE ATAPI device...
```

When no CD is found, the utility automatically checks the optical drive for the original or updated BIOS file. The utility then updates the corrupted BIOS file.

```
Award BootBlock BIOS v1.0
Copyright (c) 2000, Award Software, Inc.

BIOS ROM checksum error
Detecting IDE ATAPI device...
  Found CDROM, try to Boot from it... Fail

Detecting floppy drive A media...
```



DO NOT shut down or reset the system while updating the BIOS! Doing so can cause system boot failure!

4. Restart the system after the utility completes the updating process.



The recovered BIOS may not be the latest BIOS version for this motherboard. Visit the ASUS website (www.asus.com) to download the latest BIOS file.

4.1.5 ASUS EZ Flash utility

The ASUS EZ Flash feature allows you to update the BIOS without having to go through the long process of booting from a floppy disk and using a DOS-based utility. The EZ Flash utility is built-in the BIOS chip so it is accessible by pressing <Alt> + <F2> during the Power-On Self Tests (POST).

To update the BIOS using EZ Flash:

1. Visit the ASUS website (www.asus.com) to download the latest BIOS file for the motherboard.
2. Save the BIOS file to a floppy disk, then restart the system.
3. Press <Alt> + <F2> during POST to display the following.

```
Insert Disk then press Enter or ESC to continue POST
```

4. Insert the floppy disk that contains the BIOS file to the floppy disk drive then press <Enter>. The following screen appears.

```
AwardBIOS Flash Utility for ASUS V1.01
(C) Phoenix Technologies Ltd. All Rights Reserved

For NF-KC804-K8N-DL-00      DATE: 02/01/2005
Flash Type - SST 49LF004A/B /3.3V

File Name to Program: 

Message: Please wait...
```

5. When the correct BIOS file is found, EZ Flash performs the BIOS update process and automatically reboots the system when done.



Do not shutdown or reset the system while updating the BIOS to prevent system boot failure!

4.1.6 ASUS Update utility

The ASUS Update is a utility that allows you to manage, save, and update the motherboard BIOS in Windows® environment. The ASUS Update utility allows you to:

- Save the current BIOS file
- Download the latest BIOS file from the Internet
- Update the BIOS from an updated BIOS file
- Update the BIOS directly from the Internet, and
- View the BIOS version information.

This utility is available in the support CD that comes with the motherboard package.



ASUS Update requires an Internet connection either through a network or an Internet Service Provider (ISP).

Installing ASUS Update

To install ASUS Update:

1. Place the support CD in the optical drive. The **Drivers** menu appears.
2. Click the **Utilities** tab, then click **Install ASUS Update VX.XX.XX**. See page 5-3 for the **Utilities** screen menu.
3. The ASUS Update utility is copied to your system.



Quit all Windows® applications before you update the BIOS using this utility.

Updating the BIOS through the Internet

To update the BIOS through the Internet:

1. Launch the ASUS Update utility from the Windows® desktop by clicking **Start > Programs > ASUS > ASUSUpdate > ASUSUpdate**. The ASUS Update main window appears.

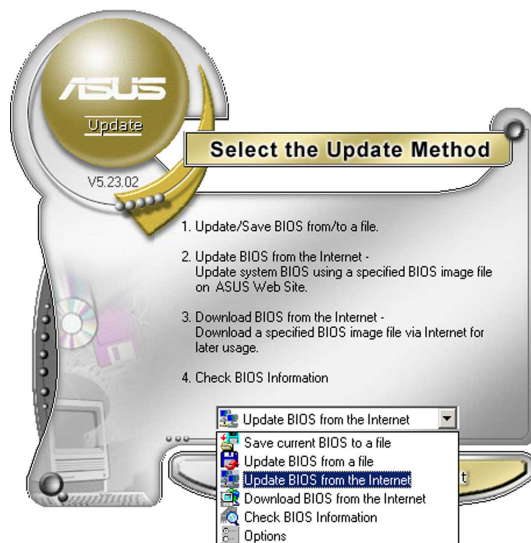
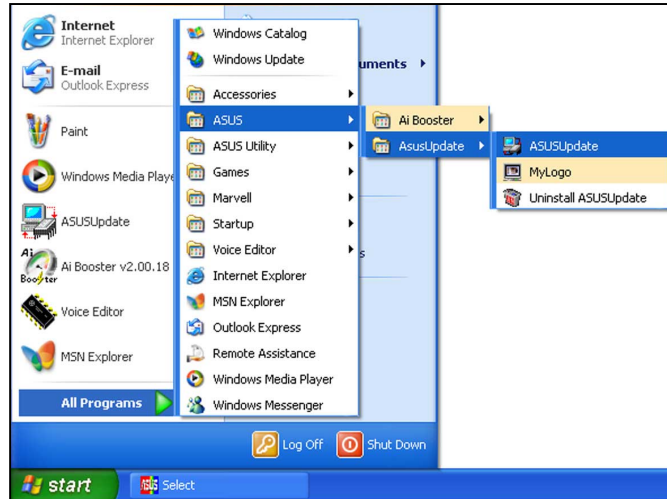

2. Select **Update BIOS from the Internet** option from the drop-down menu, then click **Next**.



3. Select the ASUS FTP site nearest you to avoid network traffic, or click **Auto Select**. Click **Next**.

- From the FTP site, select the BIOS version that you wish to download. Click Next.
- Follow the screen instructions to complete the update process.



The ASUS Update utility is capable of updating itself through the Internet. Always update the utility to avail all its features.

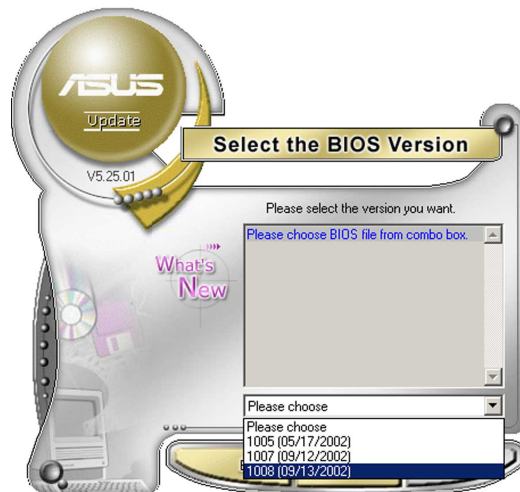

Updating the BIOS through a BIOS file

To update the BIOS through a BIOS file:

- Launch the ASUS Update utility from the Windows® desktop by clicking **Start > Programs > ASUS > ASUSUpdate > ASUSUpdate**. The ASUS Update main window appears.
- Select **Update BIOS from a file** option from the drop-down menu, then click **Next**.

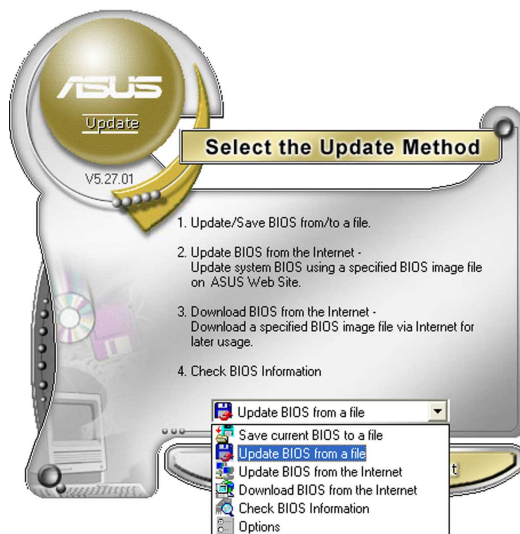

- Locate the BIOS file from the **Open** window, then click **Save**.
- Follow the screen instructions to complete the update process.

4.2 BIOS setup program

This motherboard supports a programmable Low-Pin Count (LPC) chip that you can update using the provided utility described in section “4.1 Managing and updating your BIOS.”

Use the BIOS Setup program when you are installing a motherboard, reconfiguring your system, or prompted to “Run Setup”. This section explains how to configure your system using this utility.

Even if you are not prompted to use the Setup program, you can change the configuration of your computer in the future. For example, you can enable the security password feature or change the power management settings. This requires you to reconfigure your system using the BIOS Setup program so that the computer can recognize these changes and record them in the CMOS RAM of the LPC chip.

The LPC chip on the motherboard stores the Setup utility. When you start up the computer, the system provides you with the opportunity to run this program. Press during the Power-On Self-Test (POST) to enter the Setup utility; otherwise, POST continues with its test routines.

If you wish to enter Setup after POST, restart the system by pressing <Ctrl+Alt+Delete>, or by pressing the reset button on the system chassis. You can also restart by turning the system off and then back on. Do this last option only if the first two failed.

The Setup program is designed to make it as easy to use as possible. Being a menu-driven program, it lets you scroll through the various sub-menus and make your selections from the available options using the navigation keys.



-
- The default BIOS settings for this motherboard apply for most conditions to ensure optimum performance. If the system becomes unstable after changing any BIOS settings, load the default settings to ensure system compatibility and stability. Select the **Load Default Settings** item under the Exit Menu. See section “4.7 Exit Menu.”
-
- The BIOS setup screens shown in this section are for reference purposes only, and may not exactly match what you see on your screen.
-
- Visit the ASUS website (www.asus.com) to download the latest BIOS file for this motherboard.
-

4.2.1 BIOS menu screen

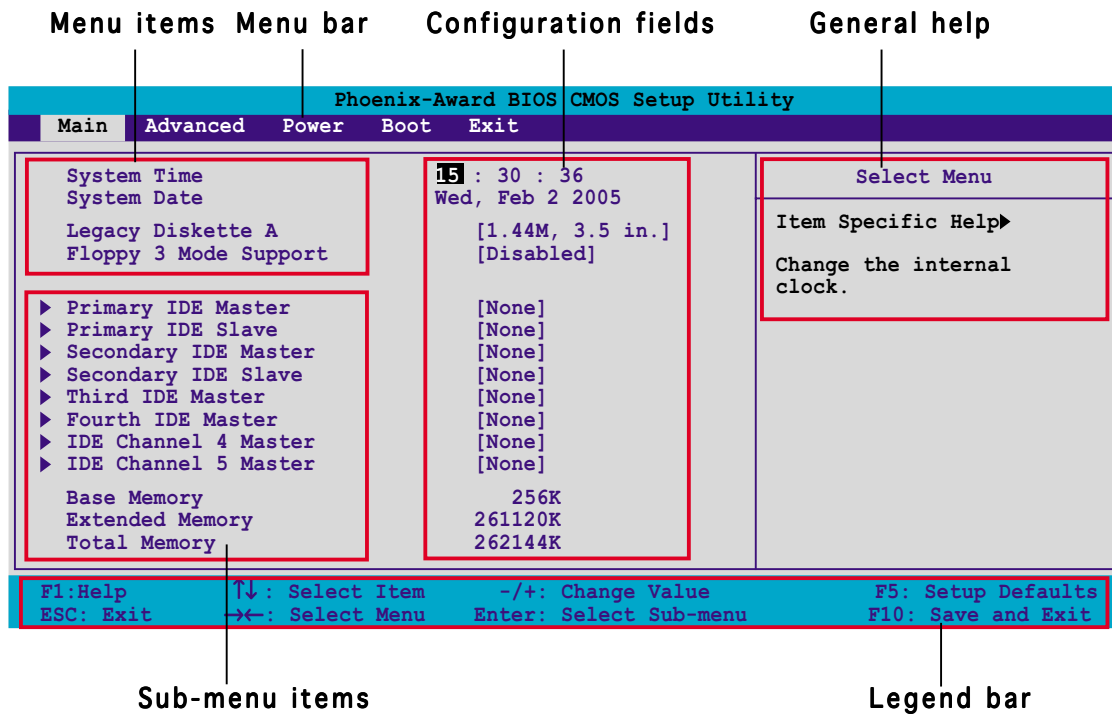

4.2.2 Menu bar

The menu bar on top of the screen has the following main items:

- Main** For changing the basic system configuration
- Advanced** For changing the advanced system settings
- Power** For changing the advanced power management (APM) configuration
- Boot** For changing the system boot configuration
- Exit** For selecting the exit options and loading default settings

To select an item on the menu bar, press the right or left arrow key on the keyboard until the desired item is highlighted.

4.2.3 Legend bar

At the bottom of the Setup screen is a legend bar. The keys in the legend bar allow you to navigate through the various setup menus. The following table lists the keys found in the legend bar with their corresponding functions.

Navigation Key	Function
<F1>	Displays the General Help screen
<F5>	Loads setup default values
<Esc>	Exits the BIOS setup or returns to the main menu from a sub-menu
Left or Right arrow	Selects the menu item to the left or right
Up or Down arrow	Moves the highlight up or down between fields
Page Down or - (minus)	Scrolls backward through the values for the highlighted field
Page Up or + (plus)	Scrolls forward through the values for the highlighted field
<Enter>	Brings up a selection menu for the highlighted field
<F10>	Saves changes and exit

4.2.4 Menu items

The highlighted item on the menu bar displays the specific items for that menu. For example, selecting **Main** shows the Main menu items.

The other items (Advanced, Power, Boot, and Exit) on the menu bar have their respective menu items.

4.2.5 Sub-menu items

A solid triangle before each item on any menu screen means that the item has a sub-menu. To display the sub-menu, select the item and press <Enter>.

4.2.6 Configuration fields

These fields show the values for the menu items. If an item is user-configurable, you can change the value of the field opposite the item. You cannot select an item that is not user-configurable.

A configurable field is enclosed in brackets, and is highlighted when selected. To change the value of a field, select it then press <Enter> to display a list of options. Refer to “4.2.7 Pop-up window.”

4.2.7 Pop-up window

Select a menu item then press <Enter> to display a pop-up window with the configuration options for that item.

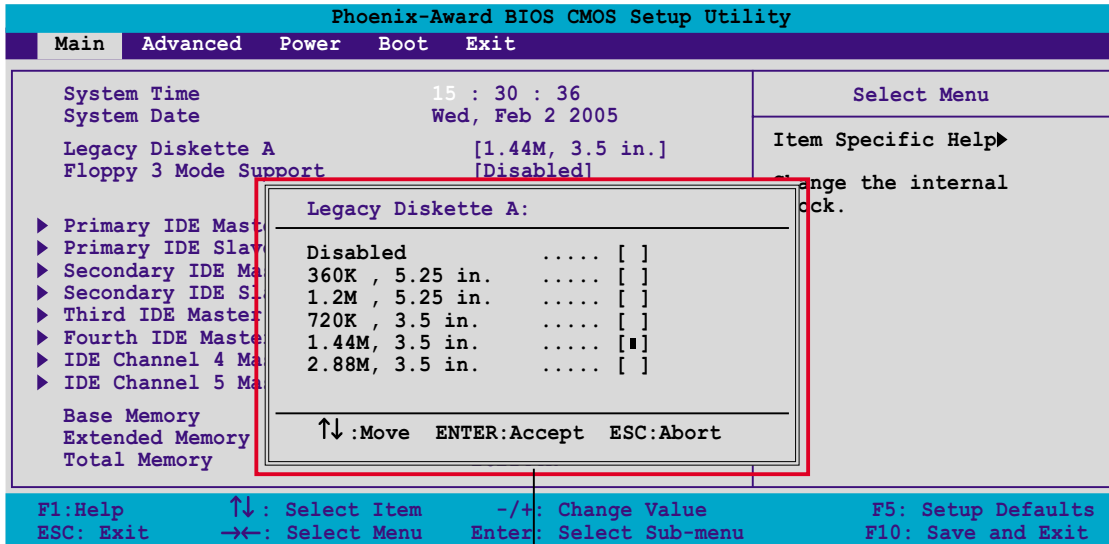

Pop-up menu

4.2.8 General help

At the top right corner of the menu screen is a brief description of the selected item.

4.3 Main menu

When you enter the BIOS Setup program, the Main menu screen appears, giving you an overview of the basic system information.



Refer to section “4.2.1 BIOS menu screen” for information on the menu screen items and how to navigate through them.

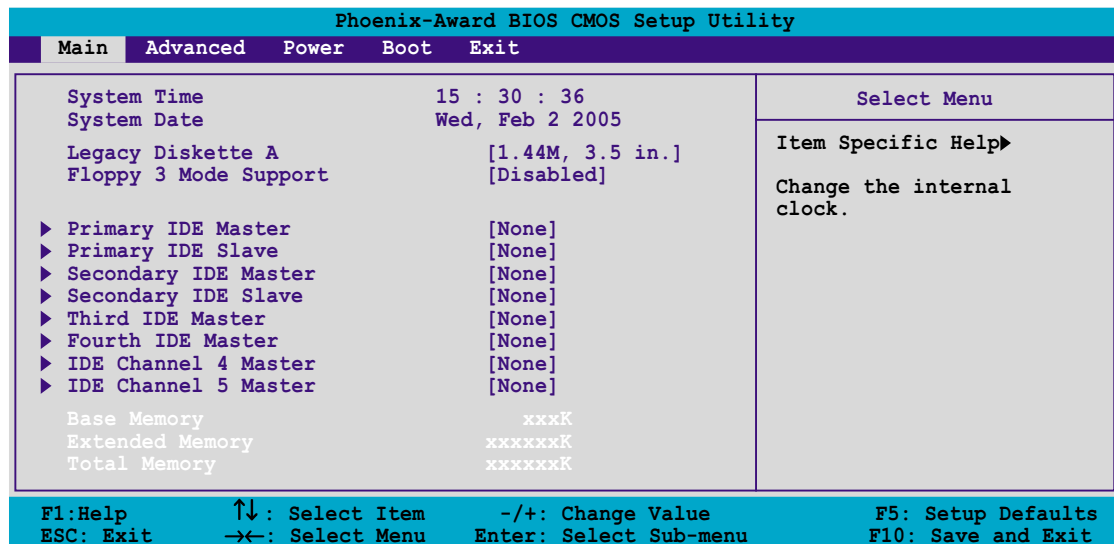

4.3.1 System Time [xx:xx:xxxx]

Allows you to set the system time.

4.3.2 System Date [Day xx/xx/xxxx]

Allows you to set the system date.

4.3.3 Legacy Diskette A [1.44M, 3.5 in.]

Sets the type of floppy drive installed. Configuration options: [Disabled] [360K, 5.25 in.] [1.2M , 5.25 in.] [720K , 3.5 in.] [1.44M, 3.5 in.] [2.88M, 3.5 in.]

4.3.4 Floppy 3 Mode Support [Disabled]

This feature allows reading and writing of 1.2 MB (as opposed to 1.44 MB) data on a 3.5-inch floppy disk. This is required to support Japanese standard floppy drives. Configuration options: [Disabled] [Drive A]

4.3.5 Base/Extended/Total Memory [xxxxxxK]

The base memory, extended memory, and the total memory values are auto-detected. These fields are not user-configurable.



While entering Setup, the BIOS automatically detects the presence of IDE devices. There is a separate sub-menu for each IDE device. Select a device item then press <Enter> to display the IDE device information.

4.3.6 Primary IDE Master

Phoenix-Award BIOS CMOS Setup Utility	
Main	
Primary IDE Master	Select Menu
PIO Mode [Auto]	Item Specific Help▶▶ Set a PIO mode for the IDE device. Mode0 through 4 successive increase in performance.
UDMA Mode [Auto]	
Primary IDE Master [Auto]	
Access Mode [Auto]	
Capacity 0 MB	
Cylinder 0	
Head 0	
Precomp 0	
Landing Zone 0	
Sector 0	
Transfer Mode None	
S.M.A.R.T Status None	
F1: Help ↑↓: Select Item -/+ : Change Value F5: Setup Defaults	
ESC: Exit →←: Select Menu Enter: Select Sub-menu F10: Save and Exit	

The BIOS automatically detects the values opposite the dimmed items (Capacity, Cylinder, Head, Precomp, Landing Zone, Sector, and Transfer Mode, and S.M.A.R.T Status). These values are not user-configurable. These items show “0” or “None” if no IDE device is installed in the system.

PIO Mode

Sets the PIO mode for the IDE device. The settings Mode 0 to 4 allow successive increase in performance. Configuration options: [Auto] [Mode 0] [Mode 1] [Mode 2] [Mode 3] [Mode 4]

UDMA Mode

When this item is set to [Auto], the UDMA capability allows improved transfer speeds and data integrity for supported IDE devices. Configuration options: [Disabled] [Auto]

Primary IDE Master [Auto]

Select [Auto] to automatically detect an IDE hard disk drive. If automatic detection is successful, the BIOS automatically fills in the correct values for the remaining fields on this sub-menu. If the hard disk was already formatted on a previous system, the BIOS may detect incorrect parameters. Select [Manual] to manually enter the IDE hard disk drive parameters. Refer to the next section “Manually detecting an IDE drive.” If no drive is installed select [None]. Configuration options: [None] [Auto] [Manual]

Access Mode [Auto]

Allows selection of the sector addressing mode. The default [Auto] allows automatic detection of an IDE hard disk drive. Select [CHS] for this item if you set the Primary IDE Master to [Manual] to manually enter the drive information. Configuration options: [CHS] [LBA] [Large] [Auto]

Manually detecting an IDE drive

To manually enter the drive information, set the Primary IDE Master item to [Manual], and the Access Mode item to [CHS].

Phoenix-Award BIOS CMOS Setup Utility	
Main	
Primary IDE Master	Select Menu
PIO Mode [Auto]	Item Specific Help▶▶
UDMA Mode [Auto]	
Primary IDE Master [Manual]	Set a PIO mode for the IDE device. Mode0 through 4 successive increase in performance.
Access Mode [CHS]	
Capacity 0 MB	
Cylinder 0	
Head 0	
Precomp 0	
Landing Zone 0	
Sector 0	
Transfer Mode None	
S.M.A.R.T Status None	
F1: Help ↑↓: Select Item -/+ : Change Value F5: Setup Defaults	ESC: Exit →←: Select Menu Enter: Select Sub-menu F10: Save and Exit



Before attempting to configure a hard disk drive, make sure you have the correct configuration information supplied by the drive manufacturer. Incorrect settings may cause the system to fail to recognize the installed hard disk.

To enter the number of cylinder, head, precomp, landing zone, sector per track for the drive, highlight an item, key-in the value that you obtained from the drive label or documentation, then press <Enter>.

To enter a value, you may also highlight the item, then press <Enter> to display a pop-up menu. Type in the value indicated in the drive label or documentation, the press <Enter>.

Capacity

Displays the auto-detected hard disk capacity.

Cylinder

Shows the number of the hard disk cylinders.

Head

Shows the number of the hard disk read/write heads.

Precomp

Displays the precompressed volumes on the hard disk, if any.

Landing Zone

Displays the drive's maximum usable capacity as calculated by the BIOS based on the drive information that you entered.

Sector

Shows the number of sectors per track.

Transfer Mode

Shows the data transfer mode if the hard disk supports this feature. Otherwise, this item is grayed out and shows the value [None].

S.M.A.R.T Status

Shows the Smart Monitoring, Analysis, and Reporting Technology (S.M.A.R.T) status if the hard disk supports this feature. Otherwise, this item is grayed out and show the value [None].



After entering the IDE hard disk drive information, use a disk utility, such as FDISK, to partition and format new IDE hard disk drives. This is necessary so that you can write or read data from the hard disk. Make sure to set the partition of the Primary IDE hard disk drives to "Active."

4.3.7 Primary IDE Slave

When configuring a drive as Primary IDE Slave, refer to section "4.3.6 Primary IDE Master" for the menu item descriptions.

4.3.8 Secondary IDE Master

When configuring a drive as Secondary IDE Master, refer to section "4.3.6 Primary IDE Master" for the menu item descriptions.

4.3.9 Secondary IDE Slave

When configuring a drive as Secondary IDE Slave, refer to section "4.3.6 Primary IDE Master" for the menu item descriptions.

4.3.10 Third IDE Master

When configuring a drive as Primary IDE Slave, refer to section “4.3.6 Primary IDE Master” for the menu item descriptions which are not discussed in this section.

Phoenix-Award BIOS CMOS Setup Utility			
Main			
Primary IDE Master		Select Menu	
Extended IDE Drive	[Auto]	Item Specific Help▶▶ Set a PIO mode for the IDE device. Mode0 through 4 successive increase in performance.	
Access Mode	[Auto]		
Capacity	0 MB		
Cylinder	0		
Head	0		
Precomp	0		
Landing Zone	0		
Sector	0		
Transfer Mode	None		
S.M.A.R.T Status	None		
F1: Help	↑↓: Select Item	-/+ : Change Value	F5: Setup Defaults
ESC: Exit	→←: Select Menu	Enter: Select Sub-menu	F10: Save and Exit

Extended IDE Drive

When set to [Auto], allows automatic selection of the extended IDE drive installed, if any. Set this item to [None] if there is no extended IDE drive, or if you do not wish to detect the drive even if installed. Configuration options: [None] [Auto]

Access Mode [Auto]

Allows selection of the sector addressing mode. Configuration options: [Large] [Auto]

4.3.11 Fourth IDE Master

When configuring a drive as Fourth IDE Master, refer to section “4.3.6 Primary IDE Master” and section “4.3.10 Third IDE Master” for the menu item descriptions.

4.3.12 IDE Channel 4 Master

When configuring a drive as IDE Channel 4 Master, refer to section “4.3.6 Primary IDE Master” and section “4.3.10 Third IDE Master” for the menu item descriptions.

4.3.13 IDE Channel 5 Master

When configuring a drive as IDE Channel 5 Master, refer to section “4.3.6 Primary IDE Master” and section “4.3.10 Third IDE Master” for the menu item descriptions.

4.4 Advanced menu

The Advanced menu items allow you to change the settings for the CPU and other system devices.



Take caution when changing the settings of the Advanced menu items. Incorrect field values can cause the system to malfunction.

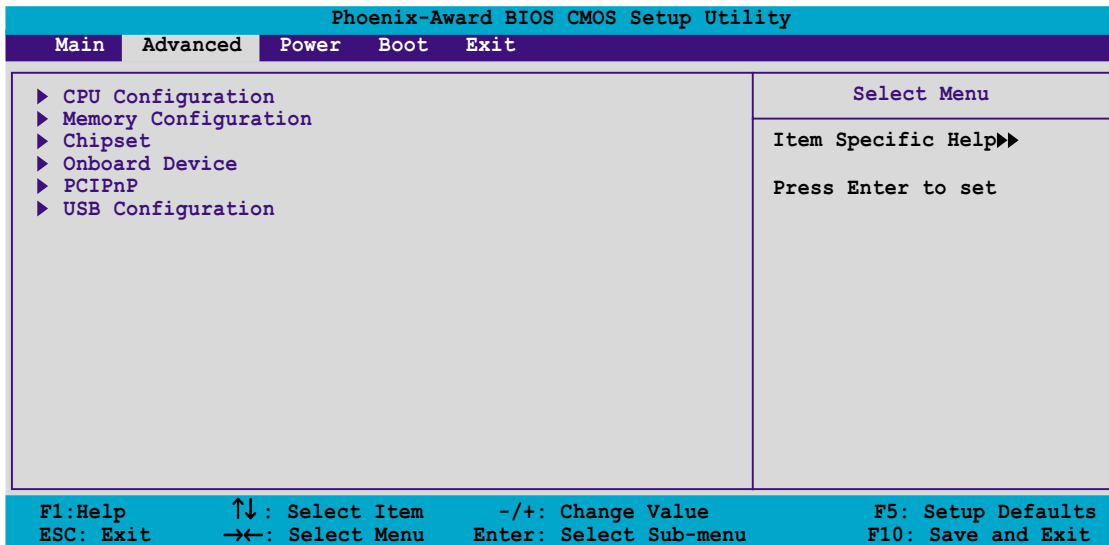

4.4.1 CPU Configuration

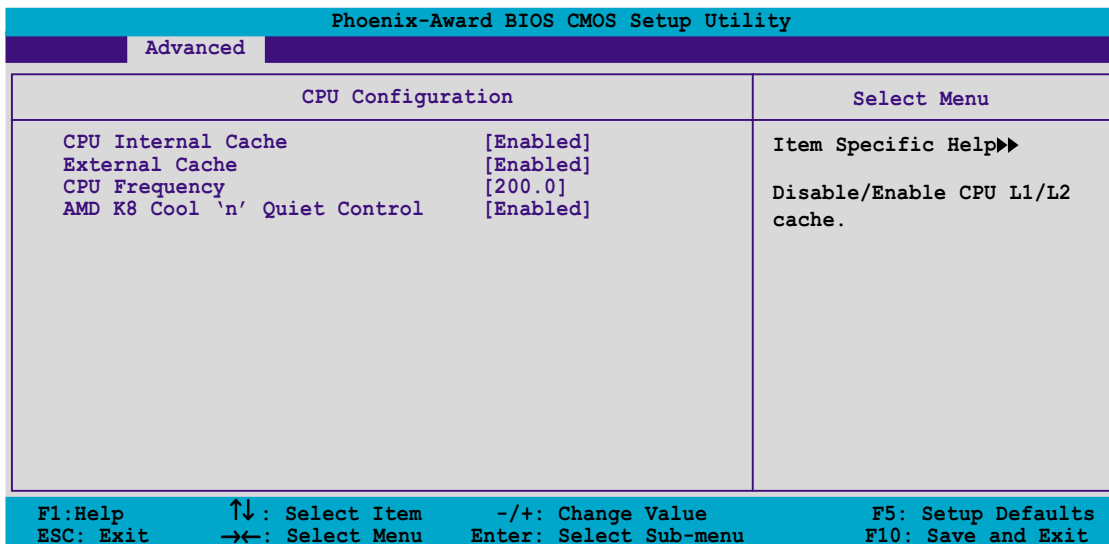

CPU Internal Cache [Enabled]

Disables or enables the CPU L1/L2 cache.
Configuration options: [Disabled] [Enabled]

External Cache [Enabled]

Disables or enables the CPU L3 cache.
Configuration options: [Disabled] [Enabled]

CPU Frequency [200.0]

Allows you to select the CPU frequency.

Configuration options: [200.0] [201.0] [202.0] ... [400.0]

AMD K8 Cool 'n' Quiet Control [Enabled]

Disables or enables the AMD K8 Cool 'n' Quiet feature.

Configuration options: [Disabled] [Enabled]

4.4.2 Memory Configuration

This menu shows the memory configuration settings. Select an item then press <Enter> to display a pop-up menu with the configuration options.

Phoenix - Award BIOS CMOS Setup Utility		
Advanced		
Memory Configuration	Select Menu	
Timing Mode	[Auto]	Item Specific Help▶▶ <Enter> to select DRAM configuration by [Auto] (recommended). [Manual] allows you to set each configuration on your own.
Memclock Index Value (Mhz)	[200Mhz]	
CAS# Latency (Tcl)	[2.5]	
Min RAS# Active Time (Tras)	[8T]	
RAS# to CAS# Delay (Trcd)	[4T]	
Row Precharge Time (Trp)	[2T]	
Node Memory Interleaving	[Disabled]	
S/W Memory Hole Remapping	[Enabled]	
MTRR Mapping Mode	[Continuous]	
Master ECC Enabled	[Enabled]	
ECC Memory Interlock	[At Least One]	
ECC MCE Enable	[Disabled]	
Chip-Kill Mode Enable	[Disabled]	
ECC Redirection	[Disabled]	
DRAM Background Scrubber	[Disabled]	
L2 Cache Background Scrubber	[Disabled]	
DCache Background Scrubber	[Disabled]	
F1:Help ↑↓:Select Item -/+ : Change Value F5:Setup Defaults		
ESC:Exit ⇐⇒:Select Menu Enter: Select SubMenu F10:Save and Exit		

Timing Mode [Auto]

When set to [Auto], BIOS detects the DRAM configurations automatically. Setting to [Manual] allows you to set the DRAM timing configurations from the available options. Configuration options: [Auto] [Manual]



The items **Memclock Index Value**, **CAS# latency**, **Min RAS# Active Time**, **RAS# to CAS# Delay**, and **Row Precharge Time** become configurable only when the Timing Mode item is set to [Manual].

Memclock Index Value (Mhz) [200MHz]

Allows selection of the DRAM frequency. Configuration options: [100Mhz] [133Mhz] [166Mhz] [200Mhz]

CAS# Latency (Tcl) [2.5]

Sets the latency (in clocks) between the DRAM read command and the time the data actually becomes available.

Configuration options: [2] [2.5] [3]

Min RAS# Active Time (Tras) [8T]

Controls the number of DRAM clocks used for DRAM parameters.

Configuration options: [5T] [6T] [7T] [8T] [9T] [10T] [11T] [12T] [13T] [14T] [15T]

RAS# to CAS# Delay (Trcd) [4T]

Controls the latency between the DRAM active command and the read/write command. Configuration options: [2T] [3T] [4T] [5T] [6T] [7T]

Row Precharge Time (Trp) [2T]

Controls the idle clocks after issuing a precharge command to the DRAM.

Configuration options: [2T] [3T] [4T] [5T] [6T] [7T]

Node Memory Interleaving [Disabled]

Enables or disables memory interleaving. Configuration options: [Disabled] [Enabled]

S/W Memory Hole Remapping [Enabled]

Allows memory hoisting/remapping of the memory-mapped I/O address hole to above 4GB system memory. Configuration options: [Disabled] [Enabled]

MTRR Mapping Mode [Continuous]

Allows selection of [Continuous] for standard mode, or [Discreet] for aggressive mode. Configuration options: [Continuous] [Discreet]

Master ECC Enable [Enabled]

Enables or disables ECC check/correct mode. Configuration options: [Disabled] [Enabled]

ECC Memory Interlock [At Least One]

Allows selection for DIMMs that are ECC-compliant. Configuration options: [At Least One] [All are]

ECC MCE Enable [Disabled]

When set to [Enabled], a machine-check exception (#MC) occurs whenever an machine-check error that may not be corrected is encountered.

Configuration options: [Disabled] [Enabled]

Chip-Kill Mode Enable [Disabled]

When set to [Enabled], allows ECC checking to be based on a 128/16 data/ECC rather than on a 64/8 data/ECC. You may only enable this feature in 128-bit DRAM data width mode. Configuration options: [Disabled] [Enabled]

ECC Redirection [Disabled]

When set to [Enabled], correctable errors are corrected as the data is passed to the requestor. The data in the DRAM is not corrected if this item is set to [Disabled]. Configuration options: [Disabled] [Enabled]

DRAM Background Scrubber [Disabled]

Specifies the scrub rate of the next address to be scrubbed by the DRAM scrubber. Configuration options: [Disabled] [40.0ns]

L2 Cache Background Scrubber [Disabled]

Specifies the scrub rate of the next address to be scrubbed by the L2 cache scrubber. Configuration options: [Disabled] [40.0ns]

DCache Background Scrubber [Disabled]

Specifies the scrub rate of the next address to be scrubbed by the data cache scrubber. Configuration options: [Disabled] [40.0ns]

4.4.3 Chipset

This menu shows the chipset configuration settings. Select an item then press <Enter> to display a pop-up menu with the configuration options.

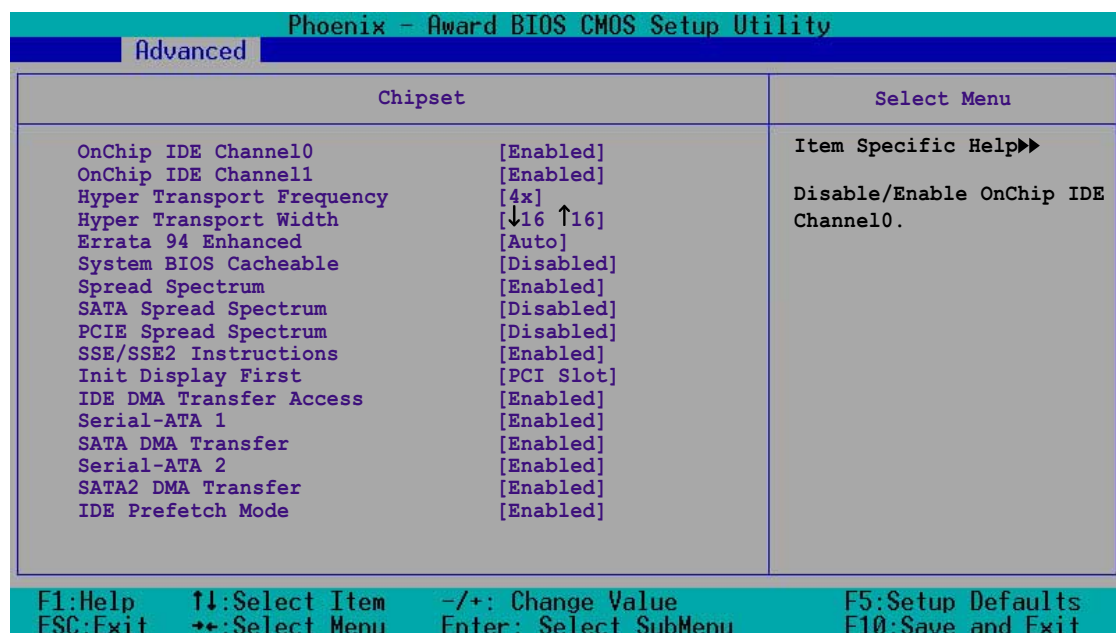

OnChip IDE Channel0 [Enabled]

Enables or disables the on-chip IDE channel 0. Configuration options: [Disabled] [Enabled]

OnChip IDE Channel1 [Enabled]

Enables or disables the on-chip IDE channel 1. Configuration options: [Disabled] [Enabled]

Hyper Transport Frequency [4x]

Allows selection of hyper transport frequency. Configuration options: [1x] [2x] [3x] [4x] [5x]

Hyper Transport Width [↓16 ↑16]

Allows selection of hyper transport frequency. Configuration options: [↓8 ↑8][↓16 ↑8] [↓8 ↑16] [↓16 ↑16]

Errata 94 Enhanced [Auto]

Configuration options: [Auto] [Disabled]

System BIOS Cacheable [Disabled]

Enables or disables the cache function of the system BIOS. Configuration options: [Disabled] [Enabled]

Spread Spectrum [Enabled]

Enables or disables the CPU spread spectrum. Configuration options: [Disabled] [Enabled]

SATA Spread Spectrum [Disabled]

Enables or disables SATA spread spectrum. Configuration options: [Disabled] [Enabled]

PCIe Spread Spectrum [Disabled]

Enables or disables PCIe spread spectrum. Configuration options: [Disabled] [Enabled]

SSE/SSE2 Instructions [Enabled]

Enables or disables the SSE instructions. Configuration options: [Disabled] [Enabled]

Init Display First [PCI Slot]

Allows you to select the graphics controller to use as primary boot device.
Configuration options: [PCI Slot] [PCIEx]

IDE DMA Transfer Access [Enabled]

Enables or disables the switch to support IDE DMA transfer.
Configuration options: [Disabled] [Enabled]

Serial-ATA 1 [Enabled]

Enables or disables the on-chip SATA1 (ports 1 and 2). Configuration options: [Disabled] [Enabled]

SATA DMA Transfer [Enabled]

Enables or disables the switch to support SATA DMA transfer.
Configuration options: [Disabled] [Enabled]

Serial-ATA 2 [Enabled]

Enables or disables the on-chip SATA2 (ports 3 and 4). Configuration options: [Disabled] [Enabled]

SATA2 DMA Transfer [Enabled]

Enables or disables the switch to support SATA2 DMA transfer.
Configuration options: [Disabled] [Enabled]

IDE Prefetch Mode [Enabled]

Enables or disables the IDE Prefetch mode. Configuration options: [Disabled] [Enabled]

4.4.4 Onboard Device

This menu shows the onboard device configuration settings. Select an item then press <Enter> to display a pop-up menu with the configuration options, or a sub-menu with additional items.

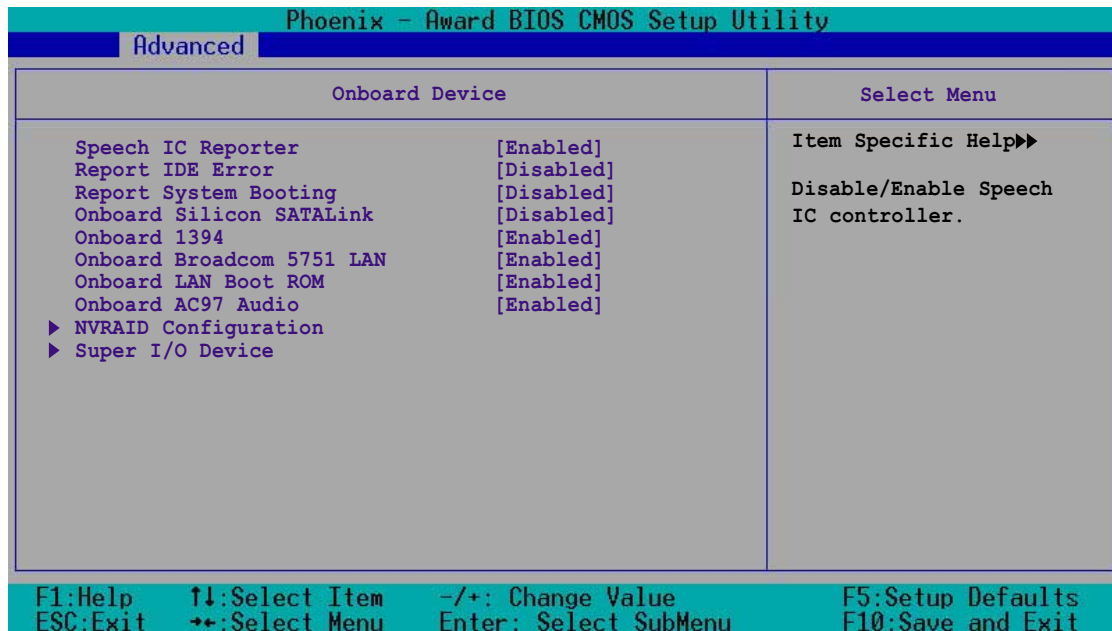

Speech IC Reporter [Enabled]

Enables or disables the speech IC controller. Configuration options:
[Disabled] [Enabled]

Report IDE Error [Disabled]

Enables or disables the speech IC IDE error report. Configuration options:
[Disabled] [Enabled]

Report System Booting [Disabled]

Enables or disables the speech IC system error report. Configuration options: [Disabled] [Enabled]

Onboard Silicon SATALink [Enabled]

Enables or disables the onboard Silicon Image SATALink device. Configuration options: [Disabled] [Enabled]

Onboard 1394 [Enabled]

Enables or disables the onboard 1394 controller. Configuration options:
[Disabled] [Enabled]

Onboard Broadcom 5751 LAN [Enabled]

Enables or disables the onboard LAN controller. Configuration options: [Disabled] [Enabled]

Onboard AC97 Audio [Enabled]

Enables or disables the onboard AC97 audio controller. Configuration options: [Disabled] [Enabled]

NVRAID Configuration

This sub-menu contains RAID-related function items. Select the items that you wish to enable to create a RAID set.

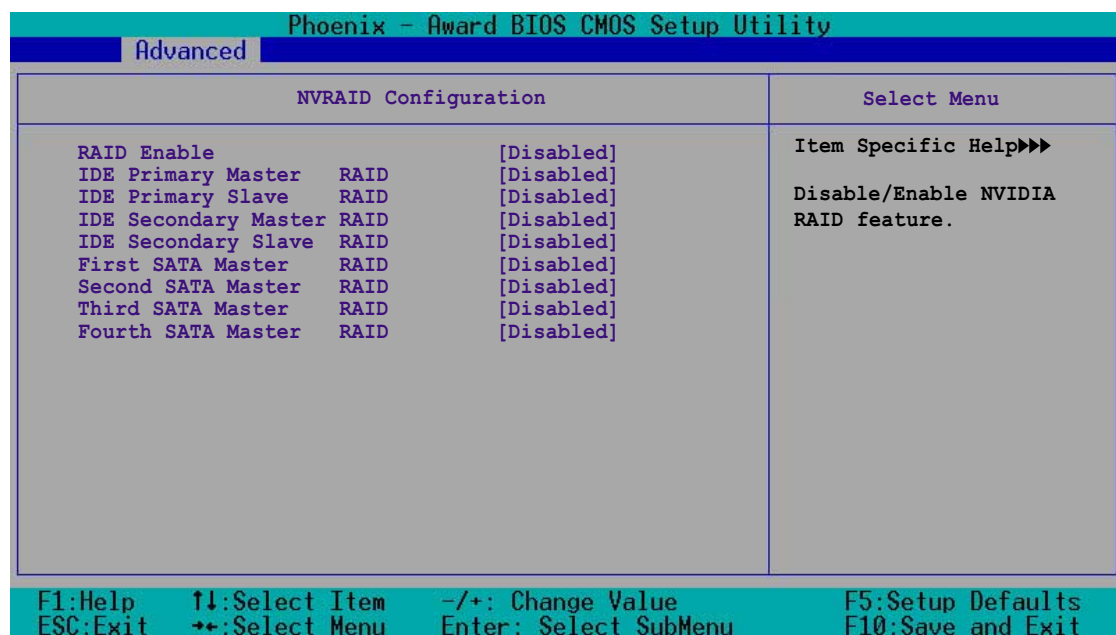

RAID Enable [Disabled]

Enables or disables the NVIDIA RAID feature. Configuration options: [Disabled] [Enabled]

IDE Primary Master/Slave, IDE Secondary Master/Slave RAID [Disabled]

When enabled, allows you to use the device/s for creating a RAID set. Configuration options: [Disabled] [Enabled]

First/Second/Third/Fourth SATA Master RAID [Disabled]

When enabled, allows you to use the device/s for creating a RAID set. Configuration options: [Disabled] [Enabled]

Super I/O Device

This sub-menu contains RAID-related function items. Select the items that you wish to enable to create a RAID set.

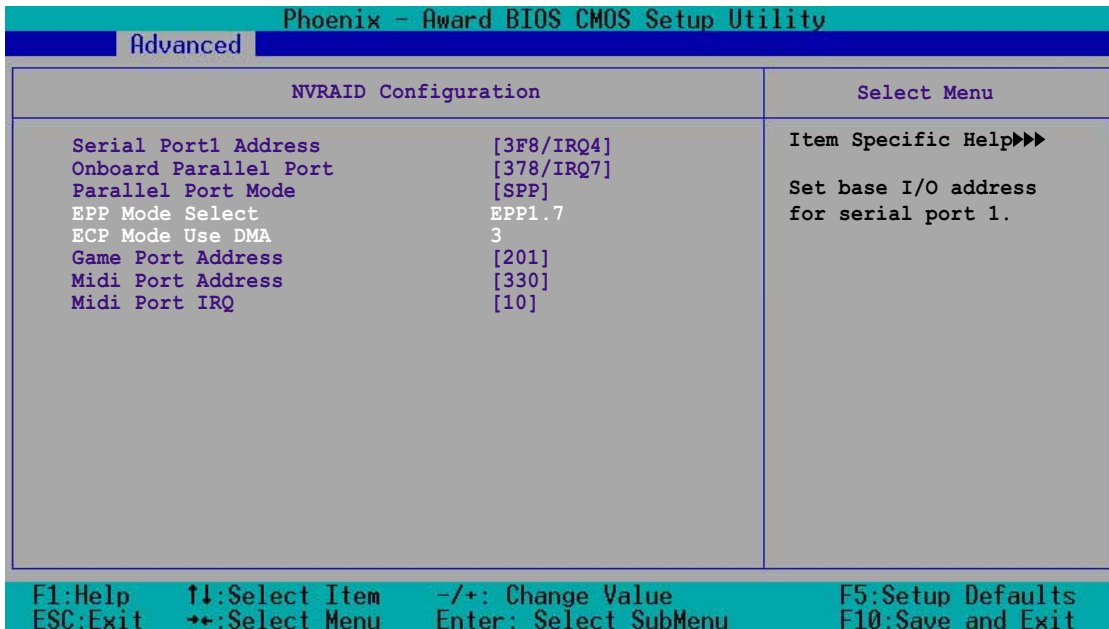

Serial Port1 Address [3F8/IRQ4]

Allows you to select the serial port 1 base address.

Configuration options: [Disabled] [3F8/IRQ4] [2F8/IRQ3] [3E8/IRQ4] [2E8/IRQ3] [Auto]

Onboard Parallel Port [378/IRQ7]

Allows you to select the parallel port base address.

Configuration options: [Disabled] [378/IRQ7] [278/IRQ5] [3BC/IRQ7]

Parallel Port Mode [SPP]

Allows you to select the parallel port mode.

Configuration options: [SPP] [EPP] [ECP] [ECP+EPP] [Normal]

EPP Mode Select [EPP1.7]

Allows you to select the version of EPP mode. This item becomes configurable only if the **Parallel Port Mode** is set to [ECP] or [ECP+EPP]. Configuration options: [EPP1.9] [EPP1.7]

ECP Mode Use DMA [3]

Allows you to configure the parallel port DMA channel for the selected ECP mode. This item becomes configurable only if the **Parallel Port Mode** is set to [ECP] or [ECP+EPP]. Configuration options: [1] [3]

Game Port Address [201]

Allows you to select the game port address.
Configuration options: [Disabled] [201] [209]

Midi Port Address [330]

Allows you to select the MIDI port address.
Configuration options: [Disabled] [330] [300] [290]

Midi Port IRQ [10]

Allows you to select the MIDI port IRQ. Configuration options: [5] [10]

4.4.5 PCIPnP

This menu shows the PCIPnP configuration settings. Select an item then press <Enter> to display a pop-up menu with the configuration options.

Phoenix - Award BIOS CMOS Setup Utility	
Advanced	
Memory Configuration	Select Menu
Resources Controlled By [Auto] IRQ Resources	Item Specific Help▶▶
PCI/VGA Pallete Snoop [Disabled]	BIOS can automatically configure all the boot and Plug and Play compatible devices. If you choose Auto, you cannot select IRQ DMA and memory base address fields, since BIOS automatically assigns them.
** PCI Express relative items ** Maximum Payload Size [4096]	

F1:Help ↑↓:Select Item -/+ : Change Value F5:Setup Defaults
ESC:Exit →+:Select Menu Enter: Select SubMenu F10:Save and Exit

Resources Controlled By [Auto]

Allows automatic or manual assignments of IRQ resources to boot devices and Plug and Play devices. Configuration options: [Auto] [Manual]



When the item **Resources Controlled By** is set to [Auto], the item **IRQ Resources** is grayed out and not user-configurable. Refer to the section “IRQ Resources” for information on how to enable this item.

PCI/VGA Pallet Snoop [Disabled]

Some non-standard VGA cards, like graphics accelerators or MPEG video cards, may not show colors properly. Setting this field to [Enabled] corrects this problem. If you are using a standard VGA card, leave this field to the default setting [Disabled]. Configuration options: [Disabled] [Enabled]

Maximum Payload Size [4096]

Sets the maximum TLP payload size (in bytes) for PCI Express devices. Configuration options: [128] [256] [512] [1024] [2048] [4096]

IRQ Resources



Set the item **Resources Controlled By** to [Manual] to enable the item **IRQ Resources** and assign the interrupts depending on the type of installed PCI devices.

Phoenix - Award BIOS CMOS Setup Utility	
Advanced	
Memory Configuration	Select Menu
Resources Controlled By [Manual]	Item Specific Help▶▶ BIOS can automatically configure all the boot and Plug and Play compatible devices. If you choose Auto, you cannot select IRQ DMA and memory base address
▶ IRQ Resources	
PCI/VGA Pallette Snoop [Disabled]	
** PCI Express relative items ** Maximum Payload Size [4096]	

Phoenix - Award BIOS CMOS Setup Utility	
Advanced	
IRQ Resources	Select Menu
IRQ-3 assigned to [PCI Device]	Item Specific Help▶▶▶ Legacy ISA for devices compliant with the original PC AT bus specification, PCI/ISA PnP for devices compliant with the Plug and Play standard whether designed for PCI or ISA bus architecture.
IRQ-4 assigned to [PCI Device]	
IRQ-5 assigned to [PCI Device]	
IRQ-7 assigned to [PCI Device]	
IRQ-9 assigned to [PCI Device]	
IRQ-10 assigned to [PCI Device]	
IRQ-11 assigned to [PCI Device]	
IRQ-12 assigned to [PCI Device]	
IRQ-14 assigned to [PCI Device]	
IRQ-15 assigned to [PCI Device]	

F1:Help ↑↓:Select Item -/+ : Change Value F5:Setup Defaults
ESC:Exit ↔:Select Menu Enter: Select SubMenu F10:Save and Exit

IRQ-xx assigned to [PCI Device]

When set to [PCI Device], the specific IRQ is free for use of PCI/PnP devices. When set to [Reserved], the IRQ is reserved for legacy ISA devices. Configuration options: [PCI Device] [Reserved]

4.4.6 USB Configuration

This menu shows the USB configuration settings. Select an item then press <Enter> to display a pop-up menu with the configuration options.

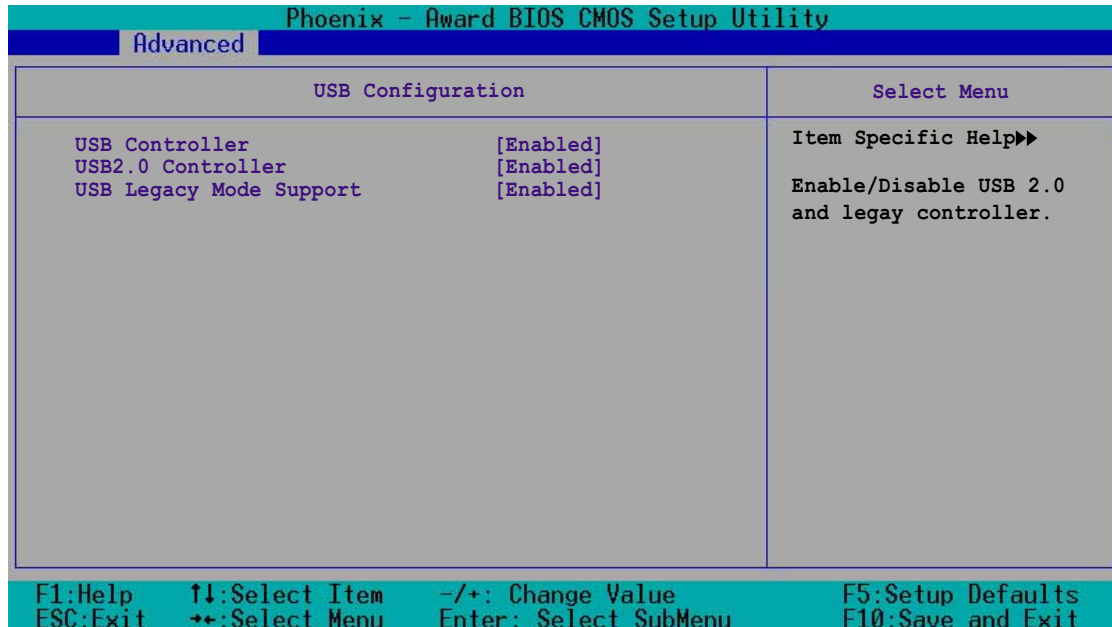

USB Controller [Enabled]

Allows you to enable or disable the USB controller.
Configuration options: [Disabled] [Enabled]

USB2.0 Controller [Enabled]

Allows you to enable or disable the USB 2.0 controller. Setting this item to [Enabled] allows the built-in high speed USB support in the BIOS to turn on automatically when you install high speed USB devices.
Configuration options: [Disabled] [Enabled]

USB Legacy Mode Support [Enabled]

Allows you to enable or disable support for the legacy USB devices.
Configuration options: [Disabled] [Enabled]

4.5 Power menu

The Power menu items allow you to change the settings for the ACPI and Advanced Power Management (APM) features. Select an item then press <Enter> to display the configuration options.

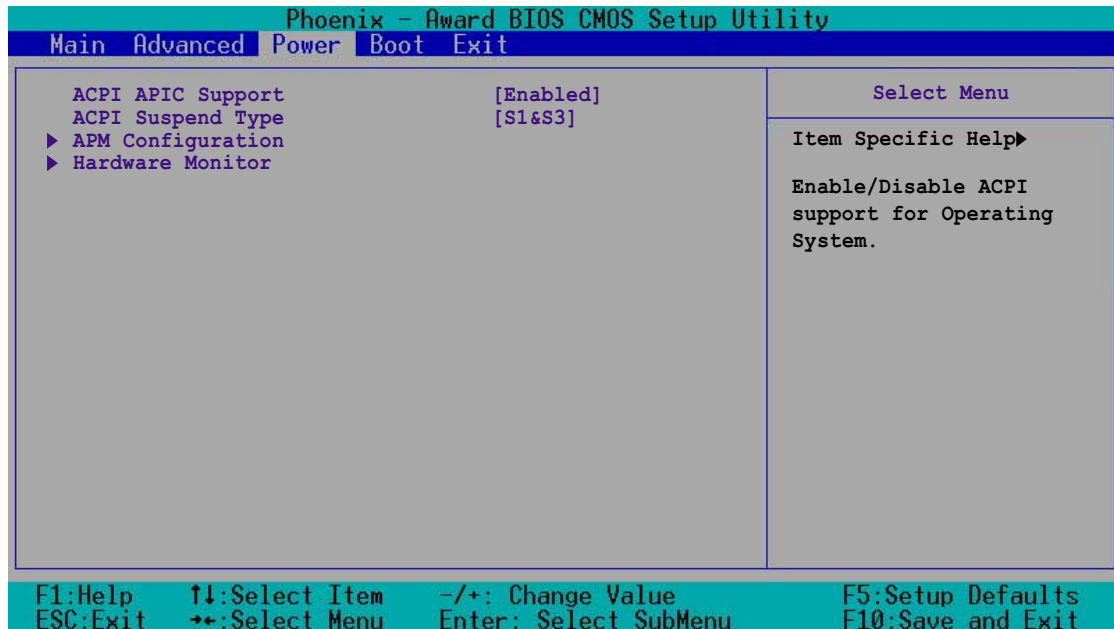

ACPI APIC Support [Enabled]

Allows you to enable or disable the ACPI feature on the operating system.
Configuration options: [Disabled] [Enabled]

ACPI Suspend Type [S1&S3]

Allows you to select the Advanced Configuration and Power Interface (ACPI) state to be used for system suspend.
Configuration options: [S1(POS)] [S3(STR)] [S1&S3]

4.5.1 APM Configuration

This menu shows the Advanced Power Management (APM) configuration settings. Select an item then press <Enter> to display a pop-up menu with the configuration options.

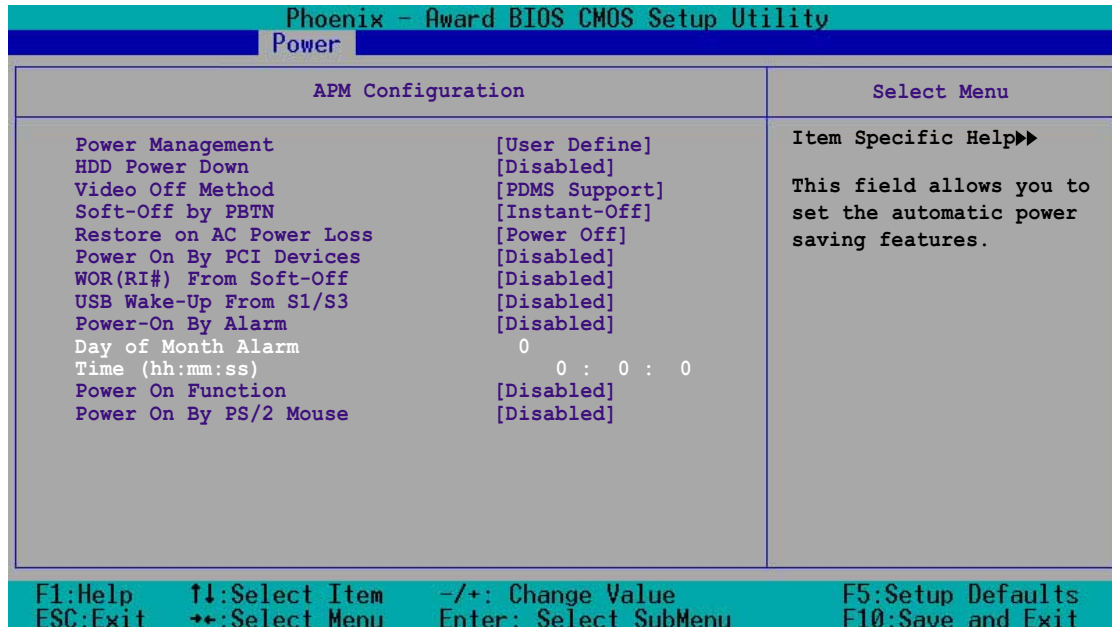

Power Management [User Define]

Allows you to set the automatic power saving features.

Configuration options: [User Define] [Min Saving] [Max Saving]

HDD Power Down [Disabled]

Shuts down any hard disk drives in the system after a period of inactivity as set in this field.

Configuration options: [Disabled] [1 Min] [2 Min]... [15 Min]

Video Off Method [DPMS Support]

Allows you to select the video off method. The Display Power Management System (DPMS) feature allows the BIOS to control the video display card if it supports DPMS. [Blank Screen] only blanks the screen. Use this for monitors without power management or "green" features.

Configuration options: [Blank Screen] [V/H Sync+Blank] [DPMS Support]

Soft-Off By PBTN [Instant-Off]

When set to [Instant-Off], the system goes to soft-off when you press the power button for less than 4 seconds. When set to [Delay 4 Sec], the system power goes off when you press the power button for more than 4 seconds. Configuration options: [Delay 4 Sec] [Instant-Off]

Restore on AC Power Loss [Power Off]

When set to [Power Off], the system goes into “off state” after an AC power interruption. When set to [Power On], the system turns on automatically after a power interruption. When set to [Last State], the system goes into whatever was the system state (on or off) before the power interruption. Configuration options: [Power Off] [Power On] [Last State]

Power On By PCI Devices [Disabled]

Allows you to enable or disable the PME to generate a wake-up event. Configuration options: [Disabled] [Enabled]

WOR(RI#) From Soft-Off [Disabled]

Allows you to enable or disable wake-up on ring. Configuration options: [Disabled] [Enabled]

USB Wake-up From S1/S3 [Disabled]

Allows you to enable or disable wake-up from S1/S3 by USB keyboard or mouse. Configuration options: [Disabled] [Enabled]

Power On By Alarm [Disabled]

Allows you to enable or disable RTC to generate a wake-up event. When this item is enabled, the items **Date of Month Alarm** and **Time (hh:mm:ss) Alarm** items become user-configurable with set values. Configuration options: [Disabled] [Enabled]

Day of Month Alarm [0]

To set the date of alarm, highlight this item and press <Enter> to display the Day of Month Alarm pop-up menu. Key-in a value within the specified range then press <Enter>. Configuration options: [Min=0] [Max=31]

Time (hh:mm:ss) Alarm [0 : 0 : 0]

To set the time of alarm:

1. Highlight this item and press <Enter> to display a pop-up menu for the hour field.
2. Key-in a value (Min=0, Max=23), then press <Enter>.
3. Press <TAB> to move to the minutes field then press <Enter>.
4. Key-in a minute value (Min=0, Max=59), then press <Enter>.
5. Press <TAB> to move to the seconds field then press <Enter>.
6. Key-in a value (Min=0, Max=59), then press <Enter>.

Power On Function [Disabled]

Allows you to define specific keys on the keyboard to turn on the system. Configuration options: [Disabled] [Ctrl+ESC] [Space Bar] [Power Key] [Any Key]

Power Up By PS/2 Mouse [Disabled]

When set to [Enabled], this parameter allows you to use the PS/2 mouse to turn on the system. This feature requires an ATX power supply that provides at least 1A on the +5VSB lead. Configuration options: [Disabled] [Enabled]

4.5.2 Hardware Monitor

This menu shows the hardware monitoring status. Select an item, then press Enter to display a pop-up menu with the configuration options.

The screenshot shows the BIOS setup utility interface. At the top, it says "Phoenix - Award BIOS CMOS Setup Utility" and "Power". The main window is titled "Hardware Monitor" and is split into two columns. The left column lists various hardware monitoring items, and the right column is titled "Select Menu" and contains the text "Item Specific Help" and "Press enter to view.". At the bottom, there is a legend for navigation keys: F1:Help, ↑↓:Select Item, -/+ : Change Value, F5:Setup Defaults, ESC:Exit, →+:Select Menu, Enter: Select SubMenu, and F10:Save and Exit.

Hardware Monitor		Select Menu
▶ Voltage Monitor		Item Specific Help▶▶
▶ Smart Q-Fan Configuration		Press enter to view.
System Temperature	39°C/102°F	
CPU1 Temperature	39°C/102°F	
CPU2 Temperature	29°C/84°F	
CPU Fan1 speed	2925 RPM	
CPU Fan2 speed	2925 RPM	
Front Fan1 speed	0 RPM	
Front Fan2 speed	0 RPM	
Rear Fan1 speed	0 RPM	
Rear Fan2 speed	0 RPM	

F1:Help ↑↓:Select Item -/+ : Change Value F5:Setup Defaults
ESC:Exit →+:Select Menu Enter: Select SubMenu F10:Save and Exit

Voltage Monitor

Phoenix - Award BIOS CMOS Setup Utility		
Power		
Voltage Monitor	Select Menu	
CPU VCORE A (V)	1.53 V	Item Specific Help▶▶▶
CPU VCORE B (V)	N/A	
+3.3 Voltage	3.28 V	
+12V Voltage	11.91 V	
+1.5V Voltage	1.56 V	
+2.5V Voltage	2.54 V	
+5VCC Voltage	4.99 V	
+5VSB Voltage	4.96 V	
VBAT Voltage	3.10 V	
CPU1 DDR Voltage	[2.60V]	
CPU2 DDR Voltage	[2.60V]	
Chipset Voltage	[1.50V]	
CPU1 Voltage Control	[Default VID+100mV]	
CPU2 Voltage Control	[Default VID+100mV]	
Hyper Transport Voltage	[1.20V]	

F1:Help ↑↓:Select Item -/+ : Change Value F5:Setup Defaults
ESC:Exit ⇨:Select Menu Enter: Select SubMenu F10:Save and Exit

CPU VCORE A/B (V), +3.3 Voltage, +12V Voltage, +1.5V Voltage, +2.5V Voltage, +5VCC Voltage, +5VSB Voltage, VBAT Voltage

These fields show the auto-detected voltages through the onboard voltage regulators.

CPU1 DDR Voltage CPU2 DDR Voltage

Allow you to adjust the DDR voltage.

Configuration options: [2.60V] [2.70V] [2.80V] [2.90V]

Chipset Voltage

Allow you to adjust the chipset voltage.

Configuration options: [1.50V] [1.60V] [1.70V] [1.80V]

CPU1 Voltage Control CPU2 Voltage Control

Allow you to select the CPU voltages.

Configuration options: [Default VID or plus 100mV] [Default VID]

Hyper Transport Voltage

Allow you to adjust the chipset voltage.

Configuration options: [1.20V] [1.25V] [1.30V] [1.35V]

Smart Q-Fan Configuration

Phoenix - Award BIOS CMOS Setup Utility	
Power	
Hardware Monitor	Select Menu
Smart Fan Control [Disabled]	Item Specific Help▶▶
System Target Temperature 50	Press enter to select
CPU1 Target Temperature 55	enable/disable Smart Fan.
CPU1 Target Temperature 55	

F1:Help ↑↓:Select Item -/+ : Change Value F5:Setup Defaults
ESC:Exit →+:Select Menu Enter: Select SubMenu F10:Save and Exit

Smart Fan Control [Disabled]

Allows you to enable or disable the Smart Fan feature.

Configuration options: [Disabled] [Enabled]



- The System/CPU1/CPU2 Target Temperature items become configurable only when you set Smart Fan Control to [Enabled].
- When the actual system/CPU1/CPU2 temperature becomes equal to the target temperature set in the following fields, the respective fan will run at full speed.

System Target Temperature [50]

Allows you to set the target temperature for the system. Configuration options: [Min=20] [Max=50]

CPU1 Target Temperature [55]

Allows you to set the target temperature for CPU1. Configuration options: [Min=30] [Max=60]

CPU2 Target Temperature [55]

Allows you to set the target temperature for CPU1. Configuration options: [Min=30] [Max=60]

4.6 Boot menu

The Boot menu items allow you to change the system boot settings. Select an item then press Enter to display a sub-menu with additional items, or show a pop-up menu with the configuration options.

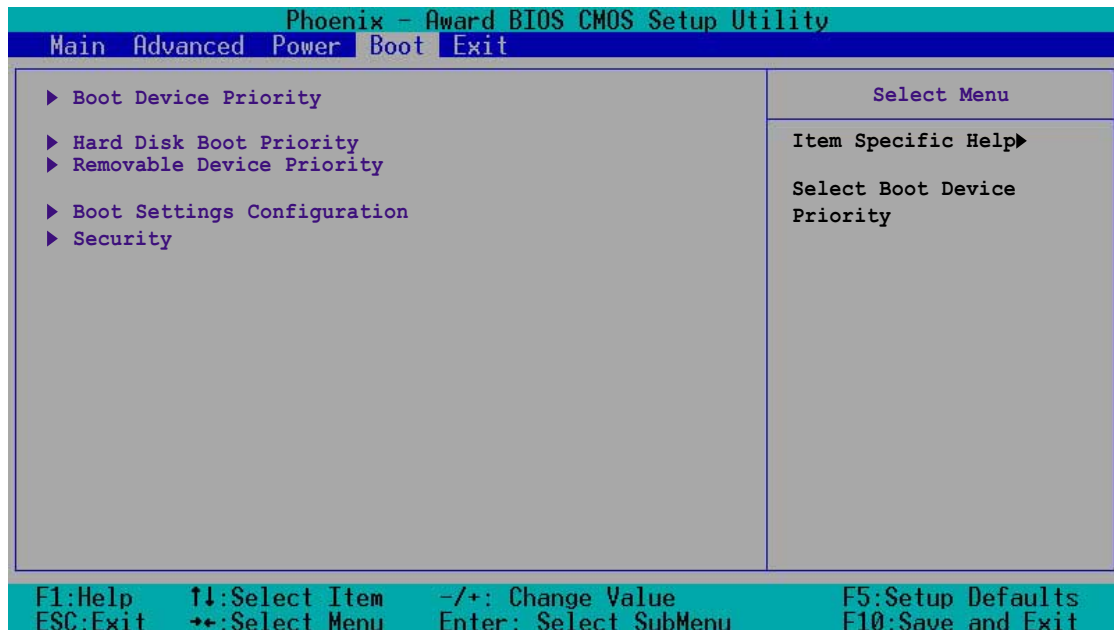

4.6.1 Boot Device Priority

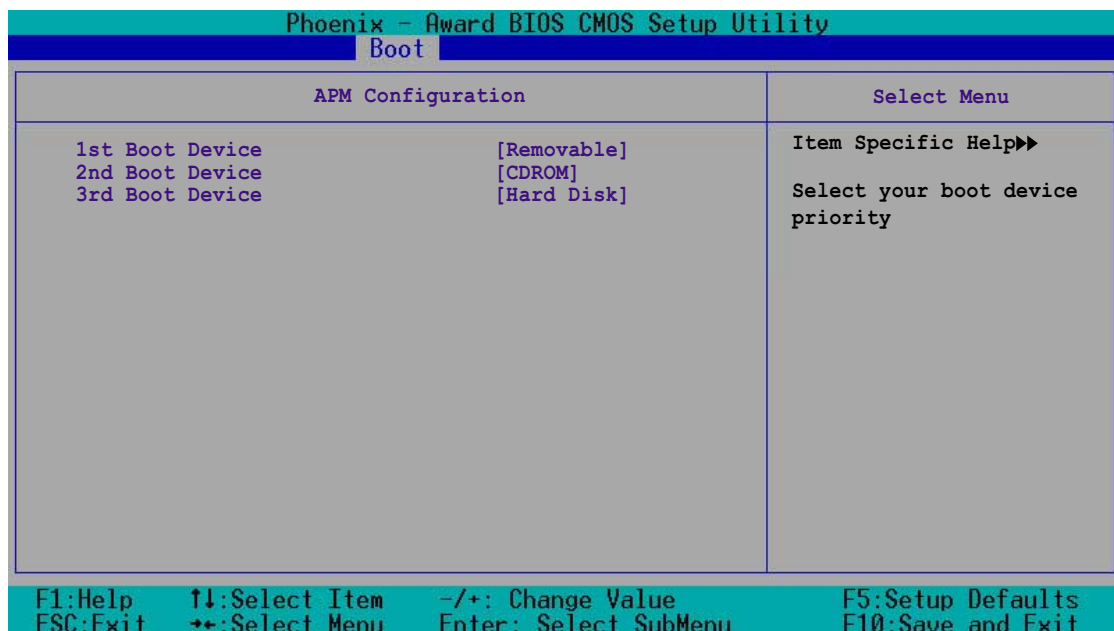

1st Boot Device [Removable]

2nd Boot Device [CDROM]

3rd Boot Device [Hard Disk]

These items allow you to select your boot device priority. Configuration options: [Removable] [Hard Disk] [CDROM] [Legacy LAN] [Disabled]

4.6.2 Hard Disk Boot Priority

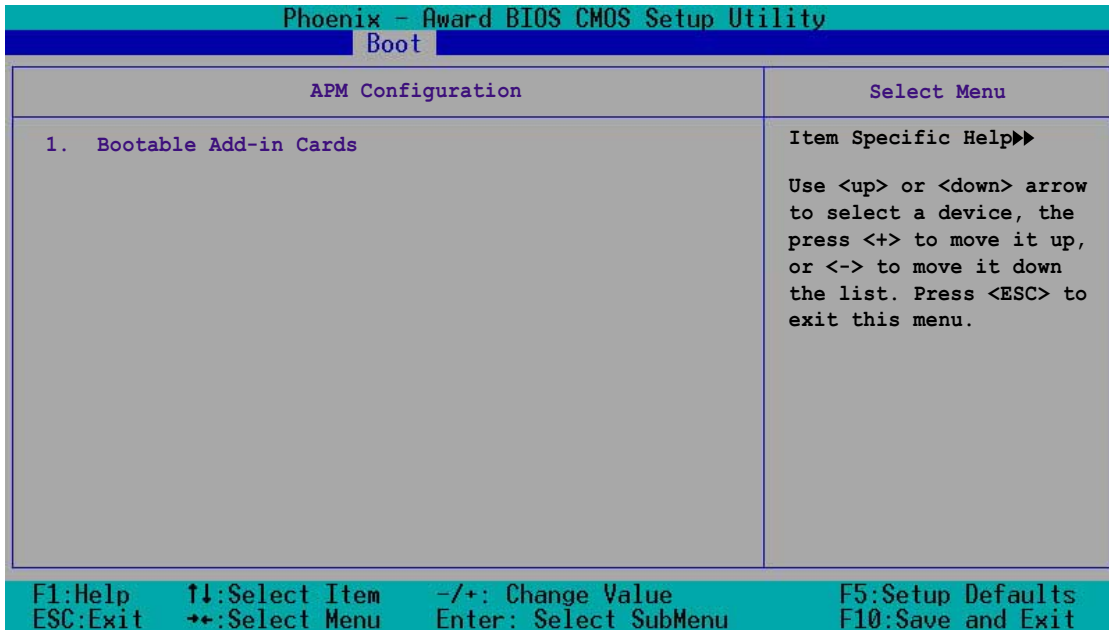

4.6.3 Removable Device Priority

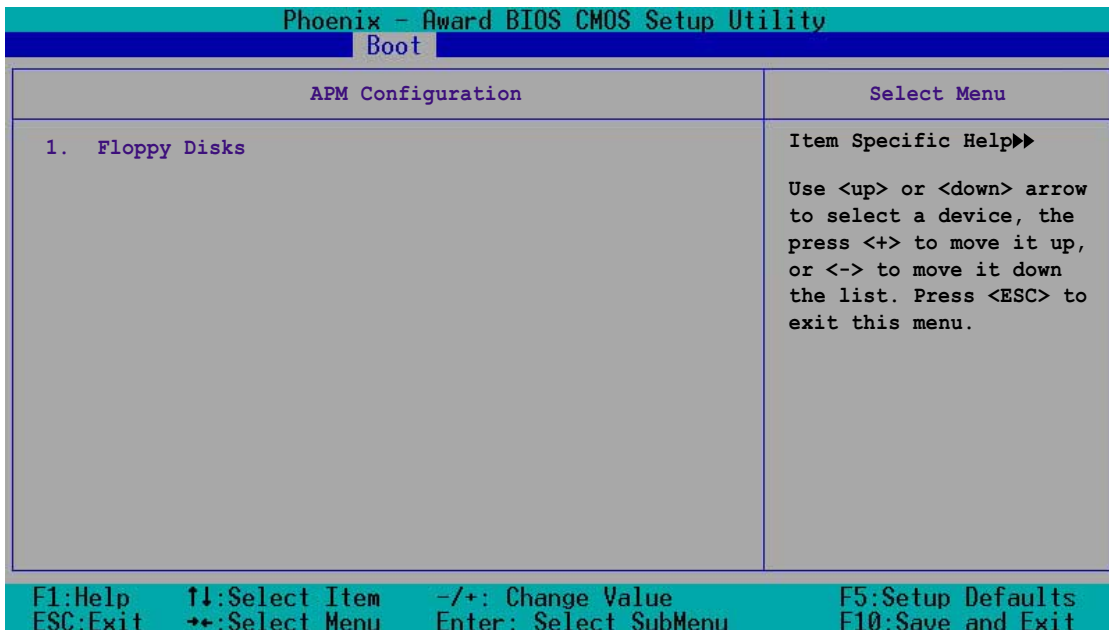

4.6.4 Boot Settings Configuration

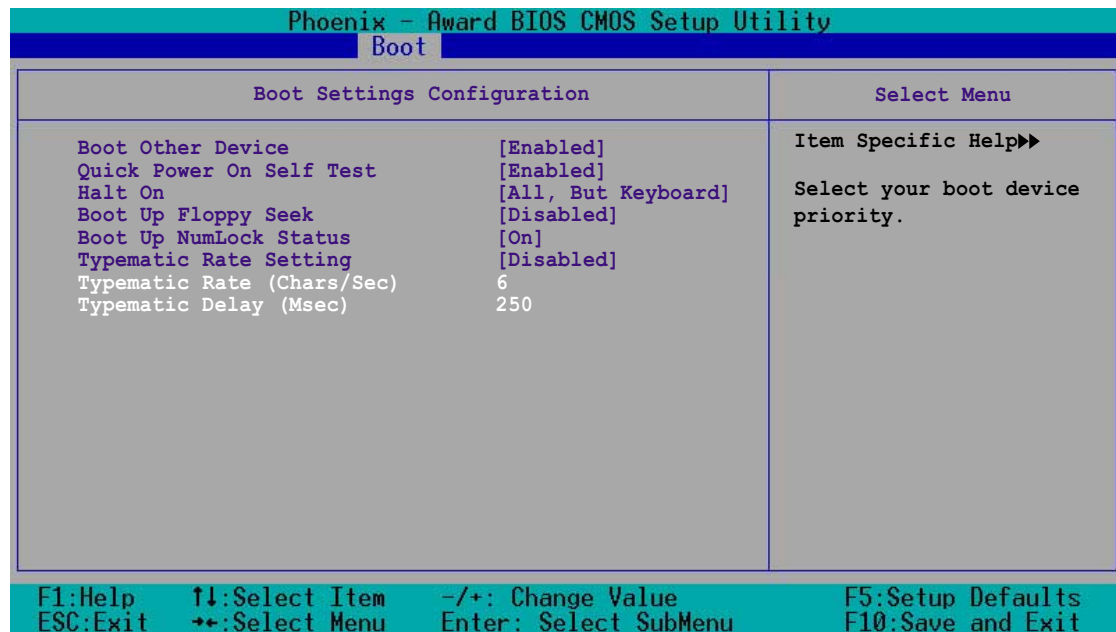

Boot Other Device [Enabled]

Allows you to enable or disable selection of other boot device.
 Configuration options: [Disabled] [Enabled]

Quick Power On Self Test [Enabled]

This field speeds up the Power-On-Self Test (POST) routine by skipping certain tests while booting, thereby decreasing the boot time.
 Configuration options: [Disabled] [Enabled]

Halt On [All, But Keyboard]

Sets the system to halt on errors according to the system functions specified in each option. Configuration options: [All Errors] [No Errors] [All, But Keyboard] [All , But Diskette] [All, But Disk/Key]

Boot Up Floppy Seek [Disabled]

When enabled, the BIOS will seek the floppy disk drive to determine whether the drive has 40 or 80 tracks. Configuration options: [Disabled] [Enabled]

Boot Up NumLock Status [On]

Allows you to select the power-on state for the NumLock. Configuration options: [On] [Off]

Typematic Rate Setting [Disabled]

Allows you to enable or disable the keyboard typematic rate setting. Set to [Enabled] to configure the Type Rate and Type Delay items. Configuration options: [Disabled] [Enabled]



The items **Typematic Rate (Chars/Sec)** and **Typematic Delay** become configurable only when the item Typematic Setting is enabled.

Typematic Rate (Chars/Sec) [6]

Allows you to select the rate at which character repeats when you hold a key. Configuration options: [6] [8] [10] [12] [15] [20] [24] [30]

Typematic Delay (Msec) [250]

Allows you to set the delay before key strokes begin to repeat. Configuration options: [250] [500] [750] [1000]

4.6.5 Security

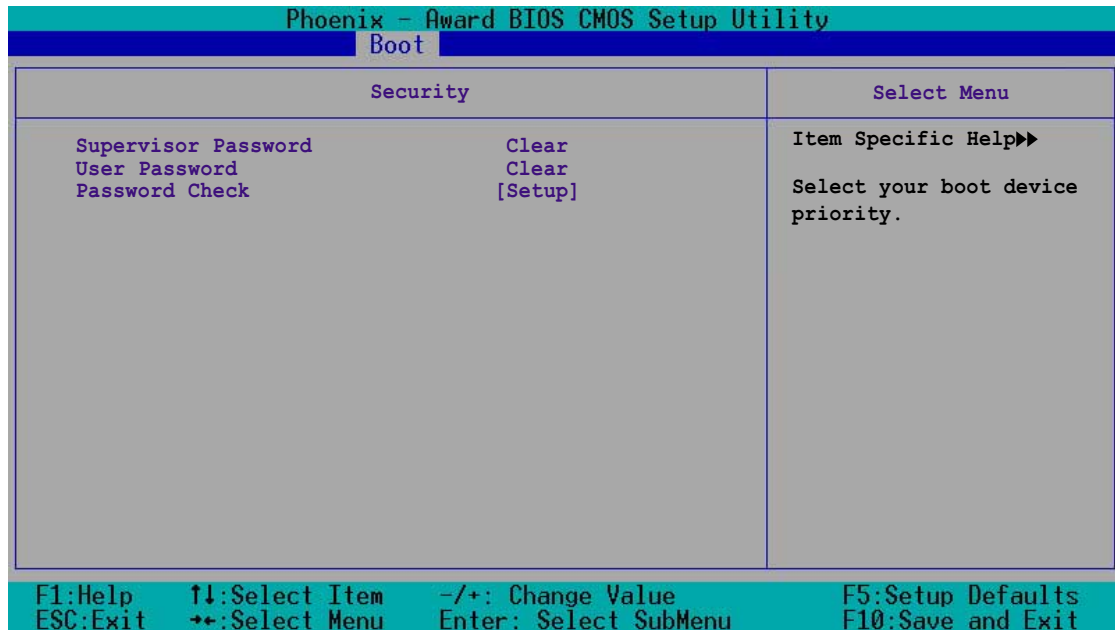

Supervisor Password [Clear] User Password [Clear]

These fields allow you to set passwords:

To set a password:

1. Select an item then press <Enter>.
2. Type in a password using a combination of a maximum of eight (8) alpha-numeric characters, then press <Enter>.
3. When prompted, confirm the password by typing the exact characters again, then press <Enter>. The password field setting is changed to Set.

To clear the password:

1. Select the password field and press <Enter> twice. The following message appears:

```
PASSWORD DISABLED !!!  
Press any key to continue...
```

2. Press any key to continue. The password field setting is changed to Clear.

A note about passwords

The Supervisor password is required to enter the BIOS Setup program preventing unauthorized access. The User password is required to boot the system preventing unauthorized use.

Forgot your password?

If you forget your password, you can clear it by erasing the CMOS Real Time Clock (RTC) RAM. The RAM data containing the password information is powered by the onboard button cell battery. If you need to erase the CMOS RAM, refer to section “2.6 Jumpers” for instructions.

Password Check

This field requires you to enter the password before entering the BIOS setup or the system. Select [Setup] to require the password before entering the BIOS Setup. Select [System] to require the password before entering the system. Configuration options: [Setup] [System]

4.7 Exit menu

The Exit menu items allow you to load the BIOS setup default settings, save or discard any changes you made, or exit the Setup utility.

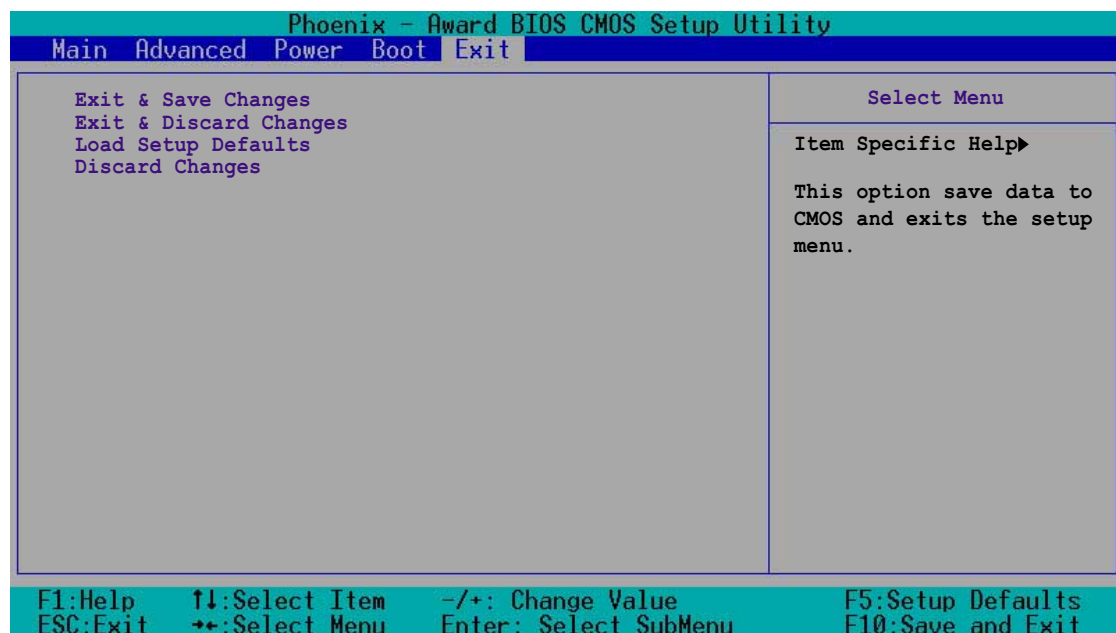

Exit & Save Changes

Select this option then press <Enter>, or simply press <F10>, to save your changes to CMOS before exiting the Setup utility.

When a confirmation window appears (with a blinking [Y]):

- press <Enter> to save and exit
- type [N], then press <Enter>, or simply press <Esc>, to cancel the command and return to the Exit menu

Exit & Discard Changes

Select this option then press <Enter> if you wish to exit the Setup utility without saving your changes.

When a confirmation window appears (with a blinking [Y]):

- press <Enter> to discard your changes and exit
- type [N], then press <Enter>, or simply press <Esc>, to cancel the command and return to the Exit menu

Load Setup Defaults

Select this option then press <Enter>, or simply press <F5>, to load the optimized values for each of the Setup menu items.

When a confirmation window appears (with a blinking [Y]):

- press <Enter> to load the default values
- type [N], then press <Enter>, or simply press <Esc>, to cancel the command and return to the Exit menu

Discard Changes

Select this option to discard the changes that you made, and restore the previously saved values.

When a confirmation window appears (with a blinking [Y]):

- press <Enter> to discard any changes, and load the previously saved values
- type [N], then press <Enter>, or simply press <Esc>, to cancel the command and return to the Exit menu

This appendix includes additional information that you may refer to when configuring the motherboard.

Reference information

Appendix summary



A.1	K8N-DL block diagram	A-1
-----	----------------------------	-----

A.1 K8N-DL block diagram

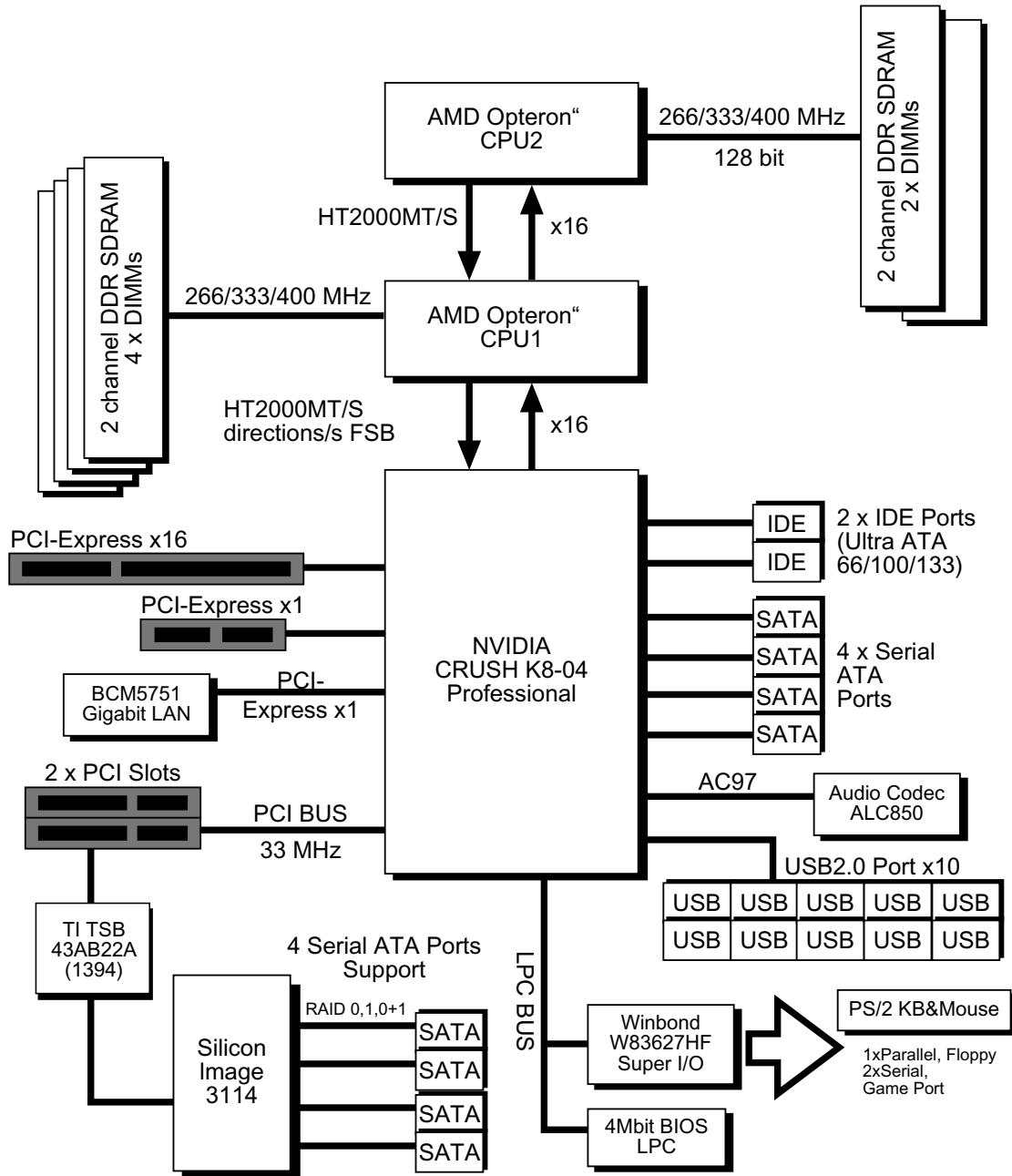

Free Manuals Download Website

<http://myh66.com>

<http://usermanuals.us>

<http://www.somanuals.com>

<http://www.4manuals.cc>

<http://www.manual-lib.com>

<http://www.404manual.com>

<http://www.luxmanual.com>

<http://aubethermostatmanual.com>

Golf course search by state

<http://golfingnear.com>

Email search by domain

<http://emailbydomain.com>

Auto manuals search

<http://auto.somanuals.com>

TV manuals search

<http://tv.somanuals.com>