



A7V400-MX

User Guide

Motherboard

E1817

Revised Edition V2

October 2004

Copyright © 2004 ASUSTeK COMPUTER INC. All Rights Reserved.

No part of this manual, including the products and software described in it, may be reproduced, transmitted, transcribed, stored in a retrieval system, or translated into any language in any form or by any means, except documentation kept by the purchaser for backup purposes, without the express written permission of ASUSTeK COMPUTER INC. ("ASUS").

Product warranty or service will not be extended if: (1) the product is repaired, modified or altered, unless such repair, modification or alteration is authorized in writing by ASUS; or (2) the serial number of the product is defaced or missing.

ASUS PROVIDES THIS MANUAL "AS IS" WITHOUT WARRANTY OF ANY KIND, EITHER EXPRESS OR IMPLIED, INCLUDING BUT NOT LIMITED TO THE IMPLIED WARRANTIES OR CONDITIONS OF MERCHANTABILITY OR FITNESS FOR A PARTICULAR PURPOSE. IN NO EVENT SHALL ASUS, ITS DIRECTORS, OFFICERS, EMPLOYEES OR AGENTS BE LIABLE FOR ANY INDIRECT, SPECIAL, INCIDENTAL, OR CONSEQUENTIAL DAMAGES (INCLUDING DAMAGES FOR LOSS OF PROFITS, LOSS OF BUSINESS, LOSS OF USE OR DATA, INTERRUPTION OF BUSINESS AND THE LIKE), EVEN IF ASUS HAS BEEN ADVISED OF THE POSSIBILITY OF SUCH DAMAGES ARISING FROM ANY DEFECT OR ERROR IN THIS MANUAL OR PRODUCT.

SPECIFICATIONS AND INFORMATION CONTAINED IN THIS MANUAL ARE FURNISHED FOR INFORMATIONAL USE ONLY, AND ARE SUBJECT TO CHANGE AT ANY TIME WITHOUT NOTICE, AND SHOULD NOT BE CONSTRUED AS A COMMITMENT BY ASUS. ASUS ASSUMES NO RESPONSIBILITY OR LIABILITY FOR ANY ERRORS OR INACCURACIES THAT MAY APPEAR IN THIS MANUAL, INCLUDING THE PRODUCTS AND SOFTWARE DESCRIBED IN IT.

Products and corporate names appearing in this manual may or may not be registered trademarks or copyrights of their respective companies, and are used only for identification or explanation and to the owners' benefit, without intent to infringe.

Contents

Notices	v
Safety information	vi
About this guide	vii
A7V400-MX specifications summary	viii

Chapter 1: Product introduction

1.1 Welcome!	1-2
1.2 Package contents	1-2
1.3 Special features	1-2
1.3.1 Product highlights	1-2
1.3.2 ASUS unique features	1-3
1.4 Before you proceed	1-4
1.5 Motherboard overview	1-5
1.5.1 Motherboard layout	1-5
1.5.2 Placement direction	1-6
1.5.3 Screw holes	1-6
1.6 Central Processing Unit (CPU)	1-7
1.6.1 Overview	1-7
1.6.2 Installing the CPU	1-7
1.7 System memory	1-8
1.7.1 Overview	1-8
1.7.2 Memory configurations	1-8
1.7.3 Installing a DIMM	1-9
1.7.4 Removing a DIMM	1-9
1.8 Expansion slots	1-10
1.8.1 Installing an expansion card	1-10
1.8.2 Configuring an expansion card	1-10
1.8.3 AGP slot	1-12
1.8.4 PCI slots	1-12
1.9 Switch and jumpers	1-13
1.10 Connectors	1-16
1.10.1 Rear panel connectors	1-16
1.10.2 Internal panel connectors	1-17

Contents

Chapter 2: BIOS information

2.1	Managing and updating your BIOS	2-2
2.1.1	Creating a bootable floppy disk	2-2
2.1.2	Using the AwardBIOS Flash Utility	2-2
2.1.3	CrashFree BIOS feature	2-4
2.1.4	ASUS Update	2-4
2.2	BIOS beep codes	2-6
2.3	BIOS Setup program	2-6
2.3.1	BIOS menu bar	2-7
2.3.2	Legend bar	2-7
2.4	Main menu	2-9
2.5	Advanced menu	2-13
2.5.1	Chip Configuration	2-14
2.5.2	I/O Device Configuration	2-19
2.5.3	PCI Configuration	2-20
2.6	Power menu	2-22
2.6.1	Power Up Control	2-23
2.6.2	Hardware Monitor	2-25
2.7	Boot menu	2-26
2.8	Exit menu	2-28

Chapter 3: Software support

3.1	Installing an operating system	3-2
3.2	Support CD information	3-2
3.2.1	Running the support CD	3-2
3.2.2	Drivers menu	3-3
3.2.3	Utilities menu	3-3
3.2.4	ASUS contact information	3-4

Notices

Federal Communications Commission Statement

This device complies with FCC Rules Part 15. Operation is subject to the following two conditions:

- This device may not cause harmful interference, and
- This device must accept any interference received including interference that may cause undesired operation.

This equipment has been tested and found to comply with the limits for a Class B digital device, pursuant to Part 15 of the FCC Rules. These limits are designed to provide reasonable protection against harmful interference in a residential installation. This equipment generates, uses and can radiate radio frequency energy and, if not installed and used in accordance with manufacturer's instructions, may cause harmful interference to radio communications. However, there is no guarantee that interference will not occur in a particular installation. If this equipment does cause harmful interference to radio or television reception, which can be determined by turning the equipment off and on, the user is encouraged to try to correct the interference by one or more of the following measures:

- Reorient or relocate the receiving antenna.
- Increase the separation between the equipment and receiver.
- Connect the equipment to an outlet on a circuit different from that to which the receiver is connected.
- Consult the dealer or an experienced radio/TV technician for help.



The use of shielded cables for connection of the monitor to the graphics card is required to assure compliance with FCC regulations. Changes or modifications to this unit not expressly approved by the party responsible for compliance could void the user's authority to operate this equipment.

Canadian Department of Communications Statement

This digital apparatus does not exceed the Class B limits for radio noise emissions from digital apparatus set out in the Radio Interference Regulations of the Canadian Department of Communications.

This class B digital apparatus complies with Canadian ICES-003.

Safety information

Electrical safety

- To prevent electrical shock hazard, disconnect the power cable from the electrical outlet before relocating the system.
- When adding or removing devices to or from the system, ensure that the power cables for the devices are unplugged before the signal cables are connected. If possible, disconnect all power cables from the existing system before you add a device.
- Before connecting or removing signal cables from the motherboard, ensure that all power cables are unplugged.
- Seek professional assistance before using an adapter or extension cord. These devices could interrupt the grounding circuit.
- Make sure that your power supply is set to the correct voltage in your area. If you are not sure about the voltage of the electrical outlet you are using, contact your local power company.
- If the power supply is broken, do not try to fix it by yourself. Contact a qualified service technician or your retailer.

Operation safety

- Before installing the motherboard and adding devices on it, carefully read all the manuals that came with the package.
- Before using the product, make sure all cables are correctly connected and the power cables are not damaged. If you detect any damage, contact your dealer immediately.
- To avoid short circuits, keep paper clips, screws, and staples away from connectors, slots, sockets and circuitry.
- Avoid dust, humidity, and temperature extremes. Do not place the product in any area where it may become wet.
- Place the product on a stable surface.
- If you encounter technical problems with the product, contact a qualified service technician or your retailer.

About this guide

Conventions used in this guide

To make sure that you perform certain tasks properly, take note of the following symbols used throughout this guide.



WARNING. Information to prevent injury to yourself when trying to complete a task.



CAUTION. Information to prevent damage to the components when trying to complete a task.



IMPORTANT. Information that you **MUST** follow to complete a task.



NOTE. Tips and additional information to aid in completing a task.

Where to find more information

Refer to the following sources for additional information and for product and software updates.

1. Websites

The ASUS websites worldwide provide updated information on ASUS hardware and software products. Refer to the ASUS contact information.

2. Optional documentation

Your product package may include optional documentation, such as warranty flyers, that may have been added by your dealer. These documents are not part of the standard package.

A7V400-MX specifications summary

CPU	Socket A for AMD Athlon™XP processors Thoroughbred/Barton core
Chipset	VIA KM400A VIA VT8235 CE
Front Side Bus (FSB)	400/333/266/200 MHz
Memory	2 x 184-pin DDR DIMM sockets support up to maximum 2GB unbuffered PC2700/2100/1600 non-ECC DDR SDRAM memory.
Expansion slots	3 x PCI 1 x AGP 8X/4X (1.5V only)
IDE	2 x UltraATA133/100/66
Graphics	Integrated VIA UniChrome™ Graphics
Audio	ADI SoundMAX 6-channel Audio CODEC S/PDIF out interface
LAN	VIA VT6103 10/100 Mbps Ethernet PHY
USB	Maximum 6 USB 2.0 ports
Hardware monitoring	Super I/O integrated monitoring of CPU/chassis fan and MB/CPU temperature
Rear panel I/O ports	1 x Parallel 1 x Serial 1 x PS/2 keyboard 1 x PS/2 mouse 1 x RJ-45 port 1 x Audio I/O 1 x VGA 4 x USB 2.0/1.1
Internal connectors	1 x USB connector supports two additional USB 2.0 ports CPU/chassis FAN connectors Chassis intrusion connector 20-pin ATX power connector PANEL connector CD/AUX connectors S/PDIF Out connector GAME/MIDI connector Front panel audio connector COM2 connector

(continued next page)

A7V400-MX specifications summary

BIOS features	2Mb Flash ROM, Phoenix Award BIOS, Enhanced ACPI, DMI2.0, PnP features, TCAV, CrashFree BIOS
Industry standard	PCI 2.2, USB 2.0/1.1
Manageability	Wake on Ring (WOR), Wake on LAN (WOL) Chassis intrusion
Support CD contents	Device drivers ASUS PC Probe ASUS Live Update Utility Award BIOS Flash Utility Adobe Acrobat Reader Trend Micro™ PC-cillin Anti-Virus Application
Accessories	User Guide ASUS A7V400-MX support CD UltraATA cable FDD cable I/O shield
Form Factor	Micro-ATX form factor: 9.6 in x 9.6 in

** Specifications are subject to change without notice.*

Chapter 1

This chapter describes the features of the motherboard. It includes brief descriptions of the motherboard components, and illustrations of the layout, jumper settings, and connectors.

Product introduction

1.1 Welcome!

Thank you for buying the ASUS® A7V400-MX motherboard!

The ASUS A7V400-MX motherboard comes with the most advanced technologies to deliver maximum performance for Socket A processors. This motherboard comes with value-added features for guaranteed consumer satisfaction. The following sections provide important technical information about the motherboard for system reconfiguration or future upgrades.

Before you start installing the motherboard and hardware devices on it, check the items in your package with the list below.

1.2 Package contents

Check your motherboard package for the following items.

- ✓ ASUS A7V400-MX motherboard.(Micro-ATX form factor: 9.6 in x 9.6 in)
- ✓ ASUS A7V400-MX support CD
- ✓ 40-pin 80-conductor ribbon cable for UltraATA133 IDE drives
- ✓ Ribbon cable for a 3.5-inch floppy drive
- ✓ Bag of extra jumper caps
- ✓ I/O shield
- ✓ User Guide



Contact your retailer if any of the items is damaged or missing.

1.3 Special features

1.3.1 Product highlights

400MHz FSB support for Athlon™ XP processors



The motherboard supports 400MHz front side bus frequency for Athlon™ XP processors allowing increased application productivity and enhanced digital multimedia experience. **See page 1-7.**

Integrated graphics

This motherboard comes with an integrated VIA Unichrome™ 2D/3D graphics core allowing efficient execution of multimedia applications and playback support for DVD video.

Integrated 10/100 LAN



Integrated in this motherboard is a 10/100Mbps Fast Ethernet controller to give you a fast and reliable connection to a local area network (LAN) and the Internet.

See page 1-16.

USB 2.0 technology



The motherboard implements the Universal Serial Bus (USB) 2.0 specification, dramatically increasing the connection speed from the 12 Mbps bandwidth on USB 1.1 to a fast 480 Mbps on USB 2.0. USB 2.0 is backward compatible with USB 1.1.

See page 1-16 and page 1-19.

Digital audio support



A Sony/Philips Digital Interface (S/PDIF) connector is onboard to give you convenient connectivity to external home theater audio systems. The S/PDIF technology allows direct digital audio transfers keeping the best signal quality.

SoundMAX 6-channel CODEC



The SoundMAX Digital Audio System is the industry's highest performance and most reliable audio solution for business professionals, audiophiles, musicians, and gamers. SoundMAX Digital Audio System can output 5.1 channel surround sound and features state-of-the-art DLS2 MIDI synthesizer and supports all major game audio technologies.

1.3.2 ASUS unique features

ASUS C.O.P.



The ASUS C.O.P. (CPU Overheating Protection) is a hardware protection circuit that automatically shuts down the system power before temperatures go high enough to permanently damage the CPU. See page 2-23.

ASUS CrashFree BIOS



CrashFree BIOS allows users to restore BIOS data from a floppy disk even when BIOS code and data are corrupted. Users can now enjoy this feature without the need to buy a new ROM. See page 2-4.

1.4 Before you proceed

Take note of the following precautions before you install motherboard components or change any motherboard settings.



- Unplug the power cord from the wall socket before touching any component.
- Use a grounded wrist strap or touch a safely grounded object or to a metal object, such as the power supply case, before handling components to avoid damaging them due to static electricity.
- Avoid touching the ICs on components.
- Whenever you uninstall any component, place it on a grounded antistatic pad or in the bag that came with the component.
- **Before you install or remove any component, ensure that the ATX power supply is switched off or the power cord is detached from the power supply.** Failure to do so may cause severe damage to the motherboard, peripherals, and/or components.

Onboard LED

The motherboard comes with a standby power LED. When lit, this green LED (SB_PWR) indicates that the system is ON, in sleep mode, or in soft-off mode, a reminder that you should shut down the system and unplug the power cable before removing or plugging in any motherboard component.

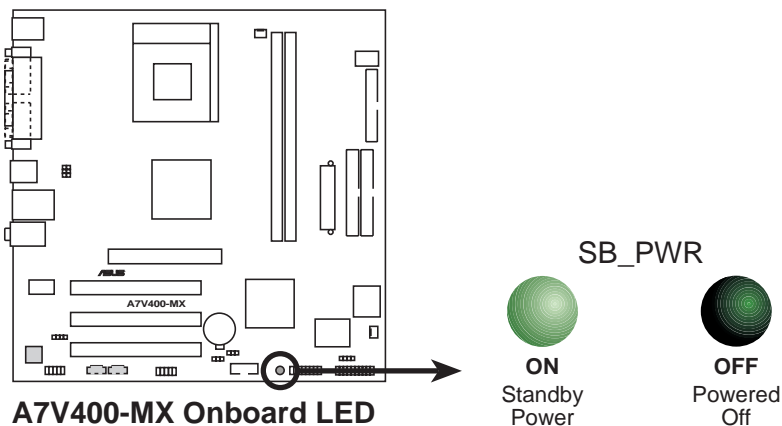

1.5 Motherboard overview

1.5.1 Motherboard layout

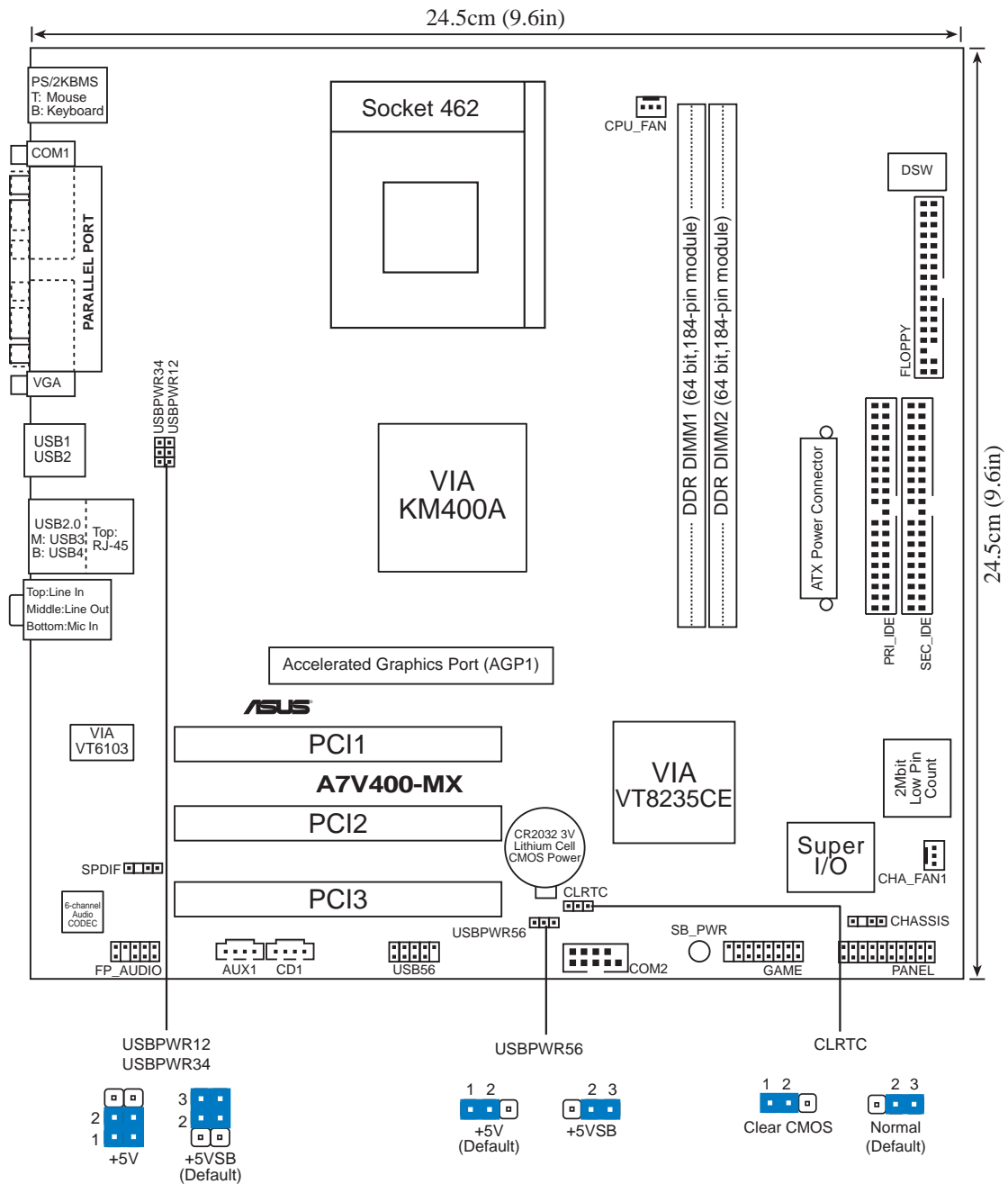

1.5.2 Placement direction

When installing the motherboard to the chassis, make sure to place it in the correct orientation. The edge with external ports goes to the rear part of the chassis as indicated in the image below. It may be more convenient to install major cables, the CPU and modular components before fixing the motherboard inside the case frame.

1.5.3 Screw holes

Place eight (8) screws into the holes indicated by circles to secure the motherboard to the chassis.



Do not overtighten the screws! Doing so may damage the motherboard.

Place this side
towards the rear of
the chassis —

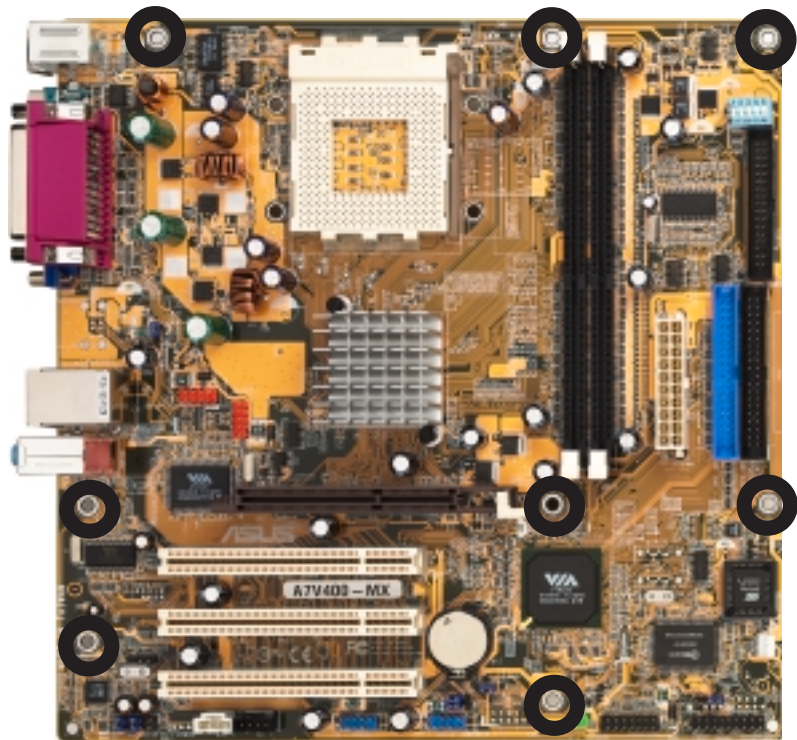

WARNING! Unplug the power cord before installing the motherboard. Failure to do so may cause you physical injury and damage Motherboard components.

1.6 Central Processing Unit (CPU)

1.6.1 Overview

The motherboard provides a Socket A for CPU installation. Each AMD CPU has a “marked” corner. This corner is usually indicated with a notch, and/or a golden square or triangle. Refer to this indicator while orienting the CPU. A fan and heatsink should be attached to the CPU to prevent overheating.



This motherboard does not support AMD processors with less than 1GHz core speed.

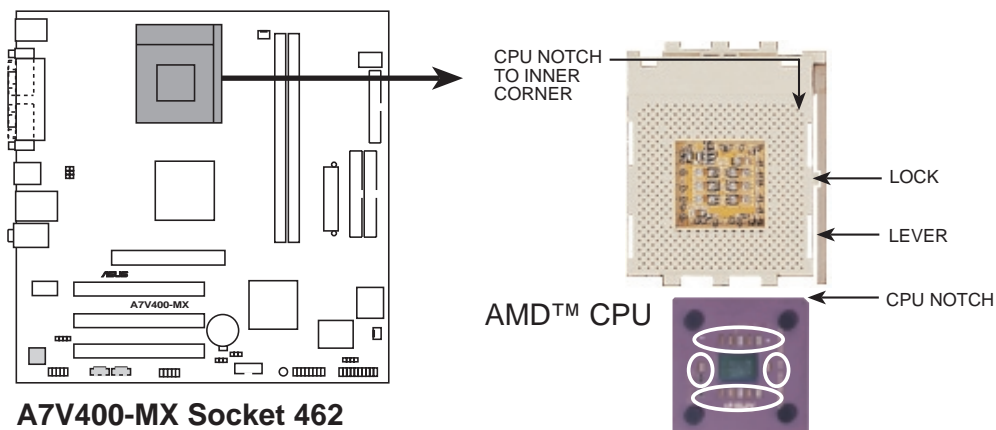

1.6.2 Installing the CPU

Follow these steps to install a CPU:

1. Locate the Socket 462 and open it by pulling the lever gently sideways away from the socket. Then lift the lever upwards. The socket lever must be fully opened (90 to 100 degrees).
2. Insert the CPU with the correct orientation. The **notched or golden corner** of the CPU must be oriented toward the inner corner of the socket base nearest to the lever hinge.

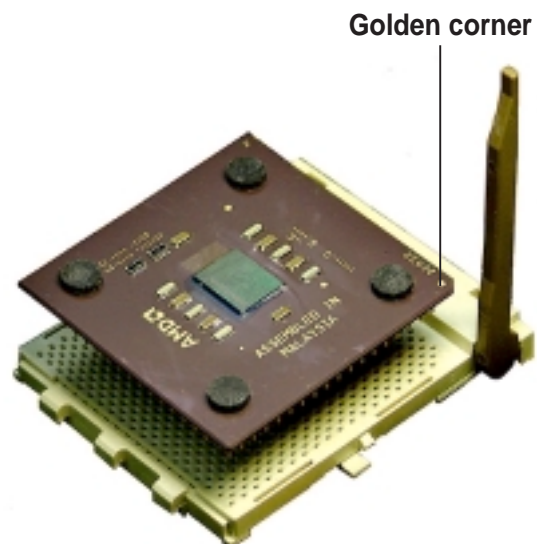

The CPU should drop easily into place. **Do not force the CPU** into the socket to avoid bending the pins. If the CPU does not fit, check its alignment and look for bent pins.

1.7 System memory

1.7.1 Overview

The motherboard has two Double Data Rate (DDR) DIMM sockets that support up to 2GB unbuffered non-ECC PC2700/2100/1600 DDR SDRAM DIMMs. Each DIMM socket is double-sided.

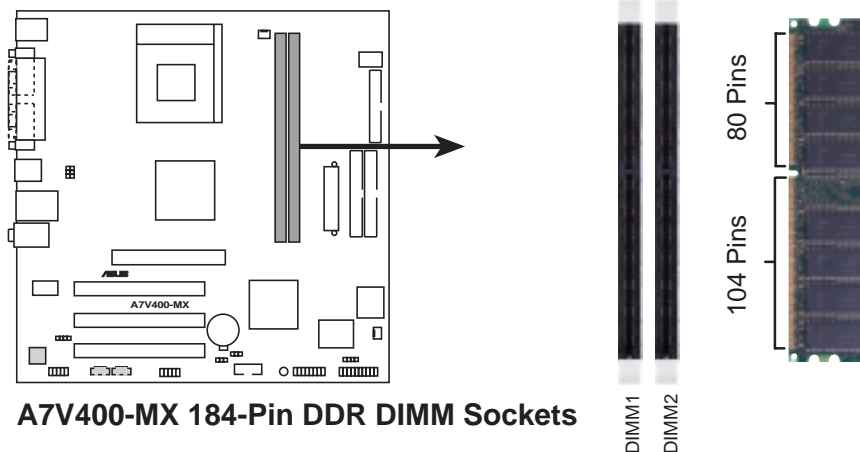

1.7.2 Memory configurations

You may install single or double-sided 64MB, 128MB, 256MB, 512MB, and 1GB DDR DIMMs to the sockets.



For optimum compatibility, it is recommended that you obtain memory modules from qualified vendors. Visit the ASUS website for an updated list of qualified DDR vendors.

1.7.3 Installing a DIMM



Make sure to unplug the power supply before adding or removing DIMMs or other system components. Failure to do so may cause severe damage to both the motherboard and the components.

Follow these steps to install a DIMM.

1. Locate the DIMM sockets in the motherboard.
2. Unlock a DIMM socket by pressing the retaining clips outward.
3. Align a DIMM on the socket such that the notch on the DIMM matches the break on the socket.

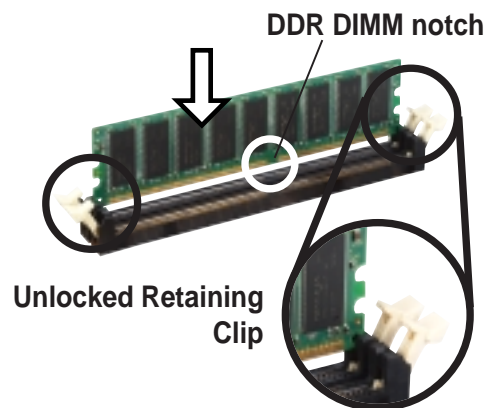

A DDR DIMM is keyed with a notch so that it fits in only one direction. **DO NOT** force a DIMM into a socket to avoid damaging the DIMM.

4. Firmly insert the DIMM into the socket until the retaining clips snap back in place and the DIMM is properly seated.

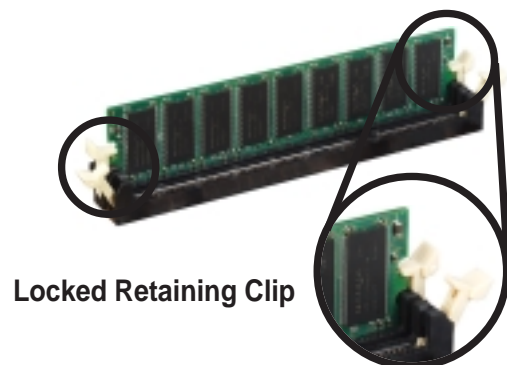

1.7.4 Removing a DIMM

Follow these steps to remove a DIMM.

1. Simultaneously press the retaining clips outward to unlock the DIMM.

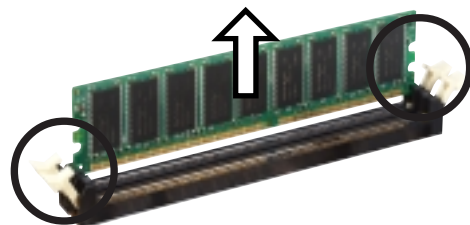

Support the DIMM lightly with your fingers when pressing the retaining clips. The DIMM might get damaged when it flips out with extra force.

2. Remove the DIMM from the socket.

1.8 Expansion slots

In the future, you may need to install expansion cards. The following sections describe the motherboard slots and the expansion cards that they support.



Make sure to unplug the power cord before adding or removing expansion cards. Failure to do so may cause you physical injury and damage motherboard components.

1.8.1 Installing an expansion card

Follow these steps to install an expansion card.

1. Before installing the expansion card, read the documentation that came with it and make the necessary hardware settings for the card.
2. Remove the system unit cover (if your motherboard is already installed in a chassis).
3. Remove the bracket opposite the slot that you intend to use. Keep the screw for later use.
4. Align the card connector with the slot and press firmly until the card is completely seated on the slot.
5. Secure the card to the chassis with the screw you removed earlier.
6. Replace the system cover.

1.8.2 Configuring an expansion card

After installing the expansion card, configure the card by adjusting the software settings.

1. Turn on the system and change the necessary BIOS settings, if any. See Chapter 2 for information on BIOS setup.
2. Assign an IRQ to the card. Refer to the tables on the next page.
3. Install the software drivers for the expansion card.

Standard Interrupt Assignments

IRQ	Standard Function
0	System Timer
1	Keyboard Controller
2	Programmable Interrupt Controller
3*	USB Universal Host Controller
4*	Communications Port (COM1)
5*	Onboard Audio
6	Standard Floppy Disk Controller
7*	Printer Port (LPT1)
8	System CMOS/Real Time Clock
9*	Onboard LAN
10*	USB Universal Host Controller
11*	Onboard VGA
12*	PS/2 Compatible Mouse Port
13	Numeric Data Processor
14*	Ultra ATA Controller
15*	Secondary Ultra ATA Controller

* These IRQs are usually available for ISA or PCI devices.

IRQ assignments for this motherboard

	A	B	C	D
PCI slot 1	shared	—	—	—
PCI slot 2	—	shared	—	—
PCI slot 3	—	—	shared	—
AGP slot	shared	—	—	—

1.8.3 AGP slot

The Accelerated Graphics Port (AGP) slot supports +1.5V/0.8V AGP graphics card. Note the notches on the card golden fingers to ensure that they fit the AGP slot on your motherboard.



Install only 1.5V AGP cards on this motherboard! This motherboard does not support 3.3V AGP cards.

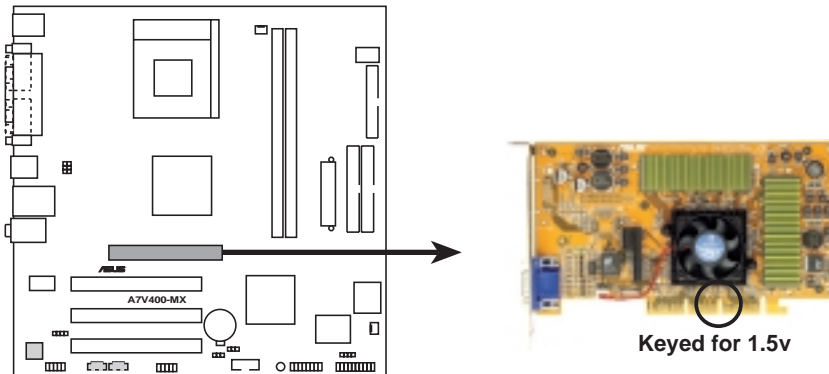

A7V400-MX Accelerated Graphics Port (AGP)

1.8.4 PCI slots

Three 32-bit PCI slots are available on this motherboard. The slots support PCI cards such as LAN card, SCSI card, USB card, and other cards that comply with PCI specifications. This figure shows a typical PCI card installed into a slot.

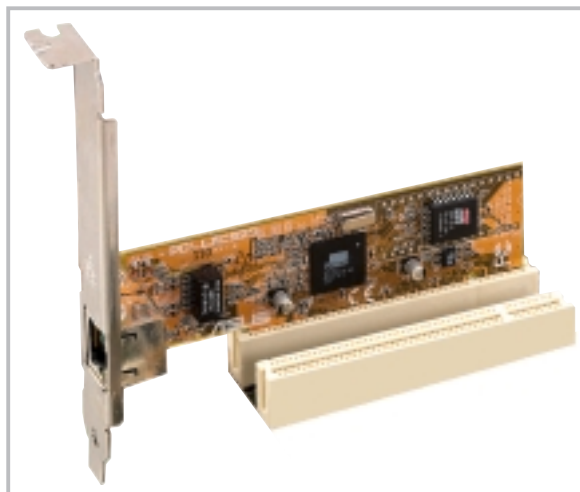

1.9 Switch and jumpers

1. CPU external frequency selection (DSW Switches 1-5)

The motherboard frequency is adjusted through the DIP switches. The white block represents the switch position. The illustration below shows the ON and OFF positions of the switches.

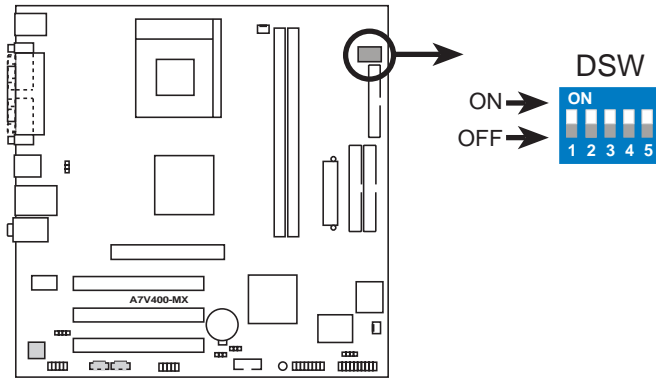

A7V400-MX DIP Switches

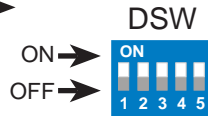

The option to set the CPU core bus frequency multiple is available only on unlocked CPUs. If you are using a locked CPU, setting the switches does not produce any effect.

The DSW switch tells the clock generator what frequency to send the CPU. This allows the selection of the CPU's external frequency (or bus clock). The bus clock multiplied by the frequency multiple equals the CPU's internal frequency (the advertised CPU speed).



The default CPU external frequency is 100MHz. If your CPU supports 200/166/133 MHz external frequency, adjust the DSW settings before installing the motherboard to the chassis.

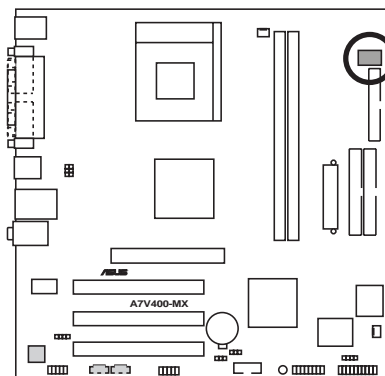

A7V400-MX CPU External Frequency Selection

DSW

	ON	ON	ON	ON
	1 2 3 4 5	1 2 3 4 5	1 2 3 4 5	1 2 3 4 5
CPU	200MHz	166.67MHz	133.33MHz	100MHz
AGP	66.67MHz	66.67MHz	66.67MHz	66.67MHz
PCI	33.33MHz	33.33MHz	33.33MHz	33.33MHz (Default)



Set the CPU frequency only to the recommended settings. Frequencies other than the recommended CPU bus frequencies are not guaranteed to be stable.

2. USB device wake-up (3-pin USBPWR12, USBPWR34, USBPWR56)

Set these jumpers to +5V to wake up the computer from S1 sleep mode (CPU stopped, DRAM refreshed, system running in low power mode) using the connected USB devices. Set to +5VSB to wake up from S3 sleep mode (no power to CPU, DRAM in slow refresh, power supply in reduced power mode). Both jumpers are set to pins 1-2 (+5V) by default because not all computers have the appropriate power supply to support this feature.

The USBPWR12 and USBPWR34 jumpers are for the rear USB ports. USBPWR56 is for the internal USB connector.



- The USB device wake-up feature requires a power supply that can provide 500mA on the +5VSB lead for each USB port. Otherwise, the system does not power up.
- The total current consumed must NOT exceed the power supply capability (+5VSB) whether under normal condition or in sleep mode.

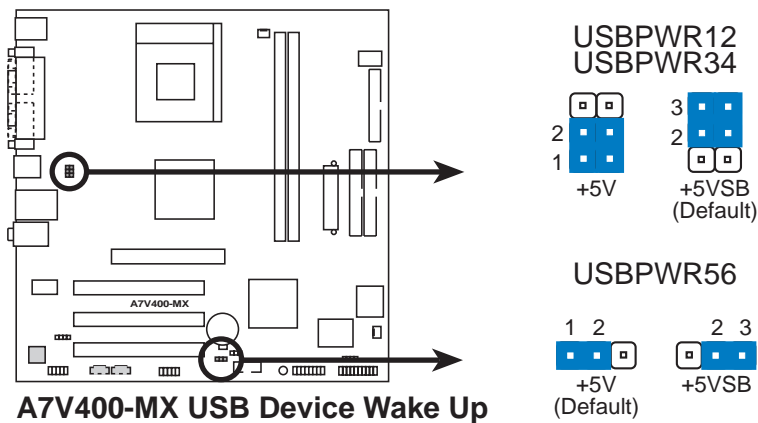

3. Clear RTC RAM (CLRTC)

This jumper clears the Real Time Clock (RTC) RAM of date, time and system setup parameters in CMOS. The RAM data in CMOS is powered by the onboard button cell battery.

To erase the RTC RAM:

1. Turn OFF the computer and unplug the power cord.
2. Remove the battery.
3. Move the jumper caps from [2-3] to [1-2] momentarily. Replace the jumper cap to the original position, [2-3].
4. Re-install the battery.
5. Plug the power cord and turn ON the computer.
6. Hold down the key during the boot process and enter BIOS setup to re-enter data.

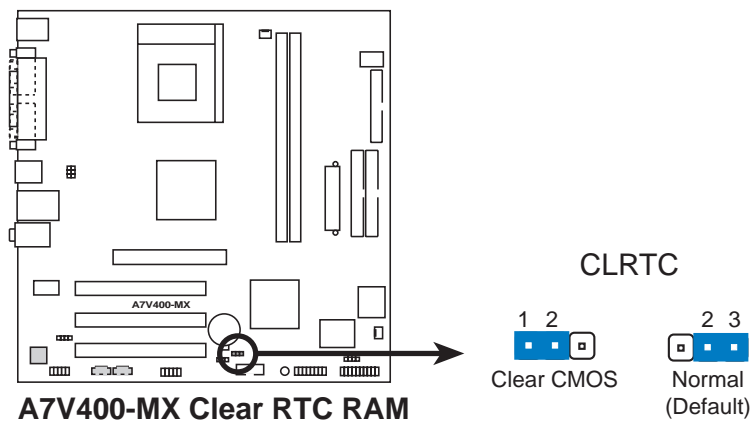

1.10 Connectors

This section describes and illustrates the rear panel and internal connectors on the motherboard.

1.10.1 Rear panel connectors

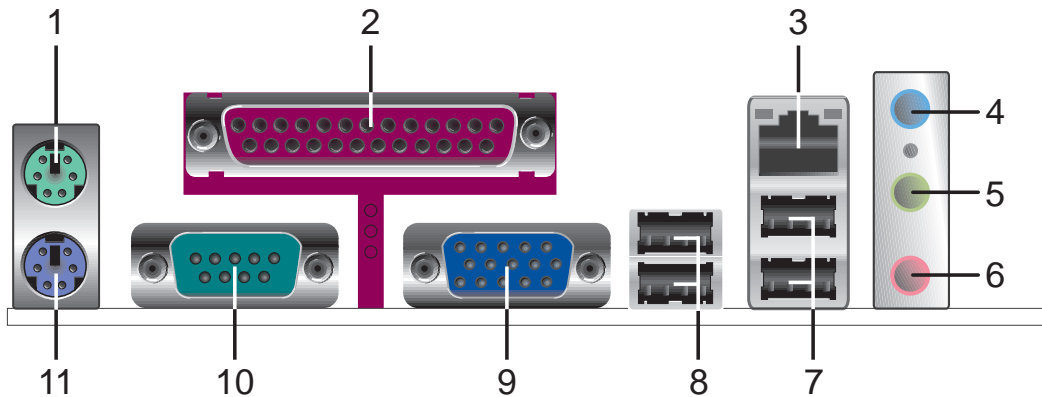

1. **PS/2 mouse port.** This green 6-pin connector is for a PS/2 mouse.
2. **Parallel port.** This 25-pin port connects a parallel printer, a scanner, or other devices.
3. **RJ-45 port.** This port allows connection to a Local Area Network (LAN) through a network hub.
4. **Line In port.** This Line In (light blue) port connects a tape player or other audio sources. In 6-channel mode, the function of this port becomes Bass/Center.
5. **Line Out port.** This Line Out (lime) port connects a headphone or a speaker. In 4/6-channel mode, the function of this port becomes Front Speaker Out.
6. **Microphone port.** This Mic (pink) port connects a microphone. In 4/6-channel mode, the function of this port becomes Rear Speaker.



The functions of the Line Out, Line In, and Microphone ports change when you select the 4 or 6-channel audio configuration as shown in the following table.

Audio ports function variation

Audio ports	Headphone/2-Channel	4-Channel	6-Channel
Light Blue	Line In	Line In	Bass/Center
Lime	Line Out	Front Speaker	Front Speaker
Pink	Mic In	Rear Speaker	Rear Speaker

7. **USB ports.** These two 4-pin Universal Serial Bus (USB) ports are available for connecting USB 2.0 devices.
8. **USB ports.** These two 4-pin Universal Serial Bus (USB) ports are available for connecting USB 2.0 devices.
9. **VGA port.** This port connects a VGA-compatible monitor.
10. **Serial port.** This 9-pin port connects a serial mouse, modem, and other serial devices.
11. **PS/2 keyboard port.** This purple connector is for a PS/2 keyboard.

1.10.2 Internal panel connectors

This section describes and illustrates the internal connectors

1. IDE connectors (40-1 pin PRI_IDE, SEC_IDE)

This connector supports the provided UltraATA133 IDE hard disk ribbon cable. Connect the cable's blue connector to the primary (recommended) or secondary IDE connector, then connect the gray connector to the UltraATA133 slave device (hard disk drive) and the black connector to the UltraATA133 master device.



- Pin 20 on each IDE connector is removed to match the covered hole on the UltraATA133 cable connector. This prevents incorrect orientation when you connect the cables.
- For UltraATA133 IDE devices, use 40-pin 80-conductor cable.

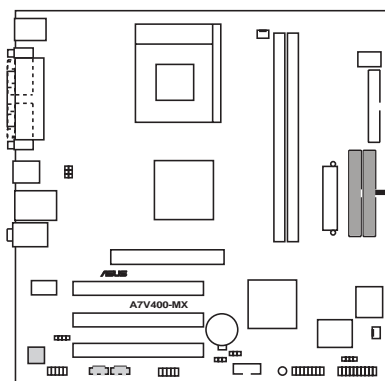

A7V400-MX IDE Connectors

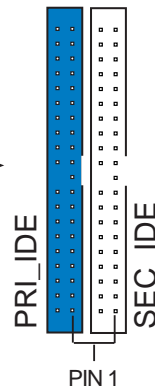

NOTE: Orient the red markings (usually zigzag) on the IDE ribbon cable to PIN 1.

2. Floppy disk drive connector (34-1 pin FLOPPY)

This connector supports the provided floppy drive ribbon cable. After connecting one end to the motherboard, connect the other end to the floppy drive. (Pin 5 is removed to prevent incorrect insertion when using ribbon cables with pin 5 plug.)

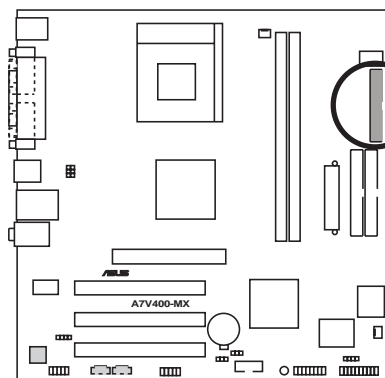

A7V400-MX Floppy Disk Drive Connector



FLOPPY

NOTE: Orient the red markings on the floppy ribbon cable to PIN 1.

3. Digital audio connector (4-1 pin SPDIF)

This connector is for an optional S/PDIF audio module that allows digital instead of analog sound input and output.

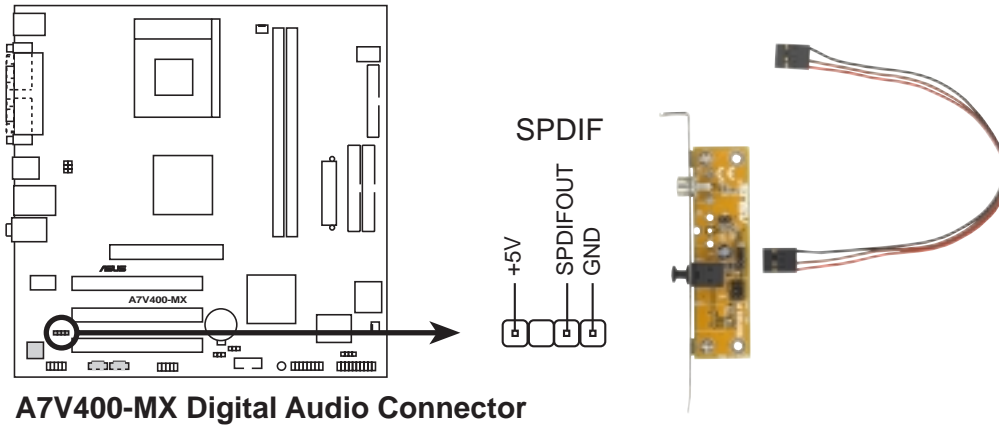

- When you input sound for S/PDIF IN, the LINE_OUT will output the sound. Mute LINE_OUT to impede sound output from S/PDIF IN.
- The S/PDIF module is purchased separately.

4. ATX power connector (20-pin ATXPWR)

This connects the power plug from the power supply. The power supply plug is designed to fit this connector in only one orientation. Find the proper orientation and push down firmly until the connector completely fits.

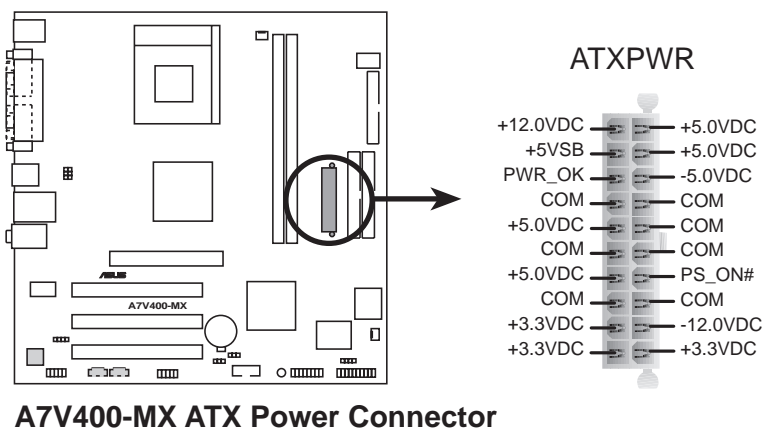

If you will need to replace the power supply in the future, make sure that your new ATX 12V power supply can provide 8A on the +12V lead and at least 1A on the +5-volt standby lead (+5VSB). The minimum recommended wattage is 230W, or 300W for a fully configured system. The system may become unstable and may experience difficulty powering up if the power supply is inadequate.

5. USB header (10-1 pin USB56)

If the rear panel USB 2.0 ports are inadequate, a USB header is available at midboard to accommodate two additional USB ports. You may connect the USB cable of a two-port USB/GAME module to this connector, then mount the module to an open slot in the chassis.

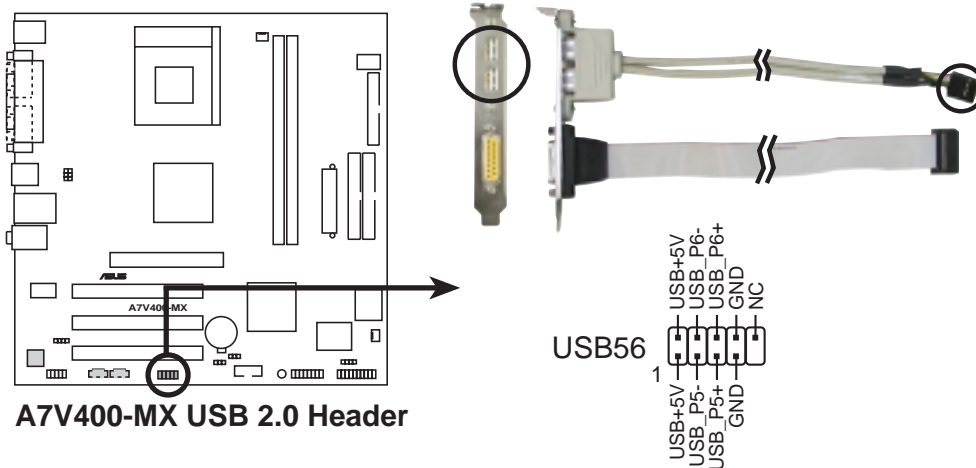

A7V400-MX USB 2.0 Header



The USB/GAME module is purchased separately.

6. GAME/MIDI connector (16-1 pin GAME)

This connector supports a GAME/MIDI module. If your package came with an optional USB/GAME module, connect the module cable to this connector, then mount the module to an open slot in the chassis. The GAME/MIDI port on the module connects a joystick or a game pad for playing games, and MIDI devices for playing or editing audio files.

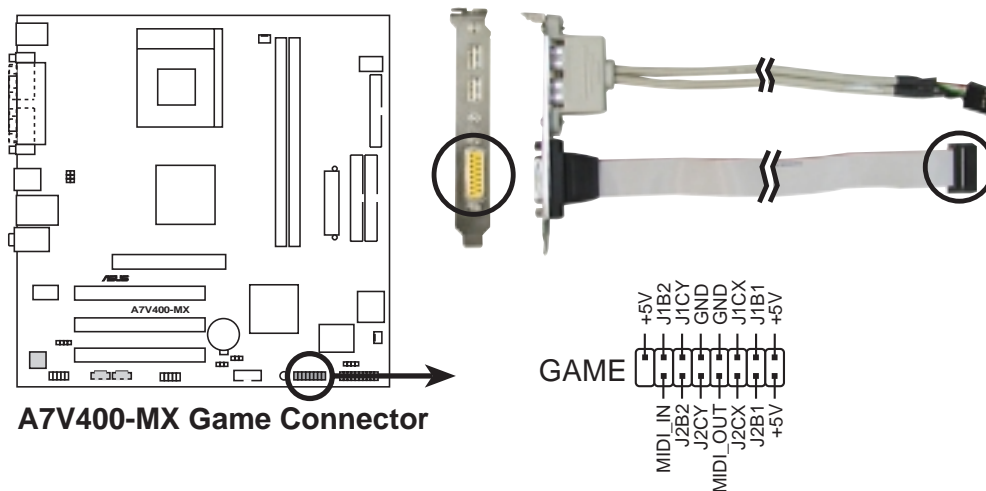

A7V400-MX Game Connector



The USB/GAME module is purchased separately.

7. CPU and chassis fan connectors (3-pin CPU_FAN, CHA_FAN)

The fan connectors support cooling fans of 350mA ~ 740mA (8.88W max). Connect the fan cables to the fan connectors on the motherboard, making sure that the black wire of each cable matches the ground pin of the connector.

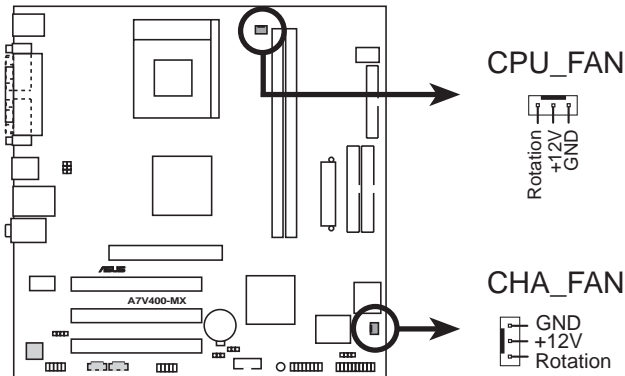

A7V400-MX 12-Volt Fan Connectors



Do not forget to connect the fan cables to the fan connectors. Lack of sufficient air flow within the system may damage the motherboard components. These are not jumpers! DO NOT place jumper caps on the fan connectors!

8. Chassis intrusion connector (4-1 pin CHASSIS)

This lead is for a chassis designed with intrusion detection feature. This requires an external detection mechanism such as a chassis intrusion sensor or microswitch. When you remove any chassis component, the sensor triggers and sends a high-level signal to this lead to record a chassis intrusion event.

By default, the pins labeled “Chassis Signal” and “Ground” are shorted with a jumper cap. If you wish to use the chassis intrusion detection feature, remove the jumper cap from the pins.

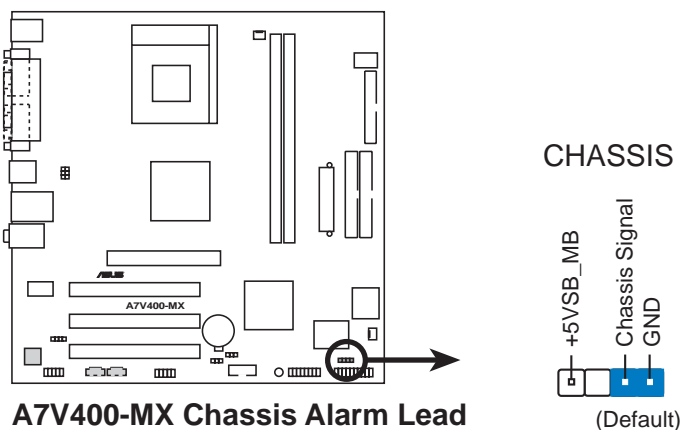

9. Serial connector (10-1 pin COM2)

This connector accommodates a second serial port using an optional serial port module. Connect the COM2 module cable to this connector then install the module to a slot opening at the back of the system chassis.

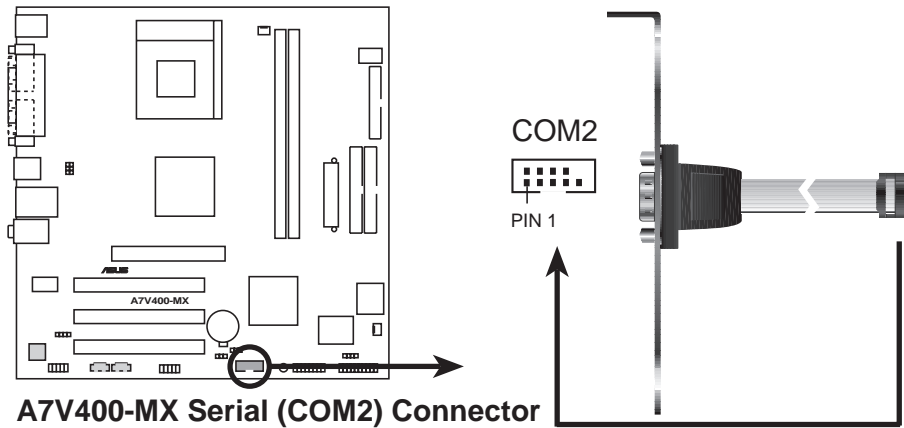

A7V400-MX Serial (COM2) Connector



The serial port module is purchased separately.

10. Internal audio connectors (4-pin CD, AUX)

These connectors allow you to receive stereo audio input from sound sources such as a CD-ROM, TV tuner, or MPEG card.

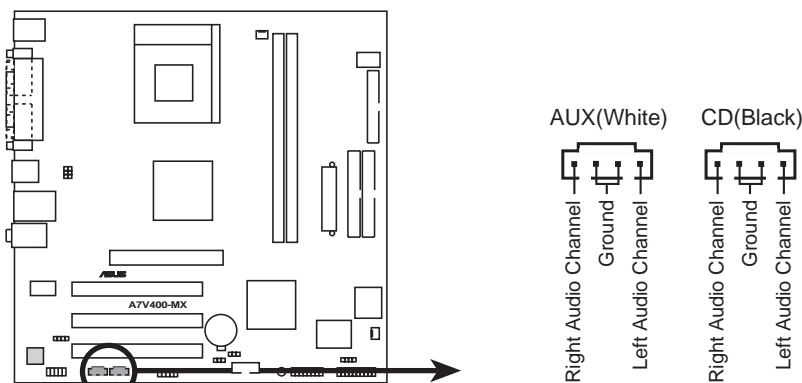

A7V400-MX Internal Audio Connectors

11. Front panel audio connectors (10-1 pin FP_AUDIO)

This is an interface for front panel audio cable that allows convenient connection and control of audio devices.

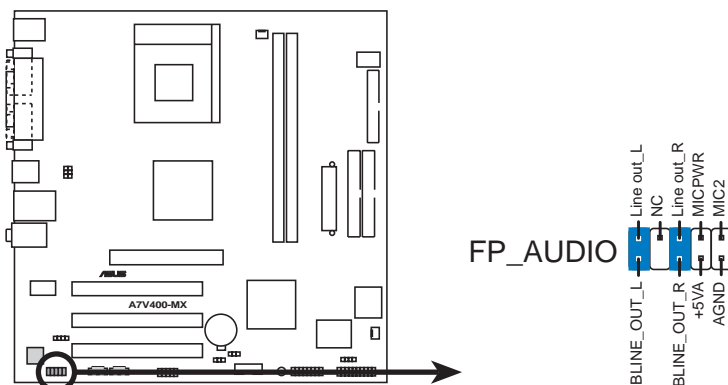

A7V400-MX Front Panel Audio Connector

12. System panel connector (20-pin PANEL)

This connector accommodates several system front panel functions.

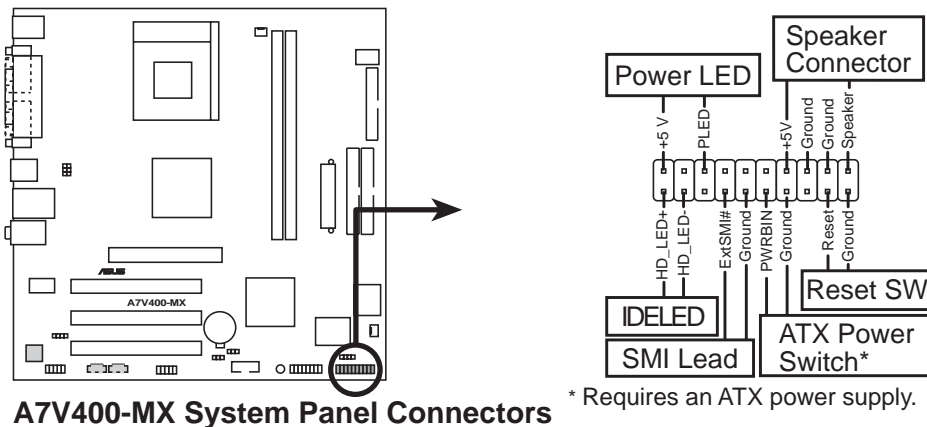

- **System Power LED Lead (3-1 pin PLED)**

This 3-1 pin connector connects to the system power LED. The LED lights up when you turn on the system power, and blinks when the system is in sleep mode.

- **System Warning Speaker Lead (4-pin SPEAKER)**

This 4-pin connector connects to the case-mounted speaker and allows you to hear system beeps and warnings.

- **System Management Interrupt Lead (2-pin SMI)**

This 2-pin connector allows you to manually place the system into a suspend mode, or “green” mode, where system activity is instantly decreased to save power and to expand the life of certain system components. Attach the case-mounted suspend switch to this 2-pin connector.

- **Reset Switch (2-pin RESET)**

This 2-pin connector connects to the case-mounted reset switch for rebooting the system without turning off the power switch.

- **ATX Power Switch/Soft-Off Switch Lead (2-pin PWR)**

This connector connects a switch that controls the system power. Pressing the power switch turns the system between ON and SLEEP, or ON and SOFT OFF, depending on the BIOS or OS settings. Pressing the power switch while in the ON mode for more than four seconds turns the system OFF.

- **Hard Disk Activity Lead (2-pin IDE LED)**

This connector supplies power to the hard disk activity LED. The read or write activities of any device connected to the primary or secondary IDE connector cause this LED to light up.

Chapter 2

This chapter tells how to change system settings through the BIOS Setup Menus. Detailed descriptions of the BIOS parameters are also provided.

BIOS information

2.1 Managing and updating your BIOS

The following utilities allow you to manage and update the motherboard Basic Input/Output System (BIOS) setup.

1. **AwardBIOS Flash Utility** (*Updates the BIOS in DOS mode using a bootable floppy disk.*)
2. **ASUS CrashFree BIOS** (*Updates the BIOS using a floppy disk during POST.*)
3. **ASUS Update** (*Updates the BIOS in Windows® environment.*)

Refer to the corresponding sections for each utility.



-
- The **original BIOS file** for this motherboard is in the support CD.
 - Copy the original BIOS to a **bootable floppy disk** in case you need to restore the BIOS in the future.
-

2.1.1 Creating a bootable floppy disk

1. Do either one of the following to create a bootable floppy disk.

DOS environment

Insert a 1.44 MB floppy disk into the drive. At the DOS prompt, type:

format a: /s , then press the <Enter> key

Windows® XP environment

- a. Insert a new 1.44 MB floppy disk in the floppy disk drive.
 - b. From the Windows desktop, click **Start > My Computer**.
 - c. In the **My Computer** window, click the **3 1/2 Floppy** icon.
 - d. From the Menu bar, click **File > Format**.
 - e. Select “**Create an MS-DOS Startup Disk**” in the **Format Options** field, then click **Start**.
2. Copy the original (or the latest) motherboard BIOS to the bootable floppy disk.

2.1.2 Using the AwardBIOS Flash Utility

You may update the Basic Input/Output System (BIOS) using the built-in Award BIOS Flash utility or using a bootable floppy disk with the executable Award BIOS Flash utility (AWDFLASH.EXE). Follow these instructions to update the BIOS using this utility.

1. Download the latest BIOS file from the website provided by the system builder. Rename the file to *.BIN, then save it to the bootable floppy disk you created earlier.
2. Insert the disk that contains the new BIOS file to the floppy drive.



Save only the updated BIOS file in the floppy disk to avoid loading a wrong BIOS file.

3. Reboot the computer.
4. Press <Alt> + <F2> during POST to display the following screen. AWDFLASH checks the new BIOS file on the floppy disk.

```
AwardBIOS Flash Utility V8.24B
(C)Phoenix Technologies Ltd. All Rights Reserved
For KM400-8235-6A6LYA0AC-00   DATE: 05/19/2003
Flash Type - SST-39SF020 /5V
File Name to Program : aw0702.bin
Message: Please Wait!
```

5. After verification, AWDFLASH flashes the new BIOS file. Do not shut down the computer during the flash process. The computer returns to POST after the new BIOS file is copied.

```
AwardBIOS Flash Utility V8.24B
(C)Phoenix Technologies Ltd. All Rights Reserved
For KM400-8235-6A6LYA0AC-00   DATE: 05/19/2003
Flash Type - SST-39SF020 /5V
File Name to Program : aw0702.bin
Program Flashing Memory
[Progress Bar]
Write OK  No Update  Write fail
Warning: Don't Turn Off Power Or Reset System!
```

Updating the BIOS using a bootable floppy disk

1. Boot from the floppy disk.
2. At the "A:\>" prompt, type "C:\>" and then press <Enter>.
3. At the "C:\>" prompt, type "AWDFLASH BIOSFILENAME" and then <Enter>. For example: "AWDFLASH aw0702.bin" The AWDFLASH screen appears.
4. Follow steps 4 to 5 of the previous section.

2.1.3 CrashFree BIOS feature

The CrashFree BIOS feature allows you to boot the computer from a floppy disk and update the BIOS in case the original BIOS fails or gets corrupted.



-
- You must have a bootable floppy disk ready before updating the BIOS.
 - The bootable floppy disk could be the one that you created following the procedure in section 2.1.1, and should contain the AWDFLASH.EXE utility.
 - A message appears during POST to indicate that the BIOS fails (ROM data or codes are corrupted).
-

To update the BIOS:

1. Turn on the computer.
2. When prompted, place the bootable floppy disk to the floppy drive.
2. Follow the BIOS update procedure in section “2.1.2 Using the Award BIOS Flash Utility.”



To use the CrashFree BIOS feature on this motherboard, install a VGA card into one of the expansion slots before rebooting the computer. On motherboards with onboard VGA, you will not see the screen display when the BIOS crashes even if you reboot the computer.

2.1.4 ASUS Update

The ASUS Update is a utility that allows you to update the motherboard BIOS in Windows® environment. This utility is available in the support CD that comes with the motherboard package. ASUS Update requires an Internet connection either through a network or an Internet Service Provider (ISP).

To install ASUS Update:

1. Place the support CD to the optical drive. The **Drivers** menu appears.
2. Click the **Utilities** tab, then click **Install ASUS Update VX.XX.XX**. See page 3-3 for the **Utilities** menu screen.
3. The ASUS Update utility is copied into your system.

To update the BIOS using the ASUS Update:

1. Launch the utility from the Windows desktop by clicking **Start > Programs > ASUS > ASUSUpdate > ASUSUpdate**. The ASUS Update initial screen appears.

2. Select your desired update method, then click **Next**.

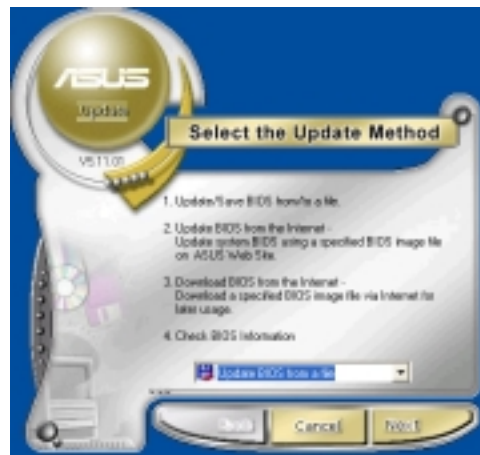

3. If you selected updating/downloading from the Internet, select the ASUS FTP site nearest you to avoid network traffic, or choose **Auto Select**. Click **Next**.



4. From the FTP site, select the BIOS version that you wish to download. Click **Next**.
5. Follow screen instructions to complete the update process.

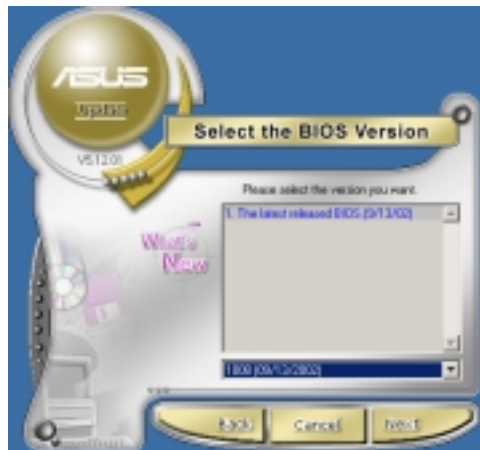

If you selected the option to update the BIOS from a file, an **Open** window appears prompting you to locate the BIOS file. Select the file, click **Open**, then follow the screen instructions to complete the update process.

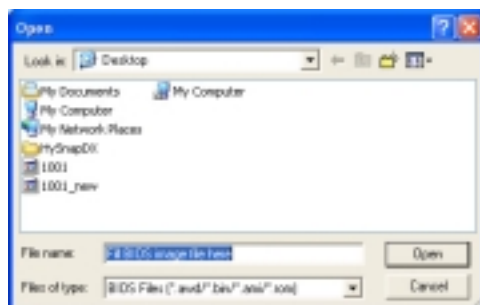

2.2 BIOS beep codes

When you turn the power on and the system runs POST (Power On Self Tests), you will hear BIOS beeps. Refer to the following table for the meaning of the beeps.

Award BIOS beep codes

Beep	Meaning
One short beep when displaying logo	No error during POST
Long beeps in an endless loop	No DRAM installed or detected
One long beep followed by three short beeps	Video card not found or video card memory bad
High frequency beeps when system is working	CPU overheated; System running at a lower frequency

2.3 BIOS Setup program

This motherboard supports a programmable Low Pin Count (LPC) chip that you can update using the provided utility described in section “2.1 Managing and updating your BIOS.”

Use the BIOS Setup program when you are installing a motherboard, reconfiguring your system, or prompted to “Run Setup”. This section explains how to configure your system using this utility.

Even if you are not prompted to use the Setup program, you may want to change the configuration of your computer in the future. For example, you may want to enable the security password feature or make changes to the power management settings. This requires you to reconfigure your system using the BIOS Setup program so that the computer can recognize these changes and record them in the CMOS RAM of the LPC chip.

The LPC chip on the motherboard stores the Setup utility. When you start up the computer, the system provides you with the opportunity to run this program. Press <Delete> during the Power-On Self Test (POST) to enter the Setup utility, otherwise, POST continues with its test routines.

If you wish to enter Setup after POST, restart the system by pressing <Ctrl> + <Alt> + <Delete>, or by pressing the reset button on the system chassis. You can also restart by turning the system off and then back on. Do this last option only if the first two failed.

The Setup program is designed to make it as easy to use as possible. It is a menu-driven program, which means you can scroll through the various sub-menus and make your selections among the predetermined choices.



Because the BIOS software is constantly being updated, the following BIOS setup screens and descriptions are for reference purposes only, and may not exactly match what you see on your screen.

2.3.1 BIOS menu bar

The top of the screen has a menu bar with the following selections:

MAIN	Use this menu to make changes to the basic system configuration.
ADVANCED	Use this menu to enable and make changes to the advanced features.
POWER	Use this menu to configure and enable Power Management features.
BOOT	Use this menu to configure the default system device used to locate and load the Operating System.
EXIT	Use this menu to exit the current menu or to exit the Setup program.

To access the menu bar items, press the right or left arrow key on the keyboard until the desired item is highlighted.

2.3.2 Legend bar

At the bottom of the Setup screen is a legend bar. The keys in the legend bar allow you to navigate through the various setup menus. The following table lists the legend bar keys and their corresponding functions.

Navigation Key	Function
<F1>	Displays the General Help screen
<F2>	Navigates the Item Specific Help screen
<F5>	Loads previous values
<Esc>	Jumps to the Exit menu or returns to the main menu from a sub-menu
Left or Right arrow	Selects the menu item to the left or right
Up or Down arrow	Moves the highlight up or down between fields
Page Down or – (minus)	Scrolls backward through the values for the highlighted field
Page Up or + (plus)	Scrolls forward through the values for the highlighted field
<Enter>	Brings up a selection menu for the highlighted field
<F10>	Saves changes and exit

General help

In addition to the Item Help window, the BIOS setup program also provides a General Help screen. You may launch this screen from any menu by simply pressing <F1>. The General Help screen lists the legend keys and their corresponding functions.

Saving changes and exiting the Setup program

See “2.8 Exit menu” for detailed information on saving changes and exiting the setup program.

Scroll bar

When a scroll bar appears to the right of a help window, it indicates that there is more information to be displayed that will not fit in the window. Use <PgUp> and <PgDn> or the up and down arrow keys to scroll through the entire help document. Press <Home> to display the first page, press <End> to go to the last page. To exit the help window, press <Enter> or <Esc>.

Sub-menu

The right pointer symbol that appears at the left of certain parameters indicates that a sub-menu exists for this field. A sub-menu offers additional parameter options. To display a sub-menu, move the highlight to the field and press <Enter>. The sub-menu appears. Use the legend keys to navigate and enter values within each sub-menu as you would within a menu. Use the <Esc> key to return to the main menu. Take some time to familiarize yourself with the legend keys and their corresponding functions. Practice navigating through the various menus and sub-menus. While moving around through the Setup program, note that explanations appear in the **Item Help** window located to the right of each menu. This window displays the help text for the highlighted field.

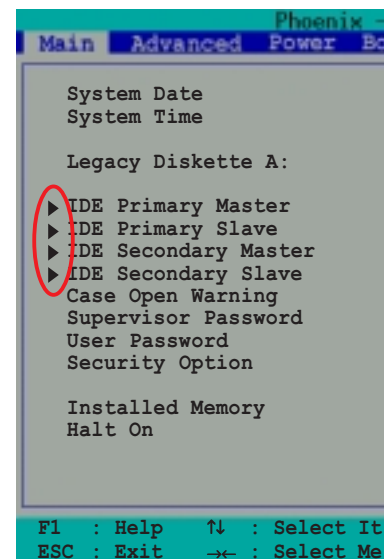

2.4 Main menu

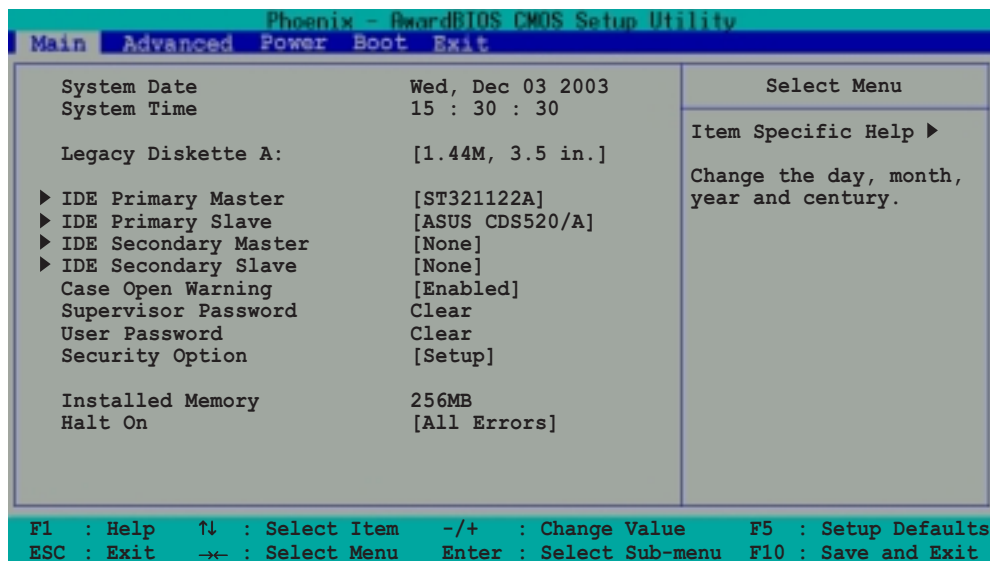

System Date [day, mm dd yyyy]

Sets the system to the date that you specify (usually the current date). The format is month, day, year. Valid values for month, day, and year are Month: (1 to 12), Day: (1 to 31), Year: (1999 to 2099). Use the <Tab> key to move between the month, day, and year fields.

System Time [hh:mm:ss]

Sets the system to the time that you specify (usually the current time). The format is hour, minute, second. Valid values for hour, minute and second are Hour: (00 to 23), Minute: (00 to 59), Second: (00 to 59). Use the <Tab> key to move between the hour, minute, and second fields.

Legacy Diskette A [1.44M, 3.5 in.]

Sets the type of floppy drive installed. Configuration options: [None] [360K, 5.25 in.] [1.2M, 5.25 in.] [720K, 3.5 in.] [1.44M, 3.5 in.] [2.88M, 3.5 in.]

Case Open Warning [Enabled]

Enable this option to activate the chassis intrusion feature of the motherboard. Configuration options: [Enabled] [Disabled]

Supervisor Password [Clear] / User Password [Clear]

These fields allow you to set passwords. To set a password, highlight the appropriate field and press <Enter>. Type in a password then press <Enter>. You can type up to eight alphanumeric characters. Symbols and other characters are ignored. To confirm the password, type the password again and press <Enter>. The password is now set to [Set]. This password allows full access to the BIOS Setup menus. To clear the password, highlight this field and press <Enter>. When the same dialog box appear, press <Enter>. The password is set to [Clear].

A note about passwords

The BIOS Setup program allows you to specify passwords in the Main menu. The passwords control access to the BIOS during system startup. Passwords are not case sensitive, meaning, passwords typed in either uppercase or lowercase letters are accepted. The BIOS Setup program allows you to specify two different passwords: a Supervisor password and a User password. If you did not set a Supervisor password, anyone can access the BIOS Setup program. If you did, the Supervisor password is required to enter the BIOS Setup program and to gain full access to the configuration fields.

Forgot the password?

If you forget your password, you can clear it by erasing the CMOS Real Time Clock (RTC) RAM. The RAM data containing the password information is powered by the onboard button cell battery. If you need to erase the CMOS RAM, unplug the all the power cables and remove the button cell battery. Re-install the battery after about 2 seconds, then power up the system. Refer to section "1.11 Switch and Jumpers - Clear RTC RAM" on how to erase CMOS RTC RAM.

Security Option [Setup]

This field requires users to enter the password before entering the BIOS setup or the system. Select [Setup] to require the password before entering the BIOS Setup. Select [System] to require the password before entering the system. Configuration options: [Setup] [System]

Installed Memory [XXX MB]

This field automatically displays the amount of conventional memory detected by the system during the boot process.

Halt On [All Errors]

This field sets the system to halt on errors according to the system functions specified in each option. Configuration options: [All Errors] [No Errors] [All, But Keyboard] [All, But Diskette] [All, But Disk/Key]

IDE Primary Master/Slave

IDE Secondary Master/Slave

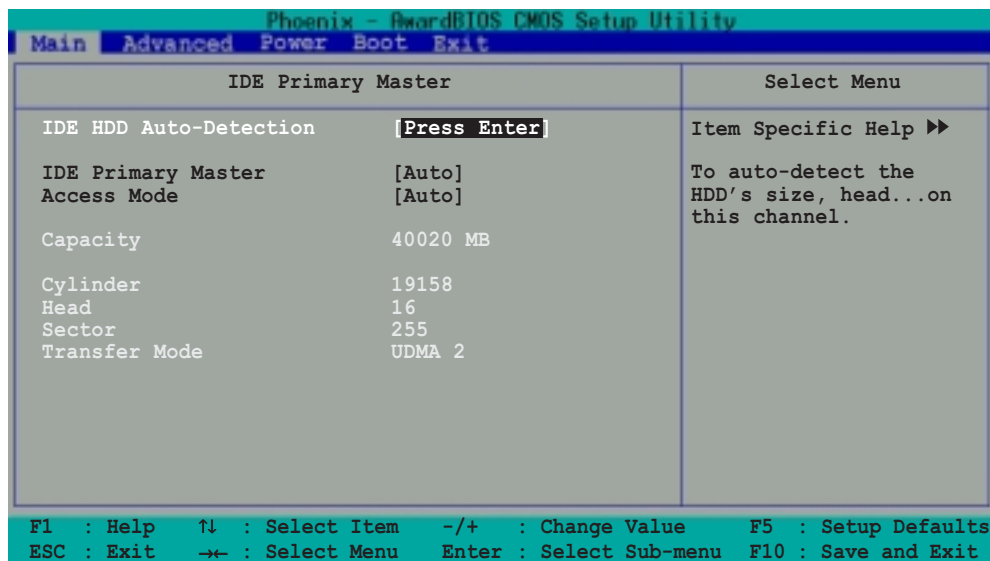

IDE HDD Auto-Detection [Press Enter]

Press enter to automatically detect an IDE hard disk drive, if the hard drive is not already detected. In cases of undetected HDDs, pressing enter will detect the HDD and then open access to both the IDE Primary Master and Access Mode fields.

IDE Primary Master/Slave [Auto]

IDE Secondary Master/Slave [Auto]

Select [Auto] to automatically detect an IDE hard disk drive. If automatic detection is successful, the setup BIOS automatically fills in the correct values for the remaining fields on this sub-menu. If automatic detection fails, this may be because the hard disk drive is too old or too new. If the hard disk was already formatted on a previous system, the setup BIOS may detect incorrect parameters. In these cases, select [Manual] to manually enter the IDE hard disk drive parameters. If no drive is installed or if you are removing a drive and not replacing it, select [None]. Configuration options: [None] [Auto] [Manual]

Access Mode [Auto]

The default [Auto] automatically detects an IDE hard disk drive. Select [CHS] in coordination with the [Manual] setting of the IDE Primary Master in order to enter the hard disk drive values manually.



Before attempting to configure a hard disk drive, make sure you have the correct configuration information supplied by the drive manufacturer. Incorrect settings may cause the system to fail to recognize the installed hard disk.

[Manual] & [CHS] Settings

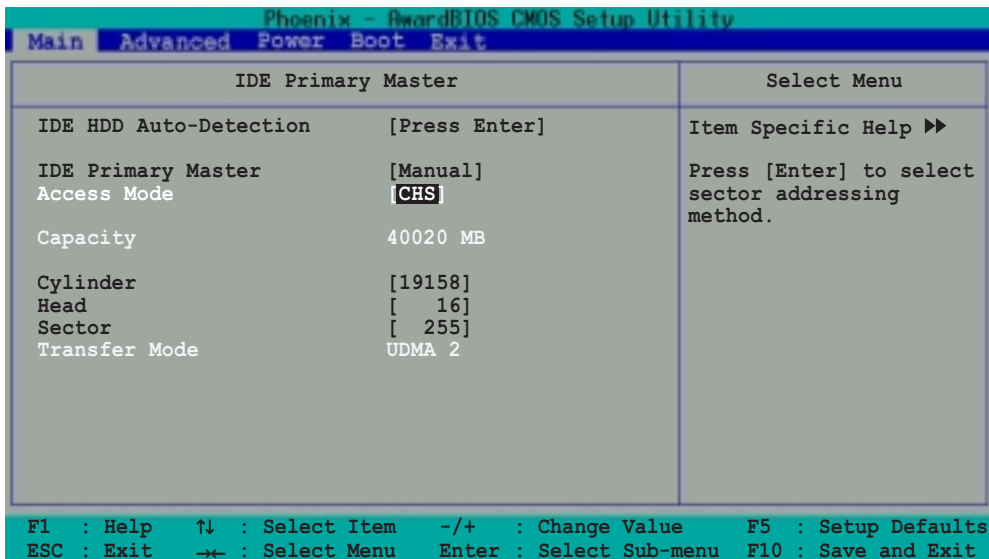

Manually enter the number of cylinders, heads and sectors per track for the drive. Refer to the drive documentation or the drive label for this information.



After entering the IDE hard disk drive information into BIOS, use a disk utility, such as FDISK, to partition and format new IDE hard disk drives. This is necessary so that you can write or read data from the hard disk. Make sure to set the partition of the Primary IDE hard disk drives to active.

After making your selections on this sub-menu, press the <Esc> key to return to the Main menu. The Main menu displays the hard disk drive field with your configuration.

Access Mode [Auto]

Select the hard disk drive type in this field. When Logical Block Addressing (LBA) is enabled, the 28-bit addressing of the hard drive is used without regard for cylinders, heads, or sectors. Note that LBA Mode is necessary for drives with more than 504MB storage capacity. Select [CHS] to make manual entries for configuring the fields below. Configuration options: [CHS] [LBA] [Large] [Auto]

Capacity

Displays the hard disk drive capacity in MB or GB. This item is non-configurable.

Cylinder

This field configures the number of cylinders. Refer to the drive documentation to determine the correct value. To make changes to this field, set the IDE Primary Master field to [Manual] and the Access Mode to [CHS].

Head

This field configures the number of read/write heads. Refer to the drive documentation to determine the correct value. To make changes to this field, set the IDE Primary Master field to [Manual] and the Access Mode to [CHS].

Sector

This field configures the number of sectors per track. Refer to the drive documentation to determine the correct value. To make changes to this field, set the Type field to [User Type HDD] and the Translation Method field to [Manual].

Transfer Mode

This field selects the UDMA transfer mode. Configuration options: [Auto] [UDMA0] [UDMA1] [UDMA2] [UDMA3] [UDMA4] [UDMA5]

2.5 Advanced menu

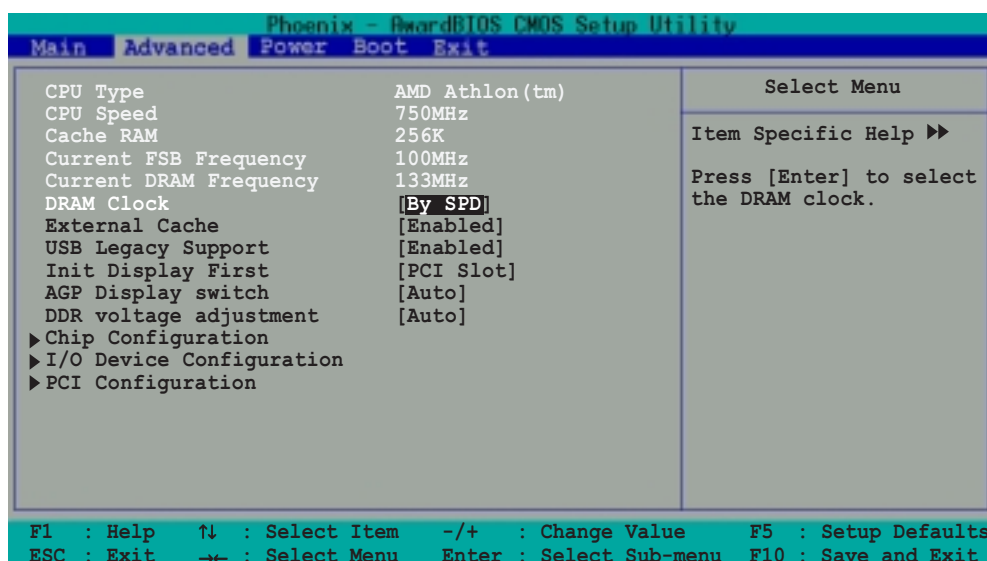

The Advanced menu displays the CPU type, speed, cache RAM, front side bus frequency and DRAM frequency information. It also contains the following BIOS parameters.

DRAM Clock [By SPD]

The DRAM clock are set according to the DRAM SPD (Serial Presence Detect). You can manually set the DRAM clock parameters. Configuration options: [By SPD] [133] [166]

External Cache [Enabled]

These fields allow you enable or disable the built-in CPU internal and external cache. Configuration options: [Disabled] [Enabled]

USB Legacy Support [Enabled]

This motherboard supports Universal Serial Bus (USB) devices. When enabled, this item allows the system to detect a USB device at startup. When you set this field to [Disabled], the USB controller legacy mode is disabled whether or not you are using a USB device. Configuration options: [Disabled] [Enabled]

Init Display First [PCI Slot]

This option allows you to select the primary VGA type if your system has multiple video controllers. Configuration options: [PCI Slot] [AGP]

AGP Display switch [Auto]

This option allows you to set the AGP display control to [Auto] or through the onboard AGP controller. Configuration options: [Auto] [Onchip AGP]

DDR voltage adjustment [Auto]

This option allows you to adjust the DDR voltage.
Configuration options: [2.6V] [2.5V] [Auto]

2.5.1 Chip Configuration

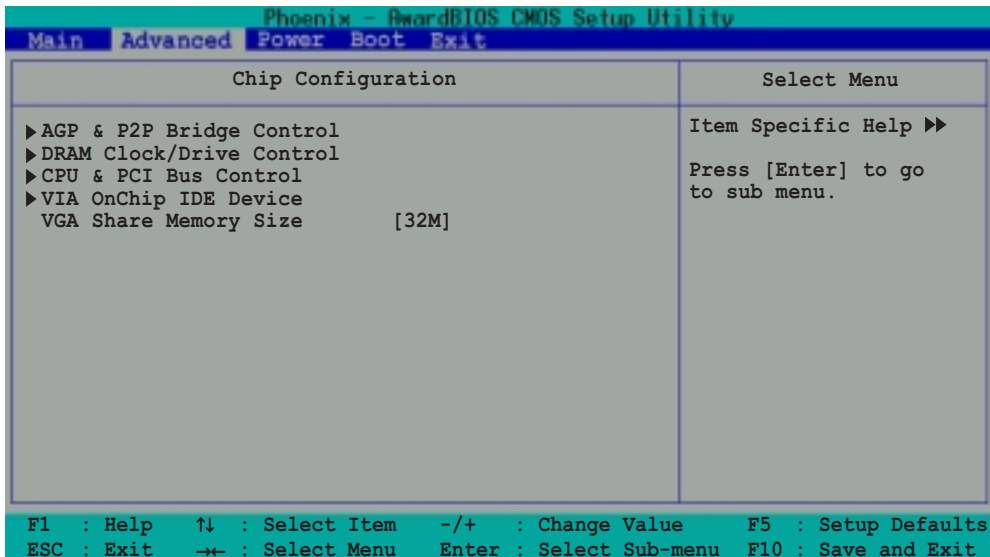

VGA Share Memory Size [32M]

This option allows you to adjust the share memory size for the onboard VGA.
Configuration options: [16M] [32M] [64M]

AGP & P2P Bridge Control

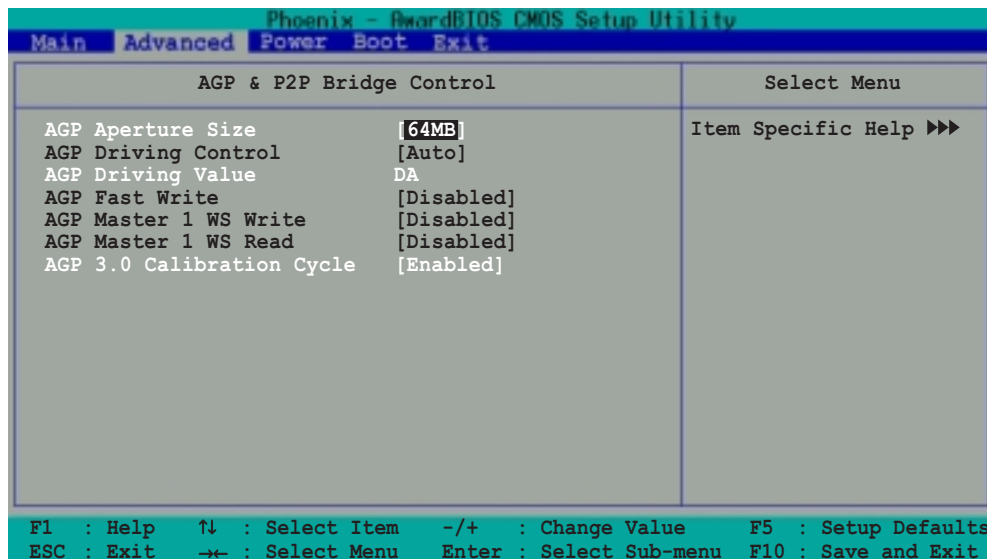

AGP Aperture Size [XXXMB]

This field sets the size of mapped memory for AGP graphic data.

Configuration options: [256M] [128M] [64M] [32M] [16M] [8M] [4M][1G] [512M]

AGP Driving Control [Auto]

This option allows you to automatically select or manually assign the AGP Driving Value. Configuration options: [Auto] [Manual]

AGP Driving Value [DA]

This item is enabled when you set the AGP Driving Control to [Manual]. Press <Enter> to assign a hexadecimal AGP Driving Value.

Configuration options: [Min = 0000, Max = 00FF]

AGP Fast Write [Disabled]

This field enables or disables the AGP Fastwrite function.

Configuration options: [Disable] [Enabled]

AGP Master 1 WS Write [Disabled]

Configuration options: [Disable] [Enabled]

AGP Master 1 WS Read [Disabled]

Configuration options: [Disable] [Enabled]

AGP 3.0 Calibration Cycle [Enabled]

Configuration options: [Disable] [Enabled]

DRAM Clock/Drive Control

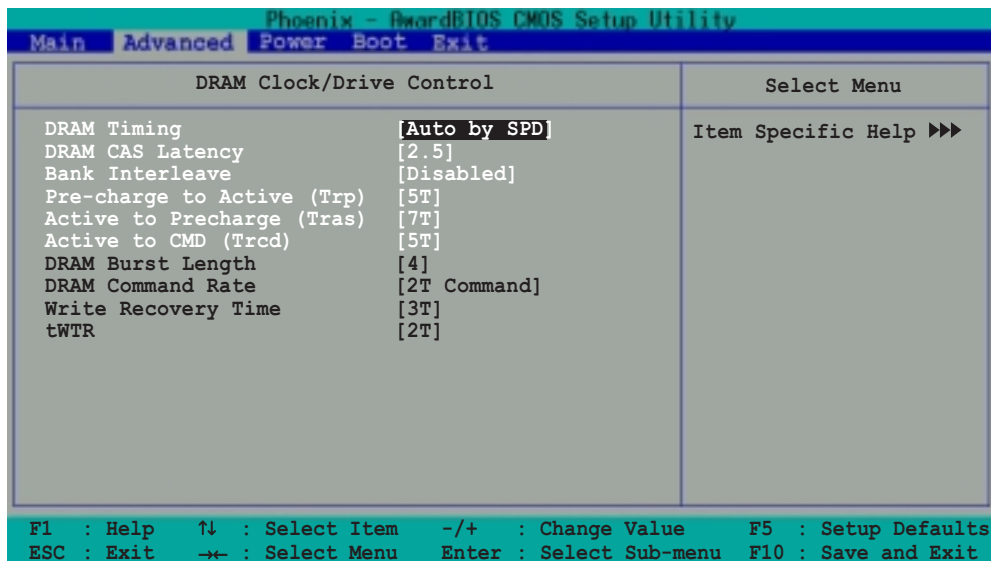

DRAM Timing [Auto by SPD]

It is recommended that you set this parameter to [Auto by SPD]. Setting to [Auto by SPD] synchronizes the DRAM timing with the DRAM clock. Setting to [Manual] allows you to set the values for DRAM CAS Latency, Bank Interleave, Pre-charge to Active (TRP) and Active to CMD (Trcd) parameters.

Configuration options: [Manual] [Auto By SPD] [Safe]

DRAM CAS Latency [2.5]

This field sets the override clock cycle for the latency time between the DRAM read command and the moment that the data actually becomes available. Normally, the system determines the rate automatically by default.

Configuration options: [1.5] [2] [2.5] [3]

Bank Interleave [Disabled]

Configuration options: [Disabled] [2 Bank] [4 Bank]

Precharge to Active (Trp) [5T]

Configuration options: [2T] [3T] [4T] [5T]

Active to Precharge (Tras) [7T]

Configuration options: [6T] [7T] [8T] [9T]

Active to CMD (Trcd) [5T]

Configuration options: [2T] [3T] [4T] [5T]

DRAM Burst Length [4]

Configuration options: [4] [8]

DRAM Command Rate [2T Command]

Configuration options: [2T Command] [1T Command]

Write Recovery Time [3T]

Configuration options: [2T] [3T]

tWTR [2T]

Configuration options: [1T] [2T]

CPU & PCI Bus Control

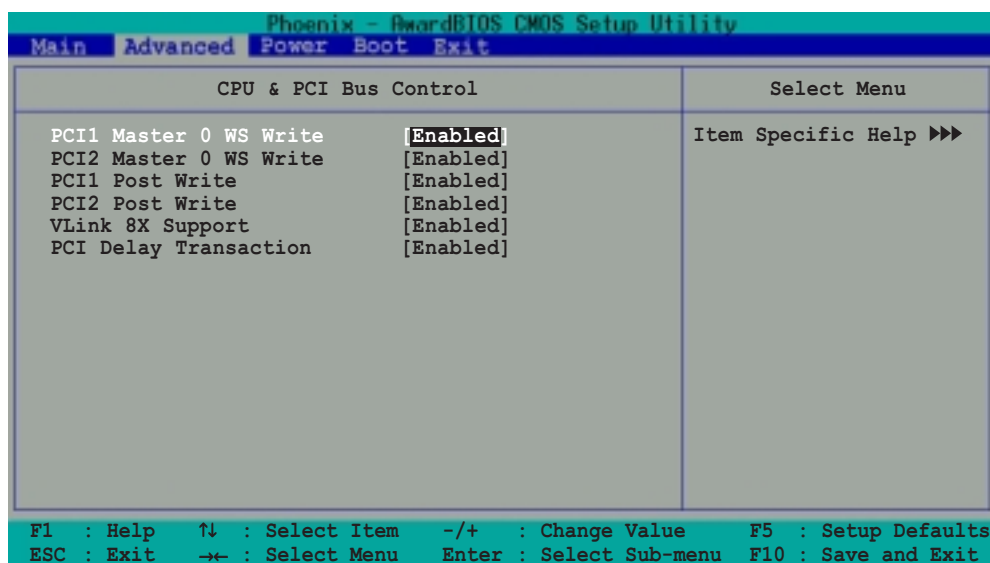

PCI1 Master 0 WS Write [Enabled]

PCI2 Master 0 WS Write [Enabled]

Configuration options: [Enabled] [Disabled]

PCI1 Post Write [Enabled]

PCI2 Post Write [Enabled]

Configuration options: [Disabled] [Enabled]

VLink 8X Support [Enabled]

This option enables or disables the VLink 8X feature of the motherboard. The VLink 8X technology allows high bandwidth connection between the North bridge and South bridge chipsets. Configuration options: [Disabled] [Enabled]

PCI Delay Transaction [Enabled]

When set to [Enabled], this feature frees the PCI bus when the CPU is accessing 8-bit ISA cards. This process consumes 50-60 PCI clocks without PCI delayed transaction. Set this field to [Disabled] when using ISA cards that are not PCI 2.2 compliant. Configuration options: [Disabled] [Enabled]

VIA OnChip IDE Device

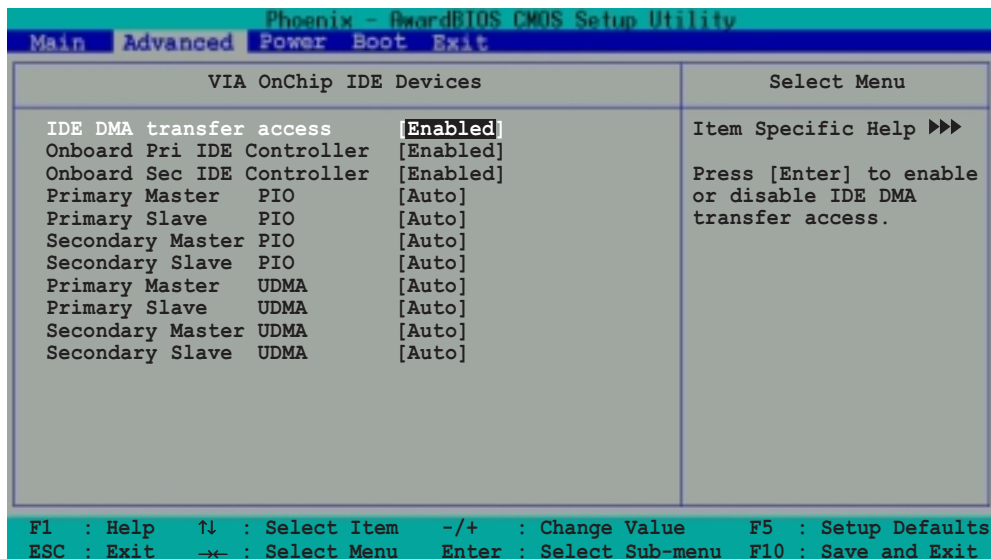

IDE DMA Transfer Access [Enabled]

This option allows you to enable the IDE DMA transfer access.

Configuration options: [Disabled] [Enabled]

Onboard Pri IDE Controller [Enabled]

Onboard Sec IDE Controller [Enabled]

This option allows you to enable the onboard IDE controllers.

Configuration options: [Disabled] [Enabled]

Primary Master PIO [Auto]

Primary Slave PIO [Auto]

This option lets you set a PIO (Programmable Input/Output) mode for Primary IDE devices. Configuration options: [Auto] [Mode 0] [Mode 1] [Mode 2] [Mode 3] [Mode4]

Secondary Master PIO [Auto]

Secondary Slave PIO [Auto]

This option lets you set a PIO (Programmable Input/Output) mode for Secondary IDE devices. Configuration options: [Auto] [Mode 0] [Mode 1] [Mode 2] [Mode 3] [Mode 4]

Primary Master/Slave UDMA [Auto]

Secondary Master/Slave UDMA [Auto]

UltraDMA capability allows improved transfer speeds and data integrity for compatible IDE devices. Set to Auto to for automatic configuration.

Configuration options: [Disabled] [Auto]

2.5.2 I/O Device Configuration

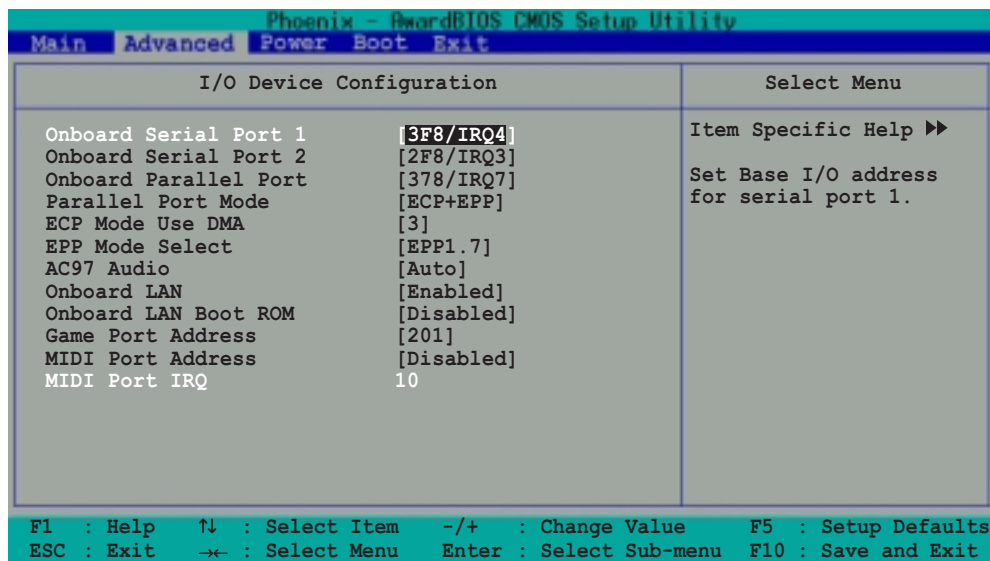

Onboard Serial Port 1 [3F8/IRQ4]

These fields allow you to set the interrupt address of the serial port. Configuration options: [Disabled] [3F8/IRQ4] [2F8/IRQ3] [3E8/IRQ4] [2E8/IRQ3] [Auto]

Onboard Serial Port 2 [2F8/IRQ3]

These fields allow you to set the address for the onboard serial connector. Configuration options: [Disabled] [3F8/IRQ4] [2F8/IRQ3] [3E8/IRQ4] [2E8/IRQ3] [Auto]

Onboard Parallel Port [378/IRQ7]

This field allows you to set the address of the onboard parallel port connector. Configuration options: [Disabled] [378/IRQ7] [278/IRQ5] [3BC/1RQ7]

Parallel Port Mode [ECP+EPP]

This field allows you to set the parallel port operation mode. Setting to [SPP] allows normal speed operation but in one direction only. [EPP] allows bi-directional parallel port operation. [ECP] allows bi-directional DMA mode operation, while [ECP+EPP] allows normal speed operation in a two-way mode. Configuration options: [SPP] [EPP] [ECP] [ECP+EPP]

ECP Mode Use DMA [3]

This field sets the parallel port DMA channel for the selected ECP mode. The default setting is 3. This selection is available only if you select [ECP] or [ECP+EPP] in the Parallel Port Mode item. Configuration options: [1] [3]

EPP Mode Select [EPP1.7]

This field sets the EPP mode. The default setting is EPP1.7. This selection is available when you set the Parallel Port Mode to [EPP] or [ECP+EPP]. Configuration options: [EPP1.9] [EPP1.7]

AC97 Audio [Auto]

This field allows you to enable or disable the onboard AC97 audio controller.
Configuration options: [Auto] [Disabled]

Onboard LAN [Enabled]

This field allows you to enable or disable the onboard LAN controller.
Configuration options: [Enabled] [Disabled]

Onboard LAN Boot ROM [Disabled]

This field allows you to turn on or off the onboard LAN boot ROM. This item appears only when onboard LAN is enabled.
Configuration options: [Enabled] [Disabled]

Game Port Address [201]

This field allows you to select the onboard Game port address.
Configuration options: [Disabled] [201] [209]

MIDI Port Address [Disabled]

This field allows you to select the onboard MIDI port address.
Configuration options: [Disabled] [330] [300] [290]

MIDI Port IRQ [10]

This field allows you to set the IRQ assignment for the onboard MIDI port.
Configuration options: [5] [10]

2.5.3 PCI Configuration

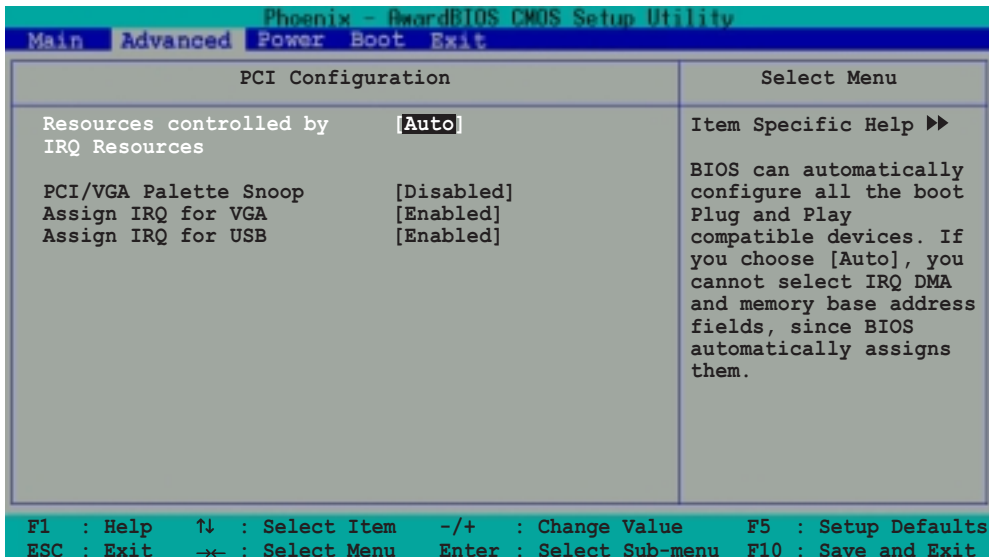

Resources Controlled by [Auto]

When set to [Auto], BIOS automatically configures all Plug and Play devices. Setting this item to [Manual], allows manual assignment of IRQ addresses to Plug and Play devices using the IRQ Resources sub-menu.
Configuration options: [Auto] [Manual]

PCI/VGA Snoop Palette [Disabled]

Some non-standard VGA cards, like graphics accelerators or MPEG video cards, may not show colors properly. Setting this field to [Enabled] corrects this problem. If you are using a standard VGA card, leave this field to the default setting [Disabled]. Configuration options:

Assign IRQ for VGA [Enabled]

Setting this option to [Enabled] allows the BIOS to automatically assign an IRQ address for the VGA controller. Configuration options: [Disabled] [Enabled]

Assign IRQ for USB [Enabled]

Setting this option to [Enabled] allows the BIOS to automatically assign an IRQ address for the USB controller. Configuration options: [Disabled] [Enabled]

IRQ Resources

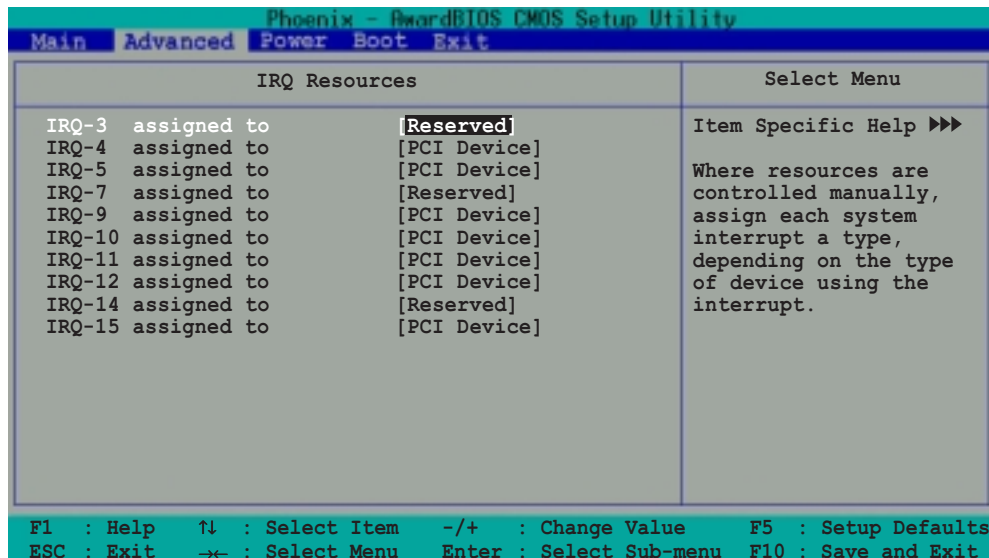

IRQ 3, 4, 5, 7, 9, 10, 11, 12, 14, 15 assigned to

The IRQ Resources sub-menu is activated when the **Resources Controlled by** parameter is set to [Manual]. Select [PCI Device] to assign an IRQ address to a Plug and Play device. Setting to [Reserved] reserves the IRQ address. Configuration options: [PCI Device] [Reserved]

2.6 Power menu

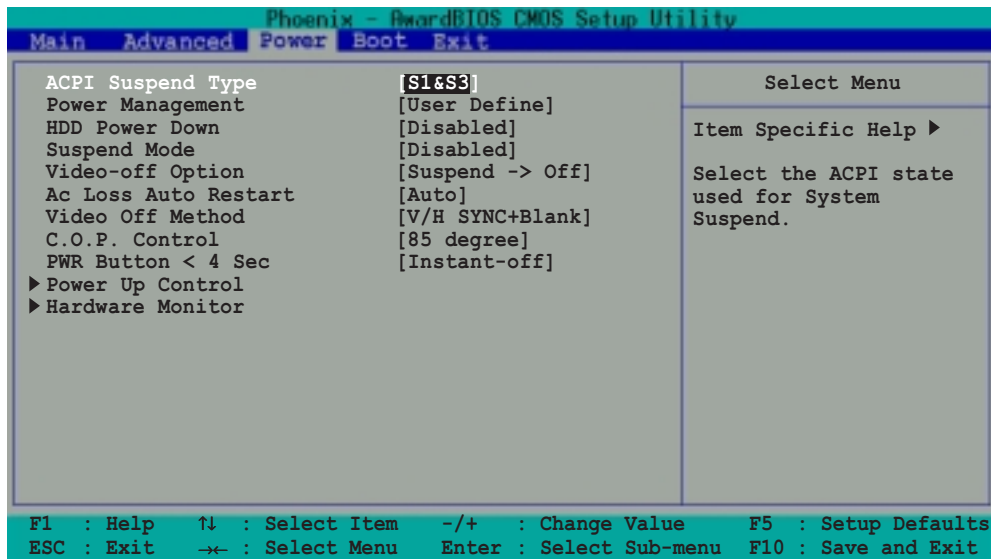

ACPI Suspend Mode [S1&S3]

Allows you to select the ACPI state to used for system suspend.
Configuration options: [S1 (POS)] [S3 (STR)] [S1 & S3]

Power Management [User Define]

Configuration options: [User Define] [Min Saving] [Max Saving]

HDD Power Down [Disabled]

Shuts down any IDE hard disk drives in the system after a period of inactivity as set in this user-configurable field. This feature does not affect SCSI hard drives.
Configuration options: [Disabled] [1Min]...[15Min]

Suspend Mode [Disabled]

Sets the time period before the system goes into suspend mode.
Configuration options: [Disabled] [1Min] [2Min] [4Min] [6Min] [8Min] [10Min] [20Min] [30Min] [40Min] [1Hour]

Video Off Option [Suspend -> Off]

This field determines when to activate the video off feature for monitor power management. Configuration options: [Always On] [Suspend -> Off]

AC Loss Auto Restart [Auto]

This allows you to set whether or not to reboot the system after AC power loss. [Off] leaves your system off while [On] reboots the system. [Auto] sets the system back to the state it was before the power interruption.
Configuration options: [Auto] [On] [Off]

Video Off Method [V/H SYNC+Blank]

This field defines the video off features. The Display Power Management System (DPMS) feature allows the BIOS to control the video display card if it supports the DPMS feature. [Blank Screen] only blanks the screen. Use this for monitors without power management or "green" features. Configuration options: [Blank Screen] [V/H SYNC+Blank] [DPMS support]

C.O.P. Control [85 degree]

Sets the threshold value for the CPU temperature. The ASUS CPU Overheating Protection (C.O.P.) feature of this motherboard automatically shuts down the system when the CPU temperature reaches or exceeds the threshold value. Configuration options: [85 degree] [95 degree]

PWR Button < 4 Sec [Instant-Off]

When set to [Instant-off], the ATX switch can be used as a normal system power-off button when pressed for less than 4 seconds. [Suspend] allows the button to have a dual function where pressing less than 4 seconds puts the system in sleep mode. Regardless of the setting, holding the ATX switch for more than 4 seconds powers off the system. Configuration options: [Suspend] [Instant-off]

2.6.1 Power Up Control

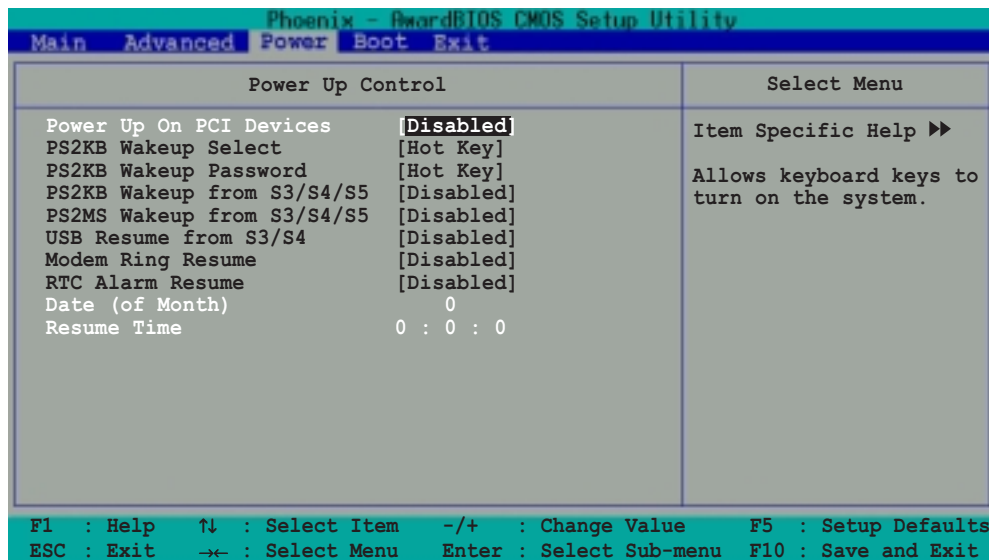

Power Up On PCI Devices [Disabled]

When set to [Enabled], this parameter allows you to turn on the system through a PCI LAN or modem card. This feature requires an ATX power supply that provides at least 1A on the +5VSB lead. Configuration options: [Disabled] [Enabled]

PS2KB Wakeup Select [Hot Key]

This parameter allows you to use specific keys on the keyboard to turn on the system. This feature requires an ATX power supply that provides at least 1A on the +5VSB lead. Configuration options: [Hot key] [Password]

PS2KB Wakeup Password [Clear]

This item appears when you select password as the wakeup method for the PS/2 keyboard. Highlight this item then press <Enter> to enter an 8-digit password. When the password is activated, the system wakes up from a keyboard stroke only after you enter the correct password. To disable the password, highlight this item again, then press <Enter> twice. A PASSWORD DISABLED! message appears indicating that you have successfully disabled the password.



The **PS2KB Wakeup from S3/S4/S5** and the **PS2MS Wakeup from S3/S4/S5** are not configurable if you set the **PS2KB Wakeup Select** item to password mode.

PS2KB Wakeup from S3/S4/S5 [Disabled]

When set to [Enabled], this parameter allows you to use the PS/2 keyboard to turn on the system. Configuration options: [Disabled] [Enabled]

PS2MS Wakeup from S3/S4/S5 [Disabled]

When set to [Enabled], this parameter allows you to use the PS/2 mouse to turn on the system. This requires an ATX power supply that provides at least 1A on the +5VSB lead. Configuration options: [Disabled] [Enabled]

USB Resume from S3/S4 [Disabled]

Configuration options: [Disabled] [Enabled]

Modem Ring Resume [Disabled]

This allows either settings of [Enabled] or [Disabled] for powering up the computer when the external modem receives a call while the computer is in Soft-off mode. Configuration options: [Disabled] [Enabled]

RTC Alarm Resume [Disabled]

Allows you to enable or disable RTC to generate a wake event. When this item is enabled, the Date and Resume Time fields are activated for manual setup. Configuration options: [Disabled] [Enabled]

2.6.2 Hardware Monitor

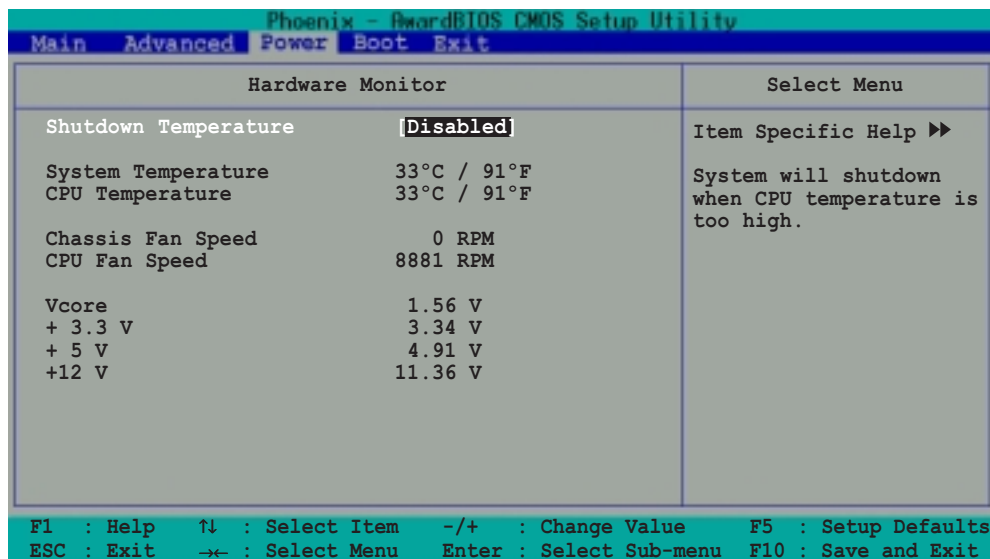

Shutdown Temperature [Disabled]

This option allows BIOS to set a threshold value for the CPU temperature. The system shuts down when the CPU temperature reaches the threshold value. Configuration options: [Disabled] [60°C/140°F] [65°C/149°F] [70°C/158°F] [75°C/167°F]

System Temperature [xxx°C/xxx°F]

CPU Temperature [xxx°C/xxx°F]

The onboard hardware monitor automatically detects and displays the system and CPU temperatures.

Chassis Fan Speed [xxxxRPM] or [0RPM]

CPU Fan Speed [xxxxRPM] or [0RPM]

The onboard hardware monitor automatically detects and displays the CPU and chassis fan speeds in rotations per minute (RPM). If any of the fans is not connected to the motherboard, that field shows 0RPM.

Vcore [XX.XX V]

+3.3V [XX.XX V]

+5V [XX.XX V]

+12V [XX.XX V]

The onboard hardware monitor automatically detects the voltage output through the onboard voltage regulators.

2.7 Boot menu

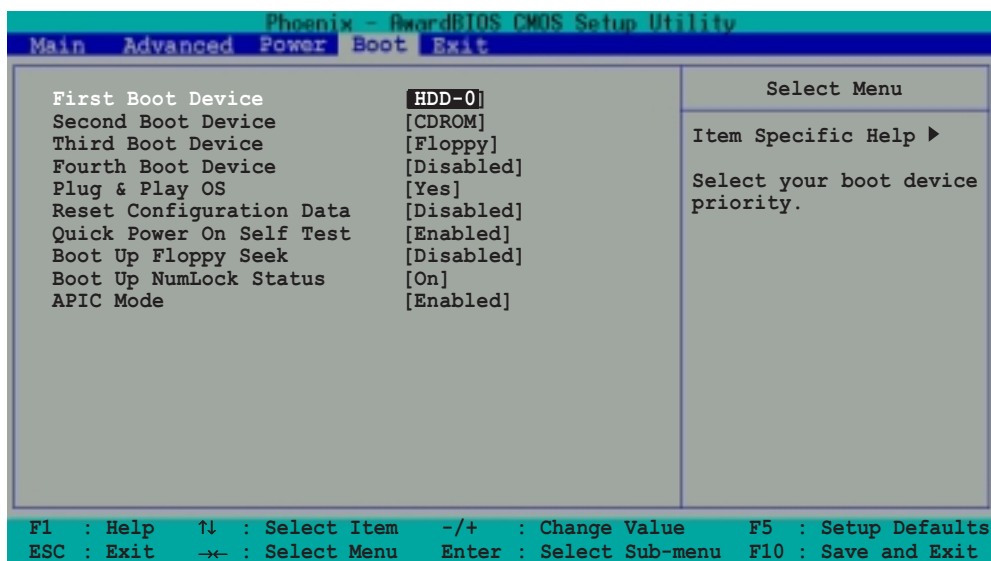

First/Second/Third/Fourth Boot Device

The Boot Menu allows you to select 13 types of boot devices. Promotion or demotion of devices alters the priority which the system uses to boot on system power up. Configuration options include [Floppy] [LS120] [HDD-0] [SCSI] [CDROM] [HDD-1] [HDD-2] [HDD-3] [ZIP100] [USB-FDD] [USB-ZIP] [USB-CDROM] [USB-HDD] [LAN] [Disabled]

Plug & Play OS [Yes]

This field allows you to use a Plug and Play (PnP) operating system to configure the PCI bus slots instead of using the BIOS. When [Yes] is selected, interrupts may be reassigned by the OS. If you installed a non-PnP OS or if you want to prevent reassigning of interrupt settings, keep the default setting [No]. Configuration options: [No] [Yes]

Reset Configuration Data [Disabled]

Select [Enabled], if you want to clear the Extended System Configuration Data (ESCD). Configuration options: [Disabled] [Enabled]

Quick Power On Self Test [Enabled]

This field speeds up the Power-On-Self Test (POST) routine by skipping retesting several times. Configuration options: [Disabled] [Enabled]

Boot up Floppy Seek [Disabled]

When enabled, the BIOS will seek the floppy disk drive to determine whether the drive has 40 or 80 tracks. Configuration options: [Disabled] [Enabled]

Boot up NumLock Status [On]

Allows you to select the power-on state for the NumLock key. Configuration options: [Off] [On]

APIC Mode [Enabled]

When enabled, this option allows you to distribute interrupt routings other than the 16 IRQs. The Programmable Interrupt Controller (PIC) setting allows you to use the 16 IRQs only. Configuration options: [Disabled] [Enabled]

2.8 Exit menu

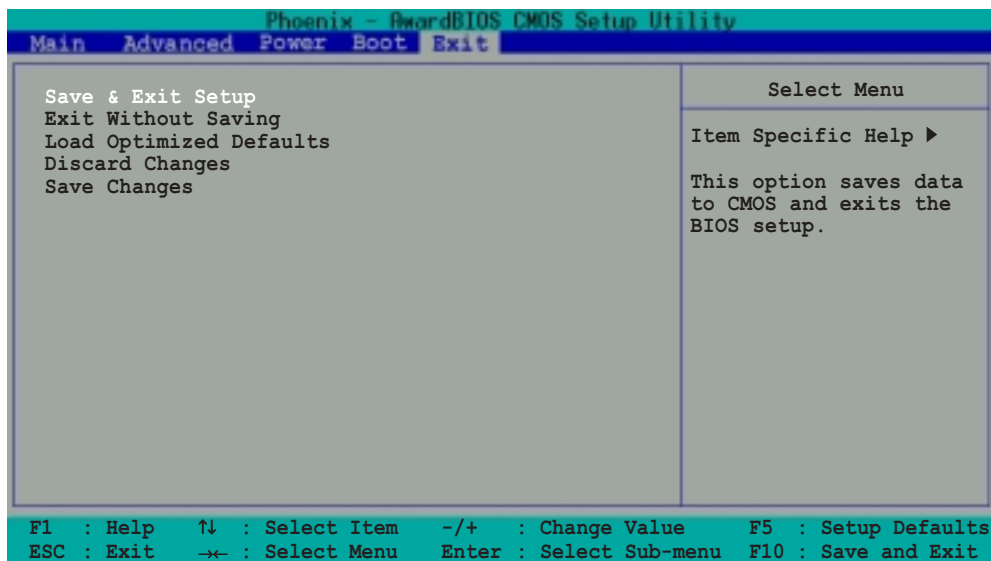

Save & Exit Setup

Once you are finished making your selections, choose this option from the Exit menu to ensure the values you selected are saved to the CMOS RAM. The CMOS RAM is sustained by an onboard backup battery and stays on even when the PC is turned off. When you select this option, a confirmation window appears. Select [Yes] to save changes and exit.

Exit Without Saving

Select this option only if you do not want to save the changes that you made to the Setup program. If you made changes to fields other than system date, system time, and password, the BIOS asks for a confirmation before exiting.

Load Optimized Defaults

This option allows you to load the optimized values for each of the parameters on the Setup menus. When you select this option or if you press <F5>, a confirmation window appears. Select [Yes] to load optimized values. Select Save & Exit or make other changes before saving the values to the non-volatile RAM.

Discard Changes

This option allows you to discard the selections you made and restore the previously saved values. After selecting this option, a confirmation appears. Select [Yes] to discard any changes and load the previously saved values.

Save Changes

This option saves your selections without exiting the Setup program. You can then return to other menus and make further changes. After you select this option, a confirmation window appears. Select [Yes] to save changes to the non-volatile RAM.

Chapter 3

This chapter describes the contents of the support CD that comes with the motherboard package.

Software support

3.1 Installing an operating system

This motherboard supports Windows® 98SE/Me/2000/XP operating systems (OS). Always install the latest OS version and corresponding updates so you can maximize the features of your hardware.



Because motherboard settings and hardware options vary, use the setup procedures presented in this chapter for general reference only. Refer to your OS documentation for more information.

3.2 Support CD information

The support CD that came with the motherboard contains useful software and several utility drivers that enhance the motherboard features.



The contents of the support CD are subject to change at any time without notice. Visit the website provided by the system builder for updates.

3.2.1 Running the support CD

To begin using the support CD, place the CD into the optical drive. The CD automatically displays the **Drivers** menu if Autorun is enabled in your computer.

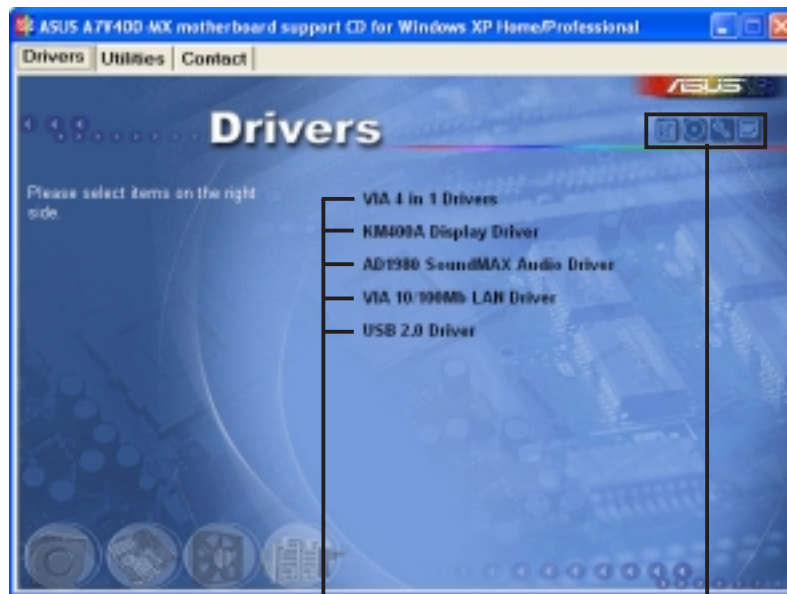

Click an item to install

Click an icon to display more information



If **Autorun** is NOT enabled in your computer, browse the contents of the support CD to locate the file **ASSETUP.EXE** from the **BIN** folder. Double-click the **ASSETUP.EXE** to run the CD.

3.2.2 Drivers menu

The drivers menu displays the available device drivers for this motherboard. Install the necessary drivers to activate the devices.

VIA 4 in 1 Drivers

This item installs the VIA 4-in-1 drivers.

KM400A Display Driver

Click this item to install the KM400A display driver for the onboard VGA.

ADI SoundMAX Audio Driver

This item installs the ADI SoundMAX audio driver and applications.

VIA 10/100Mb LAN Driver

Click this item to install the driver for the VIA 10/100Mb Fast Ethernet controller.

USB 2.0 Driver

This item installs the USB 2.0 driver.



Some items may appear only on specific operating system versions.

3.2.3 Utilities menu

The **Utilities** menu shows the software applications that the motherboard supports.

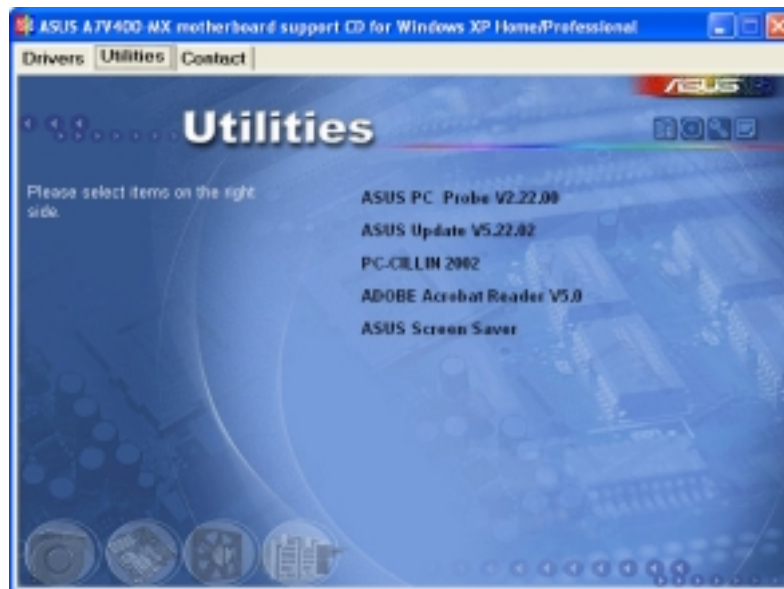

ASUS PC Probe

This convenient utility continuously monitors your computer systems vital components such as fan rotations, CPU temperature, and system voltages, and alerts you on any detected problems. This utility helps you keep your computer at a healthy operating condition.

Install ASUS Update

The ASUS Update is a utility that allows you to update the motherboard BIOS and drivers. This utility requires an Internet connection either through a network or an Internet Service Provider (ISP).

PC-CILLIN

This item installs the PC-cillin anti-virus program. View the PC-cillin online help for detailed information.

ADOBE Acrobat Reader

This item installs the Adobe® Acrobat Reader®. The Acrobat Reader® software is for viewing files saved in Portable Document Format (PDF).

ASUS Screensaver

This item installs the ASUS screensaver.

3.2.4 ASUS contact information

Click the **Contact** tab to display the ASUS contact information.



Screen display and driver options may not be the same for other operating system versions.

Free Manuals Download Website

<http://myh66.com>

<http://usermanuals.us>

<http://www.somanuals.com>

<http://www.4manuals.cc>

<http://www.manual-lib.com>

<http://www.404manual.com>

<http://www.luxmanual.com>

<http://aubethermostatmanual.com>

Golf course search by state

<http://golfingnear.com>

Email search by domain

<http://emailbydomain.com>

Auto manuals search

<http://auto.somanuals.com>

TV manuals search

<http://tv.somanuals.com>