

# xSeries 330





Hardware Maintenance Manual



# xSeries 330

**Note:** Before using this information and the product it supports, be sure to read the general information under "Notices" on page 147.

First Edition (September 2000)

INTERNATIONAL BUSINESS MACHINES CORPORATION PROVIDES THIS PUBLICATION "AS IS" WITHOUT WARRANTY OF ANY KIND, EITHER EXPRESS OR IMPLIED, INCLUDING, BUT NOT LIMITED TO, THE IMPLIED WARRANTIES OF MERCHANTABILITY OR FITNESS FOR A PARTICULAR PURPOSE. Some states do not allow disclaimer of express or implied warranties in certain transactions, therefore, this statement may not apply to you.

This publication could include technical inaccuracies or typographical errors. Changes are periodically made to the information herein; these changes will be incorporated in new editions of the publication. IBM may make improvements and/or changes in the product(s) and/or the program(s) described in this publication at any time.

This publication was developed for products and services offered in the United States of America. IBM may not offer the products, services, or features discussed in this document in other countries, and the information is subject to change without notice.

Consult your local IBM representative for information on the products, services, and features available in your area.

Requests for technical information about IBM products should be made to your IBM reseller or IBM marketing representative.

**xSeries 300**

© Copyright International Business Machines Corporation 2000. All rights reserved.

US Government Users Restricted Rights – Use, duplication or disclosure restricted by GSA ADP Schedule Contract with IBM Corp.

---

## About this manual

This manual contains diagnostic information, a Symptom-to-FRU index, service information, error codes, error messages, and configuration information for the IBM® @server xSeries 330.

**Important:** This manual is intended for trained servicers who are familiar with IBM PC Server products.

---

## Important safety information

Be sure to read all caution and danger statements in this book before performing any of the instructions.

Leia todas as instruções de cuidado e perigo antes de executar qualquer operação.

---

## 注意和危险声明 (简体中文)

重要事项:

本书中的所有注意和危险声明之前都有编号。该编号用于英语的注意或危险声明与 *Safety Information* 一书中可以找到的翻译版本的注意或危险声明进行交叉引用。

例如，如果一个注意声明以编号 1 开始，那么对该注意声明的翻译出现在 *Safety Information* 一书中的声明 1 中。

在按说明执行任何操作前，请务必阅读所有注意和危险声明。

---

## 注意及危險聲明 (中文)

重要資訊:

本書中所有「注意」及「危險」的聲明均以數字開始。此一數字是用來作為交互參考之用，英文「注意」或「危險」聲明可在「安全資訊」(Safety Information) 一書中找到相同內容的「注意」或「危險」聲明的譯文。

例如，有一「危險」聲明以數字 1 開始，則該「危險」聲明的譯文將出現在「安全資訊」(Safety Information) 一書的「聲明」1 中。

執行任何指示之前，請詳讀所有「注意」及「危險」的聲明。

Prenez connaissance de toutes les consignes de type Attention et

Danger avant de procéder aux opérations décrites par les instructions.

Lesen Sie alle Sicherheitshinweise, bevor Sie eine Anweisung ausführen.

Accertarsi di leggere tutti gli avvisi di attenzione e di pericolo prima di effettuare qualsiasi operazione.

---

## 주의 및 위험 경고문(한글)

### 중요:

이 책에 나오는 모든 주의 및 위험 경고문은 번호로 시작됩니다.  
이 번호는 *Safety Information* 책에 나오는 영문판 주의 및 위험  
경고문과 한글판 주의 및 위험 경고문을 상호 참조하는데 사용됩  
니다.

예를 들어 주의 경고문이 번호 1로 시작되면 *Safety Information*  
책에서 이 주의 경고문은 경고문 1번 아래에 나옵니다.

지시를 따라 수행하기 전에 먼저 모든 주의 및 위험 경고문을 읽  
도록 하십시오.

Lea atentamente todas las declaraciones de precaución y peligro ante de llevar a cabo cualquier operación.

---

## Online Support

Use the World Wide Web (WWW) to download Diagnostic, BIOS Flash, and Device Driver files.

File download address is:

<http://www.us.pc.ibm.com/files.html>

## IBM Online Addresses

The HMM manuals online address is:

<http://www.us.pc.ibm.com/cdt/hmm.html>

The IBM PC Company Support Page is:

<http://www.us.pc.ibm.com/support/index.html>

The IBM PC Company Home Page is:

<http://www.pc.ibm.com>

# Contents

<b>About this manual</b> . . . . .	<b>iii</b>	<b>Chapter 5.Installing options</b> . . . . .	<b>39</b>
Important safety information . . . . .	iii	Major components of the xSeries 330 server . . . . .	39
Online Support . . . . .	iv	System board . . . . .	40
IBM Online Addresses . . . . .	iv	System board options connectors . . . . .	40
<b>Chapter 1.General checkout</b> . . . . .	<b>1</b>	System board LEDs . . . . .	41
<b>Chapter 2.General information</b> . . . . .	<b>3</b>	Before you begin . . . . .	42
Features and specifications . . . . .	4	System reliability considerations . . . . .	42
What the xSeries 330 offers . . . . .	5	Working inside a server with power on . . . . .	42
Reliability, availability, and serviceability features . . . . .	5	Rack installation . . . . .	43
Server controls and indicators . . . . .	6	Removing the cover . . . . .	44
Front view . . . . .	6	Working with adapters . . . . .	44
Rear view . . . . .	7	Adapter considerations . . . . .	45
Turning on the server . . . . .	8	Installing an adapter . . . . .	46
Turning off the server . . . . .	9	Hard disk drives . . . . .	48
Stand-by mode . . . . .	9	Preinstallation steps . . . . .	48
<b>Chapter 3.Diagnostics</b> . . . . .	<b>11</b>	Installing or replacing a hard disk drive . . . . .	49
Diagnostic tools overview . . . . .	11	Hot-swap disk drives . . . . .	50
POST . . . . .	12	Preinstallation steps . . . . .	50
POST error messages . . . . .	12	Installing hot-swap disk drives . . . . .	50
Event/error logs . . . . .	12	Replacing a drive in a hot-swap bay . . . . .	51
Small computer system interface messages . . . . .	12	Memory . . . . .	53
Identifying problems using status LEDs . . . . .	13	Installing memory modules . . . . .	53
Light Path Diagnostics . . . . .	13	Microprocessor . . . . .	55
Diagnostics panel . . . . .	14	Installing the microprocessor . . . . .	56
Diagnostic programs and error messages . . . . .	15	Removing a microprocessor . . . . .	57
Text messages . . . . .	15	Fan assembly replacement . . . . .	59
Starting the diagnostic programs . . . . .	16	Installing the cover . . . . .	61
Viewing the test log . . . . .	16	I/O connector locations and ports . . . . .	61
Recovering BIOS . . . . .	18	Input/Output ports . . . . .	62
Troubleshooting the Ethernet controller . . . . .	19	Serial port . . . . .	62
Network connection problems . . . . .	19	Universal Serial Bus ports . . . . .	63
Ethernet controller troubleshooting chart . . . . .	19	Cable Chaining Technology (C2T) ports . . . . .	64
Ethernet controller messages . . . . .	20	C2T chaining cable . . . . .	65
Novell NetWare or IntraNetWare server ODI driver		C2T breakout cable . . . . .	65
teaming messages . . . . .	21	Ethernet ports . . . . .	67
NDIS 4.0 (Windows NT) driver messages . . . . .	22	Advanced System Management ports . . . . .	70
Power checkout . . . . .	24	Working with cables . . . . .	71
Replacing the battery . . . . .	25	Cabling the RS-485 ports . . . . .	71
Temperature checkout . . . . .	26	Connecting the ASM bus . . . . .	72
<b>Chapter 4.Configuring the server</b> . . . . .	<b>29</b>	Connecting the servers with a C2T chain . . . . .	72
Using the Configuration/Setup Utility program . . . . .	29	Testing the C2T chain . . . . .	74
Starting the Configuration/Setup Utility program . . . . .	29	Cable management . . . . .	75
Choices available from the Configuration/Setup main		<b>Chapter 6.FRU information (service only)</b> <b>77</b>	
menu . . . . .	29	Diskette/CD-ROM drives . . . . .	77
Using passwords . . . . .	34	Diskette/CD-ROM drive bracket . . . . .	78
Power-on password . . . . .	34	Hard disk drive backplane . . . . .	79
Administrator password . . . . .	35	Power supply . . . . .	79
Using the SCSISelect utility program . . . . .	36	PCI riser card . . . . .	80
Starting the SCSISelect utility program . . . . .	36	System board . . . . .	80
Choices available from the SCSISelect menu . . . . .	36	<b>Chapter 7.Symptom-to-FRU index</b> . . . . .	<b>83</b>
Using the Preboot eXecution Environment boot agent		Beep symptoms . . . . .	83
utility program . . . . .	37	No Beep symptoms . . . . .	85
Starting the PXE boot agent utility program . . . . .	37	Information panel system error LED . . . . .	85
Choices available from the PXE boot agent utility .		Diagnostic error codes . . . . .	87
38		Error symptoms . . . . .	89
		POST error codes . . . . .	90
		SCSI error codes . . . . .	95
		Temperature error messages . . . . .	95
		Fan error messages . . . . .	96

System shutdown .....	96
Voltage related system shutdown .....	96
Temperature related system shutdown .....	97
DASD checkout .....	97
Bus fault messages .....	97
Undetermined problems .....	98

**Chapter 8.Parts listing..... 101**

System.....	101
Keyboards.....	103
Power cords .....	104

**Chapter 9.Related service information . 107**

Safety information.....	107
General safety .....	107
Electrical safety.....	108
Safety inspection guide .....	109
Handling electrostatic discharge-sensitive devices	110
Grounding requirements.....	111
Safety notices (multi-lingual translations) .....	111
Send us your comments! .....	146
Problem determination tips.....	147
Notices.....	147
Trademarks.....	148



---

## Chapter 1. General checkout

The server diagnostic programs are stored in upgradable read-only memory (ROM) on the system board. These programs are the primary method of testing the major components of the server: the system board, Ethernet controller, video controller, RAM, keyboard, mouse (pointing device), diskette drive, serial ports, and hard drives. You can also use them to test some external devices. See “Diagnostic programs and error messages” on page 15.

Also, if you cannot determine whether a problem is caused by the hardware or by the software, you can run the diagnostic programs to confirm that the hardware is working properly.

When you run the diagnostic programs, a single problem might cause several error messages. When this occurs, work to correct the cause of the first error message. After the cause of the first error message is corrected, the other error messages might not occur the next time you run the test.

A failed system might be part of a shared DASD cluster (two or more systems sharing the same external storage device(s)). Prior to running diagnostics, verify that the failing system is not part of a shared DASD cluster.

A system might be part of a cluster if:

- The customer identifies the system as part of a cluster.
- One or more external storage units are attached to the system and at least one of the attached storage units is additionally attached to another system or unidentifiable source.
- One or more systems are located near the failing system.

If the failing system is suspected to be part of a shared DASD cluster, all diagnostic tests can be run except diagnostic tests which test the storage unit (DASD residing in the storage unit) or the storage adapter attached to the storage unit.

### Notes:

1. Safety information, see “Safety information” on page 107.
2. For systems that are part of a shared DASD cluster, run one test at a time in looped mode. Do not run all tests in looped mode, as this could enable the DASD diagnostic tests.
3. If multiple error codes are displayed, diagnose the first error code displayed.
4. If the computer hangs with a POST error, go to “POST error codes” on page 90.
5. For intermittent problems, check the error log; see “Event/error logs” on page 12.

### 1. IS THE SYSTEM PART OF A CLUSTER?

**YES.**Schedule maintenance with the customer. Shut down all systems related to the cluster. Run storage test.

**NO.**Go to step 2.

### 2. IF THE SYSTEM IS NOT PART OF A CLUSTER:

- Power-off the computer and all external devices.
- Check all cables and power cords.
- Set all display controls to the middle position.
- Power-on all external devices.

- Power-on the computer.
- If the computer hangs and no error is displayed, go to “Undetermined problems” on page 98.
- Record any POST error messages displayed on the screen. If an error is displayed, look up the first error in the “POST error codes” on page 90.
- Check the information LED panel System Error LED; if on, see “Information panel system error LED” on page 85.
- Check the System Error Log. If an error was recorded by the system, see “Chapter 7. Symptom-to-FRU index,” on page 83.
- Start the Diagnostic Programs. See “Diagnostic programs and error messages” on page 15.
- Check for the following responses:
  - a. One beep.
  - b. Readable instructions or the Main Menu.

**3. DID YOU RECEIVE BOTH OF THE CORRECT RESPONSES?**

**NO.** Find the failure symptom in “Chapter 7. Symptom-to-FRU index,” on page 83.

**YES.** Run the Diagnostic Programs. If necessary, refer to “Starting the diagnostic programs” on page 16.

If you receive an error, go to “Chapter 7. Symptom-to-FRU index,” on page 83.

If the diagnostics completed successfully and you still suspect a problem, see “Undetermined problems” on page 98.

---

## Chapter 2. General information

The IBM® eServer xSeries 330 server is a one U-high<sup>1</sup> rack-model server for high-volume network transaction processing. This high-performance, symmetric multiprocessing (SMP) server is ideally suited for networking environments that require superior microprocessor performance, efficient memory management, flexibility, and reliable data storage.

The xSeries 330 server comes with a three-year limited warranty and IBM Server Start Up Support. If you have access to the World Wide Web, you can obtain up-to-date information about your xSeries 330 model and other IBM server products at the following World Wide Web address: <http://www.ibm.com/eserver/xseries>

---

<sup>1</sup>Racks are marked in vertical increments of 1.75 inches each. Each increment is referred to as a unit, or a "U". A one-U-high device is 1.75 inches tall.

## Features and specifications

The following table provides a summary of the features and specifications for the xSeries 330 server.

Table 1. Features and Specifications.

<p><b>Microprocessor:</b></p> <ul style="list-style-type: none"> <li>Intel® Pentium® III microprocessor with MMX™ technology and SIMD extensions</li> <li>256 KB Level-2 cache</li> <li>Supports up to two microprocessors</li> </ul> <p><b>Memory:</b></p> <ul style="list-style-type: none"> <li>Standard: 256 MB</li> <li>Maximum: 4 GB</li> <li>Type: 133 MHz, ECC, SDRAM, Registered DIMMs</li> <li>Slots: 4 dual inline</li> </ul> <p><b>Drives standard:</b></p> <ul style="list-style-type: none"> <li>Diskette: 1.44 MB</li> <li>CD-ROM: 24X IDE</li> </ul> <p><b>Expansion bays:</b></p> <ul style="list-style-type: none"> <li>Two 3.5-inch slim high bays for LVD SCSI hard disk drives</li> </ul> <p><b>PCI expansion slots:</b></p> <ul style="list-style-type: none"> <li>Two 33 MHz/64-bit</li> </ul> <p><b>Power supply:</b></p> <p>One 200 watt (115-230 Vac)</p> <p><b>Video:</b></p> <ul style="list-style-type: none"> <li>S3 Savage4 PRO Graphics/Video Accelerator (integrated on system board)</li> <li>Compatible with SVGA</li> <li>8 MB SDRAM video memory</li> </ul>	<p><b>Size</b></p> <ul style="list-style-type: none"> <li>Height 43.69 mm (1.72")</li> <li>Depth: 653.29 mm (25.72")</li> <li>Width: 439.93 mm (17.32")</li> <li>Weight: approximately 12.7 kg (28lb) when fully configured</li> </ul> <p><b>Integrated functions:</b></p> <ul style="list-style-type: none"> <li>Advanced System Management processor</li> <li>One Ultra160 SCSI controller</li> <li>Two 10BASE-T/100BASE-TX Intel Ethernet controllers</li> <li>Two Universal Serial Bus (USB) ports</li> <li>Two RS-485 Advanced System Management processor ports (one In, one Out)</li> <li>One serial port</li> <li>Two Cable Chaining Technology ports (IN, OUT)</li> </ul> <p><b>Acoustical noise emissions:</b></p> <ul style="list-style-type: none"> <li>Sound power, idling: 6.1 bel maximum</li> <li>Sound power, operating: 6.2 bel maximum</li> </ul>	<p><b>Environment:</b></p> <ul style="list-style-type: none"> <li>Air temperature: <ul style="list-style-type: none"> <li>Server on: 10° to 35° C (50.0° to 95.0° F). Altitude: 0 to 914 m (2998.7 ft.)</li> <li>Server on: 10° to 32° C (50.0° to 89.6° F). Altitude: 914 m (2998.7 ft.) to 2133 m (6998.0 ft.)</li> <li>Server off: 10° to 43° C (50.0° to 109.4° F). Maximum altitude: 2133 m (6998.0 ft.)</li> </ul> </li> <li>Humidity: <ul style="list-style-type: none"> <li>Server on: 8% to 80%</li> <li>Server off: 8% to 80%</li> </ul> </li> </ul> <p><b>Heat output:</b></p> <p>Approximate heat output in British Thermal Units (BTU) per hour</p> <ul style="list-style-type: none"> <li>Minimum configuration: 273 BTU (80 watts)</li> <li>Maximum configuration: 751 BTU (220 watts)</li> </ul> <p><b>Electrical input:</b></p> <ul style="list-style-type: none"> <li>Sine-wave input (50-60 Hz) required</li> <li>Input voltage low range: <ul style="list-style-type: none"> <li>Minimum: 100 V ac</li> <li>Maximum: 127 V ac</li> </ul> </li> <li>Input voltage high range: <ul style="list-style-type: none"> <li>Minimum: 200 V ac</li> <li>Maximum: 240 V ac</li> </ul> </li> <li>Input kilovolt-amperes (kVA) approximately: <ul style="list-style-type: none"> <li>Minimum: 0.08 kVA</li> <li>Maximum: 0.22 kVA</li> </ul> </li> </ul>
--	--	--

## What the xSeries 330 offers

The unique design of this server takes advantage of advancements in symmetric multiprocessing (SMP), data storage, and memory management. The server combines:

- Impressive performance using an innovative approach to SMP

The server supports up to two Pentium III microprocessors. The server comes with one microprocessor installed; you can install an additional microprocessor to enhance performance and provide SMP capability.

- Large system memory

The memory bus in the server supports up to 4 gigabytes (GB) of system memory. The memory controller provides error correcting code (ECC) support for up to four industry standard PC133, 3.3 V, 168-pin, 8-byte, registered, synchronous-dynamic-random access memory (SDRAM) dual inline memory modules (DIMMs).

- System-management capabilities

The server comes with an Advanced System Management Processor on the system board. This processor, in conjunction with the systems-management software that is provided with the server, enables you to manage the functions of the server locally and remotely. The Advanced System Management Processor also provides system monitoring, event recording, and dial-out alert capability.

**Note:** The Advanced System Management Processor is sometimes referred to as the service processor.

Refer to the documentation provided with the system-management software for more information.

- Integrated network environment support

The server comes with two Ethernet controllers on the system board. Each Ethernet controller has an interface for connecting to 10-Mbps or 100-Mbps networks. The server automatically selects between 10BASE-T and 100BASE-TX. Each controller provides full-duplex (FDX) capability, which allows simultaneous transmission and reception of data on the Ethernet local area network (LAN).

- IBM ServerGuide CDs

The ServerGuide CDs that are included with the server provide programs to help you set up your server and install the network operating system (NOS). The ServerGuide program detects the hardware options that are installed, and provides the correct configuration programs and device drivers. In addition, the ServerGuide CDs include a variety of application programs for your server.

---

## Reliability, availability, and serviceability features

Three of the most important features in server design are reliability, availability, and serviceability (RAS). These factors help to ensure the integrity of the data stored on your server; that your server is available when you want to use it; and that should a failure occur, you can easily diagnose and repair the failure with minimal inconvenience.

The following is an abbreviated list of the RAS features that your server supports.

- Menu-driven setup, system configuration, RAID configuration, and diagnostic programs
- Power-on self-test (POST)
- Integrated Advanced System Management Processor
- Predictive Failure Alerts (PFA)
- Remote system problem-analysis support
- Power and temperature monitoring
- Hot-swap drive bays

- Error codes and messages
- System error logging
- Upgradable BIOS, diagnostics, and Advanced System Management Processor code
- Automatic restart after a power failure
- Parity checking on the PCI buses
- CRC checking on the SCSI buses
- Error checking and correcting (ECC) memory
- Redundant Ethernet capabilities
- Light Path Diagnostics™ on the system board
- Vital Product Data (VPD) on system board, and SCSI backplane

---

## Server controls and indicators

This section identifies the controls and indicators on the front and the back of your server.

### Front view

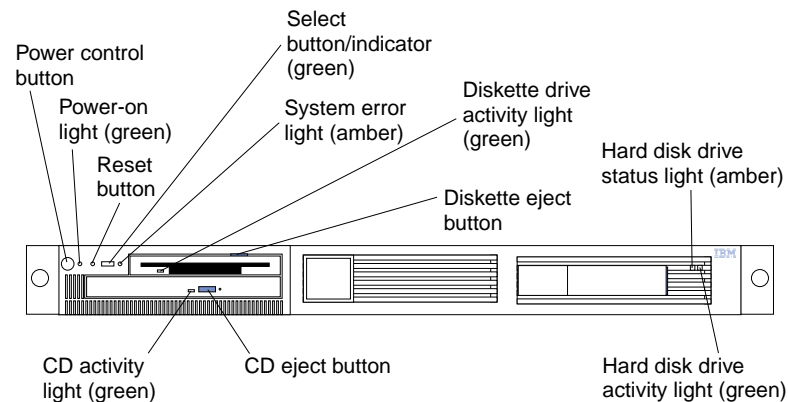

**Power-control button:** Press this button to manually turn the server on or off.

**Power-on light:** This green LED lights and stays on when you turn on your server and blinks when the server is in standby mode.

**Reset button:** Press this button to reset the server and run the power-on self-test (POST). You might need to use a pen or the end of a straightened paper clip to press the button.

**Select button/indicator:** Press this button to select the server in the C2T chain. The green LED on this button lights when the monitor, keyboard, and mouse are logically connected to this server.

**System-error light:** This amber LED lights when a system error occurs. An LED on the Light Path Diagnostic panel on the system board will also be on to further isolate the error.

**Diskette drive activity light:** When this LED is on, it indicates that the diskette drive is in use.

**Diskette-eject button:** Push this button to release a diskette from the drive.

**Hard disk drive status light:** Each of the hot-swap drives has a hard disk drive status light. When this amber LED is on continuously, the drive has failed. This status light is active only with a ServeRAID adapter installed in the server.

**Hard disk drive activity light:** Each of the hot-swap drives has a Hard Disk Activity light. When this green LED is flashing, the controller is accessing the drive.

**CD eject button:** Push this button to release a CD from the drive.

**CD drive activity light:** When this light is on, it indicates that the CD-ROM drive is in use.

## Rear view

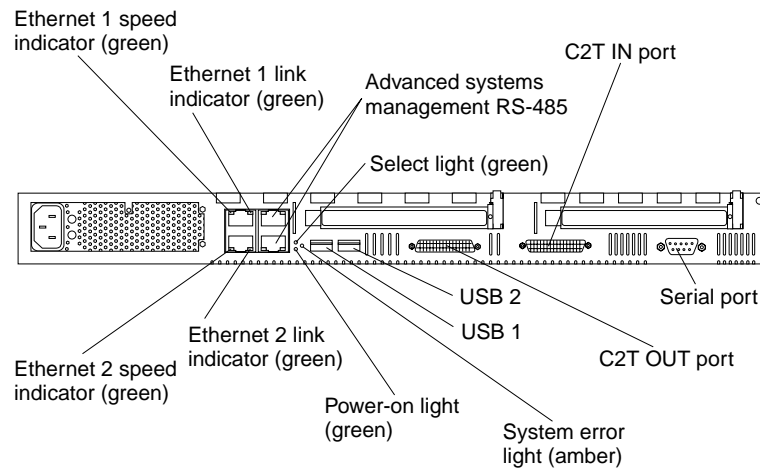

**Ethernet 1 speed indicator:** This green LED lights when the speed of the Ethernet LAN that is connected to Ethernet port 1 is 100 Mbps.

**Ethernet 1 link indicator:** This green LED lights when there is an active link connection on the 10BASE-T or 100BASE-TX interface for Ethernet port 1.

**Advanced system management:** The RS-485 ports (in and out) are used for creating a system management bus between several servers.

**Select light:** This green LED lights when the monitor, keyboard, and mouse are logically connected to this server. This light duplicates the Select button LED on the front of the server.

**Cable Chaining Technology OUT:** This port is used to connect the server to a keyboard, monitor, and pointing device. It is also used to connect multiple servers together to share a single keyboard, monitor, and pointing device.

**Serial port:** Signal cables for modems or other serial devices connect here to the 9-pin serial port connector.

**Cable Chaining Technology IN:** This port is used to connect multiple servers together to share a single keyboard, monitor, and pointing device.

**USB 2:** Universal Serial Bus 2

**USB 1:** Universal Serial Bus 1

**System-error light:** This amber LED lights when a system error occurs. An LED on the Light Path Diagnostic panel on the system board may also be on to further isolate the error. This light duplicates the system error light on the front of the server.

**Power-on light:** This green LED lights and stays on when you turn on your server and will blink when the server is in standby mode. This light duplicates the power on light on the front of the server.

**Ethernet 2 link indicator:** This green LED lights when there is an active link connection on the 10BASE-T or 100BASE-TX interface for Ethernet port 2.

**Ethernet 2 speed indicator:** This green LED lights when the speed of the Ethernet LAN connected to Ethernet port 2 is 100 Mbps.

## Turning on the server

Turning on the server refers to the act of plugging the power cord of your server into the power source and starting the operating system.

Complete the following steps to turn on the server:

1. Plug the power cord of your server into the power source.

**Note:** Plugging the power cord into a power source may cause the server to start automatically. This is an acceptable action.

2. Wait 30 seconds then press the power control button on the front of the server.

- You can press the Power control button on the front of the server to start the server.

**Note:** After you plug the power cord of your server into an electrical outlet, wait approximately 20 seconds before pressing the Power control button. During this time, the system-management processor is initializing and the Power control button does not respond.

- If the server is turned on and a power failure occurs, the server will start automatically when power is restored.
- The Advanced System Management Processor can also turn on the server.



### CAUTION:

The power control button on the device and the power switch on the power supply (if there is one) do not turn off the electrical current supplied to the device. The device also might have more than one power cord. To remove all electrical current from the device, ensure that all power cords are disconnected from the power source.

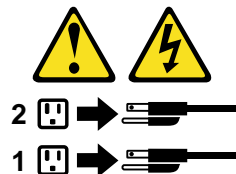

## Turning off the server

Turning off the server refers to the act of disconnecting the server from the power source.



Complete the following steps to turn off the server:

1. Refer to your operating system documentation for the proper procedure to shut down the operating system.  
**Note:** Each operating system is different. Some will allow an immediate shut-down, while others require an orderly shut-down procedure.
2. Press the power control button on the front of the server. This will put the server in the stand-by mode.
3. Disconnect the server from the power source.  
**Note:** After turning off the server, wait at least 5 seconds before you turn on the server again.

## **Stand-by mode**

Stand-by puts the server in a wait state. When in a wait state, the server is not running the operating system, and all core logic is shut down, except for the service processor.

Complete the following steps to put the server into stand-by mode:

1. Refer to your operating system documentation for the proper procedure to shut-down the operating system.  
**Note:** Each operating system is different. Read all the documentation about shutting down the operating system before continuing.
2. Press the power control button on the front of the server.



---

## Chapter 3. Diagnostics

This section provides basic troubleshooting information to help you resolve some common problems that might occur with the server.

---

### Diagnostic tools overview

The following tools are available to help you identify and resolve hardware-related problems:

- **POST beep codes, error messages, and error logs**

The power-on self-test (POST) generates beep codes and messages to indicate successful test completion or the detection of a problem. See “POST” on page 12 for more information.

- **Diagnostic programs and error messages**

The server diagnostic programs are stored in upgradable read-only memory (ROM) on the system board. These programs are the primary method of testing the major components of your server. See “Diagnostic programs and error messages” on page 15 for more information.

- **Light Path Diagnostic**

The Light Path Diagnostic is used to quickly identify system errors.

---

## POST

When you turn on the server, it performs a series of tests to check the operation of server components and some of the options installed in the server. This series of tests is called the power-on self-test or POST.

If POST finishes without detecting any problems, a single beep sounds and the first screen of your operating system or application program appears.

If POST detects a problem, more than one beep sounds and an error message appears on your screen. See “POST error messages” for more information.

### Notes:

1. If you have a power-on password set, you must type the password and press Enter, when prompted, before POST will continue.
2. A single problem might cause several error messages. When this occurs, work to correct the cause of the first error message. After you correct the cause of the first error message, the other error messages usually will not occur the next time you run the test.

## POST error messages

The table “POST error codes” on page 90 provides information about the POST error messages that can appear during startup.

## Event/error logs

The POST error log contains the three most recent error codes and messages that the system generated during POST. The System Event/Error log contains all messages issued during POST and all system status messages from the Advanced System Management Processor.

To view the contents of this error log, start the Configuration/Setup Utility program; then, select **Event/Error Logs** from the main menu.

---

## Small computer system interface messages

The following table lists actions to take if you receive a SCSI error message.

**Note:** If the server does not have a hard disk drive, ignore any message that indicates that the drive is not installed.

You will get these messages only when running the SCSISelect Utility. See “SCSI error codes” on page 95.

Table 2. SCSI messages.

SCSI Messages	Description
All	<p>One or more of the following might be causing the problem.</p> <ul style="list-style-type: none"> <li>• A failing SCSI device (adapter, drive, controller)</li> <li>• An improper SCSI configuration</li> <li>• Duplicate SCSI IDs in the same SCSI chain</li> <li>• An improperly installed SCSI terminator</li> <li>• A defective SCSI terminator</li> <li>• An improperly installed cable</li> <li>• A defective cable</li> </ul> <p><b>Action:</b></p> <p>Verify that:</p> <ul style="list-style-type: none"> <li>• The external SCSI devices are turned on. External SCSI devices must be turned on <i>before</i> the server.</li> <li>• The cables for all external SCSI devices are connected correctly.</li> <li>• The last device in each SCSI chain is terminated properly.</li> <li>• The SCSI devices are configured correctly.</li> </ul> <p>If the above items are correct, run the diagnostic programs to obtain additional information about the failing device. If the error remains or recurs, call for service.</p>

## Identifying problems using status LEDs

If the System Error light in the operator information panel on the front of the server is on, one or more LEDs inside the server may be on. Use the light path diagnostics to identify the type of error that occurred.

For LED locations see “System board LEDs” on page 41.

### Light Path Diagnostics

You can use the Light Path Diagnostics built into your server to quickly identify the type of system error that occurred. The Light Path Diagnostics panel is located on the system board just behind PCI adapter slot 1. When you press on the Light Path Diagnostics button the LED on the top right corner of the panel will illuminate. This shows that the diagnostic circuitry is working correctly.

Your server is designed so that any LEDs that are illuminated can be re-illuminated without AC power after you remove the cover. This feature helps you isolate the problem if an error causes the server to shut down. See Table 3 on page 14.

**Important:** You have up to 12 hours to use the Light Path Diagnostic LED’s after AC power has been removed from the server. After 12 hours you must power the server up again to be able to use the Light Path Diagnostic LEDs to help locate system errors.

To view the LEDs on the system board:

1. Turn off the server and any peripheral devices.
2. Remove the cables.
3. Remove the server from the rack and place it on a flat, non-conductive surface.
4. Remove the server cover (see “Removing the cover” on page 44).  
**Note:** Refer to “Working inside a server with power on” on page 42 for instructions and precautions for working in the server with the power on.
5. Press and hold the Light Path Diagnostics (blue) button on the diagnostics panel. The LEDs will illuminate while the switch is pressed.  
**Note:** You can illuminate the LEDs for a maximum of two minutes. After that time, the circuit that powers the LEDs is exhausted.

## Diagnostics panel

The following illustration shows the LEDs on the diagnostics panel on the system board. See Table 3 for information on identifying problems using these LEDs.

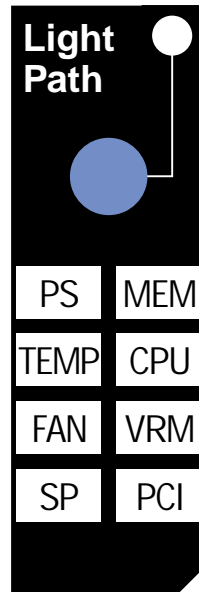

Table 3. Light Path Diagnostics.

LED	Description
PS	Power supply error
MEM	Memory error occurred
TEMP	System temperature exceeded maximum rating
CPU	Microprocessor error
FAN	Fan failed or operating slowly
VRM	Voltage regulator module error
SP	Error occurred on SP bus
PCI	Error occurred on an adapter in PCI slot 1 or 2, or one of the PCI service devices integrated on the system board.

See “Information panel system error LED” on page 85 for appropriate action.

---

## Diagnostic programs and error messages

The server diagnostic programs are stored in upgradable read-only memory (ROM) on the system board. These programs are the primary method of testing the major components of the server.

Sometimes the first error to occur causes additional errors. In this case, the server displays more than one error message. Always follow the suggested action instructions for the *first* error message that appears.

The following sections contain the error codes that might appear in the detailed test log and summary log when running the diagnostic programs.

The error code format is as follows:

fff-ttt-iii-date-cc-text message

where:

<b>fff</b>	is the three-digit function code that indicates the function being tested when the error occurred. For example, function code 089 is for the microprocessor.
<b>ttt</b>	is the three-digit failure code that indicates the exact test failure that was encountered.
<b>iii</b>	is the three-digit device ID.
<b>date</b>	is the date that the diagnostic test was run and the error recorded.
<b>cc</b>	is the check digit that is used to verify the validity of the information.
<b>text message</b>	is the diagnostic message that indicates the reason for the problem.

### Text messages

The diagnostic text message format is as follows:

Function Name: Result (test specific string)

where:

**Function Name**

is the name of the function being tested when the error occurred. This corresponds to the function code (fff) given in the previous list.

**Result** can be one of the following:

**Passed** This result occurs when the diagnostic test completes without any errors.

**Failed** This result occurs when the diagnostic test discovers an error.

**User Aborted**

This result occurs when you stop the diagnostic test before it is complete.

**Not Applicable**

This result occurs when you specify a diagnostic test for a device that is not present.

**Aborted** This result occurs when the test could not proceed because of the system configuration.

**Warning** This result occurs when a possible problem is reported during the diagnostic test, such as when a device that is to be tested is not installed.

**Test Specific String**

This is additional information that you can use to analyze the problem.

## Starting the diagnostic programs

You can press F1 while running the diagnostic programs to obtain Help information. You also can press F1 from within a help screen to obtain online documentation from which you can select different categories. To exit Help and return to where you left off, press Esc.

To start the diagnostic programs:

1. Turn on the server and watch the screen.
2. When the message F2 for Diagnostics appears, press F2.
3. Type in the appropriate password; then, press Enter.
4. Select either **Extended** or **Basic** from the top of the screen.
5. When the Diagnostic Programs screen appears, select the test you want to run from the list that appears; then, follow the instructions on the screen.

**Notes:**

- a. If the server stops during testing and you cannot continue, restart the server and try running the diagnostic programs again.
- b. The keyboard and mouse (pointing device) tests assume that a keyboard and mouse are attached to the server.
- c. If you run the diagnostic programs with no mouse attached to the server, you will not be able to navigate between test categories using the **Next Cat** and **Prev Cat** buttons. All other functions provided by mouse-selectable buttons are also available using the function keys.
- d. You can test the USB keyboard by using the regular keyboard test. The regular mouse test can test a USB mouse. Also, you can run the USB hub test only if there are no USB devices attached.
- e. You can view server configuration information (such as system configuration, memory contents, interrupt request (IRQ) use, direct memory access (DMA) use, device drivers, and so on) by selecting **Hardware Info** from the top of the screen.

When the tests have completed, you can view the Test Log by selecting **Utility** from the top of the screen.

If the hardware checks out OK but the problem persists during normal server operations, a software error might be the cause. If you suspect a software problem, refer to the information that comes with the software package.

## Viewing the test log

The test log will not contain any information until after the diagnostic program has run.

**Note:** If you already are running the diagnostic programs, begin with step 3 on page 17.

To view the test log:



1. Turn on the server and watch the screen.  
If the server is on, shut down your operating system and restart the server:
2. When the message **F2 for Diagnostics** appears, press **F2**.  
If a power-on password is set, the server prompts you for it. Type in the appropriate password; then, press **Enter**.
3. When the **Diagnostic Programs** screen appears, select **Utility** from the top of the screen.
4. Select **View Test Log** from the list that appears; then, follow the instructions on the screen.  
The system maintains the test-log data while the server is powered on. When you turn off the power to the server, the test log is cleared.

## Recovering BIOS

If the BIOS has become corrupted, such as from a power failure during a flash update, you can recover the BIOS using the BIOS code page jumper and a BIOS flash diskette.

**Note:** You can obtain a BIOS flash diskette from one of the following sources:

- Use the ServerGuide program to make a BIOS flash diskette.
- Download a BIOS flash diskette from the World Wide Web. Go to <http://www.pc.ibm.com/support/>, select IBM Server Support, and make the selections for your server.
- Contact your IBM service representative.

To recover the BIOS:

1. Turn off the server and peripheral devices and disconnect all external cables and power cords; then, remove the cover.
2. Locate the BIOS code page jumper (**J19**) on the system board.

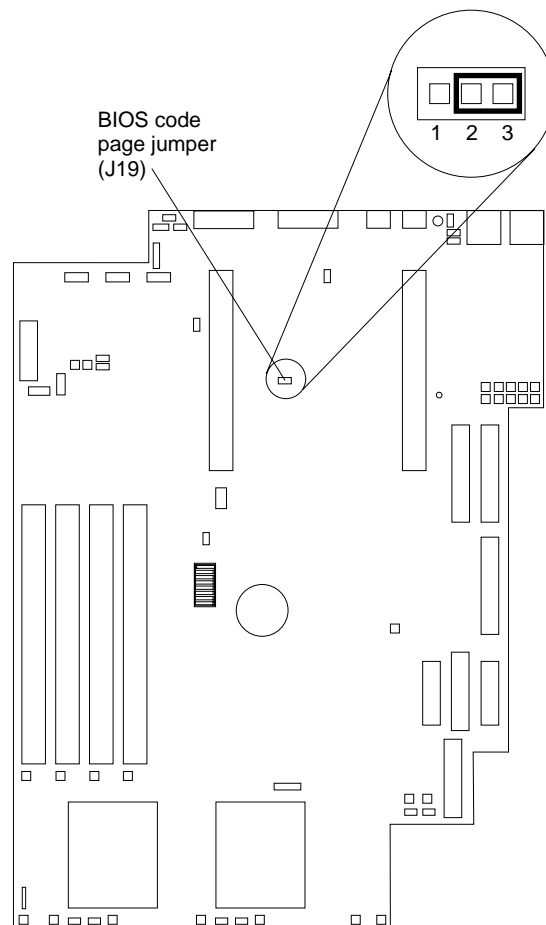

3. Place a jumper on pins 1 and 2 to enable BIOS back page.
4. Reconnect all external cables and power cords and turn on the peripheral devices.
5. Insert the BIOS Flash Diskette in the diskette drive.
6. Restart the server. The system begins the power-on self-test (POST) and BIOS flash.
7. Select **1 - Update POST/BIOS** from the menu that contains various flash (update) options.

8. When prompted as to whether you want to save the current code to a diskette, select **N**.
9. When prompted to choose a language, select a language (from 0 to 7) and press **Enter** to accept your choice.
10. Do not reboot your system at this time.
11. Remove the BIOS Flash Diskette from the diskette drive.
12. Turn the server off.
13. Move the jumper on **J19** to pins 2 and 3 to return to normal startup mode.
14. Restart the server. The system should start up normally.

---

## Troubleshooting the Ethernet controller

This section provides troubleshooting information for problems that might occur with the 10/100 Mbps Ethernet controller:

### Network connection problems

If the Ethernet controller cannot connect to the network, check the following:

- Make sure that the cable is installed correctly.

The network cable must be securely attached at all connections. If the cable is attached but the problem persists, try a different cable.

If you set the Ethernet controller to operate at 100 Mbps, you must use Category 5 cabling.

If you directly connect two workstations (without a hub), or if you are not using a hub with X ports, use a crossover cable.

**Note:** To determine whether a hub has an X port, check the port label. If the label contains an X, the hub has an X port.

- Determine if the hub supports auto-negotiation. If not, try configuring the integrated Ethernet controller manually to match the speed and duplex mode of the hub.
- Check the LAN activity light on the front of the server. The LAN activity light illuminates when the Ethernet controller sends or receives data over the Ethernet Network. If the LAN activity light is off, make sure that the hub and network are operating and that the correct device drivers are loaded.
- Make sure that you are using the correct device drivers, supplied with the server.
- Check for operating system-specific causes for the problem.
- Make sure that the device drivers on the client and server are using the same protocol.
- Test the Ethernet controller:

How you test the Ethernet controller depends on which operating system you are using (see the Ethernet controller device driver README file).

### Ethernet controller troubleshooting chart

You can use the following troubleshooting chart to find solutions to 10/100 Mbps Ethernet controller problems that have definite symptoms.

Table 4. Ethernet troubleshooting chart.

Ethernet controller problem	Suggested Action
The server stops running when loading device drivers.	<p>The PCI BIOS interrupt settings are incorrect.</p> <p>Check the following:</p> <ul style="list-style-type: none"> <li>• Determine if the interrupt (IRQ) setting assigned to the Ethernet controller is also assigned to another device in the Configuration/Setup Utility program.</li> </ul> <p>Although interrupt sharing is allowed for PCI devices, some devices do not function well when they share an interrupt with a dissimilar PCI device. Try changing the IRQ assigned to the Ethernet controller or the other device. For example, for NetWare Versions 3 and 4 it is recommended that disk controllers not share interrupts with LAN controllers.</p> <ul style="list-style-type: none"> <li>• Make sure that you are using the most recent device driver available from the World Wide Web.</li> <li>• Run the network diagnostic program.</li> </ul>
Data is incorrect or sporadic.	<p>Check the following:</p> <ul style="list-style-type: none"> <li>• Make sure that you are using Category 5 cabling when operating the server at 100 Mbps.</li> <li>• Make sure that the cables do not run close to noise-inducing sources like fluorescent lights.</li> </ul>
The Ethernet controller stopped working when another adapter was added to the server.	<p>Check the following:</p> <ul style="list-style-type: none"> <li>• Make sure that the cable is connected to the Ethernet controller.</li> <li>• Make sure that your PCI system BIOS is current.</li> <li>• Reseat the adapter.</li> <li>• Determine if the interrupt (IRQ) setting assigned to the Ethernet adapter is also assigned to another device in the Configuration/Setup Utility program.</li> </ul> <p>Although interrupt sharing is allowed for PCI devices, some devices do not function well when they share an interrupt with a dissimilar PCI device. Try changing the IRQ assigned to the Ethernet adapter or the other device.</p>
The Ethernet controller stopped working without apparent cause.	<p>Check the following:</p> <ul style="list-style-type: none"> <li>• Run diagnostics for the Ethernet controller.</li> <li>• Try a different connector on the hub.</li> <li>• Reinstall the device drivers. Refer to your operating-system documentation and to the ServerGuide information.</li> </ul>

---

## Ethernet controller messages

The integrated Ethernet controller might display messages from the following device drivers:

- Novell™ NetWare™ or IntraNetWare Server ODI
- NDIS Adapter for level 4.0 (Windows NT)
- SCO™ UNIX LLI

## Novell NetWare or IntraNetWare server ODI driver teaming messages

This section provides explanations of the error messages for the Novell NetWare or IntraNetWare server ODI driver, and suggested actions to resolve each problem.

Table 5. NetWare driver messages for the Ethernet controller.

Message	Description
Couldn't allocate resources	<b>Explanation:</b> An unknown error has occurred when trying to allocate needed resources for the AFT Module. <b>Action:</b> <ul style="list-style-type: none"> <li>• Check the server configuration. If the problem persists, contact your network supplier.</li> <li>• Verify that the Ethernet controller is enabled. If the Ethernet controller is enabled, run the diagnostic programs.</li> </ul>
AFT group for primary adapter in slot <i>nnn</i> already exists.	<b>Explanation:</b> An attempt was made to rebind an adapter already in an AFT group. <b>Action:</b> Check the AFT slot numbers for existing AFT teams. If the problem persists, contact your network supplier.
Error locating DCT addresses in internal table. Make sure that you have loaded LAN drivers after loading AFT.NLM.	<b>Explanation:</b> The bind command was entered prior to loading the device driver. The device driver must be loaded after loading AFT.NLM but before any bind command can be issued. <b>Action:</b> Load the driver for the supported adapter and try loading the AFT module again. If the problem persists, contact your network supplier.
Insufficient number of arguments specified.	<b>Explanation:</b> The appropriate or expected number of parameters was not entered in a command. <b>Action:</b> Check the parameters required for the given command. If the problem persists, contact your network supplier.
Duplicate slot numbers detected.	<b>Explanation:</b> An attempt has been made to bind the same slot number more than once. <b>Action:</b> Check the slot numbers entered during the bind. Adapter slot numbers must be valid and unique. If the problem persists, contact your network supplier.
'Xxx' is not supported for AFT team.	<b>Explanation:</b> A bind command has been issued for adapters not supported by AFT.NLM. <b>Action:</b> Make sure that you attempt to bind only adapters supported by AFT.NLM.
Primary and Secondary adapters do not match. AFT group is not created.	<b>Explanation:</b> A bind command was entered for an adapter team that is a combination of server and client adapters. An AFT team must be a grouping of the same classification of adapter. <b>Action:</b> Verify that all the adapters bound in a team are of the same classification.
Requested number of Secondary cards are not found.	<b>Explanation:</b> The number of adapters specified in the bind command could not be located. <b>Action:</b> Verify the numbers and slot locations of the adapters to be bound. If the problem persists, contact your network supplier.
Failed to create AFT group. Make sure that the drivers for supported adapters are loaded, primary adapter is bound to protocols, and secondary adapter is not bound to any protocols.	<b>Explanation:</b> Binding of protocol failed. Protocol is either not bound to any adapter or is bound to more than one adapter in the group. <b>Action:</b> Ensure that the protocol is bound to only adapter in an AFT team.
Error identifying slot numbers for the specified board names.	<b>Explanation:</b> The mapping between the board name entered and the slot number for an adapter could not be established. <b>Action:</b> Check the board name for the adapter before issuing the bind command. If the problem persists, contact your network supplier.

Table 5. NetWare driver messages for the Ethernet controller.

Can't unbind specified slot from AFT group. Make sure that the slot you specified is for the primary adapter in an AFT group.	<b>Explanation:</b> The number entered in the unbind command was not the primary adapter in an AFT group. <b>Action:</b> Reissue the unbind command and specify the slot number for the primary adapter.
LAN adapter at slot <i>nnnn</i> (Port 0xaa) failed to reset. Check the state of the adapter.	<b>Explanation:</b> The adapter that you specified could not be initialized. <b>Action:</b> <ol style="list-style-type: none"> <li>1. Load the driver for the supported adapter.</li> <li>2. Check that the adapter is seated properly in the slot and try loading the AFT module again.</li> </ol> <p>If the problem persists, contact your network supplier.</p>
AFT is not supported on this version of NetWare(TM).	<b>Explanation:</b> The NetWare on your server is not a version supported by AFT. <b>Action:</b> Load and bind AFT only on supported versions of NetWare (currently version 4.11 and above).
Failed to allocate resources tags.	<b>Explanation:</b> An unknown error has occurred when trying to allocate needed resources for the AFT module. <b>Action:</b> Check Server Configuration. If the problem persists, contact your network supplier.
Please unload all LAN drivers before unloading AFT.NLM.	<b>Explanation:</b> An attempt was made to unload the AFT.NLM module before unloading the adapter driver. <b>Action:</b> Unload the adapter driver before unloading the AFT module.

## NDIS 4.0 (Windows NT) driver messages

This section contains the error messages for the NDIS 4.0 drivers. The explanation and recommended action are included with each message.

Table 6. NDIS (Windows NT or Windows 2000) driver messages for the Ethernet controller.

Error code (hex)	Description
0x00	<b>Explanation:</b> The driver could not register the specified interrupt. <b>Action:</b> Using the Configuration/Setup utility, make sure that a PCI interrupt is assigned to your Ethernet card, and that Ethernet is enabled.
0x01	<b>Explanation:</b> One of the PCI cards did not get the required resources. <b>Action:</b> Using the Configuration/Setup utility, make sure that a PCI interrupt is assigned to your Ethernet card, and that Ethernet is enabled.
0x02	<b>Explanation:</b> Bad node address (multicast address). <b>Action:</b> Make sure the locally administered address is valid, if one is specified. The address can not be a multicast address.
0x03	<b>Explanation:</b> Failed self-test. <b>Action:</b> Make sure a cable is attached to the Ethernet connector. If the problem persists, call for service.
0x0D	<b>Explanation:</b> Could not allocate enough memory for transmit queues. <b>Action:</b> <ol style="list-style-type: none"> <li>1. From the Windows NT desktop, select <b>Start -&gt; Control Panel -&gt; Networks -&gt; Adapters</b>.</li> <li>2. Select your IBM Ethernet adapter from the list.</li> <li>3. Select <b>Properties -&gt; Advanced</b>.</li> <li>4. Lower the resource values that apply to the transmit queue.</li> </ol>
0x0E	<b>Explanation:</b> Could not allocate enough memory for receive queue. <b>Action:</b> <ol style="list-style-type: none"> <li>1. From the Windows NT desktop, select <b>Start -&gt; Control Panel -&gt; Networks -&gt; Adapters</b>.</li> <li>2. Select your IBM Ethernet adapter from the list.</li> <li>3. Select <b>Properties -&gt; Advanced</b>.</li> <li>4. Lower the resource values that apply to the receive queue.</li> </ol>

Table 6. NDIS (Windows NT or Windows 2000) driver messages for the Ethernet controller.

Error code (hex)	Description
0x0F	<b>Explanation:</b> Could not allocate enough memory for other structures. <b>Action:</b> <ol style="list-style-type: none"> <li>1. From the Windows NT desktop, select <b>Start -&gt; Control Panel -&gt; Networks -&gt; Adapters</b>.</li> <li>2. Select your IBM Ethernet adapter from the list.</li> <li>3. Select <b>Properties -&gt; Advanced</b>.</li> <li>4. Lower the value for the resource named in the message.</li> </ol>
0x10	<b>Explanation:</b> Did not find any Ethernet controllers. <b>Action:</b> Using the Configuration/Setup utility, make sure that Ethernet is enabled.
0x11	<b>Explanation:</b> Multiple Ethernet controllers found, but none matched the required ID. <b>Action:</b> Using the Configuration/Setup utility, make sure that Ethernet is enabled.
0x13	<b>Explanation:</b> Did not find any Ethernet controllers that matched the required subven/subdev. <b>Action:</b> Using the Configuration/Setup utility, make sure that Ethernet is enabled.
0x16	<b>Explanation:</b> Single adapter found but multiple instances tried to load. <b>Action:</b> Using the Configuration/Setup utility, make sure that Ethernet is enabled, and that the slot containing the IBM Netfinity 10/100 Ethernet Adapter or the IBM 10/100 Etherjet PCI adapter is enabled.
0x17	<b>Explanation:</b> Slot parameter not specified in the registry. <b>Action:</b> Remove the adapter driver and reinstall it. If the problem persists, call for service.
All other 4-character hexadecimal codes	<b>Action:</b> Call for service.

**Ethernet teaming messages:**

Table 7. NDIS (Windows NT or Windows 2000) driver teaming messages for the Ethernet controller.

Event ID	Type	Description
01	Error	<b>Explanation:</b> Team Name and physical adapter name are the same. This is an invalid configuration. <b>Action:</b> Reconfigure the adapter team by double-clicking the PROSet icon in the control panel.
02	Error	<b>Explanation:</b> Unable to allocate required resources. <b>Action:</b> Free some memory resources and restart.
03	Error	<b>Explanation:</b> Unable to read required registry parameters. <b>Action:</b> Reconfigure the adapter team by double-clicking the PROSet icon in the control panel.
04	Error	<b>Explanation:</b> Unable to bind to physical adapter. <b>Action:</b> Reconfigure the adapter team by double-clicking the PROSet icon in the control panel.
05	Error	<b>Explanation:</b> Unable to initialize an adapter team. <b>Action:</b> Reconfigure the adapter team by double-clicking the PROSet icon in the control panel.
06	Informational	<b>Explanation:</b> Team <i>nn</i> . Primary adapter is initialized. <b>Action:</b> None.
07	Informational	<b>Explanation:</b> Team <i>nn</i> . Secondary adapter is initialized. <b>Action:</b> None.
08	Informational	<b>Explanation:</b> Team <i>nn</i> . Virtual adapter or Team is initialized. <b>Action:</b> None.
09	Informational	<b>Explanation:</b> Team <i>nn</i> . Primary adapter is switching over. <b>Action:</b> None.
10	Warning	<b>Explanation:</b> Team <i>nn</i> . Adapter link down. <b>Action:</b> Make sure the adapter is functioning properly.
11	Informational	<b>Explanation:</b> Team <i>nn</i> . Secondary adapter took over. <b>Action:</b> None.

Table 7. NDIS (Windows NT or Windows 2000) driver teaming messages for the Ethernet controller.

Event ID	Type	Description
12	Warning	<b>Explanation:</b> Team <i>nn</i> . Secondary adapter is deactivated from the Team. <b>Action:</b> Make sure the secondary adapter is functioning properly and that the adapter cable is securely connected to the LAN.
13	Informational	<b>Explanation:</b> Team <i>nn</i> . Secondary adapter has rejoined the Team. <b>Action:</b> None.
14	Informational	<b>Explanation:</b> Team <i>nn</i> . Secondary adapter link is up. <b>Action:</b> None.
15	Error	<b>Explanation:</b> Team <i>nn</i> . The last adapter has lost its link. Network connection has been lost. <b>Action:</b> Shut down the server and replace the adapters; then, restart the server to reestablish the connection.
16	Informational	<b>Explanation:</b> Team <i>nn</i> . An adapter has re-established the link. Network connection has been restored. <b>Action:</b> None.
17	Informational	<b>Explanation:</b> Team <i>nn</i> . Preferred primary adapter has been detected. <b>Action:</b> None.
18	Informational	<b>Explanation:</b> Team <i>nn</i> . Preferred secondary adapter has been detected. <b>Action:</b> None.
19	Informational	<b>Explanation:</b> Team <i>nn</i> . Preferred primary adapter took over. <b>Action:</b> None.
20	Informational	<b>Explanation:</b> Team <i>nn</i> . Preferred secondary adapter took over. <b>Action:</b> None.
21	Warning	<b>Explanation:</b> Team <i>nn</i> . Primary adapter does not sense any Probes. Possible reason: partitioned Team. <b>Action:</b> Make sure the cables of the adapter team are connected to the same LAN segment. Reconfigure the team if necessary.

## Power checkout

Power problems can be difficult to troubleshoot. For instance, a short circuit can exist anywhere on any of the power distribution busses. Usually a short circuit will cause the power subsystem to shut down because of an overcurrent condition.

A general procedure for troubleshooting power problems is as follows:

1. Power off the system and disconnect the AC cord(s). Disconnect all external cables and remove server from the rack.
 

**Note:** To determine if the power switch assembly needs to be replaced turn on microswitch 5 on switch block 1 (power-on override) and reconnect the AC cord. If the system powers on within 40 seconds then replace the switch assembly.
2. Check for loose cables in the power subsystem. Also check for short circuits, for instance if there is a loose screw causing a short circuit on a circuit board.
3. Remove adapters and disconnect the cables and power connectors to all internal and external devices until system is at minimum configuration required for power-on.

**Note:** Minimum configuration requirements are:

- a. 1 Power supply
  - b. System board
  - c. 1 Microprocessor
  - d. 1 Terminator card
  - e. Memory module (with a minimum of 128 MB DIMM)
4. Reconnect the AC cord and power on the system. If the system powers up successfully, replace adapters and devices one at a time until the problem is



isolated. If system does not power up from minimal configuration, replace FRUs of minimal configuration one at a time until the problem is isolated.

To use this method it is important to know the minimum configuration required for a system to power-up.

---

## Replacing the battery

When replacing the battery you must replace it with a lithium battery of the same type, from the same manufacturer. To avoid possible danger read and follow the safety statement below.

To order replacement batteries, call 1-800-772-2227 within the United States, and 1-800-465-7999 or 1-800-465-6666 within Canada. Outside the U.S. and Canada, call your IBM reseller or IBM marketing representative.

**Note:** After you replace the battery, you must reconfigure your server and reset the system date and time.



### **CAUTION:**

**When replacing the battery, use only IBM Part Number 33F8354 or an equivalent type battery recommended by the manufacturer. If your system has a module containing a lithium battery, replace it only with the same module type made by the same manufacturer. The battery contains lithium and can explode if not properly used, handled, or disposed of.**

*Do not:*

- **Throw or immerse into water**
- **Heat to more than 100°C (212°F)**
- **Repair or disassemble**

**Dispose of the battery as required by local ordinances or regulations.**

To replace the battery:

1. Read “Before you begin” on page 42, and follow any special handling and installation instructions supplied with the replacement battery.
2. Turn off the server and peripheral devices and disconnect all external cables and power cords.
3. Remove the server from the rack (see “Rack installation” on page 43).
4. Remove the cover (see “Removing the cover” on page 44).
5. Remove the battery:
  - a. Use one finger to lift the battery clip over the battery.
  - b. Use one finger to slightly slide the battery out from its socket. The spring mechanism will push the battery out toward you as you slide it from the socket.
  - c. Use your thumb and index finger to pull the battery from under the battery clip.

- d. Ensure that the battery clip is touching the base of the battery socket by pressing gently on the clip.

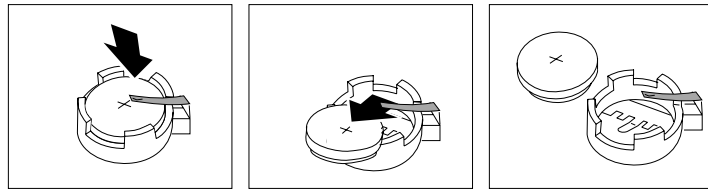

6. Insert the new battery:
  - a. Tilt the battery so that you can insert it into the socket, under the battery clip.
  - b. As you slide it under the battery clip, press the battery down into the socket.

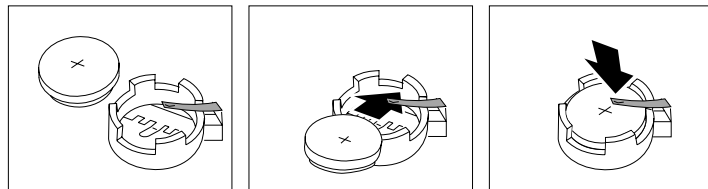

7. Reinstall the server cover and connect the cables.
8. Turn on the server.
9. Start the Configuration/Setup Utility program and set configuration parameters.
  - Set the system date and time.
  - Set the power-on password.
  - Reconfigure the server.

---

## Temperature checkout

Proper cooling of the system is important for proper operation and system reliability. For a typical Netfinity server, you should make sure:

- Each of the drive bays has either a drive or a filler panel installed
- The top cover is in place during normal operation
- There is at least 50 mm (2 inches) of ventilated space at the sides of the server and 100 mm (4 inches) at the rear of the server
- The top cover is removed for no longer than 30 minutes while the server is operating
- A removed hot-swap drive is replaced within two minutes of removal
- Cables for optional adapters are routed according to the instructions provided with the adapters (ensure that cables are not restricting air flow)
- The fans are operating correctly and the air flow is good
- A failed fan is replaced within 48 hours

In addition, ensure that the environmental specifications for the system are met. See “Features and specifications” on page 4.

**Note:** The server is not designed to operate in an enclosed environment. The xSeries 300 should not reside behind a glass door in its rack enclosure.

For more information on specific temperature error messages, see “Temperature error messages” on page 95.



---

## Chapter 4. Configuring the server

The following configuration programs are provided with the server:

- **Configuration/Setup Utility**

This program is part of the *basic input/output system (BIOS)* that comes with the server. You can use this program to configure serial and parallel port assignments, change interrupt request (IRQ) settings, change the drive startup sequence, set the date and time, and set passwords. See “Using the Configuration/Setup Utility program” for more information.

- **SCSISelect Utility**

With the built-in SCSISelect Utility program, you can configure the devices that are attached to the integrated SCSI controller. Use this program to change default values, resolve configuration conflicts, and perform a low-level format on a SCSI hard disk drive. See “Using the SCSISelect utility program” on page 36 for more information.

- **PXE Boot Agent Utility**

The Preboot eXecution Environment (PXE) Boot Agent Utility program is part of the *basic input/output system (BIOS)* code that comes with your server. You can use this program to change network boot protocols and boot order, to select OS wake up support, and to set menu wait times.

- **ServeRAID programs**

If there is a ServeRAID adapter installed in the server, you must use the ServeRAID configuration program to define and configure your disk-array subsystem *before* you install your operating system.

---

### Using the Configuration/Setup Utility program

This section provides the instructions needed to start the Configuration/Setup Utility program and descriptions of the menu choices available.

#### Starting the Configuration/Setup Utility program

To start the Configuration/Setup Utility program:

1. Turn on the server and watch the monitor screen.
2. When the message Press F1 for Configuration/Setup appears, press F1.

**Note:** If you have set both levels of passwords (user and administrator), you must enter the administrator password to access the full Configuration/Setup menu.

3. Follow the instructions that appear on the screen.

#### Choices available from the Configuration/Setup main menu

From the Configuration/Setup Utility main menu, you can select settings that you want to change. The Configuration/Setup Utility main menu is similar to the following:

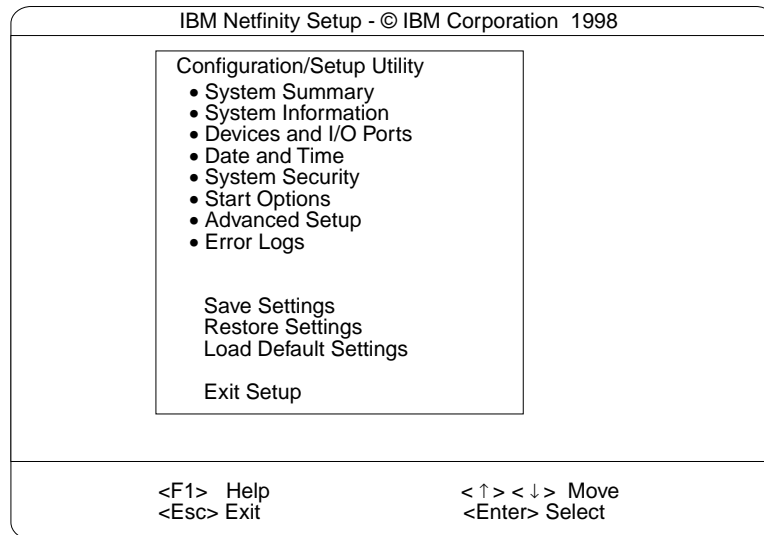

**Notes:**

1. You can press F1 to display Help information for a selected menu item.
2. The choices on some menus might differ slightly, depending on the BIOS version in the server.

Descriptions of the choices available from the main menu are as follows:

- **System Summary**

Select this choice to display configuration information. This includes the type and speed of the microprocessors and the amount of memory installed.

Changes that you make to configuration settings appear on this summary screen. You cannot edit the fields.

This choice appears on both the full and limited Configuration/Setup Utility menus.

- **System Information**

Select this choice to display information about the server. Changes that you make on other menus might appear on this summary screen. You cannot edit any fields. The System Information choice appears only on the full Configuration/Setup Utility main menu.

- **Product Data**

Select this choice to view system information, such as the machine type and model, the server serial number, and the revision level or issue date of the BIOS stored in the flash electronically erasable programmable ROM (EEPROM).

- **System Card Data**

Select this choice to view vital product data (VPD) for some server components.

- **Devices and I/O Ports**

Select this choice to view or change the assignments for devices and input/output ports. This choice appears only on the full Configuration/Setup Utility main menu.

This choice also allows you to enable or disable the integrated SCSI, and Ethernet controllers.

- The default setting is Enable for all the controllers. If you select Disable, the system will not configure the disabled device and the operating system will not see the device. (This is equivalent to unplugging the device.)
- If the on-board SCSI controller is disabled and no other storage device is installed, operating system startup cannot occur.

Select **System Service Processor Settings** to view the interrupt-request setting (IRQ) used by the Advanced System Management Processor (system service processor). You can then use the arrow keys to select a new IRQ setting for the Advanced System Management Processor from the list of available choices.

- **Date and Time**

Select this choice to set the system date and time and to change the system time sent to the Advanced System Management Processor (service processor) when the server is started. This choice appears only on the full Configuration/Setup Utility main menu.

The system time is in a 24-hour format: hour:minute:second.

You can set a time delta to be added or subtracted from the system time that is sent to the service processor (Advanced System Management Processor) each time the server is started. Use the number keys to enter the hours and minutes and + or – to add or subtract from the system time. If you want the system clock time to be the same as the Advanced System Management Processor clock time, leave the value set at its default of 0.

- **System Security**

Select this choice to set passwords or a system owner's name. This choice appears only on the full Configuration/Setup Utility main menu.

You can implement two levels of password protection:

- **Power-on Password**

Select this choice to set or change a power-on password. See “Using passwords” on page 34 for more information.

- **Administrator Password**

Select this choice to set or change an administrator password.

**Attention:** If an administrator password is set and then forgotten, it cannot be overridden or removed. You must replace the system board.

The administrator password provides access to all choices on the Configuration/Setup Utility main menu. You can set, change, or delete both

the administrator and power-on passwords, and allow a power-on password to be changed by the user.

See “Using passwords” on page 34 for more information.

- **Start Options**

Select this choice to view or change the start options. This choice appears only on the full Configuration/Setup Utility main menu. Start options take effect when you start the server.

You can select keyboard operating characteristics, such as the keyboard speed. You also can specify whether the keyboard number lock starts on or off. You also can enable the server to run without a diskette drive, monitor, or keyboard.

**Note:** To determine if you should configure your server to operate without a keyboard see Table 16 on page 73.

The server uses a startup sequence to determine the device from which the operating system loads. For example, you can define a startup sequence that checks for a startable diskette in the diskette drive, then checks the hard disk drive in bay 1, and then checks a network adapter.

If the **Boot Fail Count** choice is enabled, you must restart the system three times to restore the system BIOS default settings. If this choice is disabled, the system BIOS defaults can only be restored from the Configuration/Setup Utility main menu.

You can enable a virus-detection test that checks for changes in the master boot record at startup.

- **Advanced Setup**

Select this choice to change values for advanced hardware features, such as cache control, and PCI configuration. This choice appears only on the full Configuration/Setup Utility main menu.

A warning message appears above the choices on this menu to alert you that the system might malfunction if these options are configured incorrectly. Follow the instructions on the screen carefully.

- **Processor Serial Number Access**

Select this choice to identify if the microprocessor serial number in the microprocessor is readable.

- **System Partition Visibility**

Select this choice to identify if the System Partition is visible. To make the System Partition visible, set this value to **Visible**. To make the System Partition invisible, set this value to **Hidden**.

- **Core Chipset Control**

Select this choice to modify settings that control features of the core chip set on the system board.



**Attention:** Do not make changes here unless directed to do so by an IBM authorized service representative.

— **Cache Control**

Select this choice to enable or disable the microprocessor cache. In addition, you can set the microprocessor cache mode to write-back (WB) or write-through (WT). Selecting write-back mode will provide the maximum system performance.

— **PCI Slot/Device Information**

Select this choice to view and identify system resources used by PCI devices. PCI devices automatically communicate with the server configuration information. This usually results in automatic configuration of a PCI device.

**Attention:** You must use the menu selections to save custom settings for the PCI Slot/Device Information choice. The save, restore and load default settings choices on the main menu of the Configuration/Setup Utility do not save the PCI Slot/Device Information settings.

**PCI Device Control** allows you to enable or disable the PCI slots from this menu.

- The default setting is Enable for all the PCI slots. If you select Disable, the system will not configure the disabled device and the operating system will not see the device. (This is equivalent to unplugging the device.)

— **Memory Settings**

Select this choice to manually disable or enable a bank of memory.

If a memory error is detected during POST or memory configuration, the server will automatically disable the failing memory bank and continue operating with reduced memory capacity. If this occurs, you must manually enable the memory bank after the problem is corrected. Select **Memory Settings** from the Advanced Setup menu, use the arrow keys to highlight the bank that you want to enable; then, use the arrow keys to select **Enable**.

• **Error Logs**

Select this choice to view or clear error logs.

- Select **POST Error Log** to view the three most recent error codes and messages that the system generated during POST.

Select **Clear error logs** from the POST Error Log menu to clear the error log.

- Select **System Event/Error Log** to view the system event/error log. The system event/error log contains all the system error and warning messages that the system has generated. You can use the arrow keys to move between pages in the system event/error log.

Select **Clear error logs** from the System Event/Error Log menu to clear the error or event log.

• **Save Settings**

Select this choice to save your customized settings.

• **Restore Settings**

Select this choice to delete your changes and restore the previous settings.

• **Load Default Settings**

Select this choice to cancel your changes and restore the factory settings.

- **Exit Setup**

If you have made any changes, the program will prompt you to save the changes or exit without saving the changes.

## Using passwords

The **System Security** choice appears only on the full Configuration/Setup Utility menu. After you select this choice, you can implement two levels of password protection: power-on password and administrator password.

### Power-on password

After you set a power-on password, you can enable the unattended-start mode. This locks the keyboard and mouse, but allows the system to start the operating system. The keyboard and mouse remain locked until you enter the correct password.

You can use any combination of up to seven characters (A–Z, a–z, 0–9 and blanks) for your power-on password. Keep a record of your password in a secure place. If you forget the power-on password, you can regain access to the server through one of the following methods:

- If an administrator password is set, enter the administrator password at the power-on prompt. Start the Configuration/Setup Utility program and change the power-on password.
- Change the position of the password override jumper as described in “Setting the password override switch”.
- Remove the battery and then install the battery.

**Setting the password override switch:** The following illustration shows the location of the password override switch, switch 8 of switch block 1, on the system board.

**Note:** The illustrations in this document might differ slightly from your hardware.

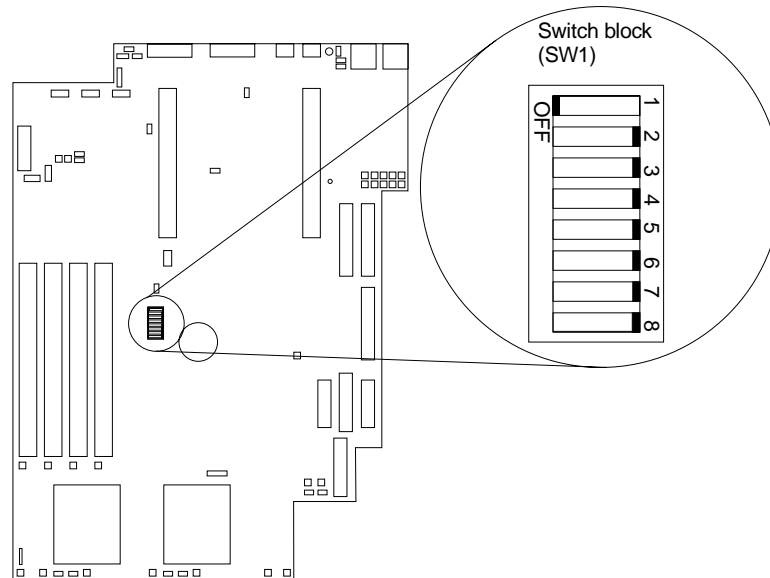

To set the password override switch:

1. Review the information in “Before you begin” on page 42.

2. Turn off the server and peripheral devices and disconnect all external cables and power cords; then, remove the cover. See “Removing the cover” on page 44.
3. Toggle switch 8 on switch block 1 on the system board. This clears the power-on password for one boot cycle.

**Note:** This means that you can now start or power-up the server one time without having to use the power-on password. But if you do not use the Configuration/Setup Utility program to change or delete the password, the next time you start the server the original power-on password will be reinstated.

4. Connect the server to a power source, keyboard, monitor, and mouse.
5. Power-up the server.

**Note:** You can now start the Configuration/Setup Utility program and either delete the old or set a new power-on password.

### Administrator password

Select this choice to set an administrator password. The administrator password provides access to all choices on the Configuration/Setup Utility main menu. You can set, change, or delete both the administrator and power-on passwords, and allow a power-on password to be changed by the user.

**Attention:** If an administrator password is set and then forgotten, it cannot be overridden or removed. You must replace the system board.

The following table provides a summary of the password features.

*Table 8. Power-on and administrator password features.*

Type of password	Results
Power-on password	<ul style="list-style-type: none"> <li>• Enter the password to complete the system startup.</li> <li>• A limited set of choices is available on the Configuration/Setup Utility main menu.</li> </ul>
Administrator password	<ul style="list-style-type: none"> <li>• No password is required to start the system.</li> <li>• Enter the password to access the Configuration/Setup Utility program.</li> <li>• All choices are available on the Configuration/Setup Utility main menu.</li> </ul>
Administrator <i>and</i> power-on password	<ul style="list-style-type: none"> <li>• You can enter either password to complete the system startup.</li> <li>• The administrator password provides access to all choices on the Configuration/Setup Utility main menu. You can set, change, or delete both the administrator and power-on passwords, and allow a power-on password to be changed by the user.</li> <li>• The power-on password provides access to a limited set of choices on the Configuration/Setup Utility main menu. This limited access might include changing or deleting the power-on password.</li> </ul>

---

## Using the SCSISelect utility program

SCSISelect is a built-in, menu-driven configuration utility program that you can use to:

- View the default SCSI IDs
- Locate and correct configuration conflicts
- Perform a low-level format on a SCSI hard disk

The following sections provide the instructions needed to start the SCSISelect Utility and descriptions of the menu choices available.

**Note:** If the server has a RAID adapter installed, use the configuration method supplied with the RAID adapter to view or change SCSI settings for attached devices.

### Starting the SCSISelect utility program

To start the SCSISelect utility program:

1. Turn on the server.
2. When the <<< Press <CTRL><A> for SCSISelect™ Utility! >>> prompt appears, press Ctrl+A.

**Note:** If an administrator password has been set, a prompt appears asking you to enter the password to start the SCSISelect Utility program.

3. Use the arrow keys to select a choice from the menu.
  - Press Esc to return to the previous menu.
  - Press the F5 key to switch between color and monochrome modes (if your monitor permits).
4. Follow the instructions on the screen to change the settings of the selected items; then, press Enter.

### Choices available from the SCSISelect menu

The following choices appear on the SCSISelect Utility menu:

- **Configure/View Host Adapter Settings**  
Select this choice to view or change the SCSI controller settings. To reset the SCSI controller to its default values, press F6; then, follow the instructions that appear on the screen.

You can view or change the following controller settings:

- **Host Adapter SCSI ID**  
Select this choice to view the SCSI controller ID, normally 7.
- **SCSI Parity Checking**  
Select this choice to view the assigned value of *Enabled*.
- **Host Adapter SCSI Termination**  
Select this choice to view the assigned value of *Enabled*.
- **Boot Device Options**

Select this choice to configure startable device parameters. Before you can make updates, you must know the ID of the device whose parameters you want to configure.

— **SCSI Device Configuration**

Select this choice to configure SCSI device parameters. Before you can make updates, you must know the ID of the device whose parameters you want to configure.

**Note:** The Maximum Sync Transfer Rate represents the transfer rate for Ultra SCSI devices.

- The transfer rate for Ultra3 SCSI LVD devices is 160.0
- The transfer rate for Ultra2 SCSI LVD devices is 80.0
- The transfer rate for Fast SCSI devices is 20.0

— **Advanced Configuration Options**

Select this choice to view or change the settings for advanced configuration options.

• **SCSI Disk Utilities**

Select this choice to view the SCSI IDs that are assigned to each device or to format a SCSI device.

To use the utility program, select a drive from the list. Read the screens carefully before making a selection.

**Note:** If you press Ctrl+A before the selected drives are ready, an Unexpected SCSI Command Failure screen might appear. Restart the server and watch the SCSISelect messages as each drive spins up. After the drive that you want to view or format spins up, press Ctrl+A.

## Using the Preboot eXecution Environment boot agent utility program

The Preboot eXecution Environment (PXE) boot agent is a built-in, menu-driven configuration utility program that you can use to:

- Change network startup (boot) protocols
- Change startup (boot) order
- Select whether or not to display setup prompt
- Set menu wait time
- Select OS wake up support

### Starting the PXE boot agent utility program

The following sections provide the instructions needed to start the PXE Boot Agent Utility and descriptions of the menu choices available.

To start the PXE Boot Agent Utility program:

1. Turn on the server.
2. When the Initializing Intel (R) Boot Agent Version X.X.XX PXE 2.0 Build XXX (WfM 2.0) prompt appears, press Ctrl+S.

**Note:** By default you will have 2 seconds after the prompt appears on the screen to press Ctrl+S.

3. Use the arrow keys or press Enter to select a choice from the menu.
  - Press Esc to return to the previous menu.
  - Press the F4 key to exit.
4. Follow the instructions on the screen to change the settings of the selected items; then, press Enter.

### Choices available from the PXE boot agent utility

The following choices appear on the PXE boot agent utility menu:

- **Network Boot Protocol**  
PXE is the default value for this menu item.  
**Note:** Do not change this value. There are no other network boot protocols supported.
- **Boot Order**  
Select this choice to change the order in which boot devices are queried.
  - Try local drives first, then network (Default)
  - Try network only
  - Try local drives only
  - Try network first, then local drives
- **Show setup prompt**  
Select this choice to either display the PXE setup prompt or disable it. Disable is the default setting.  
  
When this choice is enabled **Press Ctrl+S to enter the setup menu** will appear on the screen under the initializing prompt.
- **Setup time wait menu**  
Select this choice to set up the amount of time (in seconds) that the system will pause during initialization for a Ctrl+S input.
  - 2 seconds (Default)
  - 3 seconds
  - 5 seconds
  - 8 seconds
- **Legacy OS wake up support** Select this choice to allow/disallow a non-windows operating system to use adapter remote wake up capability.
  - Disabled (Default)
  - Enabled

---

## Chapter 5. Installing options

This chapter provides instructions to help you add options to the server. Some option-removal instructions are provided, in case you need to remove one option to install another. For a list of supported options for the server, see the Server Proven list at: <http://www.ibm.com/pc/compat>

---

### Major components of the xSeries 330 server

The following illustration shows the locations of major components in the server.

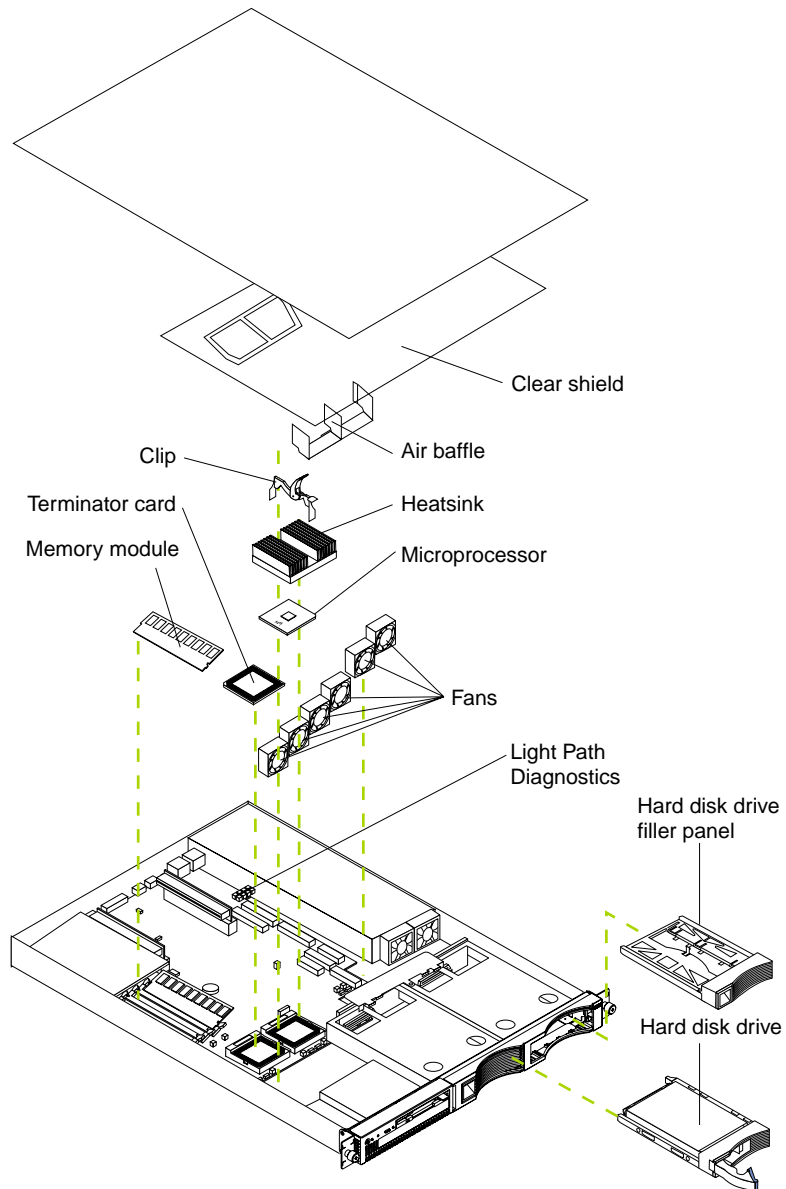

# System board

The illustrations in the following sections show the components on the system board.

## System board options connectors

The following illustration identifies the connectors on the system board.

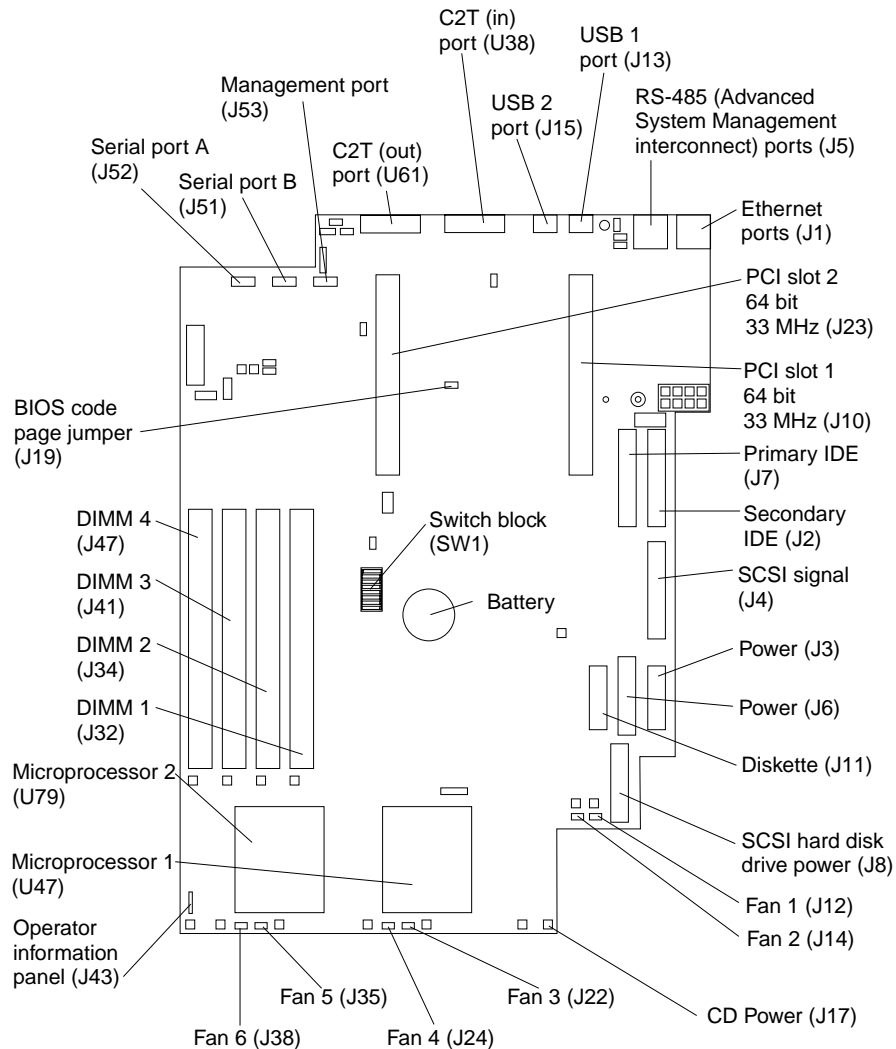

### System board jumper blocks

Any jumper blocks on the system board that are not shown in the illustration are reserved. For normal operation of the system, no jumpers should be installed on any of the jumper blocks. See “Recovering BIOS” on page 18 for information about the Flash ROM page-swap jumper.

### System board switch block

The switch block contains microswitches 1-8. As pictured in this illustration, switch 1 is at the top of the switch block and switch 8 is at the bottom. For more information about this switch block see “Setting the password override switch” on page 34.



The following table describes the function for each switch.

Table 9. Switches 1-8.

Switch number	Switch description
1	Reserved.
2	Reserved.
3	Reserved.
4	Reserved.
5	Force power-on. The default setting is Off (disabled).
6	Reserved. The default setting is Off.
7	Reserved. The default setting is Off.
8	Bypass power-on password.  When toggled to the opposite position, bypasses the power-on password, if one is set, for one boot cycle. See "Setting the password override switch" on page 34.

## System board LEDs

The following illustration identifies the LEDs on the system board.

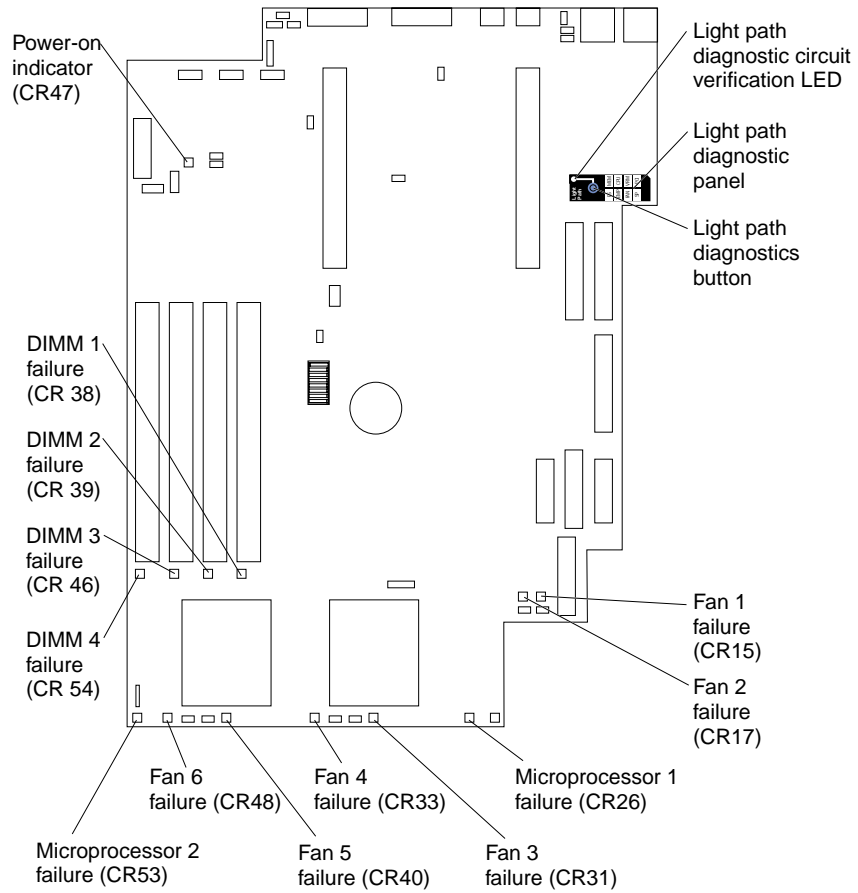

---

## Before you begin

Before you begin to install options in the server, read the following information:

- Become familiar with the safety and handling guidelines specified under “Handling electrostatic discharge-sensitive devices” on page 110, and read the safety statements in “Safety information” on page 107. These guidelines will help you work safely while working with the server or options.
- Make sure that you have an adequate number of properly grounded electrical outlets for the server, monitor, and any other options that you intend to install.
- Back up all important data before you make changes to disk drives.
- Have a small, flat-blade screwdriver available.
- For a list of supported options for the server, refer to <http://www.ibm.com/pc/us/compat> on the World Wide Web.
- For your convenience during setup and service you might want to have a separate location where you can temporarily connect the server to a power source (using a separate power cord), keyboard, monitor, and mouse (using a separate C2T device breakout cable). Additional C2T cables are available in the cable option kit.

## System reliability considerations

To help ensure proper cooling and system reliability, make sure:

- Each of the drive bays has either a drive or a filler panel installed.
- The cover is in place during normal operations, or is removed for no longer than 30 minutes while the server is operating.
- There is space around the server to allow the server cooling system to work properly. Leave about 127 mm (5 in.) of space around the front and rear of the server.
- Cables for optional adapters are routed according to the instructions provided with the adapters.
- A failed fan is replaced within 48 hours.

## Working inside a server with power on

Your server is designed to operate safely while turned on with the cover removed. Follow these guidelines when you work inside a server that is turned on:

- Avoid loose-fitting clothing on your forearms. Button long-sleeved shirts before working inside the server; do not wear cuff links while you are working inside the server.
- Do not allow your necktie or scarf to hang inside the server.
- Remove jewelry, such as bracelets, rings, necklaces, and loose-fitting wrist watches.
- Remove items from your shirt pocket (such as pens or pencils) that could fall into the server as you lean over it.
- Take care to avoid dropping any metallic objects, such as paper clips, hair pins, or screws, into the server.

---

## Rack installation

Do the following to install the server in the rack. Reverse the steps to remove the server from the rack.

1. Lift and place the server on the lower edge of the mounting bracket.
2. Slide the server as far back as it will go.

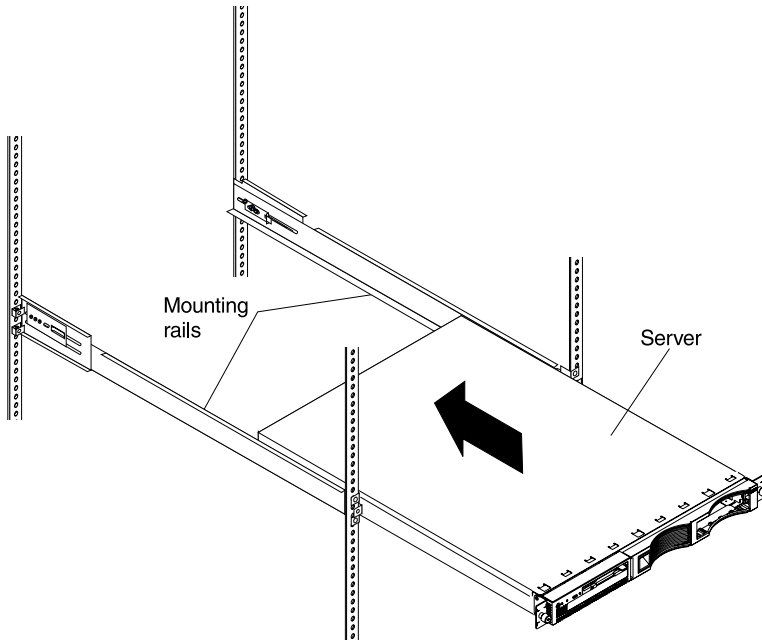

3. Using the thumb screws on the front of the server; secure the server to the brackets.

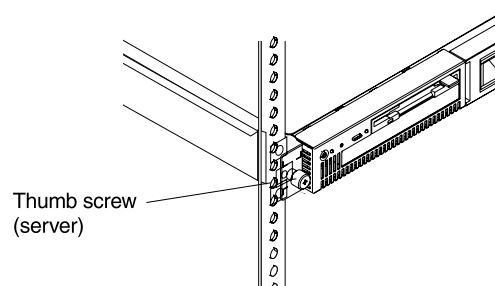

4. If you have additional servers to install, repeat steps 1 through 3 for each xSeries 330.
5. Install all external cables and power cords to the servers.

---

## Removing the cover

The following information describes how to remove the cover.

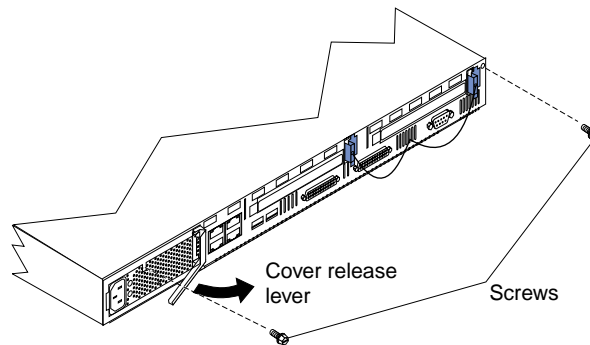

Complete the following steps to remove the cover from the server:

1. Review the information in "Before you begin" on page 42.
2. Turn off the server and all attached devices and disconnect all external cables and power cords.
3. Remove the server from the rack (see "Rack installation" on page 43).
4. Remove the two screws from the rear of the server.
5. Pull out on the cover release lever at the back of the server, to release the cover.
6. Slide the cover back, then up and off the server.

**Attention:** For proper cooling and airflow, replace the cover before turning on the server. Operating the server for extended periods of time (over 30 minutes) with the cover removed might damage server components.

7. Remove the clear shield that covers the inside of the server.

**Note:** It is not necessary to remove the shield when you are installing memory modules or installing an adapter in the PCI slots.

---

## Working with adapters

The server comes with two peripheral component interconnect (PCI) adapter slots on the system board with riser cards installed in them.

**Attention:** Your server also comes with an integrated video controller on the system board. When you install a video adapter in a PCI slot, the server BIOS automatically disables the integrated video controller. This allows the video adapter in the PCI slot to control the video functions for your monitor.

The following illustration shows the location of the 33 MHz PCI expansion slots on the system board.

**Note:** The illustrations in this document might differ slightly from your hardware.

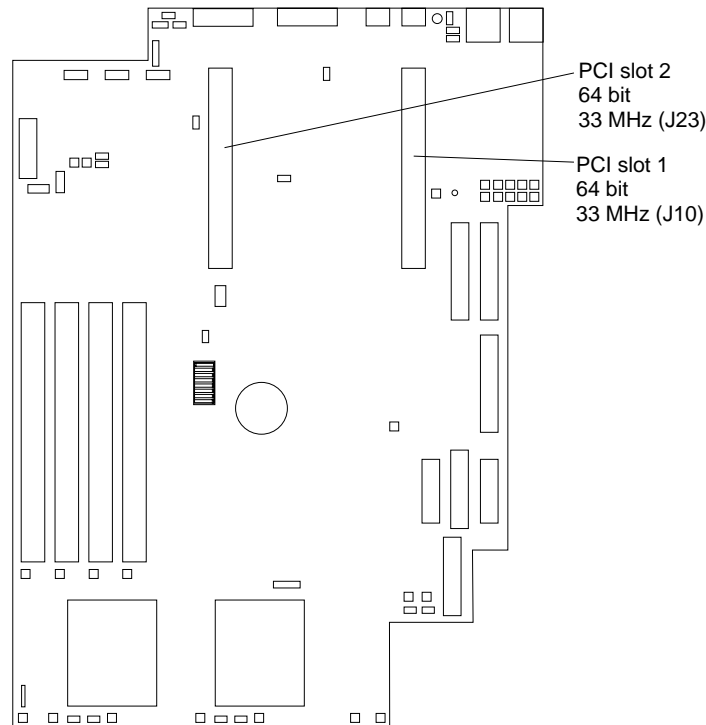

## Adapter considerations

Before you install adapters, review the following:

- Locate the documentation that comes with the adapter and follow those instructions in addition to the instructions in this chapter. If you need to change the switch settings or jumper settings on your adapter, follow the instructions that come with the adapter.
- You can install 32-bit or 64-bit full-length or half-length adapters in the expansion slots. Full-length adapters are installed in slot 1; half-length adapters are installed in either slot 1 or 2.
- Your server supports 5.0 V and universal PCI adapters; it does not support 3.3 V only adapters.
- Your server uses a rotational interrupt technique to configure PCI adapters. Because of this technique, you can install PCI adapters that currently do not support sharing of PCI interrupts.
- PCI slots 1 and 2 and the integrated SCSI controller are on PCI bus B; the system board and all other integrated devices are on PCI bus A.  
**Note:** PCI bus A = bus 0; PCI bus B = bus 1.
- The system scans PCI slots 1 and 2 to assign system resources. By default the system starts (boots) devices in the following order: System SCSI devices, then PCI devices.  
**Note:** To change the **boot precedence**, start the Configuration/Setup Utility, select **Start Options** from the main menu; then, select the **PCI SCSI adapter boot option**.

## Installing an adapter

Complete the following steps to install an adapter:

**Attention:** When you handle electrostatic discharge (ESD) sensitive devices, take precautions to avoid damage from static electricity. For details on handling these devices, refer to “Handling electrostatic discharge-sensitive devices” on page 110.

1. Review the safety precautions that are listed in “Chapter 9. Related service information,” on page 107.
2. Turn off the server and peripheral devices and disconnect all external cables and power cords.
3. Remove the server from the rack; then, remove the cover as shown. For more information see “Removing the cover” on page 44.

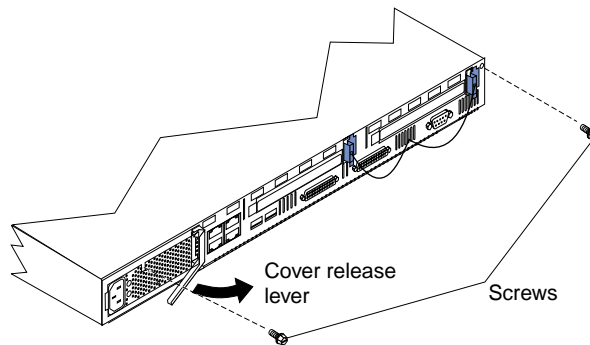

4. Remove the expansion slot clip that holds the expansion slot cover in place by sliding it upward and off the frame of the server.

**Note:** The illustrations in this document might differ slightly from your hardware.

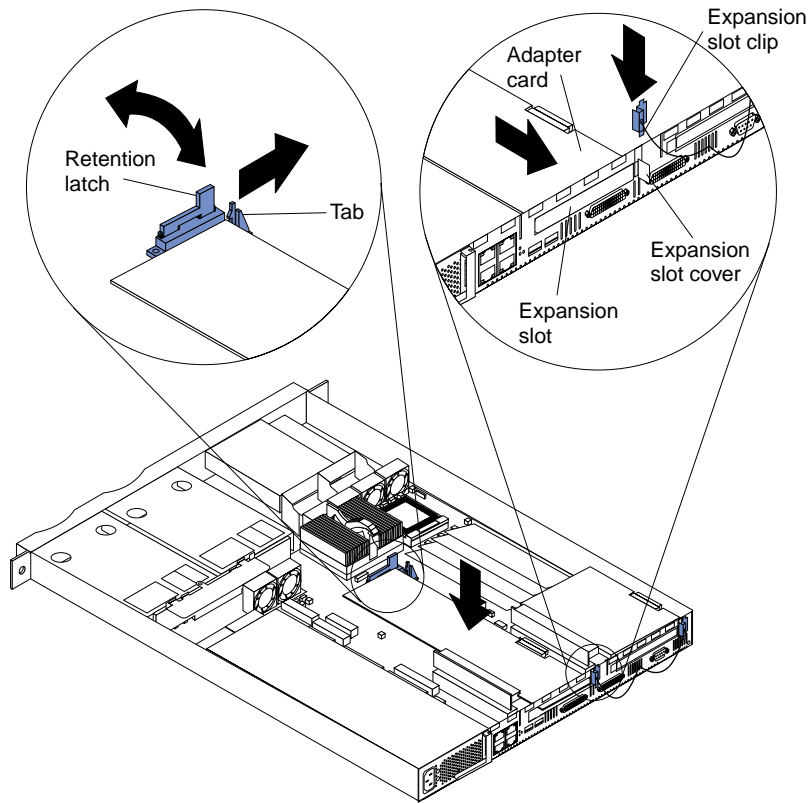

5. Remove the expansion-slot cover.
6. Refer to the documentation that comes with your adapter for any cabling instructions.  
**Attention:** You should route adapter cables before you install the adapter.
7. Set any jumpers or switches as described by the adapter manufacturer.
8. Install the adapter:
 

**Note:** When installing an adapter into slot 2, skip steps a and d.

  - a. Open the adapter retention latch by pushing the blue tab to release it. Then push the latch up to the full open position.
  - b. Carefully grasp the adapter by its top edge or upper corners, and align it with the connector on the PCI riser-card.
  - c. Press the adapter *firmly* into the riser-card connector.  
**Attention:** When you install an adapter, be sure the adapter is correctly seated in the riser-card connector before you turn on the server. Improperly seated adapters might cause damage to the system board, the riser-card, or the adapter.
  - d. Push down on the blue adapter retention latch until it clicks into place, securing the adapter.
  - e. Replace the expansion slot clip by sliding it down until it latches into place and holds the adapter securely.
9. Connect the internal cables to the adapter.

**Attention:** Route cables so that they do not block the flow of air from the fans.

**Note:** When installing a ServeRAID adapter remove the cable from the SCSI connector (J4) on the system board and attach it to the ServeRAID adapter.

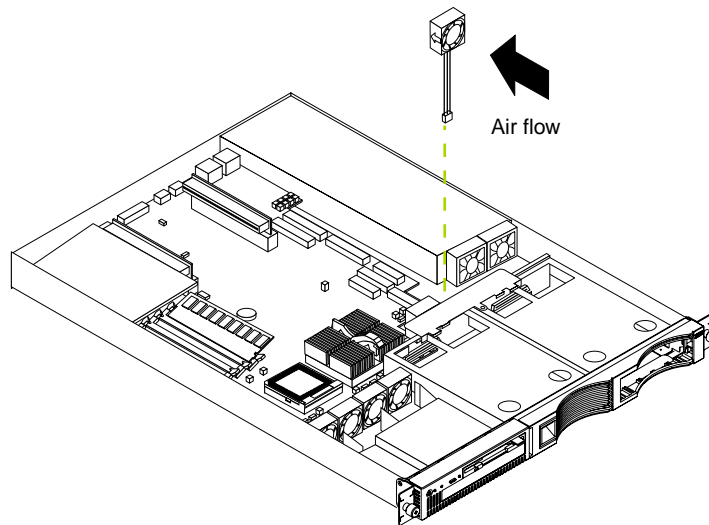

10. Install the cover see “Removing the cover” on page 44.

11. Turn on the server.

---

## Hard disk drives

The server supports two 1-inch (26 mm) slim 3.5-inch low voltage differential (LVD) hard disk drives. If you can hot-swap hard disk drives.

**Notes:**

1. You can hot-swap a hard disk drive only if a ServeRAID adapter configured as RAID1 is installed in the system. If you use any other ServeRAID or SCSI configuration, you cannot hot-swap the hard disk drive.
2. For more information on hot-swap disk drives refer to “Hot-swap disk drives” on page 50.

Each hard disk drive tray has a status and an activity light located on the upper-right corner of tray (see “Server controls and indicators” on page 6 for the location of the status and activity indicators). These lights are used to show when there is drive activity or, in some cases, when there is a problem with your hard disk drive.

- The drive must be a low voltage differential drive (LVD), and have a single connector attached (SCA) connector.
- The hard disk drive bays connect to a SCSI *backplane*. This backplane is the printed circuit board behind the bay and is connected to J4 on the system board.
- The backplane controls the SCSI IDs for the hard disk drives.

## Preinstallation steps

Before you install a hard disk drive, review the following.



- Inspect the drive tray for any signs of damage.
- Ensure that the drive is installed properly in the tray.
- To maintain proper system cooling, do not operate the server for more than two minutes without either a drive or a filler panel installed in each bay.
- If your server has a ServeRAID adapter installed; refer to the documentation provided with the ServeRAID adapter for information about adding a drive.
- Read the safety precautions listed in “Safety information” on page 107, “Handling electrostatic discharge-sensitive devices” on page 110.
- Check the instructions that come with the drive for more information about installing the drive.

## Installing or replacing a hard disk drive

Refer to the following illustration to install a hard disk drive:

**Note:** The illustrations in this document might differ slightly from your hardware.

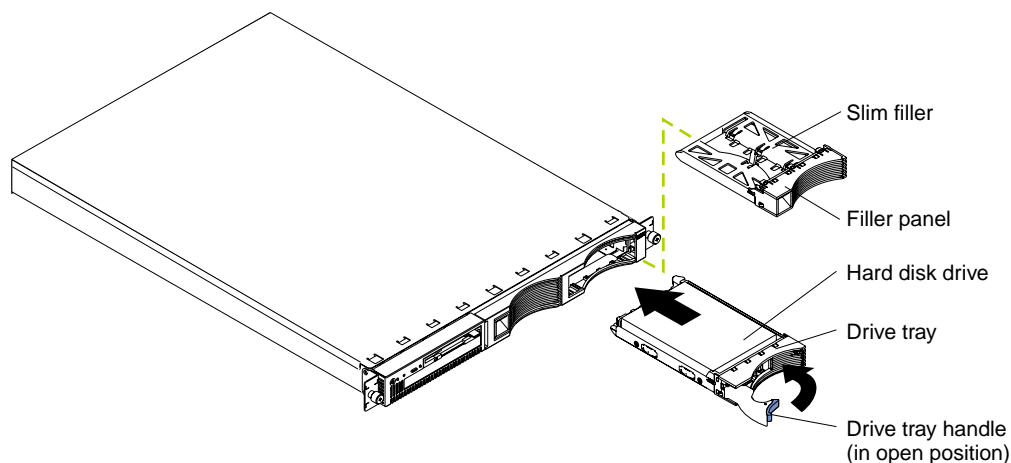

### Attention:

- When you handle electrostatic discharge (ESD) sensitive devices, take precautions to avoid damage from static electricity. For details on handling these devices, refer to “Handling electrostatic discharge-sensitive devices” on page 110.
1. Review the information in “Before you begin” on page 42.
  2. Turn off the server and all attached devices, and disconnect all external cables and power cords.
  3. Remove the filler panel or defective hard drive from one of the hard disk drive bays.
  4. Install the new hard disk drive in the drive bay:
    - a. Ensure the tray handle is open (that is, perpendicular to the drive).
    - b. Align the rails on the drive assembly with the guide rails in the drive bay.
    - c. Gently push the drive assembly into the bay until the drive connects to the backplane.
    - d. Push the tray handle toward the closed position until it locks the drive in place.
  5. Reconnect the external cables and power cords; then, turn on the server.

6. Check the hard disk drive status indicators to verify that the hard disk drives are operating properly. (See “Server controls and indicators” on page 6 for the location of the status indicators.)
  - When the green light flashes rapidly (three flashes per second), the controller is identifying the drive.

Replacing a hard disk drive is done in the same manner as installing a new hard disk drive.

If the server has a Redundant Array of Independent Disks (ServeRAID) adapter installed, you can hot-swap drives. For more information about hot-swapping drives refer to the documentation provided with the ServeRAID adapter, “Hot-swap disk drives”, and to the notes under “Hard disk drives” on page 48.

---

## Hot-swap disk drives

Your server can be configured with hardware to let you continue to operate your system while removing or installing hard disk drives (or hot-swapping). To do this you need a ServeRAID adapter, hard disk drive, and the hard disk drive tray.

- Each hard disk drive that you plan to install must have an accompanying hard disk drive tray.
- The drive must be a low-voltage differential drive (LVD), and have a single connector attached (SCA) connector.
- The hard disk drive bays connect to a SCSI *backplane*. This backplane is the printed circuit board behind the bay and is connected to the ServeRAID adapter.
- The backplane controls the SCSI IDs for the hard disk drives.

## Preinstallation steps

Before you install a hard disk drive, review the following.

- Inspect the drive tray for any signs of damage.
- Ensure that the drive is installed properly in the tray.
- To maintain proper system cooling, do not operate the server for more than two minutes without either a drive or a filler panel installed in each bay.
- If your server has a ServeRAID adapter installed; refer to the documentation provided with the ServeRAID adapter for information about adding a drive.
- Read the safety precautions listed in “Safety information” on page 107, “Handling electrostatic discharge-sensitive devices” on page 110.
- Check the instructions that come with the drive to see if you need to set any switches or jumpers on the drive.

## Installing hot-swap disk drives

**Note:** The illustrations in this document might differ slightly from your hardware.

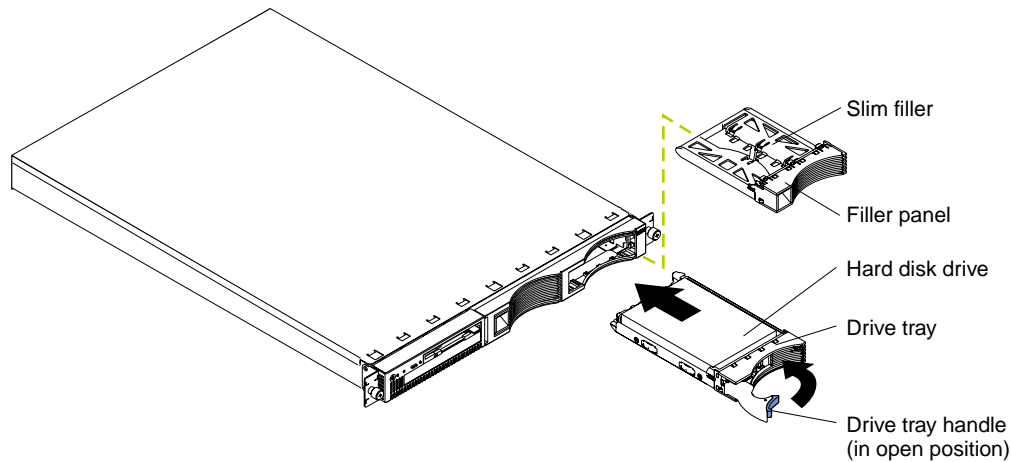

Complete the following steps to install a hot-swap drive in a hot-swap drive bay:

**Attention:**

- To maintain proper system cooling, do not operate the server for more than two minutes without either a drive or a filler panel installed for each bay.
  - When you handle electrostatic discharge sensitive devices (ESD), take precautions to avoid damage from static electricity. For details on handling these devices, refer to “Handling electrostatic discharge-sensitive devices” on page 110.
1. Remove the filler panel from one of the empty hot-swap bays by inserting your finger into the depression at the left side of the filler panel and pulling it away from the server.
  2. Install the hard disk drive in the hot-swap bay:
    - a. Ensure the tray handle is open (that is, perpendicular to the drive).
    - b. Align the rails on the drive assembly with the guide rails in the drive bay.
    - c. Gently push the drive assembly into the bay until the drive connects to the backplane.
    - d. Push the tray handle toward the closed position until it locks the drive in place.
  3. Check the hard disk drive status indicators to verify that the hard disk drives are operating properly. See “Server controls and indicators” on page 6 for the location of the status indicators.)
    - When a ServeRAID adapter is installed and:
      - The amber light is on continuously, the drive had failed.
      - The green light flashes slowly (one flash per second), the drive is being rebuilt.
      - The green light flashes rapidly (three flashes per second), the controller is identifying the drive.

**Replacing a drive in a hot-swap bay**

You do not have to turn off the server to remove or install the hot-swap drives.

1. Before you remove a hot-swap hard disk drive that is not defective, back up all important data.

2. To avoid damage to a hard disk drive, do not remove the drive from the hot-swap bay until it has had time to spin down (approximately 30 seconds). Handle the drive carefully.
3. Before you replace a hot-swap drive, make sure it is defective. If you partially or completely remove a good drive instead of a defective one, the server might lose valuable data.

This situation is especially relevant if the server has a ServeRAID adapter installed and you assigned ServeRAID level 0 or 1 to the logical drives in your disk array. The ServeRAID adapter can rebuild the data that you need, provided that certain conditions are met. Refer to the information provided with the ServeRAID adapter for further details.

Refer to the following illustration while you perform the steps in this procedure.

**Note:** The illustrations in this document might differ slightly from your hardware.

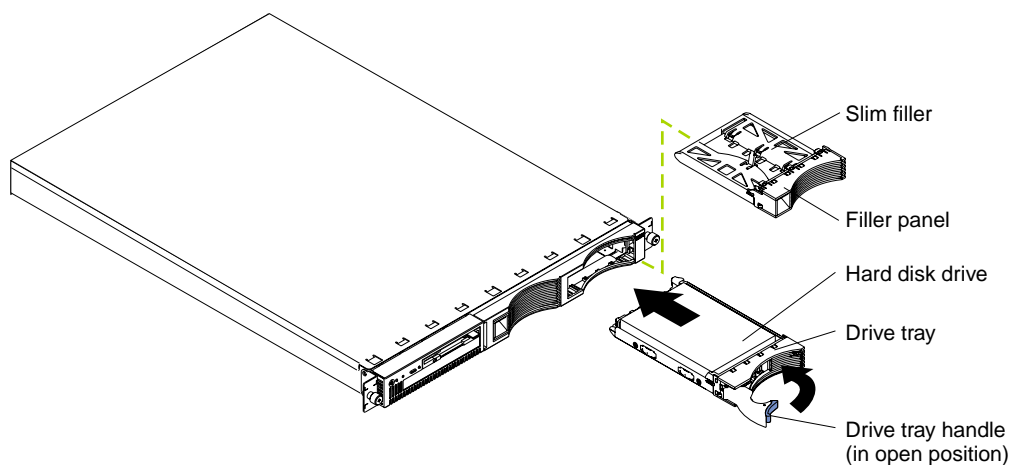

Complete the following steps to replace a drive in a hot-swap bay:

1. Before you begin, read the documentation that comes with your drive.
2. Locate the defective drive (look for an amber Hard Disk Status light on the front of the drive).
3. Remove the defective hard disk drive:
  - a. Move the handle on the drive to the open position (perpendicular to the drive)
  - b. Pull the hot-swap drive assembly from the bay.
4. Install the hard disk drive in the hot-swap bay:
  - a. Ensure the tray handle is open (that is, perpendicular to the drive).
  - b. Align the rails on the drive assembly with the guide rails in the drive bay.
  - c. Gently push the drive assembly into the bay until the drive connects to the backplane.
  - d. Push the tray handle toward the closed position until it locks the drive in place.
5. Check the hard disk drive status indicators to verify that the hard disk drive is installed properly (see “Server controls and indicators” on page 6 for the location of the status indicators).
  - When a ServeRAID adapter is installed and:
    - The amber light is on continuously, the drive has failed.

- The green light flashes slowly (one flash per second), the drive is being rebuilt.
- The green light flashes rapidly (three flashes per second), the controller is identifying the drive.

---

## Memory

Adding memory to the server is an easy way to improve system performance. You can increase the amount of memory in the server by installing options called *memory-module kits*. Each kit contains one industry-standard, dual-inline memory module (DIMM). Your server uses a noninterleaved memory configuration, which allows you to add, remove, or replace one DIMM at a time. In an interleaved system you would have to add, remove, or replace memory in sets.

The server comes with a dual inline memory module (DIMM) installed on the system board in DIMM slot 1.

**Note:** Install additional DIMMs in the following order: DIMM connector 2, then 3, then 4. (See the following illustration for memory connector locations.)

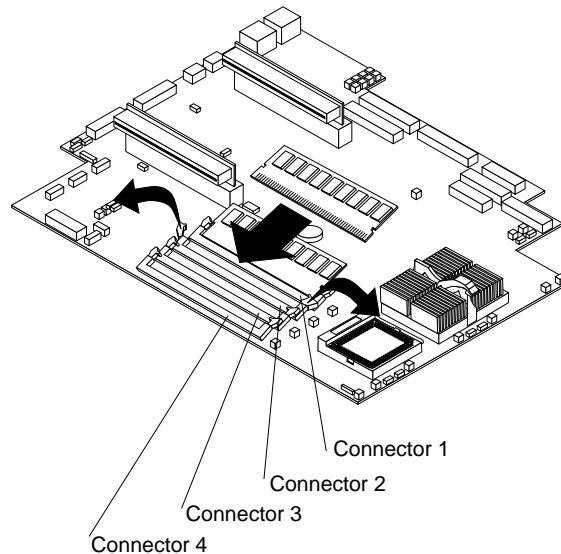

## Installing memory modules

Complete the following steps to install a DIMM:

**Attention:** When you handle electrostatic discharge-sensitive devices (ESD), take precautions to avoid damage from static electricity. For details on handling these devices, refer to “Handling electrostatic discharge-sensitive devices” on page 110.

1. Review the information in “Before you begin” on page 42 and the documentation that comes with your option.
2. Turn off the server and peripheral devices and disconnect the power cord and all external cables; then, remove the cover (see “Removing the cover” on page 44 for details).
3. If necessary, remove the PCI card in slot 2 for easier access to the DIMM connectors.
4. Touch the static-protective package containing the DIMM to any unpainted metal surface on the server. Then, remove the DIMM from the package.

**Attention:** To avoid breaking the retaining clips or damaging the DIMM connectors, handle the clips gently.

5. Install the DIMM in the connector.

**Attention:** To prevent damage to the DIMM connectors do not force the memory module into the connector.

- a. Turn the DIMM so that the index slots align correctly with the connector.

**Note:** The DIMM has two index slots, one in the center and the other on the left half of the DIMMS connector edge.

- b. Insert the DIMM into the connector by pressing on both corners of the DIMM at the same time. Be sure to press straight into the connector.

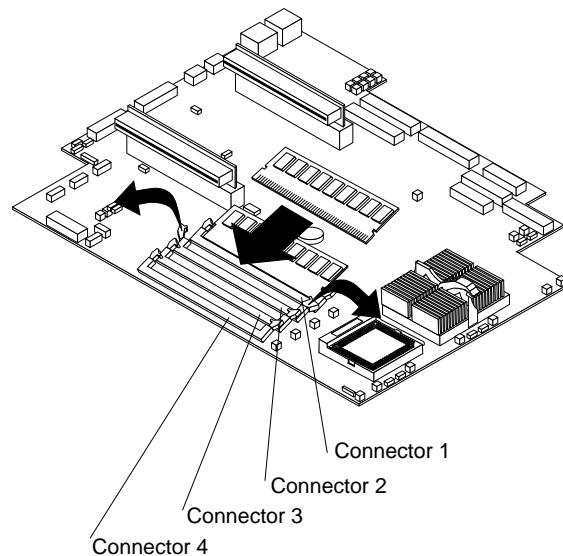

- c. When installing a memory module be sure that no gap exists between the DIMM and the retaining clips. If a gap does exist between the memory module and the retaining clips: open the retaining clips, remove the DIMM; then, reinsert the DIMM properly.

**Note:** It is a good idea to install or remove any other options at this time.

6. Turn on the server.

**Attention:** When you restart the server, the system displays a message indicating that the memory configuration has changed.

- If you installed additional memory, start the Configuration/Setup Utility program and select Save Settings.
- If you just replaced a failed DIMM, you must start the Configuration/Setup Utility program, select Advanced Setup, select Memory Settings, highlight the connector or bank of connectors that you want to enabled, and then select Enable.
- In some memory configurations, the 3-3-3 beep code might sound during POST followed by a blank display screen. If this occurs and the Boot Fail Count feature in the Start Options of the Configuration/Setup Utility is set to Enabled (its default setting), you must restart the server three times (a "three-boot reset") to force the system BIOS to reset the memory connector or bank of connectors from Disabled to Enabled.

## Microprocessor

The server comes with one or two microprocessors installed on the system board. If you have two, or had one and you installed a second microprocessor, the server can operate as a symmetric multiprocessing (SMP) server. With SMP, certain operating systems and application programs can distribute the processing load between the microprocessors. This enhances performance for database and point-of-sale applications, integrated manufacturing solutions, and other applications.

### Notes:

1. Before you install a new microprocessor, review the documentation that comes with the microprocessor, so that you can determine whether you need to update the server basic input/output system (BIOS). The latest level of BIOS for the server is available through the World Wide Web.
2. Obtain an SMP-capable operating system (optional). For a list of supported operating systems, see <http://www.ibm.com/pc/us/compat/> on the World Wide Web.
3. If the server comes with one microprocessor, it is installed in microprocessor connector 1. This is the startup (boot) microprocessor. If you install a second microprocessor in microprocessor connector 2, the two microprocessors will share the system load after the system has started.

**Attention:** To avoid damage and ensure proper server operation install microprocessors that are the same type, and have the same cache size and the same clock speed. Microprocessor internal clock frequencies and external clock frequencies must be identical. See the ServerProven list at <http://www.ibm.com/pc/compat/> for a list of microprocessors for use with the server.

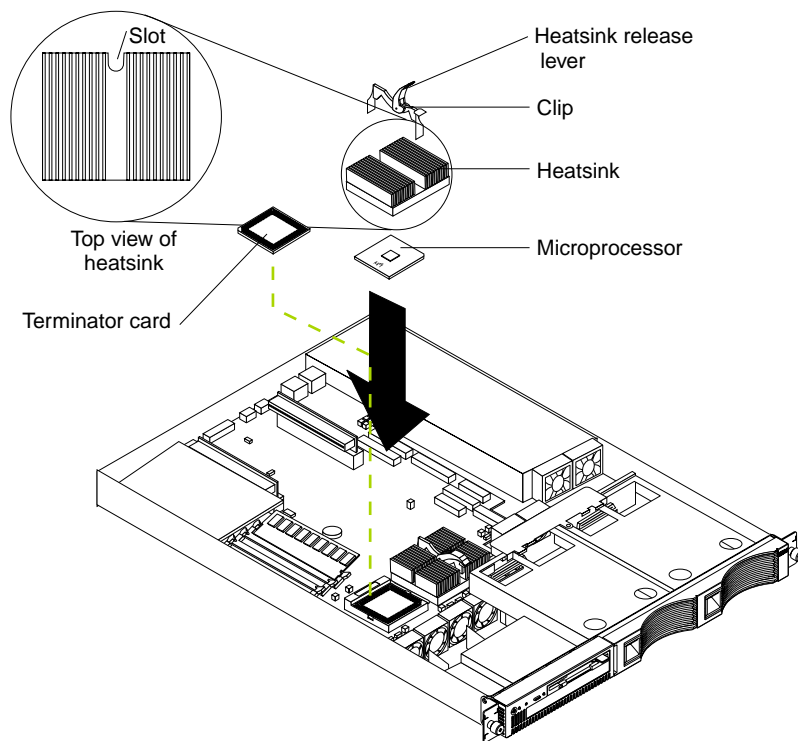

## Installing the microprocessor

Complete the following steps to install an additional microprocessor:

**Attention:** When you handle electrostatic discharge-sensitive devices (ESD), take precautions to avoid damage from static electricity. For details on handling these devices, refer to the following Web site and use a search term of ESD:  
<http://www.ibm.com/>

1. Review the safety precautions listed in “Safety information” on page 107.
2. Turn off the server and peripheral devices and disconnect the power cord and all external cables; then remove the cover (see “Removing the cover” on page 44 for details).
3. Remove the clear shield from the server and store it in a safe place.
4. Lift up the microprocessor release lever and remove the terminator card from the microprocessor connector. (After you remove the new microprocessor from the static-protective package, place the terminator card in the bag and store it in a safe place. You will need to install the terminator card again if you ever remove the microprocessor and do not replace the microprocessor.)
5. Install the microprocessor:
  - a. Touch the static-protective package containing the new microprocessor to any *unpainted* metal surface on the server; then, remove the microprocessor from the package.
  - b. Orient the microprocessor over the microprocessor connector as shown in the illustration. Carefully press the microprocessor into the connector.

**Note:** To avoid bending the pins on the microprocessor, do not use excessive force when pressing it into the connector.

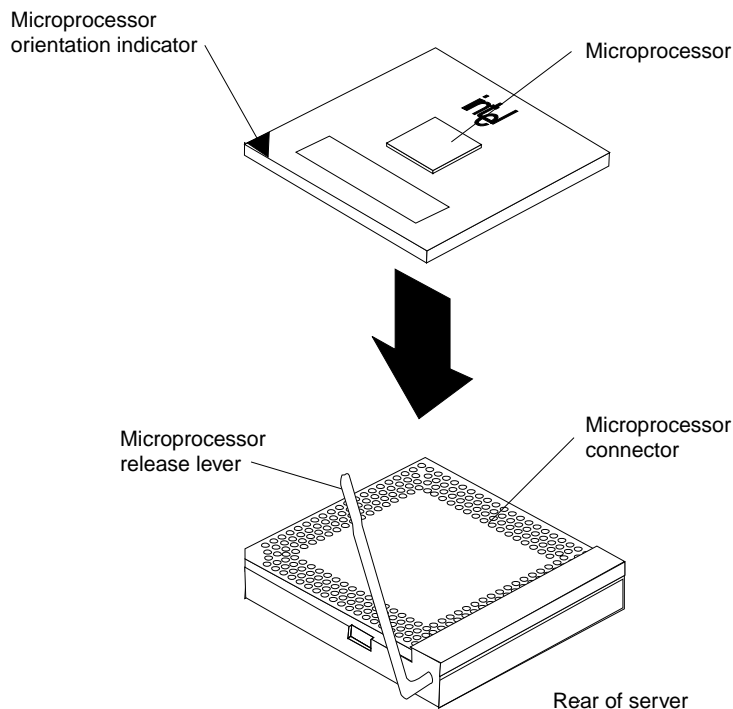



6. Push the microprocessor release lever down to lock the microprocessor into place.
7. Install the heat sink on the microprocessor:
  - a. Peel the plastic protective strip off the bottom of the heat sink. Make sure the square of thermal material is still on the bottom of the heat sink.
  - b. Align and place the heat sink on top of the microprocessor.  
**Note:** Locate the slot in the channel of the heat sink. Orientate the heat sink so the slot will be at the rear of the server.
  - c. Align and place the clip over the heat sink; then, snap the clip into place over the heat sink with the heat sink release lever in the up position.  
**Note:** If you remove the microprocessor later, remember to install the terminator card in the appropriate microprocessor connector.
  - d. Press the heat sink release lever down into the locked position once the clip is in place.
8. Replace the clear shield, then go to “Installing the cover” on page 61.  
**Note:** It is very important to replace the clear shield.
9. Start the server and run the Configuration/Setup Utility program.

## Removing a microprocessor

Do the following to remove a microprocessor:

**Note:** Do not use any tools when removing the microprocessor.

**Attention:** When you handle Electrostatic Discharge-Sensitive devices (ESD), take precautions to avoid damage from static electricity. For details on handling these devices, refer to “Handling electrostatic discharge-sensitive devices” on page 110.

1. Review the safety precautions listed in “Safety information” on page 107.
2. Turn off the server and peripheral devices and disconnect the power cord and all external cables; then remove the cover (see “Removing the cover” on page 44 for details).
3. Remove the clear shield from the server and store it in a safe place.
4. To remove microprocessor #2:
  - a. Remove the clip from the heat sink by pushing forward on the back of the clip and up on the lever. After the clip releases from the heat sink, lift it up and off the heat sink.  
**Note:** A thermal material is used between the heatsink and the processor. This material, when heated and cooled, causes the heatsink to adhere to the processor. Some force may be required to remove the heatsink.
  - b. Firmly grasp the heat sink and lift it off the microprocessor.  
**Attention:** Do not use excessive force or tools to remove the heatsink.
  - c. Discard the used heatsink.
  - d. Lift up the release lever and remove the microprocessor from the connector. Store the microprocessor in a static-protective bag for possible future use.  
**Note:** If you are installing a new microprocessor, go to “Installing the microprocessor” on page 56.  
If you are not replacing the microprocessor, then you must reinstall the terminator card. Push the release latch down to lock the terminator card into place.

**Note:** It is very important to replace the clear shield.

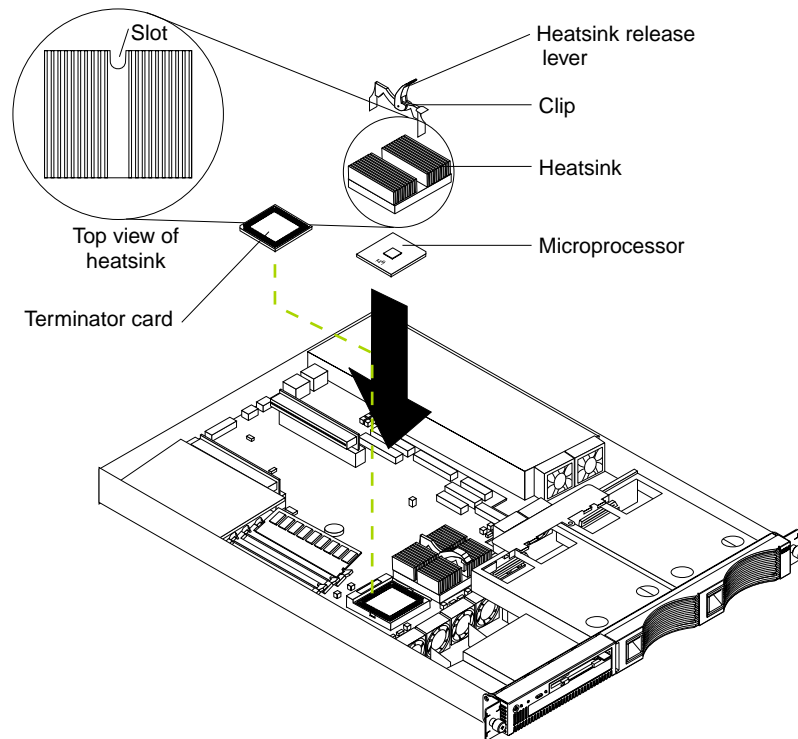

5. To remove microprocessor #1:
    - a. Remove the adapter board retainer latch:
      - 1) Lift up on the release latch.
      - 2) Remove the screws and put them in a safe place.
      - 3) Lift the retainer latch up and off the system board.
    - b. Follow steps a on page 57 through d on page 57.
    - c. After the replacement microprocessor, reinstall the adapter board retainer latch by reversing step a. above.
- Note:** If a terminator card is being installed in microprocessor slot #1, it is not necessary to replace the adapter retainer latch.

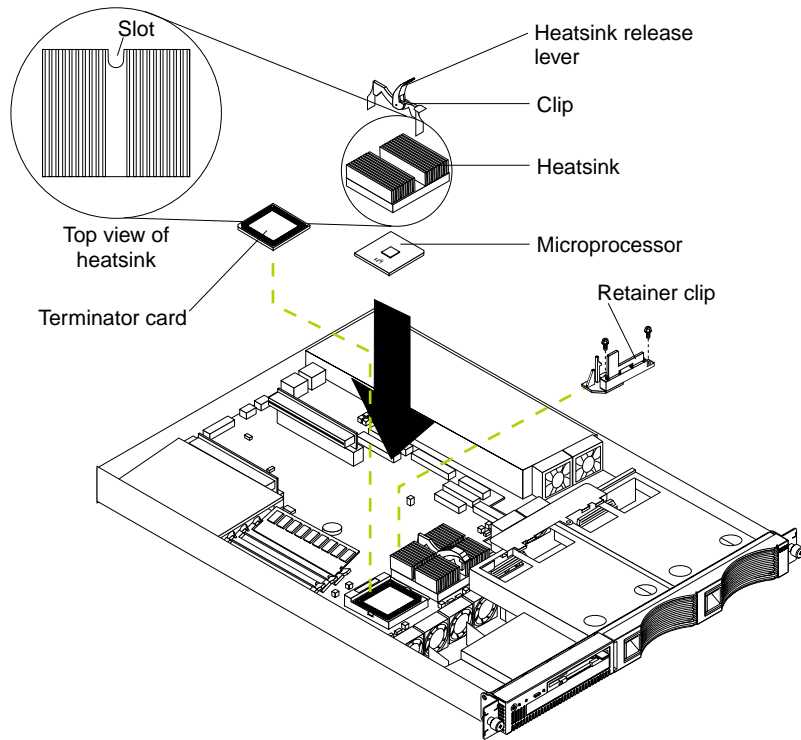

## Fan assembly replacement

The server comes with six replaceable fans.

**Attention:** Replace a fan that has failed within 48 hours to help ensure proper cooling.

The following illustration shows the replacement of a fan.

**Note:** The illustrations in this document might differ slightly from your hardware.

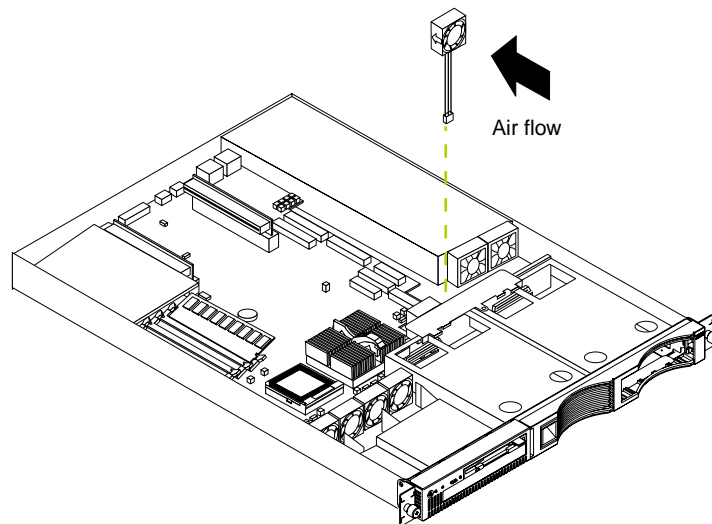

Complete the following steps to replace the fan assembly:

1. Review the safety precautions listed in “Safety information” on page 107.
2. Turn off the server and peripherals; disconnect cables and cords.
3. Remove the cover. See “Removing the cover” on page 44 for details.
4. Determine which fan to replace by checking the LED at each fan; a lit LED indicates the fan to replace. See “Identifying problems using status LEDs” on page 13.  
**Note:** The fan LEDs are illuminated by the light path diagnostic circuit, and will remain lit for up to 12 hours after the AC power has been removed from the server.
5. Remove the fan from the server:
  - a. Disconnect the fan cable from the system board.
  - b. Lift the fan away from the server.
6. Install the replacement fan:
  - a. Orientate the fan so that the air flow arrow on the side of the fan is facing or pointing toward the rear of the server.  
**Note:** Proper air flow is from the front to the rear of the server.
  - b. Push the replacement fan assembly into the server until it clicks into place.
  - c. Connect the fan cable to the system board.
  - d. If the FAN LED is lit, reseal the fan.
7. Install the cover (see “Installing the cover” on page 61).
8. Start up the system, the system error light will either remain on or turn off. If the system error light remains on you will have to turn off the server to perform further troubleshooting.

---

## Installing the cover

The following information describes the cover installation procedure.

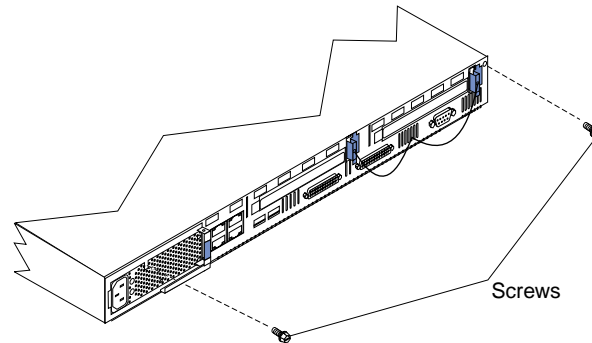

To install the server cover:

1. Clear any cables that might impede the replacement of the clear shield or the cover.
2. Install the clear shield, if it was removed.

**Note:** Thermal considerations require that the clear shield be installed before operating the server.

3. Install the cover by placing it into position and sliding it forward. Make sure the cover engages the tabs at the front and rear of the server.

**Attention:** Before sliding the cover forward make sure that all of the tabs on the cover will engage the ledge at the front of the server properly. If all of the tabs do not engage the ledge properly, it will be extremely difficult to remove the cover.

4. Install the screws and secure the cover as shown.
5. Reinstall the server in the rack (see “Rack installation” on page 43).
6. Reconnect the power cord and all external cables to the server, then plug the power cords into electrical outlets.

---

## I/O connector locations and ports

The following illustration shows the input/output connectors (ports) and the expansion slots on the rear of the server. For pin assignments and other details about these connectors, see “Input/Output ports” on page 62.

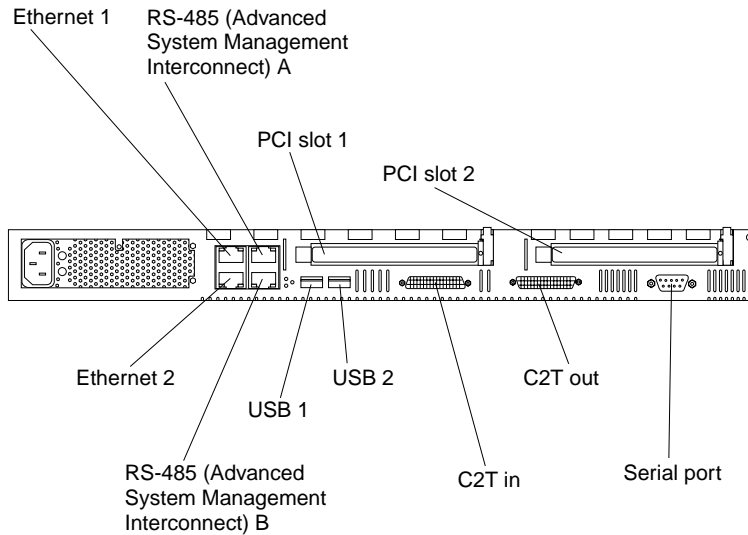

## Input/Output ports

This section provides information about the input/output (I/O) ports on the server. These ports include the following:

- Cable Chaining Technology (C2T) ports
- Serial port
- Universal Serial Bus (USB) ports
- Ethernet ports
- Advanced System Management (ASM) ports

### Serial port

Your server has one standard serial port. Some application programs require specific ports, and some modems function properly only at certain communication port addresses. You might need to use the Configuration/Setup Utility program to change communication port address assignments to prevent or resolve address conflicts. This serial port is also manually configurable from inside of the server. The following table lists the function of each of the connectors which can be used to manually configure the serial port. You will also need to refer to the figure in “System board options connectors” on page 40.

Connectors	Port	Description
J52	Serial A / Systems Management Port	Default connection. Used by OS and Advanced System Management Processor. Modem can be connected so that the system can dial out during problems.
J51	Serial Port B	Used by OS only.
J53	Management Port	Used by Advanced System Management Processor to utilize modem dial up functions.

**Viewing or changing the serial-port assignments:** To view or change the serial-port assignments:

1. Restart the server and watch the monitor screen.

2. When the message Press F1 for Configuration/Setup appears, press F1.
3. From the main menu, select **Devices and I/O Ports**; then, press Enter.  
**Note:** The Devices and I/O Ports choice appears only on the full configuration menu. If you set two levels of passwords, you must enter the administrator password to access the full configuration menu.
4. Select the serial port; then, use the arrow keys to advance through the settings available.
5. Select **Save Settings**; then, select **Exit Setup** to exit from the Configuration/Setup Utility main menu.

**Serial-port connector:** The following table shows the pin-number assignments for the 9-pin, male D-shell serial-port connector on the rear of the server. These pin-number assignments conform to the industry standard.

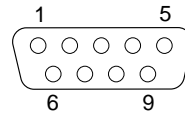

Table 10. Serial-port connectors pin-number assignments.

Pin	Signal	Pin	Signal
1	Data carrier detect	6	Data set ready
2	Receive data	7	Request to send
3	Transmit data	8	Clear to send
4	Data terminal ready	9	Ring indicator
5	Signal ground		

## Universal Serial Bus ports

Your server has two Universal Serial Bus (USB) ports, which configure automatically. USB is an emerging serial interface standard for telephony and multimedia devices. It uses Plug and Play technology to determine the type of device attached to the connector.

### Notes:

1. If you attach a standard (non-USB) keyboard to the keyboard connector, the USB ports and devices will be disabled during the power-on self-test (POST).
2. If you install a USB keyboard that has a mouse port, the USB keyboard emulates a mouse and you will not be able to disable the mouse settings in the Configuration/Setup Utility program.

**USB cables and hubs:** You need a 4-pin cable to connect devices to USB 1 or USB 2. If you plan to attach more than two USB devices, you must use a hub to connect the devices. The hub provides multiple connectors for attaching additional external USB devices.

USB technology provides up to 12 megabits-per-second (Mbps) speed with a maximum of 127 external devices and a maximum signal distance of five meters (16 ft.) per segment.

**USB-port connectors:** Each USB port has an external connector on the rear of the server for attaching USB compatible devices.

The following table shows the pin-number assignments for the USB-port connectors on the rear of the server.

Table 11. USB-port connector pin-number assignments.

Pin	Signal
1	VCC
2	-Data
3	+Data
4	Ground

## Cable Chaining Technology (C2T) ports

There are two C2T ports on the rear of the server. (They are labeled IN and OUT.) These ports, in conjunction with the C2T Chaining and the C2T breakout cables, are used to connect in a chain a maximum of 42 servers, allowing them to share a single video monitor, mouse, and keyboard.

**Note:** For best results, the highest video resolution that should be used with the C2T chain is 1024 x 768.

Connect the C2T breakout cable to the C2T OUT port of server 1. Server 1 is usually the server at the bottom of the rack. Connect the white connector of a C2T chaining cable to the C2T IN port of server 1. Connect the black connector of the C2T chaining cable to the C2T OUT port of the server above it. Refer to the following illustration for additional information. Repeat steps B and C for the other servers until all are connected together.

**Note:** The C2T breakout cables are available in the C2T cable option kit.

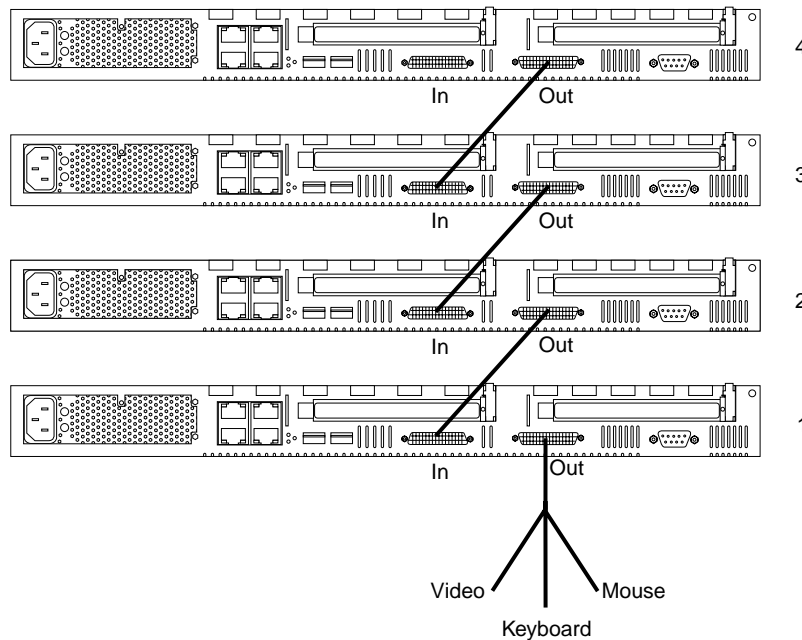



## C2T chaining cable

The C2T Chaining cable is designed to prevent the accidental connection of two OUT connectors with physically different connector shells and different color connector covers (Black = OUT, White = IN).

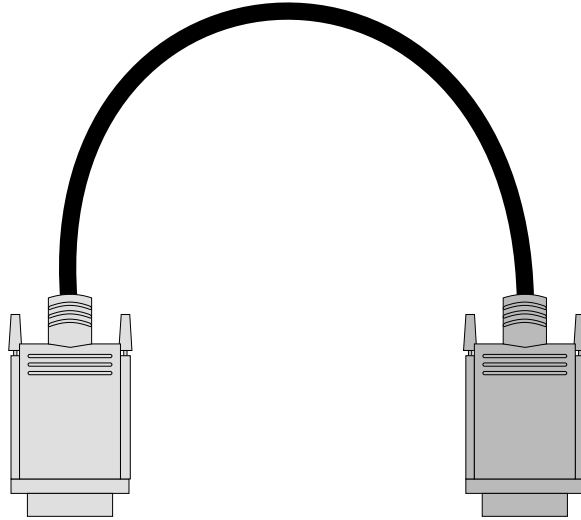

## C2T breakout cable

A keyboard, monitor, and mouse or pointing device are connected to the server through the device breakout cable. The keyboard and mouse cables have icons of a keyboard and a mouse on their respective cable connectors for easy identification.

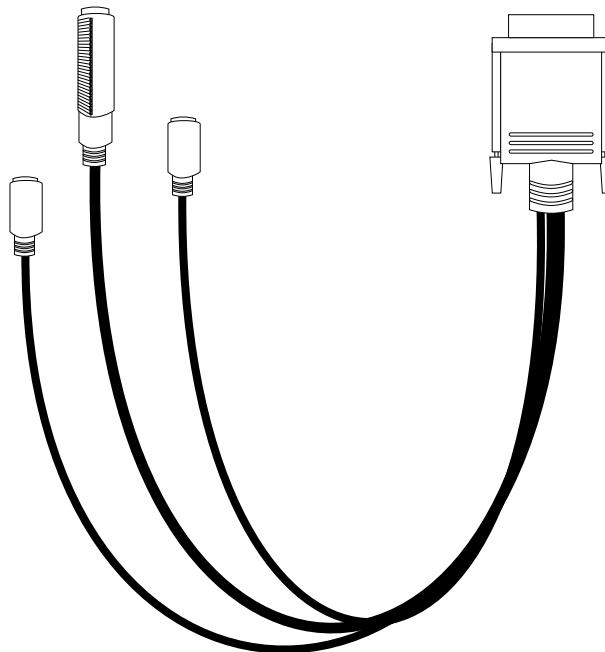

**Keyboard connector:** There is one keyboard connector on the end of the device breakout cable. This connector is identified by the keyboard icon.

**Note:** If you attach a standard (non-USB) keyboard to the keyboard connector, the USB ports and devices will be disabled during the power-on self-test (POST).

The following table shows the pin-number assignments for the keyboard connector on the end of the cable.

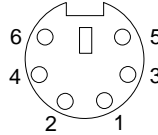

Table 12. Keyboard-connector (6-pin female) number assignments .

Pin	I/O	Signal
1	I/O	Data
2	N/A	Reserved
3	N/A	Ground
4	N/A	+5 V dc
5	I/O	Keyboard clock
6	N/A	Reserved

**Video connector:** The following table shows the pin-number assignments for the 15-pin analog video connector on the end of the C2T device breakout cable. This cable is not labeled but is easily identified by the dark blue 15-pin connector.

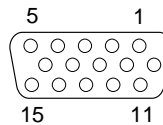

Table 13. Video-connector (15-pin female) number assignments.

Pin	Signal	Pin	Signal	Pin	Signal
1	Red	6	Ground	11	Not connected
2	Green or monochrome	7	Ground	12	DDC SDA
3	Blue	8	Ground	13	Horizontal synchronization (Hsync)
4	Not connected	9	+5 V dc DDC	14	Vertical synchronization (Vsync)
5	Ground	10	Ground	15	DDC SCL

**Auxiliary-device (pointing device) connector:** On the end of the C2T device breakout cable, there is one auxiliary-device connector that supports a mouse or other pointing device. This connector is identified by the mouse icon.

The following table shows the pin-number assignments for the auxiliary-device connector on the end of the cable.

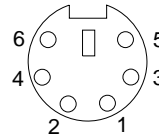

Table 14. Auxiliary or pointing-device-connector (6 pin female) number assignments .

Pin	Signal
1	Data
2	Not connected
3	Ground
4	+5 V dc
5	Clock
6	Not connected

## Ethernet ports

The server comes with two integrated Ethernet controllers. This controller provides an interface for connecting to 10-Mbps or 100-Mbps networks and provides full-duplex (FDX) capability, which enables simultaneous transmission and reception of data on the Ethernet local area network (LAN).

To access the Ethernet port, connect a Category 3, 4 or 5 unshielded twisted-pair (UTP) cable to the RJ-45 connector on the rear of the server.

**Note:** The 100BASE-TX Fast Ethernet standard requires that the cabling in the network be Category 5 or higher.

**Configuring the Ethernet controller:** When you connect the server to the network, the Ethernet controller for that Ethernet port automatically detects the data-transfer rate (10 Mbps or 100 Mbps) on the network and then sets the controller to operate at the appropriate rate. In addition, if the Ethernet port that the server is connected to supports auto-negotiation, the Ethernet controller will set the appropriate duplex state. That is, the Ethernet controller will adjust to the network data rate, whether the data rate is standard Ethernet (10BASE-T), Fast Ethernet (100BASE-TX), half duplex (HDX), or full duplex (FDX). The controller supports half-duplex (HDX) and full-duplex (FDX) modes at both speeds.

The Ethernet controller is a PCI Plug and Play device. You do not need to set any jumpers or configure the controller for your operating system before you use the Ethernet controller. However, you must install a device driver to enable your operating system to address the Ethernet controllers. The device drivers are provided on the ServerGuide CDs.

**Failover for redundant Ethernet:** The IBM Netfinity 10/100 Ethernet Adapter or the IBM 10/100 Etherjet PCI family of adapters are optional redundant network interface cards (NIC adapter) that you can install in your server. If you install this NIC adapter and connect it to the same logical segment as the primary Ethernet controller, you can configure the server to support a *failover* function. You can configure either the integrated Ethernet controller or the NIC adapter as the primary Ethernet controller. In failover mode, if the primary Ethernet controller detects a link failure, all Ethernet

traffic associated with it is switched to the redundant (secondary) controller. This switching occurs without any user intervention. When the primary link is restored to an operational state, the Ethernet traffic switches back to the primary Ethernet controller.

**High Performance Ethernet Modes:** Your Ethernet controller supports optional modes, such as teaming, priority packets, and virtual LANs, which provide higher performance and throughput for your server.

*Teaming Mode:* Your Ethernet controller provides options, called *teaming options*. These options increase throughput and fault tolerance when running with Windows NT 4.0 or NetWare 4.1x or later.

- **Adapter fault tolerance (AFT)** provides automatic redundancy for your adapter. If the primary adapter fails, the secondary adapter takes over. Adapter fault tolerance supports from 2 to 4 adapters per team.
- **Adaptive load balancing (ALB)** allows you to balance the transmission data flow among 2 to 4 adapters. ALB also includes the AFT option. You can use ALB with any 100BASE-TX switch.
- **Cisco Fast EtherChannel (FEC)** creates a team of 2 to 4 adapters to increase transmission and reception throughput. FEC also includes the AFT option. You can only use FEC with a switch that has FEC capability.

Teaming requires you to use both of the integrated Ethernet controllers. For additional information about the teaming modes, refer to the documentation that comes with these additional adapters.

*Priority Packet Mode:* Priority Packet is a traffic-prioritization utility that enables you to set up filters to process high-priority traffic before normal traffic. You can send information from critical nodes or applications with an indicated priority. Because you set this priority at the host or entry point of the network, the network devices can base forwarding decisions on priority information defined in the packet.

Priority Packet information is available on the IBM Networking Web site at: <http://www.ibm.com/networking/support>

Priority Packet prioritizes traffic based on priority filters. These are parameters you assign to outgoing (transmit) packets. Using the Priority Filter Wizard, you can set up predefined or custom priority filters based on a node (MAC) address, Ethernet type, or by various properties of the protocol and port. Priority Packet provides two different methods for prioritizing traffic: IEEE 802.1p tagging and High Priority Queue.

IEEE 802.1p is a new IEEE standard for tagging, or adding additional bytes of information to packets with different priority levels. Packets are tagged with 4 additional bytes, which increase the packet size and indicate a priority level. When you send these packets out on the network, the higher priority packets are transferred first. Priority packet tagging (also known as Traffic Class Expediting) allows the adapter to work with other elements of the network (such as switches and routers) to deliver priority packets first. You can assign specific priority levels from 0 (low) to 7 (high).

You can assign values to packets based on their priority when you use the IEEE 802.1p standard for packet tagging. This method requires a network infrastructure that supports packet tagging. The routing devices receiving and transferring these packets on your network must support 802.1p for tagging to be effective.

After you set up the priority filter in Priority Packet, you must launch IBMSet and select **802.1p/802.1Q Tagging** on the Advanced tab.

**Note:** IEEE 802.1p tagging increases the size of the packets it tags. Some hubs and switches will not recognize the larger packets and will drop them. Check your hub or switch documentation to see if they support 802.1p. (You can configure the switch to strip the tags from the packets and send it on to the next destination as normal traffic.) If these devices do not support 802.1p or if you are not sure, use High Priority Queue (HPQ) to prioritize network traffic.

The requirements for effectively using IEEE 802.1p tagging are:

- The other devices receiving and routing 802.1p tagged packets must support 802.1p.
- The adapters on these devices must support 802.1p. The Ethernet controller in all IBM Netfinity 10/100 Ethernet Security Adapters and IBM 10/100 Ethernet Server Adapters support 802.1p.
- The adapter cannot be assigned to an adapter team.
- If you are setting up VLANs and packet tagging on the same adapter, 802.1p/802.1Q Tagging must be enabled on the IBMSet Advanced tab.

If your network infrastructure devices do not support IEEE 802.1p or you are not sure, you can still define filters and send packets as high priority. While High Priority Queue (HPQ) does not provide the precise priority levels of 802.1p tagging, it does assign traffic as either high or low priority and sends high priority packets first. Therefore, if there are multiple applications on a system sending packets, the packets from the application with a filter are sent out first. HPQ does not change network routing, nor does it add any information to the packets.

To assign HPQ, you can specify it using Priority Packet when you create or assign a filter.

To effectively use HPQ tagging, the adapter cannot be assigned to an adapter team.

*Virtual LAN Mode:* A virtual LAN (VLAN) is a logical grouping of network devices put together as a LAN, regardless of their physical grouping or collision domains. Using VLANs increases network performance and improves network security.

VLANs offer you the ability to group users and devices together into logical workgroups. This can simplify network administration when connecting clients to servers that are geographically dispersed across the building, campus, or enterprise network.

Normally, VLANs are configured at the switch and any computer can be a member of one VLAN per installed network adapter. Your Ethernet controller supersedes this by communicating directly with the switch, allowing multiple VLANs on a single network adapter (up to 64 VLANs).

To set up VLAN membership, your Ethernet controller must be attached to a switch that has VLAN capability. You also need to use Windows NT 4.0 or later, or Novell NetWare 4.1x or later.

**Notes:**

1. Windows NT versions prior to 4.0 do not support VLANs.
2. VLANs require NT 4.0 with Service Pack 3.0 and the NDIS driver hotfix from Microsoft.
3. In Windows NT, VLANs cannot be implemented on controllers that have been configured for teaming options. NetWare can support teaming options and VLANs on the same adapters.

To join a VLAN from Windows NT 4.0:

1. Create a VLAN on the switch. Use the parameters you assign there to join the VLAN from the server. Refer to your switch documentation for more information.
2. Double-click the Network icon in the Control Panel window.
3. On the Adapters tab, select the adapter you want to be on the VLAN and select **Properties**.
4. In IBMSet, select **Join VLAN**. Note that VLANs cannot be assigned to adapters that are already defined to have an adapter teaming option.
5. Enter the VLAN ID and VLAN name. The VLAN ID must match the VLAN ID of the switch. The ID range is from 1 to 1000. The VLAN name is for information only and does not need to match the name on the switch.
6. Select **Join VLAN**. Repeat steps 3 through 5 for each VLAN you want the server to join. The VLANs you add are listed on the Adapters tab.
7. Select **Close** and restart the computer.

**Ethernet port connector:** The following table shows the pin-number assignments for the RJ-45 connector. These assignments apply to both 10BASE-T and 100BASE-TX devices.

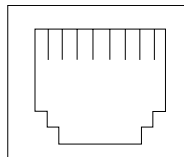

Table 15. Ethernet RJ-45 connector pin-number assignments..

Pin	Signal	Pin	Signal
1	Transmit data+	5	Not connected
2	Transmit data-	6	Receive data -
3	Receive data+	7	Not connected
4	Not connected	8	Not connected

## Advanced System Management ports

There are two kinds of Advanced System Management ports: a Management port (Serial port A), and RS-485 ports.

### Management Port (Serial port A)

This port uses a standard D-shell serial-port connector, labeled A on the rear of the server. You can attach a dedicated modem to the D-shell connector on the rear of the server to communicate with the integrated Advanced System Management Processor. For more information see “Serial port” on page 62.

### RS-485 ports

The RS-485 ports on the rear of the server enable you to connect the Advanced System Management Processors of several rack-mounted servers so that they can communicate with each other in half-duplex mode.

## Working with cables

The server has two different cabling schemes, the Advanced System Management bus (ASM) and the Cable Chaining Technology (C2T). The following sections discuss each of these options. While reading about these options, keep in mind that they are independent of each other.

**Note:** Refer to the following illustration to locate the connectors on the back of your server.

The ASM connectors on the back of the server are referred to in this book as RS-485 (A) and RS-485 (B).

**Note:** The illustrations in this document might differ slightly from your hardware.

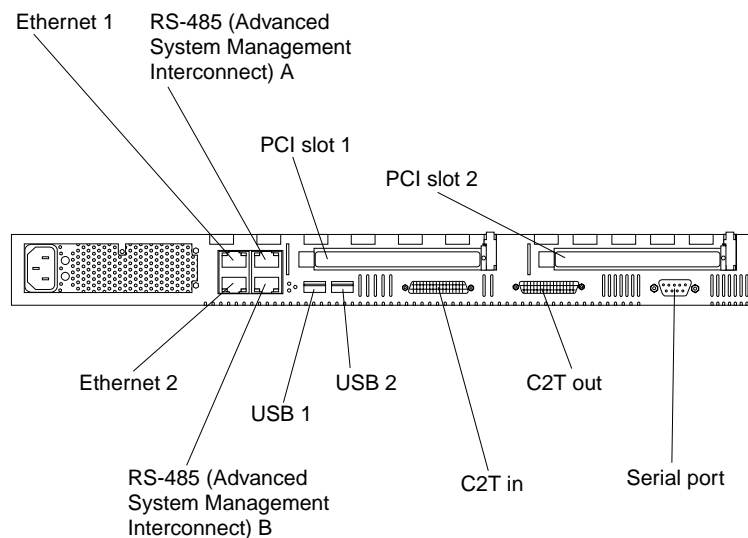

## Cabling the RS-485 ports

You can use the RS-485 connectors to create an Advanced System Management bus between several xSeries 330 servers.

Before you begin, review the following:

**Important:** The Advanced System Management bus is designed to support up to 12 units or servers. However, when using the Advanced System Management PCI adapter, the bus uses the PCI adapter as another unit. In this case, you can connect a maximum of 11 units or servers together.

- You can hot-swap the cables in the Advanced System Management bus.
- You can connect up to 12 units together if you are using serial (management) port A as your Advanced System Management port.
- When connecting an xSeries 330 server to another server type you must install an Advanced System Management adapter into PCI slot 1 or use the serial port as your Advanced System Management port.
- When the Advanced System Management PCI adapter is added to the xSeries 330, you can connect up to 11 additional servers together.
- Use standard Ethernet cables with RJ-14 connectors.

**Note:** For more information about the Advanced System Management PCI adapter refer to the documentation that came with the adapter.

## Connecting the ASM bus

The servers in the Advanced System Management bus are referenced by their assigned addresses and not their position in the rack.

Complete the following steps to connect the ASM bus:

1. Turn off the servers.
2. Locate the RS-485 ports on the rear of the server and an Ethernet cable with RJ-14 connectors on both ends.
3. Connect one end of the cable to the RS-485 (A) port.
4. Connect the other end of the cable to the RS-485 (B) port on the next server.

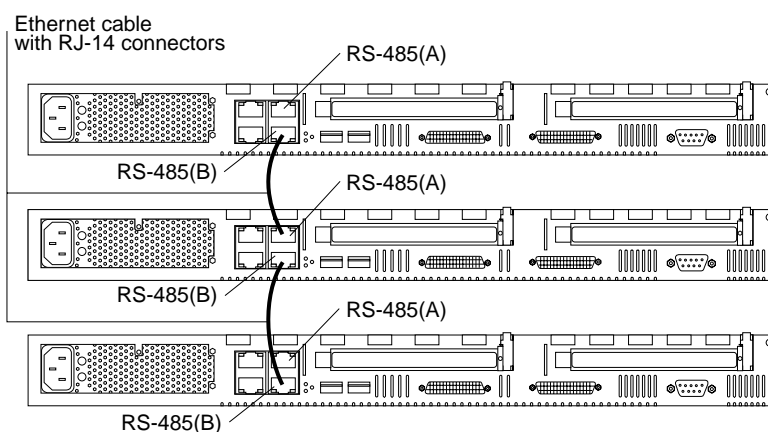

5. Repeat steps 3 and 4 to connect up to 12 units together.

## Connecting the servers with a C2T chain

To share the same monitor, keyboard, and pointing device with several servers you must connect the servers together with Cable Chaining Technology (C2T) chaining cables using the C2T IN and C2T OUT ports.

Before you begin review the following:

- The supported maximum number of servers connected in a single chain with C2T chaining cables is 42.
- When connecting servers across a gap that is larger than 3U or located on two separate racks you must use a C2T chaining cable that is 2 meters (6.5 ft.) long, which is available in the C2T cable option kit.

**Note:** Only one 2-m (6.5 ft.) long cable can be used in the C2T chain.

- The C2T interconnect cables can be hot-swapped.

**Attention:** For optimum results, do not touch the chassis with the pins of the C2T cable connector when hot adding or removing systems from the chain.

- Servers are numbered by their position in the chain (1 through nn). If one server is removed from the chain, all successive servers are renumbered. For example, if the twelfth server is removed from a chain of 15 servers, then servers 13 through 15 will then be renumbered to 12 through 14.



- The C2T numbering is independent of any other server reference. Changing the servers position in the C2T chain will not effect their IP addresses.

**Note:**

**Operational notes:**

1. Server 1 (usually the server at the bottom of the rack) is the server to which you connect the C2T device break out cable.
2. Server 1 must not be turned off (powered down) for the chain to work properly.
3. If server 1 is turned off (powered down) it must be removed from the chain and replaced by the next server in the chain.
4. For the chain to operate properly no more than two adjacent servers can be unplugged from the wall outlet at the same time.
5. If you are using a flat panel monitor, you might need to adjust the image lock on your monitor when multiple servers are connected using C2T interconnect cables. To adjust this image, select one of the middle servers in the chain by pressing the select button on the front of the server; then, adjust the image lock accordingly. For more information on how to adjust the image lock, refer to the documentation that came with your flat panel monitor.
6. When removing or replacing servers, or changing cables in the chain, it is possible for more than one select LED to be illuminated on the servers in the chain. To clear all but the selected server LED, press the select button on any one of the servers in the chain.
7. If you turn off a selected server you must select another server that is powered up. For the location of the select button see “Server controls and indicators” on page 6.
8. For your C2T chain to work properly with your operating-system, enable or disable the settings as shown in the following table.

*Table 16. C2T Configuration/Setup settings..*

OS	USB Legacy	Keyboardless Operation
Win NT 4.0	Disabled	Enabled
Win 2000	Enabled	Enabled
Redhat Linux	Disabled	Enabled

Complete the following steps to connect the servers:

1. Gather several of the C2T cables.
 

**Note:** The server comes with a short C2T chaining cable that can span approximately 3 Us if needed. A longer C2T cable is available in the C2T cable option kit.
2. Connect the servers together:
  - a. Connect the C2T breakout cable to the C2T OUT port of server 1.
 

**Note:** Server 1 is usually the server at the bottom of the rack.
  - b. Connect the white connector of a C2T chaining cable to the C2T IN port of server 1.
  - c. Connect the black connector of the C2T chaining cable to the C2T OUT port of the server above it. Refer to the following illustration for additional information.
  - d. Repeat steps b. and c. for the other servers until all are connected together.

3. Turn the servers on and check the operation of the monitor, pointing device, and keyboard with each server. (See “Testing the C2T chain” for testing instructions).

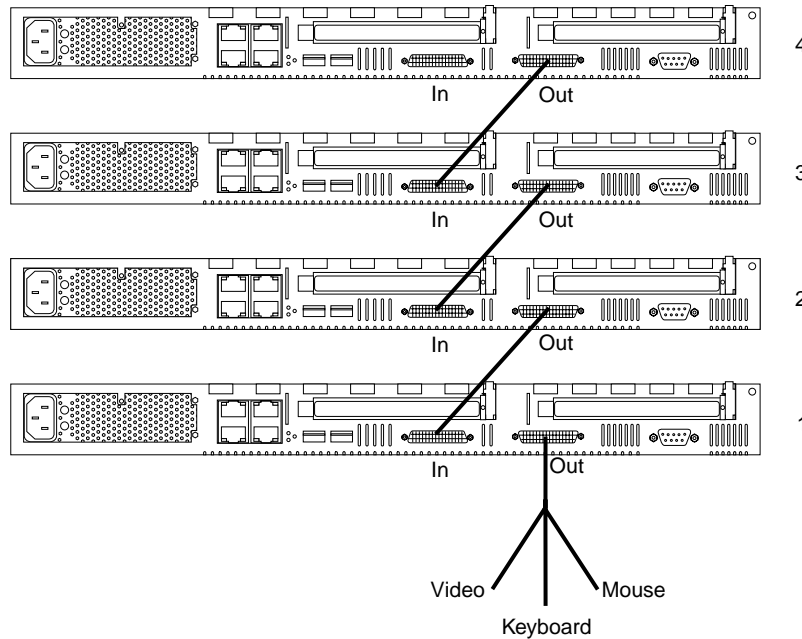

**Note:** Write-on adhesive labels have been provided so that you can label the servers position in the rack.

### Testing the C2T chain

If the monitor, keyboard and mouse are known to be good, the only verification needed to be performed after connecting the C2T chain is the verification of the connections of the servers in the chain.

Follow these steps to test the C2T cabling:

1. Turn on all the servers and the monitor, verify that the light in the select button on server 1 in the C2T chain is lighted indicating it is selected. If it is not, press the select button.
2. Verify that the monitor is working.
3. Boot an operating system that has a mouse or pointing device driver. Verify the functionality of the mouse or pointing device.
4. Test your keyboard by typing a few words within an application.
5. Use your keyboard to switch to the last server in the chain. For example, if there are 42 servers in the chain: Press NumLock twice, press 4, press 2, press Enter. The monitor screen should go blank after the second NumLock, then become active again after the Enter is pressed showing the screen output of the selected server. Verify the keyboard and mouse functionality. If successful, the C2T chain is tested.

**Note:** If you were unable to perform steps 2 through 4, verify that the C2T breakout cable is properly connected to the C2T OUT port of server 1. Retry the test steps 2 through 4. If the problem persists, disconnect the C2T chaining cable from the C2T IN port of server 1. Retry the test. If the problem persists, the problem is due to either a faulty breakout cable or a faulty server. If the problem ceased to exist after the chaining cable was disconnected, the problem is probably caused by an anomaly in the chain. A procedure that could be

used to identify the failing node (cable or system) consists of reconnecting the chain a node at a time until the failing node is isolated.

## **Cable management**

Use the cable ties and hook-and-loop straps that are supplied with your server to secure the cables.

**Note:** Do not secure cables too tightly. Over tightening can cause internal damage to cables.



---

## Chapter 6. FRU information (service only)

Field Replacement Units (FRUs) should be replaced by qualified service personnel only.

**Note:** Read “Safety information” on page 107 and “Before you begin” on page 42.

---

### Diskette/CD-ROM drives

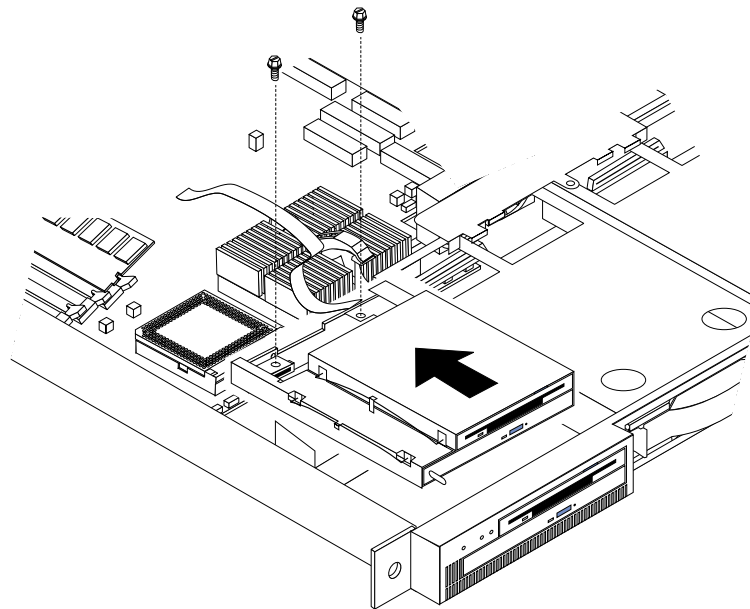

To remove the diskette/CD-ROM drive:

1. Power off the server.
2. Remove the cover. See “Removing the cover” on page 44.
3. Disconnect the cables for the floppy disk drive and the CD-ROM drive from the system board.
4. Remove the fans. See “Fan assembly replacement” on page 59.
5. Remove the screws.
6. Gently pull back and up to remove the drives from the chassis.

---

## Diskette/CD-ROM drive bracket

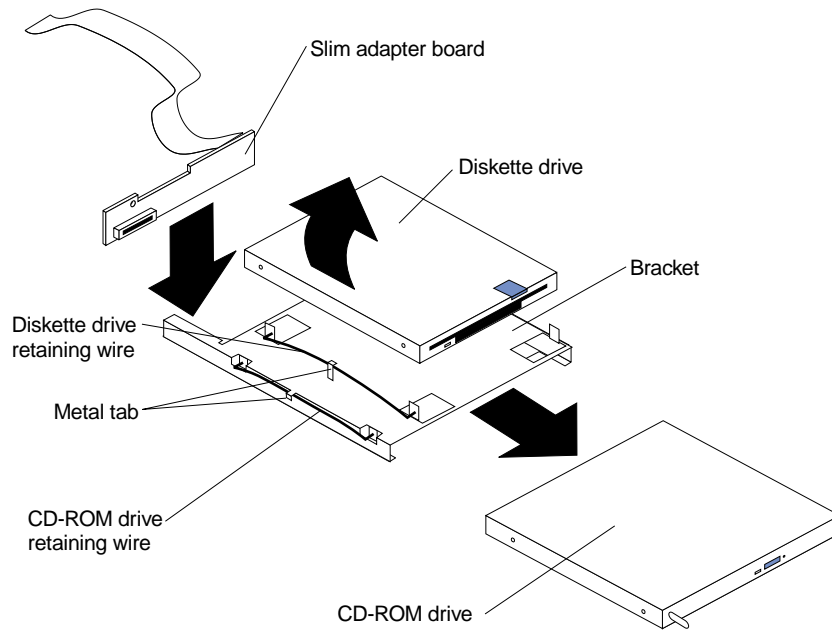

To remove the diskette/CD-ROM drive bracket:

**Note:** Read “Safety information” on page 107 and “Before you begin” on page 42.

1. Remove the diskette/CD-ROM drive. See “Diskette/CD-ROM drives” on page 77.
2. Remove the diskette drive:
  - a. Remove the diskette drive retaining wire by releasing it from the metal tab and removing it from the holes, and put it in a safe place.
  - b. Lift the diskette drive up on one side until it separates from the bracket.
  - c. Diskette drive cable:
    - 1) The diskette drive cable is removed by gently pulling the cable up until it is released from the connector.
    - 2) To replace the diskette drive cable, pull up on the connector latch until it is unlocked; then, insert the end of the cable into the connector and gently push down on the connector latch until it clicks into place.
3. Remove the CD-ROM drive:
  - a. Remove the CD-ROM drive retaining wire by releasing it from the metal tab and removing it from the holes, and put it in a safe place.
  - b. Gently loosen the connector of the slim adapter board from the CD-ROM drive connector until it pulls free; slide the slim adapter board down until it clears the notches on the bracket and remove it.
  - c. Slide the bracket toward the rear and remove it.

---

## Hard disk drive backplane

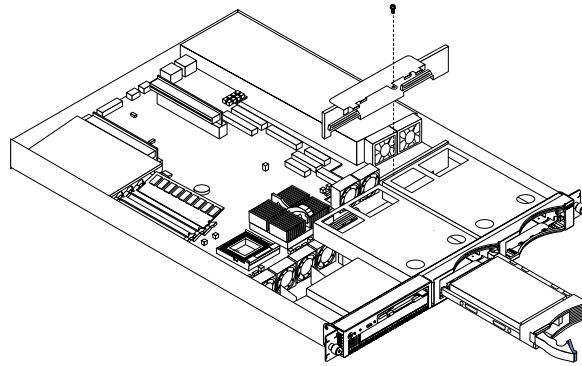

To remove the hard disk drive backplane:

**Note:** Read “Safety information” on page 107 and “Before you begin” on page 42.

1. Power off the server.
2. Remove the cover. See “Removing the cover” on page 44.
3. Disconnect the backplane cable from the system board.
4. Pull out the hard drives in order to disconnect them from the backplane.
5. Remove the screw from the top of the backplane bracket.
6. Gently but firmly lift the backplane bracket and board up from the chassis.

---

## Power supply

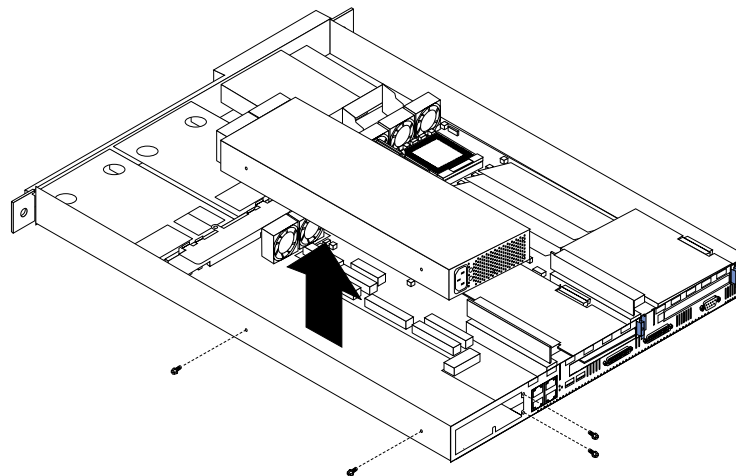

To remove the power supply:

**Note:** Read “Safety information” on page 107 and “Before you begin” on page 42.

1. Power off the server.

2. Remove the cover. See “Removing the cover” on page 44.
3. Disconnect the cables that connect the power supply to the system board.
4. Remove the screws (2) from the side of the chassis.
5. Remove the screws at the back of the chassis and power supply.
6. Slide the power supply away from the side of the chassis and lift up to remove.

---

## PCI riser card

To remove the PCI riser card:

**Note:** Read “Safety information” on page 107 and “Before you begin” on page 42.

1. Power off the server.
2. Remove the cover. See “Removing the cover” on page 44.
3. Remove any adapters and put them in a safe place.
4. Disconnect cables.
5. Gently lift up on the card to disconnect it from the system board port.

---

## System board

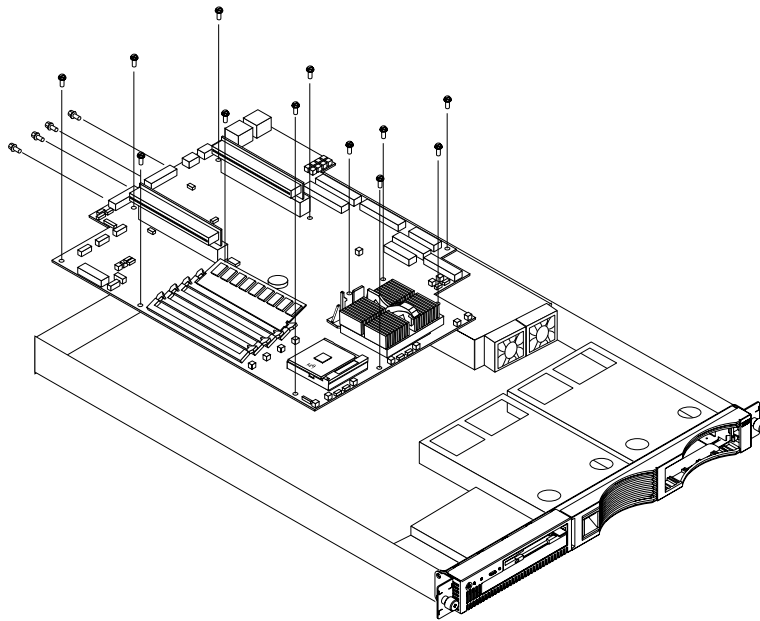

To remove the system board:

**Note:** Read “Safety information” on page 107 and “Before you begin” on page 42.

1. Power off the server.
2. Remove the cover. See “Removing the cover” on page 44.
3. Disconnect all cables from the system board.



4. Remove the adapter retaining latch (see “Removing a microprocessor” on page 57).
5. Remove the microprocessors. See “Removing a microprocessor” on page 57.
6. Remove the memory modules. See “Installing memory modules” on page 53.
7. Remove screws from the system board.
8. Remove the four screws from the rear of the server.
9. Pull up on the system board to remove from the chassis.



## Chapter 7. Symptom-to-FRU index

This index supports Netfinity 4100R servers. The Symptom-to-FRU lists symptoms, errors, and the possible causes. The most likely cause is listed first. Use this Symptom-to-FRU index to help you decide which FRUs to have available when servicing the computer.

The POST BIOS displays POST error codes and messages on the screen.

### Beep symptoms

Beep symptoms are short tones or a series of short tones separated by pauses (intervals without sound). See the following examples.

**Note:** One beep after successfully completing POST indicates the system is functioning properly.

Beeps	Description
1-2-3	<ul style="list-style-type: none"> <li>• One beep</li> <li>• A pause (or break)</li> <li>• Two beeps</li> <li>• A pause (or break)</li> <li>• Three Beeps</li> </ul>
4	Four continuous beeps

Beep/Symptom	FRU/Action
1-1-2 (Processor register test failed)	<ol style="list-style-type: none"> <li>1. <b>Optional Processor (if installed)</b></li> <li>2. Processor</li> </ol>
1-1-3 (CMOS write/read test failed)	<ol style="list-style-type: none"> <li>1. <b>Battery</b></li> <li>2. System Board</li> </ol>
1-1-4 (BIOS EEPROM checksum failed)	<ol style="list-style-type: none"> <li>1. <b>DIMM</b></li> <li>2. System Board</li> </ol>
1-2-1 (Programmable Interval Timer failed)	<ol style="list-style-type: none"> <li>1. <b>System Board</b></li> </ol>
1-2-2 (DMA initialization failed)	<ol style="list-style-type: none"> <li>1. <b>System Board</b></li> </ol>
1-2-3 (DMA page register write/read failed)	<ol style="list-style-type: none"> <li>1. <b>System Board</b></li> </ol>
1-2-4 (RAM refresh verification failed)	<ol style="list-style-type: none"> <li>1. <b>DIMM</b></li> <li>2. System Board</li> </ol>
1-3-1 (1st 64K RAM test failed)	<ol style="list-style-type: none"> <li>1. <b>DIMM</b></li> <li>2. System Board</li> </ol>
1-3-2 (1st 64K RAM parity test failed)	<ol style="list-style-type: none"> <li>1. <b>DIMM</b></li> <li>2. System Board</li> </ol>

<b>Beep/Symptom</b>	<b>FRU/Action</b>
<b>2-1-1</b> (Secondary DMA register failed)	1. <b>System Board</b>
<b>2-1-2</b> (Primary DMA register failed)	1. <b>System Board</b>
<b>2-1-3</b> (Primary interrupt mask register failed)	1. <b>System Board</b>
<b>2-1-4</b> (Secondary interrupt mask register failed)	1. <b>System Board</b>
<b>2-2-2</b> (Keyboard controller failed)	1. <b>Keyboard</b> 2. System Board
<b>2-2-3</b> (CMOS power failure and checksum checks failed)	1. <b>Battery</b> 2. System Board
<b>2-2-4</b> (CMOS configuration information validation failed)	1. <b>Battery</b> 2. System Board
<b>2-3-1</b> (Screen initialization failed)	1. <b>System Board</b>
<b>2-3-2</b> (Screen memory failed)	1. <b>System Board</b>
<b>2-3-3</b> (Screen retrace failed)	1. <b>System Board</b>
<b>2-3-4</b> (Search for video ROM failed)	1. <b>System Board</b>
<b>2-4-1</b> (Video failed; screen believed operable)	1. <b>System Board</b>
<b>3-1-1</b> (Timer tick interrupt failed)	1. <b>System Board</b>
<b>3-1-2</b> (Interval timer channel 2 failed)	1. <b>System Board</b>
<b>3-1-3</b> (RAM test failed above address OFFFFH))	1. <b>DIMM</b> 2. System Board
<b>3-1-4</b> (Time-Of-Day clock failed)	1. <b>Battery</b> 2. System Board
<b>3-2-1</b> (Serial port failed)	1. <b>System Board</b>
<b>3-2-2</b> (Parallel port failed)	1. <b>System Board</b>
<b>3-2-4</b> (Failure comparing CMOS memory size against actual)	1. <b>DIMM</b> 2. System Board 3. Battery
<b>3-3-1</b> (Memory size mismatch occurred; see "Memory Settings" on page 33)	1. <b>DIMM Board</b> 2. System Board 3. Battery
<b>3-3-2</b> (Critical SMBUS error occurred)	1. <b>Disconnect the server power cord from outlet, wait 30 seconds and retry.</b> 2. System Board 3. DIMMs 4. DASD Backplane 5. DASD Power Cable

Beep/Symptom	FRU/Action
<b>3-3-3</b> (No operational memory in system)	<ol style="list-style-type: none"> <li>1. <b>Install or reseat the memory modules, then do a 3 boot reset.</b> (See “Using the Configuration/Setup Utility program” on page 29)</li> <li>2. DIMMs</li> <li>3. System Board</li> </ol>
<b>Two Short Beeps</b> (Information only, the configuration has changed)	<ol style="list-style-type: none"> <li>1. <b>Run Diagnostics</b></li> <li>2. Run Configuration/Setup</li> </ol>
<b>Three Short Beeps</b>	<ol style="list-style-type: none"> <li>1. <b>DIMM</b></li> <li>2. System Board</li> </ol>
<b>One Continuous Beep</b>	<ol style="list-style-type: none"> <li>1. <b>Processor</b></li> <li>2. Optional Processor (if installed)</li> <li>3. System Board</li> </ol>
<b>Repeating Short Beeps</b>	<ol style="list-style-type: none"> <li>1. <b>Keyboard</b></li> <li>2. System Board</li> </ol>
<b>One Long and One Short Beep</b>	<ol style="list-style-type: none"> <li>1. <b>Video adapter (if present)</b></li> <li>2. System Board</li> </ol>
<b>One Long and Two Short Beeps</b>	<ol style="list-style-type: none"> <li>1. <b>Video adapter (if present)</b></li> <li>2. System Board</li> </ol>
<b>Two Long and Two Short Beeps</b>	<ol style="list-style-type: none"> <li>1. <b>Video adapter</b></li> </ol>

---

## No Beep symptoms

No Beep Symptom	FRU/Action
<b>No beep after completing POST and the system operates correctly.</b>	<ol style="list-style-type: none"> <li>1. System Board</li> </ol>
<b>No beep and no video</b> (System Attention LED is OFF)	<ol style="list-style-type: none"> <li>1. <b>See “Undetermined problems” on page 98</b></li> </ol>
<b>No beep and no video</b> (System Attention LED is ON)	<ol style="list-style-type: none"> <li>1. <b>See “Information panel system error LED”</b></li> </ol>

---

## Information panel system error LED

The system error LED is turned on when an error is detected. Push the button beside the LED display on the system board to illuminate the LEDs. If the system error LED is on, remove the cover and check the diagnostic panel LEDs. The following is a complete list of diagnostic panel LEDs followed by the FRU/Action for correcting the problem. The following chart is valid only when the system error LED is on.

**Note:** If a diagnostic panel LED is on and the information LED panel system error LED is off, there is probably an LED problem. Run LED diagnostics.

**Notes:**

1. To locate the LEDs on the system board see “System board LEDs” on page 41.

2. Check the System Error Log for additional information before replacing a FRU.
3. The DIMM error LEDs, processor error LEDs, and VRM error LEDs turn off when the system is powered down.

Diagnostic Panel LED	FRU/Action
<b>All LEDs off</b> (Check System Error Log for error condition, then clear System Error Log when the problem is found.)	<ol style="list-style-type: none"> <li>1. <b>System Error Log is 75% full; clear the log.</b></li> <li>2. PFA alert; check Netfinity log (Netfinity Manager or Netfinity Director) for failure; clear PFA alert; remove AC power for at least 20 seconds, reconnect, then power up system.</li> <li>3. Run Information Panel diagnostics.</li> </ol>
<b>CPU LED on</b> (The LED next to the failing CPU should be on.)	<ol style="list-style-type: none"> <li>1. <b>Processor 1 or 2.</b></li> <li>2. System Board.</li> </ol>
<b>VRM LED on</b>	<ol style="list-style-type: none"> <li>1. <b>System Board</b></li> </ol>
<b>DASD LED on</b> (The LED located next to the drive bay that the failing drive is installed in will be turned on.)	<ol style="list-style-type: none"> <li>1. <b>Failing drive.</b></li> <li>2. Be sure the fans are operating correctly and the air flow is good.</li> <li>3. SCSI Backplane.</li> </ol>
<b>FAN LED on</b>	<ol style="list-style-type: none"> <li>1. <b>Check individual fan LEDs.</b></li> <li>2. Replace respective fan.</li> <li>3. System Board.</li> </ol>
<b>MEM LED on</b> (The LED next to the failing DIMM is on.)	<ol style="list-style-type: none"> <li>1. <b>DIMM.</b></li> <li>2. Failing DIMM in slot J1-J4.</li> <li>3. System Board</li> </ol>
<b>PCI LED on</b>	<ol style="list-style-type: none"> <li>1. <b>Remove PCI adapters from slots 1-2.</b></li> <li>2. System Board.</li> </ol>
<b>PS LED on</b>	<ol style="list-style-type: none"> <li>1. <b>Power Supply</b></li> <li>2. System Board</li> </ol>
<b>TEMP LED on</b> (look at test cases)	<ol style="list-style-type: none"> <li>1. <b>Ambient temperature must be within normal operating specifications. See “Features and specifications” on page 4.</b></li> <li>2. Ensure fans are operating correctly.</li> <li>3. Examine System Error Log. <ol style="list-style-type: none"> <li>a. System over recommended temperature</li> <li>b. Power switch assembly</li> <li>c. DASD over recommended temperature <ol style="list-style-type: none"> <li>1) Overheating hard drive</li> <li>2) DASD Backplane</li> <li>3) System Board</li> </ol> </li> <li>d. System over recommended temperature for CPU X (where X is CPU number,) (CPU LED also on) <ol style="list-style-type: none"> <li>1) CPU X</li> <li>2) System Board</li> </ol> </li> <li>e. System Board over recommended temperature <ol style="list-style-type: none"> <li>1) System Board.</li> </ol> </li> </ol> </li> </ol>

## Diagnostic error codes

**Note:** In the following error codes, if *XXX* is *000*, *195*, or *197* **do not** replace a FRU. The description for these error codes are:

**000** The test passed.

**195** The **Esc** key was pressed to abort the test.

**197** This is a warning error and may not indicate a hardware failure.

For all error codes, replace/follow the FRU/Action indicated.

Error Code/Symptom	FRU/Action
<b>001-XXX-000</b> (Failed core tests)	1. <b>System Board</b>
<b>001-XXX-001</b> (Failed core tests)	1. <b>System Board</b>
<b>001-250-000</b> (Failed System Board ECC)	1. <b>System Board</b>
<b>001-250-001</b> (Failed Processor Board ECC)	1. <b>System Board</b>
<b>005-XXX-000</b> (Failed Video test)	1. <b>Video adapter (if installed)</b> 2. System Board
<b>011-XXX-000</b> (Failed COM1 Serial Port test)	1. <b>Check loopback plug connected to externalized serial port</b> 2. Check cable from externalized port to system board. Should connect to Serial Port A on the system board (J52). 3. System Board
<b>011-XXX-001</b> (Failed COM2 Serial Port test)	1. <b>Check loopback plug connected to externalized serial port</b> 2. Check cable from externalized port to system board. Should connect to Serial Port B on the system board (J51). 3. System Board
<b>014-XXX-000</b> (Failed Parallel Port test)	1. <b>System Board</b>
<b>015-XXX-001</b> (USB interface not found, board damaged)	1. <b>System Board</b>
<b>015-XXX-198</b> (USB device connected during USB test)	1. <b>Remove USB devices from USB1 and USB2.</b> 2. System Board
<b>020-XXX-000</b> (Failed PCI Interface test)	1. System Board
<b>030-XXX-000</b> (Failed Internal SCSI interface test)	1. <b>System Board</b>
<b>035-XXX-099</b>	1. <b>No RAID adapters were found.</b> 2. If adapter is installed re-check connection.
<b>035-XXX-S99</b> (Failed RAID test on PCI slot S, check System Error Log before replacing a FRU)	1. <b>RAID Adapter</b> 2. SCSI Backplane 3. Cable
<b>035-XXX-SNN</b> (Check System Error Log before replacing a FRU, NN = SCSI ID of failing fixed disk)	1. <b>Fixed Disk with SCSI ID NN on RAID adapter in PCI slot S.</b>

Error Code/Symptom	FRU/Action
<b>035-253-S99</b> (RAID adapter initialization failure)	<ol style="list-style-type: none"> <li>1. <b>ServeRAID Adapter in slot S is not configured properly.</b> Obtain the basic and extended configuration status and refer to the ServeRAID Hardware Maintenance Manual for more information.</li> <li>2. Cable</li> <li>3. SCSI Backplane</li> <li>4. Adapter</li> </ol>
<b>089-XXX-001</b> (Failed Microprocessor test)	<ol style="list-style-type: none"> <li>1. <b>Microprocessor 1</b></li> <li>2. System Board</li> </ol>
<b>089-XXX-002</b> (Failed Optional Microprocessor test)	<ol style="list-style-type: none"> <li>1. <b>Microprocessor 2</b></li> <li>2. System Board</li> </ol>
<b>165-XXX-000</b> (Failed Service Processor test)	<ol style="list-style-type: none"> <li>1. <b>System Board</b></li> </ol>
<b>180-XXX-000</b> (Diagnostics LED failure)	<ol style="list-style-type: none"> <li>1. <b>Run Diagnostic LED test for the failing LED.</b></li> </ol>
<b>180-XXX-001</b> (Failed information LED panel test)	<ol style="list-style-type: none"> <li>1. <b>Switch Card / Information LED Panel</b></li> </ol>
<b>180-XXX-003</b> (Failed System Board LED test)	<ol style="list-style-type: none"> <li>1. <b>System Board</b></li> </ol>
<b>180-XXX-005</b> (Failed SCSI Backplane LED test)	<ol style="list-style-type: none"> <li>1. <b>SCSI Backplane</b></li> <li>2. SCSI Backplane Cable</li> <li>3. System Board</li> </ol>
<b>201-XXX-0NN</b> (Failed Memory test, see "Memory Settings" on page 33)	<ol style="list-style-type: none"> <li>1. <b>DIMM Location slots 1-4 where NN = DIMM location.</b> <b>Note:</b> NN 1=DIMM 1 NN 2=DIMM 2 NN 3=DIMM 3 NN 4=DIMM 4</li> <li>2. System Board</li> </ol>
<b>201-XXX-999</b> (Multiple DIMM failure, see error text)	<ol style="list-style-type: none"> <li>1. <b>See error text for failing DIMMs</b></li> <li>2. System Board</li> </ol>
<b>202-XXX-001</b> (Failed System Cache test)	<ol style="list-style-type: none"> <li>1. <b>Microprocessor 1</b></li> <li>2. System Board</li> </ol>
<b>202-XXX-002</b> (Failed System Cache test)	<ol style="list-style-type: none"> <li>1. <b>Microprocessor 2</b></li> <li>2. System Board</li> </ol>
<b>206-XXX-000</b> (Failed Diskette Drive test)	<ol style="list-style-type: none"> <li>1. <b>Try test with another diskette</b></li> <li>2. Cable</li> <li>3. Diskette Drive</li> <li>4. System Board</li> </ol>
<b>215-XXX-000</b> (Failed IDE CD-ROM test)	<ol style="list-style-type: none"> <li>1. <b>CD-ROM Drive Cables</b></li> <li>2. CD-ROM Drive</li> <li>3. System Board</li> </ol>
<b>217-XXX-000</b> (Failed Fixed Disk test) <b>Note:</b> If RAID is configured, the fixed disk number refers to the RAID logical array	<ol style="list-style-type: none"> <li>1. <b>Fixed Disk 1</b></li> <li>2. System Board</li> </ol>



<b>Error Code/Symptom</b>	<b>FRU/Action</b>
<b>217-XXX-001</b> (Failed BIOS Fixed Disk test) <b>Note:</b> If RAID is configured, the fixed disk number refers to the RAID logical array	<ol style="list-style-type: none"> <li><b>Fixed Disk 2</b></li> <li>System Board</li> </ol>
<b>264-XXX-0NN</b> (Failed Tape Drive test)	<ol style="list-style-type: none"> <li><b>Tape Cartridge, if user executed the Read/Write Tape Drive test (failure code of XXX = 256)</b></li> <li>SCSI or Power Cable connected to tape drive with SCSI ID NN.</li> <li>Tape Drive with SCSI ID NN. (Refer to the Help and Service Information appendix of the tape drive's User Guide.)</li> <li>System Board or SCSI Controller. (Run SCSI Controller Diagnostic to determine if the SCSI bus is functioning properly.)</li> </ol>
<b>264-XXX-999</b> (Errors on multiple tape drives, see error text for more info)	<ol style="list-style-type: none"> <li><b>See error messages/text in the PC Doctor error log for detailed information on each individual tape drive error.</b></li> </ol>
<b>301-XXX-000</b> (Failed Keyboard test)	<ol style="list-style-type: none"> <li><b>Keyboard</b></li> <li>System Board</li> </ol>
<b>405-XXX-000</b> (Failed Ethernet test on controller on the System Board)	<ol style="list-style-type: none"> <li><b>Verify that Ethernet is not disabled in BIOS.</b></li> <li>System Board</li> </ol>
<b>405-XXX-A0N</b> (Failed Ethernet test on adapter in slot A)	<ol style="list-style-type: none"> <li>For A=0, system board</li> <li>For A &gt;0, adapter in PCI slot A</li> </ol>
<b>415-XXX-000</b> (Failed Modem test)	<ol style="list-style-type: none"> <li><b>Cable</b> <b>Note:</b> Ensure modem is present and attached to server.</li> <li>Modem</li> <li>System Board</li> </ol>

## **Error symptoms**

<b>Error Symptom</b>	<b>FRU/Action</b>
<b>CD is not working properly.</b>	<ol style="list-style-type: none"> <li><b>Clean the CD.</b></li> <li>Run CD-ROM diagnostics</li> <li>CD-ROM Drive</li> </ol>
<b>CD-ROM drive tray is not working.</b> (The server must be powered-on)	<ol style="list-style-type: none"> <li><b>Insert the end of a paper clip into the manual tray-release opening.</b></li> <li>Run CD-ROM diagnostics</li> <li>CD-ROM Drive</li> </ol>
<b>CD-ROM drive is not recognized.</b>	<ol style="list-style-type: none"> <li><b>Run Configuration/Setup, enable primary IDE channel.</b></li> <li>Check cables and jumpers.</li> <li>Check for correct device driver.</li> <li>Run CD-ROM diagnostics</li> <li>CD-ROM Drive</li> <li>System Board</li> </ol>

Error Symptom	FRU/Action
<b>Power switch does not work and reset button does work.</b> (SW 1-5 is force power-on switch.)	<ol style="list-style-type: none"> <li>1. <b>Reseat connector</b></li> <li>2. Switch Card</li> <li>3. System Board</li> </ol>
<b>Diskette drive in-use light stays on, or the system bypasses the diskette drive, or the diskette drive does not work</b>	<ol style="list-style-type: none"> <li>1. <b>If there is a diskette in the drive, verify that:</b> <ol style="list-style-type: none"> <li>a. The diskette drive is enabled in the Configuration/Setup utility program.</li> <li>b. The diskette is good and not damaged. (Try another diskette if you have one.)</li> <li>c. The diskette is inserted correctly in the drive.</li> <li>d. The diskette contains the necessary files to start the server.</li> <li>e. The software program is OK.</li> <li>f. Cable is installed correctly (proper orientation)</li> </ol> </li> <li>2. Run Diskette Drive Diagnostics</li> <li>3. Cable</li> <li>4. Diskette Drive</li> <li>5. System Board</li> </ol>
<b>Monitor problems (general).</b> Some IBM monitors have their own self-tests. If you suspect a problem with the monitor, refer to the information that comes with the monitor for adjusting and testing instructions.	<ol style="list-style-type: none"> <li>1. <b>Monitor</b></li> <li>2. Run Video Diagnostics. If diagnostics pass, the problem may be a video driver.</li> <li>3. Display Adapter / System Board</li> </ol>
<b>No video</b>	<ol style="list-style-type: none"> <li>1. <b>Make sure correct machine is selected.</b></li> <li>2. Make sure all cables are locked down.</li> </ol>

## POST error codes

In the following error codes, X can be any number or letter.

Error Code/Symptom	FRU/Action
<b>062</b> (Three consecutive boot failures using the default configuration.)	<ol style="list-style-type: none"> <li>1. <b>Run Configuration/Setup</b></li> <li>2. Battery</li> <li>3. System Board</li> <li>4. Processor</li> </ol>
<b>101, 102</b> (System and processor error)	<ol style="list-style-type: none"> <li>1. <b>System Board</b></li> </ol>
<b>106</b> (System and processor error)	<ol style="list-style-type: none"> <li>1. <b>System Board</b></li> </ol>
<b>111</b> (Channel check error)	<ol style="list-style-type: none"> <li>1. <b>Failing adapter</b></li> <li>2. Memory DIMM</li> <li>3. System Board</li> </ol>
<b>114</b> (Adapter read-only memory error)	<ol style="list-style-type: none"> <li>1. <b>Failing Adapter</b></li> <li>2. Run Diagnostics</li> </ol>

Error Code/Symptom	FRU/Action
<b>129</b> (Internal cache error)	<ol style="list-style-type: none"> <li>1. <b>Processor</b></li> <li>2. Optional Processor (if installed)</li> <li>3. System Board.</li> </ol>
<b>151</b> (Real time clock error)	<ol style="list-style-type: none"> <li>1. <b>Run Diagnostics</b></li> <li>2. Battery</li> <li>3. System Board</li> </ol>
<b>161</b> (Real time clock battery error)	<ol style="list-style-type: none"> <li>1. <b>Run Configuration/Setup</b></li> <li>2. Battery</li> <li>3. System Board</li> </ol>
<b>162</b> (Device Configuration Error) <b>Note:</b> Be sure to load the default settings and any additional desired settings; then, <b>save the configuration.</b>	<ol style="list-style-type: none"> <li>1. <b>Run Configuration/Setup</b></li> <li>2. Battery</li> <li>3. Failing Device</li> <li>4. System Board</li> </ol>
<b>163</b> (Real-Time Clock error)	<ol style="list-style-type: none"> <li>1. <b>Run Configuration/Setup</b></li> <li>2. Battery</li> <li>3. System Board</li> </ol>
<b>164</b> (Memory configuration changed, see "Memory settings" on page 33.)	<ol style="list-style-type: none"> <li>1. <b>Run Configuration/Setup</b></li> <li>2. DIMM</li> <li>3. System Board.</li> </ol>
<b>165</b> (Service Processor failure)	<ol style="list-style-type: none"> <li>1. <b>System Board.</b></li> </ol>
<b>175</b> (Hardware error)	<ol style="list-style-type: none"> <li>1. <b>System Board</b></li> </ol>
<b>176</b> (Computer cover or cable cover was removed without a key being used)	<ol style="list-style-type: none"> <li>1. <b>Run Configuration/Setup</b></li> <li>2. System Board</li> </ol>
<b>177, 178</b> (Security hardware error)	<ol style="list-style-type: none"> <li>1. <b>Run Configuration/Setup</b></li> <li>2. System Board</li> </ol>
<b>184</b> (Power-on password corrupted)	<ol style="list-style-type: none"> <li>1. <b>Run Configuration/Setup</b></li> <li>2. System Board</li> </ol>
<b>185</b> (Drive startup sequence information corrupted)	<ol style="list-style-type: none"> <li>1. <b>Run Configuration/Setup</b></li> <li>2. System Board</li> </ol>
<b>186</b> (Security hardware control logic failed)	<ol style="list-style-type: none"> <li>1. <b>Run Configuration/Setup</b></li> <li>2. System Board</li> </ol>
<b>187</b> (VPD serial number not set.)	<ol style="list-style-type: none"> <li>1. <b>Set serial number in Setup</b></li> <li>2. System Board</li> </ol>
<b>188</b> (Bad EEPROM CRC #2)	<ol style="list-style-type: none"> <li>1. <b>Run Configuration/Setup</b></li> <li>2. System Board</li> </ol>
<b>189</b> (An attempt was made to access the server with invalid passwords)	<ol style="list-style-type: none"> <li>1. <b>Run Configuration/Setup, enter the administrator password</b></li> </ol>

Error Code/Symptom	FRU/Action
<b>201</b> (Memory test error, see "Memory Settings" on page 33.) If the server does not have the latest level of BIOS installed, update the BIOS to the latest level and run the diagnostic program again.	<ol style="list-style-type: none"> <li>1. <b>DIMM</b></li> <li>2. System Board</li> </ol>
<b>229</b> (Cache error)	<ol style="list-style-type: none"> <li>1. <b>Processor</b></li> <li>2. Optional Processor (if installed)</li> </ol>
<b>262</b> (DRAM parity configuration error)	<ol style="list-style-type: none"> <li>1. <b>Run configuration / setup</b></li> <li>2. Battery</li> <li>3. System Board</li> </ol>
<b>289</b> (DIMM has been disabled by the user or system, see "Memory Settings" on page 33.)	<ol style="list-style-type: none"> <li>1. <b>Run Configuration/Setup, if disabled by user</b></li> <li>2. Disabled DIMM, if not disabled by user.</li> <li>3. System Board.</li> </ol>
<b>301</b> (Keyboard or keyboard controller error)	<ol style="list-style-type: none"> <li>1. <b>Keyboard</b></li> <li>2. System Board</li> </ol>
<b>303</b> (Keyboard controller error)	<ol style="list-style-type: none"> <li>1. <b>System Board</b></li> </ol>
<b>602</b> (Invalid diskette boot record)	<ol style="list-style-type: none"> <li>1. <b>Diskette</b></li> <li>2. Diskette Drive</li> <li>3. Cable</li> <li>4. System Board</li> </ol>
<b>604</b> (Diskette drive error)	<ol style="list-style-type: none"> <li>1. <b>Run Configuration/Setup and Diagnostics</b></li> <li>2. Diskette Drive</li> <li>3. Drive Cable</li> <li>4. System Board</li> </ol>
<b>605</b> (Unlock failure)	<ol style="list-style-type: none"> <li>1. <b>Diskette Drive</b></li> <li>2. Drive Cable</li> <li>3. System Board</li> </ol>
<b>662</b> (Diskette drive configuration error)	<ol style="list-style-type: none"> <li>1. <b>Run Configuration/Setup and Diagnostics</b></li> <li>2. Diskette Drive</li> <li>3. Drive Cable</li> <li>4. System Board</li> </ol>
<b>762</b> (Coprocessor configuration error)	<ol style="list-style-type: none"> <li>1. <b>Run configuration setup</b></li> <li>2. Battery</li> <li>3. Processor</li> </ol>
<b>962</b> (Parallel port error)	<ol style="list-style-type: none"> <li>1. <b>Disconnect external cable on parallel port.</b></li> <li>2. Run Configuration/Setup</li> <li>3. System Board</li> </ol>
<b>11XX</b> (System board serial port 1 or 2 error)	<ol style="list-style-type: none"> <li>1. <b>Disconnect external cable on serial port.</b></li> <li>2. Run Configuration/Setup</li> <li>3. System Board</li> </ol>

Error Code/Symptom	FRU/Action
<b>0001200</b> (Machine check architecture error)	<ol style="list-style-type: none"> <li>1. <b>Processor 1</b></li> <li>2. Optional Processor 2</li> <li>3. System Board.</li> </ol>
<b>1600</b> (The Service Processor is not functioning) Do the following before replacing a FRU:	<ol style="list-style-type: none"> <li>1. <b>Do the following before replacing a FRU:</b> <ol style="list-style-type: none"> <li>a. Ensure that a jumper is not installed on J28.</li> <li>b. Remove the ac power to the system, wait 20 seconds; then, re-connect the ac power. Wait 30 seconds; then, power-on the system.</li> </ol> </li> <li>2. System Board</li> </ol>
<b>1601</b> (The system is able to communicate to the Service Processor, but the Service Processor failed to respond at the start of POST.)	<ol style="list-style-type: none"> <li>1. <b>Do the following before replacing a FRU:</b> <ol style="list-style-type: none"> <li>a. Remove the ac power to the system, wait 20 seconds; then, re-connect the ac power. Wait 30 seconds; then, power-on the system.</li> <li>b. Flash update the Service Processor.</li> </ol> </li> <li>2. System Board</li> </ol>
<b>1762</b> (Fixed Disk Configuration error) (IDE drive only)	<ol style="list-style-type: none"> <li>1. <b>Fixed Disk Drive</b></li> <li>2. Fixed Disk Cables</li> <li>3. Run Configuration/Setup</li> <li>4. System Board</li> </ol>
<b>178X</b> (Fixed Disk error) (IDE drive only)	<ol style="list-style-type: none"> <li>1. <b>Fixed Disk Cables</b></li> <li>2. Run Diagnostics</li> <li>3. Fixed Disk Drive</li> <li>4. System Board</li> </ol>
<b>1800</b> (No more hardware interrupt available for PCI adapter)	<ol style="list-style-type: none"> <li>1. <b>Run Configuration/Setup</b></li> <li>2. Remove Adapter</li> </ol>
<b>1801</b> (no more ROM space available for PCI adapter)	<ol style="list-style-type: none"> <li>1. <b>Run Configuration/Setup</b></li> <li>2. Remove adapter</li> <li>3. Disable adapter BIOS on adapter and run Configuration/Setup</li> </ol>
<b>1962</b> (Drive does not contain a valid boot sector)	<ol style="list-style-type: none"> <li>1. <b>Verify a bootable operating system is installed.</b></li> <li>2. Run Diagnostics</li> <li>3. Hard Disk Drive</li> <li>4. SCSI Backplane</li> <li>5. Cable</li> <li>6. System Board</li> </ol>
<b>2400</b> (Video controller test failure)	<ol style="list-style-type: none"> <li>1. <b>Video Adapter (if installed)</b></li> <li>2. System Board</li> </ol>
<b>2462</b> (Video memory configuration error)	<ol style="list-style-type: none"> <li>1. <b>Video Adapter (if installed)</b></li> <li>2. System Board</li> </ol>

Error Code/Symptom	FRU/Action
<b>5962</b> (IDE CD-ROM configuration error)	<ol style="list-style-type: none"> <li>1. <b>Run Configuration/Setup</b></li> <li>2. CD-ROM Drive</li> <li>3. CD-ROM Power Cable</li> <li>4. IDE Cable</li> <li>5. System Board</li> <li>6. Battery</li> </ol>
<b>8603</b> (Pointing Device Error)	<ol style="list-style-type: none"> <li>1. <b>Pointing Device</b></li> <li>2. System Board</li> </ol>
<b>00019501</b> (Processor 1 is not functioning - check VRM and processor LEDs)	<ol style="list-style-type: none"> <li>1. <b>Processor 1</b></li> <li>2. System Board</li> </ol>
<b>00019502</b> (Processor 2 is not functioning - check VRM and processor LEDs)	<ol style="list-style-type: none"> <li>1. <b>Processor 2</b></li> <li>2. System Board</li> </ol>
<b>00019701</b> (Processor 1 failed)	<ol style="list-style-type: none"> <li>1. <b>Processor 1</b></li> <li>2. System Board</li> </ol>
<b>00019702</b> (Processor 2 failed)	<ol style="list-style-type: none"> <li>1. <b>Processor 2</b></li> <li>2. System Board</li> </ol>
<b>00180200</b> (No more I/O space available for PCI adapter)	<ol style="list-style-type: none"> <li>1. <b>Run Configuration/Setup</b></li> <li>2. Failing Adapter</li> <li>3. System Board</li> </ol>
<b>00180300</b> (No more memory above 1MB for PCI adapter)	<ol style="list-style-type: none"> <li>1. <b>Run Configuration/Setup</b></li> <li>2. Failing Adapter</li> <li>3. System Board</li> </ol>
<b>00180400</b> (No more memory below 1MB for PCI adapter)	<ol style="list-style-type: none"> <li>1. <b>Run Configuration/Setup</b></li> <li>2. Move the failing adapter to slot 1 or 2</li> <li>3. Failing Adapter</li> <li>4. System Board</li> </ol>
<b>00180500</b> (PCI option ROM checksum error)	<ol style="list-style-type: none"> <li>1. <b>Remove Failing PCI Card</b></li> <li>2. System Board</li> </ol>
<b>00180600</b> (PCI adapter self test)	<ol style="list-style-type: none"> <li>1. <b>Run Configuration/Setup</b></li> <li>2. Move the failing adapter to slot 1 or 2</li> <li>3. Failing Adapter</li> <li>4. System Board</li> </ol>
<b>00180700, 00180800</b> (General PCI error)	<ol style="list-style-type: none"> <li>1. <b>System Board</b></li> <li>2. PCI Card</li> </ol>
<b>01295085</b> (ECC checking hardware test error)	<ol style="list-style-type: none"> <li>1. <b>System Board.</b></li> <li>2. Processor</li> </ol>
<b>01298001</b> (No update data for processor 1)	<ol style="list-style-type: none"> <li>1. <b>Ensure all processors are the same stepping level and cache size.</b></li> <li>2. Processor 1</li> </ol>
<b>01298002</b> (No update data for processor 2)	<ol style="list-style-type: none"> <li>1. <b>Ensure all processors are the same stepping level and cache size.</b></li> <li>2. Processor 2</li> </ol>

Error Code/Symptom	FRU/Action
<b>01298101</b> (Bad update data for processor 1)	<ol style="list-style-type: none"> <li>1. <b>Ensure all processors are the same stepping level and cache size.</b></li> <li>2. Processor 1</li> </ol>
<b>01298102</b> (Bad update data for processor 2)	<ol style="list-style-type: none"> <li>1. <b>Ensure all processors are the same stepping level and cache size.</b></li> <li>2. Processor 2</li> </ol>
<b>I9990301</b> (Fixed boot sector error)	<ol style="list-style-type: none"> <li>1. <b>Hard Disk Drive</b></li> <li>2. Cable</li> <li>3. SCSI Backplane</li> <li>4. System Board</li> </ol>
<b>I9990305</b> (Fixed boot sector error; no operating system installed)	<ol style="list-style-type: none"> <li>1. <b>Install operating system to hard disk drive.</b></li> </ol>
<b>I9990650</b> (AC power has been restored)	<ol style="list-style-type: none"> <li>1. <b>Check power cable</b></li> <li>2. Check for interruption of power supply</li> <li>3. Power Cable</li> </ol>

## SCSI error codes

Error Code	FRU/Action
<p><b>All SCSI Errors</b> One or more of the following might be causing the problem:</p> <ul style="list-style-type: none"> <li>• A failing SCSI device (adapter, drive, controller)</li> <li>• An improper SCSI configuration or SCSI termination jumper setting</li> <li>• Duplicate SCSI IDs in the same SCSI chain</li> <li>• A missing or improperly installed SCSI terminator</li> <li>• A defective SCSI terminator</li> <li>• An improperly installed cable</li> <li>• A defective cable</li> </ul>	<ol style="list-style-type: none"> <li>1. <b>External SCSI devices must be powered-on before you power-on the server.</b></li> <li>2. The cables for all external SCSI devices are connected correctly.</li> <li>3. If you have attached an external SCSI device to the server, make sure the external SCSI termination is set to automatic.</li> <li>4. The last device in each SCSI chain is terminated correctly.</li> <li>5. The SCSI devices are configured correctly.</li> </ol>

## Temperature error messages

Message	Action
<b>DASD Over recommended Temperature (sensor X)</b> (level-warning; DASD bay "X" had over temperature condition)	<ol style="list-style-type: none"> <li>1. <b>Ensure system is being properly cooled;</b> see "Temperature checkout" on page 26.</li> </ol>
<b>DASD under recommended temperature (sensor X)</b> (level-warning; direct access storage device bay "X" had under temperature condition)	<ol style="list-style-type: none"> <li>1. <b>Ambient temperature must be within normal operating specifications;</b> see "Features and specifications" on page 4.</li> </ol>

Message	Action
<b>DASD 1 Over Temperature</b> (level-critical; sensor for DASD1 reported temperature over recommended range)	1. <b>Ensure system is being properly cooled;</b> see “Temperature checkout” on page 26.
<b>Power Supply "X" Temperature Fault</b> (level-critical; power supply "x" had over temperature condition)	1. <b>Ensure system is being properly cooled;</b> see “Temperature checkout” on page 26. 2. Replace Power Supply "X"
<b>System board is over recommended temperature</b> (level-warning; system board is over recommended temperature)	1. <b>Ensure system is being properly cooled;</b> see “Temperature checkout” on page 26. 2. Replace system board
<b>System board is under recommended temperature</b> (level-warning; system board is under recommended temperature)	1. <b>Ambient temperature must be within normal operating specifications;</b> see “Features and specifications” on page 4.
<b>System over temperature for CPU "X"</b> (level-warning; CPU "X" reporting over temperature condition)	1. <b>Ensure system is being properly cooled;</b> see “Temperature checkout” on page 26.
<b>System under recommended CPU "X" temperature</b> (level-warning; system reporting under temperature condition for CPU "X")	1. <b>Ambient temperature must be within normal operating specifications;</b> see “Features and specifications” on page 4.

## Fan error messages

Message	Action
<b>Fan "X" failure</b> (level-critical; fan "X" had a failure)	1. <b>Check connections to fan "X"</b> 2. Replace fan "X"
<b>Fan "X" fault</b> (level-critical; fan "X" beyond recommended RPM range)	1. <b>Check connections to fan "X"</b> 2. Replace fan "X"
<b>Fan "X" Outside Recommended Speed Action</b>	1. <b>Replace Fan "X"</b>

## System shutdown

Refer to the following tables when experiencing system shutdown related to voltage or temperature problems.

### Voltage related system shutdown

Message	Action
<b>System shutoff due to "X" current over max value</b> (level-critical; system drawing too much current on voltage "X" bus)	1. <b>See “Power checkout” on page 24.</b>
<b>System shutoff due to "X" current under min. value</b> (level-critical; current on voltage bus "X" under minimum value)	1. <b>See “Power checkout” on page 24.</b>



Message	Action
<b>System shutoff due to "X" V overvoltage</b> (level-critical; system shutoff due to "X" supply over voltage)	<ol style="list-style-type: none"> <li>1. <b>Check power supply connectors</b></li> <li>2. Replace power supply</li> </ol>
<b>System shutoff due to "X" V undervoltage</b> (level-critical system shutoff due to "X" supply under voltage)	<ol style="list-style-type: none"> <li>1. <b>Check power supply connectors</b></li> <li>2. Replace power supply</li> </ol>
<b>System shutoff due to VRM "X" over voltage</b>	<ol style="list-style-type: none"> <li>1. <b>Replace power supply</b></li> </ol>

## Temperature related system shutdown

Message	Action
<b>System shutoff due to board over temperature</b> (level-critical; board is over temperature)	<ol style="list-style-type: none"> <li>1. <b>Ensure system is being properly cooled</b>, see "Temperature checkout" on page 26.</li> <li>2. Replace system board</li> </ol>
<b>System shutoff due to CPU "X" over temperature</b> (level-critical; CPU "X" is over temperature)	<ol style="list-style-type: none"> <li>1. <b>Ensure system is being properly cooled</b>, see "Temperature checkout" on page 26.</li> <li>2. Replace CPU "X"</li> </ol>
<b>System shutoff due to CPU "X" under temperature</b> (level-critical; CPU "X" is under temperature)	<ol style="list-style-type: none"> <li>1. <b>Ambient temperature must be within normal operating specifications</b>, see "Features and specifications" on page 4.</li> <li>2. Replace CPU "X"</li> </ol>
<b>System shutoff due to DASD temperature (sensor X)</b> (level-critical; DASD area reported temperature outside recommended operating range)	<ol style="list-style-type: none"> <li>1. <b>Ensure system is being properly cooled</b>, see "Temperature checkout" on page 26.</li> <li>2. Replace SCSI Backplane</li> </ol>
<b>System shutoff due to high ambient temperature</b> (level-critical; high ambient temperature)	<ol style="list-style-type: none"> <li>1. <b>Ambient temperature must be within normal operating specifications</b>, see "Features and specifications" on page 4.</li> <li>2. Replace Front Panel Assembly</li> </ol>
<b>System shutoff due to system board under temperature</b> (level-critical; system board is under temperature)	<ol style="list-style-type: none"> <li>1. <b>Ambient temperature must be within normal operating specifications</b>, see "Features and specifications" on page 4.</li> <li>2. Replace System Board</li> </ol>

## DASD checkout

Message	Action
<b>Hard drive "X" removal detected</b> (level-critical; hard drive "X" has been removed)	<ol style="list-style-type: none"> <li>1. <b>Information only, take action as appropriate.</b></li> </ol>

## Bus fault messages

Message	Action
<b>Failure reading I2C device. Check devices on bus 0.</b>	<ol style="list-style-type: none"> <li>1. <b>Replace system board</b></li> </ol>

Message	Action
Failure reading I2C device. Check devices on bus 1.	<ol style="list-style-type: none"> <li>1. Front Panel</li> <li>2. Replace system board</li> </ol>
Failure reading I2C device. Check devices on bus 2.	<ol style="list-style-type: none"> <li>1. <b>Replace DASH backplane</b></li> <li>2. Replace system board</li> </ol>
Failure reading I2C device. Check devices on bus 3.	<ol style="list-style-type: none"> <li>1. <b>Replace system board</b></li> </ol>
Failure reading I2C device. Check devices on bus 4.	<ol style="list-style-type: none"> <li>1. <b>Replace DIMM</b></li> <li>2. Replace system board</li> </ol>

## Undetermined problems

You are here because the diagnostic tests did not identify the failure, the Devices List is incorrect, or the system is inoperative. If this has occurred proceed as follows:

**Note:** A corrupt CMOS can cause undetermined problems.

1. Ensure that the system is connected to an AC power source.
2. Press the power switch.

**Note:** If AC power has been removed from system, allow 30 seconds after restoring AC power before pressing power control button. See "Turning on the server" on page 8.

**Note:** If system was powered-on when AC power was removed, system should restart automatically when AC power is restored.

3. Are the power indicator LEDs (front and rear) ON or blinking?
  - a. No. Check AC power into system. If AC power into system is good, suspect the following FRUs in the order listed:
    - 1) Power supply
    - 2) System board
  - b. Yes, power indicators (front and rear) are blinking.

Turn switch 5 on switch block 1 to ON. If system powers-on, turn switch 5 on switch block 1 to OFF and replace front panel assembly. If system does not power-on, reconfigure system to minimum operating requirements and retry. If problem remains, suspect the following FRUs in the order listed:

    - 1) Power supply
    - 2) System board
  - c. Yes, power indicator LEDs (front and rear) are ON.
    - 1) Power-off system.
    - 2) Ensure system is cabled correctly.
    - 3) Reconfigure system to minimum operating requirements.

**Note:** Minimum operating requirements are:

- a) 1 Power Supply
- b) System Board
- c) 1 Microprocessor
- d) 1 Terminator Card
- e) Memory Module (with a minimum of 128 MB DIMM)

4) Power-on system. If problem remains, suspect the following FRUs in the order listed:

- a) Power supply
- b) System board

If problem goes away, replace removed items one at a time until failing item is found (power-on and reconfigure system each time).

**Notes:**

- 1. If the problem goes away when you remove an adapter from the system, and replacing that adapter does not correct the problem, suspect the System Board.
- 2. If you suspect a networking problem and all the system tests pass, suspect a network cabling problem external to the system.



---

# Chapter 8. Parts listing

---

## System

The xSeries 330 Parts Listing supports the following models: 11Y, 31Y.

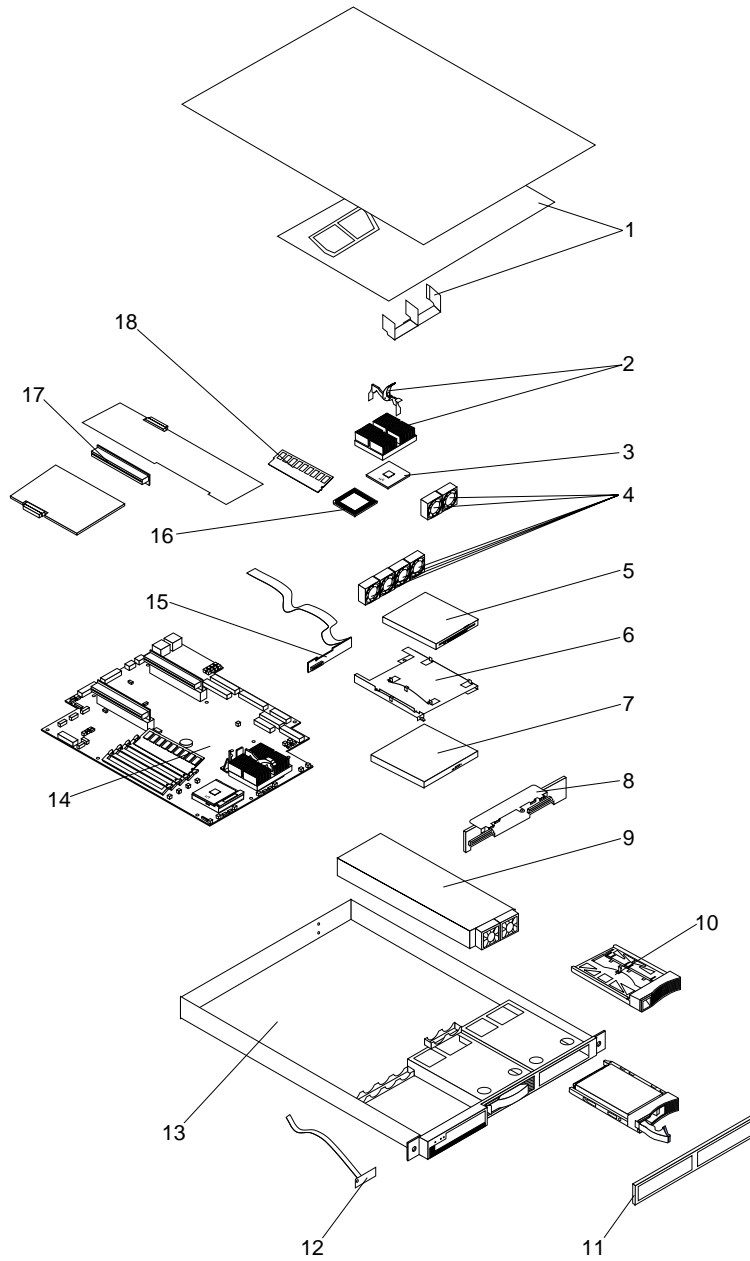

<b>Index</b>	<b>System Part (Model Number)</b>	<b>FRU Number</b>
1	Bracket/Baffle (All Models)	00N6993
2	Heat Sink/Clip Assembly (All Models)	00N6987
3	Terminator Card (All Models)	09N8007
4	Fan with Connector (All Models)	00N6991
5	3.5 Floppy Disk Drive, 12.7MM (All Models)	36L8645
6	Floppy Disk Drive/CD Bracket (All Models)	00N6999
7	CD-ROM drive, 24X LG (All Models)	09N0883
8	Hard Disk Drive Backplane (All Models)	19K1038
9	Power Supply, 200 Watt (All Models)	00N7711
10	Blank Hard Disk Drive (All Models)	00N7259
11	Bezel, Right Front (All Models)	00N6992
12	Switch Card (All Models)	09N7225
13	Chassis (All Models)	00N6990
14	Planar (All Models)	19K1326
15	Slim Adapter Board (All Models)	19K1351
16	866/133 MHz Processor (Model 31Y only)	06P4439
17	PCI Riser Card (All Models)	19K1350
18	Memory, 256MB/133MHz ECC (All Models)	33L3145
18	Memory, 128MB 133MHz ECC (All Models) (optional)	33L3143
18	Memory, 512MB 133MHz ECC (All Models) (optional)	33L3151
18	Memory, 1GB 133MHz ECC (All Models) (optional)	33L3153
	Drive, 3.5 Floppy 12.7MM (All Models)	36L8645
	Hardware Kit (All Models)	00N6997
	2 Port Serial Plate (All Models)	00N7021
	Rail Assembly (All Models)	00N6994
	External Interface Adapter Bracket (All Models)	00N6995
	Cable, Backplane-Planar (All Models)	00N6988
	Cable, CD-Power (All Models)	00N6989
	Cable, Serial Chassis-Planar (All Models)	00N6996
	Cable, FDD Signal (All Models)	00N6998
	Cable, PCI Adapter-Backplane (All Models)	00N7000
	Cable, Analog (245mm) (All Models)	00N7003
	Cable, Analog (2m) (All Models)	00N7006
	Cable, Analog M/K/V Female (245mm) (All Models)	00N7004
	Cable, Console (All Models)	06P4792
	Battery, 3.0 Volt (8590) (All Models)	33F8354
	Line Cord (All Models)	36L8886
	36.4GB 7200rpm Ultra 160 SCSI (All Models) (optional)	09N0947

<b>Index</b>	<b>System Part (Model Number)</b>	<b>FRU Number</b>
	9.1GB 7200rpm Ultra 160 SCSI (All Models) (optional)	19K1461
	18.2GB 7200rpm Ultra 160 SCSI (All Models) (optional)	19K1463
	9.1GB 10Krpm Ultra 160 SCSI (All Models) (optional)	19K1465
	18.2GB 10Krpm Ultra 160 SCSI (All Models) (optional)	19K1467
	36.4GB 10Krpm Ultra 160 SCSI (All Models) (optional)	19K1469

---

## Keyboards

<b>Keyboard</b>	<b>FRU No.</b>
US English	37L2551
French Canadian	37L2552
LA Spanish	37L2553
Arabic	37L2555
Belgium/French	37L2556
Belgium/UK	37L2557
Bulgarian	37L2558
Czech	37L2559
Danish	37L2560
Dutch	37L2561
French	37L2562
German	37L2563
Greek	37L2564
Hebrew	37L2565
Hungarian	37L2566
Korean	02K0901
Iceland	37L2567
Italy	37L2568
Norwegian	37L2569
Polish	37L2570
Portuguese	37L2571
Romanian	37L2572
Russian	37L2573
Serbian/Cyrillic	37L2574
Slavic	37L2575
Spanish	37L2576
Swedish/Finn	37L2577
Swiss, F/G	37L2578

<b>Keyboard</b>	<b>FRU No.</b>
Turkish	37L2579
Turkish	37L2580
UK English	37L2581
Yugosl/Lat	37L2582
US English-EMEA	37L2583
Chinese/US	37L2585
Thailand	37L2587
French Canadian	37L0913

## Power cords

<b>Power cord</b>	<b>FRU No.</b>
China (PRC)	01K9851
Japan	01K9853
Thailand	12J5120
Israel	12J5122
Bangladesh, Burma, India, Pakistan, South Africa, Sri Lanka	12J5124
Chile, Ethiopia, Italy, Libya, Somalia	12J5126
Argentina, Australia, New Zealand, Papua New Guinea, Paraguay, Uruguay, Western Samoa	12J5128
Antigua, Bahrain, Brunei, Channel Islands, Cyprus, Dubai, Fiji, Ghana, China (Hong Kong S.A.R.), Iraq, Ireland, Kenya, Kuwait, Malawi, Malaysia, Malta, Nepal, Nigeria, Polynesia, Qatar, Sierra Leone, Singapore, Tanzania, Uganda, United Kingdom, Yemen, Zambia	12J5987
Afghanistan, Algeria, Andorra, Angola, Austria, Belgium, Benin, Bulgaria, Burkina Faso, Burundi, Cameroon, Central African Rep., Chad, Czech Republic, Egypt, Finland, France, French Guyana, Germany, Greece, Guinea, Hungary, Iceland, Indonesia, Iran, Ivory Coast, Jordan, Lebanon, Luxembourg, China (Macao S.A.R.), Malagasy, Mali, Martinique, Mauritania, Mauritius, Monaco, Morocco, Mozambique, Netherlands, New Caledonia, Niger, Norway, Poland, Portugal, Romania, Senegal, Slovakia, Spain, Sudan, Sweden, Syria, Togo, Tunisia, Turkey, former USSR, Vietnam, former Yugoslavia, Zaire, Zimbabwe	55H6643
Denmark, Switzerland, Liechtenstein	55H6646
Bahamas, Barbados, Bermuda, Bolivia, Brazil, Canada, Cayman Islands, Colombia, Costa Rica, Dominican Republic, Ecuador, El Salvador, Guatemala, Guyana, Haiti, Honduras, Jamaica, Korea (South), Liberia, Mexico, Netherlands Antilles, Nicaragua, Panama, Peru, Philippines, Saudi Arabia, Suriname, Taiwan, Trinidad (West Indies), Venezuela	76H4865



**Power cord**

United States of America

**FRU No.**

6952301 (110) 1838574  
(220) 36L8886  
(220V/15A)



---

## Chapter 9. Related service information

**Note:** The service procedures are designed to help you isolate problems. They are written with the assumption that you have model-specific training on all computers, or that are familiar with the computers, functions, terminology, and service information provided in this manual.

---

### Safety information

The following section contains the safety information that you need to be familiar with before servicing an IBM mobile computer.

#### General safety

Follow these rules to ensure general safety:

- Observe good housekeeping in the area of the machines during and after maintenance.
- When lifting any heavy object:
  1. Ensure you can stand safely without slipping.
  2. Distribute the weight of the object equally between your feet.
  3. Use a slow lifting force. Never move suddenly or twist when you attempt to lift.
  4. Lift by standing or by pushing up with your leg muscles; this action removes the strain from the muscles in your back. *Do not attempt to lift any objects that weigh more than 16 kg (35 lb) or objects that you think are too heavy for you.*
- Do not perform any action that causes hazards to the customer, or that makes the equipment unsafe.
- Before you start the machine, ensure that other service representatives and the customer's personnel are not in a hazardous position.
- Place removed covers and other parts in a safe place, away from all personnel, while you are servicing the machine.
- Keep your tool case away from walk areas so that other people will not trip over it.
- Do not wear loose clothing that can be trapped in the moving parts of a machine. Ensure that your sleeves are fastened or rolled up above your elbows. If your hair is long, fasten it.
- Insert the ends of your necktie or scarf inside clothing or fasten it with a nonconductive clip, approximately 8 centimeters (3 inches) from the end.
- Do not wear jewelry, chains, metal-frame eyeglasses, or metal fasteners for your clothing.

**Remember:** Metal objects are good electrical conductors.
- Wear safety glasses when you are: hammering, drilling soldering, cutting wire, attaching springs, using solvents, or working in any other conditions that might be hazardous to your eyes.
- After service, reinstall all safety shields, guards, labels, and ground wires. Replace any safety device that is worn or defective.

- Reinstall all covers correctly before returning the machine to the customer.

## Electrical safety



### CAUTION:

**Electrical current from power, telephone, and communication cables can be hazardous. To avoid personal injury or equipment damage, disconnect the attached power cords, telecommunication systems, networks, and modems before you open the server covers, unless instructed otherwise in the installation and configuration procedures.**

Observe the following rules when working on electrical equipment.

**Important:** Use only approved tools and test equipment. Some hand tools have handles covered with a soft material that does not insulate you when working with live electrical currents.

Many customers have, near their equipment, rubber floor mats that contain small conductive fibers to decrease electrostatic discharges. Do not use this type of mat to protect yourself from electrical shock.

- Find the room emergency power-off (EPO) switch, disconnecting switch, or electrical outlet. If an electrical accident occurs, you can then operate the switch or unplug the power cord quickly.
- Do not work alone under hazardous conditions or near equipment that has hazardous voltages.
- Disconnect all power before:
  - Performing a mechanical inspection
  - Working near power supplies
  - Removing or installing main units
- Before you start to work on the machine, unplug the power cord. If you cannot unplug it, ask the customer to power-off the wall box that supplies power to the machine and to lock the wall box in the off position.
- If you need to work on a machine that has exposed electrical circuits, observe the following precautions:
  - Ensure that another person, familiar with the power-off controls, is near you.  
**Remember:** Another person must be there to switch off the power, if necessary.
  - Use only one hand when working with powered-on electrical equipment; keep the other hand in your pocket or behind your back.  
**Remember:** There must be a complete circuit to cause electrical shock. By observing the above rule, you may prevent a current from passing through your body.
  - When using testers, set the controls correctly and use the approved probe leads and accessories for that tester.
  - Stand on suitable rubber mats (obtained locally, if necessary) to insulate you from grounds such as metal floor strips and machine frames.

Observe the special safety precautions when you work with very high voltages; these instructions are in the safety sections of maintenance information. Use extreme care when measuring high voltages.

- Regularly inspect and maintain your electrical hand tools for safe operational condition.
- Do not use worn or broken tools and testers.
- *Never assume* that power has been disconnected from a circuit. First, *check* that it has been powered-off.
- Always look carefully for possible hazards in your work area. Examples of these hazards are moist floors, nongrounded power extension cables, power surges, and missing safety grounds.
- Do not touch live electrical circuits with the reflective surface of a plastic dental mirror. The surface is conductive; such touching can cause personal injury and machine damage.
- Do not service the following parts with the power on when they are removed from their normal operating places in a machine:
  - Power supply units
  - Pumps
  - Blowers and fans
  - Motor generatorsand similar units. (This practice ensures correct grounding of the units.)
- If an electrical accident occurs:
  - Use caution; do not become a victim yourself.
  - Switch off power.
  - Send another person to get medical aid.

## Safety inspection guide

The intent of this inspection guide is to assist you in identifying potentially unsafe conditions on these products. Each machine, as it was designed and built, had required safety items installed to protect users and service personnel from injury. This guide addresses only those items. However, good judgment should be used to identify potential safety hazards due to attachment of non-IBM features or options not covered by this inspection guide.

If any unsafe conditions are present, you must determine how serious the apparent hazard could be and whether you can continue without first correcting the problem.

Consider these conditions and the safety hazards they present:

- Electrical hazards, especially primary power (primary voltage on the frame can cause serious or fatal electrical shock).
- Explosive hazards, such as a damaged CRT face or bulging capacitor
- Mechanical hazards, such as loose or missing hardware

The guide consists of a series of steps presented in a checklist. Begin the checks with the power off, and the power cord disconnected.

Checklist:

1. Check exterior covers for damage (loose, broken, or sharp edges).
2. Power-off the computer. Disconnect the power cord.

3. Check the power cord for:
  - a. A third-wire ground connector in good condition. Use a meter to measure third-wire ground continuity for 0.1 ohm or less between the external ground pin and frame ground.
  - b. The power cord should be the appropriate type as specified in the parts listings.
  - c. Insulation must not be frayed or worn.
4. Remove the cover.
5. Check for any obvious non-IBM alterations. Use good judgment as to the safety of any non-IBM alterations.
6. Check inside the unit for any obvious unsafe conditions, such as metal filings, contamination, water or other liquids, or signs of fire or smoke damage.
7. Check for worn, frayed, or pinched cables.
8. Check that the power-supply cover fasteners (screws or rivets) have not been removed or tampered with.

## Handling electrostatic discharge-sensitive devices

Any computer part containing transistors or integrated circuits (ICs) should be considered sensitive to electrostatic discharge (ESD). ESD damage can occur when there is a difference in charge between objects. Protect against ESD damage by equalizing the charge so that the machine, the part, the work mat, and the person handling the part are all at the same charge.

### Notes:

1. Use product-specific ESD procedures when they exceed the requirements noted here.
2. Make sure that the ESD protective devices you use have been certified (ISO 9000) as fully effective.

When handling ESD-sensitive parts:

- Keep the parts in protective packages until they are inserted into the product.
- Avoid contact with other people.
- Wear a grounded wrist strap against your skin to eliminate static on your body.
- Prevent the part from touching your clothing. Most clothing is insulative and retains a charge even when you are wearing a wrist strap.
- Use the black side of a grounded work mat to provide a static-free work surface. The mat is especially useful when handling ESD-sensitive devices.
- Select a grounding system, such as those listed below, to provide protection that meets the specific service requirement.

**Note:** The use of a grounding system is desirable but not required to protect against ESD damage.

- Attach the ESD ground clip to any frame ground, ground braid, or green-wire ground.
- Use an ESD common ground or reference point when working on a double-insulated or battery-operated system. You can use coax or connector-outside shells on these systems.
- Use the round ground-prong of the ac plug on ac-operated computers.

## Grounding requirements

Electrical grounding of the computer is required for operator safety and correct system function. Proper grounding of the electrical outlet can be verified by a certified electrician.

## Safety notices (multi-lingual translations)

The caution and danger safety notices in this section are provided in the following languages:

- English
- Brazilian/Portuguese
- Chinese
- French
- German
- Italian
- Korean
- Spanish

**Important:** All caution and danger statements in the *Server Library* begin with a number. This number is used to cross reference an English caution or danger statement with translated versions of the caution or danger statement in this section.

For example, if a caution statement begins with a number 1, translations for that caution statement appear in this section under statement 1.

Be sure to read all caution and danger statements before performing any of the instructions.

- Statement 1



### DANGER

Electrical current from power, telephone and communication cables is hazardous.

#### To avoid a shock hazard:

- **Do not connect or disconnect any cables or perform installation, maintenance, or reconfiguration of this product during an electrical storm.**
- **Connect all power cords to a properly wired and grounded electrical outlet.**
- **Connect to properly wired outlets any equipment that will be attached to this product.**
- **When possible, use one hand only to connect or disconnect signal cables.**
- **Never turn on any equipment when there is evidence of fire, water, or structural damage.**
- **Disconnect the attached power cords, telecommunications systems, networks, and modems before you open the device covers, unless instructed otherwise in the installation and configuration procedures.**

- **Connect and disconnect cables as described in the following table when installing, moving, or opening covers on this product or attached devices.**

To Connect	To Disconnect
1. Turn everything OFF.	1. Turn everything OFF.
2. First, attach all cables to devices.	2. First, remove power cords from outlet.
3. Attach signal cables to connectors.	3. Remove signal cables from connectors.
4. Attach power cords to outlet.	4. Remove all cables from devices.
5. Turn device ON.	

- Statement 2



**CAUTION:**

When replacing the lithium battery, use only IBM Part Number 33F8354 or an equivalent type battery recommended by the manufacturer. If your system has a module containing a lithium battery, replace it only with the same module type made by the same manufacturer. The battery contains lithium and can explode if not properly used, handled, or disposed of.

***Do not:***

- **Throw or immerse into water**
- **Heat to more than 100°C (212°F)**
- **Repair or disassemble**

**Dispose of the battery as required by local ordinances or regulations.**

- Statement 3



**CAUTION:**

When laser products (such as CD-ROMs, DVD-ROM drives, fiber optic devices, or transmitters) are installed, note the following:

- **Do not remove the covers. Removing the covers of the laser product could result in exposure to hazardous laser radiation. There are no serviceable parts inside the device.**
- **Use of controls or adjustments or performance of procedures other than those specified herein might result in hazardous radiation exposure.**





**DANGER**

Some laser products contain an embedded Class 3A or Class 3B laser diode. Note the following:

Laser radiation when open. Do not stare into the beam, do not view directly with optical instruments, and avoid direct exposure to the beam.

- Statement 4

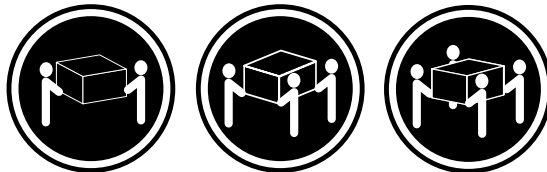

≥18 kg (37 lbs)    ≥32 kg (70.5 lbs)    ≥55 kg (121.2 lbs)

**CAUTION:**  
Use safe practices when lifting.

- Statement 5



**CAUTION:**  
The power control button on the device and the power switch on the power supply do not turn off the electrical current supplied to the device. The device also might have more than one power cord. To remove all electrical current from the device, ensure that all power cords are disconnected from the power source.

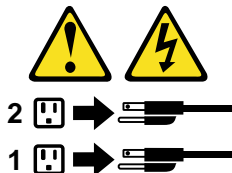

- Statement 10



**CAUTION:**

**Do not place any object weighing more than 82 kg (180 lbs.) on top of rack-mounted devices.**



**Importante:**

Todas as instruções de cuidado e perigo da *Server Library* começam com um número. Este número é utilizado para fazer referência cruzada de uma instrução de cuidado ou perigo no idioma inglês com as versões traduzidas das instruções de cuidado ou perigo encontradas nesta seção.

Por exemplo, se uma instrução de cuidado é iniciada com o número 1, as traduções para aquela instrução de cuidado aparecem nesta seção sob a instrução 1.

Certifique-se de ler todas as instruções de cuidado e perigo antes de executar qualquer operação.

**Instrução 1****PERIGO**

A corrente elétrica proveniente de cabos de alimentação, de telefone e de comunicações é perigosa.

Para evitar risco de choque:

- Não conecte ou desconecte cabos e não realize instalação, manutenção ou reconfiguração deste produto durante uma tempestade com raios.
- Conecte todos os cabos de alimentação a tomadas elétricas corretamente instaladas e aterradas.
- Conecte todos os equipamentos ao qual esse produto será conectado a tomadas corretamente instaladas.
- Sempre que possível, utilize apenas uma das mãos para conectar ou desconectar cabos de sinal.
- Nunca ligue qualquer equipamento quando existir evidência de danos por fogo, água ou na estrutura.
- Desconecte cabos de alimentação, sistemas de telecomunicação, redes e modems antes de abrir as tampas dos dispositivos, a menos que especificado de maneira diferente nos procedimentos de instalação e configuração.
- Conecte e desconecte cabos conforme descrito na seguinte tabela, ao instalar ou movimentar este produto ou os dispositivos conectados, ou ao abrir suas tampas.

Para Conectar:	Para Desconectar:
1. DESLIGUE Tudo.	1. DESLIGUE Tudo.
2. Primeiramente, conecte todos os cabos aos dispositivos.	2. Primeiramente, remova os cabos de alimentação das tomadas.
3. Conecte os cabos de sinal aos conectores.	3. Remova os cabos de sinal dos conectores.
4. Conecte os cabos de alimentação às tomadas.	4. Remova todos os cabos dos dispositivos.
5. LIGUE os dispositivos.	

### Instrução 2



#### **CUIDADO:**

Ao substituir a bateria de lítio, utilize apenas uma bateria IBM, Número de Peça 33F8354 ou uma bateria de tipo equivalente, recomendada pelo fabricante. Se o seu sistema possui um módulo com uma bateria de lítio, substitua-o apenas pelo mesmo tipo de módulo, do mesmo fabricante. A bateria contém lítio e pode explodir se não for utilizada, manuseada e descartada de maneira correta.

Não:

- Jogue ou coloque na água
- Aqueça a mais de 100°C (212°F)
- Conserte nem desmonte

Para descartar a bateria, entre em contato com a área de atendimento a clientes IBM, pelo telefone (011) 889-8986, para obter informações sobre como enviar a bateria pelo correio para a IBM.

### Instrução 3



#### **PRECAUCIÓN:**

Quando produtos a laser (unidades de CD-ROM, unidades de DVD, dispositivos de fibra ótica, transmissores, etc.) estiverem instalados, observe o seguinte:

- Não remova as tampas. A remoção das tampas de um produto a laser pode resultar em exposição prejudicial à radiação de laser. Nenhuma peça localizada no interior do dispositivo pode ser consertada.
- A utilização de controles ou ajustes ou a execução de procedimentos diferentes dos especificados aqui pode resultar em exposição prejudicial à radiação.



### PERIGO

Alguns produtos a laser contêm um diodo laser da Classe 3A ou Classe 3B embutido. Observe o seguinte:

Radiação de laser quando aberto. Não olhe diretamente para o raio a olho nu ou com instrumentos óticos, e evite exposição direta ao raio.

Instrução 4

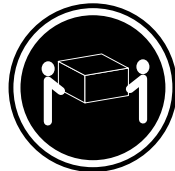

≥18 kg (37 lbs)



≥32 kg (70,5 lbs)

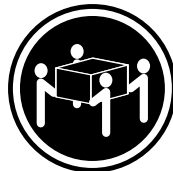

≥55 kg (121,2 lbs)

### CUIDADO:

Ao levantar a máquina, faça-o com segurança.

Instrução 5



### CUIDADO:

Os botões Liga/Desliga localizados no dispositivo e na fonte de alimentação não desligam a corrente elétrica fornecida ao dispositivo. O dispositivo também pode ter mais de um cabo de alimentação. Para remover toda a corrente elétrica do dispositivo, assegure que todos os cabos de alimentação estejam desconectados da fonte de energia elétrica.

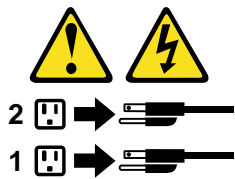

**CUIDADO:**

Instrução 10



**CUIDADO:**



Não coloque nenhum objeto com peso superior a 82 kg (180 lbs.) sobre dispositivos montados em rack.

**重要:**

Netfinity Server Library 中的所有提醒和危险条款前都有一个数字标识。该数字是用来交叉引用一个英文的提醒和危险条款及本部分中的与之对应的已翻译成其它文字的提醒和危险条款。

例如，如果一个提醒条款前的数字为 1，则本部分中相应的译文也带有标号 1。

在执行任何指示的操作之前，请确保您已经阅读了全部提醒和危险条款。

**声明 1**



**危险**

电源、电话和通信电缆中带有危险电流。

为避免电击：

雷电期间不要拆接电缆或安装、维修及重新配置本产品。

将所有电源线连接至正确布线并已安全接地的电源插座上。

将与本产品连接的所有设备连接至正确布线的插座上。

尽量只使用单手拆接信号电缆。

有水、火及结构损坏迹象时，请勿打开任何设备。

除非在安装配置过程中有明确指示，否则，打开设备机盖前应先断开与电源线、远程通信系统、网络和调制解调器的所有连接。

安装、移动或打开本产品及其附带设备的机盖时，应按下表所述连接和断开电缆。

**连接时:**

1. 关闭所有设备。
2. 首先将所有电缆连接至设备。
3. 将信号电缆连接至接口。
4. 将电源线连接至插座。

**断开连接时:**

1. 关闭所有设备。
2. 首先从插座中拔出电源线。
3. 从接口上拔下信号电缆。

### 声明 2



#### 警告:

更换锂电池时，只能使用 IBM 产品号 33F8354 或者是厂商推荐的等同类型的电池。

如果系统模块中含有锂电池，则只能使用同一厂商制造的同一类型的模块进行更换。电池中含有锂，如果使用、拿放或处理不当，可能会发生爆炸。

请勿对电池进行下列操作：  
扔入或浸入水电。  
加热超过 100 (212 F)  
进行修理或分解  
请按本地法规要求处理电池。

### 声明 3



#### 警告:

安装激光产品（如 CD-ROM、DVD 驱动器、光纤设备或送话器）时，应注意以下事项：

不要拆除外盖。拆除激光产品的外盖可能会导致激光辐射的危险，本设备中没有用户可维修的部件。

非此处指定的其它控制、调整或与性能有关的操作都有可能致激光辐射的危险。



#### 危险

某些激光产品中包含内嵌的 3A 级或 3B 级激光二极管。请注意以下事项。  
打开时会产生激光辐射。不要直视光束，不要使用光学仪器直接观看光束，避免直接暴露于光束之下。



声明 4



≥18 kg (37 磅)



≥32 kg (70.5 磅)



≥55 kg (121.2 磅)

警告：  
抬起时请采用安全操作方法。

声明 5



警告：

使用设备上的电源控制按钮和电源上的开关都不能断开本设备上的电流。  
另外，本设备可能带有多条电源线。如要断开设备上的所有电流，请确  
保所有电源线均已与电源断开连接。

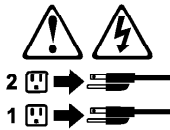

声明 6



警告：

如果在电源线连接设备的一端安装了固定松紧夹，则必须将电源线的另一端连接至  
使用方便的电源。

声明 7



警告:

如果设备带有外门，则在移动或抬起设备前应将其拆除或固定以避免造成人员伤害。外门支撑不了设备的重量。

声明 8



警告:

不要拆除电源外盖或贴有下列标签的任何部件。



贴有此标签的组件内部存在高电压、高电流的危险。这些组件中没有用户可维修的部件。如果怀疑其中的部件存在问题，应与服务技术人员联系。

声明 9



警告:

为避免人员伤害，拆除设备上的风扇前应按下热插拔风扇电缆。

声明 10



警告:

机柜安装的设备上面不能放置重于 82kg (180 磅) 的物品。



> 82 kg (180 磅)

声明 11



警告:

下面的标签表明附近有锋利的边、角或接头。



声明 12



警告:

下面的标签表明附近有高热表面。



重要資訊：

*Nefinity Server Library* 中所有「注意」及「危險」的聲明均以數字開始。此一數字是用來作為交互參考之用，英文「注意」或「危險」聲明可在本節中找到相同內容的「注意」或「危險」聲明的譯文。

例如，有一「危險」聲明以數字 1 開始，則該「危險」聲明的譯文將出現在本節的「聲明」1 中。

執行任何指示之前，請詳讀所有「注意」及「危險」的聲明。

聲明 1



危險

電源、電話及通信電纜上所產生的電流均有危險性。

欲避免電擊危險：

- 在雷雨期間，請勿連接或切斷本產品上的任何電纜線，或安裝、維修及重新架構本產品。
- 請將電源線接至接線及接地正確的電源插座。
- 請將本產品隨附的設備連接至接線正確的插座。
- 儘可能使用單手來連接或切斷信號電纜線。
- 當設備有火燒或泡水的痕跡，或有結構性損害時，請勿開啓該設備的電源。
- 在安裝及架構之時，若非非常熟悉，在開啓裝置蓋子之前，請切斷電源線、電信系統、網路及數據機。
- 在安裝、移動本產品或附加裝置，或開啓其蓋子時，請依照下表中「連接」及「切斷」電纜線的步驟執行。

連接：

1. 關閉所有開關。
2. 先將所有電纜線接上裝置。
3. 將信號電纜接上接頭。
4. 再將電源線接上電源插座。
5. 開啓裝置的電源。

切斷：

1. 關閉所有開關。
2. 先自電源插座拔掉電源線。
3. 拔掉接頭上的所有信號電纜。
4. 再拔掉裝置上的所有電纜線。

聲明 2



注意：

更換鋰電池時，只可使用 IBM 零件編號 33F8354 的電池，或製造商建議之相當類型的電池。若系統中具有包含鋰電池的模組，在更換此模組時，請使用相同廠商製造的相同模組類型。如未正確使用、處理或丟棄含有鋰的電池時，可能會引發爆炸。

請勿將電池：

- 丟入或浸入水中
- 加熱超過 100 °C (212 °F)
- 修理或拆開

請遵照當地法令規章處理廢棄電池。

### 聲明 3



注意：

安裝雷射產品(如 CD-ROM、DVD 光碟機、光纖裝置或發射器)時，請注意下列事項：

- 請勿移開蓋子。移開雷射產品的蓋子，您可能會暴露於危險的雷射輻射之下。裝置中沒有需要維修的組件。
- 不依此處所指示的控制、調整或處理步驟，您可能會暴露於危險的輻射之下。



危險

有些雷射產品含有內嵌式 Class 3A 或 Class 3B 雷射二極體。請注意下列事項：

開啓時會產生雷射輻射。請勿凝視光束，不要使用光學儀器直接觀察，且應避免直接暴露在光束下。

### 聲明 4



≥ 18 公斤 (37 磅)    ≥ 32 公斤 (70.5 磅)    ≥ 55 公斤 (121.2 磅)

注意：

抬起裝置時，請注意安全措施。

### 聲明 5



注意：

裝置上的電源控制按鈕及電源供應器上的電源開關均無法關閉裝置上的電流。本裝置可能有一條以上的電源線。如要移除裝置上的所有電流，請確認所有電源線已與電源分離。

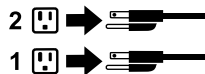

聲明 10



注意：

請勿將任何重量超過 82 公斤 (180 磅) 的物品置於已安裝機架的裝置上方。



> 82 公斤 (180 磅)

### **Important:**

Toutes les consignes Attention et Danger indiquées dans la bibliothèque *Server* sont précédées d'un numéro. Ce dernier permet de mettre en correspondance la consigne en anglais avec ses versions traduites dans la présente section.

Par exemple, si une consigne de type Attention est précédée du chiffre 1, ses traductions sont également précédées du chiffre 1 dans la présente section.

Prenez connaissance de toutes les consignes de type Attention et Danger avant de procéder aux opérations décrites par les instructions.

Notice n° 1



### **DANGER**

Le courant électrique passant dans les câbles de communication, ou les cordons téléphoniques et d'alimentation peut être dangereux.

Pour éviter tout risque de choc électrique:

- Ne manipulez aucun câble et n'effectuez aucune opération d'installation, d'entretien ou de reconfiguration de ce produit au cours d'un orage.
- Branchez tous les cordons d'alimentation sur un socle de prise de courant correctement câblé et mis à la terre.
- Branchez sur des socles de prise de courant correctement câblés tout équipement connecté à ce produit.
- Lorsque cela est possible, n'utilisez qu'une seule main pour connecter ou déconnecter les câbles d'interface.
- Ne mettez jamais un équipement sous tension en cas d'incendie ou d'inondation, ou en présence de dommages matériels.
- Avant de retirer les carters de l'unité, mettez celle-ci hors tension et déconnectez ses cordons d'alimentation, ainsi que les câbles qui la relient aux réseaux, aux systèmes de télécommunication et aux modems (sauf instruction contraire mentionnée dans les procédures d'installation et de configuration).
- Lorsque vous installez ou que vous déplacez le présent produit ou des périphériques qui lui sont raccordés, reportez-vous aux instructions ci-dessous pour connecter et déconnecter les différents cordons.

Connexion	Déconnexion
1. Mettez les unités hors tension.	1. Mettez les unités hors tension.
2. Commencez par brancher tous les cordons sur les unités.	2. Débranchez les cordons d'alimentation des prises.
3. Branchez les câbles d'interface sur des connecteurs.	3. Débranchez les câbles d'interface des connecteurs.
4. Branchez les cordons d'alimentation sur des prises.	4. Débranchez tous les câbles des unités.
5. Mettez les unités sous tension.	



Notice n° 2

**ATTENTION:**

**Remplacez la pile au lithium usagée par une pile de référence identique exclusivement - voir la référence IBM - ou par une pile équivalente recommandée par le fabricant. Si votre système est doté d'un module contenant une pile au lithium, vous devez le remplacer uniquement par un module identique, produit par le même fabricant. La pile contient du lithium et présente donc un risque d'explosion en cas de mauvaise manipulation ou utilisation.**

- Ne la jetez pas à l'eau.
- Ne l'exposez pas à une température supérieure à 100 °C.
- Ne cherchez pas à la réparer ou à la démonter.

**Pour la mise au rebut, reportez-vous à la réglementation en vigueur.**



Notice n° 3

**ATTENTION:**

**Si des produits laser sont installés (tels que des unités de CD-ROM ou de DVD, des périphériques contenant des fibres optiques ou des émetteurs-récepteurs), prenez connaissance des informations suivantes:**

- **N'ouvrez pas ces produits pour éviter une exposition directe au rayon laser. Vous ne pouvez effectuer aucune opération de maintenance à l'intérieur.**



- Pour éviter tout risque d'exposition au rayon laser, respectez les consignes de réglage et d'utilisation des commandes, ainsi que les procédures décrites dans le présent document.



#### DANGER

Certains produits laser contiennent une diode laser de classe 3A ou 3B. Prenez connaissance des informations suivantes:

Rayonnement laser lorsque le carter est ouvert. évitez de regarder fixement le faisceau ou de l'observer à l'aide d'instruments optiques. évitez une exposition directe au rayon.

Notice n° 4

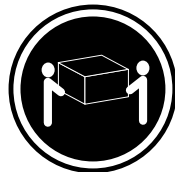

≥18 kg



≥32 kg



≥55 kg

#### ATTENTION:

Faites-vous aider pour soulever ce produit.

Notice n° 5



#### ATTENTION:

Le bouton de mise sous tension/hors tension de l'unité et l'interrupteur d'alimentation du bloc d'alimentation ne coupent pas l'arrivée de courant électrique à l'intérieur de la machine. Il se peut que votre unité dispose de plusieurs cordons d'alimentation. Pour isoler totalement l'unité du réseau électrique, débranchez tous les cordons d'alimentation des socles de prise de courant.

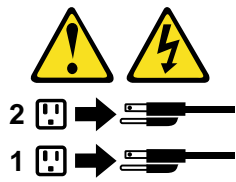

Notice n° 10



**ATTENTION:**

Ne posez pas d'objet dont le poids dépasse 82 kg sur les unités montées en armoire.

### **Wichtig:**

Alle Sicherheitshinweise in dieser *Server-Bibliothek* beginnen mit einer Nummer. Diese Nummer verweist auf einen englischen Sicherheitshinweis mit den übersetzten Versionen dieses Hinweises in diesem Abschnitt.

Wenn z. B. ein Sicherheitshinweis mit der Nummer 1 beginnt, so erscheint die Übersetzung für diesen Sicherheitshinweis in diesem Abschnitt unter dem Hinweis 1.

Lesen Sie alle Sicherheitshinweise, bevor Sie eine Anweisung ausführen.

Hinweis 1



### **VORSICHT**

Elektrische Spannungen von Netz-, Telefon- und Datenübertragungsleitungen sind gefährlich.

Aus Sicherheitsgründen:

- Bei Gewitter an diesem Gerät keine Kabel anschließen oder lösen. Ferner keine Installations-, Wartungs- oder Rekonfigurationsarbeiten durchführen.
- Gerät nur an eine Schutzkontaktsteckdose mit ordnungsgemäß geerdetem Schutzkontakt anschließen.
- Alle angeschlossenen Geräte ebenfalls an Schutzkontaktsteckdosen mit ordnungsgemäß geerdetem Schutzkontakt anschließen.
- Signalkabel möglichst einhändig anschließen oder lösen.
- Keine Geräte einschalten, wenn die Gefahr einer Beschädigung durch Feuer, Wasser oder andere Einflüsse besteht.
- Die Verbindung zu den angeschlossenen Netzkabeln, Telekommunikationssystemen, Netzwerken und Modems ist vor dem Öffnen des Gehäuses zu unterbrechen. Es sei denn, dies ist in den zugehörigen Installations- und Konfigurationsprozeduren anders angegeben.
- Nur nach den nachfolgend aufgeführten Anweisungen arbeiten, die für Installation, Transport oder Öffnen von Gehäusen von Personal Computern oder angeschlossenen Einheiten gelten.

<b>Kabel anschließen:</b>	<b>Kabel lösen:</b>
1. Alle Geräte ausschalten und Netzstecker ziehen.	1. Alle Geräte ausschalten.
2. Zuerst alle Kabel an Einheiten anschließen.	2. Zuerst Netzstecker von Steckdose lösen.
3. Signalkabel an Anschlußbuchsen anschließen.	3. Signalkabel von Anschlußbuchsen lösen.
4. Netzstecker an Steckdose anschließen.	4. Alle Kabel von Einheiten lösen.
5. Gerät einschalten.	

#### Hinweis 2



#### **ACHTUNG:**

Eine verbrauchte Batterie nur durch eine Batterie mit der IBM Teilenummer 33F8354 oder durch eine vom Hersteller empfohlene Batterie ersetzen. Wenn Ihr System ein Modul mit einer Lithium-Batterie enthält, ersetzen Sie es immer mit dem selben Modultyp vom selben Hersteller. Die Batterie enthält Lithium und kann bei unsachgemäßer Verwendung, Handhabung oder Entsorgung explodieren.

Die Batterie nicht:

- mit Wasser in Berührung bringen.
- über 100 C erhitzen.
- reparieren oder zerlegen.

Die örtlichen Bestimmungen für die Entsorgung von Sondermüll beachten.

#### Hinweis 3



#### **ACHTUNG:**

Wenn ein Laserprodukt (z. B. CD-ROM-Laufwerke, DVD-Laufwerke, Einheiten mit Glasfaserkabeln oder Transmitter) installiert ist, beachten Sie folgendes.

- Das Entfernen der Abdeckungen des CD-ROM-Laufwerks kann zu gefährlicher Laserstrahlung führen. Es befinden sich keine Teile innerhalb des CD-ROM-Laufwerks, die vom Benutzer gewartet werden müssen. Die Verkleidung des CD-ROM-Laufwerks nicht öffnen.

- Steuer- und Einstellelemente sowie Verfahren nur entsprechend den Anweisungen im vorliegenden Handbuch einsetzen. Andernfalls kann gefährliche Laserstrahlung auftreten.



### VORSICHT

Manche CD-ROM-Laufwerke enthalten eine eingebaute Laserdiode der Klasse 3A oder 3B. Die nachfolgend aufgeführten Punkte beachten.

Laserstrahlung bei geöffneter Tür. Niemals direkt in den Laserstrahl sehen, nicht direkt mit optischen Instrumenten betrachten und den Strahlungsbereich meiden.

Hinweis 4

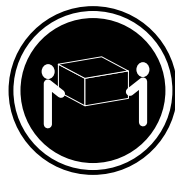

≥18 kg



≥32 kg



≥55 kg

### ACHTUNG:

Beim Anheben der Maschine die vorgeschriebenen Sicherheitsbestimmungen beachten.

Hinweis 5



### ACHTUNG:

Mit dem Betriebsspannungsschalter an der Vorderseite des Servers und dem Betriebsspannungsschalter am Netzteil wird die Stromversorgung für den Server nicht unterbrochen. Der Server könnte auch mehr als ein Netzkabel aufweisen. Um die gesamte Stromversorgung des Servers auszuschalten, muß sichergestellt werden, daß alle Netzkabel aus den Netzsteckdosen herausgezogen wurden.

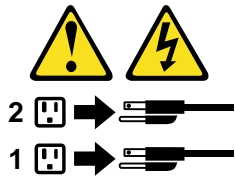

Hinweis 10



**ACHTUNG:**



Keine Gegenstände, die mehr als 82 kg wiegen, auf Rack-Einheiten ablegen.

### **Importante:**

Tutti gli avvisi di attenzione e di pericolo riportati nella pubblicazione *Server Library* iniziano con un numero. Questo numero viene utilizzato per confrontare avvisi di attenzione o di pericolo in inglese con le versioni tradotte riportate in questa sezione.

Ad esempio, se un avviso di attenzione inizia con il numero 1, la relativa versione tradotta è presente in questa sezione con la stessa numerazione.

Prima di eseguire una qualsiasi istruzione, accertarsi di leggere tutti gli avvisi di attenzione e di pericolo.

Avviso 1



### **PERICOLO**

La corrente elettrica circolante nei cavi di alimentazione, del telefono e di segnale è pericolosa.

Per evitare il pericolo di scosse elettriche:

- Non collegare o scollegare i cavi, non effettuare l'installazione, la manutenzione o la riconfigurazione di questo prodotto durante i temporali.
- Collegare tutti i cavi di alimentazione ad una presa elettrica correttamente cablata e munita di terra di sicurezza.
- Collegare qualsiasi apparecchiatura collegata a questo prodotto ad una presa elettrica correttamente cablata e munita di terra di sicurezza.
- Quando possibile, collegare o scollegare i cavi di segnale con una sola mano.
- Non accendere qualsiasi apparecchiatura in presenza di fuoco, acqua o se sono presenti danni all'apparecchiatura stessa.
- Scollegare i cavi di alimentazione, i sistemi di telecomunicazioni, le reti e i modem prima di aprire i coperchi delle unità, se non diversamente indicato nelle procedure di installazione e configurazione.
- Collegare e scollegare i cavi come descritto nella seguente tabella quando si effettuano l'installazione, la rimozione o l'apertura dei coperchi di questo prodotto o delle unità collegate.

<b>Per collegare:</b>	<b>Per scollegare:</b>
1. SPEGNERE tutti i dispositivi.	1. SPEGNERE tutti i dispositivi.
2. Collegare prima tutti i cavi alle unità.	2. Rimuovere prima i cavi di alimentazione dalle prese elettriche.
3. Collegare i cavi di segnale ai connettori.	3. Rimuovere i cavi di segnale dai connettori.
4. Collegare i cavi di alimentazione alle prese elettriche.	4. Rimuovere tutti i cavi dalle unità.
5. ACCENDERE le unità.	

#### Avviso 2



#### **ATTENZIONE:**

Quando si sostituisce la batteria al litio, utilizzare solo una batteria IBM con numero parte 33F8354 o batterie dello stesso tipo o di tipo equivalente consigliate dal produttore. Se il sistema di cui si dispone è provvisto di un modulo contenente una batteria al litio, sostituire tale batteria solo con un tipo di modulo uguale a quello fornito dal produttore. La batteria contiene litio e può esplodere se utilizzata, maneggiata o smaltita impropriamente.

Evitare di:

- Gettarla o immergerla in acqua
- Riscaldarla ad una temperatura superiore ai 100°C
- Cercare di ripararla o smontarla

Smaltire secondo la normativa in vigore (D.Lgs 22 del 5/2/9) e successive disposizioni nazionali e locali.

#### Avviso 3



#### **ATTENZIONE:**

Quando si installano prodotti laser come, ad esempio, le unità DVD, CD-ROM, a fibre ottiche o trasmettitori, prestare attenzione a quanto segue:



- Non rimuovere i coperchi. L'apertura dei coperchi di prodotti laser può determinare l'esposizione a radiazioni laser pericolose. All'interno delle unità non vi sono parti su cui effettuare l'assistenza tecnica.
- L'utilizzo di controlli, regolazioni o l'esecuzione di procedure non descritti nel presente manuale possono provocare l'esposizione a radiazioni pericolose.



### PERICOLO

Alcuni prodotti laser contengono all'interno un diodo laser di Classe 3A o Classe 3B. Prestare attenzione a quanto segue:

Aperto l'unità vengono emesse radiazioni laser. Non fissare il fascio, non guardarlo direttamente con strumenti ottici ed evitare l'esposizione diretta al fascio.

Avviso 4

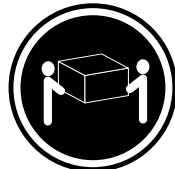

≥18 kg



≥32 kg



≥55 kg

### ATTENZIONE:

Durante il sollevamento della macchina seguire delle norme di sicurezza.

Avviso 5



### ATTENZIONE:

Il pulsante del controllo dell'alimentazione situato sull'unità e l'interruttore di alimentazione posto sull'alimentatore non disattiva la corrente elettrica fornita all'unità. L'unità potrebbe disporre di più di un cavo di alimentazione. Per disattivare la corrente elettrica dall'unità, accertarsi che tutti i cavi di alimentazione siano scollegati dalla sorgente di alimentazione.

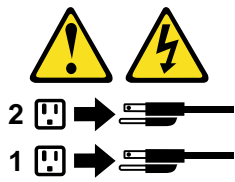

Avviso 10



**ATTENZIONE:**



Non poggiare oggetti che pesano più di 82 kg sulla parte superiore delle unità montate in rack.

경고문 1



위험

전원, 전화 및 통신 케이블로부터 흘러 나오는 전류는 위험합니다.

전기 충격을 피하려면:

- 뇌우를 동반할 때는 케이블의 연결이나 철수, 이 제품의 설치, 유지보수 또는 재구성을 하지 마십시오.
- 모든 전원 코드를 적절히 배선 및 접지해야 합니다.
- 이 제품에 연결될 모든 장비를 적절하게 배선된 콘센트에 연결하십시오.
- 가능한한 신호 케이블을 한 손으로 연결하거나 끊으십시오.
- 화재, 수해 또는 구조상의 손상이 있을 경우 장비를 켜지 마십시오.
- 설치 및 구성 프로시저에 다른 설명이 없는 한, 장치 덮개를 열기 전에 연결된 전원 코드, 원격기 통신 시스템, 네트워크 및 모뎀을 끊어 주십시오.
- 제품 또는 접속된 장치를 설치, 이동 및 덮개를 열 때 다음 설명에 따라 케이블을 연결하거나 끊도록 하십시오.

연결하려면:

1. 모든 스위치를 끕니다.
2. 먼저 모든 케이블을 장치에 연결합니다.
3. 신호 케이블을 커넥터에 연결합니다.
4. 콘센트에 전원 코드를 연결합니다.
5. 장치 스위치를 켭니다.

연결을 끊으려면:

1. 모든 스위치를 끕니다.
2. 먼저 콘센트에서 전원 코드를 뽑습니다.
3. 신호 케이블을 커넥터에서 제거합니다.
4. 장치에서 모든 케이블을 제거합니다.

경고문 2



주의:

리튬 배터리를 교체할 때는 IBM 부품 번호 33F8354 또는 제조업체에서 권장하는 동등한 유형의 배터리를 사용하십시오. 시스템에 리튬 배터리를 갖고 있는 모듈이 있으면 동일한 제조업체에서 생산된 동일한 모듈 유형으로 교체하십시오. 배터리에 리튬이 있을 경우 제대로 사용, 처리 또는 처분하지 않으면 폭발할 수 있습니다.

다음은 주의하십시오.

- 던지거나 물에 담그지 않도록 하십시오.
- 100°C(212°F) 이상으로 가열하지 마십시오.
- 수리하거나 분해하지 마십시오.

지역 법령이나 규정의 요구에 따라 배터리를 처분하십시오.

경고문 3



주의:

레이저 제품(CD-ROMs, DVD 드라이브, 광 장치 또는 트랜스미터 등과 같은)이 설치되어 있을 경우 다음을 유의하십시오.

- 덮개를 제거하지 마십시오. 레이저 제품의 덮개를 제거했을 경우 위험한 레이저 광선에 노출될 수 있습니다. 이 장치 안에는 서비스를 받을 수 있는 부품이 없습니다.

- 여기에서 지정하지 않은 방식의 제어, 조절 또는 실행으로 인해 위험한 레이저 광선에 노출될 수 있습니다.



위험

일부 레이저 제품에는 클래스 3A 또는 클래스 3B 레이저 다이오드가 들어 있습니다. 다음을 주의하십시오.

열면 레이저 광선에 노출됩니다. 광선을 주시하거나 광학 기계를 직접 쳐다보지 않도록 하고 광선에 노출되지 않도록 하십시오.

경고문 4



≥ 18 kg (37 lbs)



≥ 32 kg (70.5 lbs)



≥ 55 kg (121.2 lbs)

주의:

기계를 들 때는 안전하게 들어 올리십시오.

경고문 5



주의:

장치의 전원 제어 버튼 및 전원 공급기의 전원 스위치는 장치에 공급되는 전류를 차단하지 않습니다. 장치에 둘 이상의 전원 코드가 연결되어 있을 수도 있습니다. 장치에서 모든 전류를 차단하려면 모든 전원 코드가 전원으로부터 차단되어 있는지 확인하십시오.



경고문 10



주의:  
서랍형 모델의 장치 상단에 82 kg(180 lbs.)이 넘는 물체를 올려  
놓지 마십시오.



> 82 kg (180 lbs)

**Importante:**

Todas las declaraciones de precaución de esta *Biblioteca del servidor* empiezan con un número. Dicho número se emplea para establecer una referencia cruzada de una declaración de precaución o peligro en inglés con las versiones traducidas que de dichas declaraciones pueden encontrarse en esta sección.

Por ejemplo, si una declaración de peligro empieza con el número 1, las traducciones de esta declaración de precaución aparecen en esta sección bajo Declaración 1.

Lea atentamente todas las declaraciones de precaución y peligro antes de llevar a cabo cualquier operación.

**Declaración 1****PELIGRO**

La corriente eléctrica de los cables telefónicos, de alimentación y de comunicaciones es perjudicial.

Para evitar una descarga eléctrica:

- No conecte ni desconecte ningún cable ni realice las operaciones de instalación, mantenimiento o reconfiguración de este producto durante una tormenta.
- Conecte cada cable de alimentación a una toma de alimentación eléctrica con conexión a tierra y cableado correctos.
- Conecte a tomas de alimentación con un cableado correcto cualquier equipo que vaya a estar conectado a este producto.
- Si es posible, utilice una sola mano cuando conecte o desconecte los cables de señal.
- No encienda nunca un equipo cuando haya riesgos de incendio, de inundación o de daños estructurales.
- Desconecte los cables de alimentación, sistemas de telecomunicaciones, redes y módems conectados antes de abrir las cubiertas del dispositivo a menos que se indique lo contrario en los procedimientos de instalación y configuración.
- Conecte y desconecte los cables tal como se describe en la tabla siguiente cuando desee realizar una operación de instalación, de traslado o de apertura de las cubiertas para este producto o para los dispositivos conectados.

Para la conexin	Para la desconexiín
1. APÁGUELO todo.	1. APÁGUELO todo.
2. En primer lugar, conecte los cables a los dispositivos.	2. En primer lugar, retire cada cable de alimentaciín de la toma de alimentaciín.
3. Conecte los cables de señaal a los conectores.	3. Retire los cables de señaal de los conectores.
4. Conecte cada cable de alimentaciín a la toma de alimentaciín.	4. Retire los cables de los dispositivos.
5. ENCIENDA el dispositivo.	

## Declaración 2



### PRECAUCIÓN:

Cuando desee sustituir la batería de litio, utilice únicamente el número de pieza 33F8354 de IBM o cualquier tipo de batería equivalente que recomiende el fabricante. Si el sistema tiene un módulo que contiene una batería de litio, sustitúyalo únicamente por el mismo tipo de módulo, que ha de estar creado por el mismo fabricante. La batería contiene litio y puede explotar si el usuario no la utiliza ni la maneja de forma adecuada o si no se desprende de la misma como corresponde.

No realice las acciones siguientes:

- Arrojarla al agua o sumergirla
- Calentarla a una temperatura que supere los 100°C (212°F)
- Repararla o desmontarla

Despréndase de la batería siguiendo los requisitos que exija el reglamento o la legislación local.

## Declaración 3



### PRECAUCIÓN:

Cuando instale productos láser (como, por ejemplo, CD-ROM, unidades DVD, dispositivos de fibra óptica o transmisores), tenga en cuenta las advertencias siguientes:

- No retire las cubiertas. Si retira las cubiertas del producto láser, puede quedar expuesto a radiación láser perjudicial. Dentro del dispositivo no existe ninguna pieza que requiera mantenimiento.
- El uso de controles o ajustes o la realización de procedimientos que no sean los que se han especificado aquí pueden dar como resultado una exposición perjudicial a las radiaciones.



### PELIGRO

Algunos productos láser contienen un diodo de láser incorporado de Clase 3A o de Clase 3B. Tenga en cuenta la advertencia siguiente.

Cuando se abre, hay radiación láser. No mire fijamente el rayo ni lleve a cabo ningún examen directamente con instrumentos ópticos; evite la exposición directa al rayo.

Declaración 4



≥18 kg (37 libras)



≥32 kg (70,5 libras)



≥55 kg (121,2 libras)

### PRECAUCIÓN:

Tome medidas de seguridad al levantar el producto.

Declaración 5



### PRECAUCIÓN:

El botón de control de alimentación del dispositivo y el interruptor de alimentación de la fuente de alimentación no apagan la corriente eléctrica suministrada al dispositivo. Es posible también que el dispositivo tenga más de un cable de alimentación. Para eliminar la corriente eléctrica del dispositivo, asegúrese de desconectar todos los cables de alimentación de la fuente de alimentación.



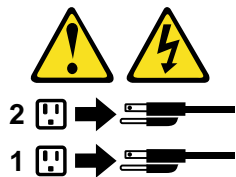

Declaración 10



**PRECAUCIÓN:**



No coloque ningún objeto que pese más de 82 kg (180 libras) encima de los dispositivos montados en bastidor.

---

## Send us your comments!

We want to know your opinion about this manual (part number 06P1796). Your input will help us to improve our publications.

Please photocopy this survey, complete it, and then fax it to **IBM HMM Survey at 919-543-8167 (USA)**.

Name: \_\_\_\_\_

Phone number: \_\_\_\_\_

1. Do you like this manual?

Yes     No

\_\_\_\_\_  
\_\_\_\_\_

2. What would you like to see added, changed, or deleted in this manual?

\_\_\_\_\_  
\_\_\_\_\_

3. What is your service experience level?

Less than five years

More than five years

4. Which servers do you service most?

\_\_\_\_\_  
\_\_\_\_\_  
\_\_\_\_\_  
\_\_\_\_\_

**Thank you for your response!**

---

## Problem determination tips

Due to the variety of hardware and software combinations that can be encountered, use the following information to assist you in problem determination. If possible, have this information available when requesting assistance from Service Support and Engineering functions.

- Machine type and model
- Processor or hard disk upgrades
- Failure symptom
  - Do diagnostics fail?
  - What, when, where, single, or multiple systems?
  - Is the failure repeatable?
  - Has this configuration ever worked?
  - If it has been working, what changes were made prior to it failing?
  - Is this the original reported failure?
- Reference/Diagnostics version
  - Type and version level
- Hardware configuration
  - Print (print screen) configuration currently in use
  - BIOS level
- Operating system software
  - Type and version level

**Note:** To eliminate confusion, identical systems are considered identical only if they:

1. Are the exact machine type and models
2. Have the same BIOS level
3. Have the same adapters/attachments in the same locations
4. Have the same address jumpers/terminators/cabling
5. Have the same software versions and levels
6. Have the same Reference/Diagnostics Diskette (version)
7. Have the same configuration options set in the system
8. Have the same setup for the operation system control files

Comparing the configuration and software set-up between "working and non-working" systems will often lead to problem resolution.

---

## Notices

References in this publication to IBM products, programs, or services do not imply that IBM intends to make these available in all countries in which IBM operates. Any reference to an IBM product, program, or service is not intended to state or imply that only that IBM product, program, or service may be used. Subject to IBM's valid intellectual property or other legally protectable rights, any functionally equivalent product, program, or service may be used instead of the IBM product, program, or

service. The evaluation and verification of operation in conjunction with other products, except those expressly designated by IBM, are the responsibility of the user.

---

## Trademarks

The following items are trademarks of the IBM Corporation in the United States or other countries or both:

HelpCenter	HelpFax
IBM	OS/2
NetBAY3	Netfinity
Netfinity Manager	ThinkPad
SystemXtra	

The following terms are trademarks of other companies:

Notes	Lotus Development Corporation
-------	-------------------------------

MMX and Pentium are trademarks or registered trademarks of Intel Corporation.

UNIX is a trademark or registered trademark of The Open Group in the United States and other countries.

Windows NT is a trademark or registered trademark of Microsoft Corporation.





Part Number: 06P1796  
File Number:



Printed in the United States of America  
on recycled paper containing 10%  
recovered post-consumer fiber.

06P1796



## Free Manuals Download Website

<http://myh66.com>

<http://usermanuals.us>

<http://www.somanuals.com>

<http://www.4manuals.cc>

<http://www.manual-lib.com>

<http://www.404manual.com>

<http://www.luxmanual.com>

<http://aubethermostatmanual.com>

Golf course search by state

<http://golfingnear.com>

Email search by domain

<http://emailbydomain.com>

Auto manuals search

<http://auto.somanuals.com>

TV manuals search

<http://tv.somanuals.com>