

TOSHIBA

TOSHIBA Thermal Printer

B-SA4T SERIES

Option Installation Manual

Document No. **EO15-33001A**

Original **Jul., 2005**
(Revised **Sep., 2005)**

PRINTED IN JAPAN

TOSHIBA TEC CORPORATION

TABLE OF CONTENTS

	Page
1. Cutter Module-----	1- 1
1.1 B-SA204-QM/ B-SA204-QM-R -----	1- 1
1.2 B-SA204P-QM-R-----	1- 4
2. Strip Module-----	2- 1
2.1 B-SA904-H-QM-R-----	2- 1
2.2 B-SA904P-H-QM-R-----	2- 5
3. Wireless LAN Module: B-SA704-WLAN-QM -----	3- 1
4. Serial Interface Board: B-SA704-RS-QM-R -----	4- 1
5. 300 dpi Print Head Kit: B-SA704-TPH3-QM-R -----	5- 1
6. Real Time Clock: B-SA704-RTC-QM-R -----	6- 1
7. Expansion I/O Board: B-SA704-IO-QM-R -----	7- 1
8. RFID Module: B-SA704-RFID-U2-EU-R -----	8- 1

CAUTION!

- 1. *This manual may not be copied in whole or in part without prior written permission of TOSHIBA TEC.*
- 2. *The contents of this manual may be changed without notification.*
- 3. *Please refer to your local Authorised Service representative with regard to any queries you may have in this manual.*

INSTALLATION PROCEDURE FOR OPTIONAL EQUIPMENT

WARNING!

1. Turn the printer power off and disconnect the power cord before installing an optional equipment.
2. Be careful not to pinch your fingers or hands with the covers.
3. Be careful not to injure your fingers when installing the cutter module.

1. Cutter Module

1.1 B-SA204-QM / B-SA204-QM-R

B-SA204-QM/ B-SA204-QM-R is an optional cutter module for the B-SA4TM Series (Metal cover).

CAUTION!
Do not connect/disconnect the cutter harness to/from the printer within one minute from a power off to protect the internal electrical circuit of the printer.

• Packing List

The following parts are supplied with the kit. Make sure you have all items shown below.

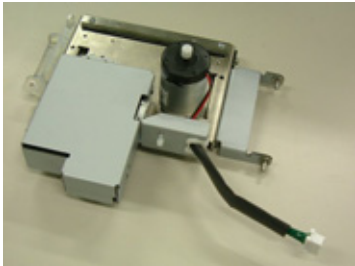
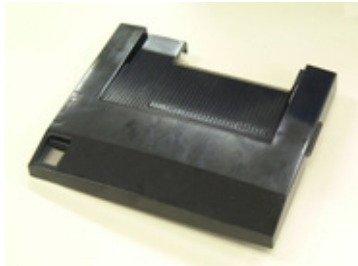
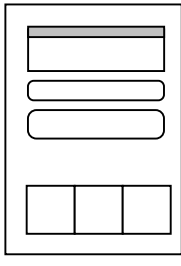
<p>Cutter Unit (1 pc.)</p> 	<p>Cutter Module Cover (1 pc.)</p> 	<p>Installation Manual (1 copy)</p> 
--	--	---

• Installation Procedure

1. Open the Front Cover, and remove the B-3x6 screw to detach the Connector Cover.

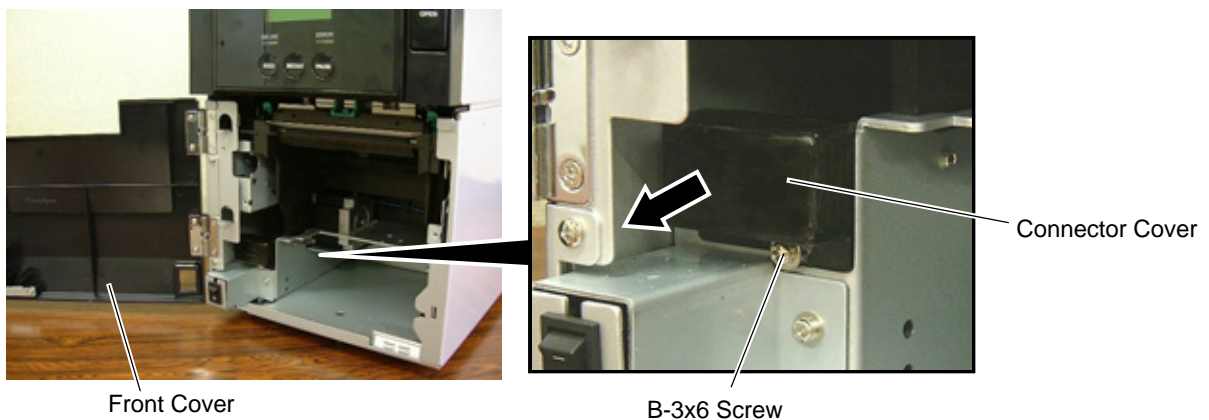

- Open the Front Cover wider. Remove the Front Cover by lifting it to disengage the hinge pins from the hinge. The Front Cover cannot be removed unless it is opened at an angle of over 100 degrees as the stoppers of the hinge prevent disengagement.

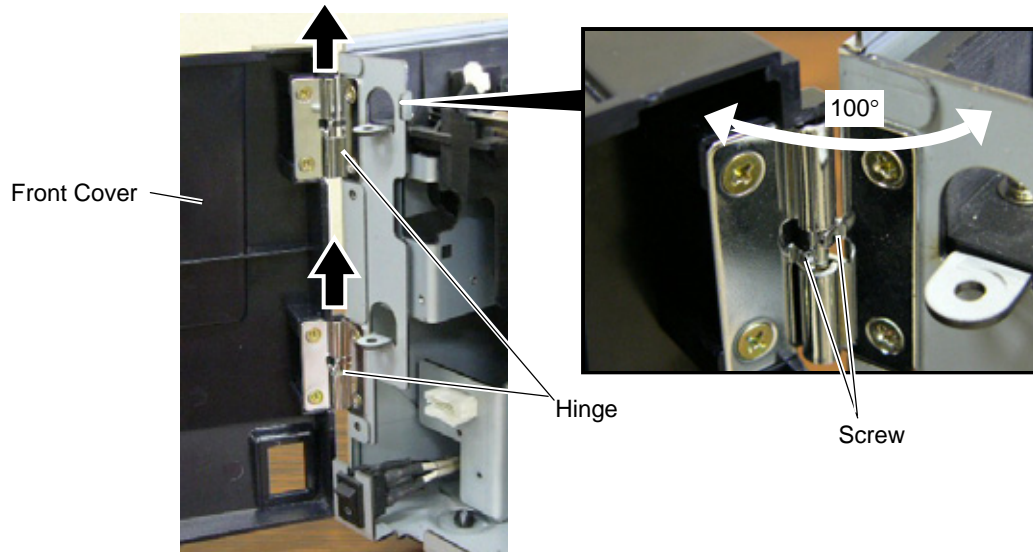

- Mount the Cutter Module Cover by inserting the hinge pins into the hinges.

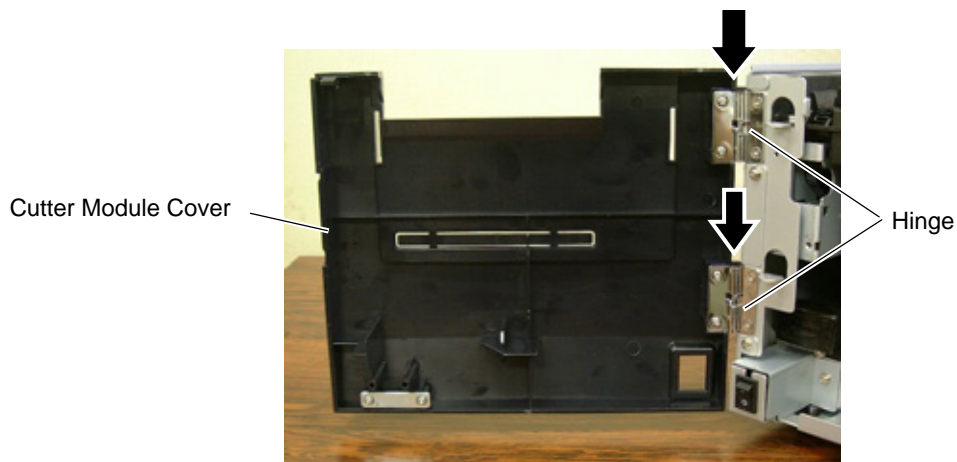

- Fit the Cutter Unit to the front of the printer by inserting the Hinge Pins into the Hinge Pin Holes.

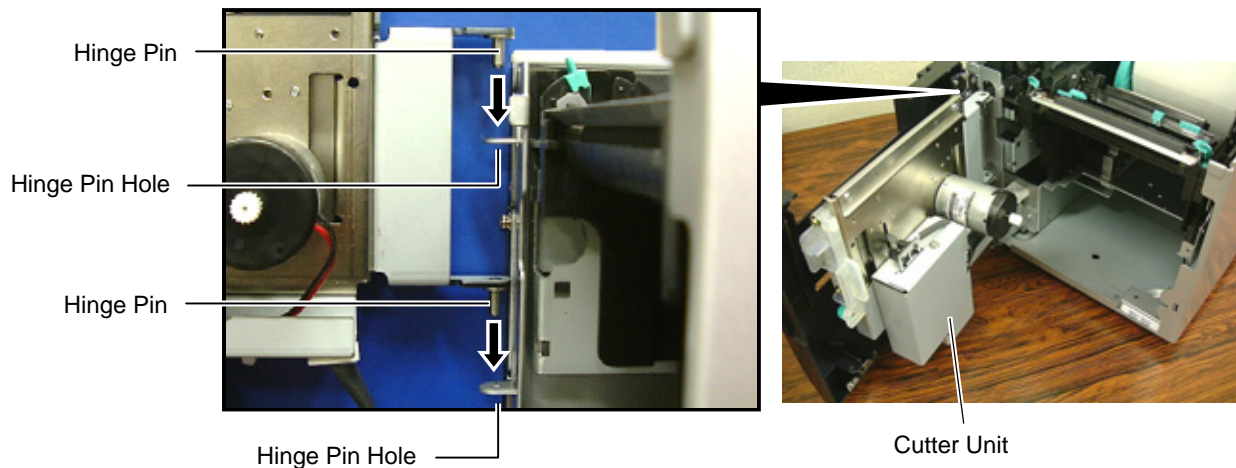

5. Connect the Cutter Harness to the connector at the front of the printer.

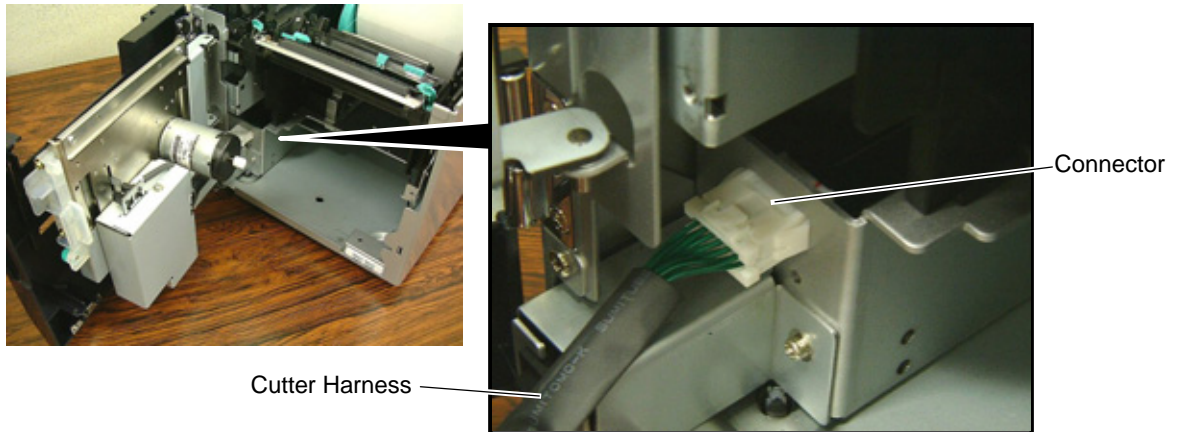

6. Close the Cutter Unit and secure it to the printer with the Set Screw.

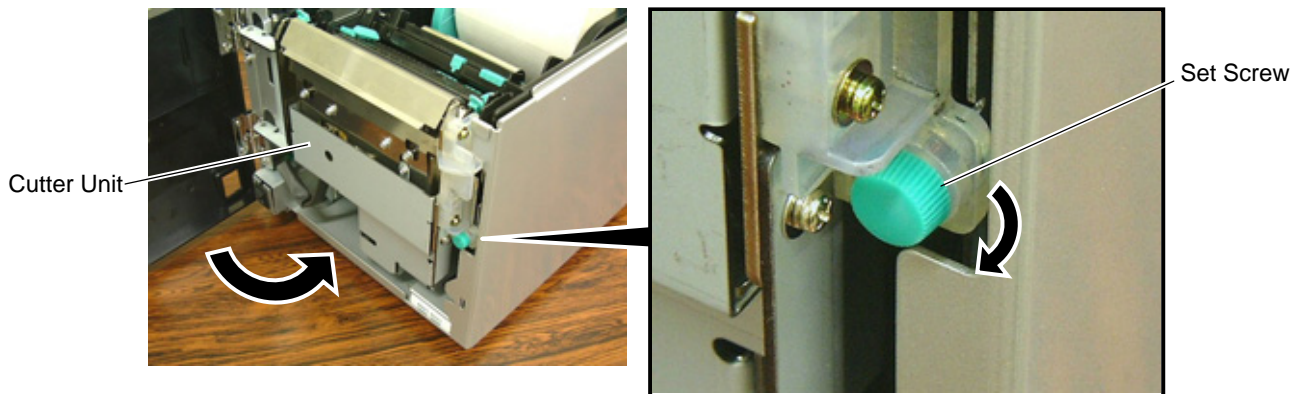

7. Close the Cutter Module Cover.



- Media loading procedure----- Owner's Manual, Section 2.3
- Operation check----- Owner's Manual, Section 2.9
- System mode setting----- System Mode Manual
- Cleaning ----- Owner's Manual, Section 4.1.3



1.2 B-SA204P-QM-R

B-SA204P-QM-R is an optional cutter module for the B-SA4TP Series (Plastic cover).

CAUTION!
 Do not connect/disconnect the cutter harness to/from the printer within one minute from a power off to protect the internal electrical circuit of the printer.

• Packing List

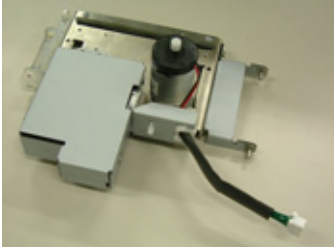
The following parts are supplied with the kit. Make sure you have all items shown below.

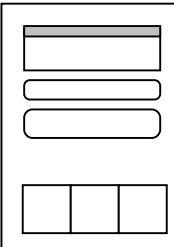
<p>Cutter Unit (1 pc.)</p> 	<p>Cutter Module Cover (1 pc.)</p> 	<p>Installation Manual (1 copy)</p> 
--	--	---

• Installation Procedure

1. Open the Front Cover, and remove the Connector Cover.

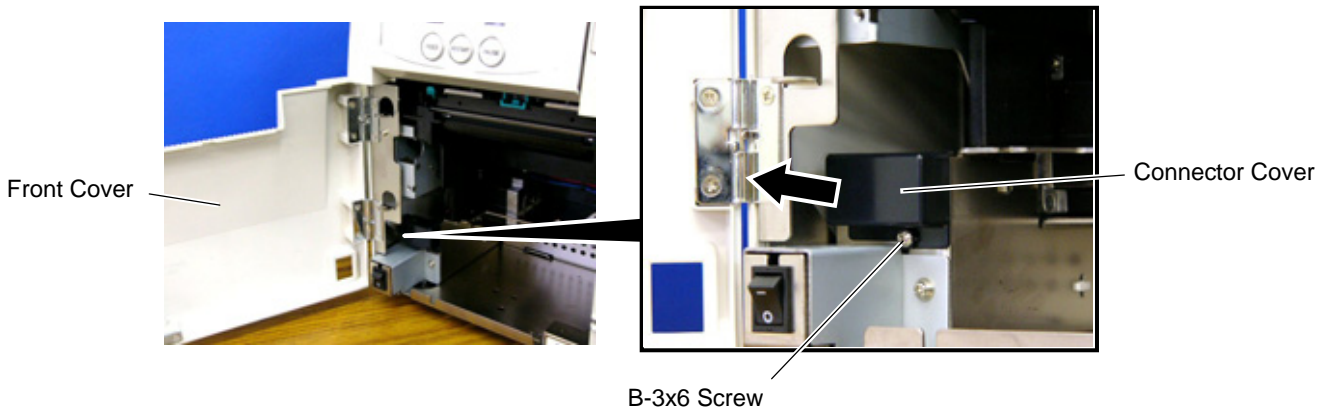

2. Open the Front Cover wider. Remove the Front Cover by lifting it to disengage the hinge pins from the hinge. The Front Cover cannot be removed unless it is opened at an angle of over 100 degrees as the stoppers of the hinge prevent disengagement.

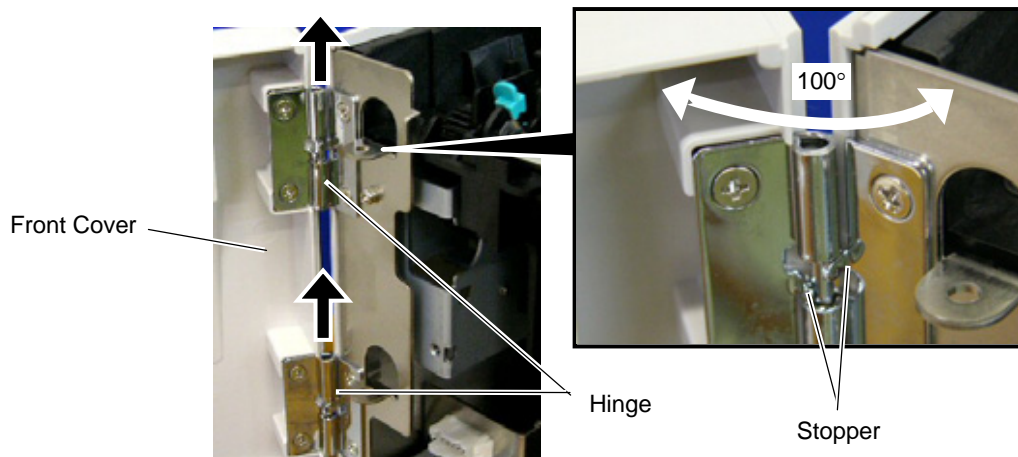

3. Mount the Cutter Module Cover by inserting the hinge pins into the hinges.

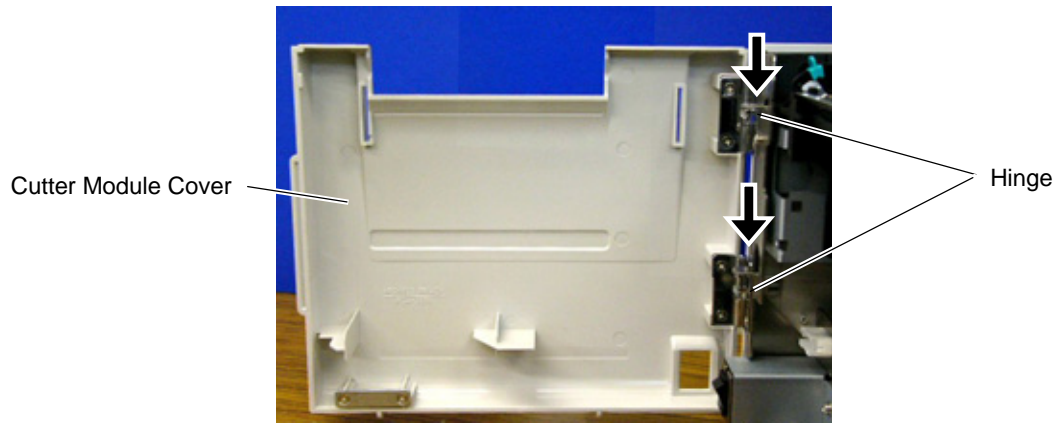

4. Fit the Cutter Unit to the front of the printer by inserting the Hinge Pins into the Hinge Pin Holes.

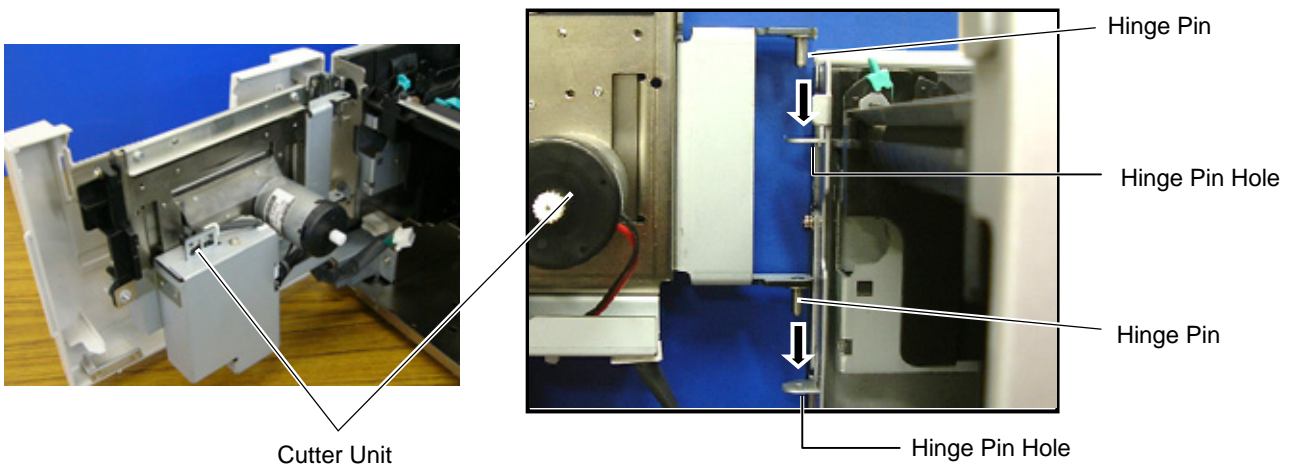

5. Close the Cutter Unit and secure it to the printer with the Set Screw.

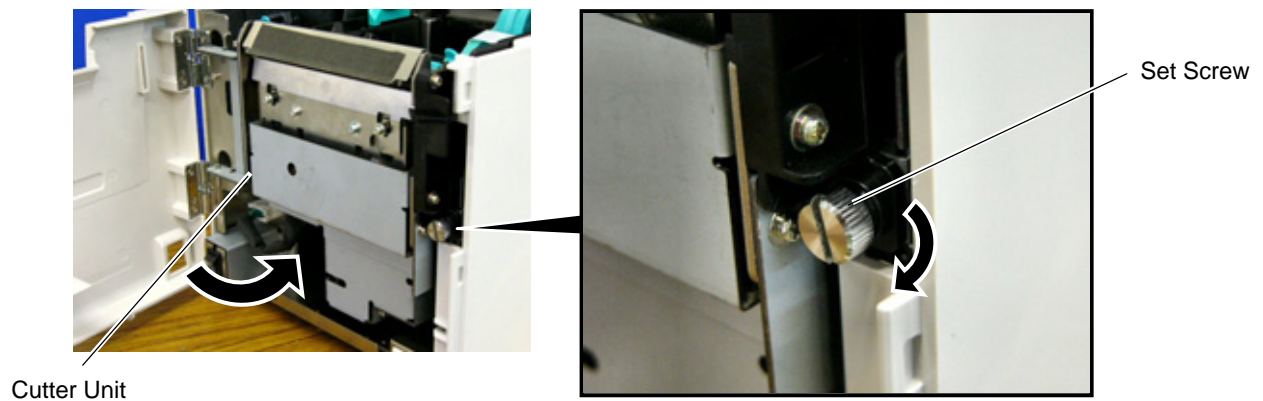

6. Secure the ground wire of the cutter unit to the printer with the B-3x6 screw removed in Step 1, as shown in the picture.
7. Connect the cutter harness to the connector at the front of the printer.

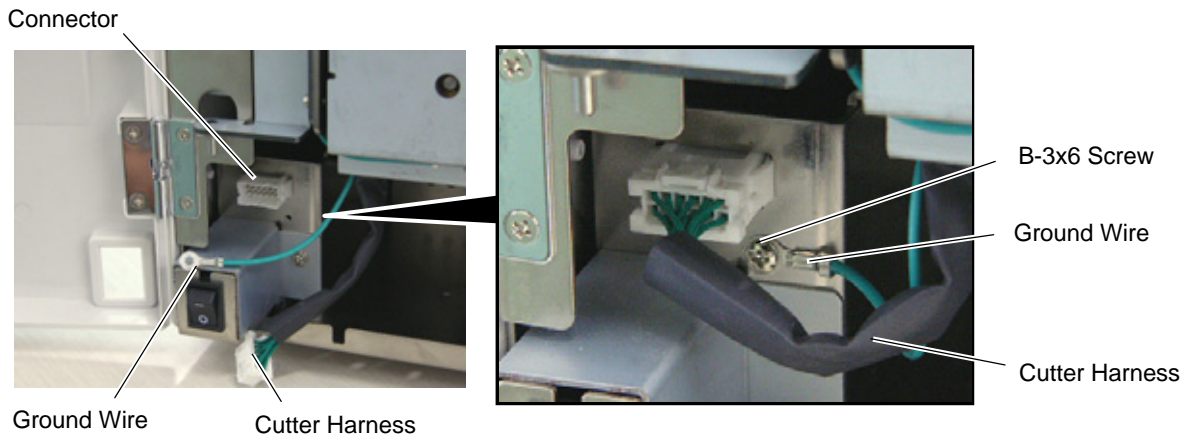

8. Close the Cutter Module Cover. After that, perform an operation check for a proper cut issue.



- Media loading procedure----- Owner's Manual, Section 2.3
- Operation check----- Owner's Manual, Section 2.9
- System mode setting----- System Mode Manual
- Cleaning ----- Owner's Manual, Section 4.1.3

2. Strip Module





NOTE: Make sure that the firmware version is V1.1 or greater. Firmware V1.0 does not support the strip module.

2.1 B-SA904-H-QM-R

B-SA904-H-QM-R is an optional strip module for the B-SA4TM Series (Metal cover).

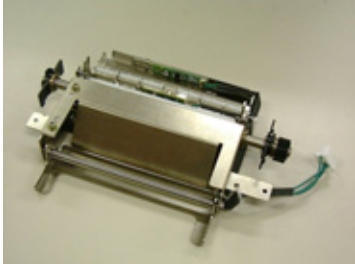
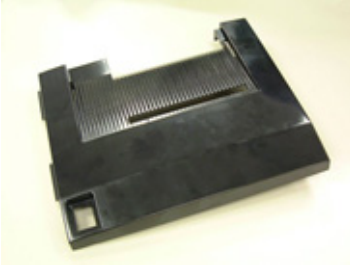
• Packing List

The following parts are supplied with the kit. Make sure you have all items shown below.

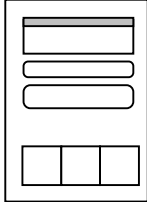
<p>Strip Unit (1 pc.)</p> 	<p>Strip Module Cover (1 pc.)</p> 	<p>SMW-3x6 Screw (4 pc.)</p> 
<p>Cutter (1 pc.)</p> 	<p>Guide Roller (1 pc.)</p> 	<p>Installation Manual (1 copy)</p> 

NOTE: When issuing labels in batch mode even though the strip module is fitted, please use the provided cutter to tear off the issued labels. Do not attach the cutter when labels are stripped one by one.

• Installation Procedure

1. Open the Top Cover and the Front Cover. Remove the B-3x6 screw to detach the Connector Cover.

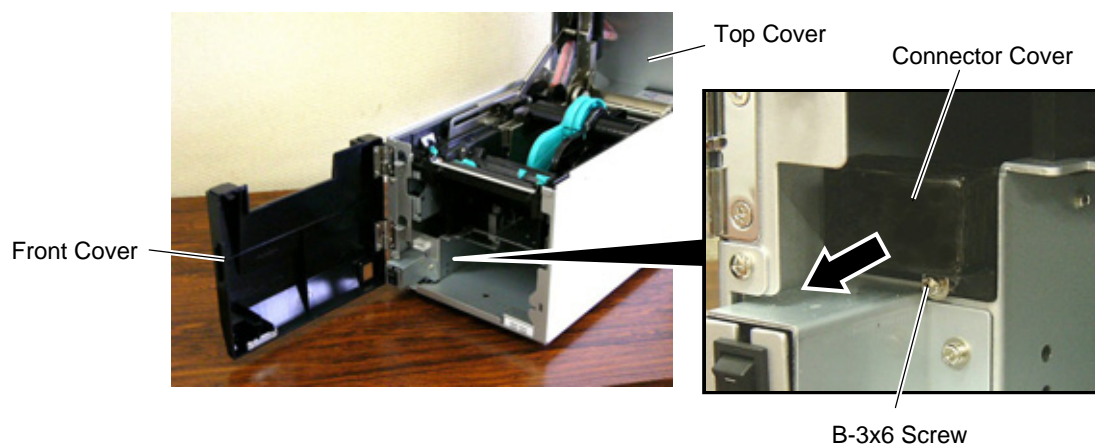

2. Open the Front Cover wider. Remove the Front Cover by lifting it to disengage the hinge pins from the hinge. The Front Cover cannot be removed unless it is opened at an angle of over 100 degrees as the stoppers of the hinge prevent disengagement.

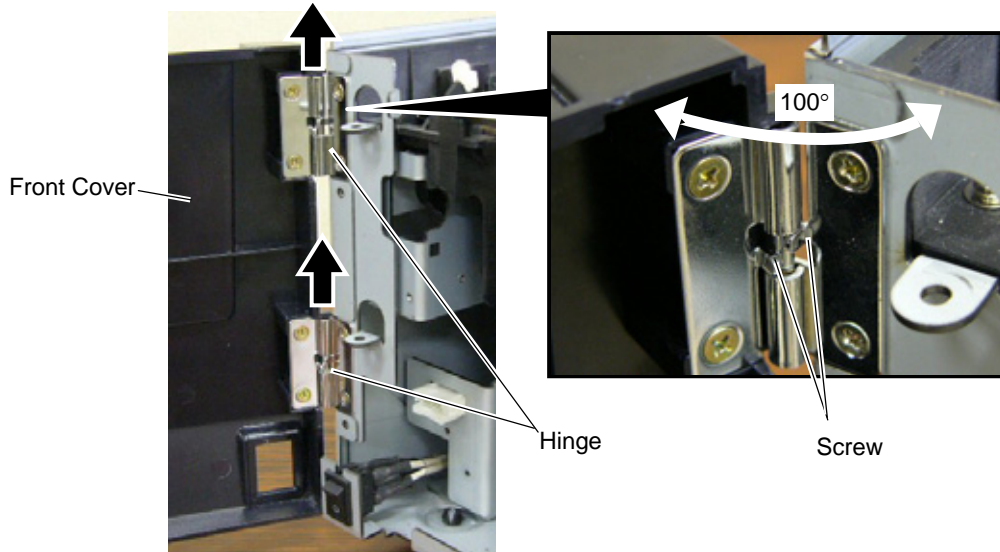

3. Mount the Strip Module Cover by inserting the hinge pins into the hinges.



4. Fit the Shaft Holders of the Backing Paper Feed Roller into the cuts of the printer.

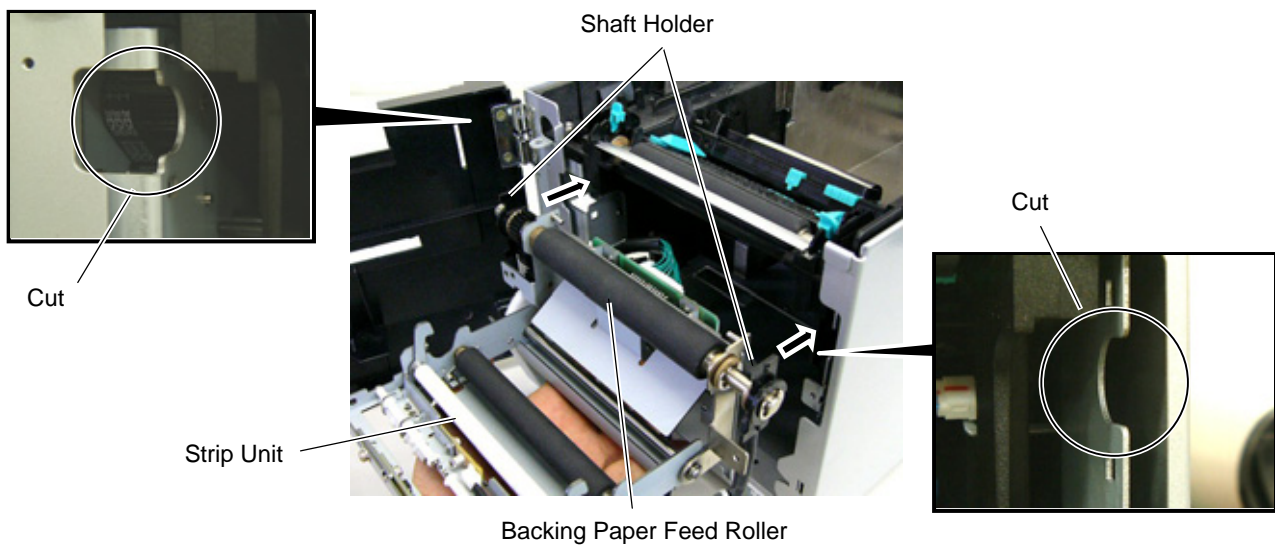

5. Secure the Strip Unit to the printer with the two screws. Make sure that the Feed Roller Gear rotates smoothly.

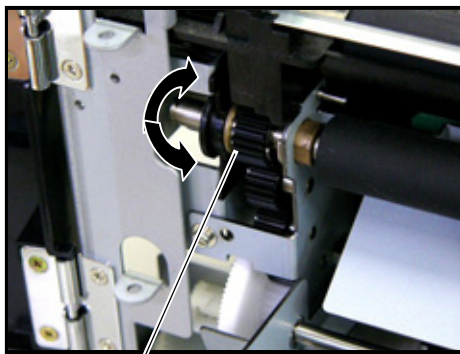

Feed Roller Gear



Strip Unit

SMW-3x6 Screw

6. Close the Strip Unit.

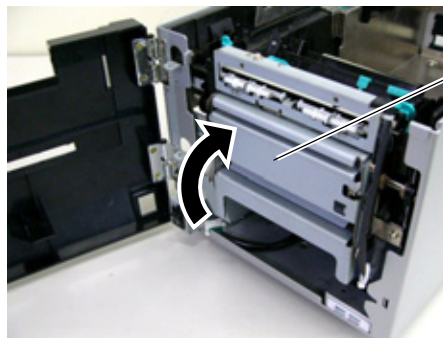

Strip Unit

7. Connect the Strip Harness to the connector at the front of the printer. At this time, carefully avoid contact of the strip harness with the gears.

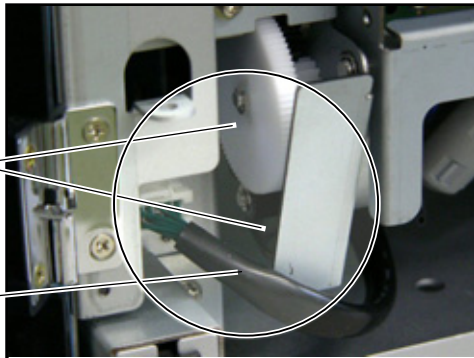

Gear

Strip Harness

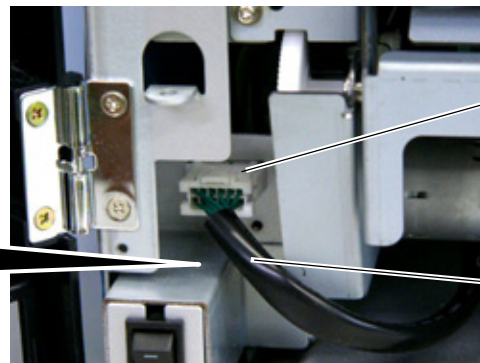

Connector

Strip Harness

8. Close the Strip Module Cover.

Perform an operation check for a proper strip issue.



- Media loading procedure----- Owner's Manual, Section 2.3
- Operation check----- Owner's Manual, Section 2.9
- System mode setting----- System Mode Manual
- Cleaning ----- Owner's Manual, Section 4.1.4

● **Attaching the Cutter**

The enclosed cutter is used to tear off the batch-issued labels. Attach the cutter with the two SMW-3x6 screws as shown in the picture below. Insert the leading edge of the labels into the opening under the cutter.

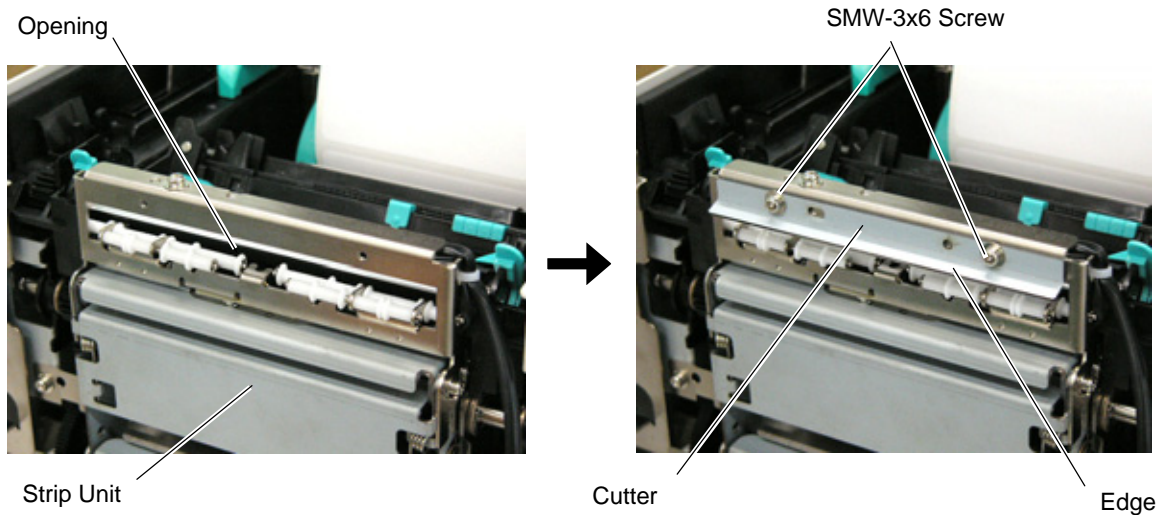

NOTE: Depending on the backing paper types, tearing off the backing paper against the slot of the strip module cover may cause it to wind onto the inner rollers. It is advisable to tear off or cut the backing paper outside the strip module cover.

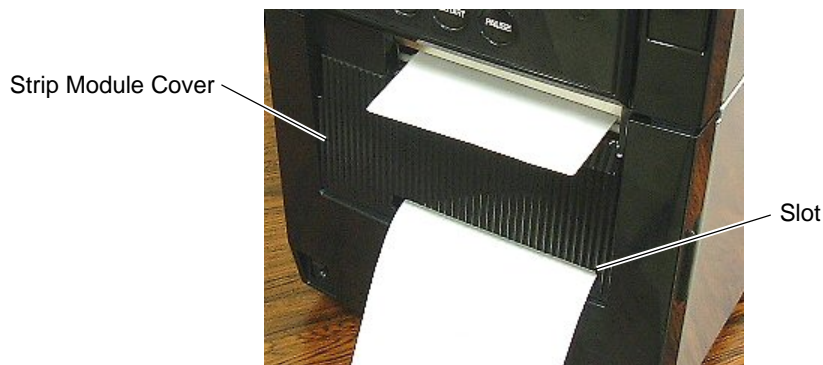

● **How to use the Guide Roller**

When issuing the label with the length of 50 mm or more, fit the guide roller to the center of the strip module cover to prevent the stripped label from sticking to the cover.



• **System Mode Settings for Stripping PET Labels**

When using PET labels on the strip module, please set the following system mode parameters in advance.

1. Connect the printer to a PC.
2. Load a PET label stock on the printer.
3. Turn ON the printer while holding down the **[FEED]** key and **[PAUSE]** key.
4. When "<1>DIAG. " is displayed on the LCD, press the **[FEED]** key to choose "<2>PARAMETER SET" menu.
5. Press the **[PAUSE]** key repeatedly until "PRE PEEL OFF" appears on the LCD.
6. As the default is OFF, choose "PRE PEEL OFF ON" with the **[FEED]** or **[RESTART]** key. Then, press the **[PAUSE]** key.
7. "P.P. FEED +0.0mm" is displayed on the LCD. Press the **[PAUSE]** key repeatedly until "PEEL OFF TRQ" appears on the LCD.
8. This menu is to set the strip motor torque. As the default is R0, choose R3 with the **[FEED]** or **[RESTART]** key. Then, press the **[PAUSE]** key.

NOTE: Setting the motor torque higher makes the strip issue easier.

Strip motor torque	Value
Low	R0
↑ ↓	R1
	R2
High	R3

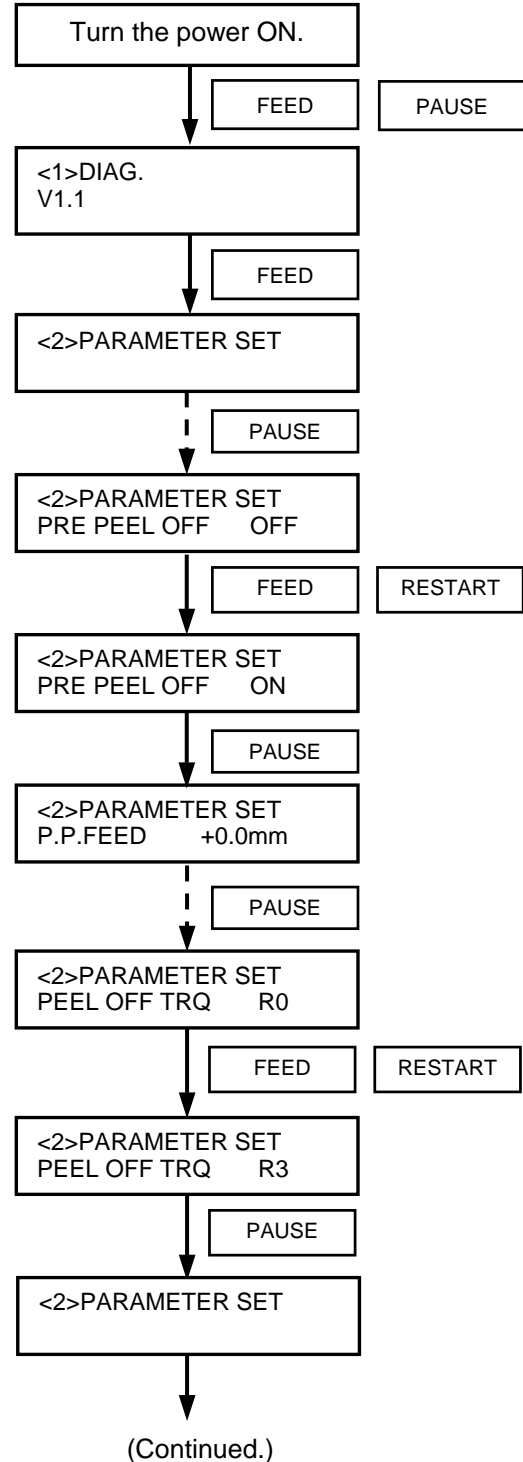

9. Turn off the printer, and then back to on. Send an issue command to the printer for strip issue.
10. If necessary, fine adjust the print start position and strip position in the system mode.

NOTES:

1. It is recommended that the print start position and strip position are adjusted on the actual print condition.
2. When short-pitch labels are used, the print start position may misalign on the first few labels. In that case, feed the labels between the media sensor and the strip shaft, and discard them.

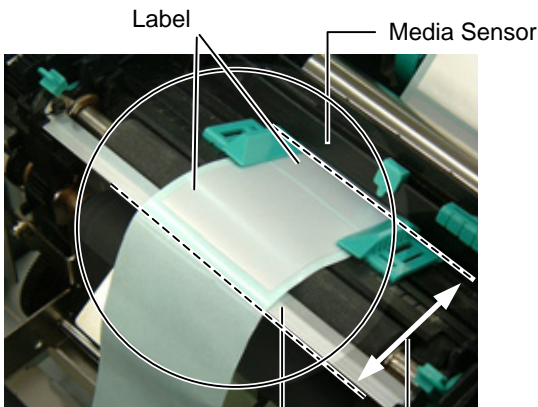

Discard labels between the media sensor and the strip shaft.

11. Repeat Steps 9 and 10 for position fine adjustment.
12. After the print position and strip position are properly adjusted, access "<2>PARAMETER SET" menu in the system mode again.

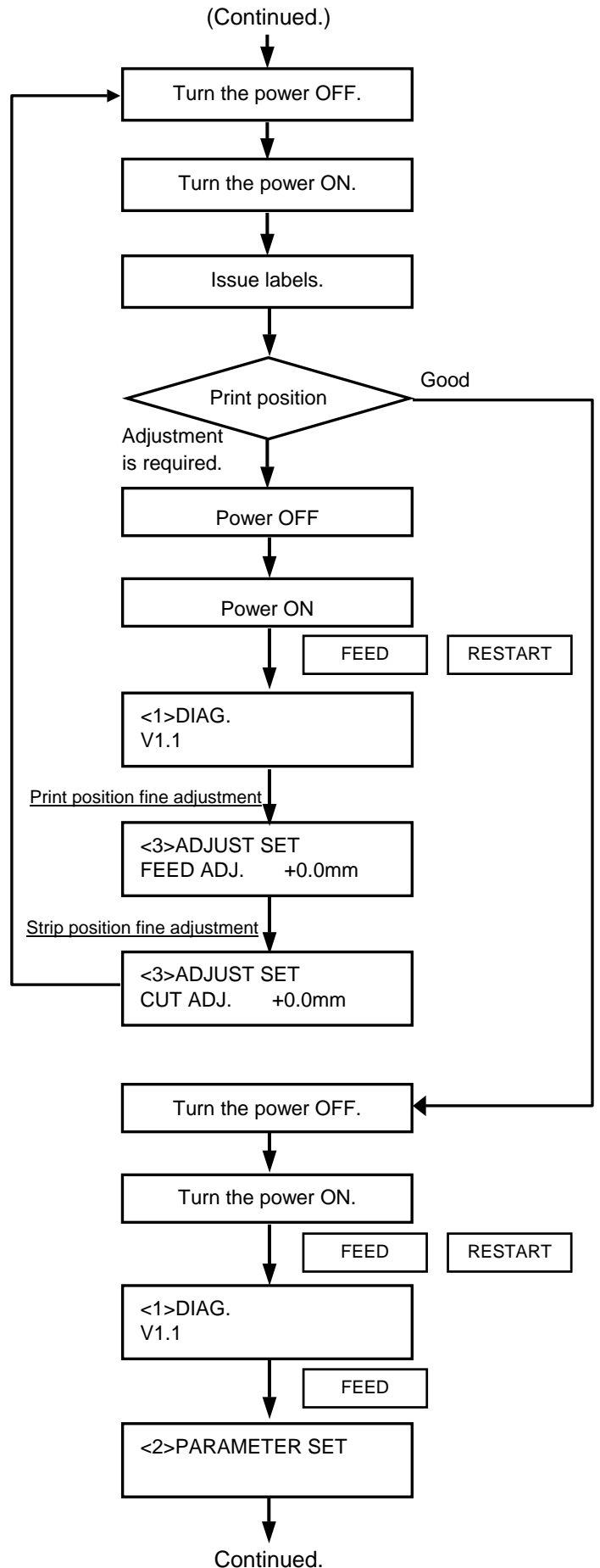

13. Press the **[PAUSE]** key repeatedly until "P.P.FEED" appears on the LCD.
14. Press the **[FEED]** key to feed a label for checking the next label's stop position. If the next label stops with its top edge aligning with the strip shaft edge, an adjustment is not required. Go to Step 15.

If not, press the **[RESTART]** key to return to "P.P.FEED +0.0mm" display, and adjust the pre-strip amount. Set the value in a range from +9.9 to -2.5 with the **[FEED]** or **[RESTART]** key.

When the top edge of the label stops past the strip shaft edge, set a negative (-) value.

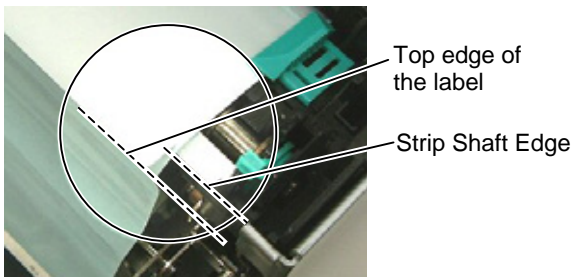

When the top edge of the label stops short of the strip shaft edge, set a positive (+) value.

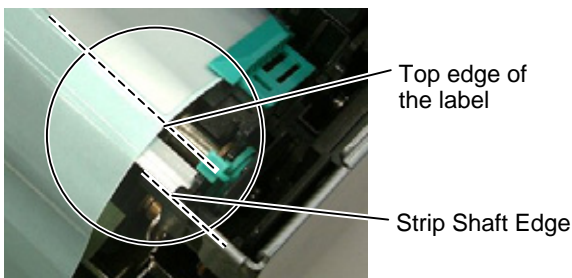



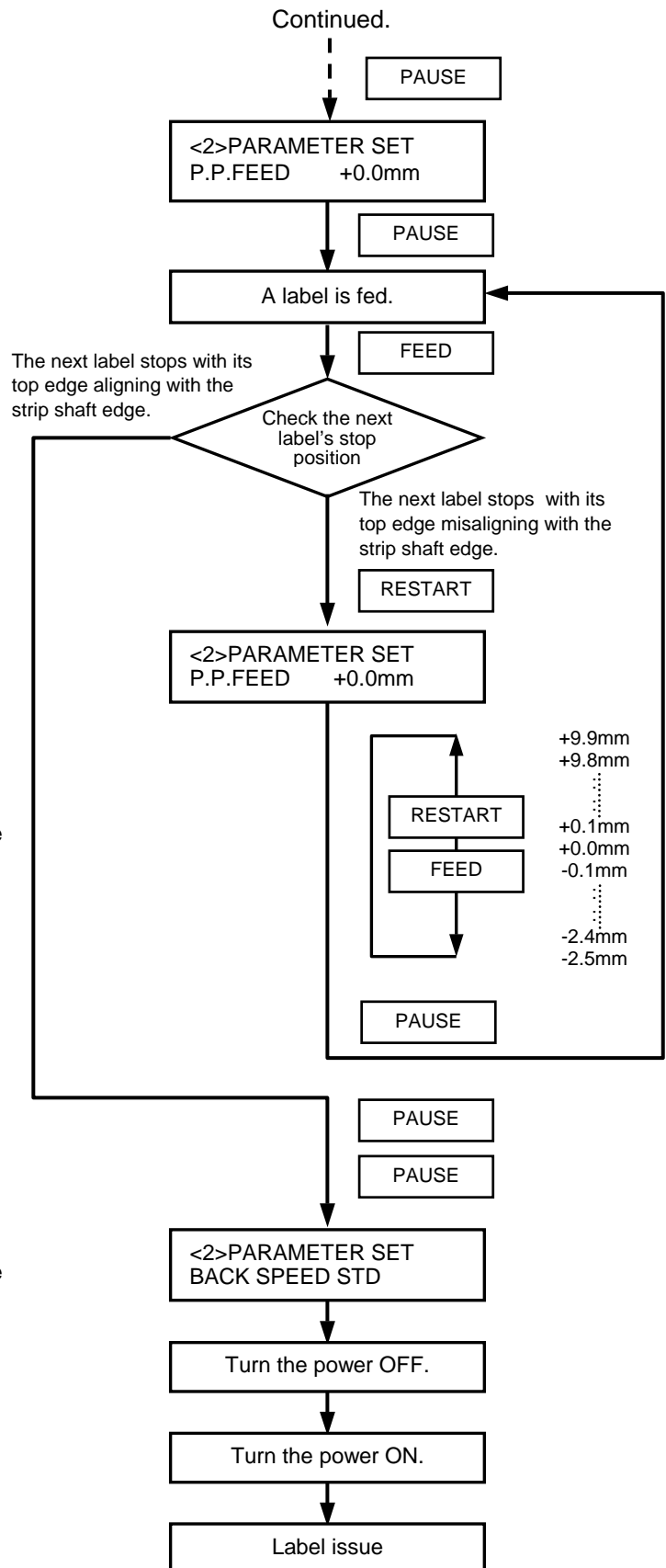

15. When the adjustment is completed, press the **[PAUSE]** key twice to finish the setting.
16. Send an issue command to the printer and check for proper strip issue.

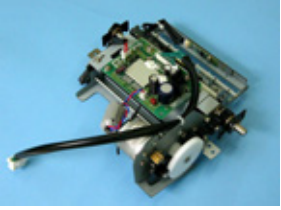

2.2 B-SA904P-H-QM-R

B-SA904P-H-QM-R is an optional strip module for the B-SA4TP Series (Plastic cover).

• **Packing List**

<p>Strip Unit (1 pc.)</p> 	<p>Strip Module Cover (1 pc.)</p> 	<p>SMW-3x6 Screw (4 pcs.)</p> 
<p>Cutter (1 pc.)</p> 	<p>Guide Roller (1 pc.)</p> 	<p>Installation Manual (1 copy)</p> 

NOTE: When issuing labels in batch mode even though the strip module is fitted, please use the provided cutter to tear off the issued labels. Do not attach the cutter when labels are stripped one by one.

• **Installation Procedure**

1. Open the Top Cover and the Front Cover. Remove the Connector Cover.

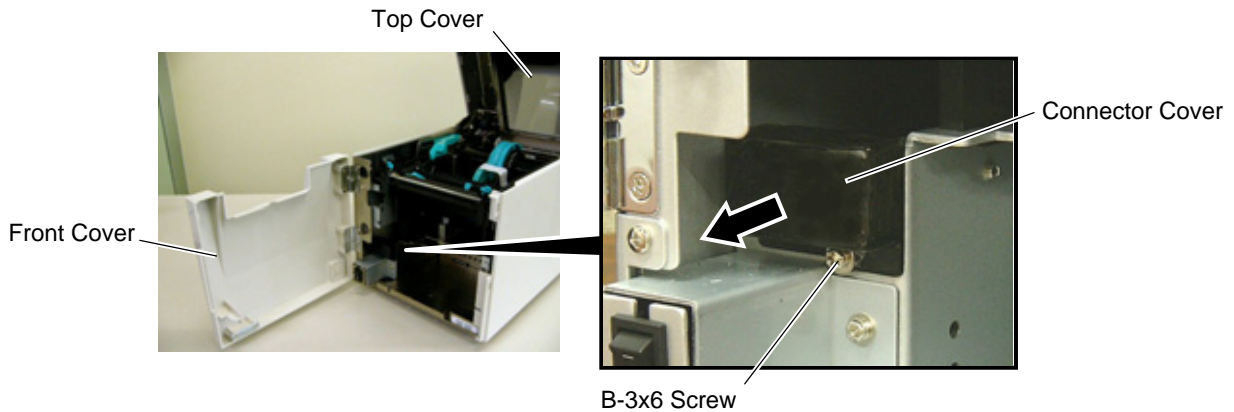

- Open the Front Cover wider. Remove the Front Cover by lifting it to disengage the hinge pins from the hinge. The Front Cover cannot be removed unless it is opened at an angle of over 100 degrees as the stoppers of the hinge prevent disengagement.

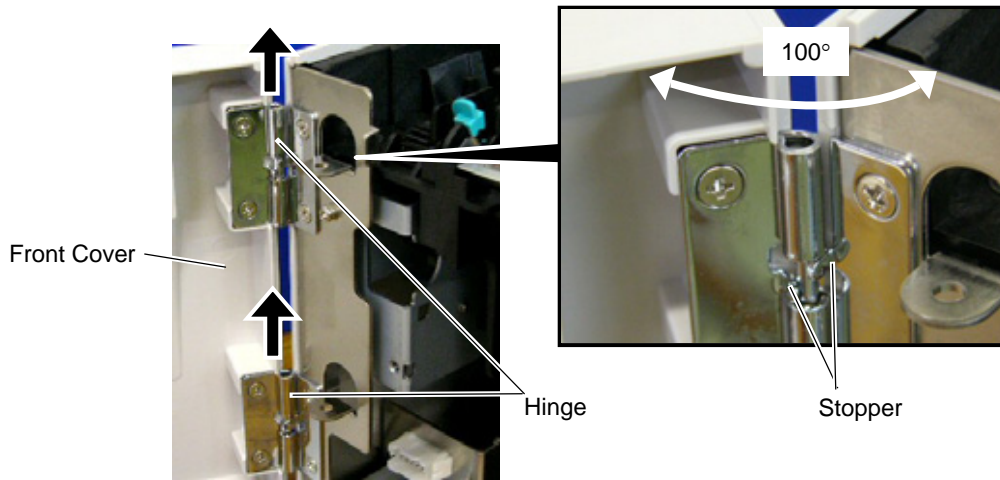

- Mount the strip Module Cover by inserting the hinge pins into the hinges.

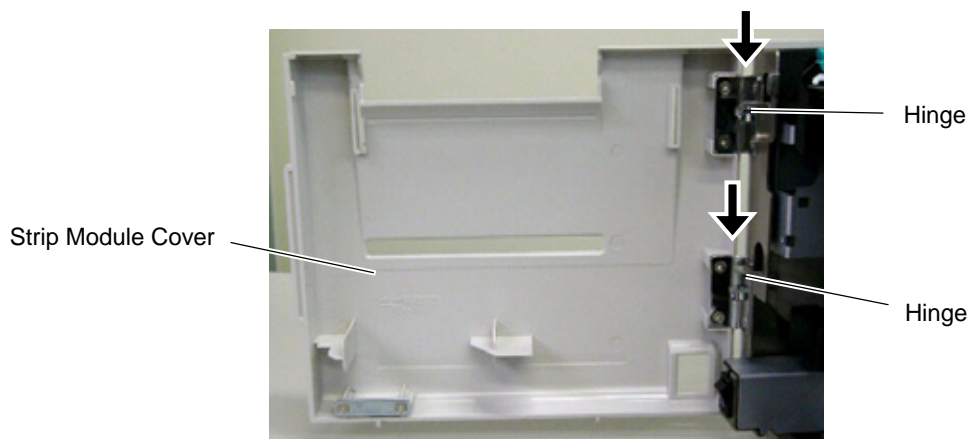

- Fit the Shaft Holders of the Backing Paper Feed Roller into the cuts of the printer.

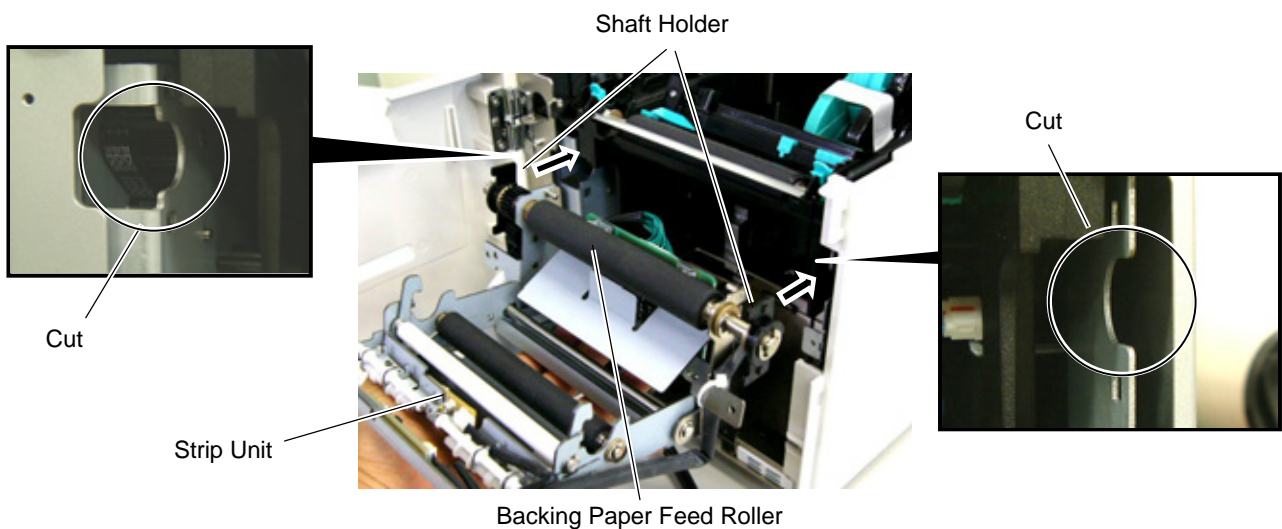

5. Secure the Strip Unit to the printer with the two screws. Make sure that the Feed Roller Gear rotates smoothly.

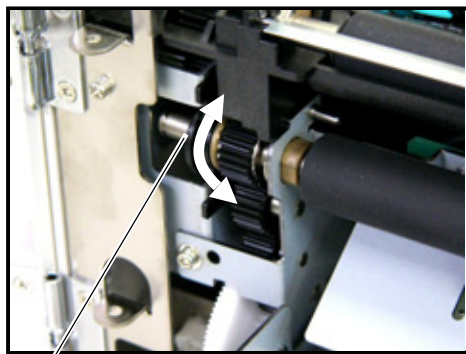

Feed Roller Gear



Strip Unit

SMW-3x6 Screw

6. Close the Strip Unit.

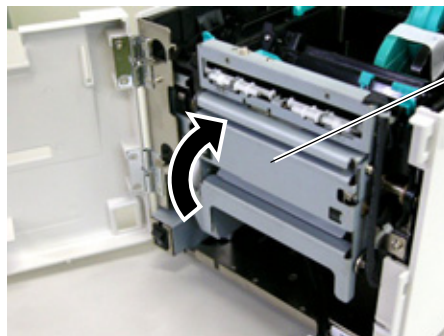

Strip Unit

7. Close the Strip Module Cover. Perform an operation check for a proper strip issue.



- Media loading procedure----- Owner's Manual, Section 2.3
- Operation check----- Owner's Manual, Section 2.9
- System mode setting----- System Mode Manual
- Cleaning ----- Owner's Manual, Section 4.1.4

● **Attaching the Cutter**

The enclosed cutter is used to tear off the batch-issued labels. Attach the cutter with the two SMW-3x6 screws as shown in the picture below. Insert the leading edge of the labels into the opening under the cutter.

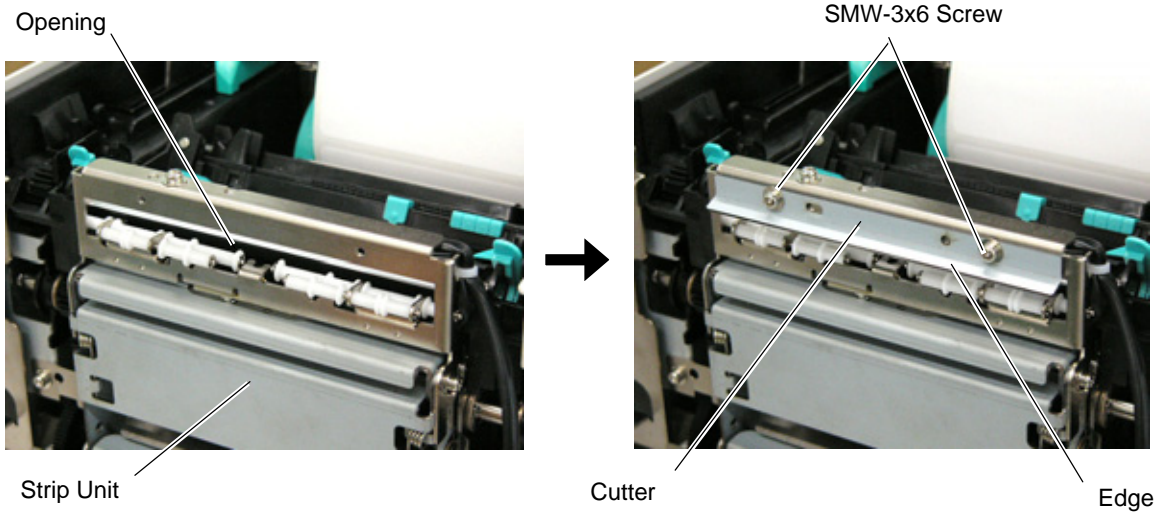

NOTE: Depending on the backing paper types, tearing off the backing paper against the slot of the strip module cover may cause it to wind onto the inner rollers. It is advisable to tear off or cut the backing paper outside the strip module cover.

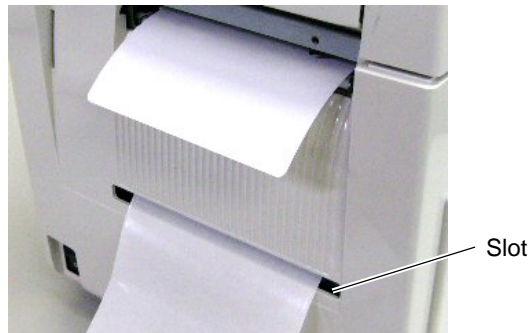

● **How to use the Guide Roller**

When issuing the label with the length of 50 mm or more, fit the guide roller to the center of the strip module cover to prevent the stripped label from sticking to the cover.

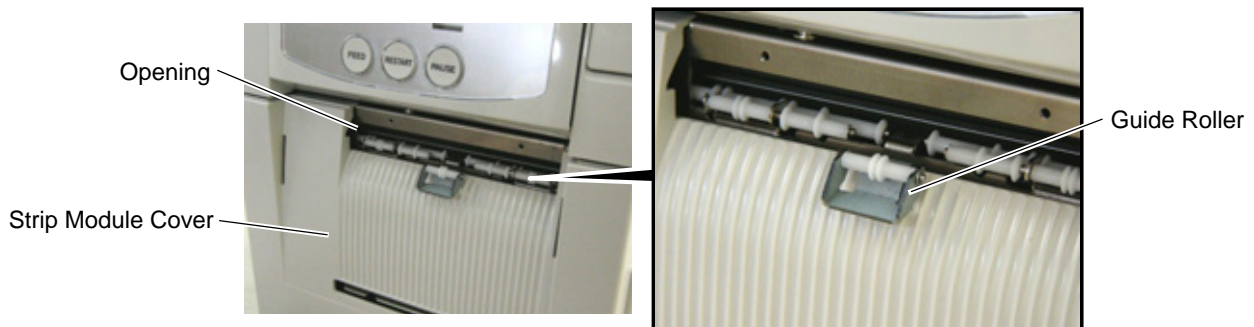





NOTE: Regarding the system mode setting for use of PET paper, refer to Section 2.1.

3. Wireless LAN Module: B-SA704-WLAN-QM

The pictures used in this section are those of the B-SA4TM, and the installation procedures are common with the B-SA4TP unless otherwise noted.

• **Packing List**

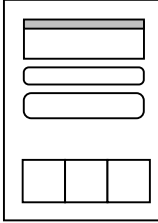
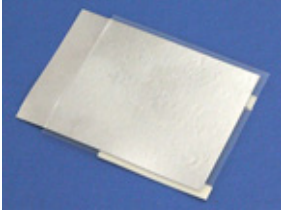
The following parts are supplied with the kit. Make sure you have all items shown below.

<p>Wireless LAN Board (1 pc.)</p> 	<p>Antenna Cover (1 pc.)</p> 	<p>SMW-3x6 Screw (4 pcs.)</p> 
<p>Installation Manual (1 copy)</p> 	<p>Shield Sheet (1 pc.)</p> 	<p>FCC/IC Sticker (1 pc.)</p> 

NOTES:

1. **DO NOT CHANGE** the DIP Switch settings on the Wireless LAN Board. Doing so may cause a malfunction.
2. MAC address of the Wireless LAN module will be necessary when setting the MAC address filtering function of an access point. As it is printed on the top of the wired LAN connector on the Wireless LAN Board, write down it on Installation Manual before mounting the covers so that an end user can know the MAC address.
3. Be careful not to hit or damage the antenna when installing this kit. A damaged antenna may affect the performance.

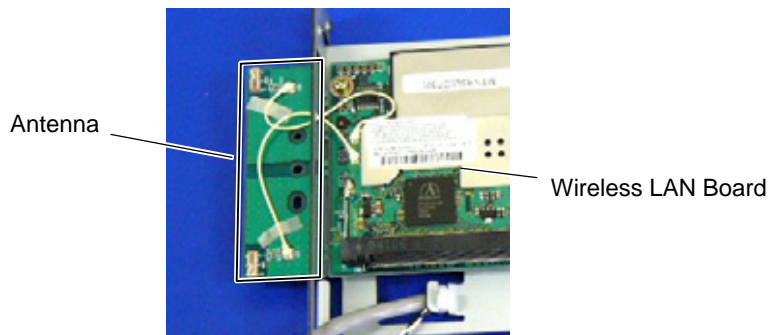
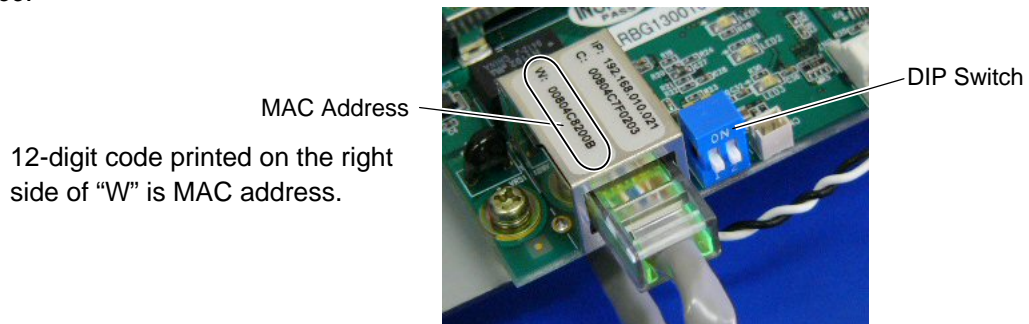

4. The shield sheet is used only when this option is installed in the B-SA4TP model.

• Installation Procedure

1. Remove the two SMW-3x6 screws from the back of the printer.

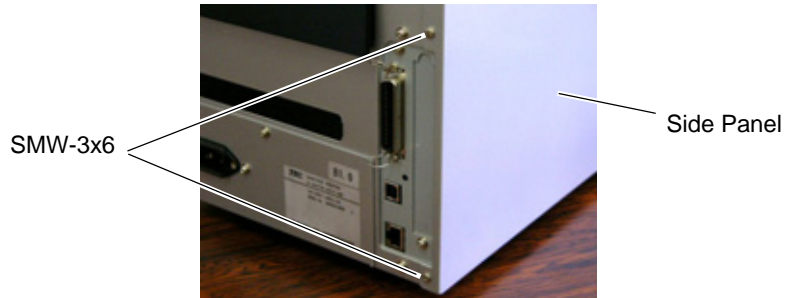

2. Remove the Side Panel in the following order. Please note the procedure is different between the B-SA4TM series and the B-SA4TP series.

B-SA4TM	B-SA4TP
<p>(1).Open the Top Cover and Front Cover.</p> <p>Top Cover</p> <p>Front Cover</p>	<p>Open the Top Cover. Slide the Side Panel backward, and then remove it in the direction of arrow A.</p> <p>Top Cover</p> <p>Side Panel</p> <p>A</p>
<p>(2).Remove the two SMW-3x6 screws which secure the Side Panel.</p> <p>SMW-3x6 Screw</p> <p>Side Panel</p> <p>SMW-3x6 Screw</p>	<p>Reverse side of Side Panel</p>
<p>(3).Close the Front Cover and remove the Side Panel.</p> <p>Side Panel</p>	<p>Hook</p>

3. Remove the two SMW-3x6 screws to detach the Blind Plate.



4. Remove the SMW-3x8 screw to detach the Cable Clamp.

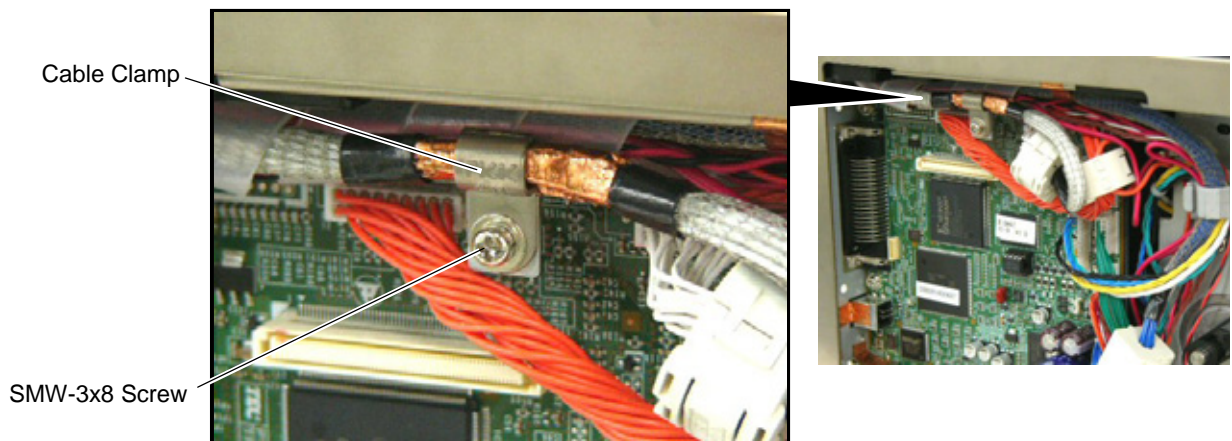

5. Put the Antenna of the Wireless LAN Board out of the opening in the printer back. Care must be taken not to hit the Antenna against the printer frame, as damaged antenna may affect the performance.

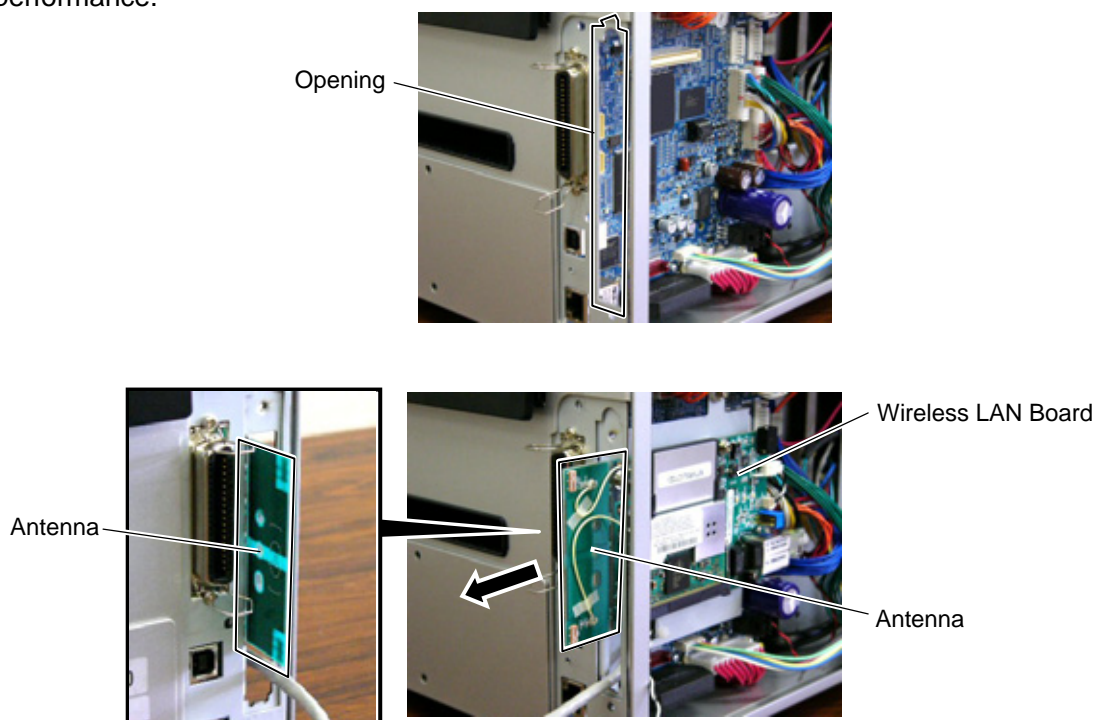

6. As the following picture shows, secure the Wireless LAN Board to the printer back with two of the enclosed SMW-3x6 screws. Also, secure the Wireless LAN Board to the PCB Support Plate with the SMW-3x8 screw together with the Cable Clamp removed in Step 4.

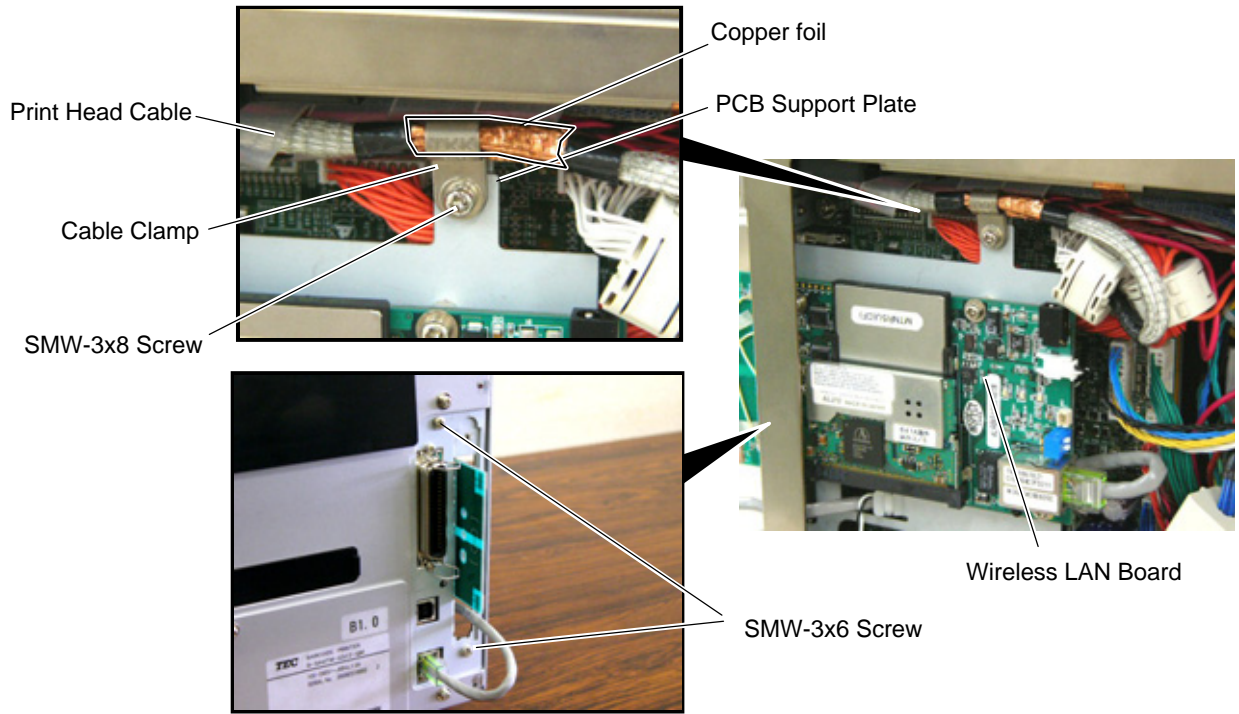

7. Only when this option is installed in the B-SA4TP printer, remove the three backing papers from the shield sheet and attach the shield sheet so that it covers the wireless LAN module.

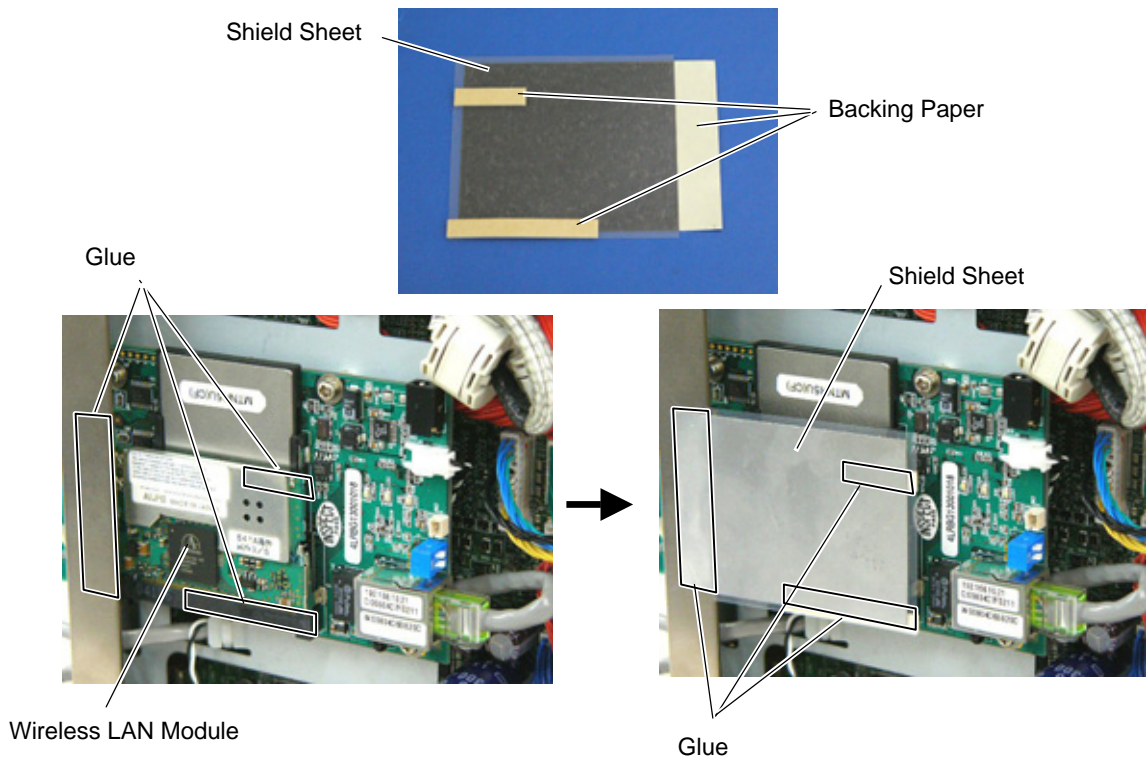

8. Connect the Wireless LAN Power Cable and the LAN Cable as shown below.

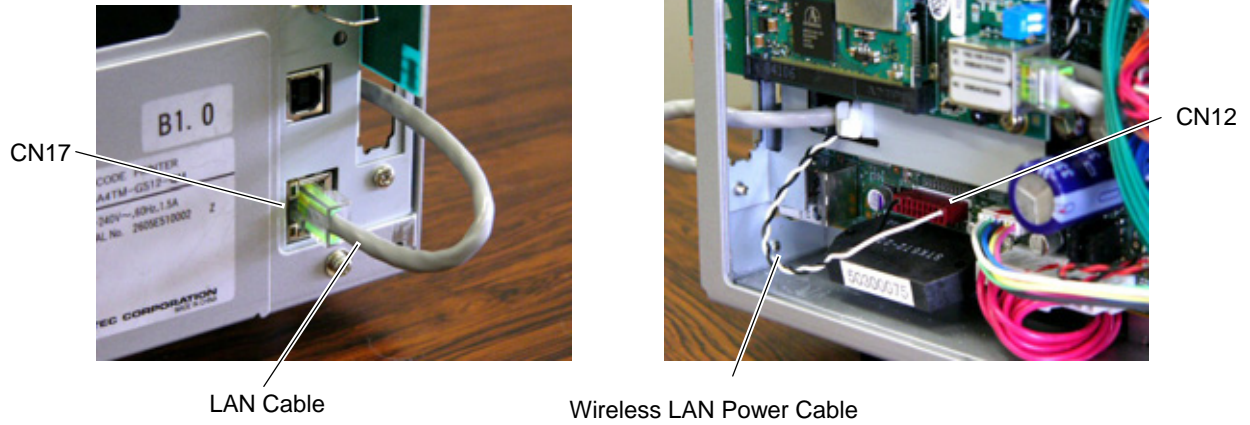

9. Fit the Antenna Cover to the back of the printer. Secure it with the SMW-3x6 screw.

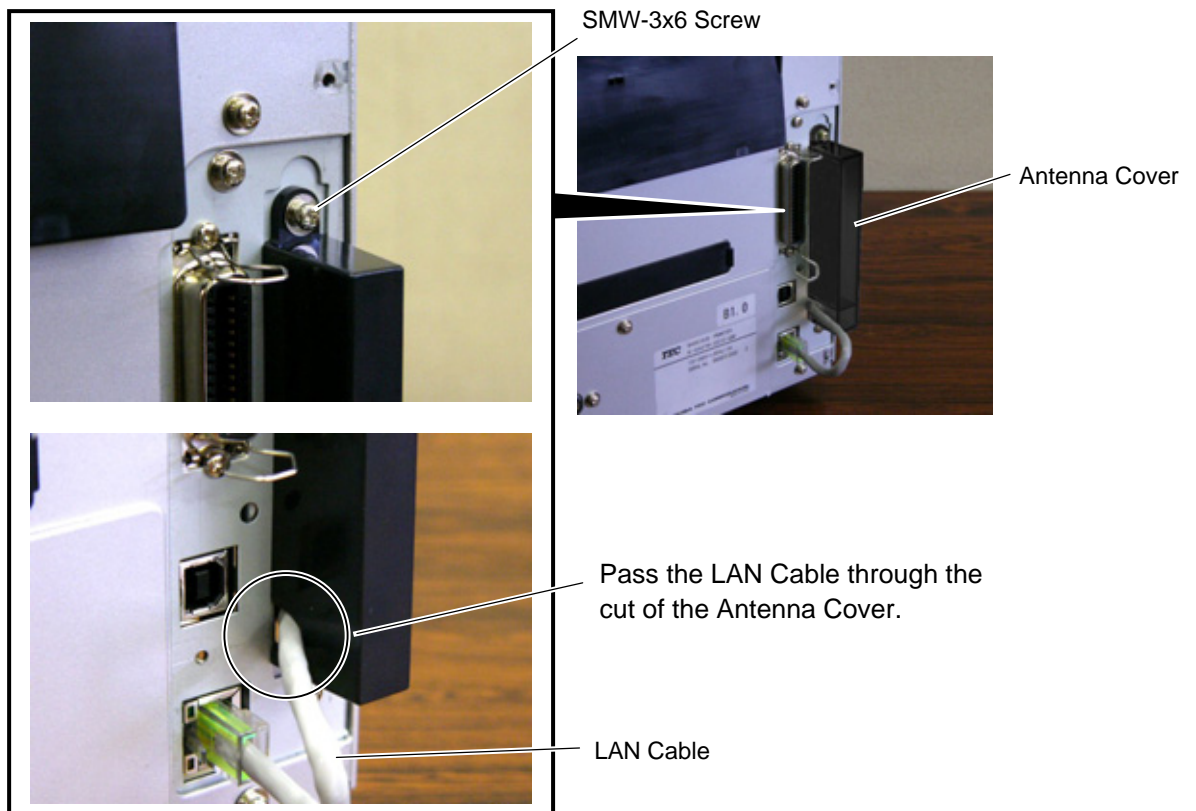

10. Re-attach the Side Panel to the printer.

• **Country Code**

As available frequency bands are different from country to country, be sure to set a country code before installing a wireless LAN module in a user's printer. Also, ask an end user to confirm a country code. Use of a wireless LAN module with a wrong country code could violate each country's Laws and Regulations for Radio Equipment, and violators could be subject to penalties.

The country code cannot be changed through the Web browser, but TELNET.

<How to set a country code using TELNET>

CAUTION! The following information must not be disclosed to users. (Internal use only)

- (1) Disconnect the LAN cable connected to the printer, connect the printer to a host PC with a straight LAN cable via a relay connector.
When using a hub in place of a relay connector, use a cross cable or
- (2) Open the MS-DOS prompt, type in "telnet 192.168.10.21" (default IP address).
- (3) Enter a password to log in. (Password: tecbcp)
- (4) From the top menu, change a country code using the following command.
=>ctry XX (XX=new country code. See Country Code Table.)
- (5) The new country code will become effective by turning the printer off and on again.
- (6) A country code can be checked by typing "=>ctry" on the telnet console.

<Country Code Table>

Country code	Country name	Country code	Country name	Country code	Country name
US	U.S.A./Canada	GR	Greece	IE	Ireland
FR	France	SE	Sweden	GB	U.K.
PT	Portugal	HU	Hungary	AU	Australia
NO	Norway	BE	Belgium	FI	Finland
DE	Germany	IT	Italy	LU	Luxembourg
ES	Spain	NL	Netherlands	CH	Switzerland
IS	Iceland	LI	Liechtenstein	NZ	New Zealand
AT	Austria	DK	Denmark		





Regarding various settings or operation check for the wireless LAN, refer to the System Mode Manual.

4. Serial Interface Board: B-SA704-RS-QM-R

The pictures used in this section are those of the B-SA4TM, and the installation procedures are common with the B-SA4TP unless otherwise noted.

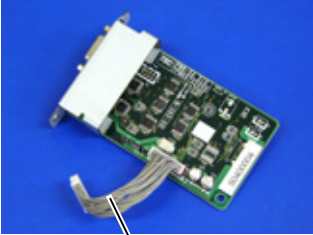
• Packing List

The following parts are supplied with the kit. Make sure you have all items shown below.

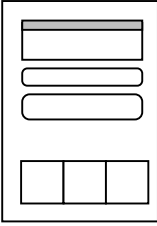
<p>SIO PC Board (1 pc.)</p>  <p>Serial Interface Cable</p>	<p>Locking Support (1 pc.)</p> 	<p>PCB Support Plate (1 pc.)</p> 
<p>SMW-3x6 Screw (3 pcs.)</p> 	<p>Installation Manual (1 copy)</p> 	

NOTE: Make sure that the Serial Interface Cable is connected to CN4 on the SIO PC Board.

• Installation Procedure

1. Remove the two screws from the back of the printer.

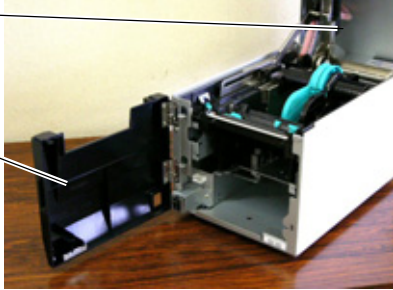
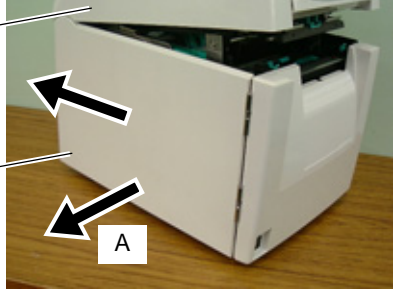
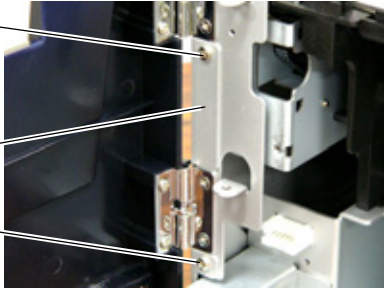
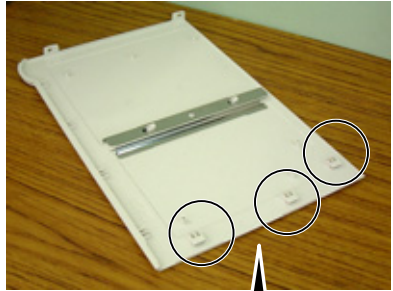
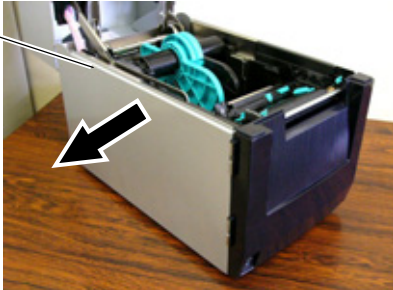
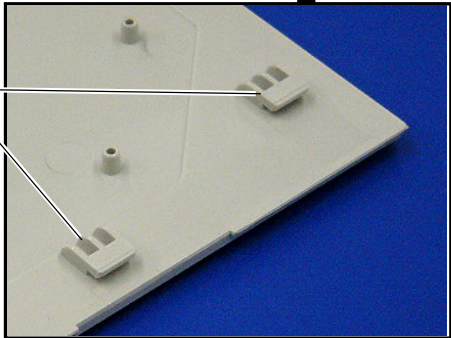

2. Remove the Side Panel in the following order. Please note the procedure is different between the B-SA4TM series and the B-SA4TP series.

B-SA4TM	B-SA4TP
<p>(1).Open the Top Cover and Front Cover.</p> <p>Top Cover</p> <p>Front Cover</p> 	<p>Open the Top Cover. Slide the Side Panel backward, and then remove it in the direction of arrow A.</p> <p>Top Cover</p> <p>Side Panel</p> <p>A</p> 
<p>(2).Remove the two SMW-3x6 screws which secure the Side Panel.</p> <p>SMW-3x6 Screw</p> <p>Side Panel</p> <p>SMW-3x6 Screw</p> 	<p>Reverse side of Side Panel</p> 
<p>(3).Close the Front Cover and remove the Side Panel.</p> <p>Side Panel</p> 	<p>Hook</p> 

3. Remove the two screws to detach the Blind Plate.



4. Attach the enclosed PCB Support Plate to the printer back with one of the enclosed SMW-3x6 screws.

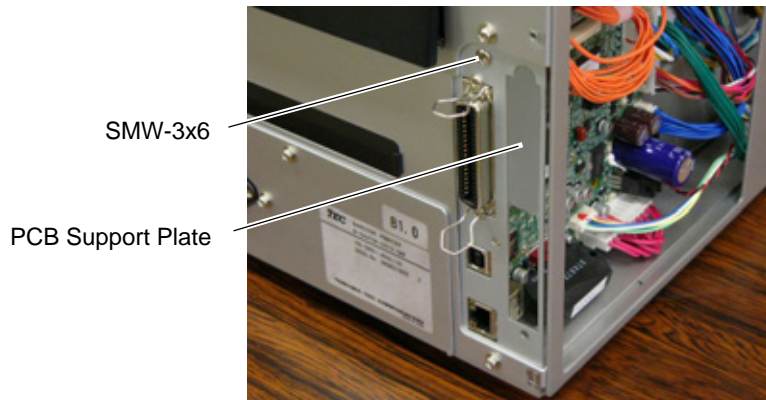

5. Fit the Locking Support into the MAIN PC Board.

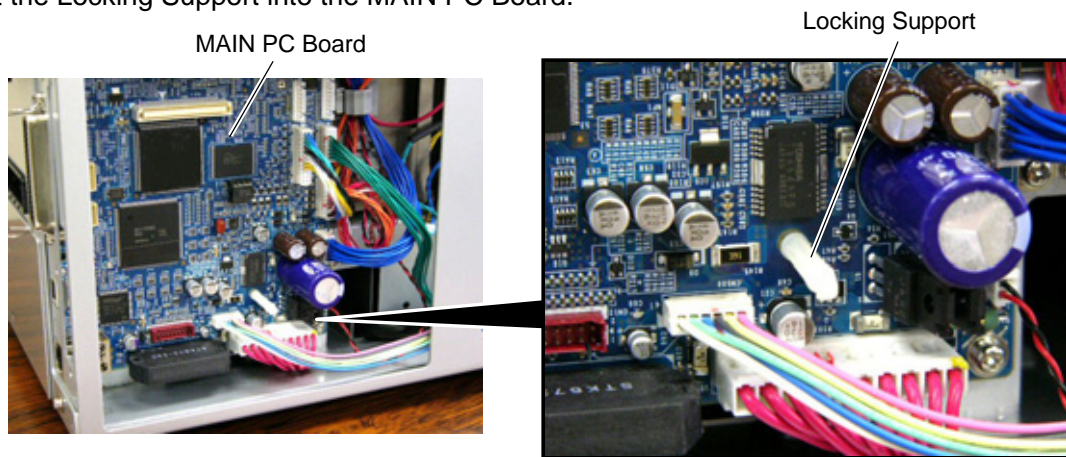

6. Connect the Serial Interface Cable of the SIO PC Board to CN12 on the MAIN PC Board.

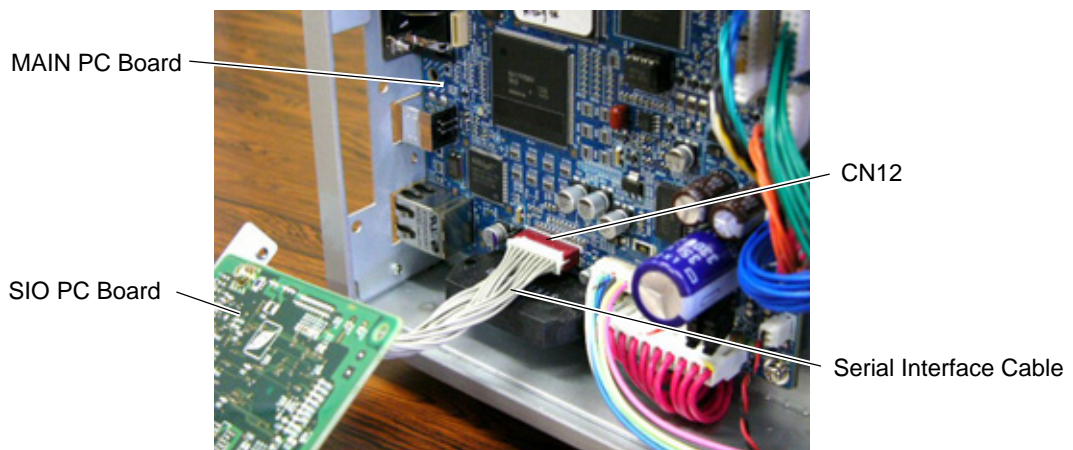

7. Secure the SIO PC Board to the printer back with the two SMW-3x6 screws. Fit the Locking Support into the SIO PC Board.

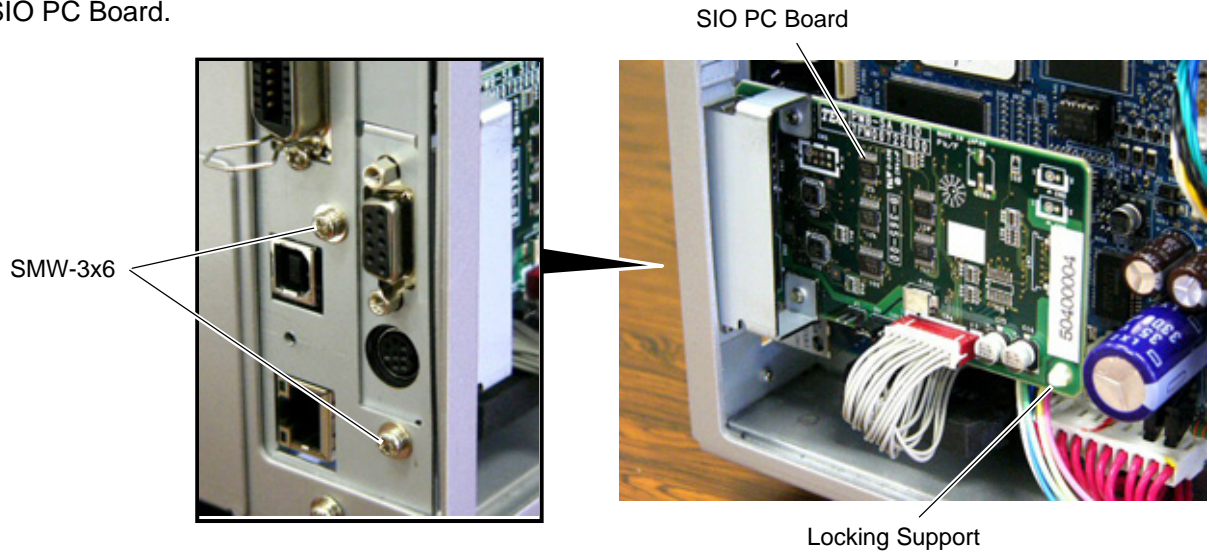

8. Re-attach the Side Panel.
9. For an operation check, settings, etc., refer to the.

5. 300 dpi Print Head Kit: B-SA704-TPH3-QM-R

B-SA704-TPH3-QM-R is an optional 300 dpi print head kit for the B-SA4TM/SA4TP-GS12 Series (203dpi printer).

You will obtain the same print quality as the TS12 model (300 dpi) only by replacing the current print head with this optional kit.

The pictures used in this section are those of the B-SA4TM, however, the installation procedure is common with the B-SA4TP.

WARNING!

Do not touch the print head or its neighboring parts immediately after printing, or you may burn yourself.

CAUTION!

1. NEVER loosen or remove the following two screws of the Print Head as they have been fine adjusted before shipment. If they are loosened or removed, print quality may become deteriorated.

NEVER loosen or remove these screws.

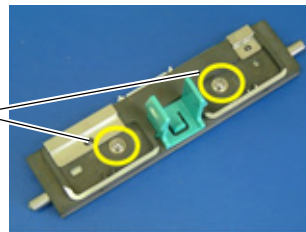

2. Do not touch the Print Head Element when handling the Print Head.

• Packing List

The following parts are supplied with the kit. Make sure you have all items shown below.

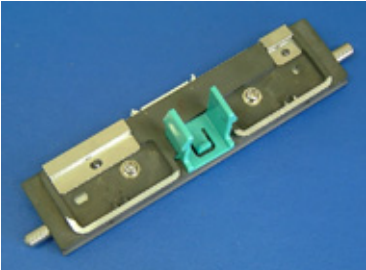
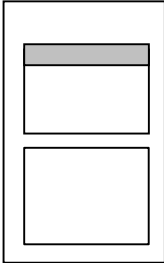
<p>300 dpi print head (1 pc.)</p> 	<p>Installation Manual (1 copy)</p> 
---	---

● **Installation Procedure**

1. Fully open the Ribbon Cover.
2. Slightly open the Top Cover (10 mm).

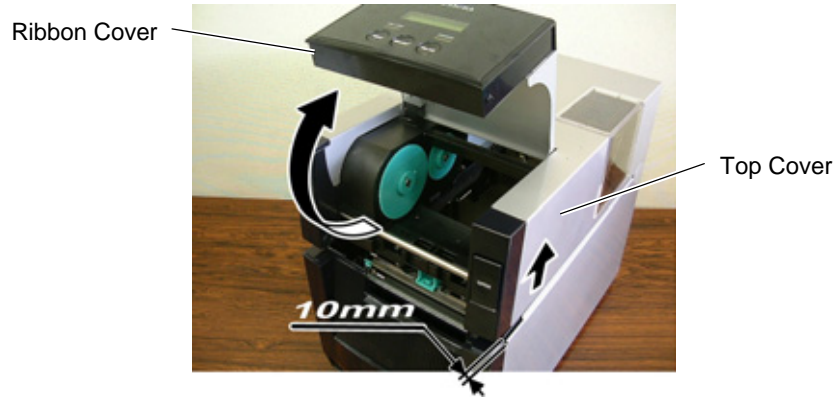

3. Unlock the Print Head by pressing the hooks toward the center. Then pull the Print Head downward.

NOTE: Care must be taken not to damage the Print Head Element by hitting it against any metal parts.

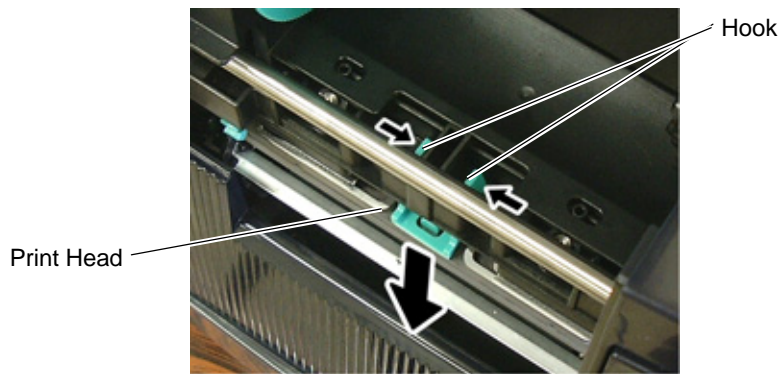

4. Disconnect the Print Head Cable from the Print Head.

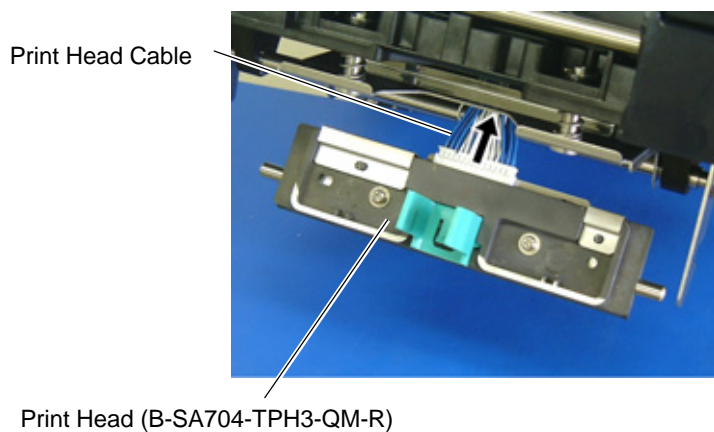

5. Replace the Print Head with a new one, and then reassemble in the reverse order of removal.



6. Real Time Clock: B-SA704-RTC-QM-R

B-SA704-RTC-QM-R is an optional Real Time Clock for the B-SA4TM/SA4TP Series. The pictures used in this section are those of the B-SA4TP, and the installation procedures are common with the B-SA4TM unless otherwise noted.

NOTE: When the B-SA704-IO-QM-R Expansion I/O Board or B-SA704-RS-QM-R Serial Interface Board has been already installed in the printer, the Interface Cable of the Real Time Clock cannot be connected to the MAIN PC Board. Please remove this optional PC board temporarily, prior to installing the Real Time Clock.

• Packing List

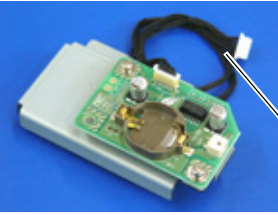
The following parts are supplied with the kit. Make sure you have all items shown below.

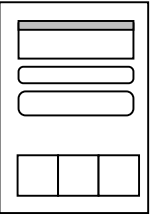
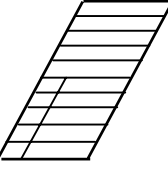
<p>Real Time Clock (1 pc.) See Note.</p>  <p>Interface Cable</p>	<p>SMW-4x8 Screw (1 pc.)</p> 	<p>Lithium Battery CR2032 (1 pc.)</p> 
<p>Installation Manual (1 copy)</p> 	<p>Battery Sticker (1 pc.)</p> 	<p>Note: Make sure that the Interface Cable is connected to CN1 on the Real Time Clock.</p>

• Installation Procedure

1. Remove the two SMW-3x6 screws from the back of the printer.

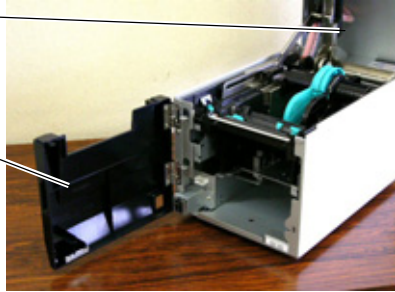
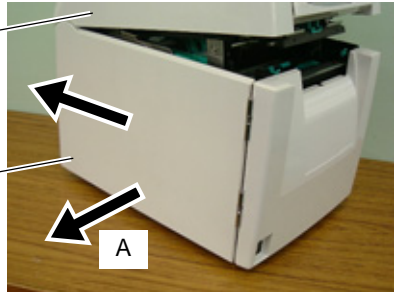
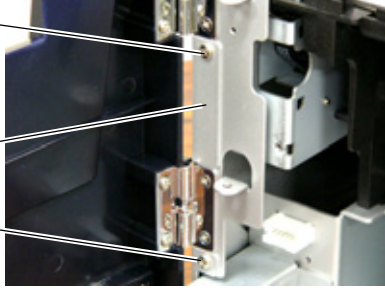
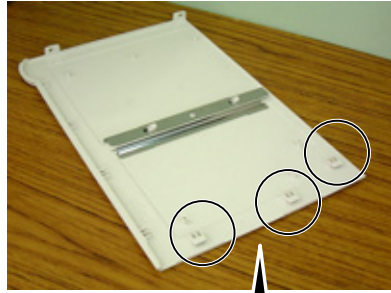
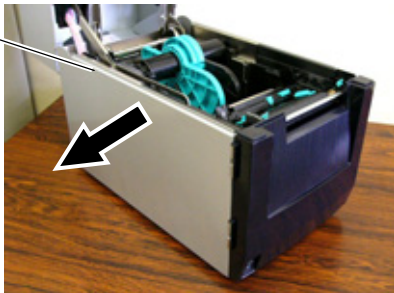
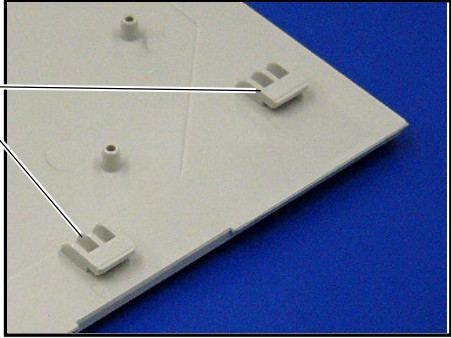

2. Remove the Side Panel in the following order. Please note the procedure is different between the B-SA4TM series and the B-SA4TP series.

B-SA4TM	B-SA4TP
<p>(1).Open the Top Cover and Front Cover.</p>  <p>Top Cover</p> <p>Front Cover</p>	<p>Open the Top Cover. Slide the Side Panel backward, and then remove it in the direction of arrow A.</p>  <p>Top Cover</p> <p>Side Panel</p> <p>A</p>
<p>(2).Remove the two SMW-3x6 screws which secure the Side Panel.</p>  <p>SMW-3x6 Screw</p> <p>Side Panel</p> <p>SMW-3x6 Screw</p>	<p>Reverse side of Side Panel</p> 
<p>(3).Close the Front Cover and remove the Side Panel.</p>  <p>Side Panel</p>	 <p>Hook</p>

3. Place the Lithium Battery into the Battery Socket in the direction of the arrow.

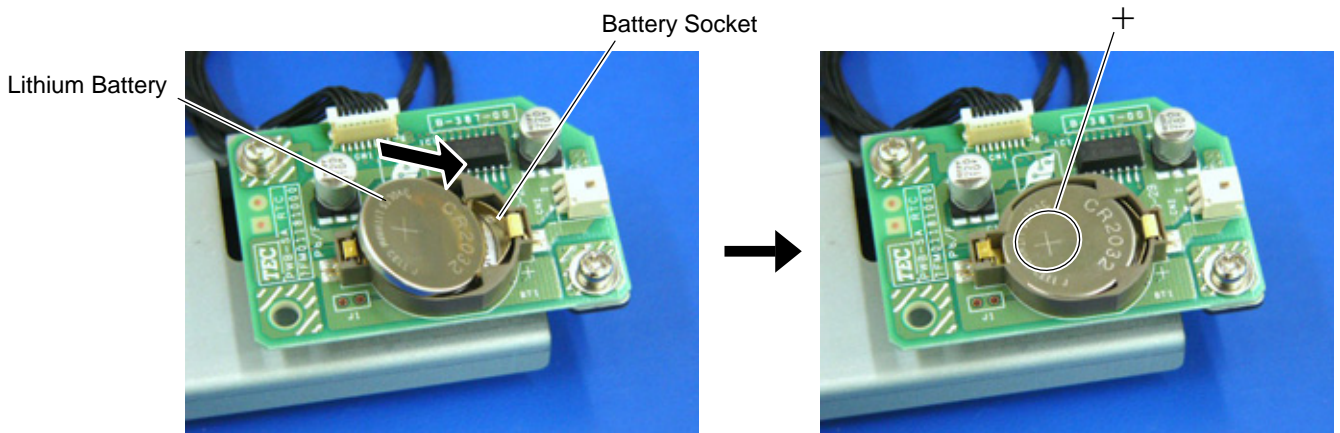

NOTES: 1. Place the battery with the “+” mark facing up.

2. A new battery is supposed to last about 2 years or more, but it varies depending on the operating conditions. When a new battery is loaded, write down the battery replacement date on a supplied battery sticker, and attach it to the reverse side of the Side Panel as a reminder.

Reverse side of Side Panel



Battery Sticker

電池有効期限	
EXPIRE DATE OF BATTERY LIFE	
PLAZO VIGENTE DE BATERIA	
DURÉE DE VALIDITÉ DU BATTERIE	
GÜLTIGSDAUER DER BATTERIE	
1	
2	
3	
4	
5	

4. Attach the Real Time Clock to the printer with the SMW-4x8 screw.

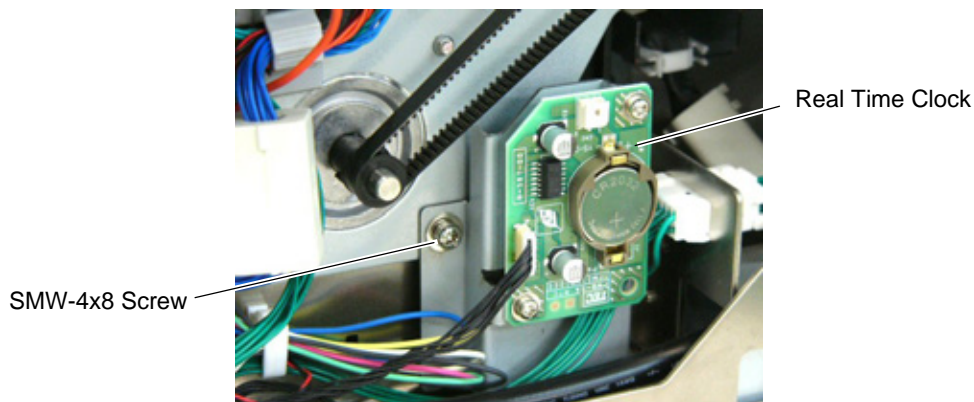

- Pass the Interface Cable through the Cable Clamp, and between CN1 and CN2 on the MAIN PC Board, as shown in the pictures below. For the B-SA4TP model, wind the cable on the two Cable Clamps.

B-SA4TP Model

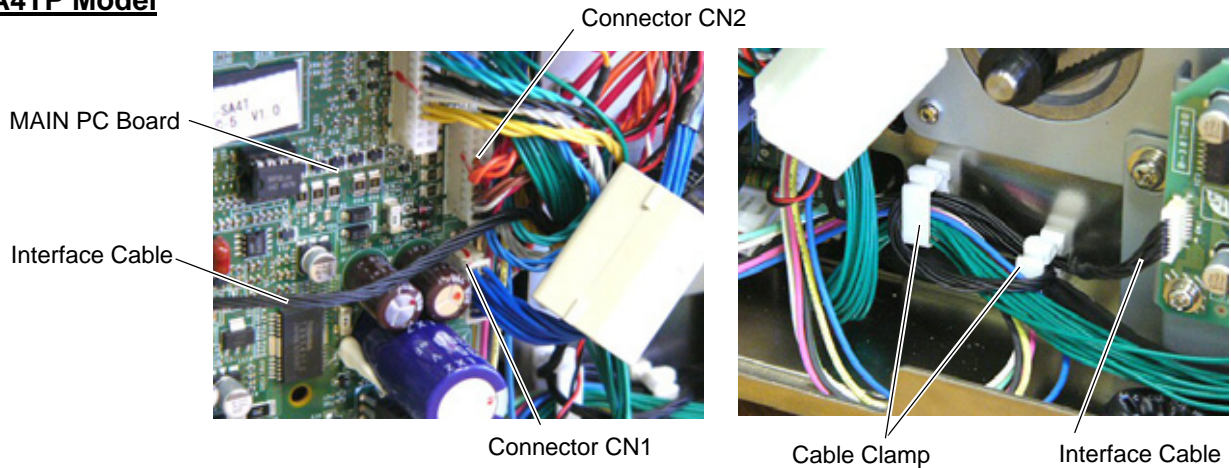

B-SA4TM Model

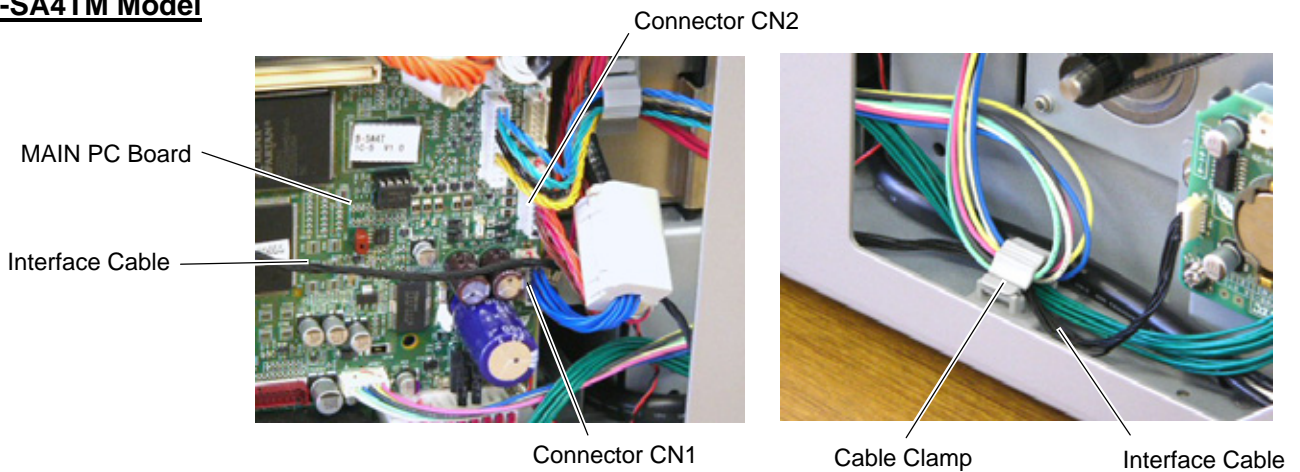

- Connect the Interface Cable to CN501 on the MAIN PC Board.

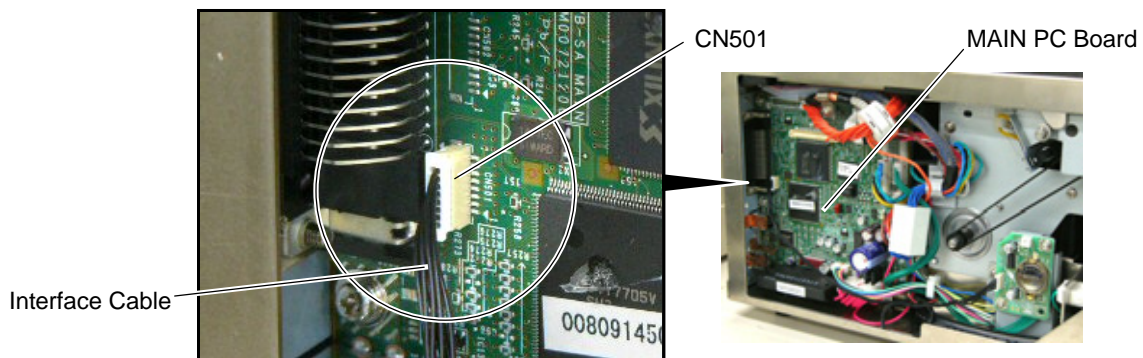

- Attach the Side Panel, removed in Step 2, back to the printer. Care must be taken not to catch the Interface Cable by the Side Panel.

NOTE: When the B-SA704-IO-QM-R Expansion I/O Board or B-SA704-RS-QM-R Serial Interface Board was removed beforehand, re-install it.

● **System Setting (Date and Time Setting)**

Set the date and time using the following procedure.

NOTE: Make sure that the printer version is V1.2 or greater. The real time clock is not supported by V1.1 or older.

1. Turn on the printer. "ONLINE" will be displayed on the LCD.
2. Press the [PAUSE] key to turn the printer to pause state.
3. Hold down the [RESTART] key until the printer enters the system mode.

NOTE: For details of the system mode, refer to the B-SA4T Series Owner's Manual stored in the CD-ROM supplied with the printer.

4. When "<1>RESET" is displayed on the LCD, press the [RESTART] key until "<8>RTC SET" appears.
5. Press the [PAUSE] key. The date currently stored in the real time clock is displayed.
6. Pressing the [PAUSE] key enables changing the Year.
7. Set the Year with the [FEED] or [RESTART] key. Pressing the [PAUSE] key fixes the Year and causes the cursor to move to the Month.
8. Set the Month with the [FEED] or [RESTART] key. Pressing the [PAUSE] key fixes the Month and causes the cursor to move to the Day.
9. Set the Day with the [FEED] or [RESTART] key. Press the [PAUSE] key to fix the Day. Then, the time currently stored in the real time clock is displayed.

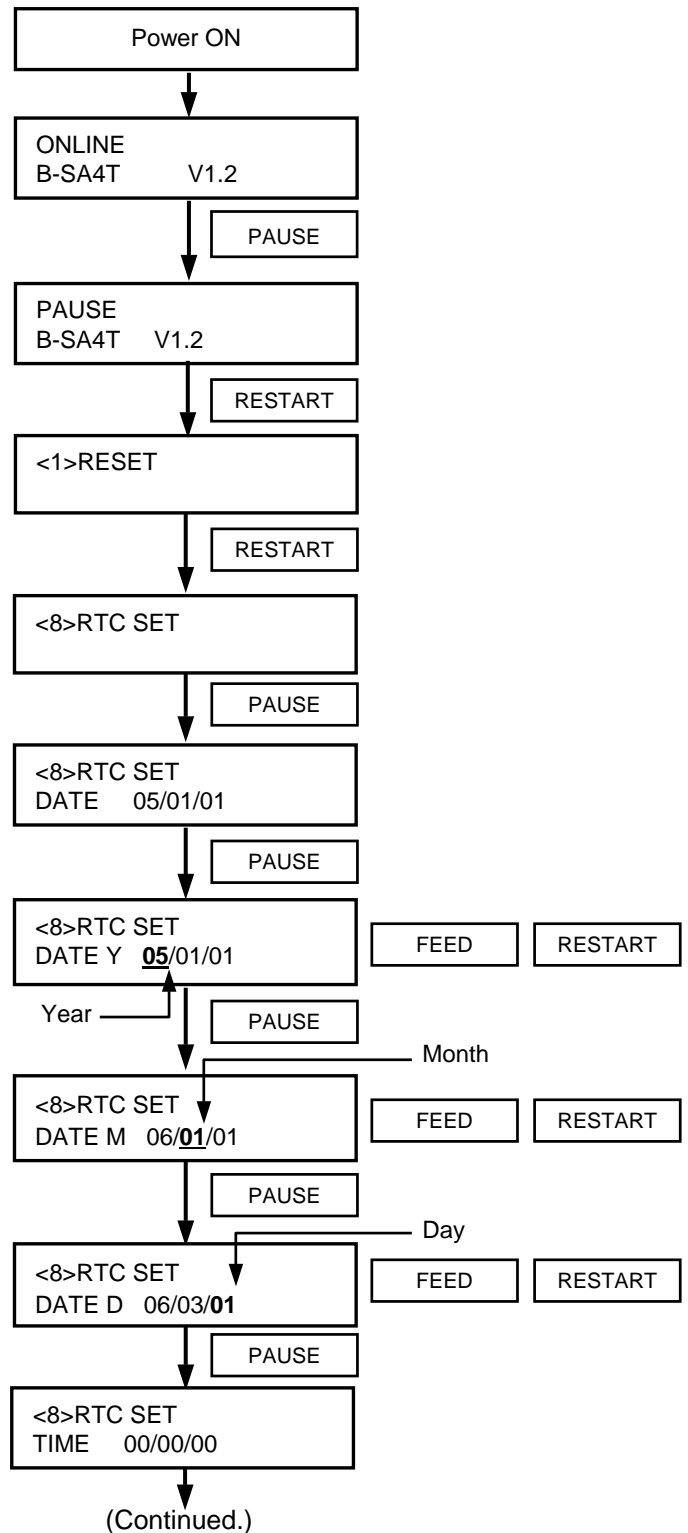

10. Pressing the **[PAUSE]** key enables setting the Hour.
11. Set the Hour with the **[FEED]** or **[RESTART]** key. Pressing the **[PAUSE]** key fixes the Hour and cause the cursor to move to the Minute.
12. Set the Minute with the **[FEED]** or **[RESTART]** key. Pressing the **[PAUSE]** key fixes the Minute and cause the cursor to move to the Second.
13. Set the second with the **[FEED]** or **[RESTART]** key. Press the **[PAUSE]** key to fix the Second. Then, the Low Battery Check selection screen is displayed.
14. Pressing the **[PAUSE]** key enables choosing whether to activate the low battery check function or not. Set the function to ON or OFF with the **[FEED]** or **[RESTART]** key.
 ON: Low battery check function is activated.
 OFF: Low battery check function is not activated. (Default)
 Press the **[PAUSE]** key to fix the setting. Then, the RTC Data Renewal Timing setting screen is displayed.
15. Pressing the **[PAUSE]** key enables choosing the RTC data renewal timing.
16. Choose PAGE or BATCH with the **[FEED]** or **[RESTART]** key.
 PAGE: A real time can be printed on each media. However, the printer needs to stop the motion before printing each media to read the real time clock data.
 BATCH: Batch print is possible. However, the same time is printed on the all media issued in a batch because the real time clock data is read only for the first media.
 Press the **[PAUSE]** key to fix the setting. Then, the current date is displayed.
17. Press the **[FEED]** and **[RESTART]** keys at the same time to return to "<8>RTC SET" display.

<Supplementary Explanation>

1. Be sure to load the battery and set the low battery check function to ON whenever the real time clock is used. If the battery is not loaded or the battery voltage is low, the real time clock data is erased at the power off time.
2. When the low battery check function is set to ON and if the battery voltage is 2.4V or less, the printer will result in a "LOW BATTERY" error and stop at the power on time. In that case, hold down the **[RESTART]** key to restore to "<1>RESET" display.
3. When "LOW BATTERY" error has occurred, contact the nearest TOSHIBA TEC service representative for replacement of the battery.
4. If you would like to keep using the same battery even after "LOW BATTERY" error occurs, set the Low battery check function to OFF, and set the date and time to the real time. As long as the power is on, the Real Time Clock will function. However, once the power is turned off, the date and time will be reset. Then, please ask for the battery replacement.

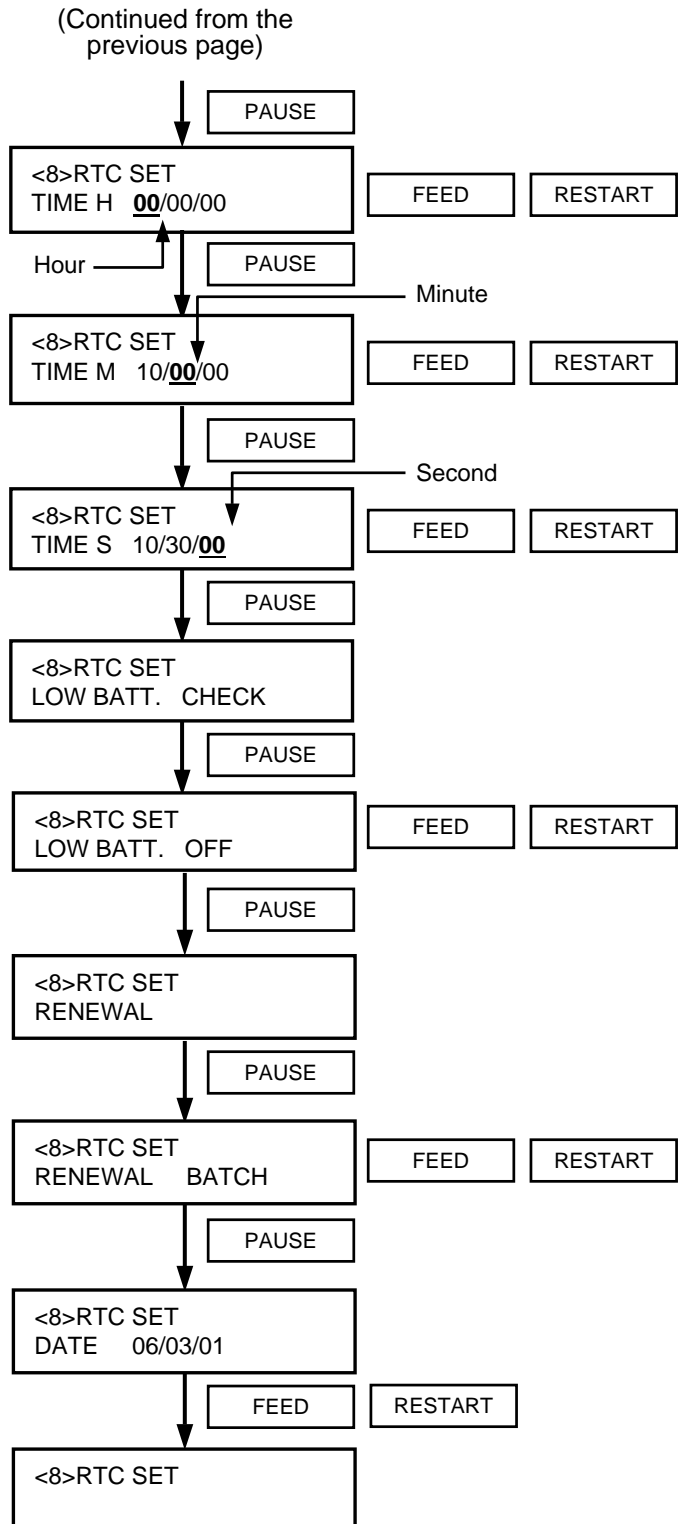



7. Expansion I/O Board: B-SA704-IO-QM-R

B-SA704-IO-QM-R is an optional expansion I/O board for the B-SA4TM/SA4TP Series. The pictures used in this section are those of the B-SA4TP, and the installation procedures are common with the B-SA4TM unless otherwise noted.

• Packing List

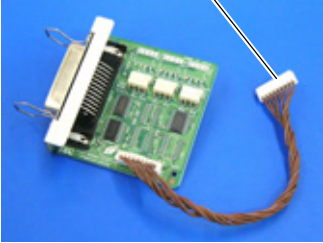
The following parts are supplied with the kit. Make sure you have all items shown below.

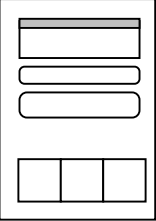
<p>Expansion I/O Board (1 pc.) See Note. Interface Cable</p> 	<p>Blind Plate (1 pc.)</p> 	<p>SMW-3x6 Screw (3 pcs.)</p> 
<p>Installation Manual (1 copy)</p> 	<p>Note: Make sure that the Interface Cable is connected to CN1 on the Expansion PC Board.</p>	

1. Remove the two SMW-3x6 screws from the back of the printer.

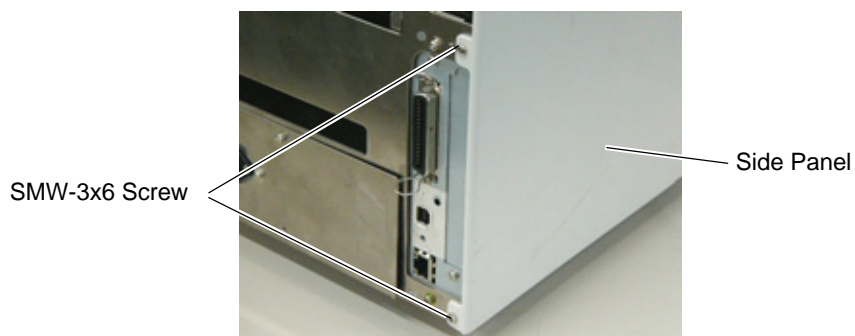

2. Remove the Side Panel in the following order. Please note the procedure is different between the B-SA4TM series and the B-SA4TP series.

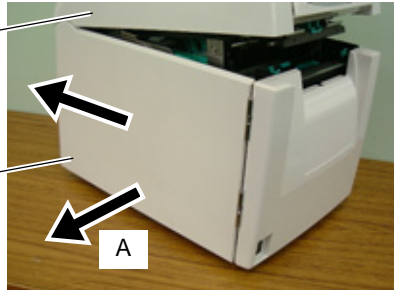
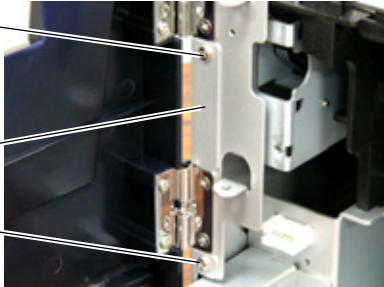
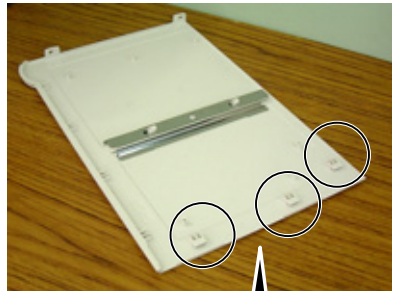
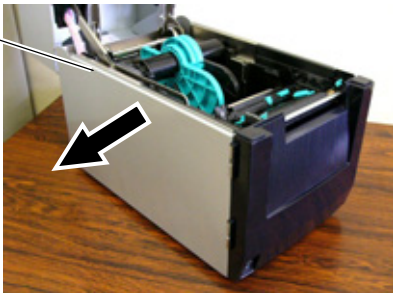
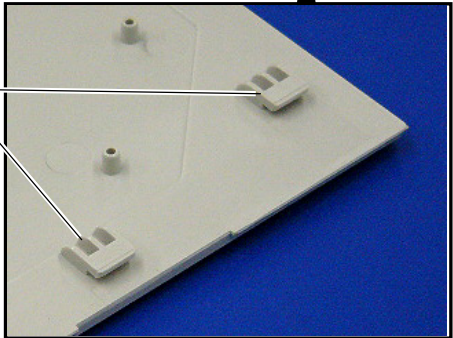
B-SA4TM	B-SA4TP
<p>(1).Open the Top Cover and Front Cover.</p> <p>Top Cover</p> <p>Front Cover</p> 	<p>Open the Top Cover. Slide the Side Panel backward, and then remove it in the direction of arrow A.</p> <p>Top Cover</p> <p>Side Panel</p> <p>A</p> 
<p>(2).Remove the two SMW-3x6 screws which secure the Side Panel.</p> <p>SMW-3x6 Screw</p> <p>Side Panel</p> <p>SMW-3x6 Screw</p> 	<p>Reverse side of Side Panel</p> 
<p>(3).Close the Front Cover and remove the Side Panel.</p> <p>Side Panel</p> 	<p>Hook</p> 

3. Remove the two SMW-3x6 screws to detach the Blind Plate.

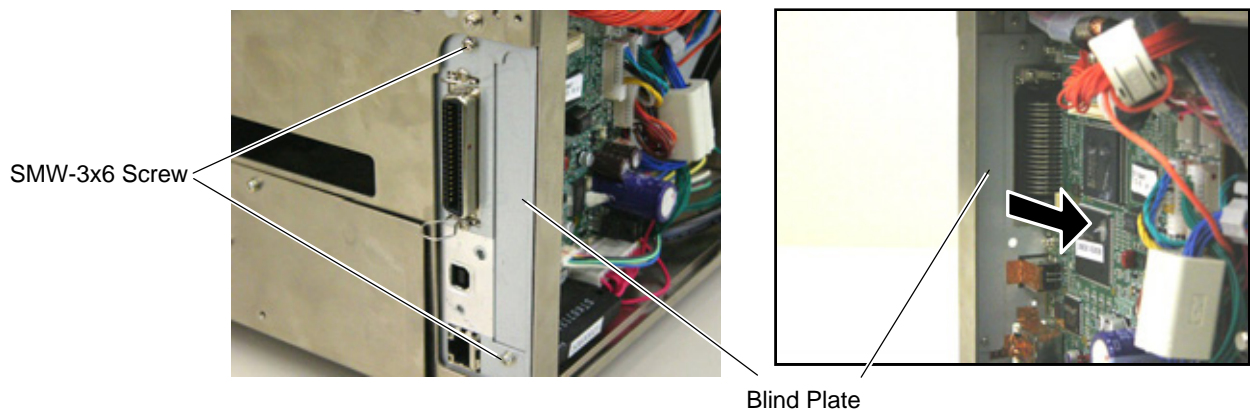

NOTE: Keep the Blind Plate for future use.

4. Attach the Expansion I/O Board to the printer back with one of the supplied SMW-3x6 screws.

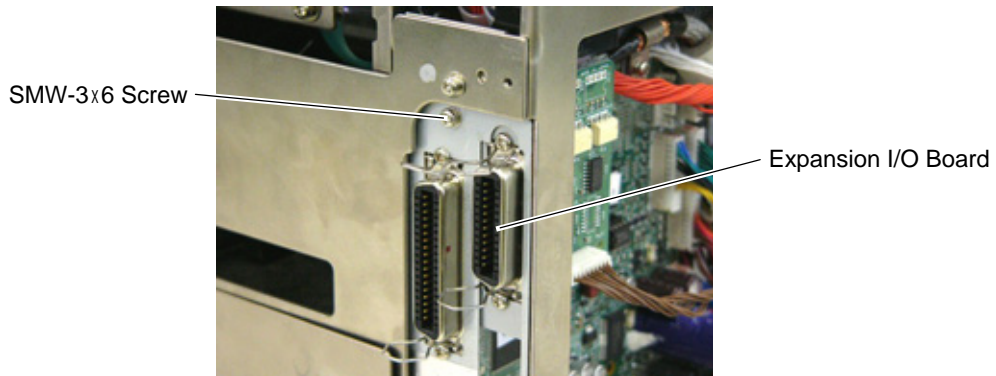

5. Connect the Interface Cable to CN4 on the MAIN PC Board.

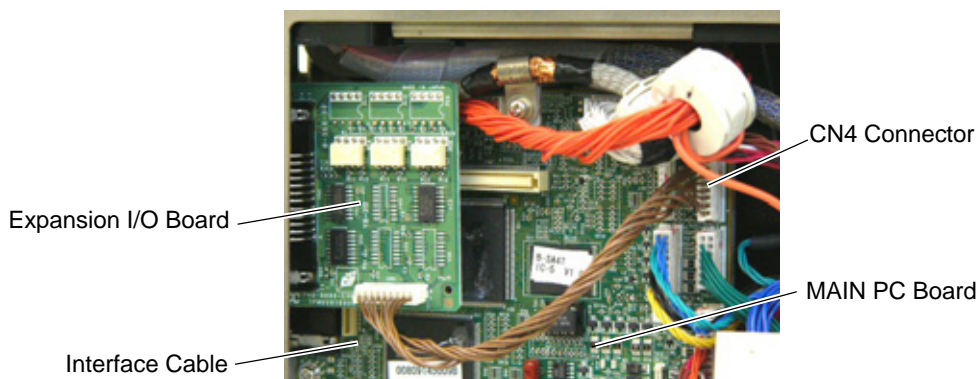

6. Attach the supplied Blind Plate to the printer back with the supplied two SMW-3x6 screws.

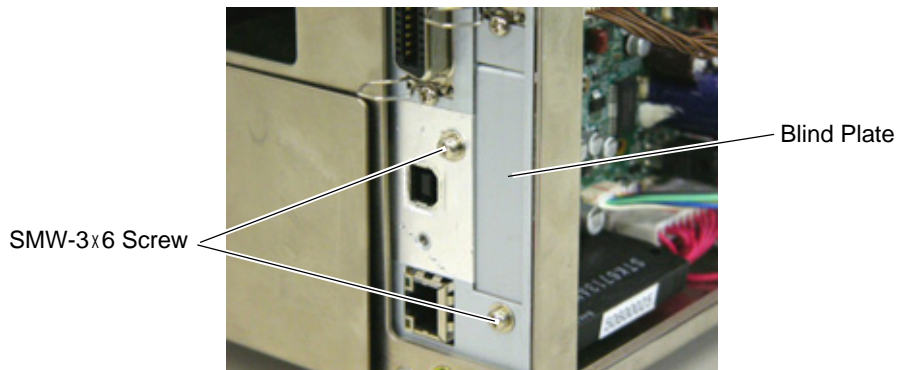

NOTE: The Blind Plate is not required to be attached when the optional Serial Interface Board is also installed.

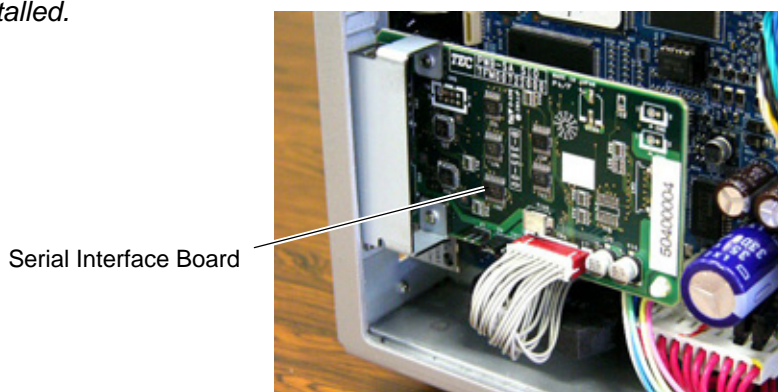

8. Attach the Side Panel, removed in Step 2, back to the printer.

8. RFID Module: B-SA704-RFID-U2-EU-R

This optional device is intended for adding the RFID tag read/write function to the B-SA4TM and B-SA4TP series.

WARNING!

1. Follow all manual instructions. Failure to do so could create safety hazards such as fire or electrocution.
 - Manual instructions must be followed when installing option kits or adding cables to avoid system failures and to insure proper performance and operation.
 - Failure to follow manual instructions or any unauthorized modifications, substitution or change to this product will void the limited product warranty.
2. Turn the power OFF and disconnect the power cord before installing the RFID module.
3. Be careful not to pinch your fingers or hands with the covers.
4. The print head and stepping motor becomes very hot immediately after printing. Do not touch the print head, stepping motor and around it right after printing, or you may get burned.
5. When opening the top cover, it must be fully opened. Failure to do this may cause the top cover to close under its own weight, resulting in an injury.

CAUTION!

Be careful not to damage the pattern of the Antenna Ass'y or peel off the Shield Sheet. Damaged pattern or removed Shield Sheet may affect the ability to read or write RFID tags.

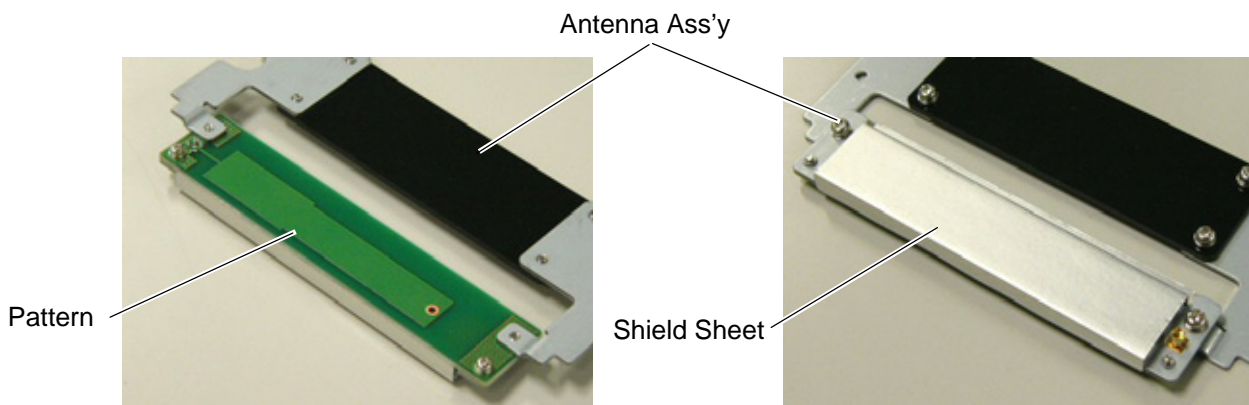

• Applicable Model











This optional device is intended for the following models:

- Notes:**
1. To use this device firmware V1.6 or greater is required. Upgrade the firmware to V1.6 or greater, if necessary. For the downloading procedure, refer to the B-SA4T Series System Mode Manual.
 2. The countries where the use of this device is allowed are as follows:

Model Name	Frequency Band	Applicable Countries
B-SA704-RFID-U2-EU-R	UHF 869.7 to 870.0MHz (Center frequency: 869.85MHz)	Austria, Belgium, Cyprus, Czech, Denmark, Estonia, Germany, Greece, Finland, France, Hungary, Ireland, Italy, Latvia, Lithuania, Luxemburg, Malta, Poland, Portugal, Slovakia, Slovenia, Spain, Sweden, the Netherlands, and U.K.

• **Packing List**

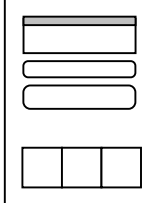
All the following parts are supplied with the kit. Make sure you have all items shown below.

Parts (Quantity)	Parts (Quantity)	Parts (Quantity)
Antenna Ass'y (1 pc.) 	RFID Module (1 pc.) 	Antenna Cable (1 pc.) 
Interface Cable (1 pc.) 	Shield Sheet (for the use of short-pitch tags) (1 pc.) 	RFID Module Attaching Plate (1 pc.) 
Cable Clamp (1 pc.) 	Edge Guard (Long and short: 2 pcs. each) 	Installation Manual (1 copy) 
Tapping Screw M-3x8 (3 pcs.) 	Double Sems Screw M-3x6 (2 pcs.) 	

• Outline of the introduction of an RFID Kit

Please follow the steps below to install the RFID kit, configure various settings, and try data write onto tags.





- (1) Install the RFID kit. (Refer to this section.)
- (2) Set an RFID module type, tag type, etc. in the printer system mode. (Refer to this section or section 2.9 of system mode manual.)
- (3) In the printer system mode, perform a read test to confirm the printer acknowledges the RFID module. (Refer to section 2.9 of system mode manual.)
- (4) Discover an optimum feed amount and output power of the RFID module for data read/write using the RFID Analyze Tool. (Refer to section 5 of system mode manual.)
- (5) Set the feed amount by using an RFID Tag Position Adjustment Command ([ESC]@003) and the output power of the RFID module by using an RFID Parameter Set Command ([ESC]Z2;3) or printer system mode, respectively. For details of the commands, refer to the B-SA4T Series External Equipment Interface Specification.
- (6) Try tag read/write with an application.
- (7) If data write fails, set an AGC threshold. (Refer to this section.)

• Installation Procedure

- 1. Remove the two screws from the back of the printer.

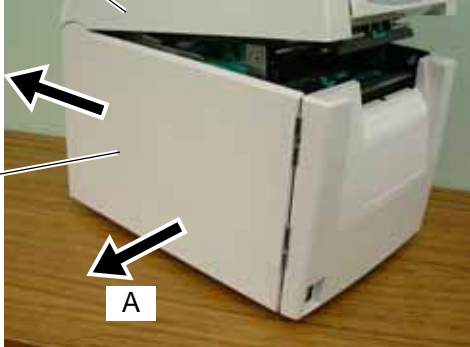

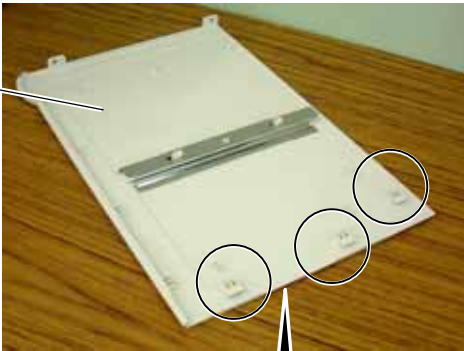
2. Remove the Side Panel in the following order. Please note the procedure is different between the B-SA4TM series and the B-SA4TP series.

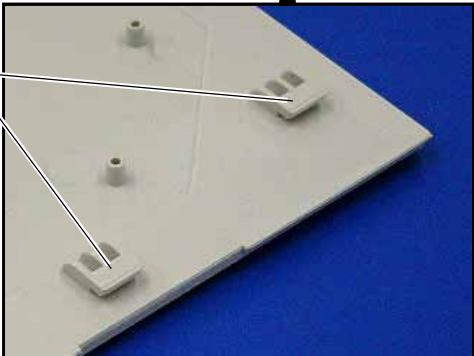
B-SA4TM	B-SA4TP
<p>1. Open the Top Cover and Front Cover.</p>  <p>Top Cover</p> <p>Front Cover</p>	<p>Open the Top Cover. Slide the Side Panel backward, and then remove it in the direction of arrow A.</p>  <p>Top Cover</p> <p>Side Panel</p> <p>A</p>
<p>2. Remove the two SMW-3x6 screws which secure the Side Panel.</p>  <p>Side Panel</p> <p>SMW-3x6 Screw</p> <p>SMW-3x6 Screw</p>	<p>Reverse side of Side Panel</p>  <p>Side Panel</p>
<p>3. Close the Front Cover and remove the Side Panel.</p>  <p>Side Panel</p>	 <p>Hook</p>

- Slightly push the Upper Sensor Lever inside (1), and open the Upper Sensor Ass'y (2).

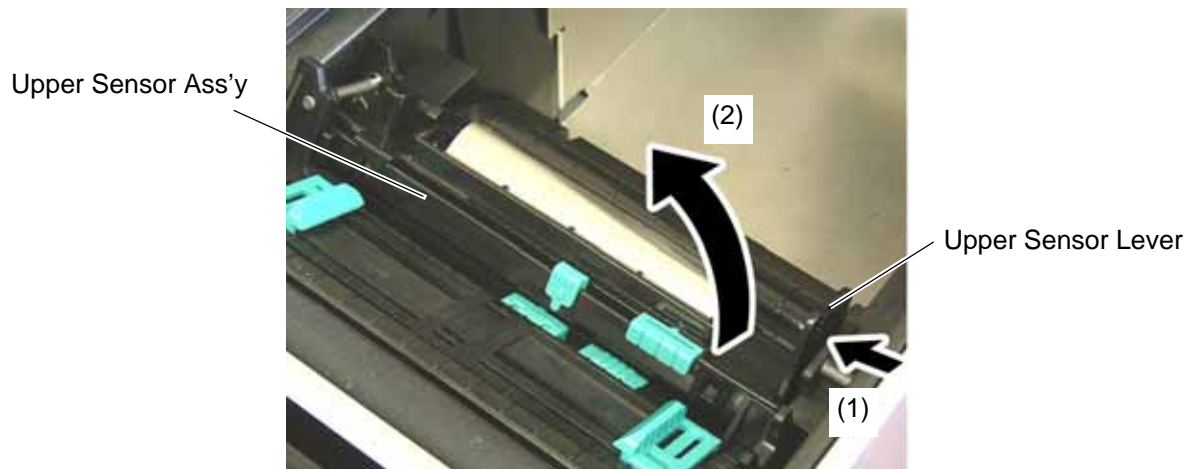

- Pushing the tabs on the rear of the Media Sensor Block toward the front of the printer, slightly lift the back of the Media Sensor Block, and remove it toward the printer back.

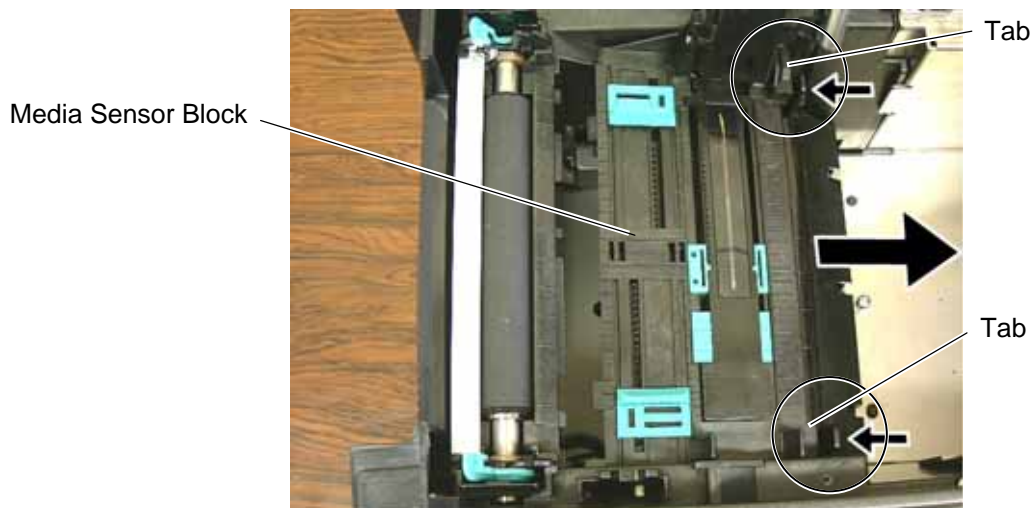

- Turn over the Media Sensor Block, and secure the Antenna Ass'y with the supplied three Tapping Screws.

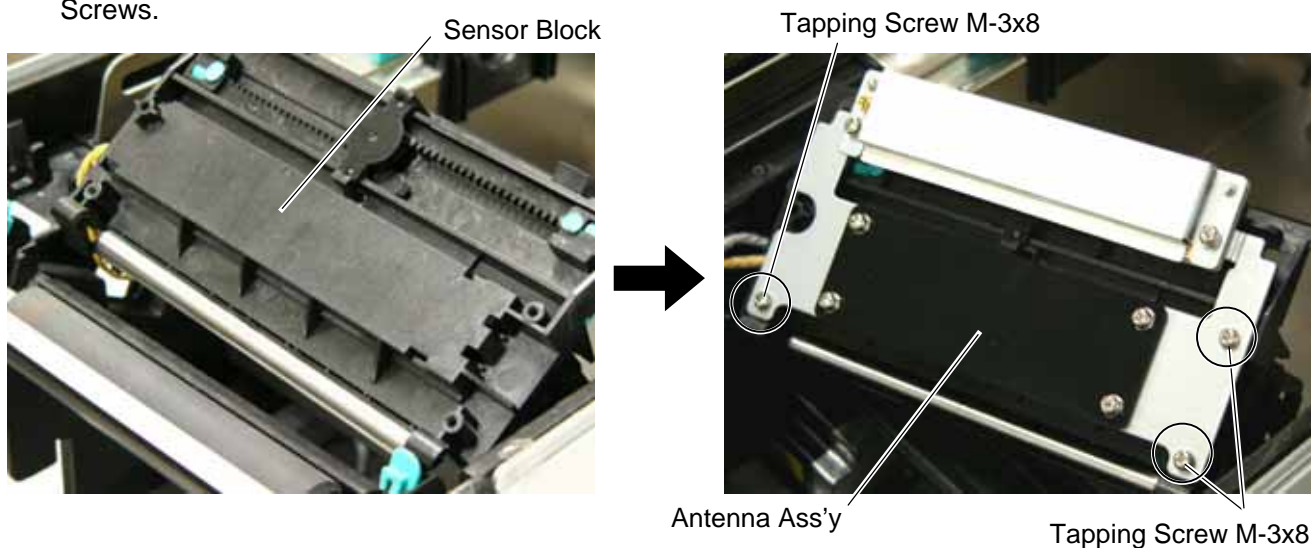

6. As the following picture shows, pass the Interface Cable through the opening behind the Stepping Motor so that the cable reaches the Main PC Board.

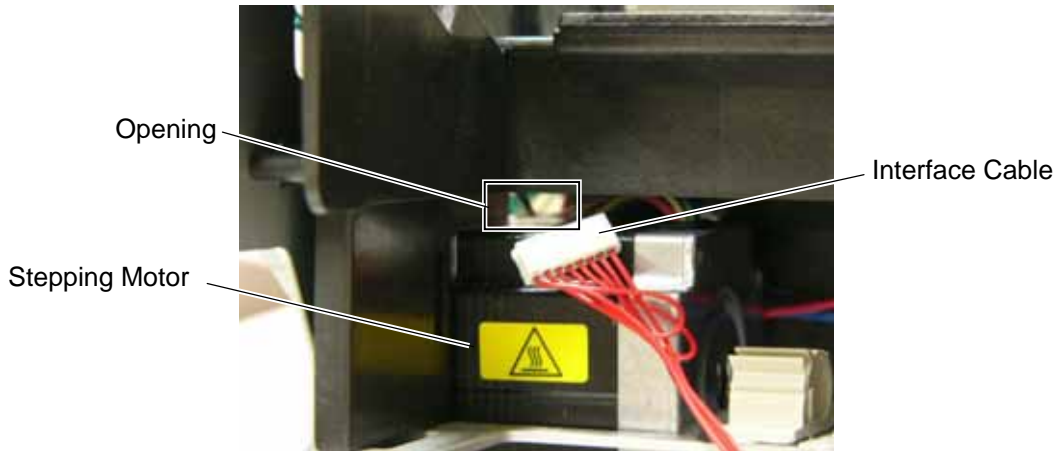

7. Connect the Interface Cable to CN6 on the Main PC Board.

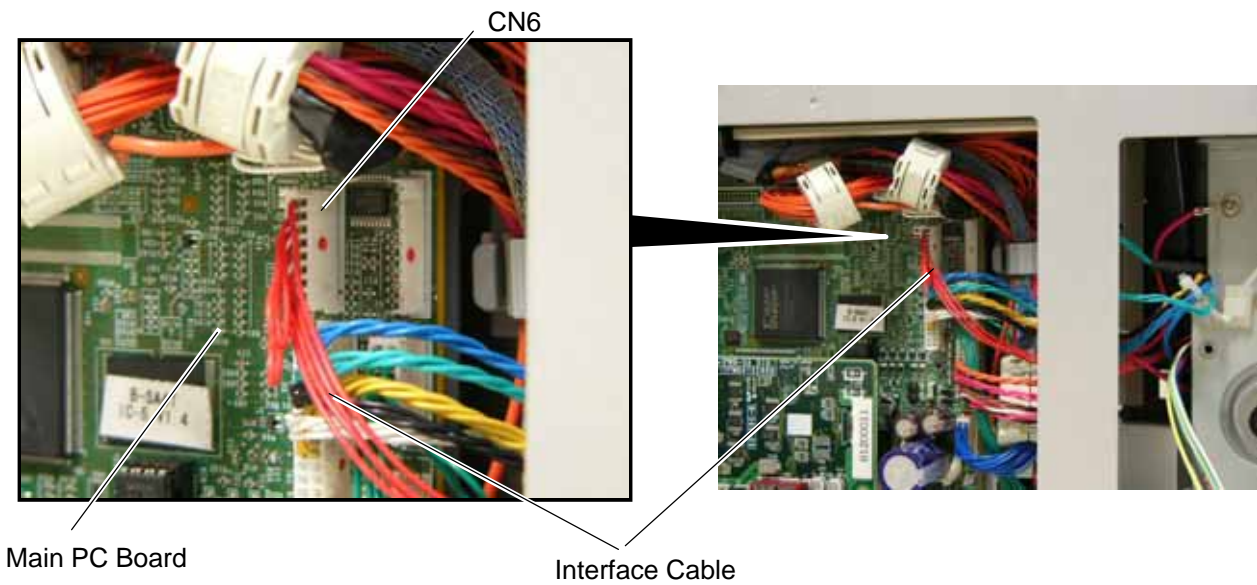

8. Put the Interface Cable on the hooks provided on the Media Path Frame.

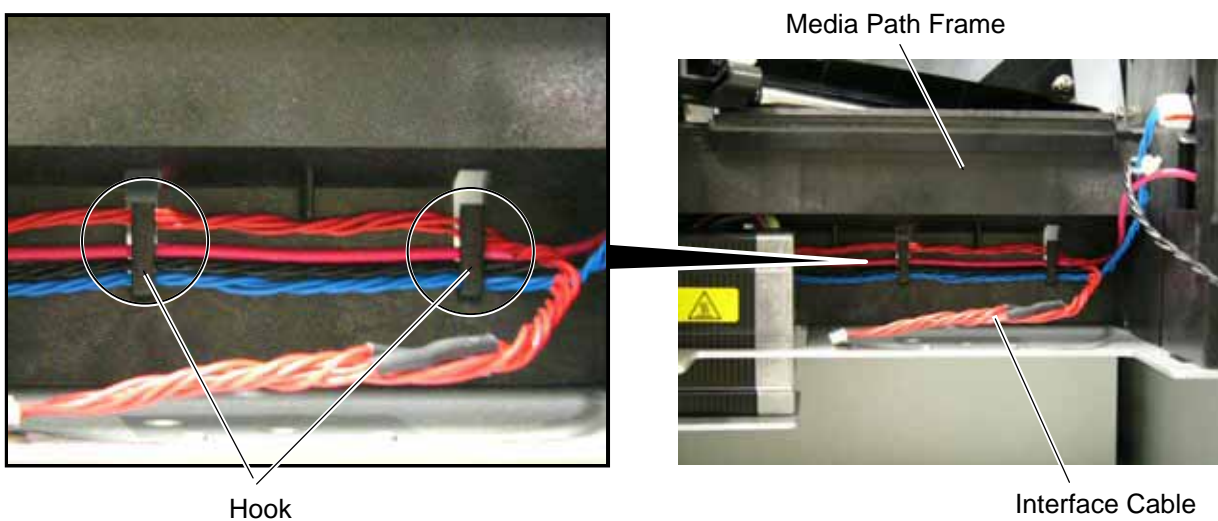

9. Fit the supplied Edge Guards on the metal plate all the way to their bottoms.
- Please be careful not to injure your hands while fitting the Edge Guards.
 - Fit the long Edge Guards and short ones on the correct positions respectively, as indicated in the pictures below.
 - The Edge Guards should not protrude from the edge of the metal plate (portions enclosed with circles).

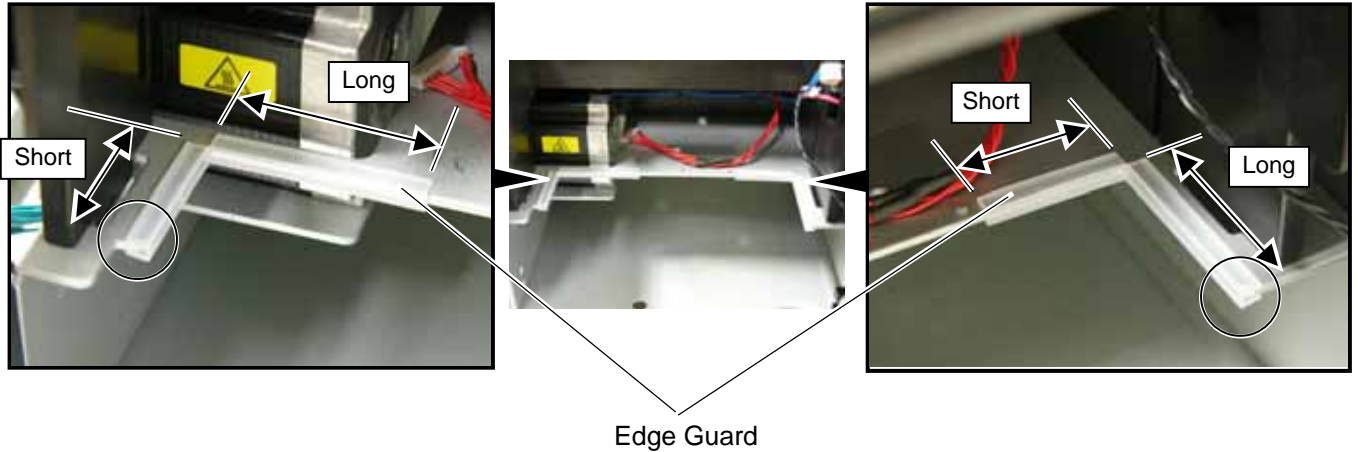

10. Attach the Cable Clamp to the position shown below.

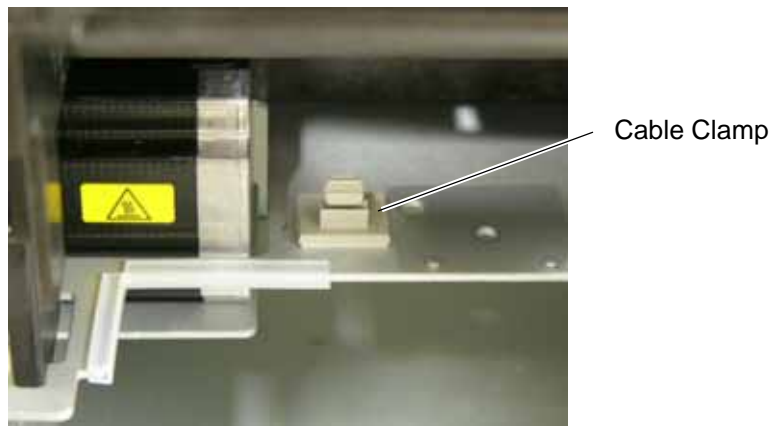

11. Temporarily secure the RFID Module Attaching Plate to the RFID Module with a supplied Double Sems Screw. Connect the Antenna Cable to the RFID Module until it clicks.

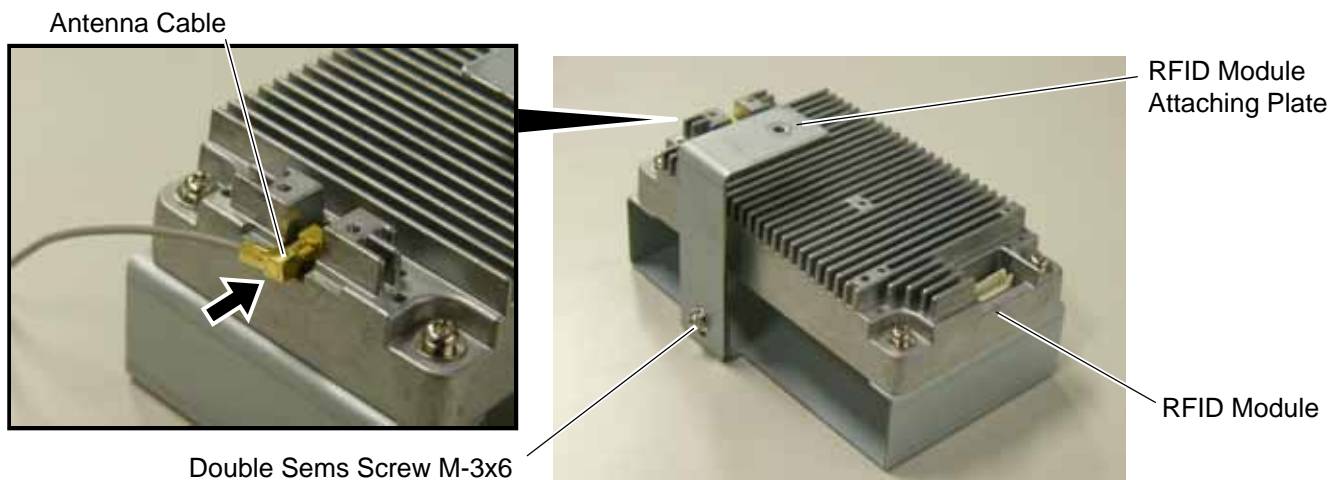

12. Connect the Interface Cable to the RFID Module.

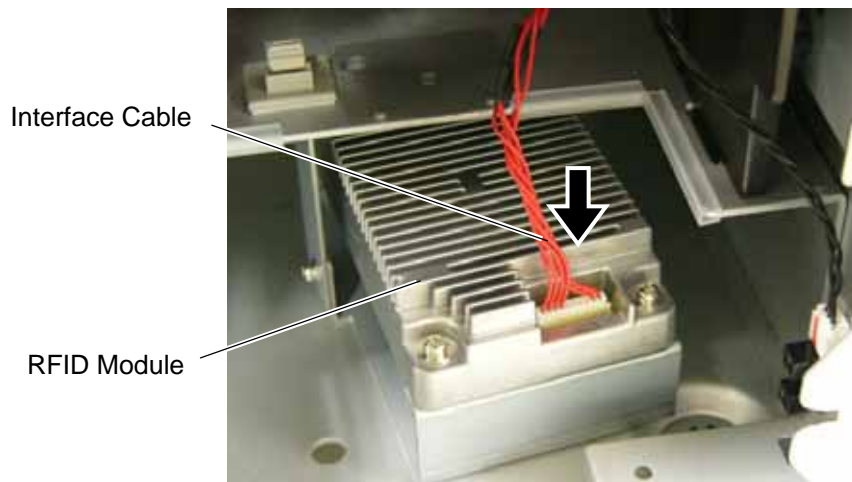

13. Secure the RFID Module to the printer with a supplied Double Sems Screw.

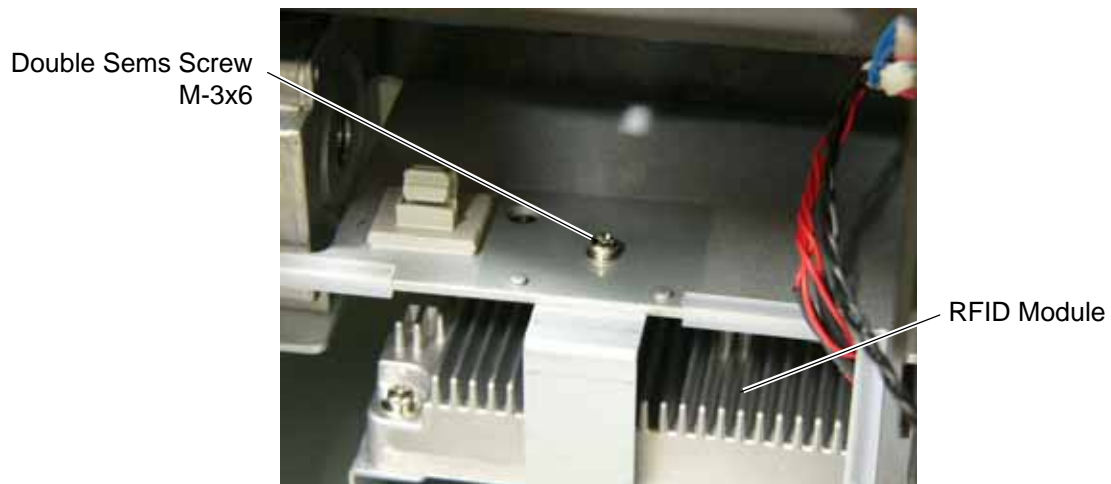

14. While pushing down the RFID Module, tighten the Double Sems Screw, which was temporarily tightened in Step 10, so that there is no clearance between the RFID Module and the Bottom Plate of the printer.

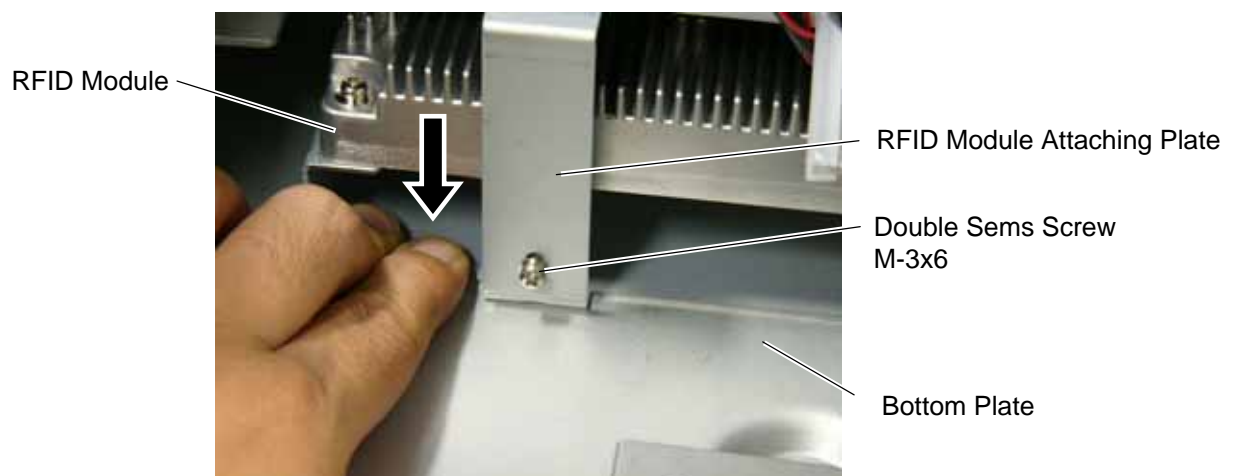

15. Re-place the Media Sensor Block.

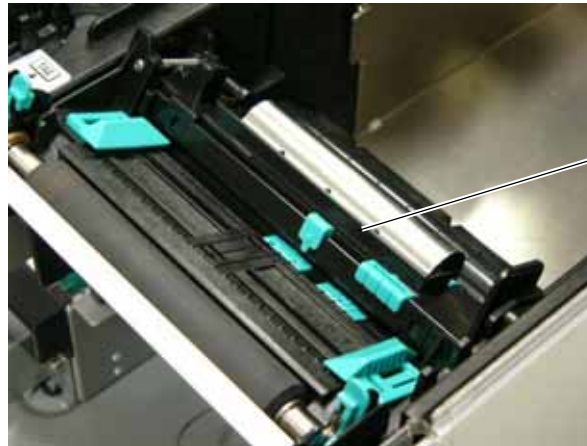

Media Sensor Block

16. Connect the Antenna Cable to the Antenna Ass'y until it clicks, and fasten the Antenna Cable with the Cable Clamp, as shown below.

Antenna Cable

Antenna Ass'y

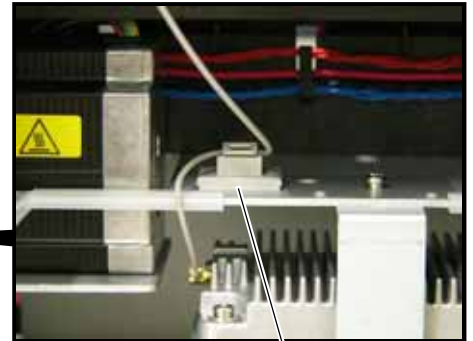
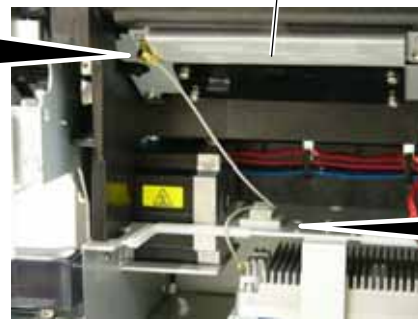
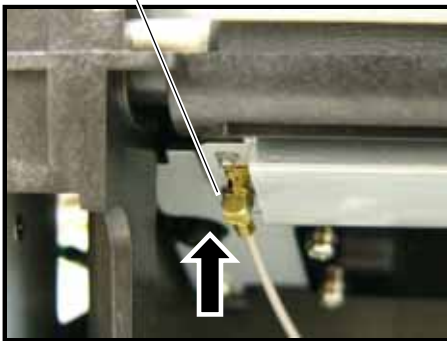

Cable Clamp

17. Reattach the Side Panel to the printer with reference to Step 2.

18. Close the Front Cover and the Top Cover. Now, an installation of the RFID Module has been finished. In the case short-pitch RFID tags (20mm) are used, refer to Section 4 to attach the Shield Sheet and Section 5 to configure the RFID module settings.

When short-pitch tags are not used, refer to Section 5 to configure the RFID module settings.

• When Short-Pitch RFID Tags (20mm) are used:

When short-pitch tags (20 mm) are used, the supplied Shield Sheet needs to be attached for proper read/write operation.

Follow the procedure below to attach the Shield Sheet to the Media Guide Bock.

1. Before attaching the Shield Sheet, move the Media Sensor to the right-most position. Failure to do this disables a media sensor position adjustment.

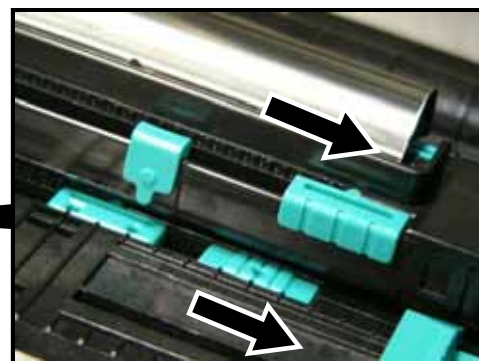
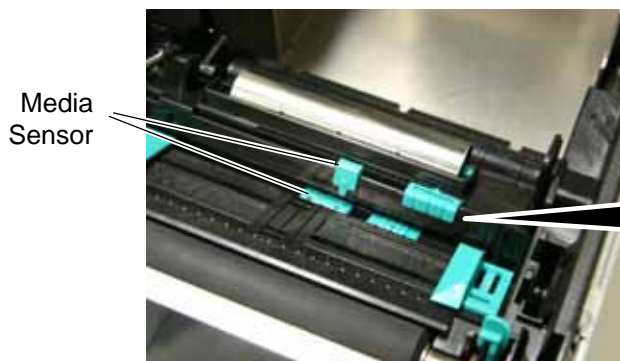

- Insert the Shield Sheet, without the backing paper removed, under the Media Guides from behind, and slightly slide it toward the Platen. Then, move the Media Guides to the width of the Shield Sheet (shorter width), as the pictures show. The purpose of this is to indicate the center of the attachment position.

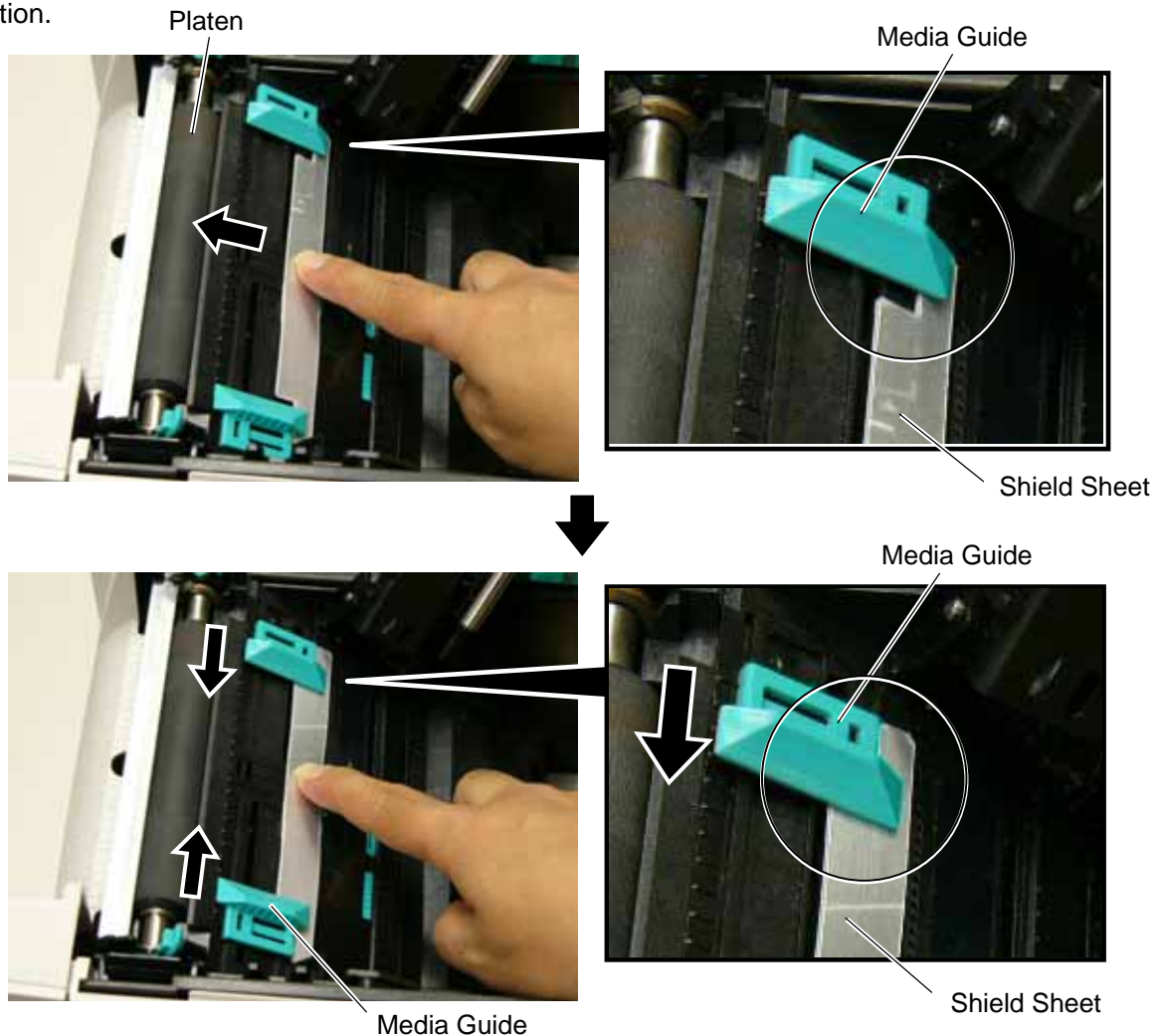

- Remove the backing paper from the Shield Sheet, and attach it to the position determined in the previous step, as indicated in the picture below. Now, the Shield Sheet attachment is completed. Next, refer to Section 5 and configure the RFID module settings.

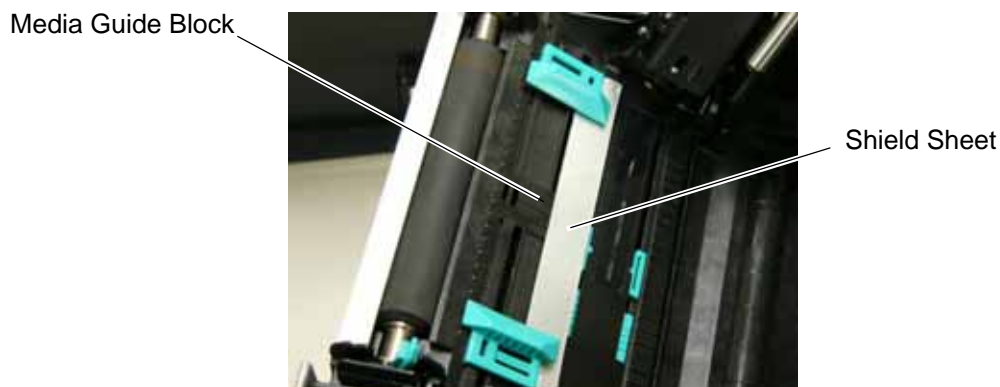

• **RFID Module Settings**

After installing the RFID Module on the printer, configure the RFID module settings using the system mode on the printer.

Turn on the printer while holding down the **[FEED]** and **[PAUSE]** keys at the same time.

<1>DIAG. V1.6

When "<1>DIAG. V1.6" appears on the LCD, press the **[RESTART]** key.

[RESTART]

<10>RFID

RFID setting menu "<10>RFID" is displayed. Press the **[PAUSE]** key.

[PAUSE]

<10>RFID
READ TEST OFF

Read test menu is displayed. Choose whether to perform a read test or not with the **[RESTART]** or **[FEED]** key.

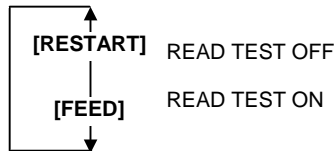

OFF: A read test is not performed. (Initially, choose "OFF".)

ON: A read test is performed.

The printer enters the read test mode, and a read test is performed each time the **[PAUSE]** key is pressed. When the data of a tag can be read, it is displayed on the LCD.

- Read data is displayed in hex. value on the 16-digit x 2-line LCD.

```
1234567890123456
6543210987654321
```

When the RFID tag contains 16 digits or more data, the first 16 digits are displayed. When data volume is less than 16 digits, the vacant digits will be filled with spaces.

- If the tag cannot be read, "RFID TIMEOUT" or "RFID READ ERROR" is displayed.
- If the type of the tag to be read and one selected by the RFID tag type selection do not match, an RFID tag read error will result. Make sure the RFID tag type has been selected before the read test is started.

[PAUSE]

After choosing an option, press the **[PAUSE]** key.

<10>RFID
CAREERSENSE OFF

Carrier sense setting menu is displayed. This menu is not available to the B-SA704-RFID-U2-EU-R. Press the **[PAUSE]** key to skip this menu.

[PAUSE]

<10>RFID
MODULE NONE

Module type setting menu is displayed. Choose "U2" with the **[FEED]** or **[RESTART]** key.

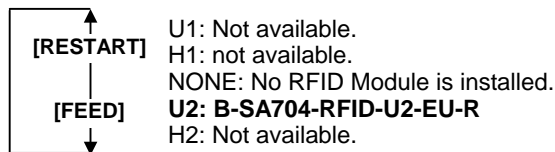

Press the **[PAUSE]** key.

[PAUSE]

Continued to the next page.

Continued from the previous page.

```
<10>RFID
TAG NONE
```

RFID tag type setting menu is displayed.
Choose "EPC C1 Gen2: 24" with the **[FEED]** or **[RESTART]** key.

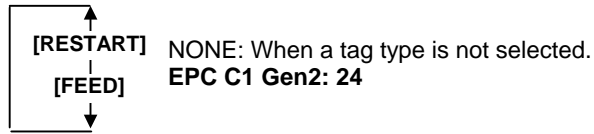

Press the **[PAUSE]** key.

[PAUSE]

```
<10>RFID
ERR CHK OFF
```

RFID error tag detection menu is displayed. Choose whether to perform an error tag detection or not with the **[FEED]** or **[RESTART]** key.

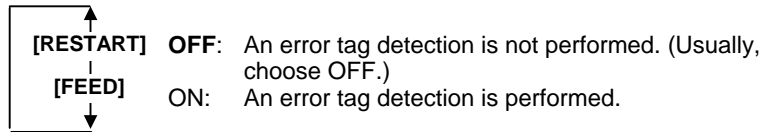

ON: A tag is read before writing data on it, and data is written on the tag only when the header data is "A5A5".
OFF: Though a tag is read before writing data on it, data write is always performed whatever data has been set as the header data.

Press the **[PAUSE]** key.

[PAUSE]

```
<10>RFID
ISSUE RETRY 3
```

Max. number of issue retries setting menu is displayed.
Set the maximum number of retries to issue an RFID tag.
When issuing an RFID tag failed, the printer prints the error pattern, and retries to issue the tag for up to specified number of times. If the printer does not succeed even after having retried for the max. times, the printer stops, resulting in an error.
Choose the max. number of retries with the **[FEED]** or **[RESTART]** key.

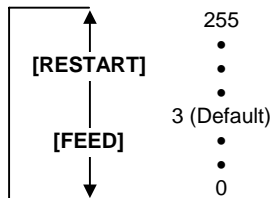

Press the **[PAUSE]** key.

[PAUSE]

```
<10>RFID
R CYCLE CNT 5
```

Max. number of read retries setting menu is displayed.
Set the maximum number of retries to read an RFID tag.
The printer retries to read the data in an RFID tag for up to specified number of times. If the timeout period expired before the max. number retries have been done, the printer stops the retries at the time.

Whenever the printer writes data onto an RFID tag, the tag is read first. The max. number of retries set by this parameter becomes also effective in this pre-read.

Choose the max. number of retries with the **[FEED]** or **[RESTART]** key.

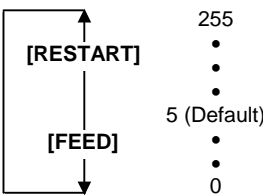

Press the **[PAUSE]** key.

[PAUSE]

Continued to the next page.

Continued from the previous page.

```
<10>RFID
R CYCLE TIM  4.0
```

[PAUSE]

```
<10>RFID
W CYCLE CNT  5
```

[PAUSE]

```
<10>RFID
W CYCLE TIM  2.0
```

[PAUSE]

Continued to the next page.

Read retry timeout setting menu is displayed.

Set the timeout period during which RFID tag read retries are allowed, with the [FEED] or [RESTART] key. If the printer has retried for the max. number of times within the RFID read retry timeout, the printer stops the retries at the time.

Whenever the printer writes data onto an RFID tag, the tag is read first. The read retry timeout set by this parameter becomes also effective in this pre-read.

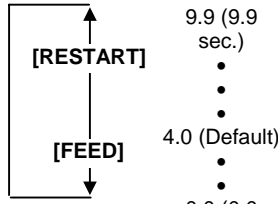

Press the [PAUSE] key.

Max. number of write retries setting menu is displayed.

Set the maximum number of retries to write data onto an RFID tag.

The printer retries to write data onto an RFID tag for up to specified number of times. If the timeout period expired before the max. number of retries have been done, the printer stops the retries at the time.

Set the max. number of times with the [FEED] or [RESTART] key.

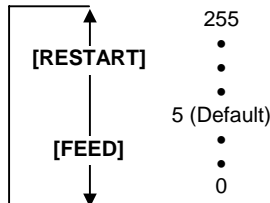

Press the [PAUSE] key.

Write retry timeout setting menu is displayed.

Set the timeout period during which RFID tag write retries are allowed, with the [FEED] or [RESTART] key.

If the printer has retried for the max. number of times within the RFID write retry timeout, the printer stops the retries at the time.

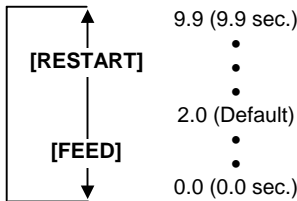

Press the [PAUSE] key.

Continued from the previous page

<10>RFID
ADJ RETRY +00

RFID adjustment for retry menu is displayed.
If writing data on a tag failed, the printer feeds the RFID tag forward or backward for specified length in order to retry writing data. When "0" is set for this parameter, this function and a retry are not performed.
Only the value of -3mm or less or +3mm or more becomes effective.
Set a value to move the RFID tag position with the **[FEED]** or **[RESTAT]** key.

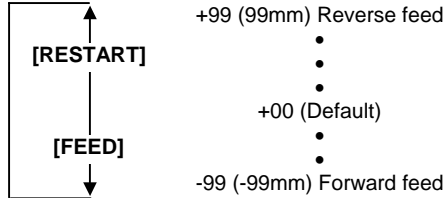

Press the **[PAUSE]** key.

[PAUSE]

<10>RFID
POWER LEVEL 18

Radio output power level setting menu is displayed.
When the value is "9", the power is the weakest, and when "18", the power is the strongest. The factory default setting is "18". The optimum value differs depending on the tag types. Usually, it is not necessary to change this value but changing the value may be able to increase the number of successful read/write times.
Set the power level with the **[FEED]** or **[RESTART]** key.

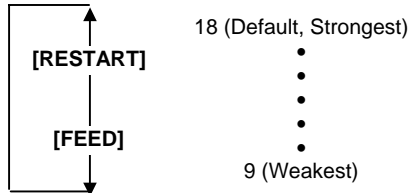

Press the **[PAUSE]** key.

[PAUSE]

<10>RFID
AGC THRESHOLD 0

AGC threshold setting menu is displayed.
When the obtained gain of an RFID tag is lower than the AGC threshold, the tag is considered as an error tag even if a data write succeeds.
When the AGC threshold is set to "0", all tags are writable.
When set to "8", for example, only tags with the AGC threshold level of 9 or greater are writable. The optimum value is different depending on the tag types. The factory default is 0.
Set an AGC threshold with the **[FEED]** or **[RESTART]** key.

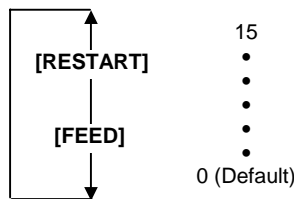

Press the **[PAUSE]** key.

[PAUSE]

<10>RFID
RF CHANNEL AUTO

RFID channel setting menu is not available to the B-SA704-RFID-U2-EU-R.

Press the **[PAUSE]** key to skip this menu.

[PAUSE]

Continued to the next page.

Continued from the previous page.

```
<10>RFID
Q VALUE  2
```

Q value setting menu is displayed.

In the case multiple RFID tags are read at the same time, this menu is useful to pinpoint a target tag.

Set the Q value to "1" or greater (2 is recommended.) with the **[FEED]** or **[RESTART]** key. Q value "0" causes the tags to interfere with each other and disables proper data write.

When a Q value is set, set an AGC threshold for data write and an AGC threshold lower limit for retry, also. Setting all these values enable writing data to a tag placed just above the antenna. (For details, refer to Section 6. AGC Threshold Setting.)

The factory default is 2.

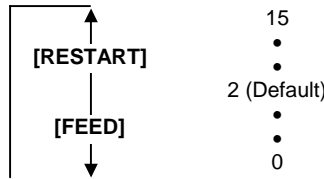

[PAUSE]

Press the **[PAUSE]** key.

```
<10>RFID
WT AGC  11
```

AGC threshold for data write setting menu is displayed.

When the Q value is set to 1 or greater, the AGC threshold for data write becomes effective.

When the obtained gain of an RFID tag is lower than the AGC threshold for data write, data write is not performed. In other words, setting an AGC threshold for data write enables writing data only to a tag placed just above the antenna.

The optimum value differs depending on the tag type.

(For details, refer to Section 6. AGC Threshold Setting.)

Set an AGC threshold for data write with the **[FEED]** or **[RESTART]** key, if necessary.

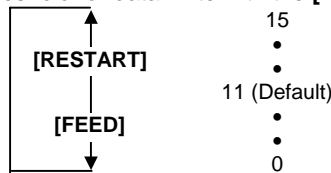

[PAUSE]

Press the **[PAUSE]** key.

```
<10>RFID
WT MIN AGC  11
```

AGC threshold lower limit for retry setting menu is displayed.

When the Q value is set to 1 or greater, the AGC threshold lower limit for retry becomes effective.

When there are tags of which AGC values fall within the range between the AGC threshold for data write and the lower limit, the printer retries data write for a tag with the highest AGC value among those tags. When printer retries data write, that value is then used as an AGC threshold.

The optimum value differs depending on the tag type.

(For details, refer to Section 6. AGC Threshold Setting.)

Set the lower limit for retry with the **[FEED]** or **[RESTART]** key, if necessary.

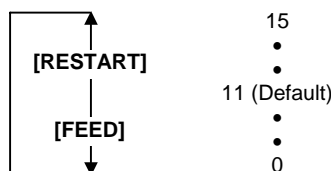

[PAUSE]

Press the **[PAUSE]** key.

```
<10>RFID
```

The LCD message returns to "<10>RFID".

Now, the RFID module settings are completed. If data write to RFID tags cannot be properly performed, refer to Section 5.

• **AGC Threshold Setting**

The B-SA704-RFID-U2-EU-R chooses a tag to write data on according to a radio intensity of RFID tags (AGC value).

An AGC threshold value has been set to 11 (0Bh) as factory default, but it may be necessary to change this value according to the tag type to be used.

When the factory default threshold value is not proper for the tag type used, follow the procedure below to configure the following settings.

As the changes are stored in the internal memory, they are retained after the printer power is turned off and on again. When the tag type is changed or data write cannot be operated properly, perform the setting again.

- Step 1. Load an RFID tag embedded media in the printer.
- Step 2. Follow the procedure below to measure the radio intensity of the tags.
 - 1) Place the media so that an RFID tag (IC chip) is positioned above the Antenna, and close the Top Cover.

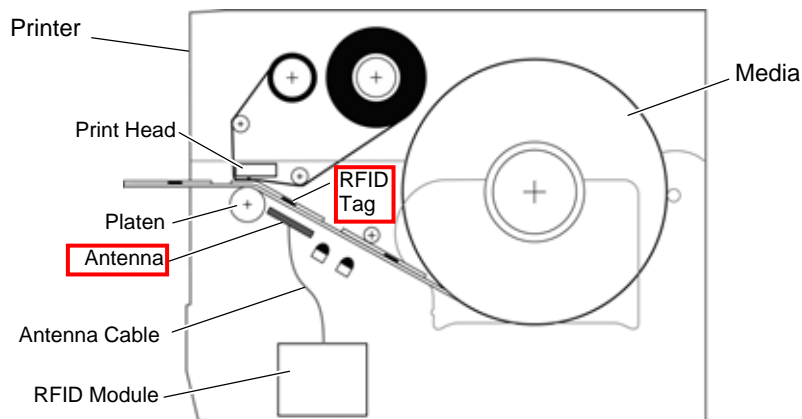

Note: If an RFID tag is not positioned above the Antenna while the Print Head is at a print start position, use @003 command to adjust the media position so that an RFID tag is positioned above the Antenna. For detail of the command, refer to the External Equipment Interface Specification (Printer Command Manual).

- 2) Start the printer in the system mode and perform a read test to measure the AGC value.

Example Turn the printer on while holding down the [FEED] and [PAUSE] keys at the same time.

```

<1>DIAG. V1.6
  |
  | [RESTART]
  |
<10>RFID
  |
  | [PAUSE]
  |
<10>RFID
  |
  | READ TEST OFF
  |
  | [FEED] or [RESTAT]
  |
<10>RFID
  |
  | READ TEST ON
  |
  | [PAUSE]
  |
<10>RFID
  |
  | READING...
  
```

When "<1>DIAG. V1.6" is displayed, press the [RESTART] key.

When "<10>RFID" is displayed, press the [PAUSE] key.

Read test menu is displayed. Press the [FEED] or [RESTAT] key to choose "READ TEST ON".

Press the [PAUSE] key to implement a read test.

Continued to the next page

Continued from the previous page

```
3132333435363738
39304142 (0A)
```

Read data is displayed.

[FEED], [RESTART]

Data in parentheses () is the AGC value expressed in hex. code. Write down this value.

```
<10>RFID
```

Press the [FEED] and [RESTART] keys to return to the RFID Setting Menu ("<10>RFID").

3) Set an AGC threshold of data write.

Set a value which is lower than the AGC value obtained by a read test by 1 or 2, taking variation of RFID tags in performance into consideration.

Example

```
<10>RFID
```

When "<10>RFID" is displayed, press the [PAUSE] key until the Q value setting menu is displayed.

[PAUSE]

Choose "2" with the [FEED] or [RESTART] key.

```
<10>RFID
Q VALUE 2
```

When "2" is already chosen, go to the AGC threshold for data write setting menu.

[FEED] or [RESTART]

```
<10>RFID
Q VALUE 2
```

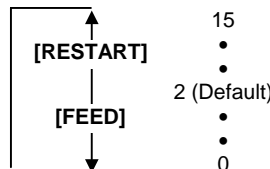

[PAUSE]

Press the [PAUSE] key.

```
<10>RFID
WT AGC 11
```

AGC threshold for data write setting menu is displayed.

Choose a threshold value (decimal number) with the [FEED] or [RESTART] key.

[FEED] or [RESTAT]

When the measured AGC is 10 (0A), for example, choose "9" (a value lower than the measured AGC by 1 or 2).

```
<10>RFID
WT AGC 9
```

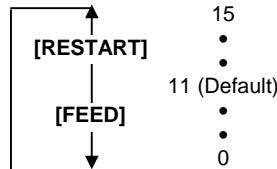

[PAUSE]

Press the [PAUSE] key.

```
<10>RFID
WT MIN AGC 11
```

AGC threshold lower limit for retry setting menu is displayed.

Choose a lower limit (decimal number) with the [FEED] or [RESTART] key.

[FEED] or [RESTAT]

Usually, choose the same value with the AGC threshold for data write (WT AGC).

```
<10>RFID
WT MIN AGC 9
```

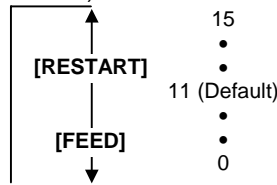

[PAUSE]

Press the [PAUSE] key.

```
<10>RFID
```

RFID Setting Menu ("<10>RFID") is displayed.

An AGC threshold setting is completed.

• Identification of The Rfid Module (B-SA704-RFID-U2-EU-R)

As from the production manufactured in October 2008, the standard label has been added to the RFID module, which is used for the B-SA4T series, for improving the efficiency of assembly.

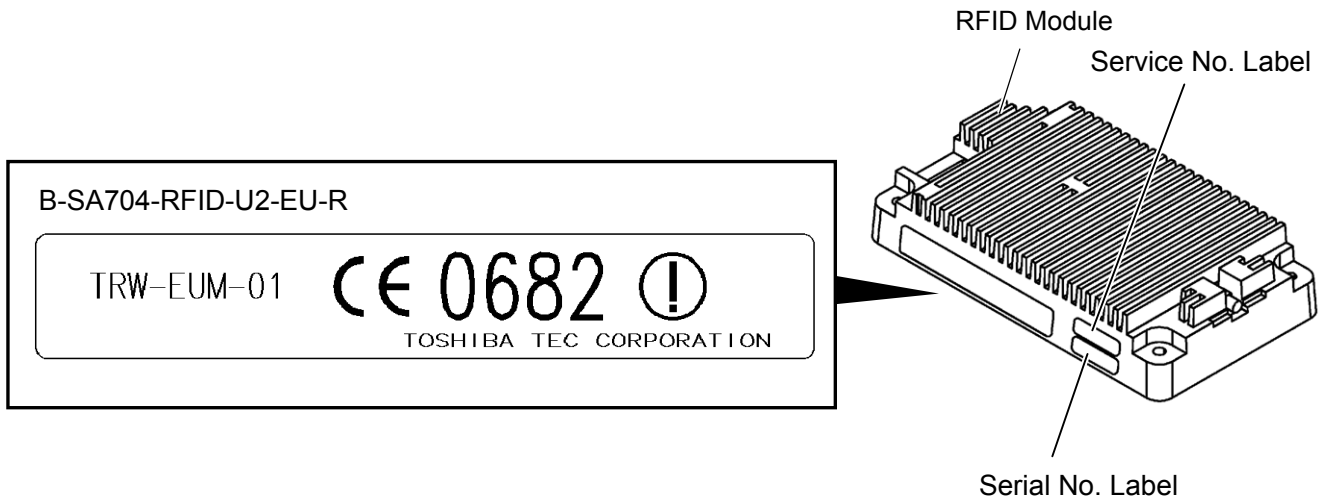

Note: *Descriptio of the serial number label and service number label*

Description of Service Number Label

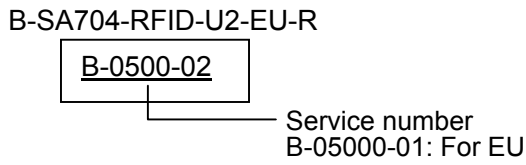

Description of Serial Number Label

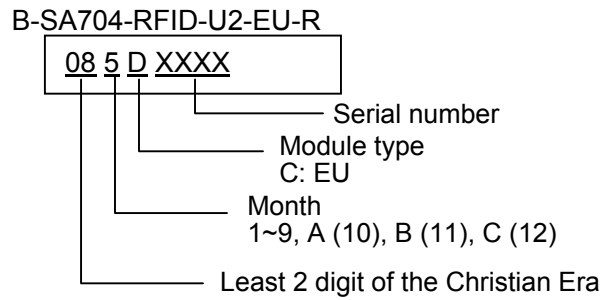

Free Manuals Download Website

<http://myh66.com>

<http://usermanuals.us>

<http://www.somanuals.com>

<http://www.4manuals.cc>

<http://www.manual-lib.com>

<http://www.404manual.com>

<http://www.luxmanual.com>

<http://aubethermostatmanual.com>

Golf course search by state

<http://golfingnear.com>

Email search by domain

<http://emailbydomain.com>

Auto manuals search

<http://auto.somanuals.com>

TV manuals search

<http://tv.somanuals.com>