



# INSTALLATION AND OPERATION MANUAL

## Direct-Vent Gas Fireplace Inserts

### ELITE™ SERIES

The Ravenna™ fireplace insert is factory equipped for 40,000 BTU input and can be converted to 33,000 using the smaller orifice provided.

### Retain These Instructions For Future Reference

P/N 775,218M Rev. B, 12/2007

A French manual is available upon request. Order P/N 775,218CF. Ce manuel d'installation est disponible en français, simplement en faire la demande. Numéro de la pièce 775,218CF.

In the Commonwealth of Massachusetts:

- Installation must be performed by a licensed plumber or gas fitter
- See Table of Contents for location of additional Commonwealth of Massachusetts requirements

Tested & Listed By  Beaverton Oregon USA  
OMNI-Test Laboratories, Inc.  
Report No. 050-S-15c-5



Shown with Cast Pillar face

## Ravenna™ 33/40 (RDV33/40)



### ⚠ WARNINGS



- **Hot! Do not touch!** The glass and surfaces of this appliance will be hot during operation and will retain heat for a while after shutting off the appliance. Severe burns may result.
- **Carefully supervise children** in the same room as appliance.
- **Suitable for installation into masonry or factory built fireplaces.** These appliances may be installed in an after-market permanently located, manufactured (mobile) home (USA only), where not prohibited by local codes. This appliance is only for use with the type of gas indicated on the rating plate. This appliance is not convertible for use with other gases unless a certified kit is used.
- **Lennox™ gas-burning appliances are designed for use as a supplemental heater.** They are not intended for continuous use as a primary heat source.

**WARNING:** If the information in this manual is not followed exactly, a fire or explosion may result causing property damage, personal injury or loss of life.

Do not store or use gasoline or other flammable vapors or liquids in the vicinity of this or any other appliance.

#### WHAT TO DO IF YOU SMELL GAS:

- Do not light any appliance.
- Do not touch any electrical switch; do not Use any phone in your building.
- Immediately call your gas supplier from a neighbor's phone. Follow your gas supplier's instructions.
- If your gas supplier cannot be reached, call the fire department.

Installation and service must be performed by a qualified installer, service agency or the gas supplier.

**AVERTISSEMENT:** Assurez-vous de bien suivre les instructions données dans cette notice pour réduire au minimum le risque d'incendie ou d'explosion ou pour éviter tout dommage matériel, toute blessure ou la mort.

**POUR VOTRE SÉCURITÉ:** Ne pas entreposer ni utiliser d'essence ni d'autres vapeurs ou liquides inflammables à proximité de cet appareil ou de tout autre appareil.

**POUR VOTRE SÉCURITÉ:** Que faire si vous sentez une odeur de gaz:

- Ne pas tenter d'allumer d'appareil.
- Ne touchez à aucun interrupteur.
- Ne pas vous servir des téléphones se trouvant dans le bâtiment
- Appelez immédiatement votre fournisseur de gaz depuis un voisin. Suivez les instructions du fournisseur.
- Si vous ne pouvez rejoindre le fournisseur de gaz, appelez le service des incendies.

L'installation et l'entretien doivent être assurés par un installateur ou un service d'entretien qualifié ou par le fournisseur de gaz.



# CAUTIONS & SAFETY



- ◆ **FOR YOUR SAFETY** do not install or operate your Ravenna™ gas insert without first reading & understanding this manual. Any installation or operation of the appliance deviating from that which is stated in this manual WILL void the warranty & may be hazardous.
- ◆ **INSTALLATION & REPAIR SHOULD ONLY BE DONE BY A QUALIFIED SERVICE TECHNICIAN. DO NOT ATTEMPT TO SERVICE THE APPLIANCE YOURSELF.**
- ◆ The insert should be inspected & cleaned before use & at least annually by a qualified service technician. More frequent cleaning may be required due to excessive lint from bedding material, carpeting, etc.
- ◆ It is imperative that control compartments, burners, & circulating air passageways of the room heater be kept clean.
- ◆ Adequate clearances around the combustion chamber and accessibility clearances for servicing & proper operation must be maintained.
- ◆ Turn off the gas before servicing this appliance. It is recommended that a qualified service technician perform an appliance check-up at the beginning of each heating season.
- ◆ All installations must conform with all local, state, & national codes. In the absence of local codes, the installation must conform with National Fuel Gas Code ANSI Z223.1-latest edition, also known as NFPA 54 (In Canada, the current CAN/CSA B149.1 installation code). Refer to the National Fuel Gas Code & local zoning & code authorities for details on installation requirements. Your Ravenna gas insert must be vented to the outside in accordance with the latest edition of the National Fuel Gas Code.
- ◆ This gas insert **MUST** be vented directly to the outside & **MUST NEVER** be attached to a chimney serving a separate solid fuel burning appliance. Each gas appliance **MUST USE** a separate vent system. Common vent systems are **PROHIBITED**.
- ◆ Mobile home installations must conform with the Mobile Home Construction and Safety Standard, Title 24 CFR, Part 3280 (in Canada CAN/CSA Z240 MH), or, when such a standard is not applicable, the Standard for Mobile Home Installations, ANSI A225.1 - latest edition.
- ◆ The appliance, when installed, must be electrically grounded in accordance with local codes or in the absence of local codes, with the National Electrical Code, ANSI/NFPA 70 - latest edition. In Canada, the current CSA C22-1 Canadian Electrical Code - latest edition.
- ◆ Do not make any make-shift compromises during installation. Any modification or alteration may result in damage to the appliance or dwelling and will void the warranty, certification and listings of this unit.
- ◆ Failure to use manufacturer provided parts, variations in techniques and construction materials or practices other than those described in this manual may create a fire hazard and void the limited warranty.
- ◆ Your Lennox™ gas insert must be equipped for the proper fuel type & altitude at which it will be operated. Any operation outside the parameters outlined in this manual may result in a hazardous condition & will void the warranty. Please carefully read the sections pertaining to these subjects and/or be sure your appliance is properly equipped.
- ◆ Do not use this insert if any part has been under water. Immediately call a qualified service technician to inspect the appliance & to replace any part of the control system & any gas control which has been under water.
- ◆ Due to high temperatures, the insert should be located out of traffic areas & away from furniture & draperies.
- ◆ Children & adults should be alerted to the hazards of high surface temperature & should stay away to avoid burns or clothing ignition. Young children should be carefully supervised when they are in the same room as the Lennox gas insert. Clothing or any other flammable material should not be placed on or near the insert.
- ◆ Never use solid fuels such as wood, paper, cardboard, coal, or any flammable liquids, etc., in this appliance.
- ◆ Any grill, panel, or glass removed for service **MUST** be replaced prior to operating the insert. Do not operate appliance with the glass front removed, cracked or broken. Replacement of the glass should be done by a qualified service technician.
- ◆ **DO NOT USE** abrasive cleaner on the glass door assembly. **DO NOT ATTEMPT** to clean the glass door when it is hot.
- ◆ Gold & nickel plated surfaces must be cleaned with glass cleaner & a clean soft cloth before firing the first time or fingerprints will remain permanently. **NEVER** use brass polish to clean gold or nickel, this will remove the plating!!!
- ◆ When opening the lower door on the face while the insert is burning, pull at the far left or far right vent openings, because the door is hot during operation.
- ◆ Lennox Hearth Products, its employees, or any of its representatives assume no responsibility for any damages caused by an inoperable, inadequate, or unsafe condition as a result of any improper operation, service or installation procedures, whether direct or indirect.
- ◆ **INSTALLER: THESE INSTRUCTIONS ARE TO REMAIN WITH THE HOME OWNER!**

# Table of Contents

<b>CAUTIONS &amp; SAFETY</b> .....	2
<b>ORIFICE SIZE / ALTITUDE ADJUSTMENT</b> .....	4
<b>FIREPLACE REQUIREMENTS</b> .....	4
<b>CODES &amp; APPROVALS</b> .....	4
<b>NEW YORK CITY, NEW YORK (MEA)</b> .....	5
<b>REQUIREMENTS FOR THE COMMONWEALTH OF MASSACHUSETTS</b> .....	5
<b>PRE-INSTALLATION</b> .....	6-8
<b>FEATURES</b> .....	6
<b>PACKAGING LIST</b> .....	6
<b>RATINGS</b> .....	6
<b>INSERT &amp; FIREPLACE DIMENSIONS</b> .....	7
<b>CLEARANCES TO COMBUSTIBLES</b> .....	8
<b>INSERT LEVELING</b> .....	8
<b>INSTALLATION</b> .....	9-11
<b>VENTING INSTALLATION</b> .....	9
<b>ZERO CLEARANCE FIREPLACE INSTALLATION</b> .....	10
<b>BRICK PANEL &amp; LOG SET INSTALLATION</b> .....	10
<b>SURROUND PANELS INSTALLATION</b> .....	11
<b>FACE INSTALLATION</b> .....	11
<b>GAS LINE INSTALLATION</b> .....	12
<b>GAS PRESSURE REQUIREMENTS</b> .....	12
<b>LP &amp; NATURAL GAS SUPPLIES</b> .....	12
<b>AIR SHUTTER ADJUSTMENT</b> .....	12-13
<b>OPERATING INSTRUCTIONS</b> .....	13-16
<b>PRE-LIGHTING CHECKLIST</b> .....	13
<b>LIGHTING INSTRUCTIONS</b> .....	13
<b>FLAME COLOR &amp; BEHAVIOR</b> .....	15
<b>PAINT CURING</b> .....	15
<b>QUIET OPERATION</b> .....	15
<b>BLOWER OPERATION</b> .....	15
<b>OPTIONAL WALL THERMOSTAT</b> .....	15
<b>OPERATING OPTIONS</b> .....	16
<b>MILLIVOLT CONTROL SYSTEM</b> .....	16
<b>MAINTENANCE &amp; SERVICING</b> .....	17-18
<b>MAINTENANCE CHECKLIST</b> .....	17
<b>GLASS MAINTENANCE</b> .....	17
<b>DOOR REMOVAL</b> .....	18
<b>FUEL CONVERSION</b> .....	18
<b>BLOWER REMOVAL</b> .....	18
<b>TROUBLESHOOTING</b> .....	19
<b>REPLACEMENT PARTS</b> .....	20
<b>ACCESSORIES</b> .....	20-21
<b>INSERT LABELS</b> .....	22-23
<b>PRODUCT REFERENCE INFORMATION</b> .....	24

## Orifice Size/Altitude Adjustment

For altitudes above 2,000 feet (In Canada 4,500 FT/1370 M), the orifice should be de-rated by 4% for every 1,000 feet to maintain the proper ratio of gas to air. Improper orifice sizing may result in damage and unsafe conditions. Changing the orifice should only be done by a qualified service technician. Contact your Lennox Hearth Products dealer for proper orifice sizes.

## The Ravenna™ Insert

- Must conform with all local, state, and national installation codes. In the absence of local codes, the installation must conform with National Fuel Gas Code ANSI Z223.1 - latest edition, also known as NFPA 54 (In Canada, the current CAN/CSA B149.1 installation code). Refer to the National Fuel Gas Code and local zoning and code authorities for details on installation requirements.
- Mobile home installations must conform with the Mobile Home Construction and Safety Standard, Title 24 CFR, Part 3280 (in Canada CAN/CSA Z240 MH), or, when such a standard is not applicable, the Standard for Mobile Home Installations, ANSI A225.1 - latest edition.
- Must be vented directly to the outside in accordance with the latest edition of the National Fuel Gas Code and must never be attached to a chimney serving a separate solid fuel burning appliance.
- Has been certified for use with either natural gas or propane.
- Is not for use with solid fuels.
- Is approved for sitting rooms and/or bedrooms.

## Fireplace Requirements

These heaters are designed to be installed into an existing masonry fireplace (built to UBC 37 or ULC S628 standards) or factory built solid fuel, wood burning fireplace (listed to UL 127 or ULC S610) only. All exhaust gases must be vented outside the structure. Combustion air is drawn from outside the structure. When installing in a factory built fireplace, the fireplace grate must be removed and the damper must be removed or secured open.

If the factory-built fireplace has no gas access hole(s) provided, an access hole of 1-1/2 inches (38 mm) or less may be drilled through the lower sides or bottom of the firebox in a proper workmanship like manner. This access hole must be plugged with a non-combustible insulation after the gas supply line has been installed. The installer must mechanically attach the marking supplied with the gas fireplace insert to the inside of the firebox of the fireplace into which the gas fireplace insert is installed.

**IMPORTANT:** When installing these appliances into a factory built fireplace or heat-form, the air flow within and around the fireplace shall not be altered by the installation of the insert (i.e. **DO NOT BLOCK** louvers or cooling air inlet or outlet ports, circulating air chambers in a steel fireplace liner or metal heat circulator).

### WARNING

THIS FIREPLACE HAS BEEN ALTERED TO ACCOMMODATE A FIREPLACE INSERT AND SHOULD BE INSPECTED BY A QUALIFIED PERSON PRIOR TO RE-USE AS A CONVENTIONAL FIREPLACE.

## Smoke Detectors

Since there are always several potential sources of fire in any home, we recommend installing smoke detectors. If possible, install the smoke detector in a hallway adjacent to the room (to reduce the possibility of occasional false activation from the heat produced by the appliance). If your local code requires a smoke detector be installed within the same room, you must follow the requirements of your local code. Check with your local building department for requirements in your area.

## Codes & Approvals

### CERTIFICATION

Gas appliances must be tested and certified by a nationally recognized testing and certification laboratory to ANSI (American National Standard Institute) gas appliance safety standards.

This insert has been tested and certified by OMNI -Test Laboratories to ANSI Z21.88-2005/CSA 2.33-2005 Standard for Vented Gas Fireplace Heater and CGA 2.17-M91 and UL 307B Gas Burning Heating Appliances for Manufactured (Mobile) Homes in both USA and Canada.

It has met all necessary ANSI Standards and is fully certified for installation in any community. If there are any questions or if you need further substantiation either write to or call your Lennox Hearth Products dealer. If you have further questions, please contact Lennox Hearth Products.

Check all local building and safety codes before installation. The installation instructions and appropriate code requirements must be followed exactly and without compromise. In the absence of local codes the following standards and codes must be followed.

## New York City, New York (MEA)

Installation of these fireplaces are approved for installation in New York City in the US state of New York (MEA#: 138-07-E).

## Commonwealth Of Massachusetts Requirements

**Note:** The following requirements reference various Massachusetts and national codes not contained in this document.

For all side wall horizontally vented gas fueled equipment installed in every dwelling, building or structure used in whole or in part for residential purposes, including those owned or operated by the Commonwealth and where the side wall exhaust vent termination is less than seven (7) feet above finished grade in the area of the venting, including but not limited to decks and porches, the following requirements shall be satisfied:

### Installation Of Carbon Monoxide Detectors

At the time of installation of the side wall horizontal vented gas fueled equipment, the installing plumber or gas-fitter shall observe that a hard wired carbon monoxide detector with an alarm and battery back-up is installed on the floor level where the gas equipment is to be installed. In addition, the installing plumber or gas-fitter shall observe that a battery operated or hard wired carbon monoxide detector with an alarm is installed on each additional level of the dwelling, building or structure served by the side wall horizontal vented gas fueled equipment. It shall be the responsibility of the property owner to secure the services of qualified licensed professionals for the installation of hard wired carbon monoxide detectors.

In the event that the side wall horizontally vented gas fueled equipment is installed in a crawl space or an attic, the hard wired carbon monoxide detector with alarm and battery back-up may be installed on the next adjacent floor level.

In the event that the requirements of this subdivision can not be met at the time of completion of installation, the owner shall have a period of thirty (30) days to comply with the above requirements; provided, however, that during said thirty (30) day period, a battery operated carbon monoxide detector with an alarm shall be installed.

### Approved Carbon Monoxide Detectors

Each carbon monoxide detector as required in accordance with the above provisions shall comply with NFPA 720 and be ANSI/UL 2034 listed and IAS certified.

### Signage

A metal or plastic identification plate shall be permanently mounted to the exterior of the building at a minimum height of eight (8) feet above grade directly in line with the exhaust vent terminal for the horizontally vented gas fueled heating appliance or equipment. The sign shall read, in print size no less than one-half (1/2) inch in size, **“GAS VENT DIRECTLY BELOW. KEEP CLEAR OF ALL OBSTRUCTIONS.”**

## Inspection

The state or local gas inspector of the side wall horizontally vented gas fueled equipment shall not approve the installation unless, upon inspection, the inspector observes carbon monoxide detectors and signage installed in accordance with the provisions of 248 CMR 5.08(2)(a)1 through 4.

## Exemptions

The following equipment is exempt from 248 CMR 5.08(2)(a)1 through 4:

- The equipment listed in Chapter 10 entitled “Equipment Not Required To Be Vented” in the most current edition of ANSI Z233.1 / NFPA 54 (In Canada CAN/CSA B149.1 - current edition) as adopted by the Board; and
- Product Approved side wall horizontally vented gas fueled equipment installed in a room or structure separate from the dwelling, building or structure used in whole or in part for residential purposes.

## MANUFACTURER REQUIREMENTS

### Gas Equipment Venting System Provided

When the manufacturer of Product Approved side wall horizontally vented gas equipment provides a venting system design or venting system components with the equipment, the instructions provided by the manufacturer for installation of the equipment and the venting system shall include:

- Detailed instructions for the installation of the venting system design or the venting system components; and
- A complete parts list for the venting system design or venting system.

### Gas Equipment Venting System NOT Provided

When the manufacturer of a Product Approved side wall horizontally vented gas fueled equipment does not provide the parts for venting the flue gases, but identifies “special venting systems”, the following requirements shall be satisfied by the manufacturer:

- The referenced “special venting system” instructions shall be included with the appliance or equipment installation instructions; and
- The “special venting systems” shall be Product Approved by the Board, and the instructions for that system shall include a parts list and detailed installation instructions.

A copy of all installation instructions for all Product Approved side wall horizontally vented gas fueled equipment, all venting instructions, all parts lists for venting instructions, and/or all venting design instructions shall remain with the appliance or equipment at the completion of the installation.

- Installation and repair must be done by a plumber or gas fitter licensed in the Commonwealth of Massachusetts.
- The flexible gas line connector used shall not exceed 36 inches (92 centimeters) in length.
- The individual manual shut-off must be a T-handle type valve.

## Pre-Installation

### FEATURES

#### Installation Options

Manufactured (Mobile) Home  
 Natural Gas Or Propane (LP)  
 Bedrooms  
 Optional Wall-mounted Or Remote Thermostat

#### Electrical

The standard fan motor requires 120 Volts AC for operation. The fireplace is not dependent on the fan or an outside electrical supply to operate. **WARNING - Electrical Grounding Instructions - This appliance is equipped with a three-prong (grounding) plug for your protection against shock hazard and should be plugged directly into a properly grounded three-prong receptacle. Do not cut or remove the grounding prong from this plug.**

#### Millivolt Valve

This insert is operated with a millivolt valve and therefore burns even during a power outage.

#### Fuel

This insert comes from the factory equipped to burn natural gas at a specified elevation. The insert can be converted to burn LP (liquid propane) by installing a conversion kit. Only Lennox Hearth Products conversion kits can be used to convert from NG to LP or LP to NG. Contact your Lennox Hearth Products dealer for details.

## PACKAGING LIST

To install a Ravenna™ insert, an insert body, face, surround (flange) kit, and brick panel are required.

### Insert Body Packaging List

- 1 Insert Body with Burner Cassette
- 1 Set of Refractory Brick Panels
- 1 Log Set
- 1 Ravenna 40
- 1 #36 Burner Orifice (to convert to Ravenna 33)
- 1 Bag of Embers
- 1 Fasteners: 6 slotted 1/4" truss screws
  - 6 speed nuts
  - 9 spring clips
  - 3 plastic adhesive wire restraints
- 1 Installation and Operation Manual

### Decorative Faces - One Required

Traditional	Arch inset
Foundry	Screen
Cast pillar	

### Surround Kits - One Required

**Traditional 1-pc. (41"W x 29"H)**

**Traditional 3-pc. (41"W x 29"H, 48"W x 29"H, 41"W x 33"H or 48"W x 33"H)**

**Cast Iron (45-1/2"W x 30"H-Cast Pillar face only)**

### Surround Kit Contents

- 1 Top Surround
- 2 Side Surrounds
- 3 Gold or Nickel Plated Trim Pieces
- 2 Elbowed Trim Fasteners

RATINGS	Ravenna 40 (RDV40)		Ravenna 33 (RDV33)	
	NATURAL GAS	LP GAS	NATURAL GAS	LP GAS
Max/Min Input BTU/h 0-2,000 Feet (0-610 M) ❶	40,000/28,000	37,500/26,000	33,000/24,000	33,000/24,000
Manifold Pressure (IN. WC)	3.5	10.0	3.5	10.0
Min. Inlet Pressure (IN. WC)	5.0	10.5	5.0	10.5
Maximum heat output BTUs/hour-steady state (depending on vent configuration) ❷	83%	83%	83%	83%
P4 Efficiency <b>ENERGUIDE</b> ❸	67.17%	69.07%	65.55%	67.80%
Orifice (DMS) 0-2,000 Feet (0-610 M) ❶	1/8"	#49	#36	#51

❶ Unit factory equipped for 0-2000 FT/0-610 M, In Canada 0-4500 FT/0-1370 M

❷ The Steady State Efficiency numbers based on maximum vent configuration.

❸ Tested to CSA P.4.1-02 "Testing Method for Measuring Annual Fireplace Efficiency."

Electrical Rating: 120 VAC, 60 HZ, Less Than 2 Amps

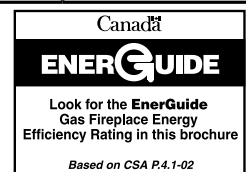

## INSERT DIMENSIONS

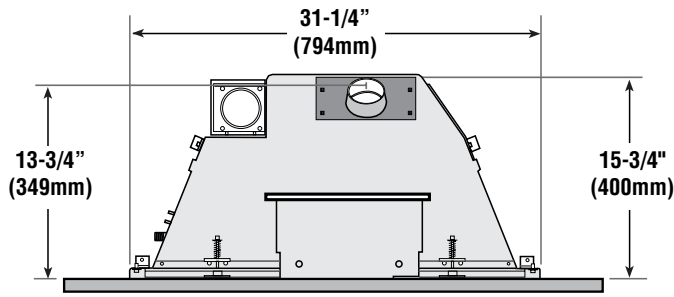

Figure 1 Top View

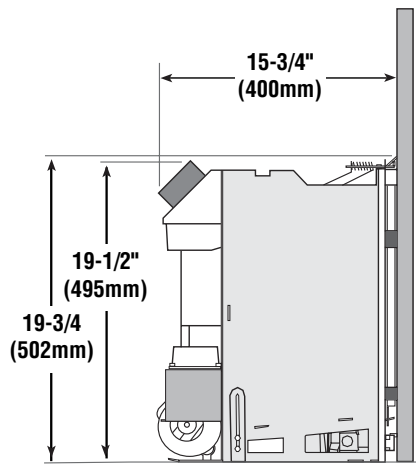

Figure 2 Side View

Insert Dimensions	
Width of insert behind Surround Panels	28" (711mm)
Rear height	19-3/4" (502mm)
Insert depth into fireplace	16" (406mm)
Flue collar diameter (OD)	2-15/16" (75mm)

## MINIMUM FIREPLACE OPENING REQUIRED

- A = 29-3/4" (756mm) Front Opening
- B = 19-1/2" (495mm) Height
- C = 19" (483mm) Rear Width
- D = 16" (406mm) Fireplace Depth

\* Top air duct will need to be removed for short ZC applications. Replace tap tights when removed.

## MINIMUM FIREPLACE CAVITY

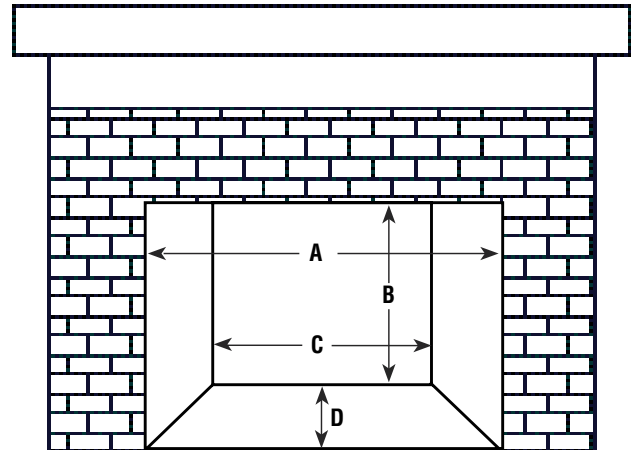

Figure 3

## CAUTIONS

- Trim panels or surrounds must not seal ventilation openings in the existing fireplace that the appliance is installed in.
- The fireplace in which this gas insert is to be installed must be thoroughly cleaned if it has been used to burn wood or synthetic logs. Have the chimney and all inside surfaces of the fireplace brushed and vacuumed so that no soot, embers, or loose combustion deposits can be drawn into the heat circulation blower and blown into the living area.
- If any portion of the chimney system shows signs of structural or mechanical weaknesses, such as: cracks, leaky joints, corroded or warped surfaces, the faulty portion must be repaired or replaced prior to installing this appliance.
- The factory built firebox must accept the insert without modification other than removing bolted or screwed together pieces such as baffles / smoke shelf / deflectors, ash lips, glass door, screen or door tracks, log grates, refractory or masonry lining and damper assemblies. Any fireplace component, which is removed, must be retained so they can be reinstalled to restore the fireplace to its original operating condition. The removal of any part must not alter the integrity of the outer shell of the pre-engineered fireplace cabinet in any way. Any parts removed must be replaceable. If any components are removed from (or altered) from the existing fireplace, a Warning Label (see Page 4) must be affixed inside the fireplace firebox, so that it shall be visible upon removal of the fireplace insert. Note: RTV high temperature silicone is an approved adhesive to affix the label.

## Clearances to Combustibles

**IMPORTANT:** If unit is converted to an RDV33 from an RDV40, the clearances to combustibles can be reduced as shown on this page.

**WARNING:** If this unit is ever converted back to an RDV40, ensure that the clearances are correct for this model.

### MINIMUM CLEARANCES TO COMBUSTIBLES

Minimum clearances include any projections such as shelves, window sills, mantels, spacers/standoffs or surfaces to combustible construction etc. above the appliance. Paint or lacquer used to finish the mantel must be heat resistant in order to avoid discoloration.

The letters below, E through J, correspond to Figure 5 showing minimum clearances required from the appliance to combustibles and the minimum projection of the hearth extension.

E = From Top Facing or Mantel to Bottom of Insert -  
RDV40 = 35-1/2" (902mm) and RDV33 = 31-1/2" (800mm)

F = 25-1/2" From Center of Glass Door to Side Facing or Wall - RDV40 = 25.5" (648mm) and RDV33 = 25.5" (648mm)

J = 10.5" (267mm) Mantel to Bottom of Insert -  
RDV40 = 43" (1092mm) and RDV33 = 39" (991mm)

### HEARTH PROTECTION

G = Minimum Hearth Protection from Front of Insert\*

H = Vertical Distance from Insert Bottom to Combustible Material.

RDV40	G	14" (356mm)	10" (254mm)	0" (0mm)
	H	0" (0mm)	2" (21mm)	4" (102mm)

RDV33	G	13" (330mm)	10" (254mm)	0" (0mm)
	H	0" (0mm)	2" (21mm)	4" (102mm)

**Note:** Hearth protection to be min. 3/8" (10mm) thick non-combustible or equivalent, with a k factor of .84.

### INSERT LEVELING

At each front and rear corner of the insert is an adjustable leg provided to level the insert should the hearth of the fireplace be uneven. To adjust the legs, loosen the two 5/32" allen head screws, move the leg to the desired height, and then tighten the screws. Repeat these steps for each adjusting leg.

## FACING AND MANTEL CLEARANCES

Please note that the RDV33 mantel clearances are 4" less than the RDV40 mantel clearances as shown in Figures 4A (RDV40) and 4B (RDV33).

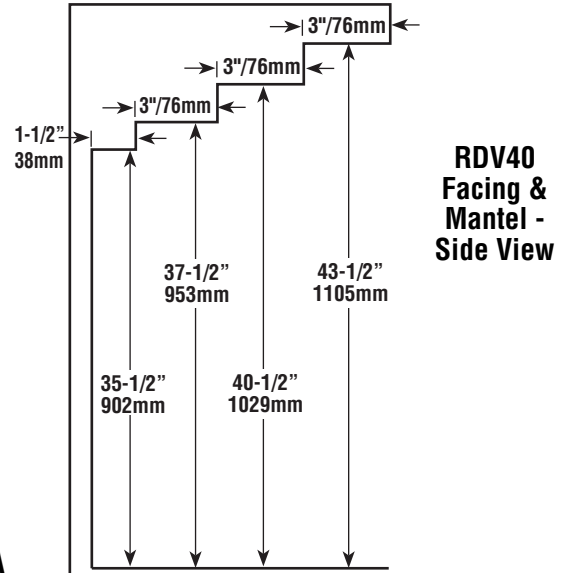

Figure 4A

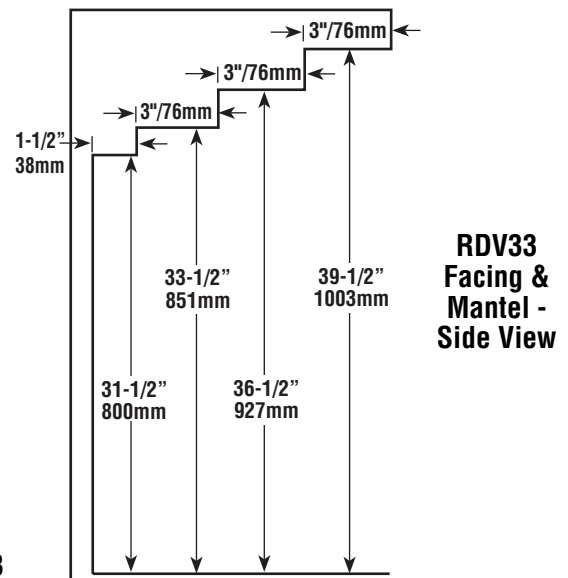

Figure 4B

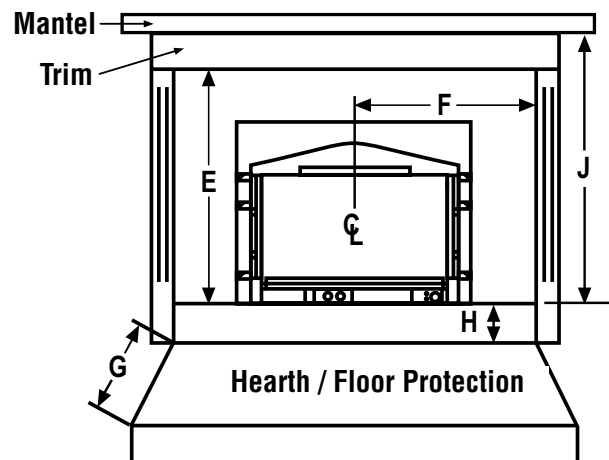

Figure 5 - Clearances



# Installation

## VENTING INSTALLATION

Your Lennox™ gas insert must be vented to the outside in accordance with the current edition of the National Fuel Gas Code ANSI-Z223.1 (In Canada, the current CAN/CSA B149.1 installation code). The insert must not be connected to a chimney flue serving a separate solid fuel burning appliance.

This gas insert requires a 3" diameter listed flex liner. The vent should terminate with a listed direct vent termination cap. The chimney should be sealed around the cap to prevent air and rain from entering the chimney. Adhere to the vent manufacturer's instructions for installation and vent termination. These appliances are approved for use with the following vent kits.

Vent Kits *		
Cat. No.	Model	Description
H0909	FKDVI	Flex Liner Kit, DVI 3" X 35' (requires 2, one for exhaust, and one for intake)
H0908	TKDVI	Termination Kit, DVI (termination cap and flashing)

## VERTICAL VENTING

The vent pipes must be connected to the proper collars on the unit and the exhaust vent pipe must be connected to the termination cap or the unit will not operate. The combustion air vent pipe can be connected to the termination cap or it can terminate inside the chimney.

The bottom opening of the chimney must be sealed around the vent pipes if the combustion air vent is not connected to the termination cap. Use unfaced fiberglass insulation to seal around the vent pipes. The insulation may give off an odor during the first hour of operation.

**NOTE:** The minimum vertical rise (exhaust vent) is 10 feet (3.1 M) and the maximum vertical rise is 35 feet (10.7 M). These dimensions are measured from the starting collars of the unit to the end of the vent pipe.

The fireplace and fireplace chimney must be clean and in good working order and constructed of non-combustible materials. Inspect chimney cleanouts for proper fit and seal.

\* Other approved vent components include; Standard Simpson Dura-vent Co-linear Chimney Liner Kit, Direct Vent Termination #991, Liner Termination Kit (includes termination connector and flashing) #923GK & 3" x 35' Alum Flex #2280

The existing fireplace chimneys may take various contours which the flexible liners will accommodate. However, keep the flexible liner as STRAIGHT as possible, avoid unnecessary bending.

The standard cap in Termination Kit, H0908, is a high wind cap

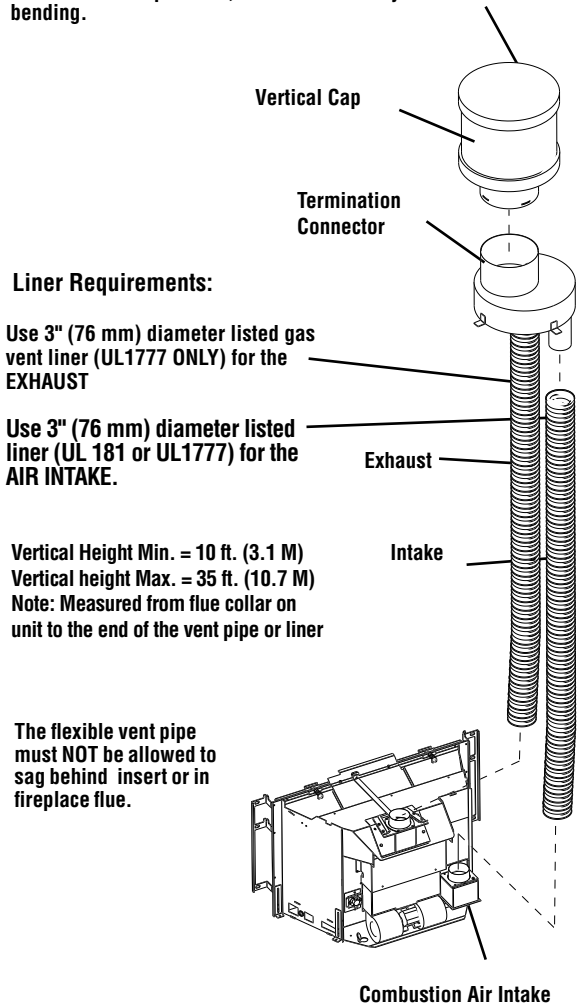

Figure 6

Make sure that both liners will pass through existing damper area. Remove or lock damper to allow the passage of the flexible liners. If the damper will not allow the passage of both liners, DO NOT PROCEED FURTHER. (If fireplace is masonry) Consult a local mason for removal of the damper without risk of structural damage or leakage (if the fireplace is factory built) The appliance may NOT be installed into the fireplace.

**⚠ WARNING**

**Direct-Vent Fireplace Insert Vent Requirements - Use liner listed to UL181 (Factory-made Air Ducts And Air Connectors) or UL1777 (Chimney Liners) for the AIR INTAKE. Use liner listed to UL1777 ONLY for the EXHAUST.**

**Do not substitute the heat-rated flex liner (UL1777) for the exhaust with any other type liner or a fire may result causing property damage, personal injury or loss of life.**

## ZERO CLEARANCE FIREPLACE INSTALLATION

This insert may be installed in a masonry or factory built/zero clearance (ZC) fireplace. When installing in a ZC fireplace, the ZC grate must be removed and the ZC damper must be removed or secured open. The ZC doors, screen, refractory or masonry lining, baffles, and smoke shelf may be removed if necessary to install the gas insert. However, do not cut or alter the fireplace components. The removal of any parts to facilitate installation must not alter the integrity of the inner or outer shells of the fireplace cabinet. Any parts removed must be replaceable if the insert is taken out of the fireplace or the fireplace clearly marked with a paint stick that "This fireplace has been altered and is no longer safe to operate."

The insert is designed to fit into a ZC fireplace with a minimum firebox height of 19-1/2" (495mm). To facilitate this the hood will need to be removed and discarded (Note: the screws should be replaced in the insert body).

If the factory-built fireplace has no gas access hole(s) provided, an access hole of 1-1/2" (37.5 mm) or less may be drilled through the lower sides or bottom of the firebox in a proper workmanship like manner. This access hole must be plugged with a non-combustible insulation after the gas supply line has been installed.

The installer must mechanically attach the marking supplied with the gas fireplace insert to the inside of the firebox of the fireplace into which the gas fireplace insert is installed.

### RAVENNA™ 40 CONVERSION TO RAVENNA 33

To convert to a Ravenna 33 gas insert, after step 1 remove and replace the stock burner orifice with the #36 NG orifice supplied in the installation manual bag. Pipe dope or other approved gas line sealant will need to be applied before inserting into bulkhead. The foil sticker supplied, stating RDV33, will need to be affixed over the model name RDV40 on the serial number label (located in the control compartment).

### BRICK PANEL & LOG SET INSTALLATION

If logs are not installed according to the log installation instructions, flame impingement and improper combustion could occur and result in soot and/or excessive production of carbon monoxide (CO), a colorless, odorless, toxic gas.

The size and position of the log set is critical to achieve a safe, reliable and attractive flame pattern. Any attempt to use a different log set in the fireplace will void the warranty and will result in incomplete combustion, sooting, and poor flame quality.

1. Remove the log rack (2 screws) and install the rear log on the retainer.

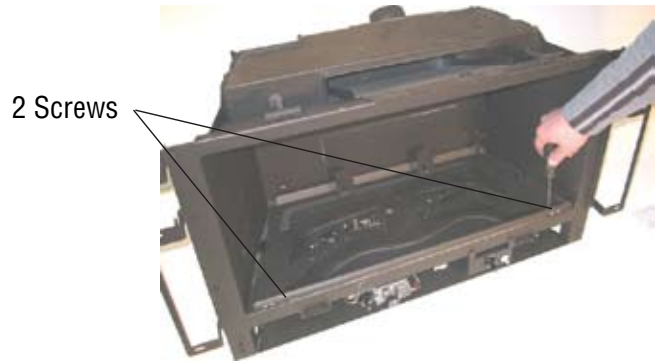

Figure 7



Figure 8

2. Place the rear brick panel on the brackets and reinstall the log rack with the rear log. **IMPORTANT!!! SCREWS PASS THROUGH THE LOG RACK AND THE BURNER PAN.**
3. Install the side brick panels by sliding them into place.

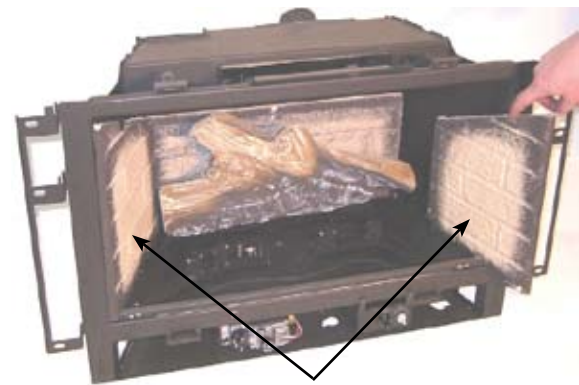

Figure 9

4. Install a light layer of rockwool directly over the ports.
  - A light layer will give a more constant rear flame.
  - A heavy layer will give more glow, but will need to be adjusted after light up.



**Figure 10**

5. Install front logs on retainer slots.

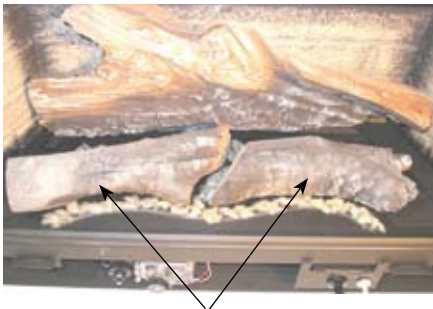

**Figure 11**

Front Logs

6. Place embers around the perimeter of the rockwool.
  - IMPORTANT!!! Do not cover the ports with the embers.**
7. Place top log on pin.

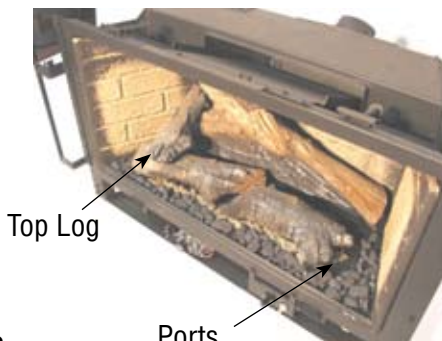

**Figure 12**

## SURROUND INSTALLATION

The Ravenna™ insert surrounds are made of heavy gage steel for durability and, if desired, for the ease of making an inside fit in the fireplace. See **Packaging List** for available sizes.

1. Remove the speed nuts (A in Figure 13) from the parts bag and install (with the flat surface forward) on the six holes in the surround brackets - three on each side of the insert (B in in Figure 13). A flat bladed screwdriver may help in installing the nuts.

2. Install all surround panels and trim with the insert positioned in the fireplace, but a few inches in front of its final location.
3. If an Arch face is to be installed on the insert, the sight obstructor that comes with the face must be installed prior to installing the surround panels. See the instructions included with the face for proper sight obstructor installation.
4. Install the side surround panels by lining up the holes in the tabs on the side surround panels in front of the holes on the surround brackets. Next insert two slotted 1/4" truss screws for each side surround panel and secure loosely.
5. Fasten the top surround panel with the remaining two truss screws. Tighten all six truss screws after adjusting the surround panels to eliminate space between side and top surround panels.
6. Assemble the surround trim by inserting the elbowed retainer in the rectangular slot in the ends of the longest piece of trim and secure by tightening the screw in the retainer. Slide the mitred ends of the two side trim pieces onto the elbowed retainer and secure by tightening the retainer screw.
7. The fastened trim pieces should now be horseshoe shaped. Slide the trim down over the surround panels so the edge of the surround panel fits just behind the rounded edge of the trim.
8. Install three spring clips (found in parts bag in firebox) in each piece of trim by inserting them between the rear of the surround and the channel of the trim. The spring clips will push the trim tight to the surround.

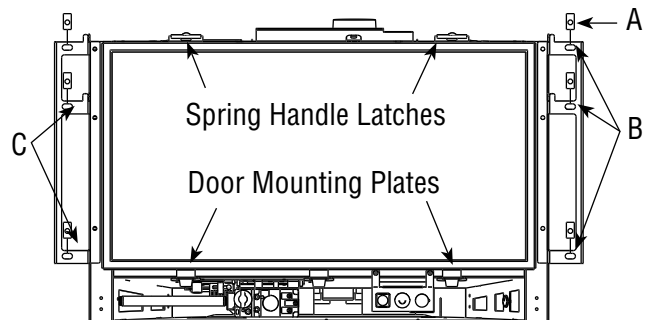

**Figure 13**

## FACE INSTALLATION

A number of different face finishes and styles are available for your Ravenna gas insert. The Arch face comes with a sight obstructor that must be installed prior to installing the surround panels and face. Instructions for installing the sight obstructor are included with the face. The faces come with hooked brackets. To install the face, hang the hooked brackets on the surround brackets (See C in Figure 13).

**Note:** Gold and nickel plated surfaces must be cleaned with glass cleaner and a soft clean cloth before firing the first time or fingerprints and stains will remain permanently. **NEVER use brass polish to clean gold or nickel surfaces, this will remove the plating!!!**

NOTE: DIAGRAMS & ILLUSTRATIONS ARE NOT TO SCALE.

## Gas Line Installation

After leveling, position the insert in the fireplace - holding it about six inches out from its final location.

**Caution: Specific hearth requirements apply (see Clearances to Combustibles).**

The Ravenna™ gas insert must be connected to the gas line in accordance with local codes and/or the National Fuel Gas Code, ANSI Z223.1 (In Canada, the current CAN/CSA B149.1 installation code). The insert comes with an 8" nipple attached to the supply side of the gas valve. After connecting the gas line, all joints in the line and connections at the valve should be checked for leaks before final positioning of the unit. Conduct a gas leakage test of the appliance piping and control system downstream of the shutoff valve in the supply line to the appliance.

### GAS PRESSURE REQUIREMENTS

**A MAJOR CAUSE OF OPERATING PROBLEMS WITH GAS APPLIANCES IS IMPROPER GAS PRESSURE!**

**The most important item to check during the initial installation and the first thing to check when operating problems occur is gas pressure! This appliance will not function properly unless the required gas pressure is supplied. See the table on this page for gas pressure requirements.**

Two pressure taps are provided on the insert's valve to check gas pressures. The taps are located to the right of the on/off/pilot knob (see Figure 14). The bottom tap is the inlet (supply) pressure side. To check inlet pressure (with the insert burning), insert a small phillips screwdriver into the tap and turn a half turn counter-clockwise. Cover the tap with the line from a manometer and check the pressure. Close the tap gently but securely after completing the check. The manifold (outlet) tap is above the inlet tap. To check manifold pressure (with the insert burning at the high burn setting) insert a small phillips screwdriver into the tap and turn a half turn counter-clockwise. Cover the tap with the line from the manometer and check the pressure. Again, close the tap gently but securely after completing the check. Check the taps for gas leaks with a gas leak test solution (retighten if necessary).

If the pressure is not sufficient, make sure the gas supply line is large enough, the supply regulator is properly adjusted, and the total gas load for the residence does not exceed the amount supplied.

**The appliance and its individual shut off valve must be disconnected from the gas supply piping system during any pressure testing of that system at test pressures in excess of 1/2 psig.**

**The appliance must be isolated from the gas supply piping system by closing its individual manual shut-off valve during any pressure testing of the gas supply piping system at test pressures equal to or less than 1/2 psig. Check with your gas supplier or plumber.**

Fuel Type	Inlet Pressure			Manifold Pressure	
	Desired	Minimum	Maximum	On Hi Fire	On Lo Fire
Natural Gas	7" WC	5" WC	10.5" WC	3.5" WC	1.7" WC
LP Gas	11" WC	10.5" WC	13" WC	10" WC	5.4" WC

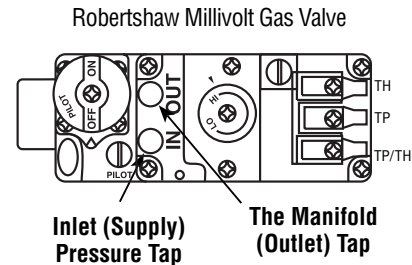

Figure 14

### LP AND NATURAL GAS SUPPLIES

Your Ravenna gas insert is equipped from the factory for use with natural gas only as specified on the Safety / Listing label attached to the appliance. This appliance can only be operated using propane gas (LP) if a certified fuel conversion kit provided by Lennox Hearth Products is installed by a qualified service technician.

Also check the orifice size on the label on the igniter bracket. It must be the correct size for the fuel and altitude.

**Do not run propane tank dry. Running the tank dry may cause a hazardous condition due to pressure drop in empty tank.**

**Solid fuel is NOT to be used with this unit.**

### Air Shutter Adjustment

The Ravenna gas insert has an air shutter control lever located behind the lower door on the insert's face and to the left of the gas valve (see Figures 15a & 15b). The lever is linked to the primary air shutter on the main burner. The air shutter regulates the amount of primary air the burner receives and therefore how clean the insert burns. The air shutter should only be adjusted by a qualified gas technician. The insert should burn for about 15 minutes with the logs installed before adjusting the air shutter. More air will result in shorter flames and less color, less air will result in bigger flames and more color. To adjust the air shutter, insert a regular screwdriver into the slide adjustment and slide it side to side (see Figures 15a & 15b). **Caution: The air shutter should never be set so as to make the tips of the flames sooty or create sooting on the viewing glass, logs, or heat exchanger. If soot begins to form after burning, the air shutter should be opened gradually until the sooting condition stops. Gas quality and gas pressure may vary, which can affect the burning characteristics of the insert.**

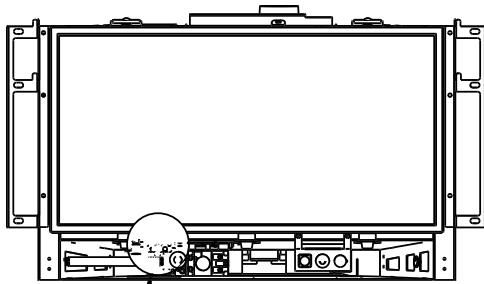

Figure 15a

See Detail Shutter Adjustment

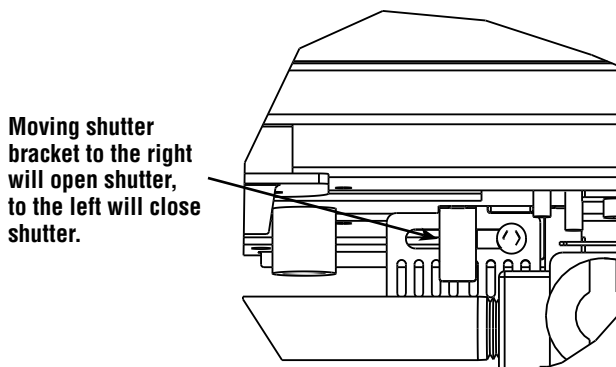

Figure 15b

Shutter Adjustment Detail

## Operating Instructions

### PRE-LIGHTING CHECKLIST

Be sure to check these items before the initial lighting of the insert:

- The insert gas label corresponds to the gas supply available - that is "natural gas" for natural gas or "LP gas" for LP gas.
- Gas pressure has been checked carefully - see Page 12.
- All gas fittings have been checked for leaks.
- All clearances to combustibles have been met-see Page 8.
- All combustible materials have been removed from the area in front of the insert.
- All vented areas of the insert face are unobstructed.
- House is ventilated to clear initial paint curing odors - see Page 15.
- All packaging materials have been removed from the firebox.
- While insert is cool, fingerprints or other marks have been cleaned from any gold or nickel surfaces with denatured alcohol and a soft cloth. Marks left on these surfaces may become etched into the finish if not removed prior to burning the unit.
- Brick panels and log set have been installed.
- The glass door is in place and is properly sealed.

### Lighting Instructions

The following is a copy of the operating and lighting instructions found with each insert:

## FOR YOUR SAFETY READ BEFORE OPERATING

**WARNING: IF YOU DO NOT FOLLOW THESE INSTRUCTIONS EXACTLY, A FIRE OR EXPLOSION MAY RESULT CAUSING PROPERTY DAMAGE, INJURY, OR LOSS OF LIFE.**

**CAUTION: HOT WHILE IN OPERATION. DO NOT TOUCH. KEEP CHILDREN, FURNITURE, GASOLINE, AND OTHER LIQUIDS WITH FLAMMABLE VAPORS AWAY. NEVER OPERATE UNIT WITH GLASS OFF OR ATTEMPT TO REMOVE THE GLASS WHILE HOT.**

- A. This appliance is equipped with a piezo ignition device to light the pilot. When lighting the pilot, follow these instructions exactly.
- B. **BEFORE LIGHTING**, smell around the appliance area for gas. Be sure to smell next to the floor, because some gas is heavier than air and will settle on the floor.

### WHAT TO DO IF YOU SMELL GAS:

**DO NOT** try to light the appliance.  
**DO NOT** touch any electric switch,  
**DO NOT** use any phone in the building. Immediately call your gas supplier from a neighbor's phone. Follow the gas supplier's instructions. If you cannot reach your gas supplier, call the fire department.

- C. Use only your hand to push in or turn the gas control knob. Never use any tool. If the knob will not push in or turn by hand, don't try to repair it, call a qualified service technician. Force or attempted repair may result in a fire or explosion.
- D. **DO NOT** use this appliance if any part has been under water. Immediately call a qualified service technician to inspect the appliance and to replace any part of the control system and any gas control which has been under water.

### OPERATING INSTRUCTIONS

**CAUTION: Your Lennox™ gas INSERT MUST ALWAYS BE OPERATED WITH GLASS IN PLACE.**





**STOP!! Read the safety information above before proceeding.**

1. Open the lower door. Make sure gas supply shut-off cocks are open and ON/OFF rocker switch is "OFF." If equipped with a thermostat, set it to the lowest setting.
2. Turn off all electrical power to the appliance.
3. Push in gas cock dial slightly and turn clockwise  to "OFF."

**NOTE:** Dial cannot be turned from "PILOT" to "OFF" unless dial is pushed in slightly. Do not force.

4. Wait five minutes to clear out any gas. Then smell for gas, including near the floor. If you smell gas, STOP! Follow "B" above. If you don't smell gas continue.



5. Locate the pilot by looking over the top of the left front log. A blue flame will be seen when the pilot is lit.
6. Turn the gas control knob counter-clockwise  to the "PILOT" position.
7. Push the knob all the way in and hold in that position. Immediately light the pilot by pressing the igniter button several times until pilot is lit. Continue to hold the knob in for about 30 seconds after the pilot is lit. Release knob and it will pop back out. Pilot should remain lit. If it goes out, repeat steps 4-8 holding knob in an additional 15 seconds after pilot is lit. If knob does not pop out when released, stop and immediately call your service technician or gas supplier. If the pilot will not stay lit after several tries, turn the gas control knob to "OFF" and call your service technician or your gas supplier.
8. After pilot is lit, turn gas control knob counter-clockwise  to "ON." Knob can only be turned to "ON" if the knob has popped out.
9. To turn burner on, turn "ON/OFF" rocker switch to "ON" or set the thermostat to the desired temperature above room temperature.
10. Adjust the flame height (and heat output) by turning the flame height knob clockwise  for full flame and counter-clockwise  for reduced flame.
11. Turn on the electric power to the appliance and set the blower to the desired air flow after it turns on when the appliance reaches operating temperature.

### TO TURN OFF GAS TO APPLIANCE

1. Turn off the "ON/OFF" rocker switch and/or thermostat (if installed) to its lowest setting.
2. Turn off electric power to the appliance if service is to be performed.
3. Push in gas control knob slightly and turn clockwise  to "OFF." Do not force.

**This appliance needs fresh air for safe operation and must be installed so there are provisions for adequate combustion and ventilation air.**

### SHUTDOWN PROCEDURE

To turn off the burner, turn the rocker switch to "OFF" or adjust the thermostat (if installed) to a setting below room temperature. The pilot will remain lit for future burner ignition. For complete shutdown, see "TO TURN OFF GAS TO APPLIANCE" above.

## WARNINGS

- **Improper installation, adjustment, alteration, service or maintenance can cause injury or property damage. For assistance or additional information, consult a qualified installer, service agency or your gas supplier.**
- **Operation of this appliance when not connected to a properly installed and maintained venting system can result in carbon monoxide (CO) poisoning and possible death.**
- **Carbon monoxide poisoning – early signs of carbon monoxide poisoning resemble the flu with headaches, dizziness, or nausea. If you have these signs, get fresh air at once! Have the heater inspected by a qualified service technician. Some people are more affected by carbon monoxide than others. These include pregnant women, people with heart or lung disease or anemia, those under the influence of alcohol, and those at high altitudes.**

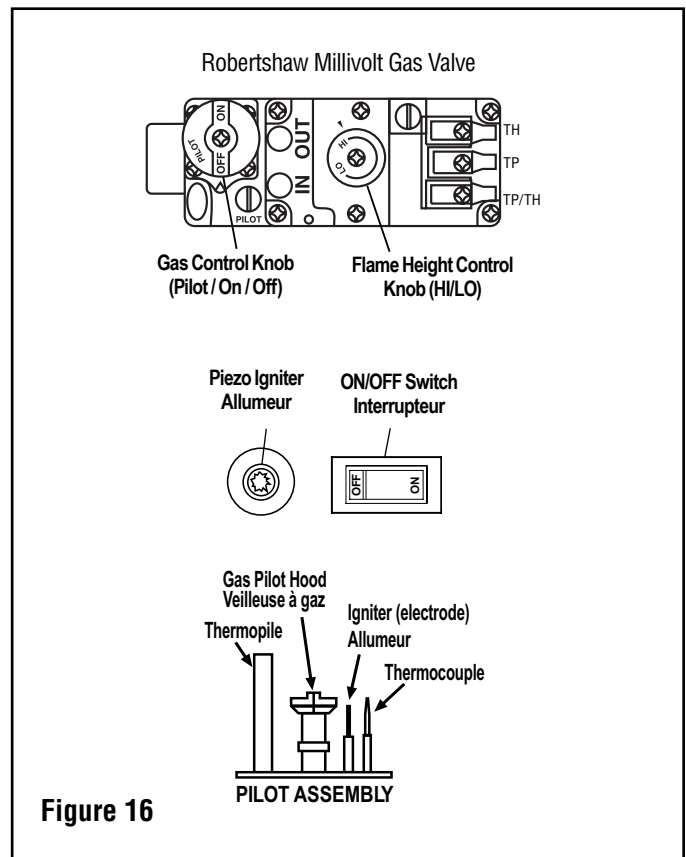

## Flame Color & Behavior

Your Ravenna™ gas insert is designed for maximum heating efficiency. Therefore, upon lighting of the main burner the flames will be semi-transparent or “bluish.” After 10-20 minutes of operation the logs will heat up and the flames will become a yellow/orange color.

Adjusting the insert to cause the flames to turn orange sooner may result in poor combustion, sooting, and a hazardous situation. See Figure 17 showing proper flame appearance.

When testing for proper operation - If an optional thermostat is installed adjust it to its highest temperature setting. Visually determine that main burner gas is burning properly: i.e., no floating, lifting or flashback. Adjust the primary air shutter(s) as required. Check for proper main burner operation at both high and low flame.

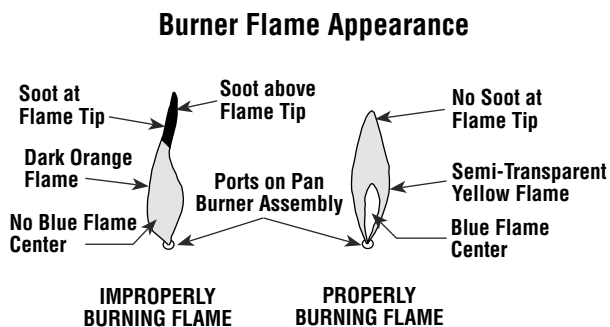

Figure 17

## Paint Curing

This insert has been painted with StoveBright high temperature metallic stove paint. It leaves the factory dry to the touch, but finishes curing as the insert is used. Fire the insert four successive times for ten minutes each time with a five minute cool down between each firing. Ventilate the house during these first firings as the paint gives off an unpleasant odor. It is recommended that persons sensitive to an imbalance in the indoor air quality avoid the insert during the curing process.

## Quiet Operation

As the Ravenna™ gas insert is burning, a number of normal operational sounds may be heard. The flow of gas through the gas valve and orifice may make a rushing or whistling noise. If this noise is objectionable, it can be reduced by turning down the flame. Turning down the flame can reduce total heat output by more than 30%. When the blower turns on, the sound of rushing air may be heard. The blower sounds may be reduced by adjusting the speed control located on the blower assembly. Also, a slight clicking sound may be heard as the gas valve or blower switch turn on and off.

## Blower Operation

Your Ravenna gas insert comes equipped with a 150 CFM blower with a variable speed control and an automatic temperature activated On/Off snap switch.

### OPERATION:

1. Plug the blower power cord into a grounded (three-prong) outlet. This appliance is equipped with a three-prong (grounding) plug for your protection against shock hazard and should be plugged directly into a properly grounded three-prong receptacle. Do not cut or remove the grounding prong from this plug.
2. After the insert warms up, the fan will turn on if the speed control (located at the right below the firebox) is left in the "ON" position. The fan will not operate until the insert is warm.
3. Once the fan turns on, turn the knob to the desired speed. No further adjustment is necessary.
4. If you do not wish to have the fan on, turn the knob until it clicks into the "OFF" position.

## Optional Wall Thermostat

If an optional wall thermostat is to be installed, install the thermostat per the manufacturers instructions (provided with the thermostat). Failure to follow manufacturers instructions could result in a malfunction. Pay special attention to the thermostat location requirements. If the location requirements are not adhered to the appliance, erratic operation or failure may occur.

Do not mount the thermostat where it may be affected by:

- Radiant heat from this appliance, fireplaces, sun or other heat sources.
- Drafts or dead spots behind doors or in corners.
- Hot or cold air from ducts.

## OPERATING OPTIONS

The rocker switch on your Ravenna™ gas insert is used to turn the burner on and off while the pilot is on. The rocker switch can be installed in the hole in the right side of the top surround panel or in the hole in the panel to the left of the igniter button. The hole in the panel is covered by a label which must be carefully cut out before installing the rocker switch. The switch must be disconnected from the coil of wire to which it is attached, the plastic nut unscrewed from the back side of the switch, and then the switch can be inserted into the hole at either location. If the switch is to be located in the surround, route the wire behind the igniter bracket and through the hole in the lower right side of the insert. Attach the three plastic adhesive wire restraints (found in the bag in the firebox) to the side surround panel. Feed the wire through these restraints and up to the switch. Care should be taken to ensure the wire does not come in contact with the hot surfaces of the firebox. Reconnect the wires to the switch.

A wall-mounted switch, a millivolt wall thermostat, or a remote control, can be used to supplement the rocker switch. The gas valve is powered by millivolts generated by the pilot assembly. This millivolt system is very sensitive to electrical resistance, therefore, make sure all connections are tight, clean, and free from corrosion. Do not splice any millivolt wires. Consult the table on this Page to determine the proper gage of wire for the thermostat or wall switch connections. This table refers to the total length of the wire (out to the switch and back). The thermostat must be a millivolt type. A 24-volt furnace thermostat will not work. Never hook up household current - 120 Volts - to the millivolt system. It is not recommended to hook up any more than two switches to the insert (for example a rocker switch and a wall thermostat). Additional switches may affect the system resistance and increase the chance of the burner not igniting. Follow the instructions included with the thermostat or remote control for wiring.

The thermostat, remote control, and rocker switch will turn the burner on and off independently. Be sure to set the rocker switch to the "OFF" position when using the thermostat or remote control and set the thermostat or remote control to the lowest temperature when you wish to use the rocker switch only, otherwise one may override the other. If a remote thermostat is to be used with the insert, do not place the receiver under the firebox.

Thermostat Wire	
Wire Size	Maximum Length
12 Gage	100 Feet
14 Gage	64 Feet
16 Gage	40 Feet
18 Gage	25 Feet
20 Gage	16 Feet

## MILLIVOLT CONTROL SYSTEM

This fireplace operates on a millivolt control system. As such, no additional power supply is needed for the fireplace to heat. The pilot assembly contains a thermocouple, that when heated by the pilot flame, generates electricity (millivolts- mV=1/1000 of a volt) which opens a valve allowing gas to flow to the pilot assembly. The pilot assembly also contains a thermopile, that when heated by the pilot flame, generates electricity that flows to terminal #1 (labeled THTP) on the gas valve. When the electricity is conducted from terminal #1 through the on/off switch, thermostat, or receiver of the remote control to terminal #3 (labeled TH) on the gas valve, the main burner will ignite.

### Millivolt Control Schematic

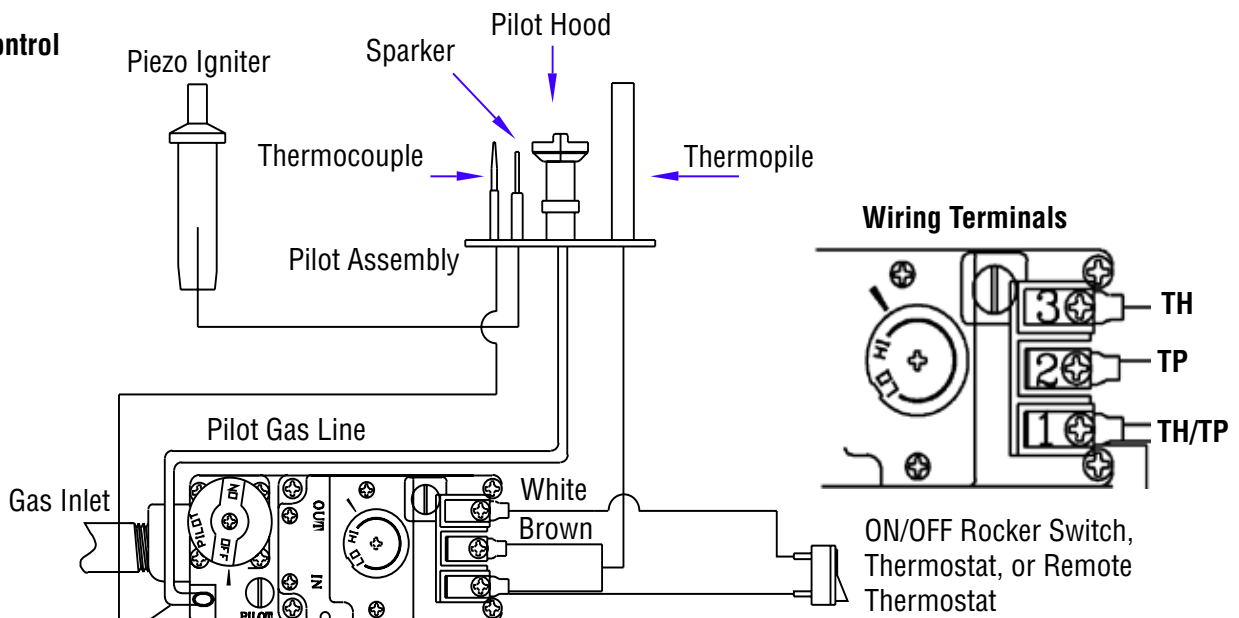

Figure 18

NOTE: DIAGRAMS & ILLUSTRATIONS ARE NOT TO SCALE.



## Maintenance & Servicing

### MAINTENANCE CHECKLIST

The following should only be performed by a qualified service technician.

**Caution:** Label all wires prior to disconnection when servicing controls. Wiring errors can cause improper and dangerous operation. Verify proper operation after servicing.

#### 1. Annual inspection should be made and the following checks performed:

- When unit is cool, remove glass and inspect burner for dirt, soot, and lint accumulations, and remove if necessary. If excessive soot accumulation is present on burner, have a qualified service technician adjust the burner for proper combustion.
- Clean inside of glass with gas fireplace glass cleaner. NEVER attempt to remove or clean the glass when the unit is hot.
- Check the hot air outlet vents for lint or other accumulations. Never block or restrict vent openings, obstruct flow of ventilation air, or use vents other than those approved for use with the Ravenna gas insert.
- Check that the chimney and its outlet are open and free of soot, blockage, or debris.
- Check gaskets once a year. Gaskets must be tight. Replace if necessary.
- Inspect the pilot system for proper flame. NEVER ADJUST THE PILOT until after the gas pressure has been checked and the supply lines have been completely bled (this may take an hour or more when bleeding through the pilot). All pilots are checked and burned at the factory prior to shipment. The pilot adjustment screw is located below the ON/OFF/PILOT control knob. Remove the pilot adjusting cover with a flat-bladed screwdriver to access the pilot adjusting screw. Adjust the pilot screw to properly size the flames. The flames should directly contact the thermopile and extend across the main burner ports. Be careful not to back the screw out of its threads. Replace the cover and check for gas leaks using a gas leak test solution.
- Check that the area around the insert is kept clear and is free of combustible materials, gasoline, and other flammable vapors and liquids.
- Check the millivolt system as per the table on this page.

#### 2. The viewing glass should be cleaned periodically (see Glass Maintenance).

Millivolt and System Checks				
Check Test	To Test	Connect Meter Leads to Terminals	Thermostat Connects	Meter Reading Should Be
A	Complete System	2 & 3	Closed	100 MV or More
B	Thermopile Output	1 & 2	Open	Greater Than 325 MV
C	System Resistance	2 & 3	Closed	2.5 Ohms

#### PROPER PILOT FLAME APPEARANCE

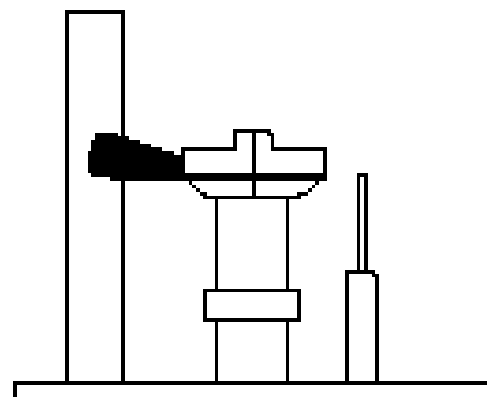

Figure 19

### GLASS DOOR CLEANING AND MAINTENANCE

**Cleaning:** When cool, the glass may be cleaned with a clean, soft cloth and Windex. For cleaning white condensation from the interior glass, use KEL KEM gas fireplace glass cleaner available from your insert dealer. Use of caustic or abrasive cleaners may damage the glass. DO NOT operate the insert with broken glass. DO NOT clean door or glass when hot. DO NOT abuse the glass door by striking or slamming it shut. DO NOT use substitute materials if replacing the glass. DO NOT spray commercial glass cleaner with ammonia on the door and glass gasket as it may dissolve the gasket glue.

**Glass Replacement:** The glass in the insert door cannot be replaced separately. Should the glass be damaged, the entire glass, gasket, and metal frame assembly must be replaced as a unit. This replacement glass assembly is available from your LennoxHearth Products dealer. The glass is neo-ceramic and alternative types must not be used.

**WARNING:** Do not operate appliance with the glass panel removed, cracked, or broken. Do not remove glass door while the insert is hot. Replacement of the glass door should be done by a qualified service technician.

## GLASS DOOR REMOVAL

**Caution: Do not slam or strike glass door or damage may occur.**

Do not remove the glass door while the insert is hot. To remove the glass door, pull forward and up on the top latches. Lift the glass door up and off the lower spring latch. Be careful not to damage or scratch the glass while handling. To reinstall the glass, reverse the removal steps. Do not operate the insert with the glass removed.

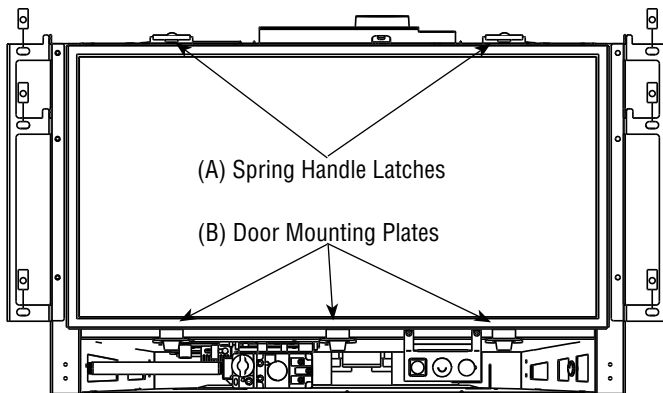

Figure 20

## GLASS DOOR CLEANING AND REPAIR

**Cleaning:** Do not remove or clean the glass door when hot. A gas door glass cleaner (available from your Lennox Hearth Products dealer) or windex should be used with a soft cloth to clean the glass. Do not use an abrasive cleaner.

**Repair:** If the glass is broken in the glass door, the entire door (metal frame, gasket, and glass) should be replaced as a unit. This replacement unit is available from your Lennox Hearth Products dealer. Do not use substitute parts or materials.

**Caution: Do not operate this insert with broken glass.**

## Blower Wiring Schematic

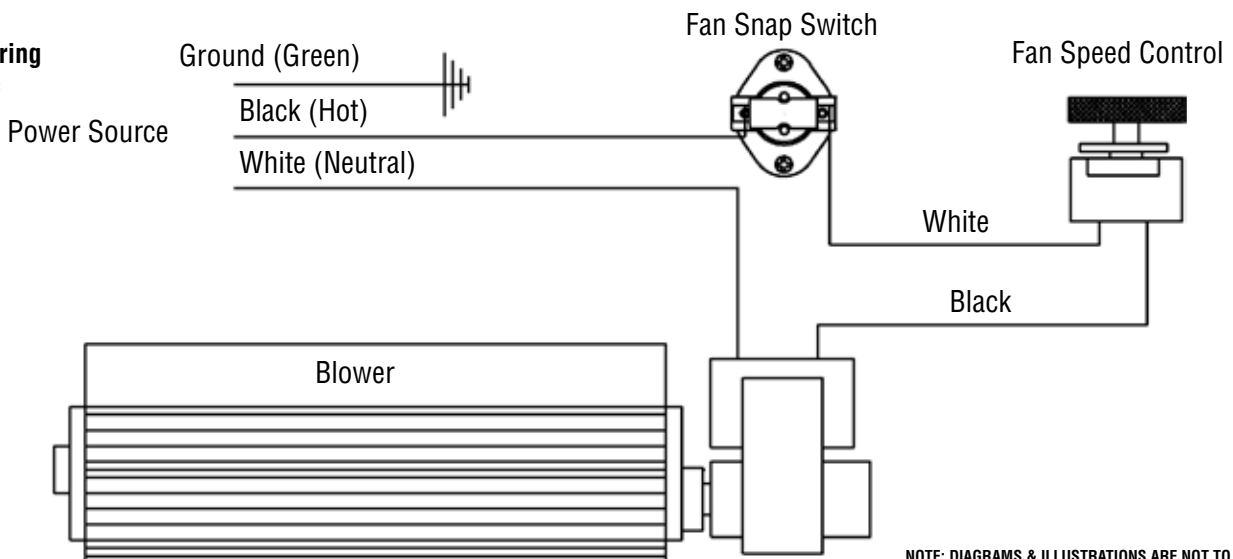

Figure 21

## FUEL CONVERSION

Converting your Ravenna™ gas insert between natural gas and LP can be accomplished by installing a conversion kit (valve regulator and burner orifice). Only a qualified service technician should perform the conversion.

**CONVERSION KIT:** Please see instructions provided with conversion kit.

## BLOWER REMOVAL

Unplug the power supply cord from the electrical outlet prior to removing the blower. The fan can be accessed through the back wall of the firebox.

**Caution: Label all wires prior to disconnection when servicing controls. Wiring errors can cause improper and dangerous operation. Verify proper operation after servicing (see the fan wiring diagram below for reference).**

Remove the insert face, glass door, log set, and brick panels. All of these items are fragile so handle them with care. Next, remove the nine allen head screws around the outside of the panel fastened to the back wall of the firebox. Rotate the top of this panel toward the front, remove the two wires connected to the fan, and then lift the panel with the fan attached out of the firebox. To reinstall the fan, repeat these steps in the reverse order.

## Electrical Requirements:

This gas insert operates without an outside power source, however the blower requires a 120 Volt electrical service outlet. This appliance, when installed, must be electrically grounded in accordance with local codes, or in the absence of local codes, the National Electrical Code ANSI/NFPA 70 - latest edition. (See Operating Options for thermostat and ON/OFF switch information).

## Troubleshooting

**NOTE:** When troubleshooting the gas control system, be sure the external gas shut off valve, located at the gas supply inlet is in the “ON” position.

**IMPORTANT:** Call your gas supplier or plumber for additional help with any gas control problem. Valve system troubleshooting should only be accomplished by a qualified service technician.

SYMPTOM	PROBABLE CAUSE	CORRECTIVE ACTION
Thin black coating (soot) forms on the viewing glass, logs, or firebox	Improper log or ember placement Improper air shutter setting Not enough combustion air	See <b>Brick Panel and Log Set Installation on Pages 10 &amp; 11</b> . If there is soot in one specific location, the rockwool below this location needs to be adjusted. This can be done by pulling embers forward slightly. If the flames have soot tails, the shutter will need to be opened.  If sooting continues open air shutter (see <b>Air Shutter Adjustment on Page 12 &amp; 13</b> )  Check for debris obstructing air flow in valve compartment under insert or in front of lower venting.
Humming or whistling coming from insert.	Normal operating noise Obstructed orifice opening	See <b>Quiet Operation on Page 15</b> . The noise may be reduced by slightly turning down the flame. Turning the flame down will reduce the heat output of the insert.  If noise is excessive or is “whistling” have your gas supplier check the regulator and orifices and replace if necessary.
A change in flame appearance or burner operation.	A change in gas pressure Improper ember placement	Have your gas supplier check for correct gas pressure (7" W.C. / po. C.E. [1.74 kPa] natural gas; 11" W.C. / po. C.E. [2.74 kPa] LP gas). <b>NOTE: NEVER BLOCK OR OBSTRUCT AIR INTAKE OR OUTLET VENTS.</b>  See <b>Brick Panel and Log Set Installation on Pages 10 &amp; 11</b> .
Spark igniter will not light pilot after repeated tries.	No gas supplied to unit or air in line Defective igniter (no spark at electrode) Defective or misaligned electrode at pilot (spark at electrode)	Check gas supply. To purge, hold in gas cock on valve for 1-2 minutes and try again.  Check for spark at electrode and pilot, if no spark and electrode wire is properly connected, replace igniter and igniter wire.  Using a match, light pilot. If pilot lights, turn off pilot and trigger the igniter again. If pilot lights, an intermittent gas/air supply may be the problem, if longer purge will not light - check gap between electrode and pilot - should be 1/8 inch (3 mm) to have a strong spark. If OK, replace pilot.
Pilot will not stay lit after carefully following lighting instructions.	Low gas inlet pressure Defective thermopile Defective automatic valve operator	Check inlet pressure and adjust pilot if necessary.  Be sure wire connections from thermopile are tight at gas valve terminals.  Either rocker switch or thermostat wires may be grounded. Remove wires from valve terminals. If pilot stays lit, trace switch wiring for a ground. May be grounded to insert or gas supply.  Check open circuit millivolt output of thermopile. Reading should be greater than 325mV. Also check thermopile wire for kinks that can cause loss of mV. Replace faulty thermopile if wire is okay and reading is less than 325mV. Turn valve knob to “ON” and thermostat (if installed) to 90°. Millivolt meter should read greater than 100 mV. If reading is OK and burner does not turn on, replace gas valve (qualified service technician only).
Main burner will not burn.	Pilot has gone out Rocker switch, thermostat, or wires defective Thermopile may not be generating sufficient millivolts	See <b>Lighting Instructions</b> .  Disconnect rocker switch and thermostat wires at terminals 1 and 3 on valve. Jumper across from 1 to 3 with pilot lit. If burner comes on either rocker switch, thermostat, or wiring is not functioning.  Check thermopile with millivolt meter (see <b>Maintenance and Servicing</b> ), recheck symptom #2.

## Replacement Parts

### Ravenna™ 33/40 (RDV33/40)

Part Number	Description
H3132	Cassette Assembly NG 33,000 BTU (if LP, also requires H5433 Conversion Kit)
H3045	Cassette Assembly NG 40,000 BTU (if LP, also requires H5433 Conversion Kit)
H6010	Burner Assembly
H5922	Pilot Assembly Convertible, NG or LP
H5938	Gas Control Valve NG (if LP, also requires H5941 LP Regulator)
H5939	Regulator, NG
H5941	Regulator, LP
H5924	Orifice Main Burner #36 NG 33,000 BTU
H5963	Orifice Main Burner 1/8" NG 40,000 BTU
H5926	Orifice High Altitude Main Burner #37 NG 33,000 BTU
H5971	Orifice High Altitude Main Burner #30 NG 40,000 BTU
H5925	Orifice Main Burner #51 LP 33,000 BTU
H5929	Orifice Main Burner #49 LP 40,000 BTU
H5927	Orifice High Altitude Main Burner #52 LP 33,000 BTU
H5972	Orifice High Altitude Main Burner #53 LP 40,000 BTU
H5433	Conversion Kit, NG to LP
H5434	Conversion Kit, LP to NG
H6013	Blower W/Mounting Bracket
H5875	Blower Snap Switch
H5655	Blower Speed Control (rheostat)
H5744	On/Off Switch
H6007	On/Off Switch Wires Only
H5745	Piezo Igniter
H4635	Wall Thermostat, Digital
70005	AC Remote Control Thermostat
H0251	DC Remote Control, Deluxe, Thermostat
H5975	Power Cord
H5977	Blower Wire
H5730	Speed Control Wire (for rheostat)
H5858	Log Set
H2739	Brick Panel Set
H5863	Bag of Embers (volcanic stone)
H5864	Bag of Rockwool
H3130	Firebox Door w/Glass
H5989	Hardware Package
H5839	Log Set Support
H5913	Hinge, Right, Double Door W/Screen all Faces
H5914	Hinge, Left, Double Door W/Screen all Faces
H5980	Knob Extension Kit, Robertshaw, Bay Face
H5893	Accent Trim, Gold, Traditional Face
H5908	Glass, Pillar Center
H5910	Glass Pillar Side
75169	Knob, Gold, Set of 2
75170	Knobs, Brushed Nickel, set of 2
75010	Knobs, Black Nickel, set of 2

## Accessories

Brick Panel Kits	
Cat. No.	Description
75357	Standard Brick
75359	Architectural Stone
75358	Red Brick

Surround Panel Kits	
75362	29 x 41 BLACK Trim (One-piece)
75068	29 x 41 BLACK Trim
75069	29 x 48 BLACK Trim
75070	33 x 41 BLACK Trim
75071	33 x 48 BLACK Trim

Cast Black Surround Panels	
75156	30 x 44 Top (Box 1 of 2)
75157	30 x 44 Sides (Box 2 of 2)

Surround Trim Kits	
H5143	Trim/Black 29 x 41
H5145	Trim/Black 29 x 48
H5144	Trim/Black 33 x 41
H5146	Trim/Black 33 x 48
75036	Trim/Gold 29 x 41
75038	Trim/Gold 29 x 48
75040	Trim/Gold 33 x 41
75042	Trim/Gold 33 x 48
75037	Trim/Nickel 29 x 41
75039	Trim/Nickel 29 x 48
75041	Trim/Nickel 33 x 41
75043	Trim/Nickel 33 x 48

Gas Conversion Kits	
H5433	Conversion Kit 33/40 NG to LP
H5434	Conversion Kit 33/40 LP to NG



Misc.	
70005	Remote Control, Thermostat AC
H0251	Remote Control, RCL-STAT, Deluxe Thermostat DC
H4635	Wall Thermostat, Digital
75273	Round Black On/Off Switch Cover Plate

Finish Panels/front Supports	
Cat. No.	Description
75252	"ZC Lower Finish Panel/Bay Face Support *Requires Trim Pieces below"
75253	"ZC Lower Finish Panel/Reg Face Support *Requires Trim Pieces below"
75251	Front Support Ext. Trim Black
75062	Front Support Ext. Trim Gold
75063	Front Support Ext. Trim Nickel

Arched Face Kits	
	
75374	Black Face
75375	Gold Face
75376	Brushed Nickel Face
75377	Black Nickel Face

Insets	
	
75306	ASPEN Black
75308	ASPEN Gold
75307	ASPEN Brushed Nickel
75309	ASPEN Black Nickel
75330	NAPA Black
75332	NAPA Gold
75331	NAPA Brushed Nickel
75333	NAPA Black Nickel
75378	PACIFIC Black
75379	PACIFIC Gold
75380	PACIFIC Brushed Nickel
75381	PACIFIC Black Nickel
75298	TUSCAN Black
75300	TUSCAN Gold
75299	TUSCAN Brushed Nickel
75301	TUSCAN Black Nickel

Traditional Face Kits	
	
Cat. No.	Description
75167	Black Face/gold Trim
75168	Gold Face
75006	Black Nickel Face
75045	Brushed Nickel Face

Face Kits	
Screen Face Kit	
	
75028	Screen Face/double Door/black
Foundry Face Kit	
	
75034	BLACK FACE/Black Nickel Hand-Hammered Straps
Pillar Cast Face Kits	
	
75093	Glass Door (Box 1 Of 3)
75092	Back, Pillars, Top (Box 2 Of 3)
75094	Grille/bars Traditional (Box 3 Of 3) Or
75091	Grille/filigree Ornate (Box 3 Of 3)

# SAFETY / LISTING LABEL

Tested & Listed By **OMNI-TEST** Beaverton Oregon USA  
 OMNI-Test Laboratories, Inc.  
 Report No. / Numéro de Rapport  
 050-S-15c-5

MODEL / MODÈLE **Ravenna™ 40** SERIAL NO. **RDV**

MANUFACTURED BY / FABRIQUÉ PAR:  
**LENNOX HEARTH PRODUCTS**  
 PO BOX 987  
 AUBURN, WA, USA 98071



FACTORY EQUIPPED FOR NATURAL GAS. IF CONTROL PANEL CONTRADICTS THIS LABEL, UNIT FUEL TYPE HAS BEEN CONVERTED. CET APPAREIL EST MUNI D'ÉQUIPEMENT POUR L'USAGE DU GAZ NATUREL. SI L'ÉTIQUETTE DU PANNEAU DES COMMANDES CONTREDIT CETTE ÉTIQUETTE, C'EST QUE LE TYPE DE CARBURANT DE CET APPAREIL A ÉTÉ CONVERTI.

**LISTED VENTED GAS FIREPLACE HEATER - FIREPLACE INSERT - NOT FOR USE WITH SOLID FUEL**  
 TESTED TO ANSI Z21.88-2005/CSA 2.33-2005 "VENTED GAS FIREPLACE HEATERS", UL307b, CSA P.4.1-02, AND CGA 2.17-M91. THIS APPLIANCE MUST BE INSTALLED IN ACCORDANCE WITH LOCAL CODES, IF ANY. IF NOT, FOLLOW THE CURRENT ANSI Z223.1/NFPA 54-LATEST EDITION (USA) OR CAN/CSA B149.1-LATEST EDITION (CANADA). THIS APPLIANCE MUST BE INSTALLED IN ACCORDANCE WITH THE MANUFACTURER'S INSTALLATION INSTRUCTION. FOR INSTALLATION IN SOLID FUEL BURNING FIREPLACES ONLY - MASONRY OR FACTORY BUILT. THIS VENTED GAS FIREPLACE HEATER IS NOT FOR USE WITH AIR FILTERS. THIS APPLIANCE IS ONLY FOR USE WITH THE TYPE OF GAS INDICATED ON THE RATING PLATE AND MAY BE INSTALLED IN AN AFTERMARKET, PERMANENTLY LOCATED, MANUFACTURED (MOBILE) HOME WHERE NOT PROHIBITED BY LOCAL CODES. SEE OWNER'S MANUAL FOR DETAILS. THIS APPLIANCE IS NOT CONVERTIBLE FOR USE WITH OTHER GASES UNLESS A CERTIFIED KIT IS USED.

**DANGER: RISK OF ELECTRICAL SHOCK. DISCONNECT POWER BEFORE SERVICING UNIT.**  
 IF ELECTRICALLY CONNECTED, CONNECTIONS AND GROUNDING MUST BE IN ACCORDANCE WITH LOCAL CODES. IF ANY. IF NOT, FOLLOW THE CURRENT NATIONAL ELECTRICAL CODE ANSI/NFPA 70-LATEST EDITION (USA) OR CSA C22.1-LATEST EDITION (CANADA).

RATINGS	Ravenna 40 (RDV40)		Ravenna 33 (RDV33)	
	NATURAL GAS	LP GAS	NATURAL GAS	LP GAS
MAX/MIN INPUT BTUH 0-2,000 FT (0-610 M)*	40,000/28,000	37,500/26,000	33,000/24,000	33,000/24,000
MANIFOLD PRESSURE (IN. WC)	3.5	10.0	3.5	10.0
MIN. INLET PRESSURE (IN. WC)	5.0	10.5	5.0	10.5
ORIFICE (DMS) 0-2,000 FT (0-610 M)*	1/8"	#49	#36	#51

\*UNIT FACTORY EQUIPPED FOR 0-2000 FT/0-610 M, IN CANADA 0-4500 FT/0-1370 M  
 ELECTRICAL RATING: 120 VAC, 60 HZ, LESS THAN 2 AMPS

**CHIMNEY - USE WITH B-VENT CHIMNEY OR SINGLE WALL GAS VENT FLEX CHIMNEY LINER LISTED TO UL 1777 OR ULC S635.**  
 THIS APPLIANCE MUST BE PROPERLY CONNECTED TO A VENTING SYSTEM IN ACCORDANCE WITH THE MANUFACTURER'S INSTALLATION INSTRUCTIONS.  
 FOR ALTITUDES ABOVE 2,000 FT/610M (IN CANADA 4500 FT/1370M) DE-RATE THE APPLIANCE BY FOUR (4%) FOR EVERY 1,000 FT (405 M).

**WARNING: IF UNIT IS CONVERTED TO AN RDV40 FROM AN RDV33 ENSURE THAT THE CLEARANCES TO COMBUSTIBLES ARE CORRECT FOR RDV40.**

### MINIMUM CLEARANCES TO COMBUSTIBLES

	RDV40	RDV33
E = Top Facing to Bottom of Insert	35.5" (902mm)	31.5" (800mm)
F = Center of Glass to Side Facing or Side Wall	25.5" (648mm)	25.5" (648mm)
*J = 10.5" (267mm) Mantel to Bottom of Insert	43" (1092mm)	39" (991mm)

\* See owner's manual for additional mantel clearances and options

### MINIMUM CLEARANCES

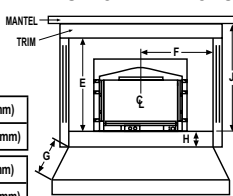

### MINIMUM FIREPLACE SIZES REQUIRED

	RDV40	RDV33
A=29.75" (756mm) Front Opening	14" (356mm)	10" (254mm)
B=19.50" (495mm) Height	0" (0mm)	0" (0mm)
C=19.00" (483mm) Rear Width	0" (0mm)	2" (51mm)
D=16.00" (406mm) Fireplace Depth	0" (0mm)	4" (102mm)

### HEARTH PROTECTION

	RDV33	RDV40
G = Minimum Hearth Protection from Front of Insert	13" (330mm)	10" (254mm)
H = Vertical Distance from Insert Bottom to Combustible Material	0" (0mm)	2" (51mm)

Note: Hearth protection to be min. 3/8" (10mm) thick non-combustible or equivalent, with a k factor of .84.

**CAUTION: HOT WHILE IN OPERATION. DO NOT TOUCH. SEVERE BURNS MAY RESULT. KEEP CHILDREN, CLOTHING, FURNITURE, GASOLINE AND OTHER LIQUIDS HAVING FLAMMABLE VAPORS AWAY. KEEP BURNER AND CONTROL COMPARTMENT CLEAN. SEE INSTALLATION AND OPERATING INSTRUCTIONS ACCOMPANYING APPLIANCE. FOR USE WITH GLASS DOORS CERTIFIED WITH THIS INSTALLATION ONLY. DO NOT OPERATE THE APPLIANCE WITH GLASS REMOVED, CRACKED OR BROKEN. REPLACEMENT OF THE PANEL(S) SHOULD BE DONE BY A LICENSED OR QUALIFIED PERSON.**

**WARNING: IMPROPER INSTALLATION, ADJUSTMENT, ALTERATION, SERVICE OR MAINTENANCE CAN CAUSE INJURY OR PROPERTY DAMAGE. REFER TO THE OWNER'S INFORMATION MANUAL PROVIDED WITH THIS APPLIANCE. FOR ASSISTANCE OR ADDITIONAL INFORMATION CONSULT A QUALIFIED INSTALLER, SERVICE AGENCY OR GAS SUPPLIER.**

Part No./No. pièce #36200 Rev. A, 05/2007

DO NOT REMOVE OR COVER THIS LABEL

### HOMOLOGUÉ FOYER RADIANT PRÉFABRIQUÉ AU GAZ - INSERTION DE FOYER AU GAZ - NE PAS UTILISER AVEC DU COMBUSTIBLE SOLIDE

TESTÉ SELON LA NORME ANSI Z21.88-2005/CSA 2.33-2005 «FOYER RADIANT AU GAZ», UL307B, CSA P.4.1-02, ET CGA 2.17-M91. CET APPAREIL DOIT ÊTRE INSTALLÉ CONFORMÉMENT AUX EXIGENCES DES CODES RÉGIONAUX ET DU CODE D'INSTALLATION ANSI NFPA 54-DERNIÈRE ÉDITION (ÉTATS-UNIS), OU CAN/CSA B149.1-DERNIÈRE ÉDITION (CANADA). CET APPAREIL DOIT ÊTRE INSTALLÉ SELON LES DIRECTIVES D'INSTALLATION DU FABRICANT. POUR L'INSTALLATION DANS DES FOYERS À COMBUSTIBLE SOLIDE SEULEMENT - DE MAÇONNERIE OU PRÉFABRIQUÉ EN USINE. CE FOYER RADIANT AU GAZ À ÉVACUATION N'EST PAS CONÇU POUR ÊTRE UTILISÉ AVEC DES FILTRES À AIR.

CET APPAREIL DOIT ÊTRE UTILISÉ AVEC LE TYPE DE GAZ INDICÉ SUR LA PLAQUE SIGNALÉTIQUE ET PEUT ÊTRE INSTALLÉ DANS UNE MAISON PRÉUSINÉE OU DANS UNE MAISON MOBILE FIXE, LA OÙ LES CODES RÉGIONAUX LE PERMETTENT. VOIR LE MANUEL D'ENTRETIEN POUR PLUS DE DÉTAILS. CET APPAREIL NE PEUT PAS ÊTRE CONVERTI POUR L'USAGE AVEC D'AUTRES TYPES DE GAZ À MOINS D'UTILISER UNE TROUSSE DE CONVERSION HOMOLOGUÉE.

**DANGER: RISQUE DE CHOC ÉLECTRIQUE. DÉBRANCHEZ L'APPAREIL AVANT D'EN FAIRE L'ENTRETIEN.**  
 SI L'APPAREIL REQUIERT UN BRANCHEMENT ÉLECTRIQUE, LES RACCORDEMENTS ET LA MISE À LA TERRE DOIVENT ÊTRE CONFORMES AUX EXIGENCES DES CODES RÉGIONAUX ET DU CODE D'INSTALLATION ANS/NFPA 70 OU CSA C22-1.

SPÉCIFICATIONS	Ravenna 40 (RDV40)		Ravenna 33 (RDV33)	
	GAZ NATUREL	GAZ PROPANE	GAZ NATUREL	GAZ PROPANE
ENTRÉE MAX/MIN BTU/HR 0-4500 pi (0-1370 M)*	40000/28000	37500/26000	33000/24000	33000/24000
PRESSION À LA SORTIE (IN. WC/C.E.)	3.5	10.0	3.5	10.0
PRESSION MINIMUM D'ENTRÉE DU GAZ (IN. WC/C.E.)	5.0	10.5	5.0	10.5
ORIFICE (DMS) 0-4500 pi (0-1370 M)*	1/8"	#49	#36	#51

\*L'APPAREIL PRÉUSINÉ EST MUNI D'ÉQUIPEMENT POUR 0-2000 PIEDS (0-610 M), AU CANADA 0-4500 PIEDS (0-1370M).  
 SPÉCIFICATIONS ÉLECTRIQUE 120 VCA, 60 HZ, MOINS DE 2 AMPÈRES

**CHEMINÉE - ÉVACUATION :** INSTALLER AVEC DE L'ÉVENT À GAZ DE TYPE B-VENT OU UN CONDUIT FLEXIBLE À SIMPLE PARIOL HOMOLOGUÉ COMME TUBAGE.

CET APPAREIL DOIT ÊTRE RELIÉ À UN SYSTÈME D'ÉVACUATION TEL QUE SPÉCIFIÉ DANS LE MANUEL D'INSTALLATION DU FABRICANT.

EN ALTITUDE, AU-DELÀ DE 2000 PI/610 M, (AU CANADA 0-4500 PI/0-1370M) LA CAPACITÉ ÉNERGÉTIQUE DE L'APPAREIL DIMINUE DE QUATRE (4%) POUR CHAQUE 1000 PI (405 M).

**SI LE MODÈLE RDV33 EST CONVERTI COMME MODÈLE RDV40, ASSUREZ VOUS QUE LES DÉGAGEMENT AUX COMBUSTIBLES SONT RESPECTER SELON LE MODÈLE RDV40.**

DÉGAGEMENTS AUX COMBUSTIBLES	RDV40	RDV33
E = Dessus du foyer à partir de la base	35.5" (902mm)	31.5" (800mm)
F = Mur latéral à partir du centre du foyer	25.5" (648mm)	25.5" (648mm)
*J = 10.5" (267mm) manteau de foyer à partir de la base	43" (1092mm)	39" (991mm)

\* Voir le manuel d'entretien pour les informations supplémentaires reliées aux distances à respecter pour le manteau de foyer

### DIMENSIONS MINIMUMS DE FOYER REQUISES

	RDV40	RDV33
A = 29.75" (756mm) Ouverture avant	14" (356mm)	10" (254mm)
B = 19.50" (495mm) Hauteur	0" (0mm)	0" (0mm)
C = 19.00" (483mm) Largeur arrière	0" (0mm)	2" (51mm)
D = 16.00" (406mm) Profondeur du foyer	0" (0mm)	4" (102mm)

### PROTECTION DU FOYER

	RDV33	RDV40
G = Extension d'âtre min. devant le foyer	13" (330mm)	10" (254mm)
H = Distance verticale de la base de l'appareil aux combustibles	0" (0mm)	2" (51mm)

### DÉGAGEMENTS MINIMUMS

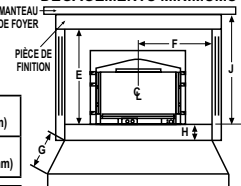

Note: Extension d'âtre fabriqué avec 3/8" (10mm) minimum de matériaux non-combustible ou équivalent possédant un facteur k de 0.84.

**DANGER: CET APPAREIL DÉGAGE DES TEMPÉRATURES ÉLEVÉES ET DEVRAIT ÊTRE INSTALLÉ À L'ÉCART DES ENDROITS TRÈS PASSANTS ET LOIN DES MEUBLES ET RIDEAUX. SURVEILLEZ LES ENFANTS QUI SE TROUVENT DANS LA PIÈCE. GARDEZ LA ZONE AUTOUR DU FOYER EXEMPTÉ DE MATÉRIAUX COMBUSTIBLES, D'ESSENCE ET AUTRES VAPEURS ET LIQUIDES INFLAMMABLES. MAINTENEZ LE BRÛLEUR ET LE BOÎTIER DES COMMANDES PROPRE EN TOUT TEMPS. VOIR LES MANUELS D'INSTALLATION ET D'ENTRETIEN QUI ACCOMPAGNENT L'APPAREIL. SEUL LE PANNEAU VITRÉ FOURNI PAR LE MANUFACTURIER PEUT ÊTRE UTILISÉ AVEC CET APPAREIL. EN AUCUN CAS, L'APPAREIL NE PEUT ÊTRE UTILISÉ SANS LA VITRE OU AVEC LA VITRE BRISÉE. LE REMPLACEMENT DE LA VITRE DOIT ÊTRE EFFECTUÉ PAR UN TECHNICIEN DE SERVICE QUALIFIÉ.**

**AVERTISSEMENT: UNE INSTALLATION INADÉQUATE DE MÊME QU'UN AJUSTEMENT, UNE MODIFICATION, UNE RÉPARATION OU UN ENTRETIEN INCORRECTS PEUVENT CAUSER DES BLESSURES OU DOMMAGES À LA PROPRIÉTÉ. RÉFÉREZ-VOUS AU MANUEL D'ENTRETIEN LIVRÉ AVEC CET APPAREIL. POUR DE L'ASSISTANCE, CONSULTEZ UN INSTALLATEUR QUALIFIÉ, UNE ENTREPRISE DE SERVICE OU UN FOURNISSEUR DE GAZ.**

### DATE OF MANUFACTURE / DATE DE FABRICATION

2007	2008	2009	2010	JAN	FEB	MAR	APR	MAY	JUN	JUL	AUG	SEP	OCT	NOV	DEC
<input type="checkbox"/>	<input type="checkbox"/>	<input type="checkbox"/>	<input type="checkbox"/>	<input type="checkbox"/>	<input type="checkbox"/>	<input type="checkbox"/>	<input type="checkbox"/>	<input type="checkbox"/>	<input type="checkbox"/>	<input type="checkbox"/>	<input type="checkbox"/>	<input type="checkbox"/>	<input type="checkbox"/>	<input type="checkbox"/>	<input type="checkbox"/>

N'ENLEVEZ PAS OU NE COUVREZ PAS CETTE ÉTIQUETTE

IGN

# Lighting Label

## FOR YOUR SAFETY READ BEFORE OPERATING

**WARNING:** IF YOU DO NOT FOLLOW THESE INSTRUCTIONS EXACTLY, A FIRE OR EXPLOSION MAY RESULT CAUSING PROPERTY DAMAGE, INJURY OR LOSS OF LIFE.

**CAUTION:** HOT WHILE IN OPERATION. DO NOT TOUCH. KEEP CHILDREN, FURNITURE, GASOLINE AND OTHER LIQUIDS WITH FLAMMABLE VAPORS AWAY. NEVER OPERATE UNIT WITH GLASS DOOR OFF OR ATTEMPT TO OPEN THE DOOR WHILE HOT.

- This appliance is equipped with a piezo ignition device to light the pilot. When lighting the pilot, follow these instructions exactly.
- BEFORE LIGHTING**, smell around the appliance area for gas. Be sure to smell next to the floor because some gas is heavier than air and will settle on the floor.

### WHAT TO DO IF YOU SMELL GAS:

- DO NOT try to light the appliance.
  - DO NOT touch any electric switch; do not use any phone in the building.
  - Immediately call your gas supplier from a neighbor's phone. Follow the gas supplier's instructions.
  - If you cannot reach your gas supplier, call the fire department.
- Use only your hand to push in or turn the gas control knob. Never use any tool. If the knob will not push in or turn by hand, don't try to repair it, call a qualified service technician. Force or attempted repair may result in a fire or explosion.
  - DO NOT use this appliance if any part has been under water. Immediately call a qualified service technician to inspect the appliance and to replace any part of the control system and any gas control which has been under water.

## OPERATING INSTRUCTIONS

**CAUTION:** YOUR COUNTRY GAS APPLIANCE MUST ALWAYS BE OPERATED WITH GLASS DOOR IN PLACE.

**STOP!** Read the safety information above before proceeding.

- Open the lower door. Make sure gas supply shut-off cocks are open and ON/OFF Rocker Switch is "OFF". If equipped with a thermostat, set it to the lowest setting.
- Turn off all electrical power to the appliance.

3. Push in Gas Control Knob slightly and turn clockwise to "OFF".

**NOTE:** Knob cannot be turned from "PILOT" to "OFF" unless Knob is pushed in slightly. Do not force.

- Wait five (5) minutes to clear out any gas. If you smell gas, **STOP!** Follow "B" above. If you don't smell gas continue.
- Locate the pilot by looking over the top of the front left log. Blue flame will be seen when the pilot is lit.

- Turn the gas control knob counterclockwise to the "PILOT" position.
- Push the knob all the way in and hold in that position. Immediately light the pilot by pressing the ignitor button several times until pilot is lit. Continue to hold the knob in for about 30 seconds after the pilot is lit. Release knob and it will pop back out.

Pilot should remain lit. If it goes out, repeat steps 4-8 holding knob in an additional 15 seconds after pilot is lit.

- If knob does not pop out when released, stop and immediately call your service technician or gas supplier.
- If the pilot will not stay lit after several tries, turn the gas control knob to "OFF" and call your service technician or your gas supplier.

- After pilot is lit, turn gas control knob counterclockwise to "ON". Knob can only be turned "ON" if the knob has popped out.
- To turn burner on, turn "ON/OFF" rocker switch to "ON" or set the thermostat to the desired temperature above room temperature.

- Adjust the flame height (and heat output) by turning the flame height knob clockwise for reduced flame and counterclockwise for full flame.
- Turn on all electrical power to the appliance.

- Set the blower to the desired air flow after it turns on when the appliance reaches operating temperature.

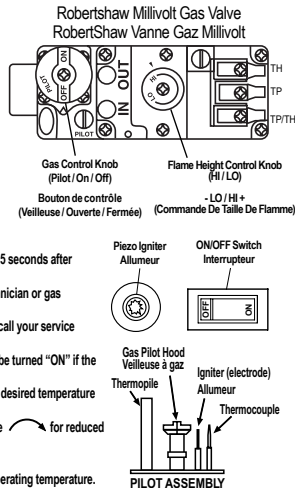

## TO TURN OFF GAS TO APPLIANCE

- Turn off the "ON/OFF" rocker switch and/or thermostat (if installed).
- Turn off electric power to the appliance if service is to be performed.
- Turn gas control knob clockwise to "OFF". Do not force.

This appliance needs fresh air for safe operation and must be installed so there are provisions for adequate combustion and ventilation air. See Installation and Operation Manual accompanying appliance.

**WARNING:** Improper installation, adjustment, alteration, service or maintenance can cause injury or property damage. For assistance or additional information, consult a qualified installer, service agency or your gas supplier.

Operation of this appliance when not connected to a properly installed and maintained venting system can result in carbon monoxide (CO) poisoning and possible death.

## SHUTDOWN PROCEDURE

- To turn off the burner, switch the rocker switch to "OFF" or adjust the thermostat to a setting below room temperature (if installed). The pilot will remain lit for future burner ignition.

#36200 Rev. A, 04/07

For complete shutdown: See "TO TURN OFF GAS TO APPLIANCE" above.

## POUR VOTRE SÉCURITÉ, LIRE AVANT L'ALLUMAGE

**AVERTISSEMENT:** SI VOUS NE RESPECTEZ PAS RIGOREUSEMENT LES INSTRUCTIONS CI-DESSOUS, VOUS POURRIEZ ENCOURIR UN RISQUE D'INCENDIE ET/OU D'EXPLOSION QUI POURRAIENT CAUSER DES DOMMAGES MATÉRIELS ET CORPORELS POUVANT ENTRAÎNER LA MORT.

**DANGER:** CET APPAREIL DÉGAGE DES TEMPÉRATURES ÉLEVÉES ET DEVRAIT ÊTRE INSTALLÉ À L'ÉCART DES ENDOITS TRÈS PASSANTS ET LOIN DES MEUBLES ET RIDEAUX. GARDEZ LA ZONE AUTOUR DU FOYER EXEMPTÉ DE MATÉRIAUX COMBUSTIBLES, D'ESSENCE ET AUTRES VAPEURS ET LIQUIDES INFLAMMABLES.

- Cet appareil utilise un système d'allumage par étincelle (allumeur Piézo-électrique) pour allumer la veilleuse. Assurez-vous de suivre rigoureusement les instructions d'allumage de la veilleuse.

- AVANT D'ALLUMER L'APPAREIL**, assurez-vous qu'il n'y a pas d'odeur de gaz près de l'appareil ni près du sol car certains gaz plus lourds que l'air auraient tendance à s'y accumuler en cas de fuite.

**QUOI FAIRE SI VOUS SENTEZ UNE ODEUR DE GAZ:**

- N'ALLUMEZ aucun appareil.
- Ne touchez aucune prise électrique; N'utilisez aucun téléphone dans votre édifice.
- Sortez de la maison. À partir d'un autre endroit, appelez immédiatement votre fournisseur de gaz et suivez les directives.
- S'il est impossible de joindre le distributeur de gaz, appelez les pompiers.

- N'utilisez aucun outil pour tourner ou pousser le dispositif de contrôle du gaz. Si vous ne pouvez le faire manuellement, n'essayez pas de réparer l'appareil. Appelez un technicien de service qualifié. Si vous tentez de forcer ou réparer le dispositif de contrôle du gaz vous pourriez encourir un risque d'incendie et/ou d'explosion.

- N'utilisez pas cet appareil si une de ses composantes a été émergée dans l'eau. Appelez immédiatement un technicien de service qualifié et reconnu afin qu'il inspecte et remplace au besoin toutes pièces du système qui auraient été en contact avec l'eau.

## ALLUMAGE

**DANGER:** VOTRE APPAREIL AU GAZ LENNOX DOIT ÊTRE OPÉRÉ AVEC DES PORTES DE VERRE.

**ATTENTION!** Lisez les consignes de sécurité ci-dessous avant d'opérer votre appareil.

- Ouvrir la porte du bas. Assurez-vous que l'alimentation en gaz est à la position Fermée "OFF". Si l'appareil est équipé d'un thermostat, placez-le à la température la plus basse.

- Couper le courant électrique qui alimente l'appareil.

- Enfoncez légèrement le bouton de contrôle du gaz et tournez-le dans le sens des aiguilles d'une montre à la position "OFF".

**NOTE:** Le bouton de contrôle du gaz ne peut être tourné de la position "PILOT" à "OFF" sans qu'une légère pression ne soit appliquée.

- Attendez au moins 5 minutes pour que le gaz qui se trouve dans la chambre de combustion puisse s'échapper. Si vous sentez une odeur de gaz **ARRÊTEZ!** Référez-vous à la section B ci-dessus. Si vous ne sentez pas d'odeur de gaz, allez à la prochaine étape.

- Vous localiserez la veilleuse à l'arrière et au centre du brûleur derrière la bûche centrale. Une flamme bleue est visible lorsque la veilleuse est allumée.

- Tournez le bouton de contrôle de gaz dans le sens inverse des aiguilles d'une montre pour le placer sur "PILOT".

- Cet appareil de chauffage est équipé d'un système d'allumage par étincelle (allumeur Piézo-électrique), devant être utilisé pour l'allumage de la veilleuse. Poussez complètement le bouton de contrôle du gaz et le maintenir dans cette position. Appuyez immédiatement sur le bouton (allumeur Piézo-électrique) situé à gauche du robinet de contrôle du gaz. L'étincelle produite par l'allumeur Piézo-électrique doit allumer la veilleuse. Continuez à maintenir le bouton de contrôle dans cette position pendant environ 30 secondes après l'allumage de la veilleuse. Relâchez le bouton de contrôle du gaz qui reviendra à la position initiale. La veilleuse doit rester allumée. Répétez les étapes 4 à 8 pendant 15 secondes supplémentaires si la veilleuse s'éteint.

- Si le bouton de contrôle du gaz ne revient pas à la position initiale une fois relâché, appelez immédiatement un technicien qualifié ou votre distributeur de gaz.
- Si la veilleuse ne reste pas allumée après plusieurs essais, tournez le bouton de contrôle du gaz à la position "OFF" et appelez immédiatement un technicien qualifié ou votre distributeur de gaz.

- Lorsque la veilleuse est allumée, tournez le bouton de contrôle du gaz dans le sens inverse des aiguilles d'une montre pour le placer à la position "ON". Le bouton de contrôle peut-être tourné à la position "ON" seulement si il n'est plus enfoncé.

- Pour allumer le brûleur, mettre l'interrupteur à la position "ON" ou ajustez le thermostat à la température souhaitée.

- Ajustez la flamme et la température souhaitée en tournant le bouton de réglage de la flamme dans le sens des aiguilles d'une montre pour l'abaisser et dans le sens contraire pour l'augmenter.

- Allumez l'alimentation électrique de l'appareil.

- Ajustez le ventilateur au volume désiré lorsque l'appareil aura atteint la température de fonctionnement.

## POUR COUPER L'ALIMENTATION EN GAZ DE L'APPAREIL

- Fermez l'interrupteur et/ou le thermostat «MARCHE/ARRÊT».
- Coupez l'alimentation électrique de l'appareil si vous prévoyez en faire le service.
- Tournez le bouton de commande du gaz dans le sens des aiguilles d'une montre à "OFF". Ne le forcez pas.

Cet appareil a besoin d'air frais pour opérer sereinement et doit être installé pour qu'il y ait un apport en air suffisant. Référez-vous aux manuels d'entretien et d'installation fournis avec l'appareil.

**AVERTISSEMENT:** Une installation inadéquate, un mauvais ajustement, une altération ou toutes autres modifications inappropriées pourraient entraîner des blessures physiques et/ou des dommages matériels. Référez-vous au guide d'utilisation fourni avec ce foyer. Pour assistance ou information supplémentaires contactez un installateur qualifié, un agent de service ou un fournisseur de gaz.

Si vous opérez cet appareil sans qu'il ne soit correctement raccordé à un conduit d'évacuation, vous pourriez risquer d'être empoisonné au monoxyde de carbone (CO) ce qui pourrait entraîner des conséquences graves ou la mort.

## PROCÉDURE D'ARRÊT

- Pour arrêter le brûleur, mettre l'interrupteur à la position "OFF" ou ajustez le thermostat à une température ambiante. La veilleuse restera allumée pour permettre un allumage ultérieur.

Pour un arrêt complet: Consultez la procédure ci-dessus «POUR COUPER L'ALIMENTATION EN GAZ DE L'APPAREIL».

IGN

## WARRANTY

Your gas appliance is covered by a limited warranty (provided with appliance). Please read the warranty to be familiar with its coverage.

Retain this manual. File it with your other documents for future reference.

## PRODUCT REFERENCE INFORMATION

We recommend that you record the following important information about your appliance. Please contact your Lennox Hearth Products dealer for any questions or concerns. For the number of your nearest Lennox Hearth Products dealer, please call 1-800-9-LENNOX.

## REPLACEMENT PARTS

See **Page 20** for a complete replacement parts list. Use only parts supplied from the manufacturer.

Normally, all parts should be ordered through your Lennox distributor or dealer. Parts will be shipped at prevailing prices at time of order.

When ordering repair parts, always give the following information:

1. The model number of the appliance.
2. The serial number of the appliance.
3. The part number.
4. The description of the part.
5. The quantity required.
6. The installation date of the appliance.

If you encounter any problems or have any questions concerning the installation or application of this system, please contact your dealer.

## LENNOX HEARTH PRODUCTS

1110 West Taft Avenue

Orange, CA 92865

Visit us at [www.Lennox.com](http://www.Lennox.com)

Your Appliance's Model Number \_\_\_\_\_

Your Fireplace Insert's Serial Number \_\_\_\_\_

The Date On Which Your Fireplace Insert Was Installed \_\_\_\_\_

The Type of Gas Your Fireplace Insert Uses \_\_\_\_\_

Your Dealer's Name \_\_\_\_\_

Fuel Type (Check one)  Natural Gas  Propane Gas (LP)

NATIONAL  
FIREPLACE  
INSTITUTE



CERTIFIED  
[www.nficertified.org](http://www.nficertified.org)

We recommend that our gas hearth products be installed and serviced by professionals who are certified in the U.S. by the National Fireplace Institute® (NFI) as NFI Gas Specialists.

NATIONAL  
FIREPLACE  
INSTITUTE



CERTIFIED  
[www.nficertified.org](http://www.nficertified.org)

Nous recommandons que nos foyers au gaz soient installés et que l'entretien soit effectué par des professionnels certifiés par le National Fireplace Institute® (NFI). (Etats-Unis seulement)

Lennox™ reserves the right to make changes at any time, without notice, in design, materials, specifications, prices and also to discontinue colors, styles and products. Consult your local distributor for fireplace code information.

**LENNOX**<sup>TM</sup>

**HEARTH PRODUCTS**

1110 West Taft Avenue • Orange, CA 92865



## Free Manuals Download Website

<http://myh66.com>

<http://usermanuals.us>

<http://www.somanuals.com>

<http://www.4manuals.cc>

<http://www.manual-lib.com>

<http://www.404manual.com>

<http://www.luxmanual.com>

<http://aubethermostatmanual.com>

Golf course search by state

<http://golfingnear.com>

Email search by domain

<http://emailbydomain.com>

Auto manuals search

<http://auto.somanuals.com>

TV manuals search

<http://tv.somanuals.com>