

Lang



Service Manual for the Lang Models:

LG-24S, LG-36S, LG-48S, LG-60S, LG-72S,

LG-24, LG-36, LG-48, LG-60, LG-72

XL-24, XL-36, XL-48

PB-12, PB-24

TABLE OF CONTENTS

<u>CHAPTER</u>	<u>PAGE</u>
1. TABLE OF CONTENTS	1
2. READ FIRST	2
3. EQUIPMENT DESCRIPTION.....	4
4. INSTALLATION.....	5
5. START-UP.....	7
6. GENERAL OPERATION	8
7. SEQUENCE OF OPERATION	10
8. TROUBLESHOOTING	11
9. TECHNICAL DATA.....	13
10. WIRING DIAGRAMS	15
11. PARTS LIST	23

- CAUTION:** EACH UNIT IS EXTREMELY HEAVY. FOR SAFE HANDLING, INSTALLER SHOULD OBTAIN HELP AS NEEDED, OR EMPLOY APPROPRIATE MATERIALS HANDLING EQUIPMENT (SUCH AS A FORKLIFT, DOLLY, OR PALLET JACK) TO REMOVE THE UNIT FROM THE SKID AND MOVE IT TO THE PLACE OF INSTALLATION.
- CAUTION:** ANY STAND, COUNTER OR OTHER DEVICE ON WHICH GRIDDLE WILL BE LOCATED MUST BE DESIGNED TO SUPPORT THE WEIGHT OF THE GRIDDLE.
- CAUTION:** SHIPPING STRAPS ARE UNDER TENSION AND CAN SNAP BACK WHEN CUT.

- DANGER:** THIS APPLIANCE MUST BE GROUNDED AT THE TERMINAL PROVIDED. FAILURE TO GROUND THE APPLIANCE COULD RESULT IN ELECTROCUTION AND DEATH.
- WARNING:** INSTALLATION OF THE UNIT MUST BE DONE BY PERSONNEL QUALIFIED TO WORK WITH ELECTRICITY AND PLUMBING. IMPROPER INSTALLATION CAN CAUSE INJURY TO PERSONNEL AND/OR DAMAGE TO EQUIPMENT. UNIT MUST BE INSTALLED IN ACCORDANCE WITH ALL APPLICABLE CODES.

- NOTICE:** The data plate is located behind access panel between controls and grease drawer. The grill voltage, wattage, serial number, wire size, and clearance specifications are on the data plate. This information should be carefully read and understood before proceeding with the installation.
- NOTICE:** The installation of any components such as a vent hood, grease extractors, fire extinguisher systems, must conform to their applicable National, State and locally recognized installation standards.
- NOTICE:** During the first few hours of operation you may notice a small amount of smoke coming off the grill, and a faint odor from the smoke. This is normal for a new grill and will disappear after the first few hours of use.
- CAUTION:** ALWAYS KEEP THE AREA NEAR THE APPLIANCE FREE FROM COMBUSTIBLE MATERIALS.
- CAUTION:** KEEP FLOOR IN FRONT OF EQUIPMENT CLEAN AND DRY. IF SPILLS OCCUR, CLEAN IMMEDIATELY, TO AVOID THE DANGER OF SLIPS OR FALLS.



WARNING: KEEP WATER AND SOLUTIONS OUT OF CONTROLS. NEVER SPRAY OR HOSE CONTROL CONSOLE, ELECTRICAL CONNECTIONS, ETC.



CAUTION: MOST CLEANERS ARE HARMFUL TO THE SKIN, EYES, MUCOUS MEMBRANES AND CLOTHING. PRECAUTIONS SHOULD BE TAKEN TO WEAR RUBBER GLOVES, GOGGLES OR FACE SHIELD AND PROTECTIVE CLOTHING. CAREFULLY READ THE WARNING AND FOLLOW THE DIRECTIONS ON THE LABEL OF THE CLEANER TO BE USED.



NOTICE: Service on this, or any other, LANG appliance must be performed by qualified personnel only. Consult your authorized service station directory or call the factory at 1-800-224-LANG (5264), or WWW.LANGWORLD.COM for the service station nearest you.



WARNING: BOTH HIGH AND LOW VOLTAGES ARE PRESENT INSIDE THIS APPLIANCE WHEN THE UNIT IS PLUGGED/WIRED INTO A LIVE RECEPTACLE. BEFORE REPLACING ANY PARTS, DISCONNECT THE UNIT FROM THE ELECTRIC POWER SUPPLY.



CAUTION: USE OF ANY REPLACEMENT PARTS OTHER THAN THOSE SUPPLIED BY LANG OR THEIR AUTHORIZED DISTRIBUTORS CAN CAUSE BODILY INJURY TO THE OPERATOR AND DAMAGE TO THE EQUIPMENT AND WILL VOID ALL WARRANTIES.



ELECTRIC GRIDDLE

EXTERIOR

◆ **Griddle**

- The griddle dimensions are 17" (43.18cm) High, 30" (76.20cm) Deep, and width is dependent on the actual model number.
- The Sides, Bottom, and Rear wall are constructed of double wall stainless steel, which allows closer installation to combustible surfaces.
- The griddle surface is made of 1" thick, highly polished steel to reduce hot and cold spots, recovery problems, warping, and ensure even heat to the edges of the griddle.

◆ **XL Hood**

- The Hood dimension (including griddle) are 22¼" (55.88cm) High with hood down, 44¾" (113.67cm) High with hood up, 31½" (80cm) Deep, and 24" (61cm) Wide.
- The Hood wrap is constructed of stainless steel and uses infrared heat to broil the product.

◆ **Pane Bella**

- The Pane Bella dimensions are 12" (30.5cm) High with hood down, 24.5" (62.25cm) with hood up, 16" (40.5 cm) Deep and width is dependent on model number.

CONTROLS

The Electric Griddle is available either with the Lang Accu-Temp (LG-24, 36, 48, 60, 72) controls or the Lang Selectronic (LG-24S, 36S, 48S, 60S, 72S):

◆ **LG (ACCU-TEMP)**

- Each twelve-inch section has its own easy to use manual thermostat with a temperature range from 175°F to 450°F in 50° increments.
- Each twelve-inch section has a set of 6 K.W. elements for high efficiency, quick recovery and outstanding performance.

◆ **LGS (SELECTRONIC)**

- Each twelve-inch section has its own temperature selector switch that snaps into place to lock in any temperature from 175°F to 450°F in 25° increments.
- Each twelve-inch section of the griddle is controlled by an area sensitive RTD probe, which can sense and react to a temperature change of +/- 4°F.
- Each twelve-inch section has a set of 6 K.W. elements for high efficiency, quick recovery and outstanding performance.

◆ **Pane Bella**

- Each twelve-inch section has its own easy to use manual thermostat with a knob.
- Each 12" section has its own 900 Watt element in the bottom and 720 Watt in the top.

INSTALLATION

RECEIVING THE GRIDDLE

Upon receipt, check for freight damage, both visible and concealed. Visible damage should be noted on the freight bill at the time of delivery and signed by the carrier's agent. Concealed loss or damage means loss or damage, which does not become apparent until the merchandise has been unpacked.

If concealed loss or damage is discovered upon unpacking, make a written request for inspection by the carrier's agent within 15 days of delivery. All packing material should be kept for inspection.

Do not return damaged merchandise to Lang Manufacturing Company. File your claim with the carrier.

Prior to un-crating, move the range as near its intended location as practical. The crating will help protect the unit from the physical damage normally associated with moving it through hallways and doorways.

ELECTRICAL CONNECTION

LG / LGS

There is one power supply connection on 2, 3 and 4 foot griddles. There are two power supply connections on 5 and 6-foot griddles. Refer to the power supply chart in the Technical Data portion of this manual, for proper power supply size.

There is (1) one 1 1/4-inch conduit knockout on 2, 3, and 4-foot griddles located at the rear of the griddle, through the back and the bottom of the griddle body. There are (2) two 1 1/4-inch conduit knockouts provided on the 5 and 6 foot griddles. Use a supply wire suitable for at least 90 degree centigrade.

The model LG-S griddle is shipped from the factory wired for 208/240 or 480 volts, the 208/240 griddle is a dual voltage design. Jumper wires on terminal strip next to the main power supply connection determine the griddle voltage. For a 208 volt power supply, leave the jumpers in place. For a 240 volt power supply disconnect the jumpers as indicated on the tag to the terminal strip. The 480 volt griddle can be operated on 480 volts only.

PB

All PB-24 grills are supplied with a 48" 10 gauge cord and a NEMA L6-30P plug.

The PB-12 grill is supplied with a 48" 12 gauge cord and a NEMA L6-30P plug on the 240 Volt and NEMA 5-15P plug on the 120 Volt

XL HOOD

Power connection can be made at a two pole terminal block located next to the power connection on the grill.

All XL Hoods are single phase and come in either 208 Volt or 240 Volt.

INSTALLATION CONT'D

PHASING

LG / LGS

All griddles are shipped from the factory set up for a three- phase service. Rearrange the wires in the power supply terminal block to convert the griddle to single phase. Rephasing the griddle is not chargeable to Lang Manufacturing Company as warranty. To convert to single phase follow the chart below.

Model Number	Three Phase			Single Phase	
	Line 1	Line 2	Line 3	Line1	Line 2
LG-24	1,4	2	3	1,3	2,6
LG-36	1,4	2,5	3,6	1,3,5	2,4,6
LG-48	1,4,7	2,5,8	3,6,9	1,3,5,7	2,4,6,8
LG-60 #1	1,4	2,5	3,6	1,3,5	2,4,6
LG-60 #2	1,4	2	3	1,3	2,6
LG-72 #1	1,4	2,5	3,6	1,3,5	2,4,6
LG-72 #2	1,4	2,5	3,6	1,3,5	2,4,6

PB

All griddles are shipped single phase.

START-UPS

ELECTRIC GRIDDLES

Electric Griddle Start-Up

1) Verify connections at plug and terminal block

2) Incoming Volt - Single Phase L1-L2 _____
Three Phase L1-L2 _____ L2-L3 _____ L3-L1 _____

3) Amp draw L1 _____
L2 _____
L3 _____

6) Verify actual temperature at 350 °F _____ °F.

Note: Install thermocouple wire in center of 12 section for that control area.
Let griddle cycle off and on 3 times before recording temperature.

Model # _____ Date _____ Serial # _____

Store # _____ Tech Name _____
Contact _____ Company _____
Store Phone # _____ Service Company Phone # _____

Address _____

GENERAL

GENERAL

The suggested time and temperature chart (below) is provided as a guide for the products listed only.

CAUTION: ALWAYS KEEP THE AREA NEAR THE APPLIANCE FREE FROM COMBUSTIBLE MATERIALS.



CAUTION: KEEP FLOOR IN FRONT OF EQUIPMENT CLEAN AND DRY. IF SPILLS OCCUR, CLEAN IMMEDIATELY, TO AVOID THE DANGER OF SLIPS OR FALLS.



SUGGESTED TIMES AND TEMPERATURES		
PRODUCTS	TEMPERATURE (F)	TIME (MIN)
HAMBURGER	350	
2 patties per LB	350	6 to 8
4 patties per LB	350	4 to 6
6 patties per LB	350	3 to 4
STEAKS		
1/2 to 3/4 inch thick, cooked medium	375	5 to 7
3/4 to 1 inch thick, cooked medium	375	8 to 10
Lamb Chops	350	6 to 8
Pork Chops	350	6 to 8
Salmon	350	6 to 8
Halibut	325	6 to 8
Snapper	325	6 to 8
Hashbrown Potatoes	375	3 to 4
Bacon	350	3 to 4
Sausage Links or Patties	350	3 to 4
Ham (Pre-cooked)	375	2
Eggs	275	2 to 4
Note: The times and temperatures in this chart are intended as a general guide and starting point. Your actual times and temperatures may vary from this chart.		

If different temperature settings are to be used, select one side of the griddle and operate at the lowest temperature. Adjoining sections should be set at progressively higher temperatures. Do not try to operate the end sections hot and the center sections cool.

OPERATIONS

An understanding of how the griddle sections are controlled will be a valuable aid in loading your griddle.

Each 12 inch section of your griddle is independently controlled by a temperature controller. The temperature control sensor is mounted in the center of each cooking section under the griddle plate.

If the product is loaded directly over the temperature sensor, that section will turn on and the burner will heat the entire cooking section. If the product is loaded to the side, front or back of the temperature sensor, the thermostat will react to the temperature change much slower.

During slow periods with minimal loads, do not load directly over the thermostat sensors as this will unnecessarily turn the burners on and overheat the remainder of the section not being utilized.

Turn the product and continue cooking until it has reached its desired degree of doneness.

Remove the product from the griddle.

When reloading the griddle, first use the griddle surface on which a previous load was not placed. This will help insure the proper griddle temperature.

SEQUENCE OF OPERATION

LG Griddle

208/ 240 VAC to Thermostat.

Thermostat turned on.

208/ 240 VAC to Elements.

LGS Griddle

Power switch turned to on:

208/240 VAC to poles of each sections contactor.

240/24 Transformer energized.

Individual section switch turned to on.

24VAC across pins 9 & 7 on computer board.

Temperature set.

24 VAC across pins 8 & 6 on computer board.

Contactor energizes.

Elements heat up.

Pane Bella Griddle

120/208/240 VAC to 12 Pole terminal strip.

120/208/240 VAC to Thermostat.

Temperature set.

120/208/240 VAC to elements.

Elements heat up.

XL HOOD

Power switch turned to on:

208/240 VAC to poles of contactor.

Hood lowered.

208/240 to coil of contactor.

208/240 to elements.

TROUBLESHOOTING

LG Griddle:

PROBLEM	SOLUTION
Whole griddle will not heat	<ul style="list-style-type: none"> ➤ Confirm that Circuit breakers are on. ➤ Confirm that griddle is connected properly.
One Section will not heat	<ul style="list-style-type: none"> ➤ Confirm that elements have power. ➤ Confirm that thermostat is operating properly.

LGS Griddle

PROBLEM	SOLUTION
Whole Griddle will not heat	<ul style="list-style-type: none"> ➤ Confirm that incoming power is correct. ➤ Confirm that power switch is operating properly. ➤ Confirm that Transformer is operating properly.
One section will not heat	<ul style="list-style-type: none"> ➤ Check Probe for normal operation. ➤ Check contactor for normal operation. (24 VAC, 11Ω) ➤ Confirm that board heat call light (amber light) is on. <p>If no amber light is detected:</p> <ul style="list-style-type: none"> ➤ Check for 24 VAC across pins 9 and 7. <p>If voltage is not present:</p> <ul style="list-style-type: none"> ➤ Check wiring from transformer. <p>If voltage is present:</p> <ul style="list-style-type: none"> ➤ Check 12-position switch. ➤ Confirm that probe is operating. <p>If amber light is detected:</p> <ul style="list-style-type: none"> ➤ Check for 24 VAC across pins 6 and 8. <p>If 24 VAC is not present:</p> <ul style="list-style-type: none"> ➤ Replace Circuit board. <p>If 24 VAC is present:</p> <ul style="list-style-type: none"> ➤ Check door switch for normal operation.

TROUBLESHOOTING CONT'D

Pane Bella

PROBLEM	SOLUTION
Grill will not heat	<ul style="list-style-type: none">➤ Confirm that incoming power is correct.➤ Check thermostat for normal operation.➤ Check elements for proper operation.➤ Confirm that there are no breaks in the wires.

XL Hood

PROBLEM	SOLUTION
Hood will not heat	<ul style="list-style-type: none">➤ Confirm that incoming power is correct.➤ Check elements for proper operation.➤ Confirm that power switch is operating properly.➤ Check Hi-Temp switch for normal operation.➤ Check Tilt switch for normal operation.➤ Confirm that contactor is operating properly.

TECHNICAL DATA

ELEMENT RESISTANCE

➤ 208 / 240 Volt I/S	11030-29	LG Griddle	9 Ω / 9.6 Ω	23 / 25 Amps
➤ 208 Volt O/S	11030-30	LG Griddle	29 Ω	8 Amps
➤ 480 Volt	11030-31	LG Griddle	38 Ω	12.5 Amps
➤ 120 Volt Bottom	11030-51	PB Griddle	13.5 Ω	9 Amps
➤ 120 Volt Top	11030-50	PB Griddle	17 Ω	7 Amps
➤ 208/240 Volt Bottom	11030-40	PB Griddle	48 Ω / 64 Ω	4 / 3 Amps
➤ 208/240 Volt Top	11030-41	PB Griddle	60 Ω / 80 Ω	3.5 / 3 Amps
➤ 104 Volt	11160-26-1	XL Hood	11 Ω	9.5 Amps
➤ 120 Volt	11160-27-1	XL Hood	14.5 Ω	8.3 Amps

TRANSFORMER RESISTANCE

TRANSFORMER	Part #	Input	Primary	Secondary	Output
➤ 240/24 Volt	31400-10	240 Volt	73.8 Ω	1 Ω	24 Volt

CONTACTOR RESISTANCE

CONTACTOR	Part #	Coil
➤ 2 Pole 24 Volt coil	30701-04	11 Ω

GRIDDLE LINE AMPERAGE, AND WATTAGE

MODEL NUMBER	TOTAL K.W.	NOMINAL AMPS PER LINE									SINGLE PHASE		
		THREE PHASE									208V	240V	
		208 Volt			240 Volt			480 Volt					
		L1	L2	L3	L1	L2	L3	L1	L2	L3			
24"	12.0	50.0	28.8	28.8	43.3	25.0	25.0	21.7	12.5	12.5	57.7	50.0	
36"	18.0	50.0	50.0	50.0	43.3	43.3	43.3	21.7	21.7	21.7	86.5	75.0	
48"	24.0	75.0	75.0	50.0	65.0	65.0	43.3	32.5	32.5	21.7	115.4	100.0	
60"	#1	18.0	50.0	50.0	50.0	43.3	43.3	43.3	21.7	21.7	21.7	86.5	86.5
	#2	12.0	50.0	28.8	28.8	43.3	25.0	25.0	21.7	12.5	12.5	57.7	50.0
72"	#1	18.0	50.0	50.0	50.0	43.3	43.3	43.3	21.7	21.7	21.7	86.5	75.0
	#2	18.0	50.0	50.0	50.0	43.3	43.3	43.3	21.7	21.7	21.7	86.5	75.0

XL HOOD LINE AMPERAGE, AND WATTAGE

TOTAL K.W	AMPS	
	SINGLE PHASE	
	208 VOLT	240 VOLT
6.0	28.9	25.0

TECHNICAL DATA CONT'D

PROBE RESISTANCE

TEMP	RESISTANCE	VOLT DROP	TEMP	RESISTANCE	VOLT DROP
70°	556 Ω	1.11	290°	881 Ω	1.76
80°	569 Ω	1.14	300°	897 Ω	1.79
90°	583 Ω	1.17	310°	914 Ω	1.83
100°	596 Ω	1.19	320°	931 Ω	1.86
110°	610 Ω	1.22	330°	948 Ω	1.90
120°	623 Ω	1.25	340°	965 Ω	1.93
130°	637 Ω	1.27	350°	983 Ω	1.97
140°	651 Ω	1.3	360°	1000 Ω	2.00
150°	665 Ω	1.33	370°	1018 Ω	2.04
160°	678 Ω	1.36	380°	1036 Ω	2.07
170°	694 Ω	1.39	390°	1054 Ω	2.11
180°	709 Ω	1.42	400°	1072 Ω	2.14
190°	724 Ω	1.45	410°	1090 Ω	2.18
200°	739 Ω	1.48	420°	1109 Ω	2.22
210°	754 Ω	1.51	430°	1127 Ω	2.25
220°	769 Ω	1.54	440°	1146 Ω	2.29
230°	785 Ω	1.57	450°	1165 Ω	2.33
240°	800 Ω	1.60	460°	1184 Ω	2.37
250°	816 Ω	1.63	470°	1204 Ω	2.41
260°	832 Ω	1.66	480°	1223 Ω	2.45
270°	848 Ω	1.70	490°	1243 Ω	2.49
280°	864 Ω	1.73	500°	1263 Ω	2.53

NOTE

Probe is factory checked at 350 °F. Must be completely disconnected from circuit board when measuring probe resistance.

WIRING DIAGRAM LG 208/240

ELEMENT HOOKUP	
208V	240V
INSTALL JUMPER ④	REMOVE JUMPER ④

- ① GRIDDLE ELEMENTS
- ② GRIDDLE PILOT LAMP
- ③ GRIDDLE THERMOSTAT
- ④ JUMPER
- ⑤ TERMINAL BLOCK

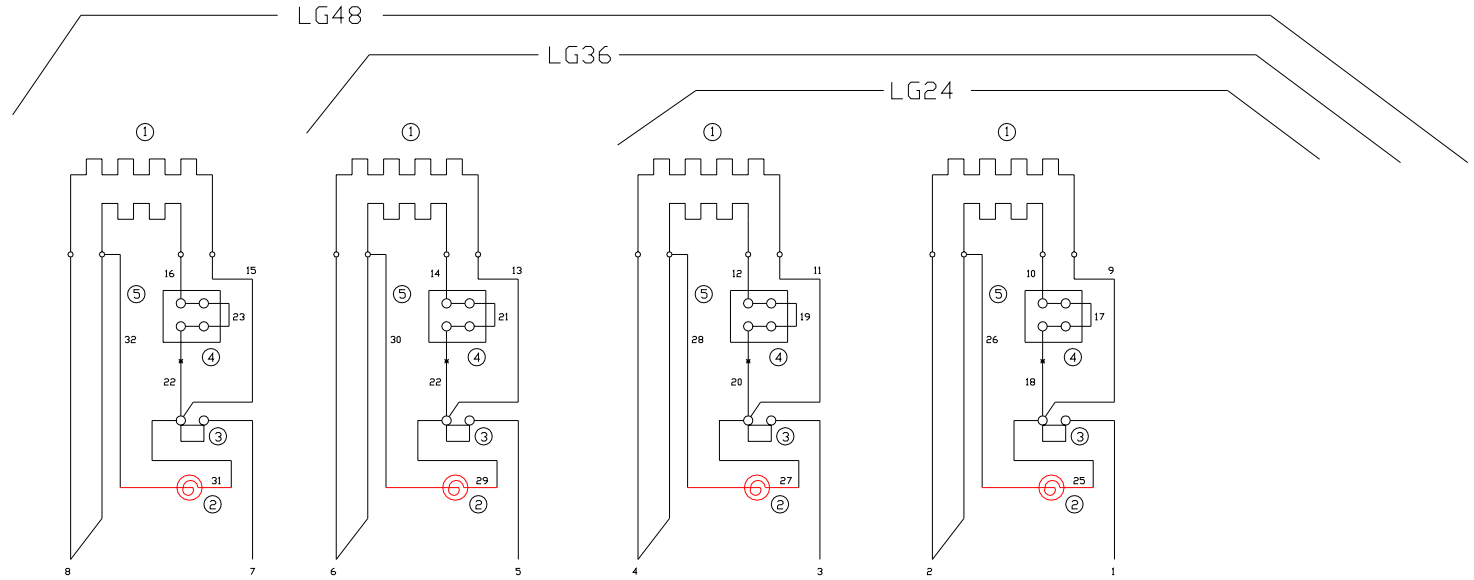

NOTE: LG60 & LG72 HAVE TWO POWER SUPPLY CONNECTIONS

LG60: CONN # 1 USE LG36
CONN # 2 USE LG24

LG72: CONN # 1 USE LG36
CONN # 2 USE LG36

MODEL	K.W.			
	L1-L2	L2-L3	L3-L1	TOTAL
24	6.0	0.0	6.0	12.0
36	6.0	6.0	6.0	18.0
48	12.0	6.0	6.0	24.0

SERVICE CONNECTIONS					
THREE PHASE			SINGLE PHASE		
L1	L2	L3	L1	L2	
1,4	2	3	1,3	2,4	
1,4	2,5	3,6	1,3,5	2,4,6	
1,4,7	2,5,8	3,6	1,3,5,7	2,4,6,8	

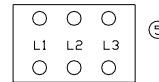

WIRING DIAGRAM LG 480

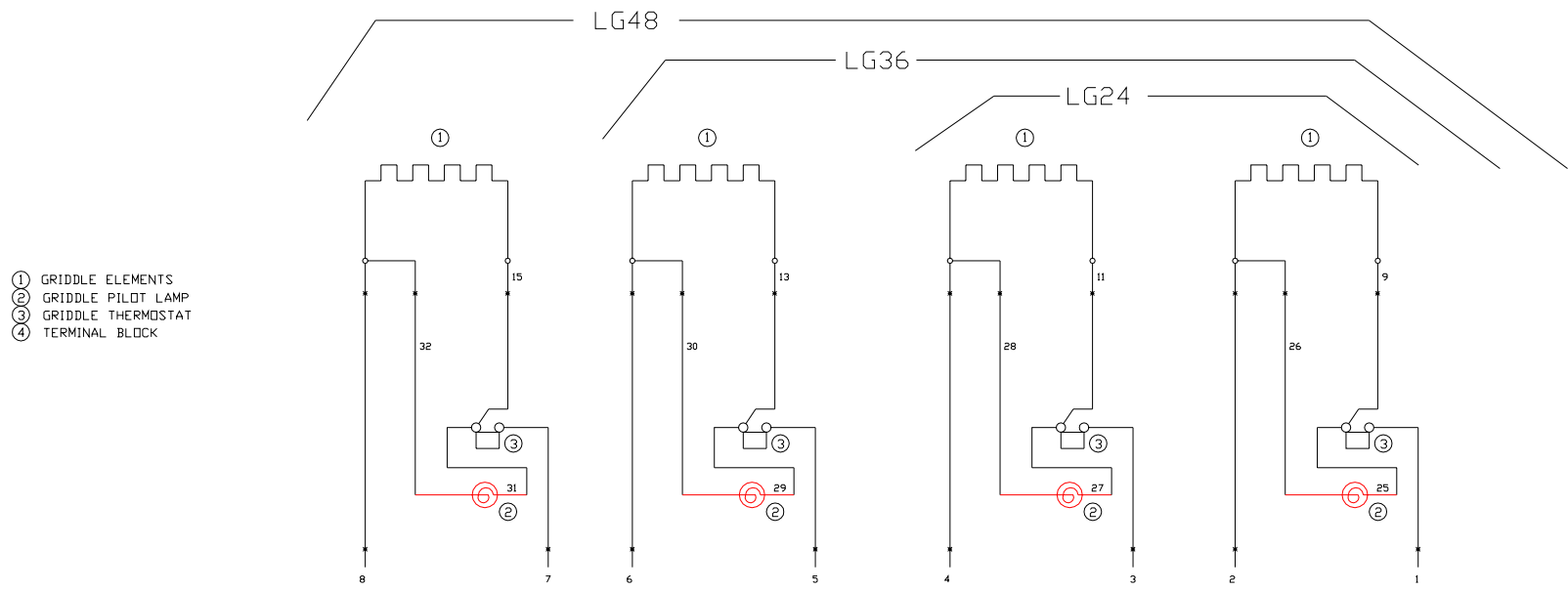

NOTE: LG60 & LG72 HAVE TWO POWER SUPPLY CONNECTIONS

LG60: CONN # 1 USE LG36
 CONN # 2 USE LG24

LG72: CONN # 1 USE LG36
 CONN # 2 USE LG36

SERVICE CONNECTIONS			
MODEL	THREE PHASE		
	L1	L2	L3
24	1,4	2	3
36	1,4	2,5	3,6
48	1,4,7	2,5,8	3,6

* NUMBER

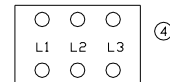

WIRING DIAGRAM LG-S 208/240

ELEMENT HOOKUP	
208V	240V
INSTALL JUMPER	REMOVE JUMPER
④	④

- ① GRIDDLE ELEMENTS
- ② GRIDDLE PILOT LAMP
- ③ CONTACTOR
- ④ JUMPER
- ⑤ TERMINAL BLOCK
- ⑥ TEMP. CONTROL BOARD
- ⑦ 12 POSITION SWITCH
- ⑧ TOGGLE SWITCH
- ⑨ TRANSFORMER
- ⑩ PROBE

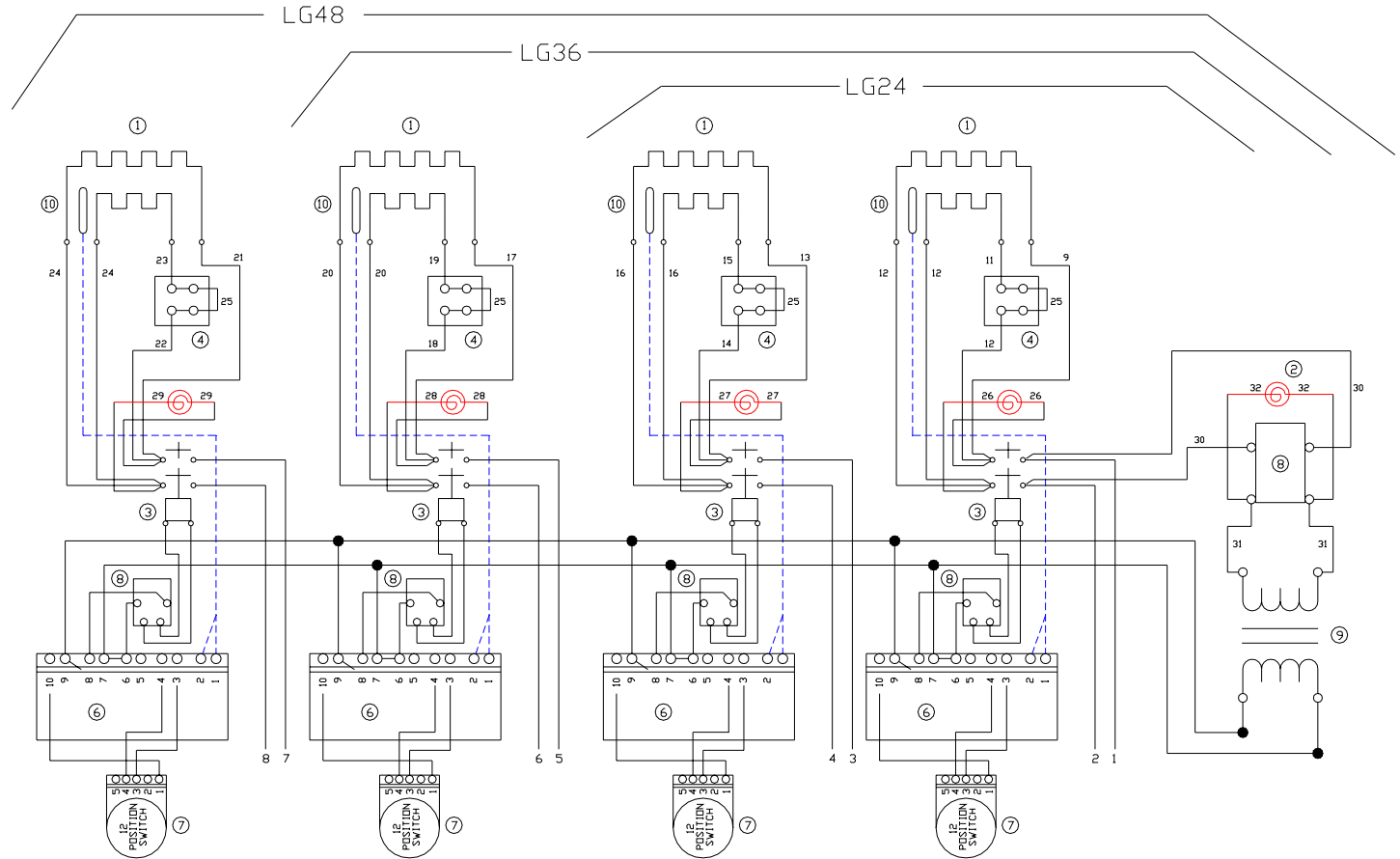

NOTE: LG60 & LG72 HAVE TWO POWER SUPPLY CONNECTIONS

LG60: CONN # 1 USE LG36
CONN # 2 USE LG24

LG72: CONN # 1 USE LG36
CONN # 2 USE LG36

SERVICE CONNECTIONS

MODEL	K.W.			
	L1-L2	L2-L3	L3-L1	TOTAL
24	6.0	0.0	6.0	12.0
36	6.0	6.0	6.0	18.0
48	12.0	6.0	6.0	24.0

THREE PHASE			SINGLE PHASE	
L1	L2	L3	L1	L2
1,4	2	3	1,3	2,4
1,4	2,5	3,6	1,3,5	2,4,6
1,4,7	2,5,8	3,6	1,3,5,7	2,4,6,8

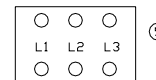

WIRUNGSSCHEMATA LGS 480

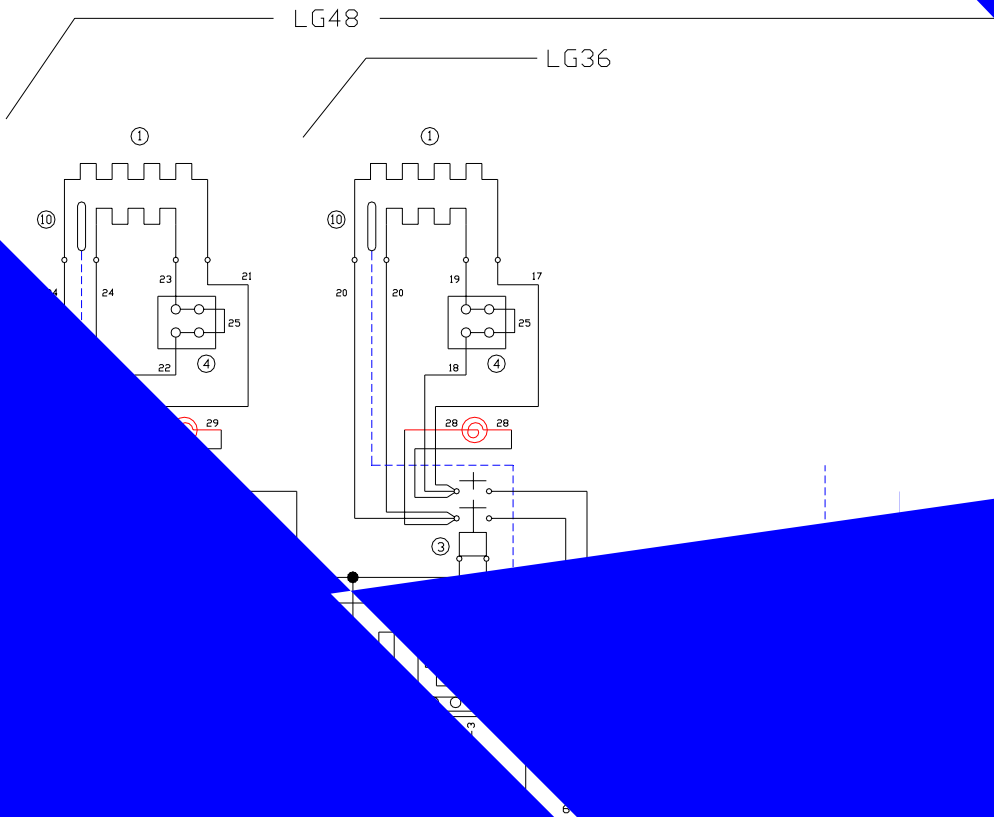

PB-24 208/240 WIRING DIAGRAM

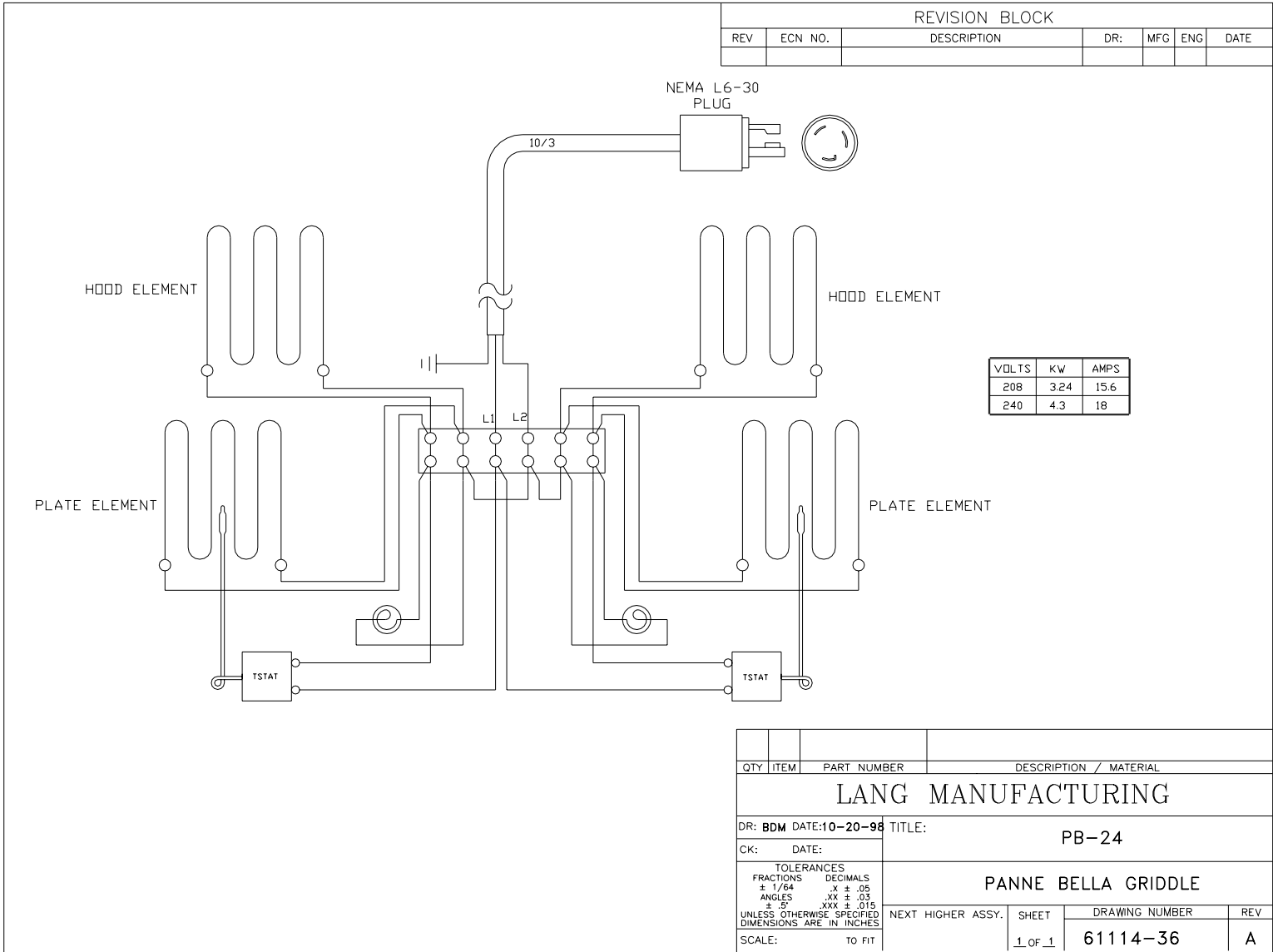

QTY	ITEM	PART NUMBER	DESCRIPTION / MATERIAL						
LANG MANUFACTURING									
DR: BDM DATE: 10-20-98		TITLE: PB-24							
CK:	DATE:	PANNE BELLA GRIDDLE							
TOLERANCES FRACTIONS DECIMALS ± 1/64 .X ± .05 ANGLES .XX ± .03 ± .5" .XXX ± .015 UNLESS OTHERWISE SPECIFIED DIMENSIONS ARE IN INCHES									
SCALE: TO FIT		NEXT HIGHER ASSY:	<table border="1" style="width: 100%; border-collapse: collapse;"> <tr> <th>SHEET</th> <th>DRAWING NUMBER</th> <th>REV</th> </tr> <tr> <td style="text-align: center;">1 OF 1</td> <td style="text-align: center;">61114-36</td> <td style="text-align: center;">A</td> </tr> </table>	SHEET	DRAWING NUMBER	REV	1 OF 1	61114-36	A
SHEET	DRAWING NUMBER	REV							
1 OF 1	61114-36	A							

PB-12 120 WIRING DIAGRAM

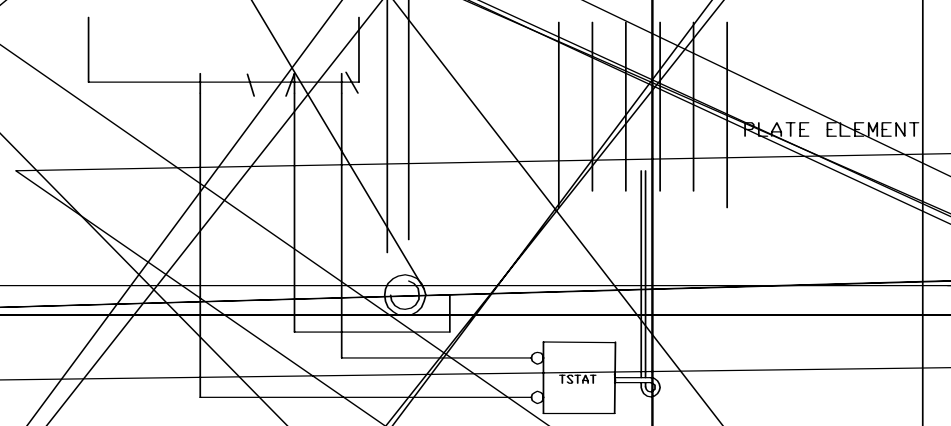

PB-12, 208/240 WIRING DIAGRAM

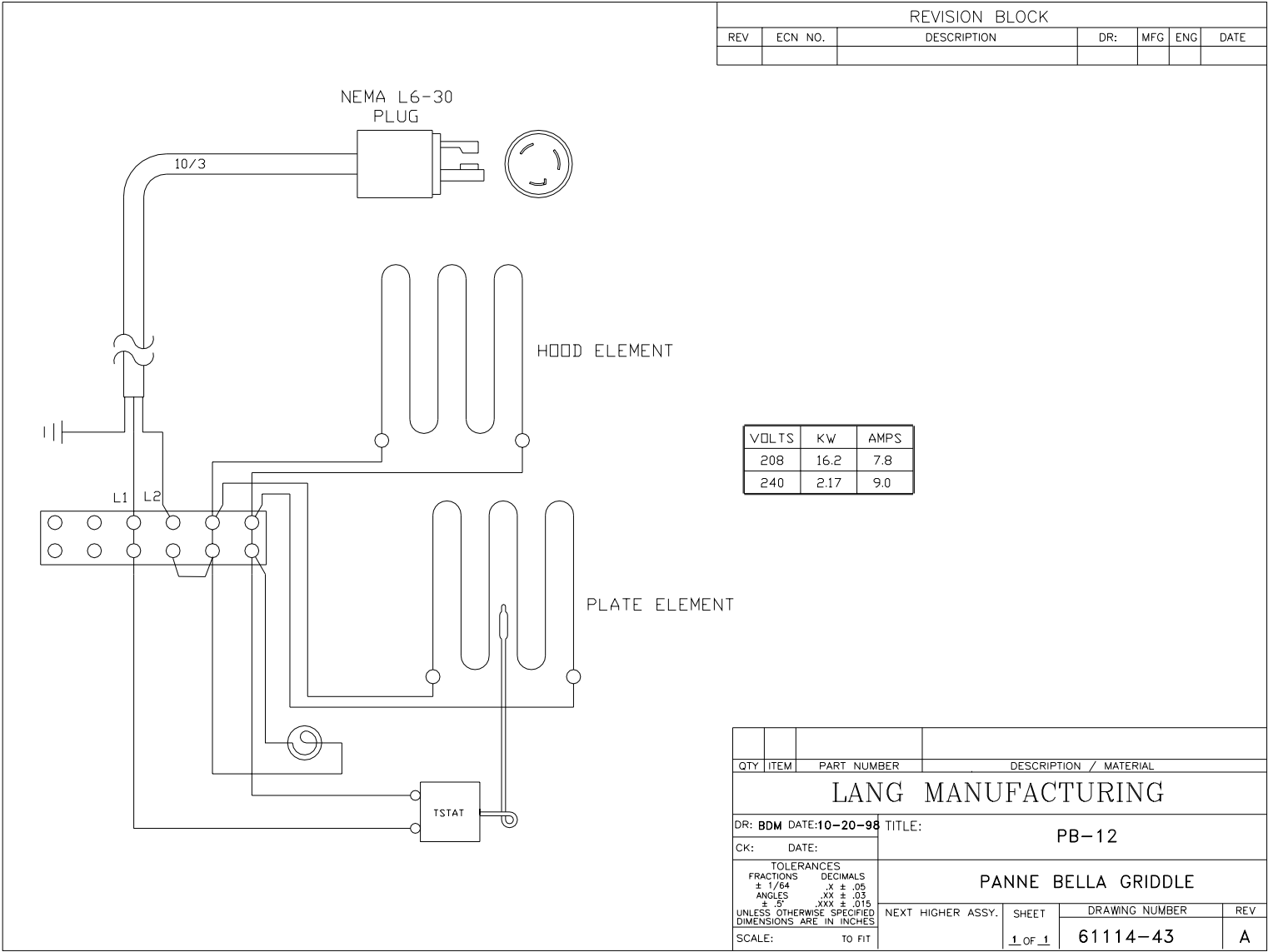

REVISION BLOCK						
REV	ECN NO.	DESCRIPTION	DR:	MFG	ENG	DATE

VOLTS	KW	AMPS
208	16.2	7.8
240	2.17	9.0

QTY	ITEM	PART NUMBER	DESCRIPTION / MATERIAL
LANG MANUFACTURING			
DR: BDM		DATE: 10-20-98	TITLE: PB-12
CK: DATE:		PANNE BELLA GRIDDLE	
TOLERANCES FRACTIONS DECIMALS ± 1/64 .X ± .05 ANGLES .XX ± .03 ± 5° .XXX ± .015 UNLESS OTHERWISE SPECIFIED DIMENSIONS ARE IN INCHES		NEXT HIGHER ASSY.	SHEET
SCALE: TO FIT		DRAWING NUMBER	REV
		1 OF 1	61114-43 A

XL HOOD

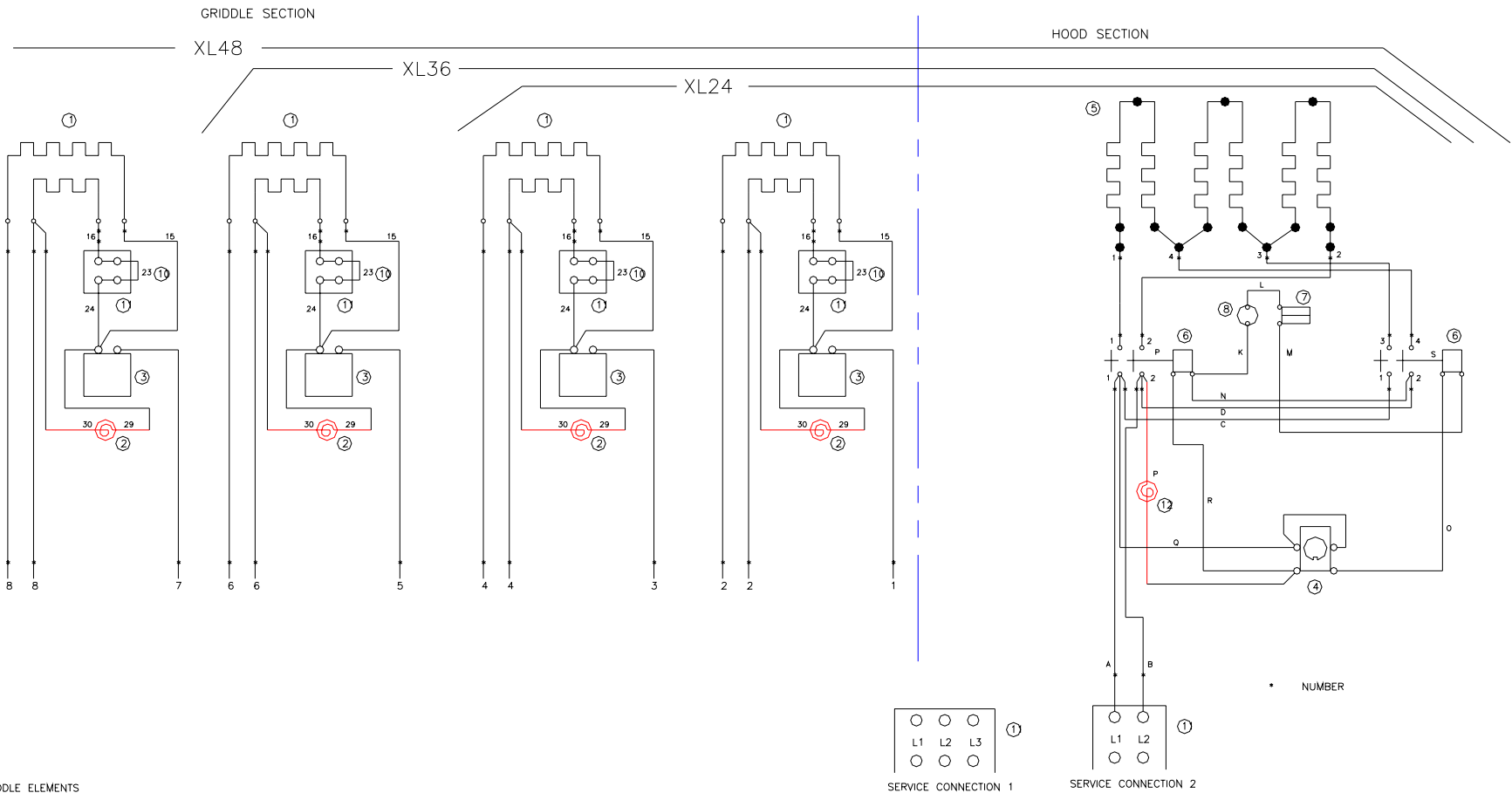

- 1 GRIDDLE ELEMENTS
- 2 GRIDDLE PILOT LAMP
- 3 GRIDDLE THERMOSTAT
- 4 BROILER POWER SWITCH
- 5 HEATERS
- 6 CONTACTOR
- 7 BROILER SWITCH
- 8 PRESET HIGH TEMP. CUT OFF SW.
- 9 WIRE NUT
- 11 TERMINAL BLOCK
- 12 BROILER PILOT LAMP

MODEL	THREE PHASE			SINGLE PHASE		2	
	L1	L2	L3	L1	L2	L1	L2
XL24	1,4	2	3	1,3	2,4	A	B
XL36	1,4	2,5	3,6	1,3,5	2,4,6	A	B
XL48	1,4,7	2,5,8	3,6	1,3,5,7	2,4,6,8	A	B

ELEMENT HOOK UP	
208V	240V
INSTALL JUMPER	REMOVE JUMPER
(10)	(10)

LG-24, LG-36, LG-48, LG-60, LG-72**ELECTRIC GRIDDLE**

DESCRIPTION	PART NO.
Element Griddle 380 Volt 5991 Watts	11030-04
Element Griddle 208/240 Volt I/S 4500/5991 Watts	11030-29
Element Griddle 208 Volt O/S 1491 Watts	11030-30
Element Griddle 480 Volt 5991 Watts	11030-31
Thermostat 550°F Griddle (Grooved Griddles Only)	30402-07
Thermostat 450°F Griddle	30402-08
Terminal Strip 4 Pole, LG-24	30500-02
Terminal Strip 6 Pole, LG-36	30500-03
Terminal Strip 8 Pole, LG-48	30500-05
Terminal Block 3 Pole	30500-07
Power Cord with Molded Plug	31107-02
Pilot Light 208/240V 6" Lead Black Body	31601-01
Pilot Light 480 Volt 6" Lead Black Body	31601-02
Grooved Griddle Cleaning Tool	50100-05
Grooved Griddle Cleaning Tool – Replacement Fingers	50100-051
Grooved Griddle Cleaning Tool – Replacement Blades	50100-052
Element Pan Assembly	50302-05
Knob Thermostat 550°F (Grooved Griddles Only)	70701-15
Knob Thermostat 450°F	70701-19
Legs 4" Stainless Steel	72500-02
Wiring Harness (LG-24 1ea, LG-60 1ea)	XL-575
Wiring Harness (LG-36 1ea, LG-60 1ea, LG-72 2ea)	XL-577
Wiring Harness (LG-48)	XL-579

LG-24S, LG-36S, LG-48S, LG-60S, LG-72S**ELECTRIC SELECTRONIC GRIDDLE**

DESCRIPTION	PART NO.
Element Griddle 208/240 Volt I/S 4500/5991 Watts	11030-29
Element Griddle 208 Volt O/S 1491 Watts	11030-30
Element Griddle 480 Volt 5991 Watts	11030-31
Switch Toggle On-Off	30303-06
Switch Temperature Control 12 Position 174-450°F (Before D-70205)	30304-17
Switch Temperature Control 12 Position 174-450°F (After D-70205)	30304-22
Terminal Strip 4 Pole, LG-24	30500-02
Terminal Strip 6 Pole, LG-36	30500-03
Terminal Strip 8 Pole, LG-48	30500-05
Terminal Block 3 Pole	30500-07
Contactors 2 Pole 24 VAC	30701-04
Power Cord with Molded Plug	31107-02
Transformer 240/24 VAC	31400-10
Transformer 480/24 VAC	31400-15
Pilot Light 208/240V 6" Lead Black Body	31601-01
Pilot Light 480V 6" Lead Black Body	31601-02
Circuit Board Temperature Control	40101-19
Probe Temperature Sensor	41100-17
Grooved Griddle Cleaning Tool	50100-05
Grooved Griddle Cleaning Tool – Replacement Fingers	50100-051
Grooved Griddle Cleaning Tool – Replacement Blades	50100-052
Element Pan Assembly	50302-05
Panel Label	60301-29
Knob Temperature Control	70701-28
Spacer Support 1/2" Nylon	70801-07
Legs 4" Stainless Steel	72500-02
Element Harness LGS-24	XL-575
24 Volt Harness LGS-24	XL-576
Element Harness LGS-36	XL-577
24 Volt Harness LGS-36	XL-578
Element Harness LGS-48	XL-579
24 Volt Harness LGS-48	XL-580
Selectronic Harness (1 ea. Per section)	XL-587

PB-24**ELECTRIC PANE BELLA GRIDDLE**

DESCRIPTION	PART NO.
Element Lower 208/240 Volt 900 Watts	11030-40
Element Upper 208/240 Volt 720 Watts	11030-41
Stud Grill Plate 10-24 x 1"	20101-13
Stud Grill Plate 10-24 x 1 1/4"	20101-14
Screw, Crumb Tray Knob	20101-24
Thermostat 500°F Griddle (Before A-86009)	60101-92
Thermostat 567°F Griddle (Before B-87780)	60101-92
Thermostat 550°F Griddle (W/ Serial Prefix B After B-87780)	30402-35
Thermostat 650°F Griddle (Serial Prefix C, D & E)	30402-36
Terminal Strip 6 Pole (After B-87780)	30500-03
Terminal Block 2 Pole (Before A-86009)	30500-08
Timer Mechanical 15 Min.	30801-02
Terminal Wire Ring	31001-03
Terminal Power Cord	31001-04
Wire, 18 Gage, Black	31001-04
Wire, 18 Gage, Red	31001-06
Terminal Wire 1/4" Flag	31005-01
Wire, 16 Gage, High Temp.	31103-01
Power Cord (Not on Serial Prefix D & E)	31107-05
Pilot Light 208/240V 6" Lead Black Body	31601-01
Cleaning Tool	50100-10
Cleaning Tool (Serial Prefix E)	50100-10-1
Crumb Tray, Standard	50302-27
Crumb Tray, Large (Serial Prefix D Only)	50302-28
Griddle Plate Lower	50800-78-1
Griddle Plate Upper Left	50800-79
Griddle Plate Upper Right	50800-80
Griddle Plate Upper Left (Serial Prefix E)	50800-92
Griddle Plate Lower (Serial Prefix E)	50800-93
Griddle Plate Upper Right (Serial Prefix E)	50800-94
Spring Upper Griddle Assist	51001-31
Hood Stop (Serial Prefix D & E)	60102-168
Power Cord (Serial Prefix D & E)	60102-161
Handle – Tube	60102-891
Panel Label	60301-99
Panel Label (Serial Prefix E)	60301-130
Complete Left Hand Handle Assembly	72603-22
Complete Right Hand Handle Assembly	72603-22-1
Knob Crumb Tray	70701-49
Knob Upper Grill Adjustment	70701-52
Knob Thermostat	70701-53
Knob Timer	70701-54
Bushing, Strain Relief Power Cord	70801-20
Bushing, Strain Relief Power Cord (Serial Prefix D & E)	70801-21
Leg, 3" Black Plastic	72500-11
Wire Tube Left Hand	PB-838
Wire Tube Right Hand	PB-839
Wire Tube Retaining Clip	20601-02

PB-12**ELECTRIC PANE BELLA GRIDDLE**

DESCRIPTION	PART NO.
Element Lower 115 Volt 900 Watts	11030-51
Element Upper 115 Volt 720 Watts	11030-52
Stud Grill Plate 10-24 x 1"	20101-13
Stud Grill Plate 10-24 x 1 1/4"	20101-14
Screw, Crumb Tray Knob	20101-24
Thermostat 650°F Griddle	30402-36
Terminal Strip	30500-03
Timer Mechanical 15 Min.	30801-02
Terminal Wire Ring	31001-03
Terminal Power Cord	31001-04
Terminal Wire 1/4" Flag	31005-01
Wire, 18 Gage, Black	31001-04
Wire, 18 Gage, Red	31001-06
Wire, 16 Gage, High Temp.	31103-01
Pilot Light 208/240V 6" Lead Black Body	31601-01
Crumb Tray, Standard	50302-29
Grill Plate Lower	50800-93
Grill Plate Upper	50800-92
Spring Upper Griddle Assist	51001-31
Power Cord with Molded Plug	31107-02
Panel Label	60301-129
Knob Crumb Tray	70701-52
Knob Thermostat	70701-53
Knob Timer	70701-54
Bushing, Strain Relief Power Cord	70801-21
Leg, 3" Black Plastic	72500-11
Cleaning Tool	50100-10-1
Hood Stop	60102-168

XL-24, XL-36, XL-48, XL-60, XL-72**ELECTRIC QUARTZ COMBO GRIDDLE**

DESCRIPTION	PART NO.
Element Griddle 208/240 Volt I/S 4500/5991 Watts	11030-29
Element Griddle 208 Volt O/S 1491 Watts	11030-30
Element Griddle 480 Volt 5991 Watts	11030-31
Quartz Lamp 208V 1200 Watts 2ft Socket Type (Serial Prefix A Only)	11160-03
Quartz Lamp 240V 1200 Watts 2ft Socket Type (Serial Prefix A Only)	Obsolete
Steel Heater 104V 1000 Watts 208V (After Serial Prefix A)	11160-26-1
Steel Heater 104V 1000 Watts 240V (After Serial Prefix A)	11160-27-1
Switch Toggle On-Off (After Serial Prefix A)	30303-06
Switch Rocker On-Off-On (Serial Prefix A Only)	30306-02
Switch Mercury Tilt	30307-01
Thermostat Safety 465°F Open	30401-05
Thermostat 450°F Griddle	30402-08
Terminal Strip 4 Pole, XL-24	30500-02
Terminal Strip 6 Pole, XL-36	30500-03
Terminal Strip 8 Pole, XL-48	30500-05
Terminal Block 3 Pole	30500-07
Terminal Block 2 Pole	30500-08
Contactor 2 Pole 208/240 VAC	30701-02
Pilot Light 208/240V 6" Lead Black Body	31601-01
Pilot Light 480V 6" Lead Black Body	31601-02
Lamp Socket (Serial Prefix A Only)	31602-01
Grooved Griddle Cleaning Tool	50100-05
Grooved Griddle Cleaning Tool – Replacement Fingers	50100-051
Grooved Griddle Cleaning Tool – Replacement Blades	50100-052
Tube Guard Quartz Heaters (Serial Prefix A Only)	50201-01
Lamp Shield Can Lock Disc (Serial Prefix A Only)	50302-01
Drip Shield Broiler	50302-04
Element Pan Assembly	50302-05
Lamp Shield Can Assembly (Serial Prefix A Only)	50302-06
Spring Pin 9 1/16" Diameter – Broiler	50800-01
Retaining Clip for Spring Pin	20601-02
Spring Compression Outer – Broiler	51002-01
Spring Rod Assembly Broiler	51100-15
Rulon Sleeve Bearing – Broiler	70200-03
Bronze Bushing 7/16 ID x 9/16 OD x 1 1/4 Long	70201-02
Handle Assembly Broiler	70603-03
Knob Thermostat 450°F Griddle	70701-19

Free Manuals Download Website

<http://myh66.com>

<http://usermanuals.us>

<http://www.somanuals.com>

<http://www.4manuals.cc>

<http://www.manual-lib.com>

<http://www.404manual.com>

<http://www.luxmanual.com>

<http://aubethermostatmanual.com>

Golf course search by state

<http://golfingnear.com>

Email search by domain

<http://emailbydomain.com>

Auto manuals search

<http://auto.somanuals.com>

TV manuals search

<http://tv.somanuals.com>