

WD My Cloud™

Personal Cloud Storage
User Manual



WD® Service and Support

Should you encounter any problem, please give us an opportunity to address it before returning this product. Most technical support questions can be answered through our knowledge base or e-mail support service at <http://support.wd.com>. If the answer is not available or if you prefer, please contact WD at the best telephone number shown below.

Your product includes 30 days of free telephone support during the warranty period. This 30-day period starts on the date of your first telephone contact with WD Technical Support. E-mail support is free for the entire warranty period and our extensive knowledge base is available 24/7. To help us keep you informed of new features and services, remember to register your product online at <http://register.wd.com>.

Accessing Online Support

Visit our product support website at <http://support.wd.com> and choose from these topics:

- **Downloads**—Download drivers, software, and updates for your WD product.
- **Registration**—Register your WD product to get the latest updates and special offers.
- **Warranty & RMA Services**—Get warranty, product replacement (RMA), RMA status, and data recovery information.
- **Knowledge Base**—Search by keyword, phrase, or answer ID.
- **Installation**—Get online installation help for your WD product or software.
- **WD Community**—Share your thoughts and connect with other WD users.
- **Learning Center** — Start here to get the most out of your personal cloud storage device (<http://www.wd.com/setup>).

Contacting WD Technical Support

When contacting WD for support have your WD product serial number, system hardware, and system software versions available.

North America		Asia Pacific	
English	800.ASK.4wd (800.275.4932)	Australia	1 800 42 9861
Spanish	800.832.4778	China	800 820 6682 / +65 62430496
		Hong Kong	+800 6008 6008
		India	1 800 11 9393 (MNTL) / 1 800 200 5789 (Reliance) 011 26384700 (Pilot Line)
		Indonesia	+803 852 9439
Europe (toll free)*	00800 ASK4 WDEU (00800 27549338)	Japan	0120-994-120 / 00531-65-0442
		Korea	02 703 6550
Europe	+31 880062100	Malaysia	+800 6008 6008 / 1 800 88 1908/+65 62430496
Middle East	+31 880062100	Philippines	1 800 1441 0159
Africa	+31 880062100	Singapore	+800 6008 6008 / +800 608 6008/+65 62430496
		Taiwan	+800 6008 6008/+65 62430496

* Toll free number is available in the following countries: Austria, Belgium, Denmark, France, Germany, Ireland, Italy, Netherlands, Norway, Spain, Sweden, Switzerland, United Kingdom.

Registering Your WD Product

Register your WD product to get the latest updates and special offers. You can easily register your device online at <http://register.wd.com> or by using the WD My Cloud Personal Cloud Storage installer, available on the online Learning Center.

Table of Contents

WD® Service and Support	iii
Registering Your WD Product	iii
1 Important User Information	1
Important Safety Instructions	1
Recording Your WD Product Information	2
2 Product Overview	3
About the System	3
About the Learning Center	4
Package Contents	5
System Requirements	6
Pre-installation Instructions	7
Handling Precautions	7
Product Views	7
3 Getting Started	9
Physically Connecting the Device	9
LEDs	10
Getting Started Using the Online Setup Installer	11
Getting Started Without the Online Setup Installer	21
Getting to the Public Share	21
4 Backing Up and Retrieving Files	24
Using WD SmartWare™ Pro (Windows Only)	24
Using Windows 7 Backup and Restore	26
Using Windows 8 File History	27
Using Apple Time Machine	27
5 Managing Your Device With WD Quick View	32
Installing WD Quick View (Mac)	32
Accessing WD Quick View Shortcut Options	34
Checking Device Status	34
Launching WD SmartWare (Windows)	35
Exiting WD SmartWare Safely (Windows)	35
Accessing Shares	35
Launching the WD My Cloud Dashboard	36
Mapping the Drive (Windows)	36
Creating a Shortcut to the Public Share (Windows)	37
Viewing Device Properties	37
Monitoring Storage	37

Shutting Down Safely	38
..... Monitoring Alerts	38
Ejecting a USB Storage Device (Windows)	39
Uninstalling WD Quick View	40
6 At a Glance: The Dashboard	41
Launching the Dashboard	41
The Dashboard Home Page	42
Obtaining Customer Support	48
Basic Administrative Tasks	50
7 Managing Users	51
About Users	51
Viewing Users	51
Creating a User	53
Changing a User's Password	53
Editing User Settings	54
Removing a User	54
8 Managing Shares	55
About Shares	55
Viewing a List of Shares	55
Creating a New Share	56
Making a Share Private	57
Deleting a Share	58
Accessing the Contents of a Share Locally	58
9 Accessing Your Cloud Remotely	60
Enabling Cloud Access for the WD My Cloud Device	60
Enabling Cloud Access for a User	60
Mobilizing Your Files with WD My Cloud Mobile Apps	62
The Pathway to Your Personal Cloud	70
Accessing Your Personal Cloud on the Web	70
10 Configuring Settings	74
General	74
Network	79
Media	82
Utilities	83
Notifications	87
Firmware	89
11 Managing Safepoints	92
About Safepoints	92

Creating a Safepoint	92
Updating a Safepoint	97
Recovering a Safepoint	97
Deleting a Safepoint	99
12 Playing/Streaming Videos, Photos, & Music	100
Media Servers	100
Media Storage	101
Enabling/Disabling DLNA and iTunes	102
Accessing Your Personal Cloud Using Media Players	104
Accessing Your Personal Cloud Using iTunes	105
13 Connecting a USB Hard Drive	106
Overview	106
Connecting A USB Drive	106
Mapping A USB Drive (Windows Only)	107
Creating a Shortcut to the USB Drive (Windows only)	107
Appendix A: Specifications	108
Appendix B: Troubleshooting	109
First Steps Checklist	109
Resetting the WD My Cloud Device	109
Specific Problems and Corrective Actions	110
Appendix C: Regulatory and Warranty Information	114
Regulatory Compliance	114
Warranty Information (All Regions Except Australia/New Zealand)	115
Warranty Information (Australia/New Zealand only)	116
Index	118

1

Important User Information

[Important Safety Instructions](#)
[Recording Your WD Product Information](#)

Important Safety Instructions

This device is designed and manufactured to assure personal safety. Improper use can result in electric shock or fire hazard. The safeguards incorporated into this unit will protect you if you observe the following procedures for installation, use, and servicing.

- Follow all warnings and instructions marked on the product.
- Unplug this product from the wall outlet before cleaning. Do not use liquid cleaners or aerosol cleaners. Use a damp cloth for cleaning.
- Do not use this product near any liquids.
- Do not place this product on an unstable surface. The product may fall, causing serious damage to the product.
- Do not drop the product.
- Do not block the slots and openings on the top and bottom of the chassis; to ensure proper ventilation and reliable operation of the product and to protect it from overheating, these openings must not be blocked or covered. Making sure the device is standing upright also helps prevent overheating.
- Operate this product only from the type of power indicated on the marking label. If you are not sure of the type of power available, consult your dealer or local power company.
- Do not allow anything to rest on the power cord. Do not locate this product where persons will walk on the cord.
- If an extension cord is used with this product, make sure that the total ampere rating of the equipment plugged into the extension cord does not exceed the extension cord ampere rating. Also, make sure that the total rating of all products plugged into the wall outlet does not exceed the fuse rating.
- Never push objects of any kind into this product through the chassis slots as they may touch dangerous voltage points or short out parts that could result in a fire or electric shock.
- Unplug this product from the wall outlet and refer servicing to qualified service personnel under the following conditions:
 - When the power cord or plug is damaged or frayed.
 - If liquid has been spilled on the product.
 - If the product has been exposed to rain or water.
 - If the product does not operate normally when the operating instructions are followed. Adjust only those controls that are covered by the operating instructions since improper adjustment may result in damage and require extensive work by a qualified technician to the product to normal condition.

- If the product has been dropped or the chassis has been damaged.
- If the product exhibits a distinct change in performance, contact WD Customer Support at <http://support.wd.com>.

Recording Your WD Product Information

Remember to write down the following WD product information, which is used for setup and technical support. Your WD product information is found on the label on the bottom of the device.

- Serial Number
- Model Number
- Purchase Date
- System and Software Notes

2

Product Overview

[About the System](#)
[Features](#)
[About the Learning Center](#)
[Package Contents](#)
[System Requirements](#)
[Pre-installation Instructions](#)
[Handling Precautions](#)
[Product Views](#)

About the System

The WD My Cloud personal cloud storage system is a high-performance system providing secure wireless access to your media and files from any computer, tablet, or smartphone when it is connected to a wireless router.

Connect this powerful system to your wireless router for shared storage on your home network and accessing your files from within and outside the home. Share files with your Mac and PC, stream media to your DLNA-compatible devices, and access your files remotely with the WD My Cloud apps and the WDMycloud.com web site.

This user manual provides step-by-step installation instructions and other important information about your WD product. Translated versions and updates to this user manual can be downloaded from <http://products.wd.com/updates>. For more information and news about this product, visit our website at <http://www.wd.com/>.

Features

Finally, a cloud of your own - Save everything on your WD My Cloud and access it from anywhere with mobile and desktop apps.

Centralized storage for your family's media collection – Store and organize all your family's photos, videos, music, and important documents in one secure place on your home network.

Access from anywhere – Enjoy your personal cloud no matter where you are from any PC, Mac, tablet, or smartphone. With WD's free apps, your personal cloud is always with you.

Automatic file backup for all your computers – Easily back up all the files on your PC and Mac computers to your WD My Cloud. Get peace of mind knowing that all your files are securely and automatically backed up on your network. For PC users, WD SmartWare™ Pro offers options for backing up your files to multiple devices on your network. Mac users, take advantage of all the features of Apple Time Machine backup software to protect your data.

Directly upload from your mobile devices – Are your mobile devices at maximum capacity? Save valuable space on your tablets and smartphones with easy photo, video and file uploads direct to your personal cloud.

Connect to Dropbox™ and more – Easily transfer files between your personal cloud, Dropbox, and other public cloud accounts.

Expandable storage with the USB expansion port – Easily expand your storage capacity with the USB 3.0 expansion port. Simply plug-in your USB 3.0 or USB 2.0 external hard drive to instantly add more storage for all your photos, videos, music, and documents.

Fast file transfers for high-performance streaming – Gigabit Ethernet and dual-core processor deliver high-performance media streaming and blazing-fast file transfers. Seamlessly stream your videos, photos and music to your connected DLNA-compatible TV's, media players, and gaming consoles without skipping a beat.

Serve up your music with iTunes® – WD My Cloud includes iTunes support so you can centralize your music and video collection and play it on any PC or Mac computer with iTunes.

Password protection for privacy – Your data is always safe and completely under your control. Protect your personal cloud from unauthorized access with password protection available for every user.

Easy to set up, easy to find on your network – Get up and running in minutes with WD's rich web-based user interface for seamless web-guided setup.

Need help setting up? – We're with you every step of the way. Visit <http://wd.com/setup/wdmycloud> or contact the WD customer support team to walk you through the installation of WD My Cloud and WD's free apps for your computers and mobile devices. Contact information is on page ii of this manual and in the Quick Install Guide.

Add an extra layer of protection for your files – You can automatically make a second copy, or safepoint, of your personal cloud on another NAS device or a Windows PC on your LAN, or on a USB device connected to the WD My Cloud device. With extra-safe protection for all your media, you get the ultimate peace of mind.

About the Learning Center

WD's online Learning Center provides the latest information, instructions, and software to help users get the most out of their personal cloud storage. This web-based guide offers step-by-step help with setting up remote access, backing up data, monitoring drive status, and more. It's an interactive resource to walk users through installing and using their WD My Cloud device. The Learning Center allows you to:

- Learn about your new personal cloud storage product.
- Download the latest software for your product.
- Find in-depth, interactive information on how to explore each of your product's features.
- Update your product whenever new features become available.
- Access an always-available resource online, without a manual or CD.

Package Contents

- WD My Cloud Personal Cloud Storage device
- Ethernet cable
- AC power adapter
- Quick Install Guide



WD My Cloud Personal Cloud Storage Device

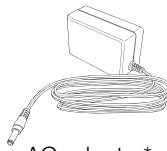

AC adapter*



Ethernet cable



Quick Install Guide

For information on additional accessories for this product, visit:

US	www.shopwd.com or www.wdstore.com
Canada	www.shopwd.ca or www.wdstore.ca
Europe	www.shopwd.eu or www.wdstore.eu
All others	Contact WD Technical Support in your region. For a list of Technical Support contacts, visit http://support.wd.com and see Knowledge Base Answer ID 1048.

System Requirements

Operating System

Windows®

- Windows 8.1 and earlier
- Windows 7
- Windows Vista®
- Windows XP (32 bit) SP3 or later

For Windows OS, you will need to install a Java runtime client

Mac OS X

- Mavericks (Mac OS 10.8)
- Mountain Lion* (Mac OS 10.8)
- Lion* (Mac OS 10.7)
- Snow Leopard (Mac OS 10.6)

* For Lion and Mountain Lion, you will need to install a Java runtime client. For additional information, visit

<http://support.apple.com/kb/dl1421>

Note: Compatibility may vary depending on your computer's hardware configuration and operating system.

For highest performance and reliability, install the latest updates and service pack (SP):

- For Windows, click **Start** or  > **(All) Programs and select Windows Update.**
- For a Mac, go to the **Apple** menu and select **Software Update.**

Web Browsers

- Internet Explorer 8.0 and later on supported Windows computers
- Safari 5.0 and later on supported Mac computers
- Firefox 12 and later on supported Windows and Mac computers
- Google Chrome 14 and later on supported Windows and Mac computers

Local Network

Router/switch – Gigabit Ethernet recommended to maximize performance of wired connection; 802.11n or 802.11ac to maximize Wi-Fi performance, especially when streaming videos.

Internet

Broadband Internet connection is required for initial setup and software downloads, as well as for remote access and mobile apps.

Pre-installation Instructions

Before installing the device, select a suitable place for it for maximum efficiency. Place it in a place that is:

- Near a grounded power outlet
- Clean and dust free
- On a stable surface free from vibration
- Well ventilated, with nothing blocking or covering the slots and openings on the top and bottom of the device, and away from sources of heat
- Secluded from electromagnetic fields from electrical devices such as air conditioners, radio and television receivers.

Handling Precautions

WD products are precision instruments and must be handled with care during unpacking and installation. Rough handling, shock, or vibration can damage the device. Observe the following precautions when unpacking and installing your external storage product:

- Do not drop or jolt the device.
- Do not move the device while it is powered on.
- Do not use this product as a portable drive.



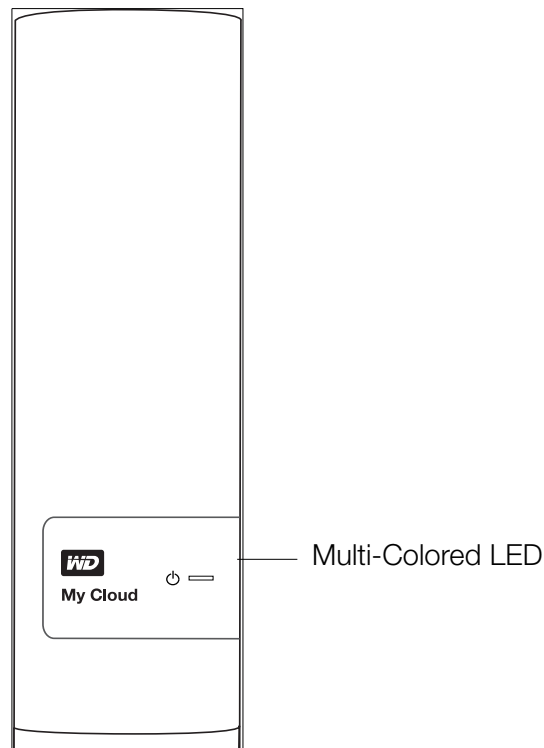

Product Views

Front

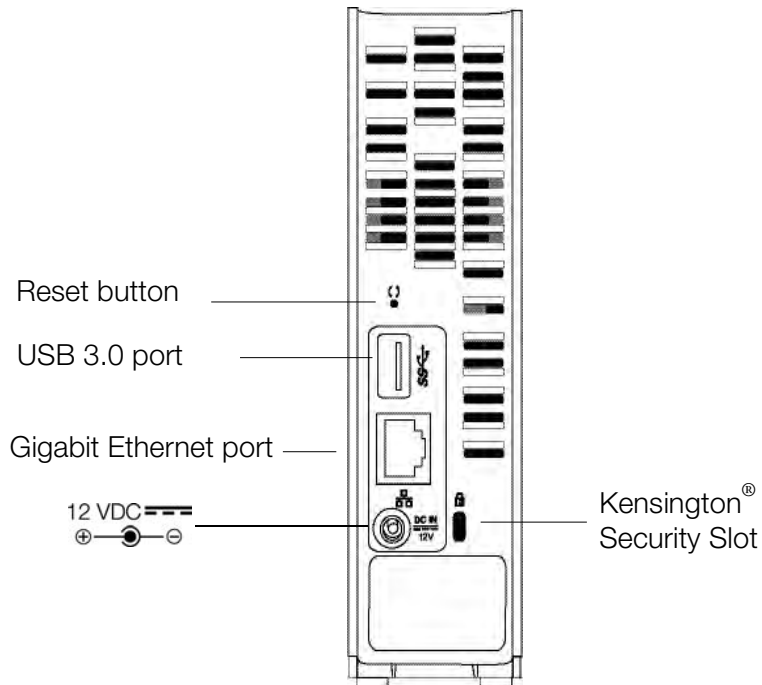

Back



Component	Icon	Description
Gigabit Ethernet port		Connects the device to a local network.
USB 3.0 port		Connects to a USB hard drive for additional storage.
Reset button		Restores settings such as the admin user name and password for the device.
Power port		Connects the device to an AC adapter and the power outlet.
Kensington security slot		For device security, the device is equipped with a security slot that supports a standard Kensington security cable. Visit http://www.kensington.com/ for more information.

3

Getting Started

- [Physically Connecting the Device](#)
- [Getting Started Using the Online Setup Installer](#)
- [Getting Started Without the Online Setup Installer](#)
- [Getting to the Public Share](#)

It is easy to set up the WD My Cloud Personal Cloud Storage device—all you have to do is unpack your device, connect it, and check the LEDs on the front and back of the device to make sure the connections are working properly. Then, download and run the quick setup installer, available at <http://www.wd.com/setup/wdmycloud>.

Note: For information about safely shutting down and disconnecting the device, see “Utilities” on page 83.

Physically Connecting the Device

Note: Remove the sticker from the back of the unit prior to connecting your device.

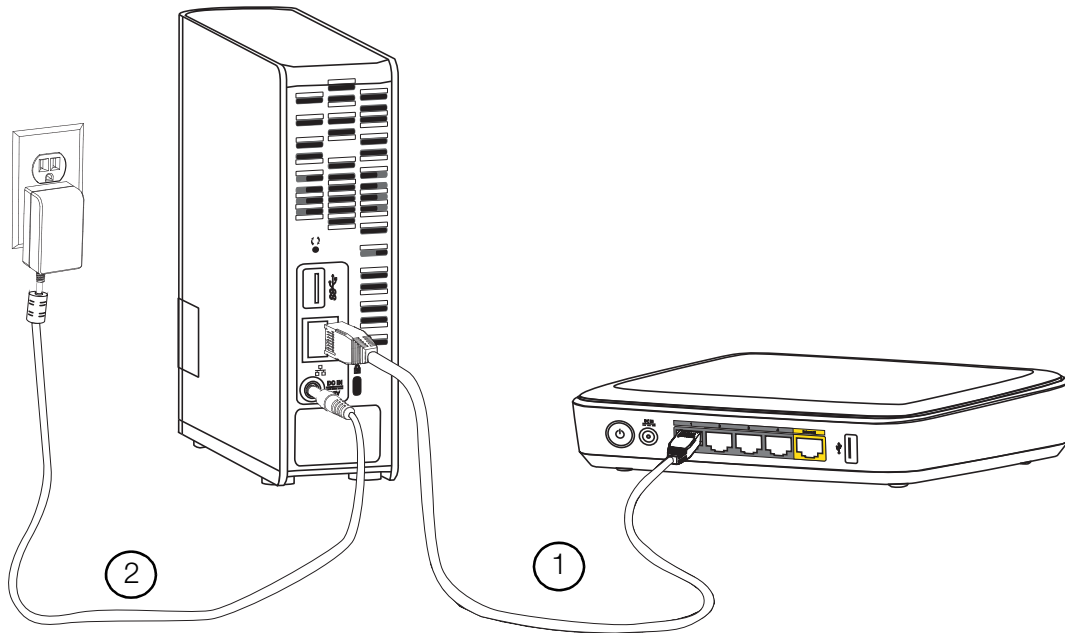

Follow the steps below to connect the WD My Cloud Personal Cloud Storage device to a home or small office network.

Important: To avoid overheating, make sure the device is upright as shown in the illustration above and nothing is blocking or covering the slots and openings on the top and bottom of the device. In the event of overheating, the device will perform a safe shutdown, interrupting all processes currently being performed. If this occurs, data may be lost.

1. Connect one end of the Ethernet cable to the Ethernet port located on the back of the device. Connect the other end of the Ethernet cable directly into an available router or network switch port.

Important: We recommend that you use the enclosed Ethernet cable for best performance.

2. Connect one end of the adapter into the power supply socket on the back of the device. Plug the power adapter into a power outlet. The unit powers up automatically.

Important: Wait for the WD My Cloud device to finish powering up (approximately three minutes) before configuring the device. You will know it is ready when the LED stops flashing and turns solid blue.

3. When the LED on the front of your device turns a solid blue, continue with “Getting Started Using the Online Setup Installer” on page 11 or “Getting Started Without the Online Setup Installer” on page 21.

LEDs

Checking the Front Panel LED

The following table describes the front panel (red/white/yellow/blue) LED behavior.

State	Color	Appearance	State Description
Power Off	None		Displays if the device is unplugged.
Power On	White	Flashing	Displays when you first apply power to the unit.
Initializing	White	Solid	device has begun loading the Operating System (OS).
Ready	Blue	Solid	The OS is now ready.
Standby	Blue	Pulsing	Unit is in HDD standby mode.
Attention	Yellow	Blink	The following circumstances trigger this state: <ul style="list-style-type: none"> • Disk thermal warning threshold exceeded (under or over temp) • Network cable not inserted
Fault/action required	Red	Solid	The following faults trigger this state: <ul style="list-style-type: none"> • Disk SMART failure • Data volume does not exist • System volume does not exist • System thermal shutdown (75° C)

Checking Back Panel (Network) LEDs

The following table describes the network state and activity LEDs.

Note: Looking at the port, with the LEDs on the bottom, the LED on the top is the Activity LED, and the one on the bottom is the Link LED.

State	LED	Appearance	State Description
Link down	Link	Off	Cable or device is not plugged in, or other end of link is not operational.
Link up – 100 Mbps	Link	Yellow	Cable is plugged in, and both ends of the link have successfully established communications. Network negotiated at 100 Mbps.
Link up – 1000 Mbps	Link	Green	Cable is plugged in, and both ends of the link have successfully established communications. Network negotiated at 1000 Mbps.
Link idle	Activity	Off	Active communication is not in progress.
Link busy	Activity	Green - Blinking	Active communication is in progress.

Getting Started Using the Online Setup Installer

The online setup installer walks you through the steps necessary to easily connect your WD My Cloud device to your home or small office network. Use the following steps to download and run the installer, discover the device, and get started using it. The online setup installer is available from WD's online Learning Center at <http://www.wd.com/setup/wdmycloud>.

Downloading and Installing the Online Setup Installer

To download the installer necessary for setting up your device:

1. Connect the WD device as described on page 9.
2. Open a web browser. For requirements, see "System Requirements" on page 6.
3. In the address field, type <http://www.wd.com/setup/wdmycloud> to display the online Learning Center Welcome to personal cloud storage page.

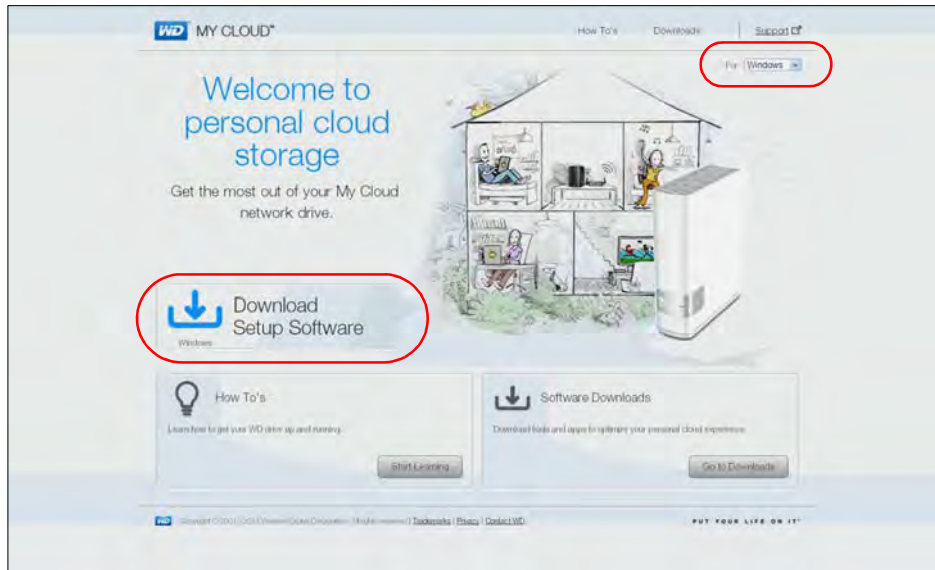

Note: The online Learning Center automatically detects your operating system (OS). If you'd like to download setup installer for a different operating system, select your OS from the pull-down menu at the top right of the page before clicking **Download Setup Software**.

4. Click **Download Setup Software**. The My Cloud Personal Cloud Storage screen displays:



5. Click **Get Started**.



6. Read the Western Digital License Agreement that displays; then select the **"I accept ..."** check box and click **Next**.

The Get Powered Up and Connected screen displays:



7. When the LED on your WD My Cloud device is solid blue, click **Next**. The installer discovers your device:

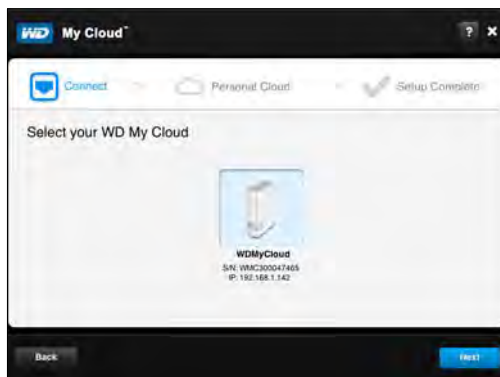

8. Click **Next**. The Checking Your Device progress bar displays.
 9. When the Set up your personal cloud screen displays, continue to “Creating a Personal Cloud” on page 14.

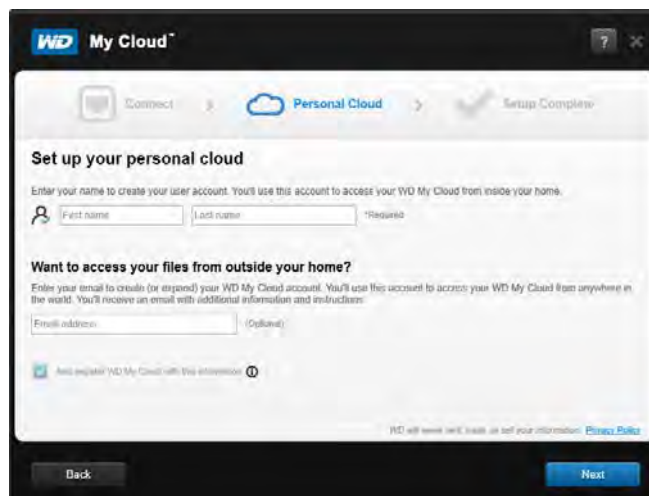

If your device is not detected, continue to “Troubleshooting Connections” on page 14.

Troubleshooting Connections

The Connect - No WD My Cloud personal cloud storage found screen displays when the setup installer cannot find the device on your system. Follow the steps on the page to ensure that your device is:

- Plugged into a working outlet
- Connected to your router
- Displaying a solid blue light on the front

1. Click **Rescan**.
2. If the device is found, continue to “Creating a Personal Cloud,” below.
If the device still cannot be found, get support at <http://support.wd.com>.

Creating a Personal Cloud

WD My Cloud web access provides free remote access to your WD My Cloud personal cloud device. Once you log in, your WD My Cloud device is mounted to your computer like a local drive, and your remote folders are available on any Mac or PC.

The administrator first sets up an admin personal cloud, and then creates user accounts with their own personal clouds for remote access.

On the Set up your personal cloud screen:

1. Enter your **First Name, Last Name** and your **Email address**.
Note: Email address is optional, but it is necessary for remotely accessing your files.

You may see a message saying that it may take a few minutes for your email inbox to receive instructions on accessing the WD My Cloud device remotely.
2. On the Set up your personal cloud screen, select the **Also register WD My Cloud with this information** check box, if not already selected.
Note: If you didn't enter your email address in step 1, this option is disabled.

The Your Account screen displays, listing your name as the administrator.

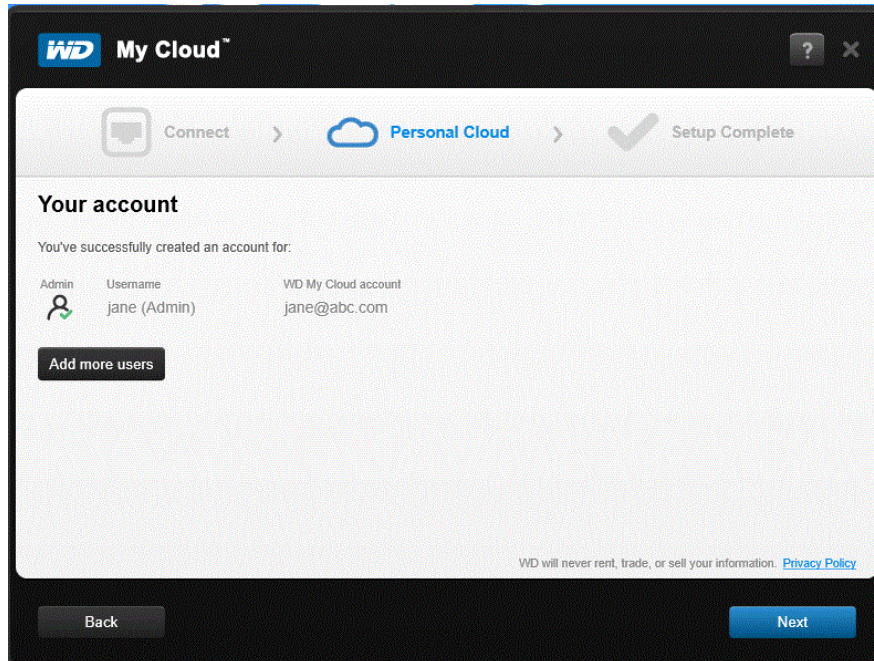

3. To add more accounts, click **Add more users** to add them here, or use the Add a User screen. (See “Creating a User” on page 53.)
4. Click **Next** to display the Setup Complete screen:



All options are enabled by default. The table below explains what happens when the options are enabled and disabled.

5. Select your desired options, clearing the check box for any option you want to disable, and click **Finish**.

Option	Result
<p>Install the WD My Cloud application</p>	<p>If option is enabled:</p> <ul style="list-style-type: none"> • An installation wizard launches automatically. • See “Installing and Accessing the WD My Cloud™ for Desktop App” on page 17 for instructions. <hr/> <p>If option is disabled:</p> <ul style="list-style-type: none"> • The online Learning Center Welcome page displays • The Public share displays in Explorer (Windows) or Finder (Mac).
<p>Place helpful shortcuts on my Desktop</p>	<div data-bbox="956 821 1330 972" data-label="Image"> </div> <ul style="list-style-type: none"> • The online Learning Center Welcome page displays • The Public share displays in Explorer (Windows) or Finder (Mac). • Opens the My Cloud dashboard for configuring your WD My Cloud device.
<p>Recommended: Automatically update WD My Cloud whenever new firmware becomes available</p>	<ul style="list-style-type: none"> • The online Learning Center Welcome page displays • The Public share displays in Explorer (Windows) or Finder (Mac). • If option is enabled, the firmware turns on automatic updates; at 3:00 AM daily. To change settings for automatic updates, see “Firmware” on page 90.

- If you set up a personal cloud, check your email to confirm your new WDMyCloud.com account.

Note: You may need to check your email spam folder if your spam filter does not allow email from WD.

- To configure your WD My Cloud device, continue with “At a Glance: The Dashboard” on page 41.

Installing and Accessing the WD My Cloud™ for Desktop App

The WD My Cloud for desktop app is for your PC/Mac laptop or desktop. It lets you access and manage content on your WD My Cloud devices easily. Take your computer to a different location and you stay connected to your personal cloud.

Note: Regular 32 or 64-bit applications, such as the WD My Cloud for desktop app, do not run on tablets with an ARM processor. You have to use a device with a 32 or 64-bit (Windows or Mac) operating system.

You can install the application during setup, as described here, or download it from the online Learning Center.

- Use the installation wizard displayed when you select **Install the WD My Cloud application** in step 5 on page 16 (or enter <http://setup.wd2go.com/?mod=download&device=mc> as the url in a browser).

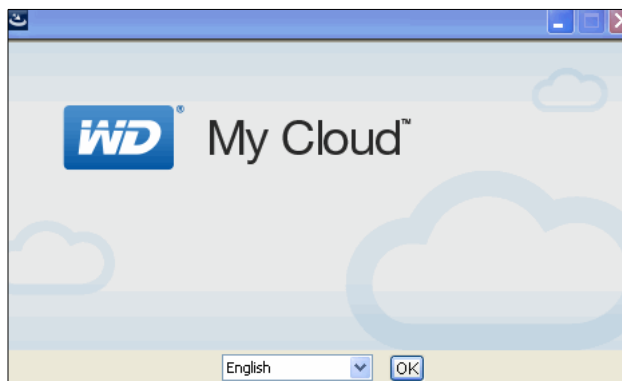

- Click **OK** to display the WD End User License Agreement:

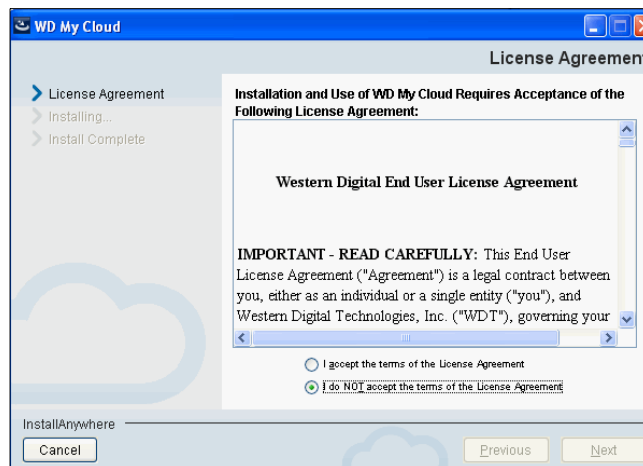

- Read the agreement, select “I accept...,” and click **Next**.

The APPLE, INC. license agreement displays:



4. Select "I accept..." and click **Install**. The Installing WD My Cloud screen displays:

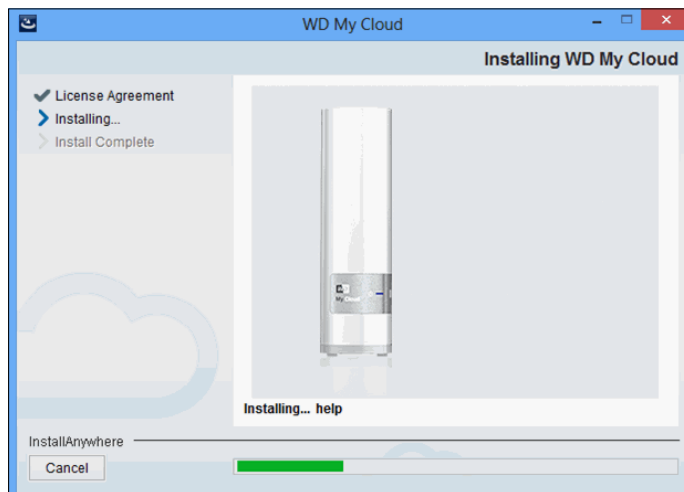

Note: The Installing screens on Windows and Mac differ only slightly. The screen shots included here are from a Windows PC.

5. When the Install Complete screen displays, click **Done**.

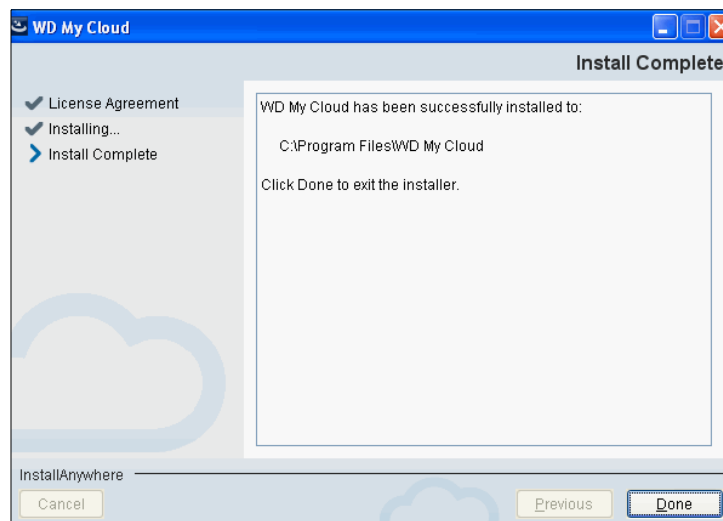

Using the WD My Cloud for Desktop App

1. After you install the WD My Cloud for desktop app, double-click the My Cloud shortcut  that now appears on the desktop to display all of the WD devices on the network.

Note: The system may display information about security alerts:

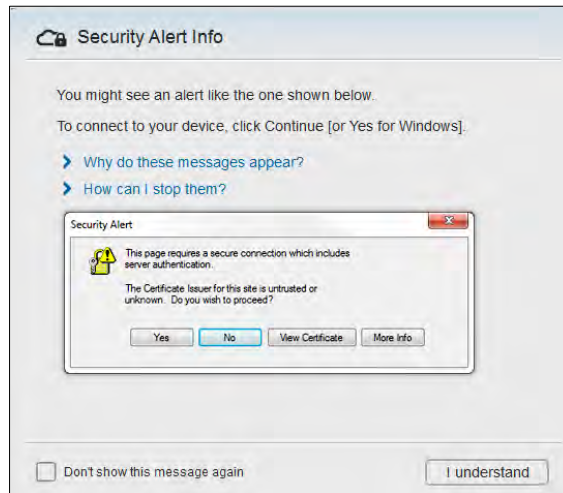

Note: To avoid displaying this screen again, select the Do not show this message again check box. Click **I understand** to display devices on your network.

2. Click the device you want to connect to, in this case the WD My Cloud device:

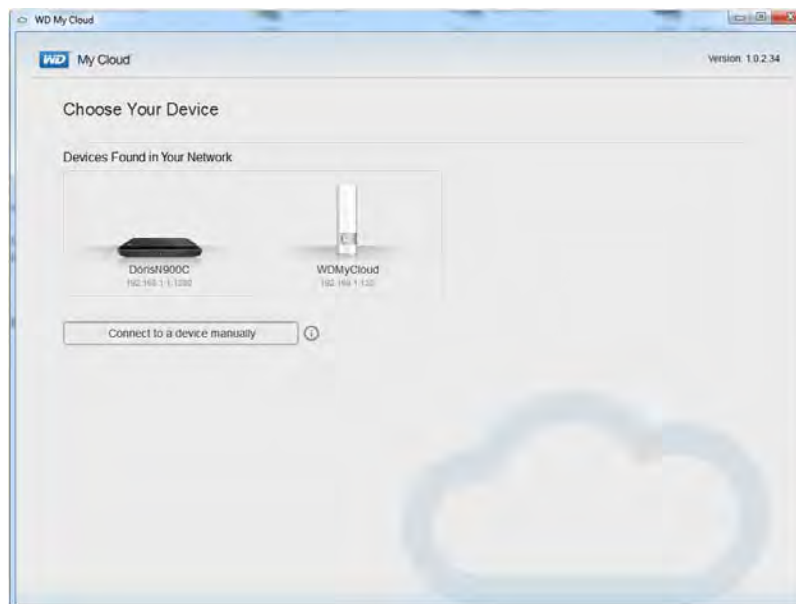

The Getting Started screen displays:

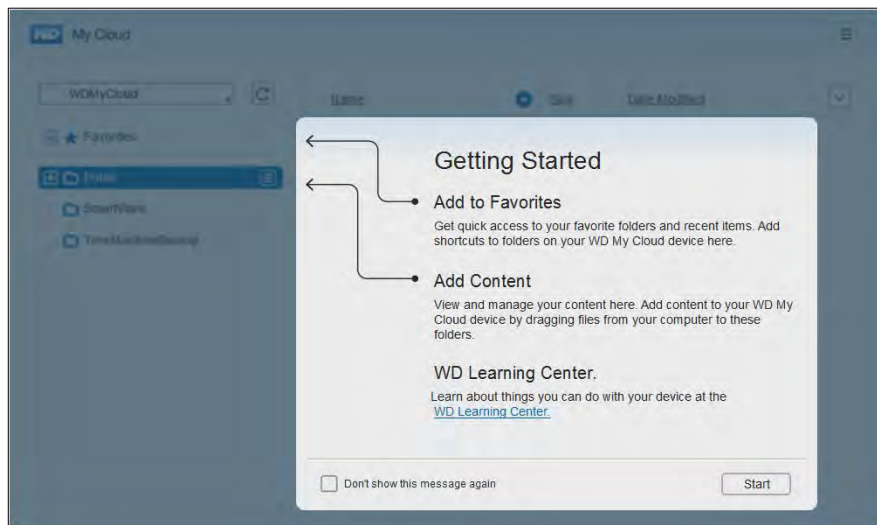

Note: To obtain more information, click the WD Learning Center link on the screen.

3. Click **Start** to display the WD My Cloud device's shares:

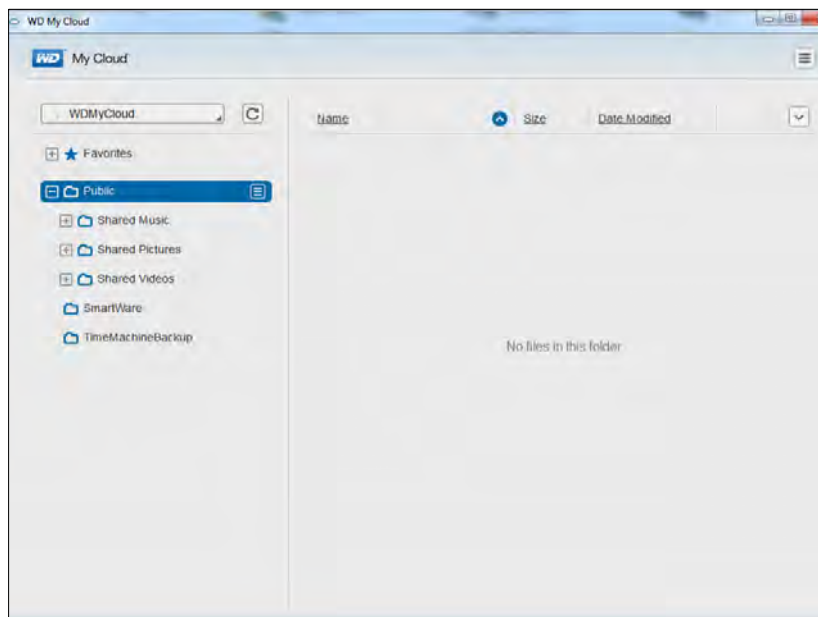

- To learn how to access and manage the content stored on your WD My Cloud device remotely, click the *Access Using Your Computer* link in the online Learning Center's WD My Cloud download panel:



Getting Started Without the Online Setup Installer

If you do not use the online setup installer to get started, you can still:

- Use your WD My Cloud personal cloud storage device as an external hard drive, dragging and dropping files to and from it.
- Configure the device using the WD My Cloud device's dashboard. (See "At a Glance: The Dashboard" on page 41.)
- Back up files using Windows 8 File History, Windows 7 Backup and Restore, or Apple Time Machine. (See "Backing Up and Retrieving Files" on page 24.)

Getting to the Public Share

The WD My Cloud device's Public share (folder) contains Shared Music, Shared Pictures, and Shared Videos subfolders.

Note: In this manual the term shares and folders are used interchangeably.

To get to these folders so you can drag and drop files there or access files that have been backed up from your computer or an attached USB drive, follow one of the procedures described below.

Using Windows 8

- Physically connect the device to your network (see "Physically Connecting the Device" on page 9).
- On the task bar at the bottom of the screen, click the File Explorer icon .
- In the left panel, click **Network**.

4. Double-click **WDMYCloud** under Network, and then locate the device's Public folder.

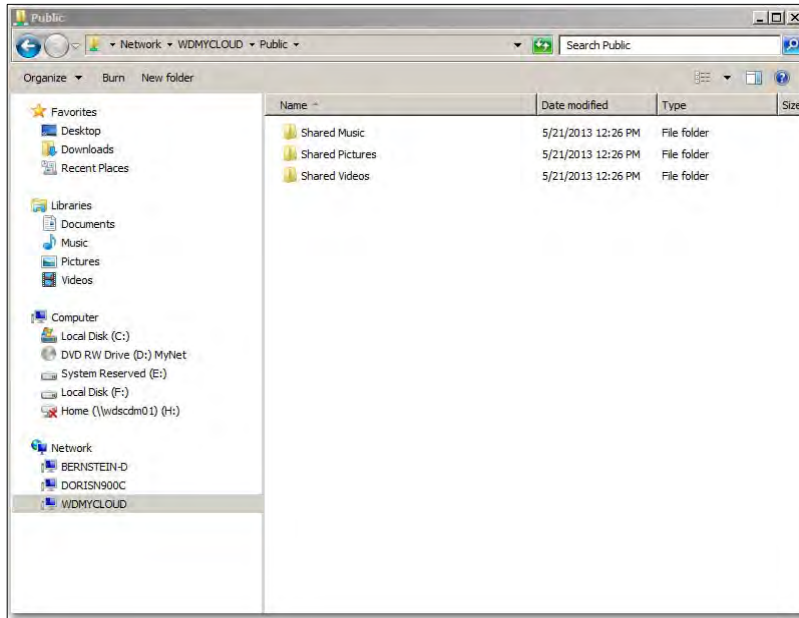

5. Double-click the Public folder to display the Shared Music, Shared Pictures, and Shared Videos subfolders. You can now drag and drop files into and from the shared media folders using Windows Explorer.

Using Windows XP/Vista/Windows 7

1. Physically connect the device to your network.
2. Click  or **Start > Computer > Network > WDMYCloud**, and locate the device's Public folder.
3. Double-click the Public folder to access the Shared Photos, Shared Videos, and Shared Music subfolders.

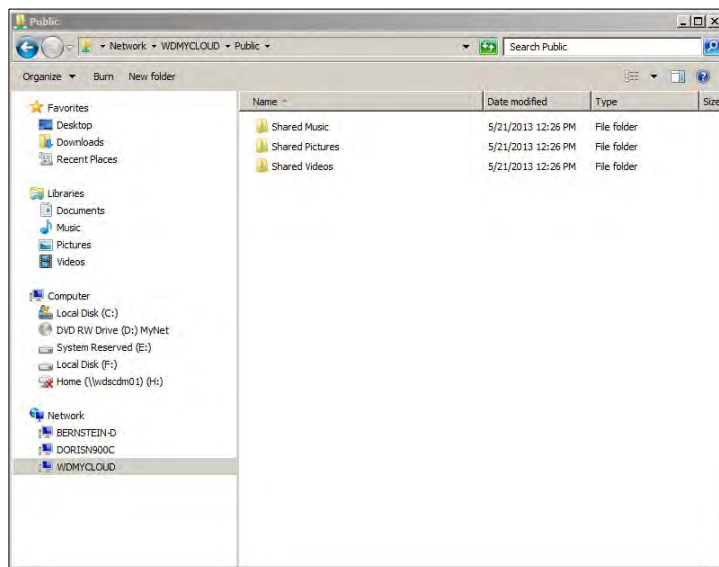

Mapping the Public Folder (Windows)

To map the WD My Cloud public folder for quick access in the future:

1. In Windows Explorer, under Network, click **WDMYCLOUD**.
2. Right-click the Public folder and select **Map Network Drive** from the menu.
3. Select the desired letter from the **Drive** drop-down list.
4. Select the **Reconnect at login** check box.
5. Click **Finish**. Your Public folder is now mapped.

Using Mac OS X Snow Leopard/Lion/Mountain Lion

1. In a Finder window, click **WDMyCloud** under the shared items in the side panel.
2. If presented with an authorization page:



3. Select **Guest** and click **Connect** to display the Public folder:

4

Backing Up and Retrieving Files

[Using WD SmartWare™ Pro \(Windows Only\)](#)

[Using Windows 7 Backup and Restore](#)

[Using Windows 8 File History](#)

[Using Apple Time Machine](#)

Using WD SmartWare™ Pro (Windows Only)

WD SmartWare software is an easy-to-use tool that gives you the power to:

- **Protect your data automatically**—Automatic, continuous backup instantly makes a copy whenever you add or change a file.

Note: Automatic backup protection is continuous as long as both your WD My Cloud device and computer are connected to your network. If you disconnect the device from your network, backup temporarily stops. Once you reconnect, the WD SmartWare software automatically scans your computer for new or changed files and resumes backup protection.
- **See your backup as it happens**—Visual backup organizes your content into categories and shows the progress of your backup.
- **Retrieve lost files effortlessly**—Bring back your valuable data to its original location whether you have lost all your data or just overwritten an important file.
- **Take control**—Customize your backups.

Installing WD SmartWare Software

Note: WD SmartWare Pro software is a free upgrade, providing you with three licenses for your household.

The installation process gives you the choice of installing standard WD SmartWare or WD SmartWare Pro. Pro enables you to back up to non-WD drives, otherwise unsupported WD drives, and the cloud via Dropbox.

1. Access the online Learning Center WD My Cloud Welcome page at <http://www.wd.com/setup/wdmycloud>:



2. Click **Go to Downloads** to display the Downloads page:

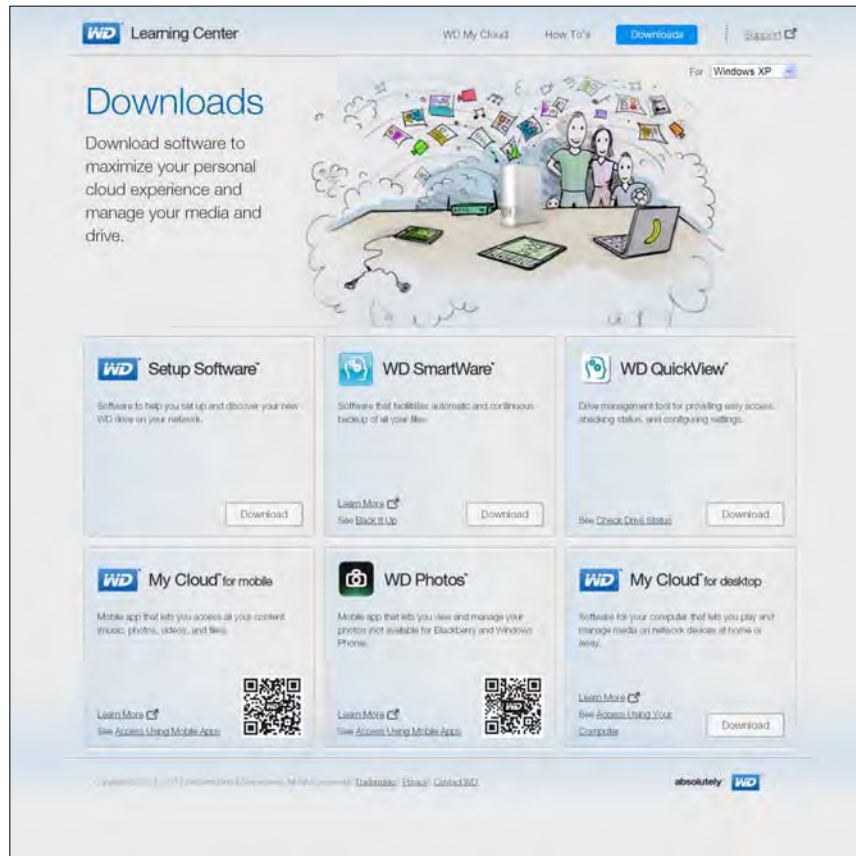

3. In the WD SmartWare box, click **Download**.

Note: WD My Cloud users will initially download the standard version of WD Smartware, which is then automatically upgraded to the WD SmartWare Pro version. You can choose the WD SmartWare standard version if you prefer.

4. Access your downloaded files, and extract the contents of the zip file to your computer.
5. Double-click the **WD SmartWare Setup** file.
6. Follow the online instructions to complete the installation.

Launching the WD SmartWare Software After Installation

Use one of the following options for WD SmartWare Software once you have installed it:

- **Windows XP and Windows 7:** From the Start menu, click **Programs > WD SmartWare > WD SmartWare**.
- **Windows 8:** From the Start menu, click **WD Smartware**.
- **WD QuickView Icon:** Left- or right-click the WD Quick View  icon in the Windows system tray to display the menu, and then select **WD SmartWare**. (The icon is automatically installed when you download WD SmartWare. For more information about WD Quick View, see “Managing Your Device With WD Quick View” on page 32.)

Viewing the Info/Online Help Topics

WD SmartWare software provides two kinds of Help:

- **Help icon** —Each WD SmartWare page provides easy access to online help information to quickly guide you through your backup, retrieve, and settings tasks. Whenever you are uncertain about what to do, just click the info/online Help icon in the upper-right corner of any page.

To close the info/help page after reading the online Help, click the **X** button in the upper-right corner of the page.

- **Help tab**—This tab on the WD SmartWare pages provides more detailed Help. For information on using the Help tab, see *Using Windows 7 Backup and Restore*, below.

Please refer to the WD Smartware online Help for further instructions.

Using Windows 7 Backup and Restore

If you choose not to use WD SmartWare software for backing up files to the WD My Cloud Personal Cloud Storage device, you can use Windows 7 Backup and Restore or Windows 8 File History.

Note: The WD My Cloud device does not support Windows Vista Backup and Restore. Use WD SmartWare software for backing up files to the WD My Cloud device.

The Windows Backup features of Windows 7 (Professional and Ultimate versions) enable you to back up media files, documents, email, and other personal files to your WD My Cloud device. If you lose files or your system crashes, you can easily restore the files to your PC. For more information on Windows Backup, consult Microsoft's documentation.

1. Click  > **Control Panel > System and Security**.
2. Click **Backup and Restore**.
3. Click **Set up Backup** and follow the steps in the wizard.
4. When prompted to select where you want to save your backup, click **Save on a network**.
5. Click the **Browse** button and select the WD My Cloud device as the backup destination.
6. Select a share where you want the backup to be created and click **OK**.
7. Enter the username and password for the WD My Cloud Personal device. (See "Creating a User" on page 53.)
8. Make sure the backup destination is correct and click **Next**.
9. When prompted for the content you want to back up, select **Let Windows choose** or select desired content and then click the **Next** button.
10. On the Review your backup settings page, click **Save settings and run backup**.

Using Windows 8 File History

Windows 8 File History automatically backs up media files, documents, email, and other personal files to your WD My Cloud Personal Cloud Storage device. If you lose files or your system crashes, you can easily restore the files to your Windows computer. For more information on Windows 8 File History, consult Microsoft's documentation.

1. In the task bar, click the File Explorer icon .
2. Click **Computer**.
3. In the Ribbon (top of page) click **Computer > Open Control Panel**.
4. Click **System and Security** and then **File History**.
5. On the File History page, ensure that **File History** is **On**.
6. In the left panel, select **Select Drive**. File History detects your WD My Cloud device and lists it in the **Select a File History drive** list.
7. Click **Add Network Location**. A Select Folder pop-up displays your WD My Cloud's name.
8. Double-click the device name.
9. Select a share.
10. Click **Select Folder** and then **OK**.
11. Click **Turn On**.

Using Apple Time Machine

Backing up

The Apple Time Machine is a built-in feature on Mac OS X Mavericks, Mountain Lion, Lion, and Snow Leopard computers that can back up everything on your computer: music, photos, documents, applications, emails, and system files. The WD My Cloud device can store these backups, so that if your hard drive or operating system should crash, or you lose a file, you can easily restore it to your computer. You can also specify the maximum amount of space you'd like to use on your Time Machine to back up your files.

Setting Time Machine

Important: Before setting up Time Machine, on the WD My Cloud dashboard, click **Settings** to navigate to the Settings General page. Check under Mac Backups to make sure Time Machine is set to **ON** (default).

To set up Time Machine to back up files to your WD My Cloud device:

1. Use one of the following methods to open Time Machine:
 - Click the Time Machine icon in the Dock:



- Click the **Apple menu > System Preferences** and select **Time Machine**.
 - Click **Go > Applications** and select **Time Machine**.
2. If this is your first time creating a backup, the following page displays:



Click **Set Up Time Machine** to display the Time Machine Preferences page:



3. To add a Time Machine drop-down menu icon  to the menu bar at the top of the page, select the **Show Time Machine status in the menu bar** check box. This menu enables you to start a backup, enter Time Machine to restore files, or open the Time Machine Preferences page.

- Slide the **Time Machine** button to **ON** and click **Select Disk**. Select the WD My Cloud device where you want the backups stored:

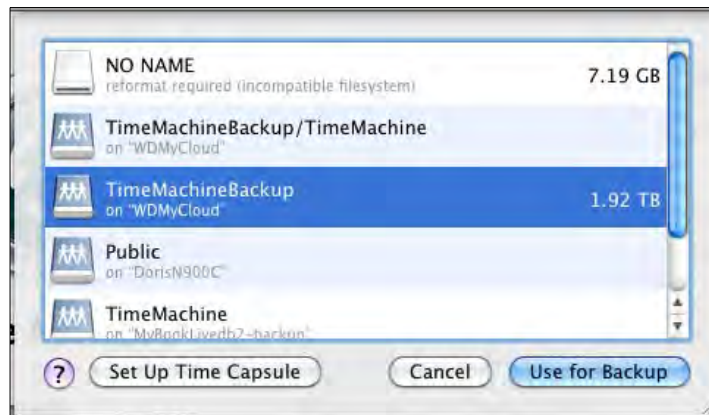

- Click **Use for Backup**. A page prompts for your user name and password.
- Select **Guest** and click **Connect**:



The Preferences page redisplay.

Time Machine begins backing up your files. The first backup may take some time, but subsequent backups are faster because Time Machine only backs up new or changed items. A status bar displays the progress of the backup:

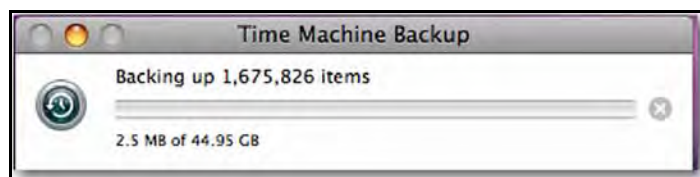

Time Machine backs up your computer every hour and keeps the following backup sets:

- Every hour for 24 hours
- Every day for the past month
- Weekly until the WD My Cloud device is full.

Note: If a backup is interrupted, for example, if the computer goes into sleep mode, or the WD My Cloud is disconnected, the backup will resume automatically once the computer is available.

If you change the name of the WD My Cloud, previously set Time Machine backups delay or fail. To fix the problem, resume backing up by re-selecting the device in the Time Machine Preferences page.

To see information such as available capacity and the date and time of the oldest, latest, and next backup, select **Open Time Machine Preferences** on the Time Machine drop-down menu:

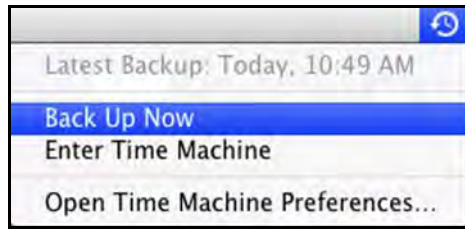

Starting a Backup

To start a backup at any time, select **Back Up Now** on the drop-down menu (above).

Retrieving Backed-Up Items

You might sometimes want to retrieve files and other items backed up on the WD My Cloud device. For example, you might have lost a file, or you want to see files from a week ago. You can retrieve individual items, multiple items, shares, or if your system crashes, your entire hard drive.

To retrieve backed-up items to your hard drive:

1. Open the window on your computer where you want the item restored. For example, if you are retrieving a document, open the Documents folder. (If you are restoring an item on your desktop, you do not need to open a window.)
2. Click the **Time Machine** icon in the Dock, or select **Enter Time Machine** from the drop-down menu:

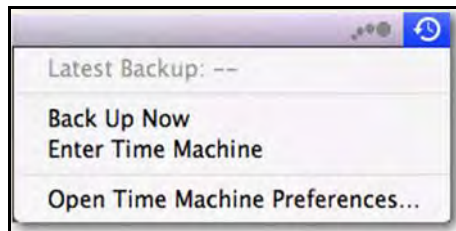

All of your backups display in a cascade, with the most recent in front.

3. Click the arrows or the time line on the bottom right of the page to browse through all the backups Time Machine has created:



4. Select the item you want to restore, and click the **Restore** button at the bottom right to display the Copy message:

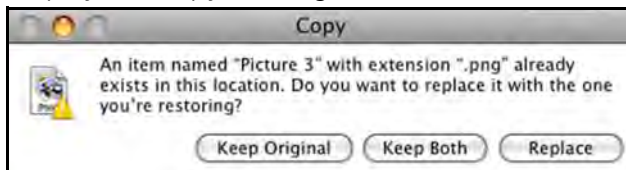

5. Click the button for the desired option:
 - **Keep Original**— Does not restore the item from the backup drive.
 - **Keep Both**— The original item remains and the backed-up item is added to the selected location on your computer.
 - **Replace**— The backed-up item replaces the original item.

5

Managing Your Device With WD Quick View

[Installing WD Quick View \(Mac\)](#)
[Accessing WD Quick View Shortcut Options](#)
[Checking Device Status](#)
[Launching WD SmartWare \(Windows\)](#)
[Exiting WD SmartWare Safely \(Windows\)](#)
[Accessing Shares](#)
[Launching the WD My Cloud Dashboard](#)
[Mapping the Drive \(Windows\)](#)

[Creating a Shortcut to the Public Share \(Windows\)](#)
[Viewing Device Properties](#)
[Monitoring Storage](#)
[Shutting Down Safely](#)
[Monitoring Alerts](#)
[Ejecting a USB Storage Device \(Windows\)](#)
[Uninstalling WD Quick View](#)

Installing WD Quick View (Mac)

WD Quick View software installs the WD Quick View icon in the Mac OS X menu bar so that you can perform important functions such as launching WD SmartWare or checking drive status quickly. Once installed, you can quickly and conveniently perform the tasks described in this chapter.

Note: For Windows OS, WD Quick View installs automatically when you install WD SmartWare. If you don't install WD Smartware Software then, you can download it later from the online Learning Center.

1. Access the online Learning Center at <http://www.wd.com/setup/wdmycloud>.



2. Click the **Software Downloads** button to display the Downloads page:



3. In the WD Quick View box, click **Download**.
4. Access your downloaded file, and extract the contents of the zip file to your Mac.
5. Double-click the **WD Quick View Setup** file.
6. Complete the Quick View installer, following the directions on the page.

Accessing WD Quick View Shortcut Options

Windows

1. Right- or left-click the WD Quick View icon  in the system tray to display a menu.
2. Move the pointer over or click to select your WD My Cloud Personal Cloud Storage device and display a submenu:

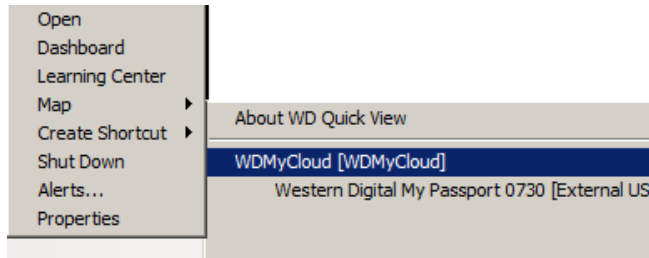

3. Select the desired option.

Mac OS X

1. Click the **WD Quick View** icon  on the menu bar to display a menu.
2. Move the pointer over the name of your WD My Cloud device to display a submenu:

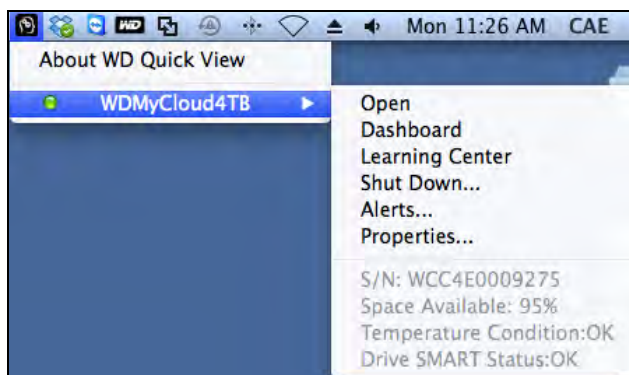

3. Select the desired option.

Checking Device Status

Windows

Move the pointer over the WD Quick View icon  in the system tray to see the drive capacity used and drive temperature:

WD Quick View				
Drive Name [Volumes]	Used	Locked	Temperature	Updates
MyBookLivedb2 [My Book Live]	5%	n/a	OK	Yes
DorisN900C [MyNetN900C]	0%	n/a	OK	No
WDMycloud [WDMycloud]	3%	n/a	OK	No
Western Digital My Passport 0730 [External USB]	4%	No	n/a	n/a

- A green dot beside the drive name means the drive is behaving normally.
- A red dot beside the drive name means the drive is experiencing a problem, such as an abnormally high temperature.

Mac OS X

Click the WD Quick View icon  in the menu bar and move the cursor over the name of your WD My Cloud device to display drive status below the submenu:

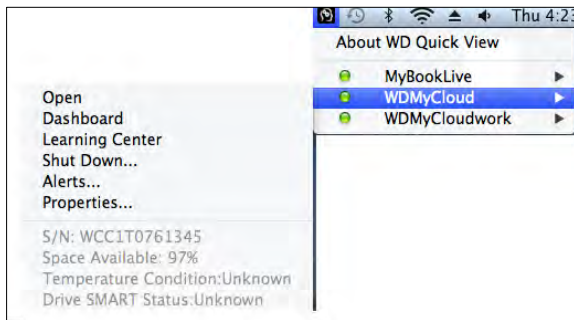

Launching WD SmartWare (Windows)

If WD SmartWare is installed, select the **WD SmartWare** option on the WD Quick View menu to display the WD SmartWare home page.

Exiting WD SmartWare Safely (Windows)

Select **Exit WD SmartWare** on the WD Quick View menu to close the application. (This option only appears if you are running WD SmartWare.)

Accessing Shares

You can use WD Quick View to open the device's Public share and any private shares to which you have access permission.

1. Select **Open** on the WD Quick View submenu.
2. Select **Public**.

Windows: The shares display in Windows Explorer:

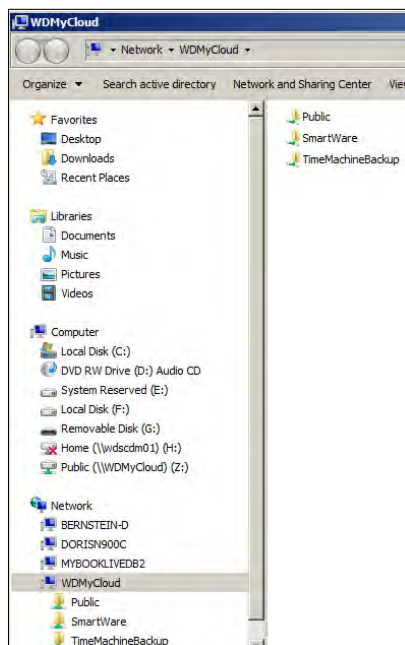

Mac OS X: The contents of the Public share display in Finder:

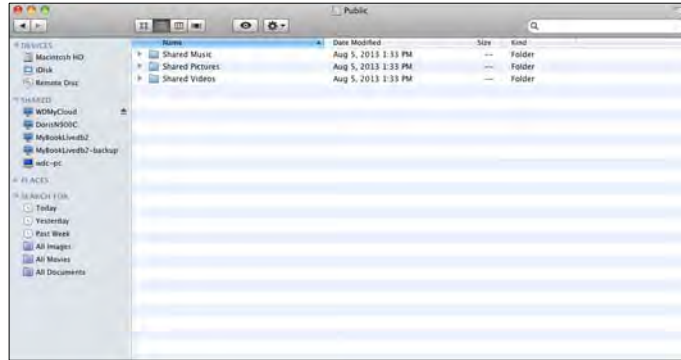

Note: To view all of the shares on the device, click the name of your WD My Cloud device under Shared.

3. Select the share you want to view:

Windows: For a private share, if prompted for a user name and password, enter those associated with your user account on the WD My Cloud dashboard (see “Creating a User” on page 53). If you make the user name and password for the dashboard the same as those for logging into the computer, no user name or password are required here.

Mac OS X: For a private share, if prompted for a user name and password, enter those associated with your user account on the WD My Cloud dashboard (see “Creating a User” on page 53). For a public share, if prompted for a user name and password, select **Guest**.

Launching the WD My Cloud Dashboard

Select **Dashboard** on the WD Quick View submenu to launch the application. The Welcome page displays. (See “At a Glance: The Dashboard” on page 41.)

Mapping the Drive (Windows)

1. Select **Map [WD My Cloud device name]** on the WD Quick View submenu. The Map Network Drive page displays:

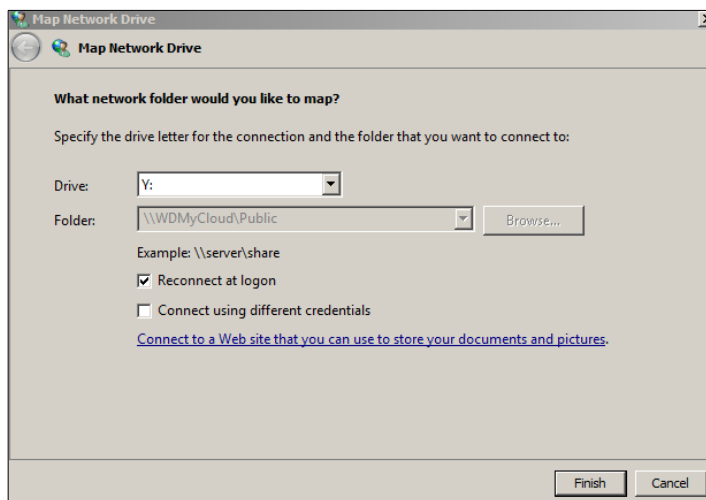

2. Select the desired letter from the **Drive** drop-down list.

3. Click the **Finish** button.

Note: When Windows attempts to reconnect a Mapped Network Drive after a restart, the “Unable to reconnect mapped network drives” error may appear. This can occur if the username and password of the WD My Cloud device do not match the current Window's username and password information.

Creating a Shortcut to the Public Share (Windows)

Note: Mac OS X automatically displays a Public share icon on the desktop, and you can create aliases for any subshares.

Select **Create Shortcut** on the WD Quick View submenu. An icon representing the Public share displays on the desktop.

Viewing Device Properties

Select **Properties** on the WD Quick View submenu to display the Properties page:

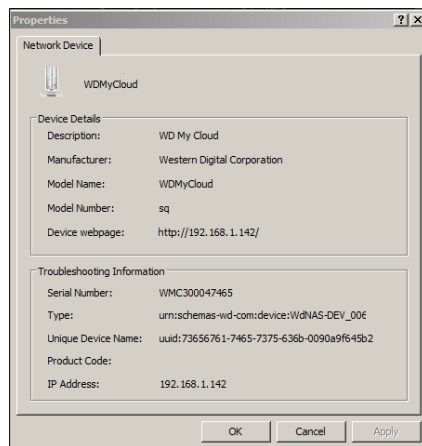

Monitoring Storage

Hover your cursor over the WD Quick View icon to display the drive name, storage capacity used, temperature status within the drive, and WD My Cloud firmware updates.

If you have a USB Drive attached to WD My Cloud device, the drive information also displays in this area:

WD Quick View				
Drive Name [Volumes]	Used	Locked	Temperature	Updates
● MyBookLivedb2 [My Book Live]	5%	n/a	OK	Yes
● DorisN900C [MyNetN900C]	0%	n/a	OK	No
● WDMyCloud [WDMyCloud]	3%	n/a	OK	No
Western Digital My Passport 0730 [External USB]	4%	No	n/a	n/a

Shutting Down Safely

One of the recommended ways to safely shut down your WD My Cloud device is to use the WD Quick View icon.

Note: Another preferred method is to use the dashboard. (See “Utilities” on page 83.) If the unit does not shut down using either recommended method, see “I am having trouble shutting down the WD My Cloud Device.” on page 122.

Important: Before shutting down, ensure that no files are being transferred to or from the device.

4. Select **Shut Down** on the WD Quick View submenu to display the WD SmartWare Shut Down page:



5. Enter the administrator's password or leave blank and then click the **OK** button. The device shuts down.

Monitoring Alerts

Flashing Icon and Balloon Alert

On both Windows and Mac systems, the WD Quick View icon flashes to indicate the device may be overheated or about to fail. In Windows, a balloon alert displays as well.

Note: If the device overheats, power it down and let it cool for 60 minutes. Power it back on, and if the problem persists, contact WD Support.

WD Quick View Alerts Option

An option on the WD Quick View submenu displays alerts such as:

- Drive is reaching maximum capacity.
- Drive is full and subsequent backups cannot take place. Displays every five minutes until space is made available.
- Updates are available.

To view drive alerts:

1. To display one or more alerts, select your drive, then select **Alerts** on the WD Quick View submenu. Multiple alerts are arranged chronologically.

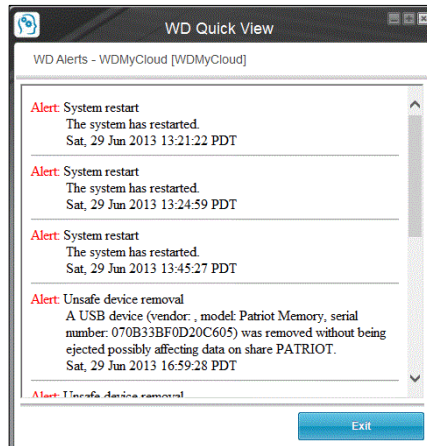

Alerts on Windows

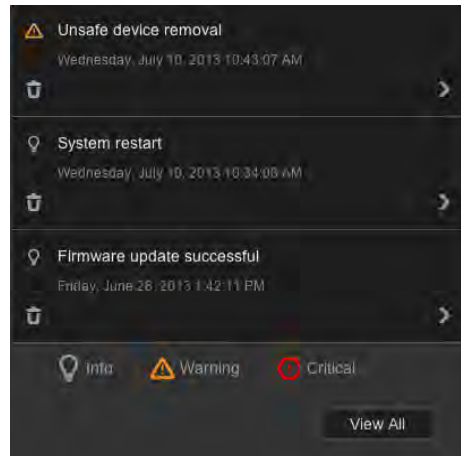

Alerts on Mac OS X

2. To close the alert panel, click **Exit** (Windows) or **OK** (Mac).

Ejecting a USB Storage Device (Windows)

1. Left- or right-click the WD Quick View icon in your system tray.
2. Select your USB Storage Device and then select **Safely remove** from the Quick View menu. Your USB ejects from your system.

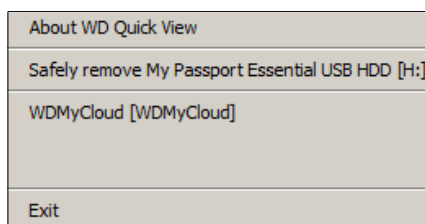

Uninstalling WD Quick View

Windows

Windows XP: Click **Start > Control Panel > Add or Remove Programs**, and then uninstall WD Quick View.

Windows Vista/Windows 7: Click  **> Control Panel > Programs > Programs and Features**. Uninstall WD Quick View.

Windows 8: From the desktop, double-click **Control Panel**, and then click **Programs and Features**. Uninstall WD Quick View.

The System Tray no longer contains the WD Quick View icon. For more information on uninstalling WD Quick View, see Knowledge Base Answer ID 5373.

Mac OS X

1. On the desktop, click **Finder**, and then select **Applications** from the Favorites area.
2. In the Applications list on the right of the page, double-click **WD Quick View Uninstaller**.
3. Click **Continue**. A login window displays your Mac user name.
4. Enter your Mac password and click **OK**.
The menu bar no longer contains the WD Quick View icon.

6



At a Glance: The Dashboard



[Launching the Dashboard](#)
[The Dashboard Home Page](#)
[Obtaining Customer Support](#)
[Basic Administrative Tasks](#)

The WD My Cloud Dashboard Home page provides a snapshot of the WD My Cloud device. You can perform the basic administrative tasks using the Home Page. For example, you can set up user accounts, restrict access to the files on your WD My Cloud device, set up folders for storing files, and customize the device to suit your needs.

Launching the Dashboard

Use one of the following methods to launch the dashboard:

IF you want to launch from . . .	THEN . . .
Dashboard Desktop Icon 	<ol style="list-style-type: none"> 1. Double-click the Dashboard icon on your desktop. Note: The icon only displays on your desktop if you selected Create Shortcut on the final page of the online setup installer.
A browser or Windows Explorer	<ol style="list-style-type: none"> 1. For Windows, enter <code>http://the name of your WD My Cloud device</code> (default name: WDMycloud) or the IP address as the URL. For a Mac, enter <code>http://the device name.local</code> (example: WDMycloud.local) or the IP address as the URL. 2. Press Enter.
WD Quick View icon (See "Managing Your Device With WD Quick View" on page 32.)	<ol style="list-style-type: none"> 1. Left- or right-click the WD Quick View icon. 2. Select your WD My Cloud device and then Dashboard.
WD SmartWare	<ol style="list-style-type: none"> 1. On the WD SmartWare Home page, select your WD My Cloud device. 2. Click the Settings tab to display the Main Settings page. 3. Click Setup Drive.
Windows 8	<ol style="list-style-type: none"> 1. In the task bar, click the File Explorer icon . 2. In the left panel, click Network. 3. In the right panel, locate your WD My Cloud device under Storage. 4. Double-click the device, or right-click and select View device webpage from the resulting menu.
Windows 7/Vista	<ol style="list-style-type: none"> 1. Click  > Computer > Network. 2. In the right panel, locate your WD My Cloud device under Storage. 3. Double-click the device, or right-click and select View device webpage from the resulting menu.

IF you want to launch from ...	THEN ...
Windows XP	<ol style="list-style-type: none"> 1. Click Start > My Network Places. 2. Locate your WD My Cloud device. 3. Double-click the device or right-click and select Invoke.
Mac OS X (shortcut)	<ol style="list-style-type: none"> 1. Click Safari  > Bookmark  > Bonjour. 2. Double-click the WD My Cloud device on the network.
Mobile devices	<ol style="list-style-type: none"> 1. Open a browser. 2. In the Address bar, enter http:// name of your WD My Cloud device (default name: WDMycloud) or http://IP address. Note: If the URL fails to display the dashboard, try typing the following URL: http://WDMycloud.local (for a Mac).



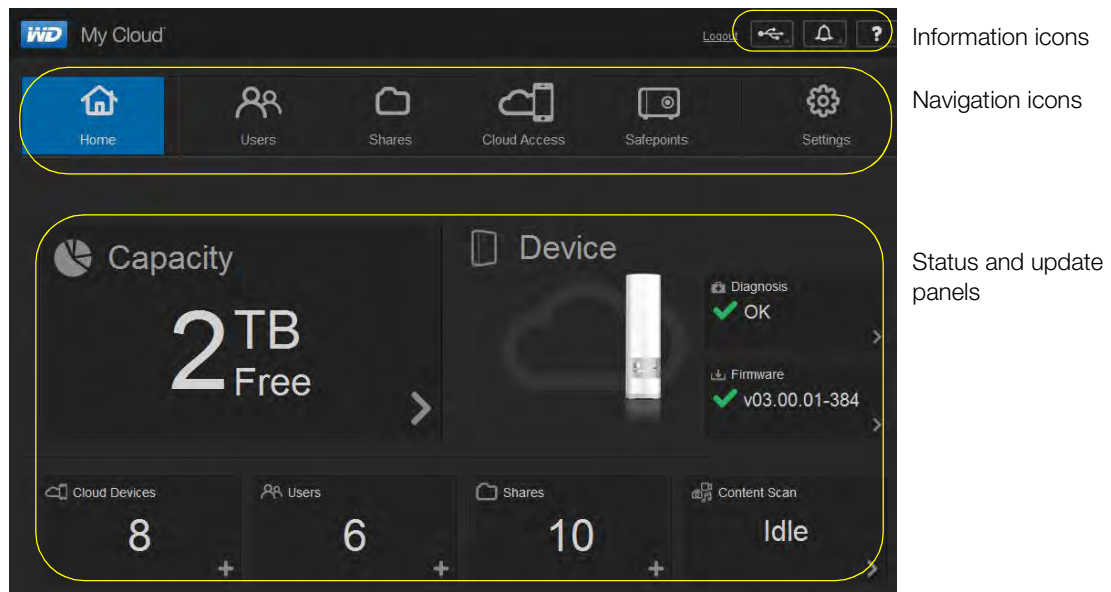

The Dashboard Home Page

The WD My Cloud Home page has an information bar at the top right, a navigation icon bar across the top of the page, an instant overview of the status of the device's main functions, and links for updating settings in the body of the page.



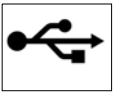





Information Icons

Information icons are at the top right of every page.

Icon	Name	Actions
	USB device on the WD My Cloud	Click to display the number of USB devices connected (a hub with multiple devices can be connected to the USB port). Icon is dim if no USB is attached.
	Alerts	Click to display recent alerts about new firmware and network issues.
	Critical alerts	Click to display a severe warning: over temperature, under temperature, drive SMART failure, failure of the data volume to mount.
	Help	Click to display a menu of ways of obtaining help.

Navigation Icons

Navigation icons display across the top of every page.

Icon	Name	Actions
	Home	Provides a snapshot of the My WD Cloud's status, capacity, current firmware, and the number of user, shares, and connected tablet and mobile devices.
	Users	Create user accounts and grant them full or limited access to particular shares.
	Shares	Create shares and grant specific users full, read only, or no access to particular shares
	Cloud Access	Enable/disable remote cloud access for users, generate device access codes for users to connect remotely to their personal cloud, and monitor remote access status.
	Safepoints	Create safepoints on either a USB drive attached to the WD My Cloud device or on a different storage device within your network.
	Settings	Enable/disable cloud access for the device. Configure advanced settings for Internet connections, wireless connections, storage, drives, system administration, security, the local network (LAN), and firmware updates.

Viewing Drive Status and Making Updates

The body of the Home page shows the status of the drive, its functions and shortcuts to the most necessary tasks.

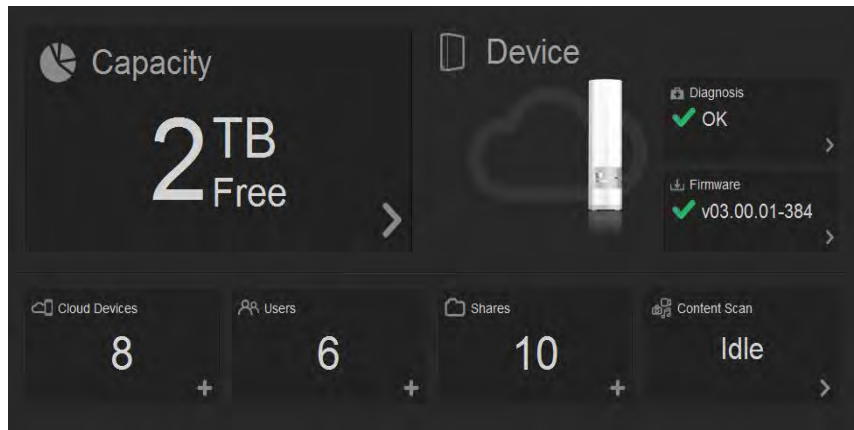

Capacity

The Capacity panel displays the amount of free storage left on your WD My Cloud device.

1. To see more detailed information, click the arrow in the lower right of the Capacity panel to display the current usage of the drive's capacity:

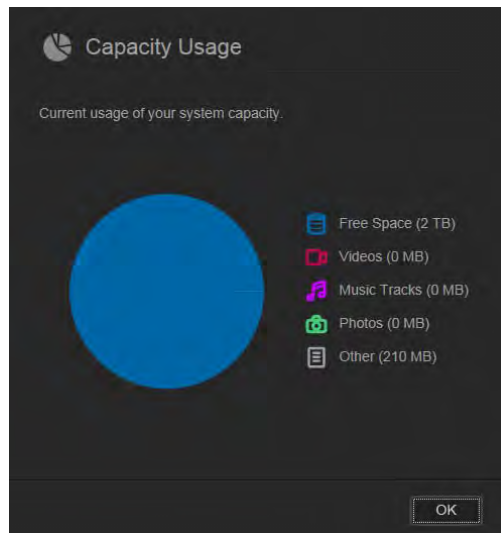

2. To return to the Home page, click **OK**.

Diagnosis

The Diagnosis panel displays the overall health of the system.

1. To see details about the status of system components, click the arrow in the lower right of the Diagnosis panel:

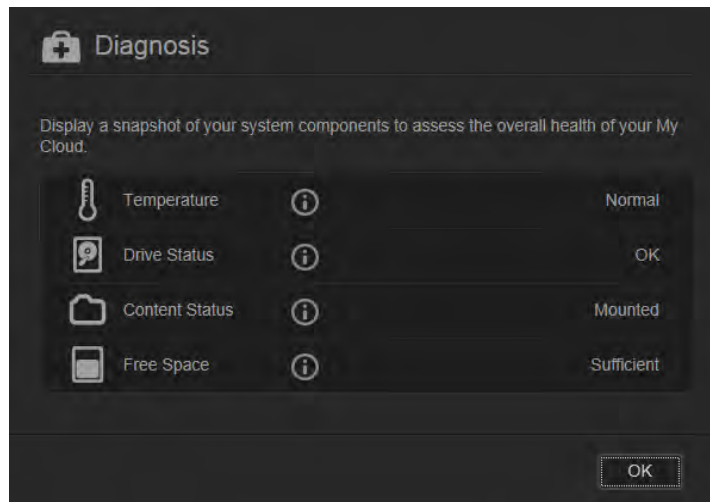

2. To return to the Home page, click **OK**.

Firmware

The Firmware panel displays the current version of firmware loaded on your WD My Cloud device.

1. To see whether an updated version of the firmware is available, click the arrow in the lower right of the Firmware panel. To return to the Home page, click **OK**.

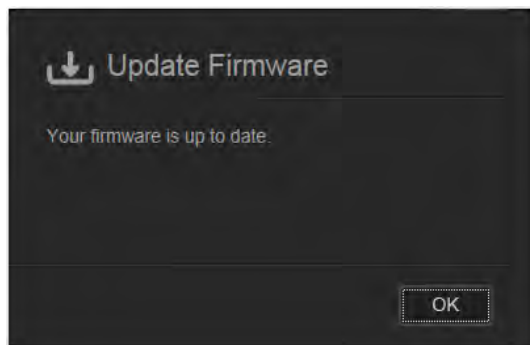

2. If new firmware is available, see “Firmware” on page 90 for information on updating your WD My Cloud device.

Cloud Devices

The Cloud Devices panel displays the number of cloud devices currently registered to the WD My Cloud device remotely. It enables you to generate an activation code that you need when setting up a mobile device for cloud access.

1. To add a mobile device, click the arrow in the lower right of the Cloud Devices panel to display the Add Cloud Access dialog box.

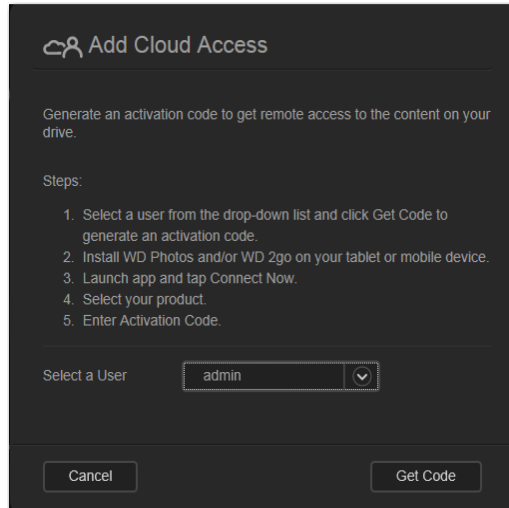

2. To generate an activation code, select a user from the drop-down list and click **Get Code**. The dialog box displays the activation code and the code's expiration date.

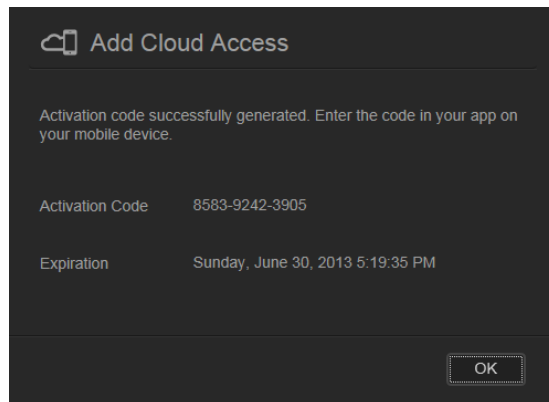

3. Click **OK**.
4. Follow the steps listed on the first Add Cloud Access dialog box to connect your tablet or mobile device to the WD My Cloud device.

Users

The Users panel displays the number of users currently set up to use the WD My Cloud device.

1. To add a user, click the plus (+) sign in the lower right of the panel. The Add User dialog box displays:

2. Enter the required information and click **Save**.

Shares

The Shares panel displays the number of public and private shares that have been created on the WD My Cloud device.

1. To add a share, click the plus (+) sign in the lower right of the panel.

2. Enter the share name and share description (optional).
3. If you want to stream media stored in this share to other devices, switch **Media Serving** to **ON**.
4. Click **Save**.

Content Scan

The Content Scan panel displays information about the latest media scan of the content stored on your WD My Cloud device and of the videos, music, and photos being streamed to DLNA devices. The scan takes place when the content changes, for example, when files are added.

1. To view the results of the latest content scan, click the arrow at the bottom right of the Content Scan panel to display the Content Scan Status screen:



Note: Actually, the WD My Cloud device runs two scans:

The first section allows cloud accessed devices (mobile) to see thumbnails for supported files (e.g., jpgs). The second section is what a media server would see and be able to access (e.g., Windows Media Player).

The Media crawler section shows progress bars. They change to check marks when the scan is complete. Hovering the cursor over the check marks in the media scan section displays a progress bar and number of files processed.

The DLNA section shows “scan in progress...” next to the DLNA Media Server text and only shows counts of files as it is scanning. When the scan is complete, a check mark replaces the progress bar. Hovering the mouse over a check mark displays status and number of files scanned.

2. Click a category’s check mark to see scan results.
3. To return to the Home page, click **OK**.

Obtaining Customer Support

To open the Support page:

1. Click the **Help** icon **?** at the top right of each page to display the Help menu.
2. Click **Support** to display the following page:

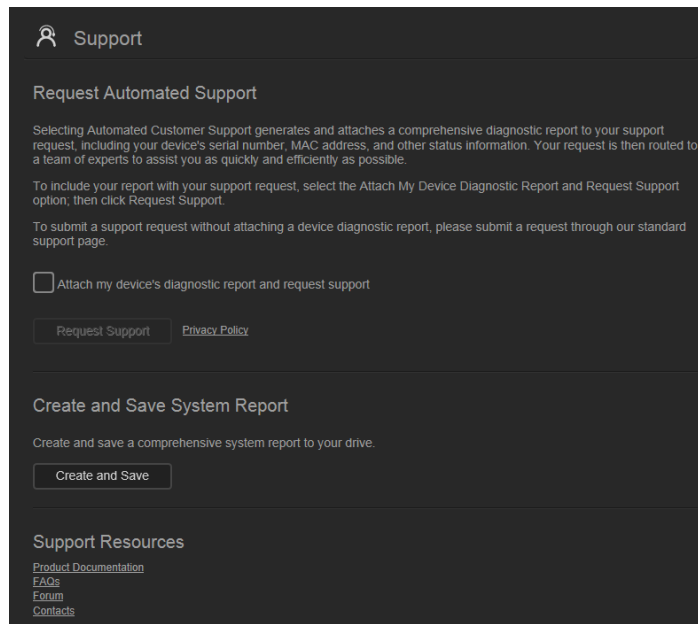

If a problem occurs with the WD My Cloud device, WD Customer Support will need information about your WD My Cloud device to troubleshoot and determine the best solution. There are two ways in which you can get your device info and request support:

- Run a system report and send it to WD automatically.
- Create a system report manually and send it to WD.

Requesting Automatic Support

Note: To use this feature, make sure to disable any pop-up blockers.

In the Request Automated Customer Support section:

1. Click the **Attach my device's diagnostic report and request support** check box if you want to send a diagnostic report and request automated support.

Note: You must click this checkbox to activate the **Request Support** button.

2. If you want to review WD's privacy policy, click the **Privacy Policy** link.
3. Click **Request Support** to display the WD Support web page.
4. Complete and send the request.

Creating and Saving a System Report

In the Create and Save System Report section:

1. Click **Create and Save**.
2. Save the report to your computer.
3. If desired, email the report to WD Customer Support.

Obtaining Other Support

In the Support Resources section are links to additional resources:

- To obtain the most recently updated user manual, click the **Product Documentation** link.
- To see answers to frequently asked questions and instructions, click the **FAQs** link.
- To discuss your WD My Cloud device with other users, click the **Forum** link.
- To see WD phone numbers and other contact information, click the **Contacts** link.

Basic Administrative Tasks

The next few chapters step you through the procedures for configuring and using the WD My Cloud device. The following table provides shortcuts to instructions for some basic administrative tasks.

How do I ...	See ...
Set up the device on my network	page 9
Access content from the device (public and private shares)	page 21
Upload and back up content to the device	page 24
Create users	page 53
Create shares	page 56
Download WD mobile apps	page 62
Enable or disable remote access for you and people you want to share with	page 76
Enable DLNA and iTunes	page 82
Shut down or reboot the WD My Cloud device	page 83
Update firmware	page 90
Create and recover safepoints to back up the device	page 93

7

Managing Users

[About Users](#)
[Viewing Users](#)
[Creating a User](#)
[Changing a User's Password](#)
[Editing User Settings](#)
[Removing a User](#)

About Users

As the WD My Cloud device owner (admin), you have a special user account (admin) that gives you administrative privileges. These privileges enable you to set up and configure the device to your specific needs, as well as give other people access to your personal cloud. You have the power to determine exactly what other users can access. As a default, the admin user name does not have a password. You can add one at any time.

The **Users** icon  displays a list of current users and enables the admin account to view user details, create new users, create shares, and grant users access to existing shares.

Viewing Users

1. On the navigation bar, click **Users** to display the Set Up Users page. You'll see a description of the page and some Help topics.

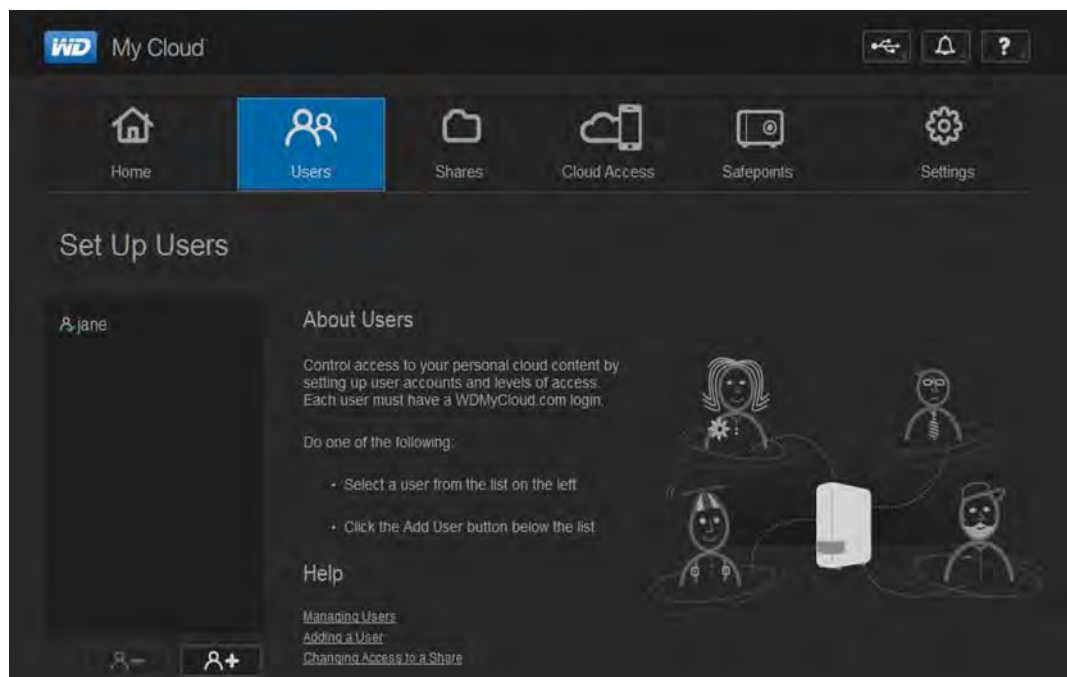

Only the admin is listed in the Set Up Users pane. Once you create more users, they are listed as well.

Note: If you entered your name when you created your personal cloud, your name rather than “admin” is listed first. The admin account has a check mark beside its name.

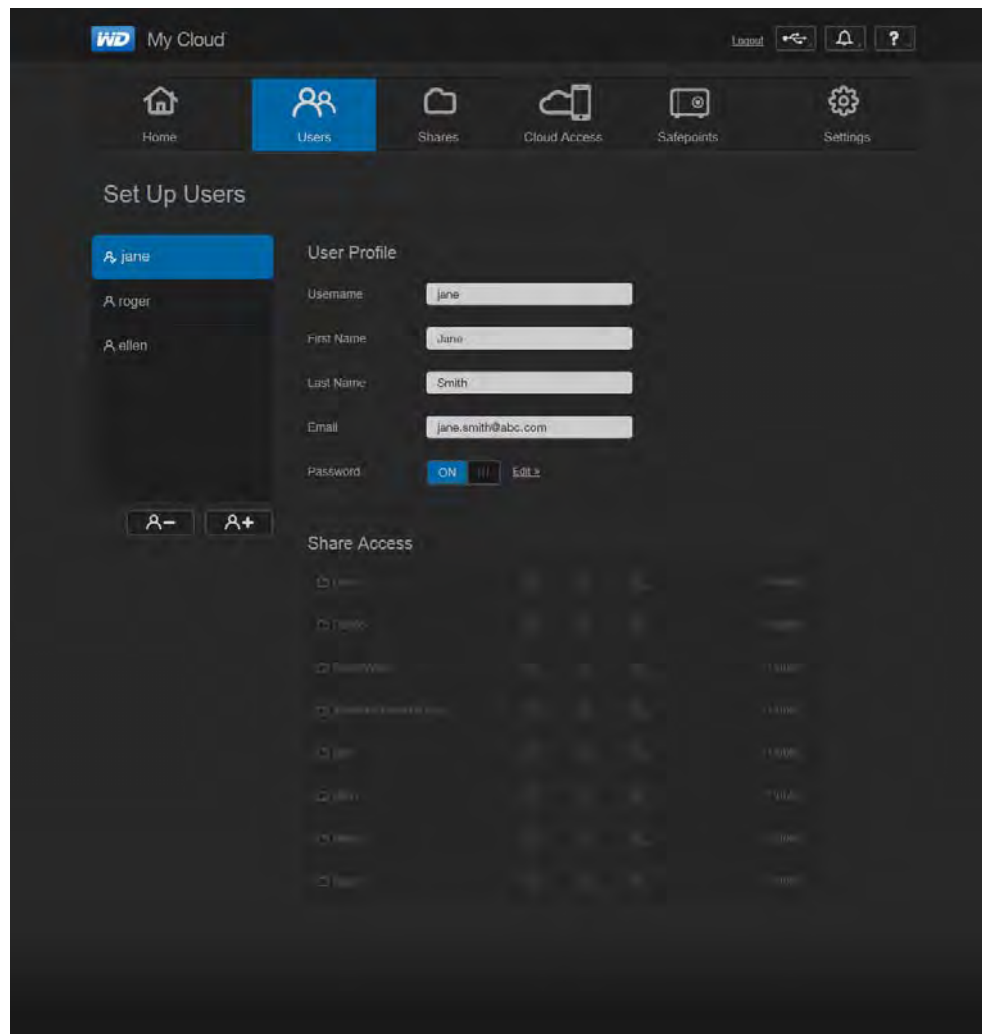

- To view user details, click a user name on the left. The user’s profile and share access information display. Initially, all the shares are Public and inaccessible, meaning they cannot be changed on the Add a User page.

Note: For information about changing share access, see “Making a Share Private” on page 57.

Creating a User

The administrator creates users and may limit their access to shares.

1. Click the **Add User** icon (below the list of users) to display the Add User dialog box.

2. Enter the user's first name, last name, and email address (optional). The first name becomes the user name. If you do not enter an email address, the user will not receive an email confirming WDMycloud.com access and instructions.
3. To prevent others from accessing the user's private share, you may enter a password for the user.
4. Click **Save**. The Set Up Users page displays a profile of the new user, who is listed on the left.

Note: To assign a private share for the user, see "Making a Share Private" on page 57.

Important: Make sure to inform the user of the name and password, which is needed to access private shares on the LAN.

Changing a User's Password

When viewing details about a user, the administrator can add or change the user's password (no password is the default setting).

1. On the Set Up Users page, select the user from the list on the left.
2. Click the **Edit** link to the right of the **Password** button to display the Edit Password dialog box:

3. Enter the new password in both the **Password** and **Confirm Password** fields.
4. Click **Save**.

Editing User Settings

1. On the Set Up Users page, select the user. The User Profile and Share Access panels display.
2. Modify the settings as desired and click **Save**.

Removing a User

You can delete all users except the administrator.

1. On the Set Up Users page, select the user.
2. Click the **Remove User** icon , and in response to the confirmation message, click **OK**.

8

Managing Shares

- [Managing Shares](#)
- [Viewing a List of Shares](#)
- [Creating a New Share](#)
- [Making a Share Private](#)
- [Deleting a Share](#)
- [Accessing the Contents of a Share Locally](#)

About Shares

A share is an area on the WD My Cloud device for storing files. A share can be public so that all users can access the contents, or private to limit access to selected users. The **Shares** icon on the navigation panel displays a list of shares on the WD My Cloud device and enables the administrator to manage shares and user access.

Viewing a List of Shares

1. Click the **Shares** icon on the navigation bar to display a list of shares on the WD My Cloud device. For each share name, the description and the media serving and access status display. Included in the list as shares are (WD) SmartWare backup, TimeMachine Backup, and shares on a USB device connected directly to the WD My Cloud expansion port. The first time you access the page, it displays an explanation, a graphic description, and links to pertinent Help topics.

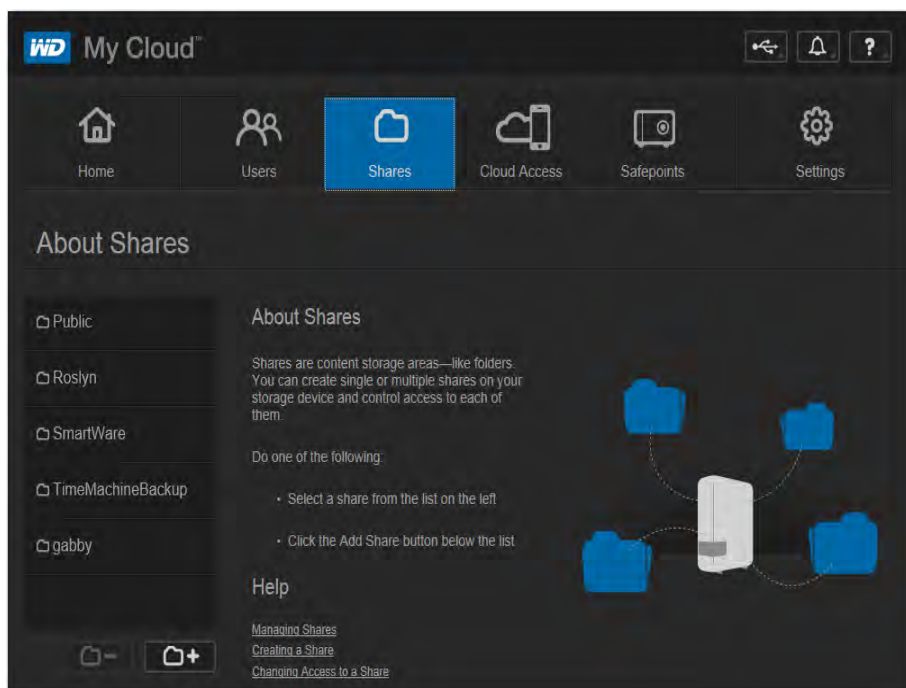

- Click a share to display its profile and user access information. The user access list is inaccessible when **Public Access** is **ON**; you can change the user's access to the share when **Public Access** is **OFF**.

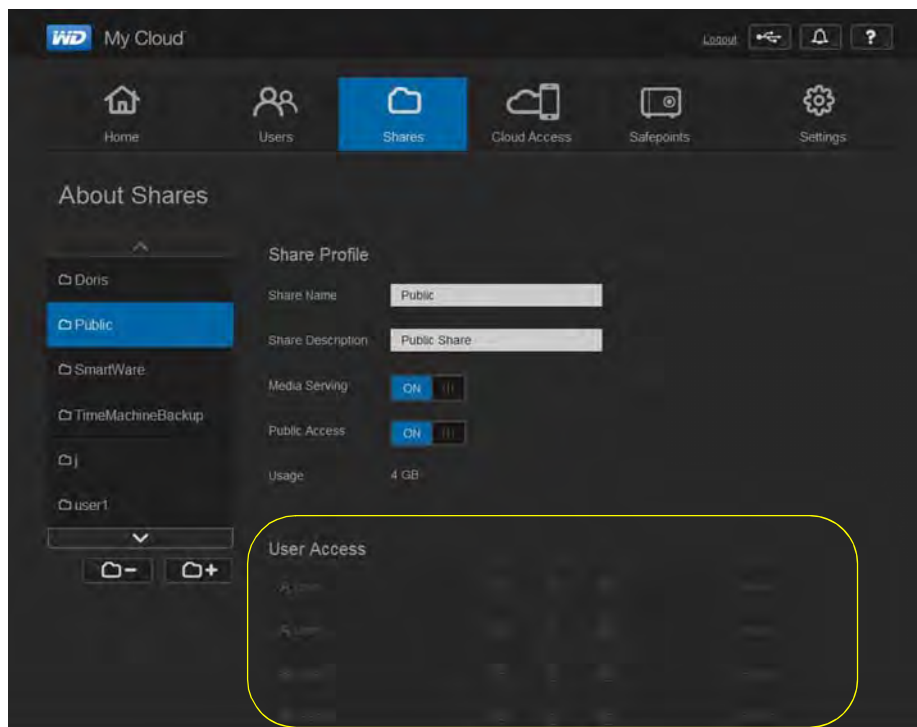

Creating a New Share

You can create a share and designate it as public or private. For example, if the share contains financial information, you may want to make the share private. Or, if there are photos you would like a friend to see, you can make the share public to that friend.

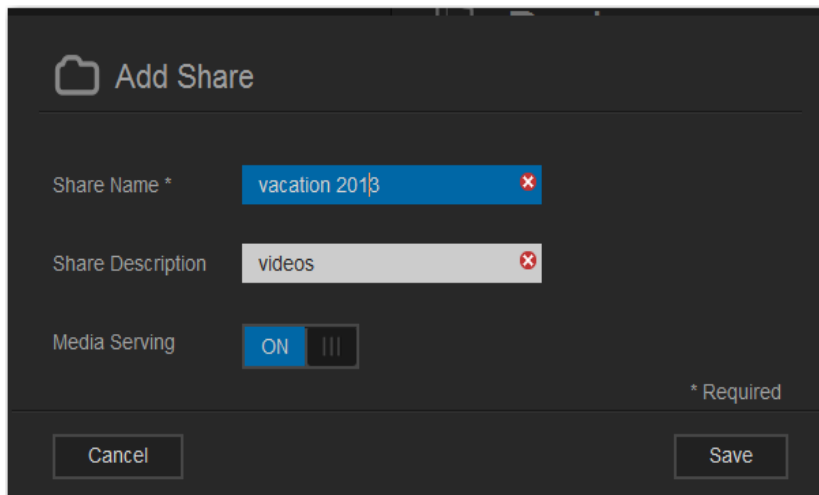

- Click the **Shares** icon on the navigation bar to display the About Shares page.
- Click the **Add a Share** icon .



- Complete the settings, as follows:

Share Name	Assign a name to the share. (Names must be case sensitive and contain 1-32 alphanumeric characters but no spaces.)
Share Description (optional)	Enter a brief description of the share to remind yourself of what it contains. Share descriptions must begin with an alphanumeric value and can contain up to 256 characters.
Media Serving (optional)	If you want to stream media stored in this share to other devices, switch Media Serving to ON . (Default is OFF .)

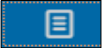
- Click **Save**. The About Shares window returns. It now lists the new share, showing its profile and user access information.
- If desired, change the share's access level by clicking the appropriate icon for the share:



	read/write
	read only
	no access

Making a Share Private

If you decide there is a reason to limit access to a public share, convert it to a private share.

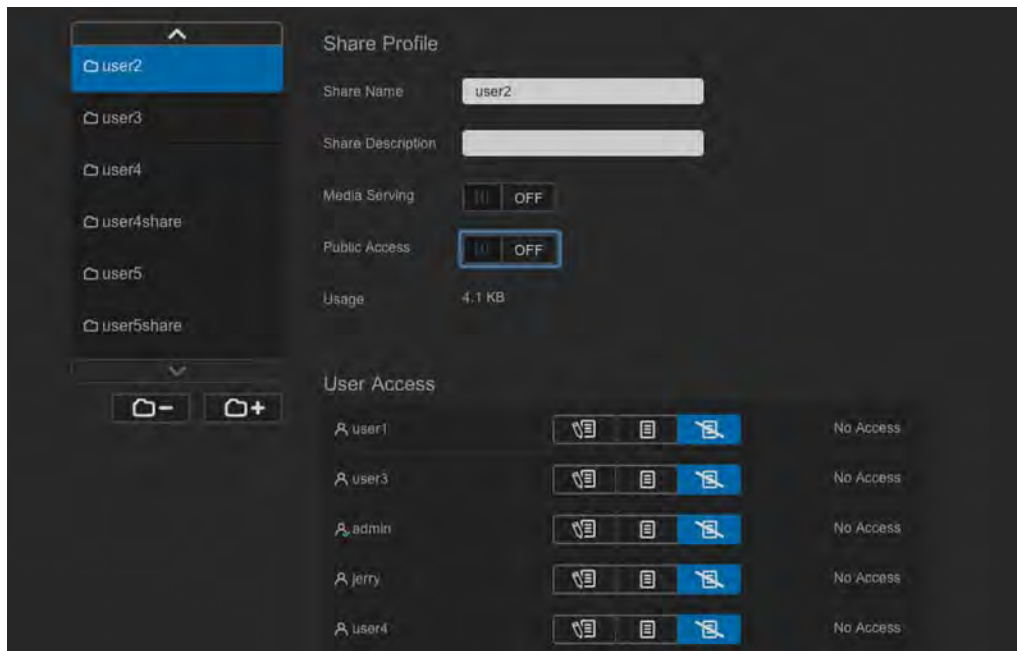
- Select the share.



- On the About Shares page, switch the **Public Access** button to **OFF**.
- For each user listed in the **User Access** section, select the level of access by clicking the appropriate icon for the share (read/write , read only , or no access ).

Deleting a Share

WARNING! Deleting a share erases all files and folders on the share.



1. Select the share in the list of shares on the About Shares page.
2. Click the Delete Share icon .
3. In response to the confirmation message, click **OK**.

Accessing the Contents of a Share Locally

Note: For information on accessing the contents of a share remotely, see “Accessing Your Cloud Remotely” on page 60.

Several options are available for opening a WD My Cloud share. For a private share, the user must have:

- A user name and password assigned to the share name
- Read-only or full access to the share

IF you want to open a share using . . .	THEN . . .
WD Quick View icon in the system tray (Windows)	<ol style="list-style-type: none"> 1. Left- or right-click the WD Quick View icon  to display the main menu. 2. Click the WD My Cloud device name, and then click Open. The shares display in Windows Explorer. 3. For a private share, if prompted for a user name and password, enter those associated with your user account. 4. For a private share, if the user's name and password are the same as for logging into the computer, a user name and password are not required. If they are not the same, visit http://support.wd.com and see Knowledge Base Answer ID 5681.
WD Quick View in the menu bar (Mac OS X)	<ol style="list-style-type: none"> 1. Click the WD Quick View icon  in the menu bar and move the cursor over the name of your WD My Cloud device to display the submenu. 2. Select Open on the WD Quick View submenu. The shares display in a second submenu. 3. Select the desired share. 4. For a private share, if prompted for a user name and password, enter those associated with your user account (see “Creating a User” on page 53). 5. For a Public share, if prompted for a user name and password, select Guest.
Windows 8	<ol style="list-style-type: none"> 1. In the task bar, click the File Explorer icon . 2. In the left panel, select Network, and double-click WDMycCloud. 3. Double-click a Public or private share on your device.

IF you want to open a share using . . .	THEN . . .
Windows Vista/Windows 7/ Windows XP	<ol style="list-style-type: none"> 1. Click  or Start > Computer. 2. In the left panel, select Network 3. Click WDMycloud. 4. Double-click the Public or private shares on your device.
Mac OS X	<ol style="list-style-type: none"> 1. Open a Finder window and locate your WD My Cloud device under the Shared heading in the side bar. If presented with an authorization page, select Guest, and then click Connect. 2. Click the device to display the Public share and any private shares to which you have access.

9

Accessing Your Cloud Remotely

[Enabling Cloud Access for the WD My Cloud Device](#)

[Enabling Cloud Access for a User](#)

[Mobilizing Your Files with WD My Cloud Mobile Apps](#)

[The Pathway to Your Personal Cloud](#)

[Accessing Your Personal Cloud on the Web](#)

Note: For information about the WD My Cloud for desktop app, see “Installing the WD My Cloud™ for Desktop App” on page 16 and “Using the WD My Cloud for Desktop App” on page 19.

A personal cloud is your content, at home, secure and under your control. Unlike public clouds, a personal cloud allows you to keep all your content in one safe place on your home network. Share files, stream media, and access your content anywhere, from the web and from mobile devices. No monthly fees. No mysterious location for your data. Keep your videos, music, photos, and files safe at home and always with you.

This chapter explains how to set up the WD My Cloud device for remote access and describes some of the ways you can take advantage of its many capabilities.

Enabling Cloud Access for the WD My Cloud Device

To enable the WD My Cloud device for remote access and to check the status of its remote connection(s), see page 76.

Enabling Cloud Access for a User

You can assign the user remote access rights to the WD My Cloud device via the WDMycloud website and from mobile devices.

1. On the navigation bar, click **Cloud Access** to display the Configure Access page. The admin's name has a check mark beside it to differentiate it from other users.

Note: The first time you access it, the screen provides some helpful information and links.

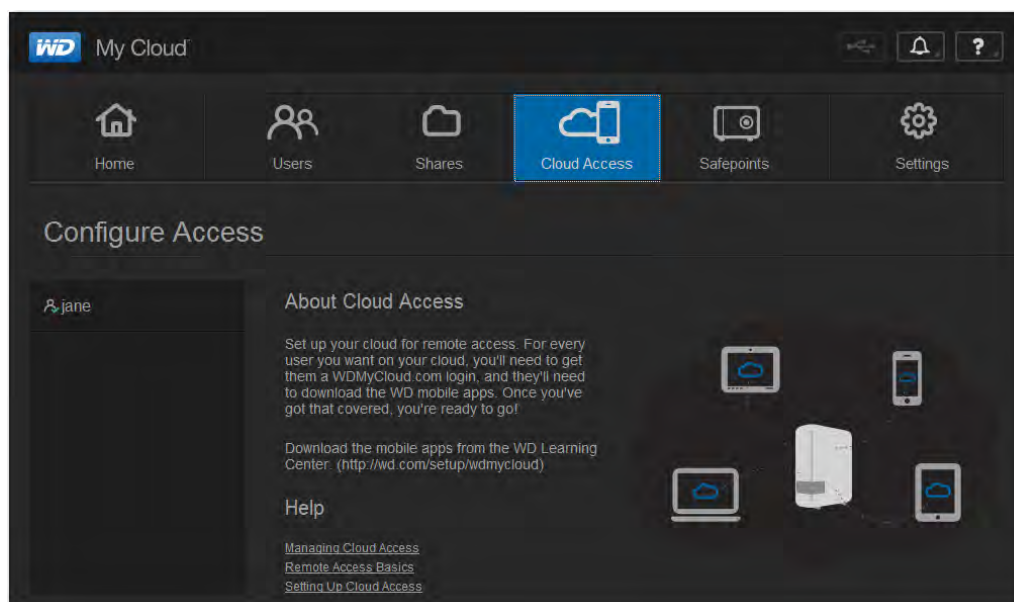

2. Select the user.



To give the user access to the WDMYCloud.com web site:

1. If the user already has a WDMYCloud.com login, you can update and/or resend it to the user by clicking the appropriate icon.
 - Note:** You can also delete it.
2. If the user does not have a WDMYCloud.com login:
 - a. Click **Sign Up** to display the Sign Up for WDMYCloud.com Login dialog box.

The dialog box is titled 'Sign Up for WDMYCloud.com Login'. It contains the text 'Sign up to get a login for WDMYCloud.com.' Below this are two input fields: 'Your Name *' and 'Email Address *'. To the right of the 'Email Address *' field is the text '* Required'. At the bottom of the dialog are two buttons: 'Cancel' and 'Save'.

- b. Enter the user's name and email address and click **Save**.
- c. In response to the confirmation message, click **OK**. The user receives the email and must follow its instructions.

To generate an activation code for a user's mobile device(s):

Important: Codes are valid for 48 hours from the time of request and can be used one time only.

1. Click **Get Code**. You must generate one code for each app you want to activate. A dialog box displays the user's activation code and its expiration date and time.

Note: Make sure to write down the access codes.

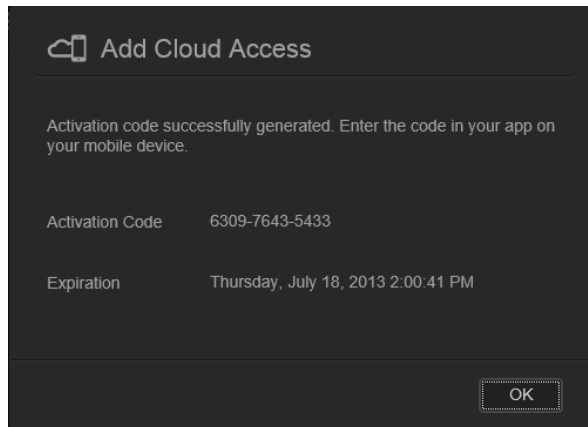

2. Click **OK**.
3. The Configure Access page displays the cloud devices for which the user now has access, along with the activation code and expiration date of each. The device is labeled New Unregistered Device for now.

Mobilizing Your Files with WD My Cloud Mobile Apps

WD My Cloud and WD Photos mobile apps bring your photos and files to your fingertips on your iOS and Android mobile devices. These mobile apps are also available for download for your Windows or Blackberry mobile devices.

Note: Screen captures shown in this chapter are from an iPhone. Functionality and installation may vary from device to device.

Requirements include:

- WD My Cloud personal cloud storage device connected to the Internet
- Your WDMycloud.com email address and password or a mobile device access code generated by your WD My Cloud device
- Android devices—Most tablets and smart phones with OS 2.1 or later
- iOS devices
 - WD Photos—iPhone, iPod touch, or iPad with OS 4.x or later
 - WD My Cloud —iPhone, iPod touch, or iPad OS 5.x or later
- Windows and Blackberry devices (for WD My Cloud mobile apps only)

About WD Photos Mobile App

Entertainment is happening all around you. Now you can capture every moment of it and send it to your device for access on any page in your home. Take a photo or video clip on your smartphone or tablet and upload it directly to your WD My Cloud device. Then you will have new files waiting for you so you can enjoy them in your entertainment center.

Important: WD Photos enables you to view photos in .jpg format only.

Show off your entire photo collection, that can include thousands of photos, without taking up tons of space on your smartphone.

WD Photos is compatible with leading Apple mobile devices and many popular Androids such as the DROID by Motorola, DROID Incredible by HTC, Nexus One, and HTC EVO 4G. Photos are automatically optimized for viewing on your mobile device.

WD Photos lets you view your most recently accessed photos even when you are offline. Display your photos vertically or view them horizontally and turn your mobile device into the ultimate photo album.

With WD Photos, you can:

- Instantly post photos to Facebook.
- Create a slideshow with transitions to create digital art.
- Access previously viewed photos even when you are offline.
- View your photos all at once or filter them by folder or album.
- Search by file name, folder name, or date using the built-in search options.
- Email a photo to a friend.
- Assign a photo to a contact.
- Download a photo from your WD My Cloud device to the camera roll on your mobile device.
- Upload photos and videos from the camera roll on your mobile device directly to your personal cloud storage, no matter where you are.

Note: WD Photos automatically creates a subfolder on the WD My Cloud device with the mobile device name in the Public/Shared Pictures directory for uploaded photos. Similarly, the app creates a subfolder with the mobile device name in the Public/Shared Videos directory for uploaded videos.

For more features and instructions for using WD Photos, see the Help, Guide Me page, and Quick Tips within the WD Photos application, and go to <http://wd.com/mycloud>.

Installing WD Photos on Your Mobile Device

Important: WD Photos lets you view photos in .jpg format only.

To install WD Photos on your mobile device:

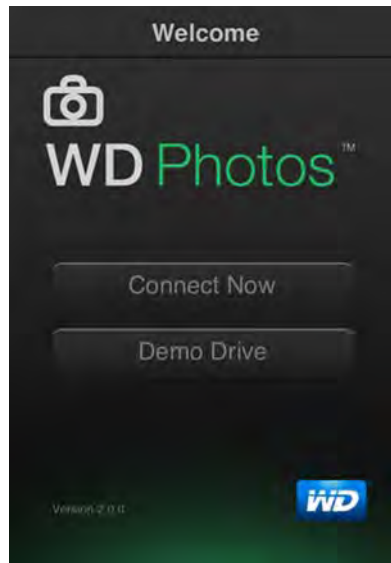

1. Download WD Photos from the Apple App Store or Android Market and install it on your mobile device.

2. Launch WD Photos on your mobile device to display the Welcome page.

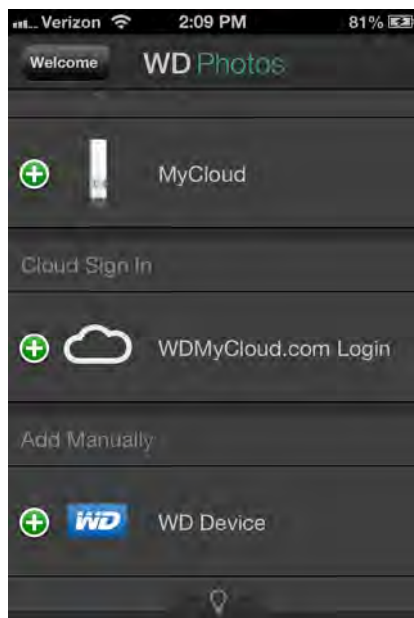

3. Tap **Connect Now** to display the WD Photos welcome page, which has three sections: Found in Network, Cloud Sign-in, and Add Manually.



4. You have three options for connecting to the WD My Cloud device:
 - **Found in Network:** If the mobile device is connected by Wi-Fi to the same Local Area Network as the WD My Cloud device, the app is automatically activated.
 - **Cloud Sign In:** Tap the  and sign into your personal cloud using your WDMyCloud.com login account email address and password.
 - **Add Manually:** If the mobile device is not on the same LAN or Wi-Fi network as the WD My Cloud device:
 - a. In the **Add Manually section**, tap the  to the left of **WDMyCloud**.

- b. Enter the activation code generated on the WD My Cloud's dashboard and tap **Activate**.

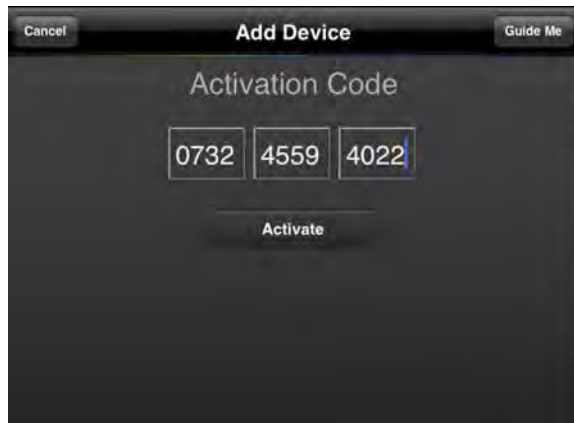

Note: You must generate one code for each app you want to activate. Codes are valid for 48 hours from the time of request and can be used one time only. See “To generate an activation code for a user’s mobile device(s):” on page 62.

5. Tap your WD My Cloud device to display your photos.



Note: If you have problems installing WD Photos, please visit <http://support.wd.com/m/wdphotos.asp>. For more features and instructions, see the app’s online Guide Me page, Help, and tips, and go to <http://wdphotos.wdc.com>.

Note: If you suspect that your WD My Cloud database has been corrupted, rebuild the database as described in “Cloud Access” on page 76.

About WD My Cloud Mobile App

You are always connected to your personal cloud. Save valuable space on your iOS, Android, Windows, or Blackberry devices with easy photo and video uploads directly to your personal cloud, and then securely access and share your memories from anywhere. Have a public cloud account? Conveniently expand your personal cloud with full access to your Dropbox and other cloud accounts.

Download the WD My Cloud mobile app from the Android Market, Apple App store, Windows store, or Blackberry World.

With the WD My Cloud mobile app, you can:

- Open and view the important files stored on your WD My Cloud device from anywhere without copying them to your mobile device.
- Show off your photos stored on your WD My Cloud device.
- Connect to other cloud sites such as Dropbox, Google Drive, and Skydrive from your tablet or smartphone.
- Stream and enjoy music and video files stored on your WD My Cloud device.
 - Note:** Video streaming performance is best over your LAN and when your mobile device is connected using Wi-Fi wireless connections. WAN streaming performance may be limited by upload speeds on your home Internet connection.
- Share your presentations on your Apple or Android tablets. WD My Cloud supports most major file types, such as Microsoft Word documents, Microsoft Excel spreadsheets, and PowerPoint presentations.

For more features and instructions, see the Help, Guide Me page, and Quick Tips within the WD My Cloud application, or go to <http://wd.com/mycloud>.

Note: The WD My Cloud app brings your data from the WD My Cloud device to your tablet, handset, or other portable devices using Google Android or Apple iOS. WD My Cloud provides a convenient file list of the WD My Cloud device contents and then launches your favorite player or viewer for any files you wish to open. For file types your mobile device supports, see the device's manual.

Installing the WD My Cloud Mobile App

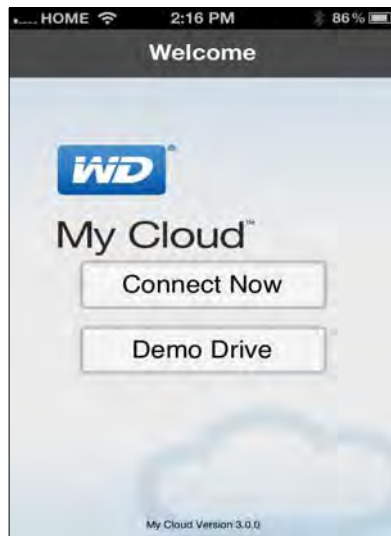

1. Download the WD My Cloud mobile app from the Apple App, Android Market, Blackberry World, or Windows Store and install it on your mobile device.

2. Launch the app to display the Welcome page:

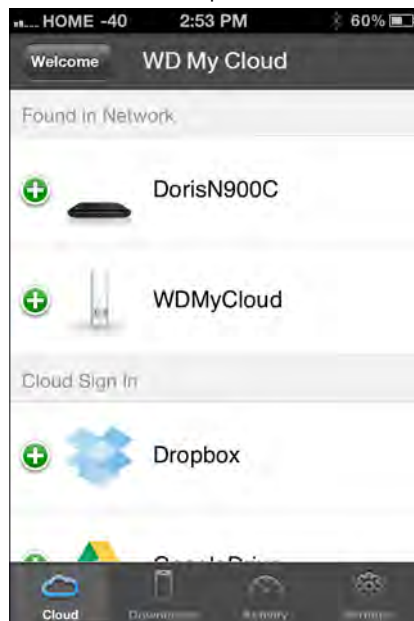

3. Tap **Connect Now**.
4. You have three options for connecting to the WD My Cloud device:



- **Found in Network:** If the mobile device is connected by Wi-Fi to the same Local Area Network as the WD My Cloud device, the app is automatically activated.
- **Cloud Sign In:** Tap the  and sign into your personal cloud using your WDMyCloud.com login account email address and password.
- **Add Manually:** If the mobile device is not on the same LAN or Wi-Fi network as the WD My Cloud device:
 - a. In the **Add Manually section**, tap the  to the left of **WDMyCloud**.
 - b. Enter the activation code generated on the WD My Cloud's dashboard and tap **Activate**.

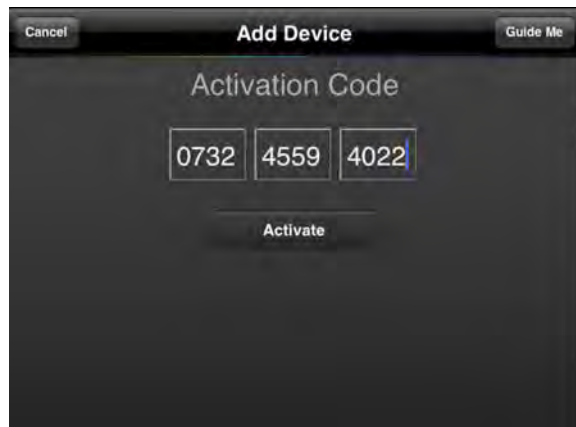

- c. You must generate one code for each app you want to activate. Codes are valid for 48 hours from the time of request and can be used one time only. See Enter your user name and password.
5. Tap **Done**.
 6. Tap your **WD My Cloud** device to display its share(s).



7. Tap a share to display its subfolders.

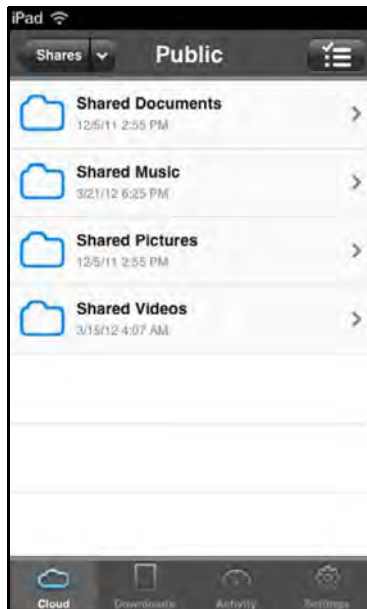

8. Tap a subfolder to display a list of files.



9. Tap a file to display it.

Note: If you have problems installing the WD My Cloud app, visit <http://websupport.wd.com/rn/wdmycloud.asp>. For more features and instructions, see the app's online Guide Me page, Help, FAQs, and tips, or go to <http://wd.com/mycloud>.

If you suspect that your WD My Cloud database has been corrupted, rebuild the database. See "Cloud Access" on page 76.

The Pathway to Your Personal Cloud



If you can access the Internet from a computer, you can securely access your media and files anywhere in the world. WD My Cloud web access provides free remote access to your WD My Cloud personal cloud storage. Once you log in, the WD My Cloud device is mounted to your computer like a local drive, and your remote folders are available on your Mac or Windows computer. Seamlessly open, save as, and attach files to emails from this virtual drive.

Accessing Your Personal Cloud on the Web

Note: WD My Cloud access is not compatible with 64-bit Windows XP.

First-Time Users

1. After a user account is created, the new user receives an email with instructions for creating a wdmycloud.com password.
2. Follow the instructions in the email. The My Cloud Sign in page displays.

3. Enter the email address associated with the user and a password for wdmycloud.com, and then click **Sign in**. The password must be between 8 and 30 characters and contain two of the following: a number (0-9), an uppercase letter (A-Z), or a special character (!@\$%^&*).
4. The My WD Devices screen displays your device. Continue to “Using Your Personal Cloud (wdmycloud.com)” on page 71.

Returning Users

1. In a browser, sign in to <http://www.wdmycloud.com> using the password you created for wdmycloud.com. My WD Devices page displays your device.
2. Continue to “Using Your Personal Cloud (wdmycloud.com)” on page 71.

Using Your Personal Cloud (wdmycloud.com)



1. Click the button on the lower right and select **View shares**.
2. If your WD My Cloud device is password protected, enter your password in the **Network Drive Password** field.

 A screenshot of a login form. It has two input fields: 'UserID:' with the text 'Jane' entered, and 'Password' with four black dots. Below the fields is a 'Login' button.

3. Depending on whether you have remotely accessed a share before, a Java application run request may appear. For more information about Java applets, search for Answer ID 9786 in the WD Knowledge Base at <http://support.wdc.com>. For Lion and Mountain Lion, you will need to install the Java runtime client. For additional information, visit <http://support.apple.com/kb/dl1421>
4. If a message asks you whether you want to “allow” Java, click **Allow**.
5. Several messages regarding SSL certificates and a few security warnings display, starting with:

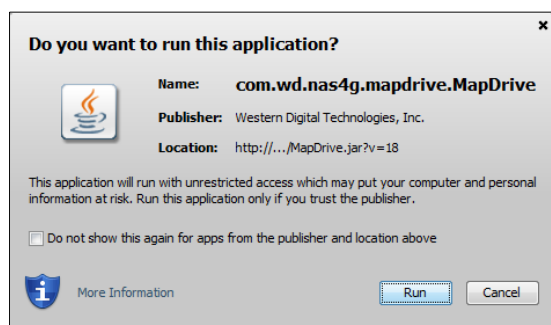

and ending with:

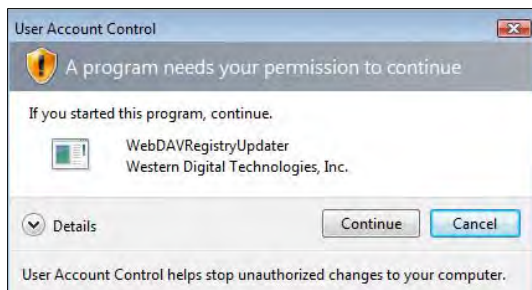

Respond affirmatively to each screen to complete the process. Your accessible shares display:

- In Windows, click the **+ Open in Explorer** button next to the share you want to access.



On a Mac, click the **+ Open in Finder** button next to the share you want to access.

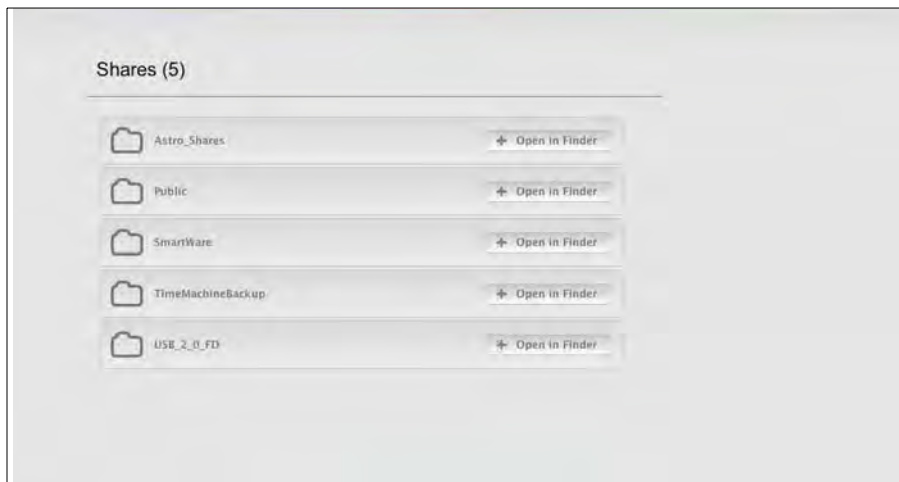

- You can now access your files. Depending on your operating system settings, your share may not appear automatically.

- On Windows, once your share has mounted successfully, a drive letter for the share displays under My Computer (XP) or Computer (Vista/Windows 7/Windows 8). You can use the drive letter like any other mapped network drive. Opening the drive displays all of the folders and files in the share.

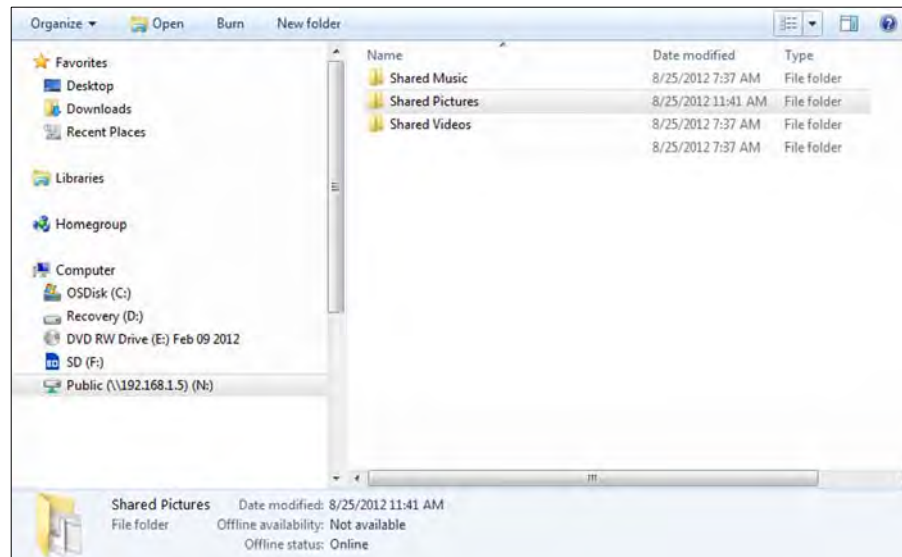

- On a Mac, the Finder window opens on its own once the drive successfully connects to the WD My Cloud device and displays your share.

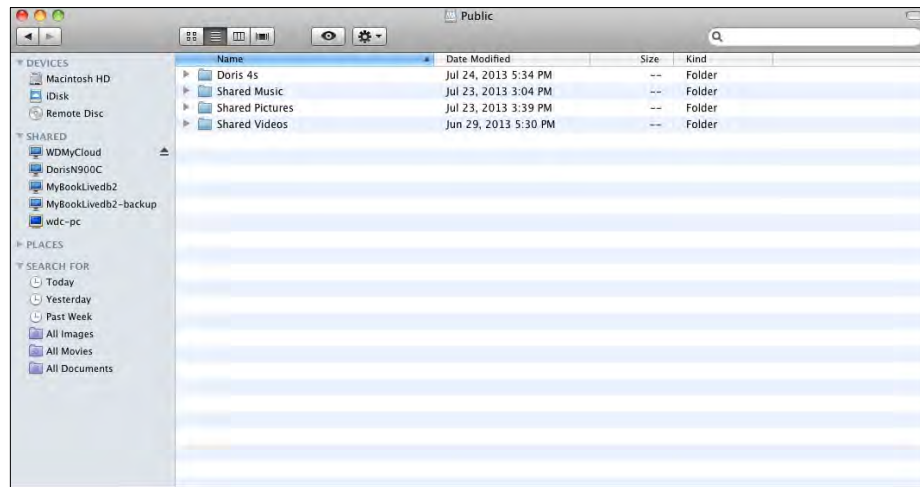

- Select the file(s) you want to access.

You can view, edit, delete, or copy files just as you would with any network drive.

Sharing Your Files Remotely

You can easily share files remotely with a family member or friend. When the user is created, an email is sent that provides a link to WDMycloud.com and some instructions. The user creates a password and logs in. Only the shares to which the user has access and the Public share display.

If the person is not already a user of the WD My Cloud device, create a new user, including a password and email address (see "Creating a User" on page 53).

10

Configuring Settings

[General](#)
[Network](#)
[Media](#)
[Utilities](#)
[Notifications](#)
[Firmware](#)

The Settings option on the navigation bar enables the administrator to view and customize the WD My Cloud device's system, network, media, utilities, notifications, and firmware settings.

General

Use the General page to view and modify the device name and description, select the language in which the user interface should display, enable or disable cloud access, set energy usage settings, and enable or disable Time Machine backups.

WARNING! Renaming the WD My Cloud device forces all the network computers to remap their shared network resources. Change the device name only when necessary.

1. On the navigation bar, click **Settings**, and then click **General** in the left pane. The General page displays:

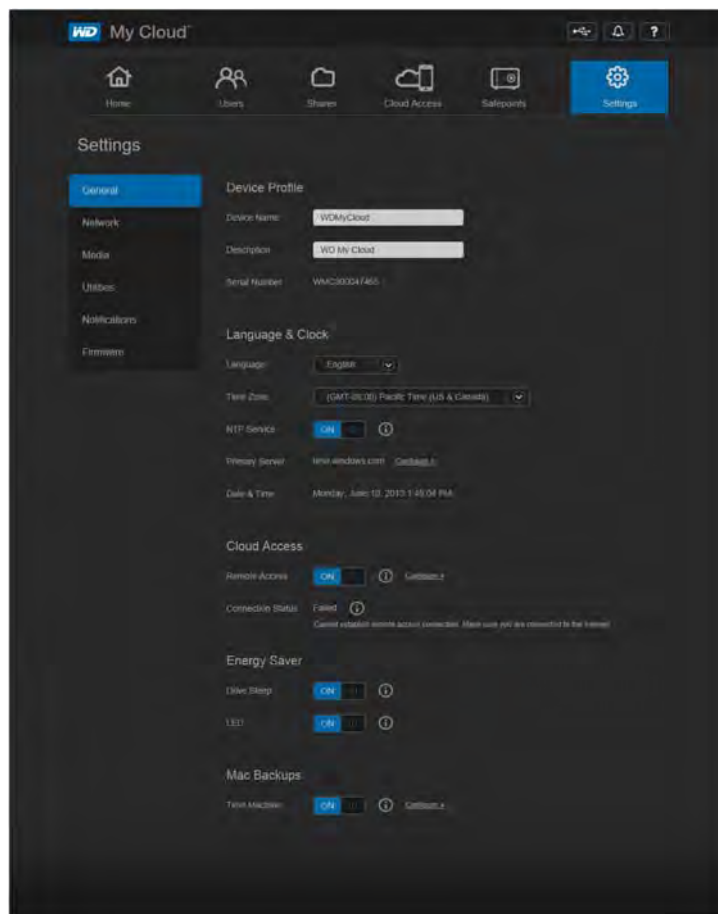

Device Profile

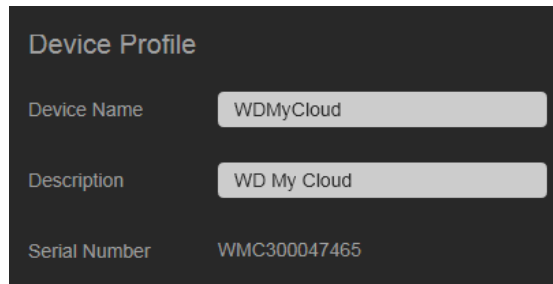

Device Profile

Device Name: WDMYCloud

Description: WD My Cloud

Serial Number: WMC300047465

1. In the Device Profile section of the General page, view or modify the following settings:

Device Name	Enter a unique name for your device to identify it on the network.
Device Description	The default description is WD My Cloud. If desired, enter a different description.
Serial Number	Displays the WD-assigned number that identifies the specific unit.

2. If you made any changes, click **Save** (appears below the section).

Note: Throughout the WD My Cloud dashboard, the **Save** and **Cancel** buttons display only if you make changes.

Language and Clock

In this section of the General page, you can change the language displayed in the WD My Cloud device's interface and set the date and time. The date and time are synchronized to the NTP (network time protocol) server by default. You have the option of setting the date and time manually or allowing the NTP to access the Internet and automatically set the time. If you are not connected to the Internet, you must enter the date and time manually.

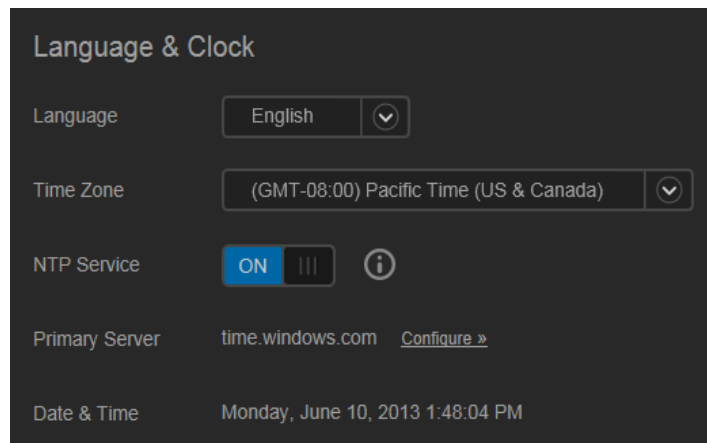

Language & Clock

Language: English

Time Zone: (GMT-08:00) Pacific Time (US & Canada)

NTP Service: ON

Primary Server: time.windows.com [Configure »](#)

Date & Time: Monday, June 10, 2013 1:48:04 PM

1. View or modify the following settings:

Language	From the drop-down list, select the language in which you want the WD My Cloud web pages to display. The default language is English.
Time Zone	From the drop-down list, select the time zone where your device is located.
NTP Service	<p>Leave NTP (network time protocol) Service ON to automatically synchronize your device to update the time and date. A page displays current NTP servers, and you can add another NTP server if you choose.</p> <p>If you turn NTP Service to OFF, click the Configure link that displays, enter the current date and time, and click Save.</p>
Primary Server	If you want to change to another primary NTP server, click Add User NTP , and then enter the URL address of the new primary server.
Date & Time	The date and time display. They are synchronized to the NTP server by default.

2. Click **Save** for each change you make.

Cloud Access

If you are an administrator, you can turn cloud access on or off for the WD My Cloud device, controlling whether computers and mobile devices can access the content on it.

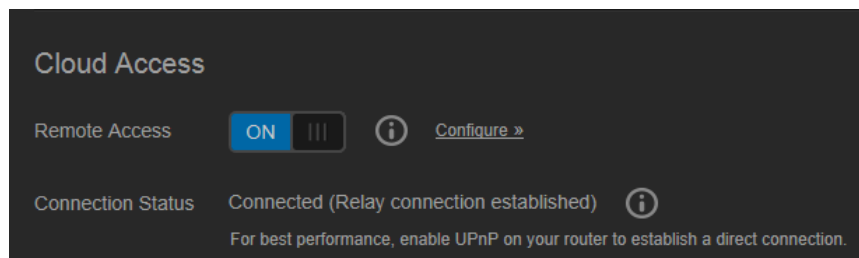

1. Toggle the **Remote Access** switch to enable (**ON**) or disable (**OFF**) remote access to the WD My Cloud device.

Note: For information about turning on cloud access for a single device or user, see “Mobilizing Your Files with WD My Cloud Mobile Apps” on page 62.
2. **Connection Status** displays information about the status of the remote access connection to the WD My Cloud device.

- Click the **Configure** link to change the type of connection.

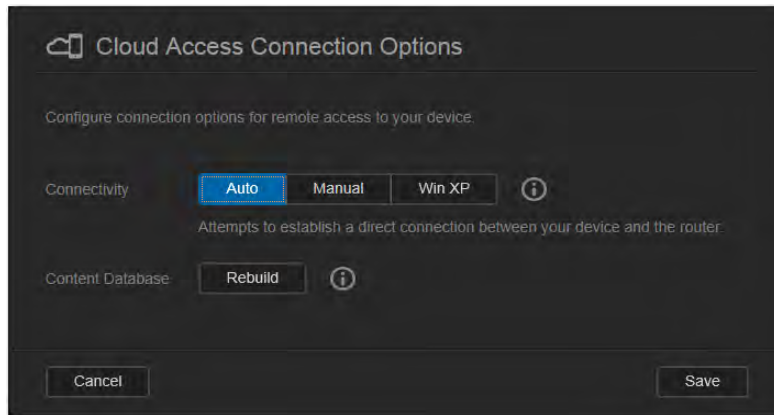

- By default, the WD My Cloud device automatically establishes a direct connection between your mobile devices and router.
- To change the connection type:
 - To make a manual connection, click **Manual**. **External Port 1 (HTTP)** and **External Port 2 (HTTPS)** numbers display. You can change these port numbers.
 - If you are using the Win XP operating system, click **Win XP**. The WD My Cloud device attempts to establish a compatible direct or relay connection

Note: If remote access is enabled through a relay connection (the Connection Status says **Connected (Relay)**), you can improve performance by enabling port forwarding on your WD My Cloud device.

For more information about connection options, see “Mobilizing Your Files with WD My Cloud Mobile Apps” on page 62.

- For troubleshooting purposes only, when database corruption is suspected, click **Rebuild**.

Important: Rebuilding will take a considerable amount of time.

- Click **Save**.

Checking Cloud Access Status

At any time, you can check whether:

- The WD My Cloud device is configured for remote access
- A remote access to your cloud is enabled through a direct or relayed connection
- A particular mobile device for a certain user is currently enabled to access your cloud remotely

To check cloud access status:

- On the navigation bar, click **Cloud Access**.
- In the left pane, click a user name.

Energy Saver

You can save power use by the WD My Cloud device.

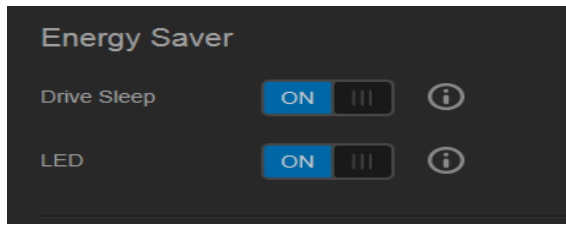

1. View or change the following settings:

Drive Sleep	If this function is enabled, the hard drive goes into standby mode to save power after a designated period of inactivity. Drive Sleep is enabled by default.
LED	Turns the device's LED on or off.

Mac Backups

This section of the General page enables or disables Time Machine backups of Mac computers. You can also configure Time Machine Settings.

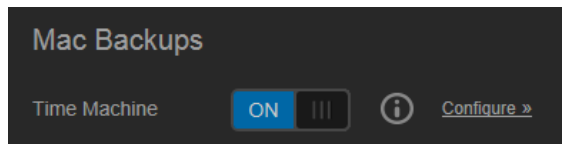

To configure backup settings:

1. With the **Time Machine** switch **ON**, click the **Configure** link to display the Time Machine Settings dialog box:

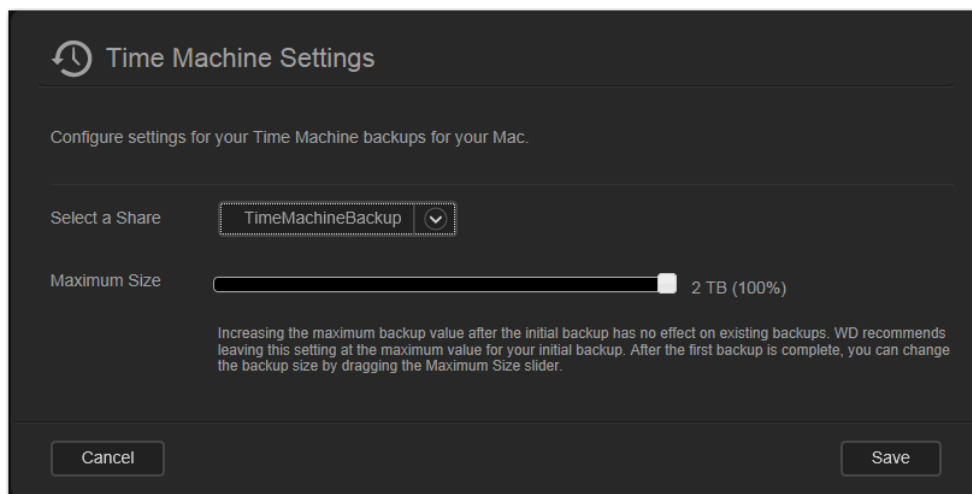

2. From the **Select a Share** drop-down list, select to back up all of the data on the Mac, or select a specific share to back up.

- Use the slider to indicate the **Maximum Size** of the backup. **Leave the slider at the maximum value** (quota) for your first backup (see on-screen note). After that, move the slider to a smaller quota to avoid filling up the entire drive with backups.
- Click **Save**.

Important: Once your Time Machine begins to back up your files to a selected share, we recommend that you continue to back up to that share. Switching shares generates a new backup file which will not contain your previously saved information.

Network

The **Network** page displays the device's MAC and IP addresses. You can set network options such as network mode, enable FTP protocol for secure file transfer, and create a work group.

Network Profile

- On the navigation bar, click **Settings**, and then click **Network** in the left panel.

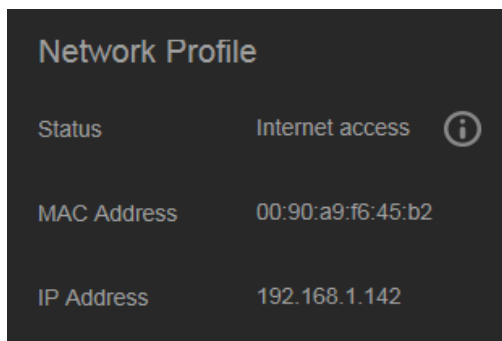

The Network Profile section displays the following information:

Status	The current status of Internet connectivity for network functions such as NTP, firmware update checks, and remote access connections.
MAC Address	Uniquely identifies the device.
IP Address	Identifies the device's current IP address.

Network Services

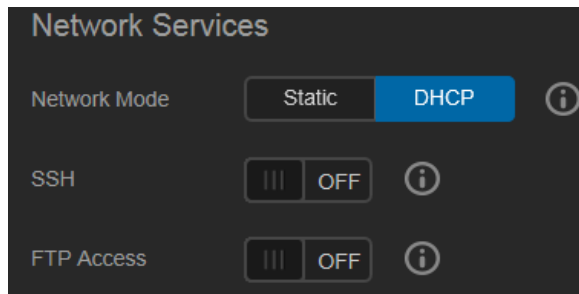

1. Review or update the following:

Network Mode	Select the method of assigning the device's unique IP address: <ul style="list-style-type: none"> DHCP Client (default) causes the WD My Cloud device to obtain an IP address and associated settings automatically from the local DHCP server. Static IP lets you set an IP address manually. You will be prompted for IP Address, Netmask, Gateway, and DNS Server. (If you don't know this information, check your router's settings.) For details on changing the network mode, see "Changing Network Mode from DHCP to Static:" on page 81.
SSH	Important: Enable SSH only if you are very familiar with it. Click ON to securely access your personal cloud and perform command-line operations via the Secured Shell (SSH) protocol. SSH is disabled by default.
FTP Access	File Transfer Protocol enables the transfer of data from one computer to another through a network. FTP is disabled by default. Note: An FTP requires a username and password. Anonymous FTPs are not allowed. You must create a new user for the FTP function to work. See "Creating a User" on page 53 for information on creating a username and password.

Changing Network Mode from DHCP to Static:

Note: If you switch from Static Mode to DHCP, you may need to re-discover the device on your network.

1. For the **Network Mode** option, click **Static**. The Change Network Mode dialog box displays:

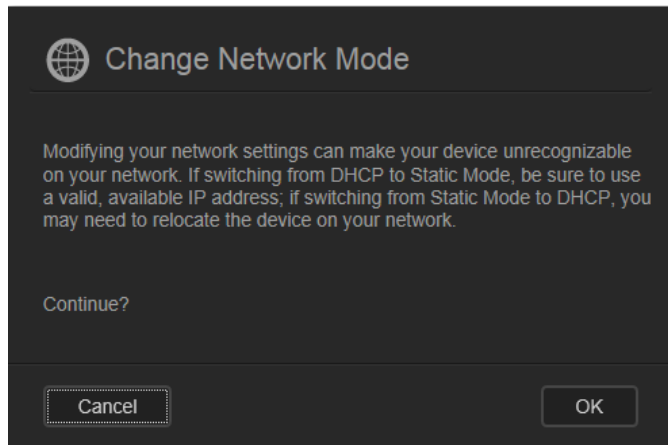

2. Click **OK** to display the Static Network Mode dialog box and continue with the change:

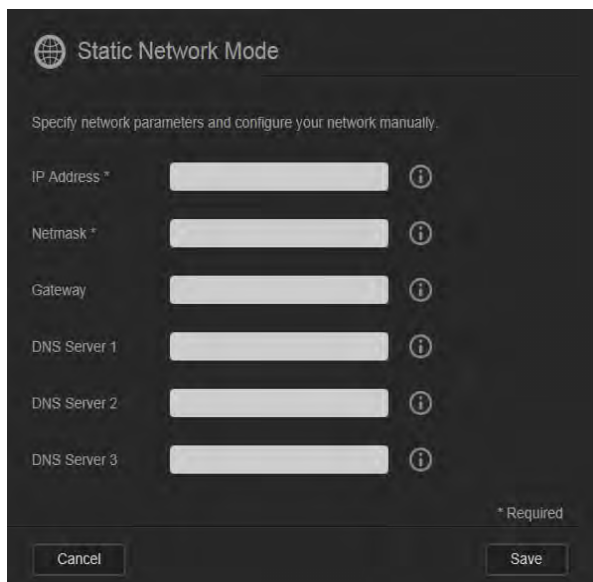

3. In the Static Network Mode dialog box, enter at least an **IP Address** and a **Netmask**. (If you don't know this information, check your router's settings.)

Note: If you do not enter Gateway and DNS Server(s), you will lose connection to the LAN.

4. Click **Save**.

Note: For more information on this topic, see Knowledge Base Answer ID 5872.

Workgroup (Windows)

A workgroup is a name you assign to each member of a group of computer network devices in a network environment. The devices that have the same workgroup name can easily exchange information through the network. A workgroup does not require a central server.

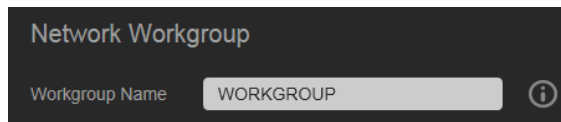

To name or rename a workgroup:

1. Enter a name for the workgroup (no spaces allowed).
2. Click **Save**.
3. Each time you add a device to your network, you can assign it this workgroup name.

Media

On the Media page, you can enter DLNA (Digital Living Network Alliance) media server and iTunes media player settings so that you can enjoy media in every room in your house.

1. On the Navigation bar, click **Settings**, and then click **Media** in the left panel.

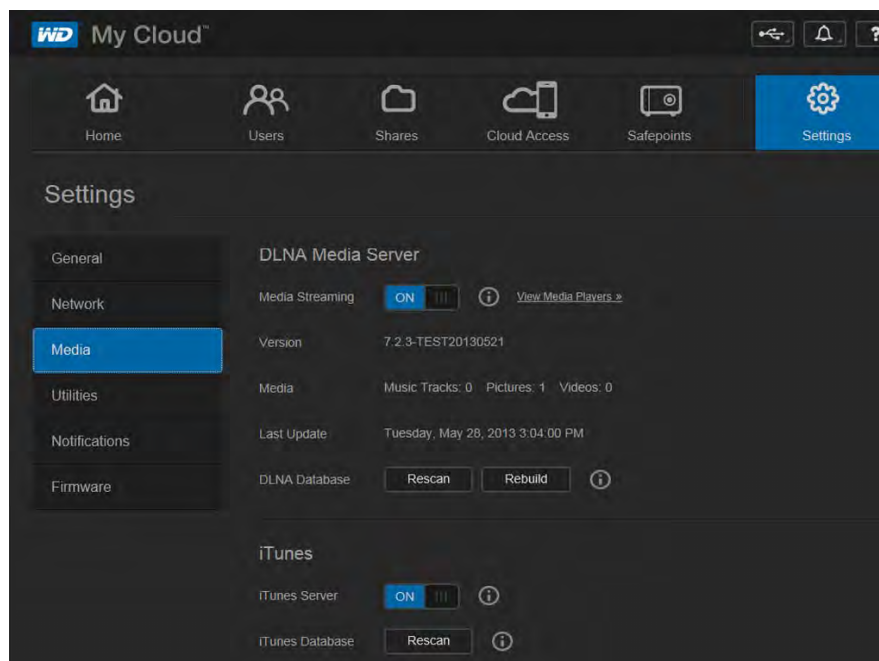

Note: DLNA and iTunes only works on your network.

2. For instructions on entering media settings on this page and then displaying or streaming media, see “Playing/Streaming Videos, Photos, & Music” on page 112.

Utilities

On the Utilities page, you can test the WD My Cloud device and get diagnostic information, restore the device to factory defaults, reboot or shut down the device, and import or export a configuration file.

1. On the Navigation Bar, click **Settings**, and then click **Utilities** in the left panel.

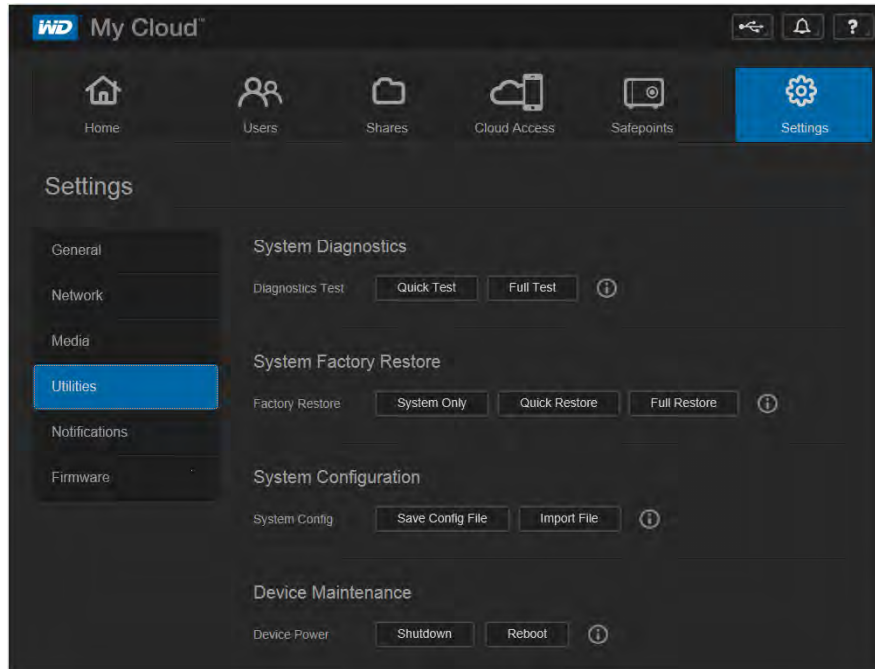

2. Carry out the functions on each section of the page as described below.

System Diagnostics

Run diagnostic tests if you are having problems with your device. The short test checks the device for major performance problems. The result of a short drive test is a pass or fail evaluation of the drive's condition. The short drive test can take several minutes to complete.

The more comprehensive drive diagnostic is the full test. It methodically tests each and every sector of your drive. You will be informed of the condition of the drive once the test is performed. The full drive test will take several hours to complete, depending on the size and data configuration of your drive.

To run a test:

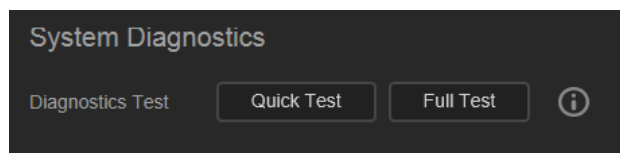

1. On the Utilities page, click **Quick Test** or **Full Test**. A progress bar displays, indicating test progress and whether the drive passed or failed the test.
2. If the drive passed the test, click **OK** to return to the Utilities page. If the drive fails the test, click the Support icon **?** in the upper right to get assistance.

System Factory Restore

Note: For information about using the **Reset** button to return the password and network mode to factory settings, see “Resetting the WD My Cloud Device” on page 119.

In this section of the Settings page, the Administrator can choose a system only, a quick, or a full factory restore.

Important: You might want to export and save the device's current configuration before restoring factory default settings so that you can import it afterwards. Note that importing a configuration in this case does not restore shares or users.

If you want to restore the complete contents of a WD My Cloud device, including user settings, backups, and data, use the safepoint feature described on “About Safepoints” on page 93. A restore disrupts service to users currently accessing your cloud.

WARNING! **Do not unplug your WD My Cloud device while a restore is in progress.**

As an administrator, you can restore the WD My Cloud device to its original, default settings, as well as wipe out all data securely. Three restore operations are available:

System Only: Changes all settings back to the factory default values, makes private shares public, and returns the administrator password to none. Your content remains untouched and intact.

Note: You can also do a system restore physically. See “Resetting the WD My Cloud Device” on page 119.

Quick Restore: Reverts all settings to their factory default values, deletes data in shares and sets the shares back to factory defaults, resets the WD My Cloud system, and erases the drive. It takes several minutes.

Full Restore: Reverts all settings to their default values and permanently overwrites or erases all user data and shares. It could take several hours for the process to complete.

To restore the WD My Cloud device:

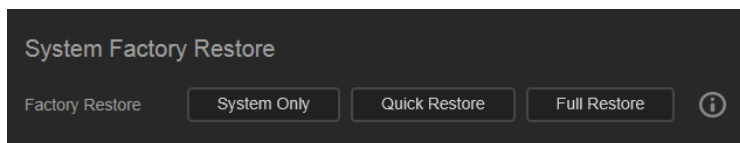

WARNING! **Interrupting the factory restore process may damage the WD My Cloud device. Wait until after the reboot to use the device again.**

1. In the **System Factory Restore** section, click the desired type of restore: **System Only**, **Quick Restore** or **Full Restore**.
2. When asked to confirm the action, click **Yes**.
3. When the progress bar displays, if you selected **Full Restore** in step 1, but you change your mind, click **Switch to Quick** to start a Quick Restore from the beginning.

- At the end of the restore, the “Factory Restore Successful” message displays, and the system reboots. A setup dialog box displays. Follow the wizard’s instructions.



Device Maintenance: Reboot and Shutdown

Important: Before rebooting or shutting down, make sure that there are no file transfers in progress. Check the LED on the front of the device to make sure it is not blinking. Blinking indicates that the unit is processing information (for example, backing up or transferring files).

WARNING! Do not unplug the device during reboot or shutdown.

You can safely reboot and shut down your WD My Cloud device using two methods.

- Device Maintenance section of the Utilities page (discussed below)
- WD Quick View icon (see “Utilities” on page 83).

If you are unable to shut down by either method, see “I am having trouble shutting down the WD My Cloud Device.” on page 122.

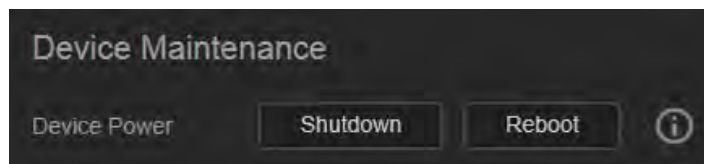

To reboot your device:

- On the Utilities page, in the Device Maintenance section, click **Reboot**.

The following message displays:

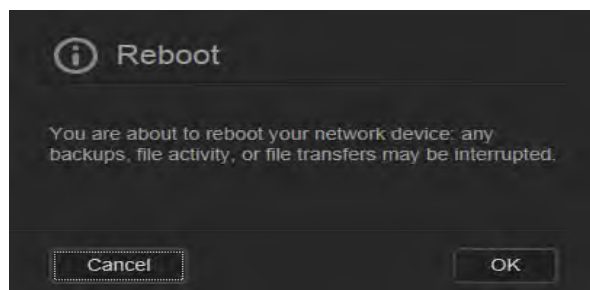

2. If the device is not processing information, or it is but you choose to proceed, click the **Continue** button.

The device shuts down and then restarts. Wait until the LED is solid blue before resuming work with the WD My Cloud device.

To shut down the device:

1. Click **Shutdown Device**.
2. A message reminds you that shutting down may interrupt important processes:



3. If the device is not processing information, or it is but you choose to proceed, click **OK**. The following message displays:

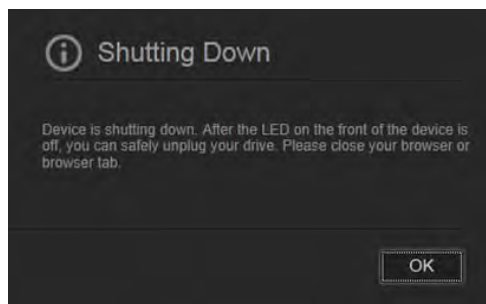

4. Click **OK** to close the message.
5. When the LED on the front of the device is off, you can safely unplug your device.
6. Close the browser.

Import/Export Current Configuration

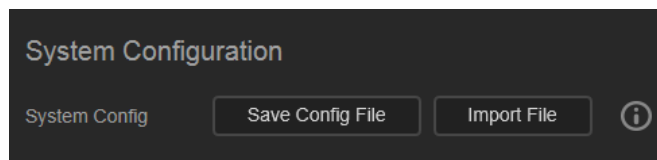

Important: Before doing a factory restore or a system update, you may choose to save your device's current configuration. At a later time, you can import a previously saved configuration. Keep in mind that importing a configuration after restoring factory defaults does not restore shares or users. See "About Safepoints" on page 93.

To save the current configuration:

1. Click **Save Config File**.
2. Browse to the location where you want to save the file and click **Save**.

To replace the current configuration:

1. Click **Import File**.
2. Browse to locate the replacement file, select it, and click **Open**.
3. Click **Open**, and when the Import Configuration File dialog displays, click **OK**.
The WD My Cloud device reboots.

Notifications

The WD My Cloud device provides notifications about various events, including whether a firmware update is available, a firmware installation was successful, capacity was exceeded, and so on. The notification may concern system conditions, such as over temperature, or hard drive, volume, and network status. Notifications display in a pop-up panel and are available by email, depending on how your device is configured. Notifications are categorized according to severity:

- **Critical:** Problems that need to be addressed immediately.
- **Warning:** Problems that you need to be aware of; however, they are not as severe as critical ones.
- **Info:** Informative details.

The Notification Emails section of the page enables you to set up email addresses for up to five users who will receive notifications. These alerts help the administrator manage and detect events or errors.

As an administrator, you can configure:

- Event categories you want to be notified of by email
 - Event categories you want to display in the web interface
1. In the Navigation bar, click **Settings** and then click **Notifications** in the left panel.

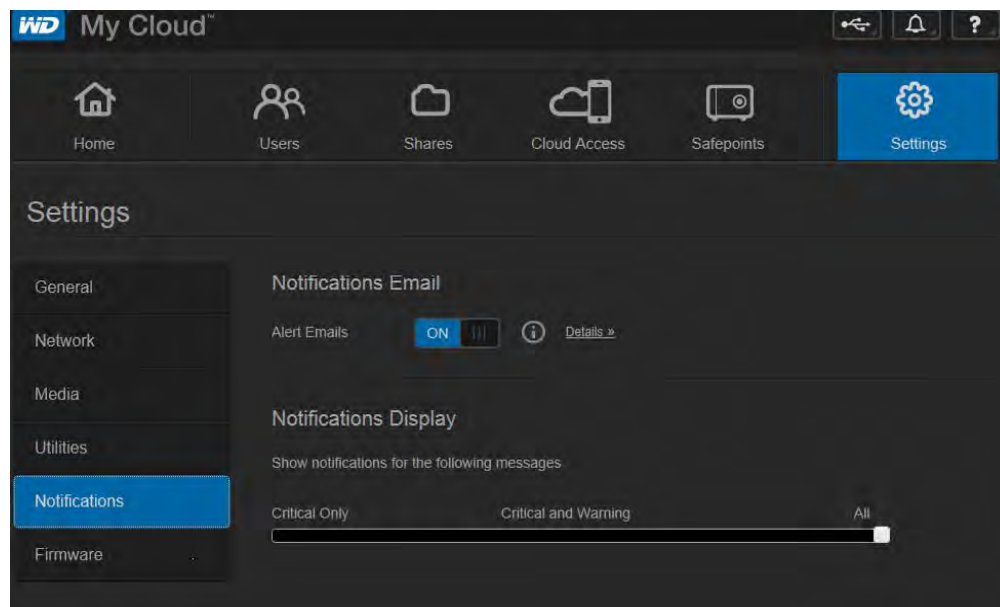

To configure notifications by email:

You can send notifications to up to five recipients.

1. In the Notifications Email section, toggle **Alert Emails** to **ON**. The Notifications Configuration dialog box displays.

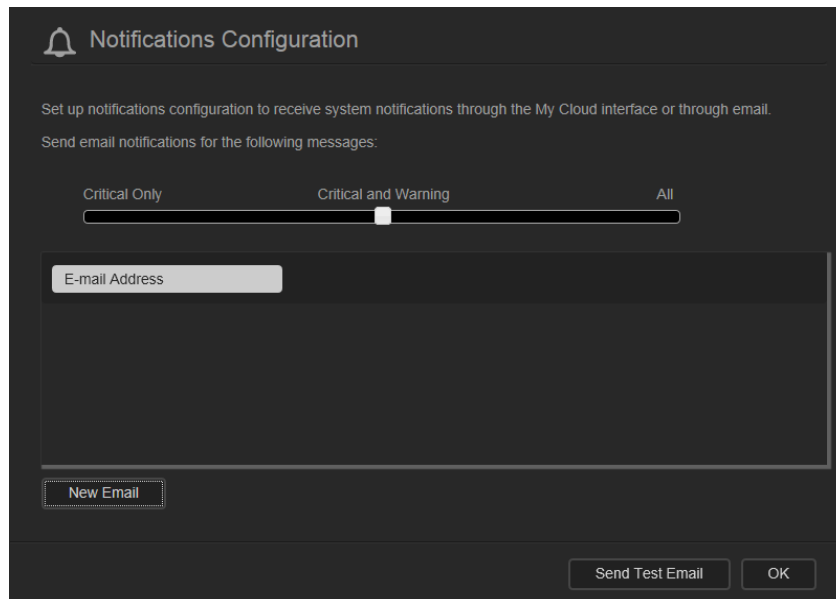

2. Move the slider to choose the severity of notifications to email.
3. Click **New Email**.
4. Enter the email address of a recipient, and then click one of the following:
 - **Save**
 - **Send Test Email**
5. (Optional) Add up to five email addresses by repeating steps 3 and 4 as needed.
6. (Optional) To delete an email address, click the trash can icon to its right.
7. Click **OK**.

To configure the severity of notifications that display in the web interface:

1. In the Notifications Display section, move the slider to choose the severity of notifications to display.
2. Click **OK**.

Firmware

The Firmware page enables you to set up the device to update the WD My Cloud firmware automatically or to manually check for an update file. The current version number and the date of last update of the WD My Cloud firmware display.

1. On the Navigation bar, click **Settings**, and then click **Firmware** on the left panel.

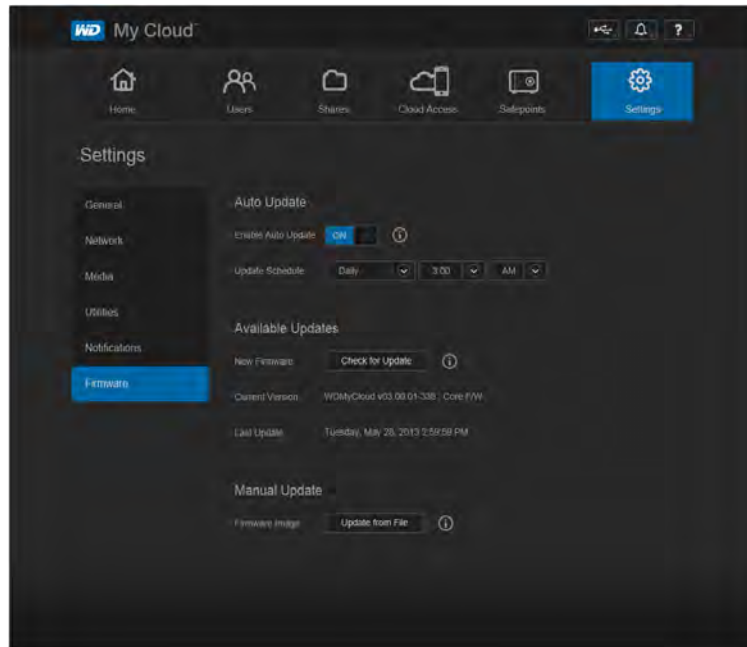

Auto Update

You can schedule the WD My Cloud device to conveniently check for available software updates and install them automatically. This is the easiest way of ensuring the WD My Cloud firmware is current.

Note: After a firmware update installs, the WD My Cloud device reboots. Since a reboot will affect users' ability to access the cloud, you should schedule the updates to occur at times when the likelihood of users accessing the cloud are minimal.

To update WD My Cloud firmware automatically:

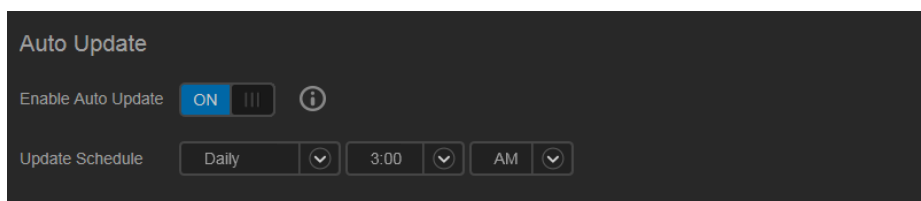

1. Toggle **Enable Auto Update** to **ON**.
2. From the drop-down lists, specify the frequency (e.g., daily) and time at which the device should look for an update on the WD website, and if one is available, to automatically install it and reboot.
3. Click **Save**.

Manually Checking for Updates

1. In the Available Updates section, click **Check for Update**. (The button will be labeled **Update Now** if new firmware is found.)

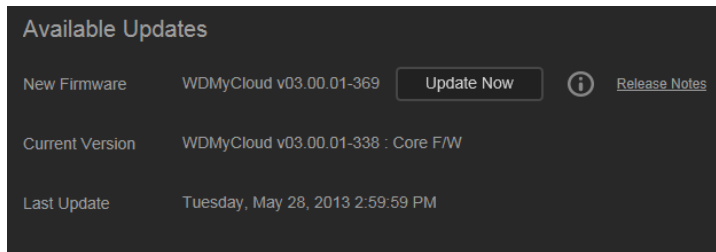

A message lets you know whether new firmware is available. If it is not available, click **OK**. If new firmware is available, click **Install and Reboot**.

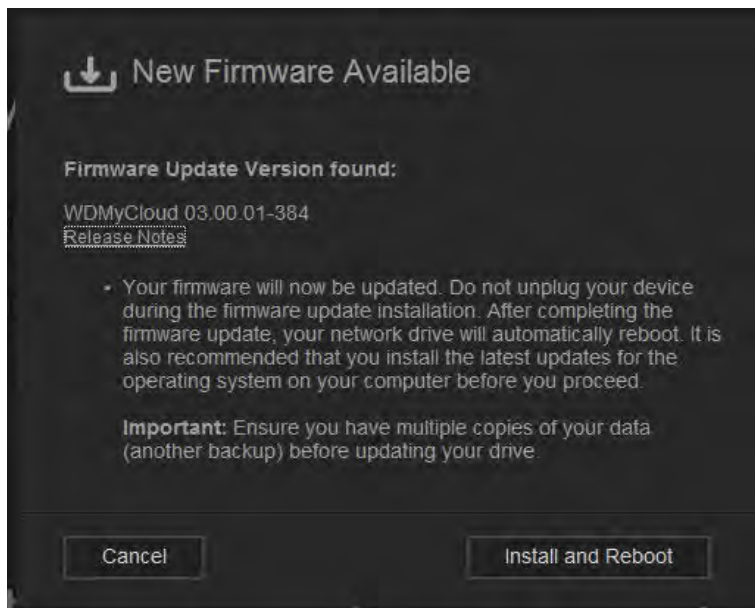

Manually Installing an Update

1. Go to the WD Tech Support Downloads page at <http://support.wd.com/product/download.asp>.
2. If a later version of WD My Cloud firmware than your current version is available, select the WD My Cloud and click the **Current Firmware** link to go to the product update page.
3. Click the **Download** button.
4. Download the firmware file and save it to your desktop.
5. Unzip the zip file to access the .deb file.
6. If not already on the Firmware page, on the dashboard Navigation bar, click **Settings**, and then click **Firmware** on the left panel.

7. In the Manual Update section of the Firmware page, click **Update from File**.

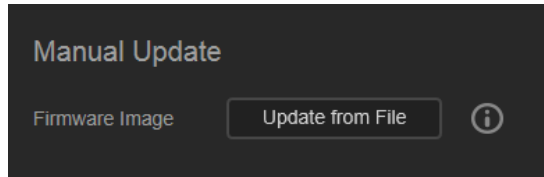

8. Select the .deb file and click **Open**.
A message prompts for confirmation that you want to update now.
9. Click **Install and Reboot**. A progress bar displays. When the process is complete, the WD My Cloud device reboots.

11

Managing Safepoints

- [About Safepoints](#)
- [Creating a Safepoint](#)
- [Updating a Safepoint](#)
- [Recovering a Safepoint](#)
- [Deleting a Safepoint](#)

About Safepoints

You can create a complete backup or snapshot of your WD My Cloud device, called a safepoint, and save it to an external location on your home network or an attached USB drive attached to the USB expansion port. Safepoints can be created or run on a schedule you define. They include a record of users, data, and shares on your device; any backups created using WD SmartWare, Apple Time Machine, Windows 7 Backup, or Windows 8 File History, and any associated device configuration details. Creating a safepoint ensures that you can easily recover your data from a specific point in time to a new WD My Cloud device in the unlikely event that your WD My Cloud device fails.

Creating a Safepoint

To create a safepoint for your WD My Cloud device:

1. On the navigation bar, click **Safepoints** to display the Protect Your Stuff page:

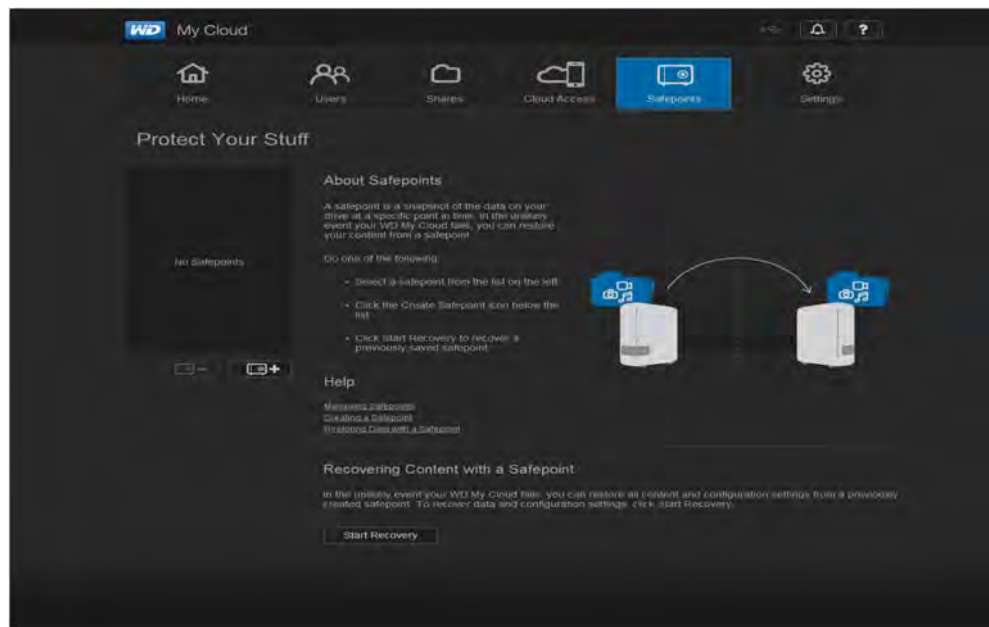

Note: The first time you open this page, in addition to a list of existing safepoints, you'll see information and links to Help pages about safepoints.

2. Click the Add a Safepoint icon  to display the Create a Safepoint screen:

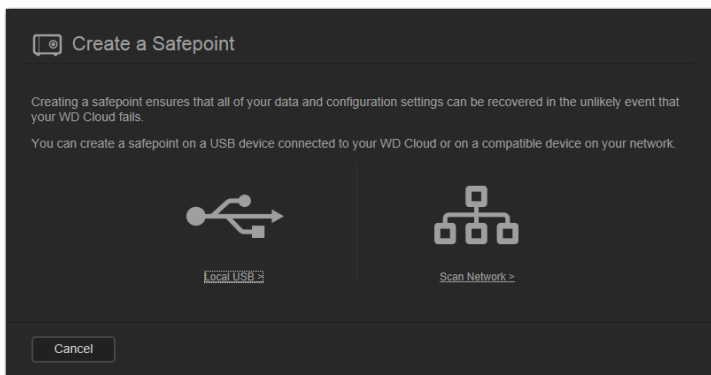

3. Click either **Local USB** or **Scan Network** to display a list of available devices on your local USB drive or network:

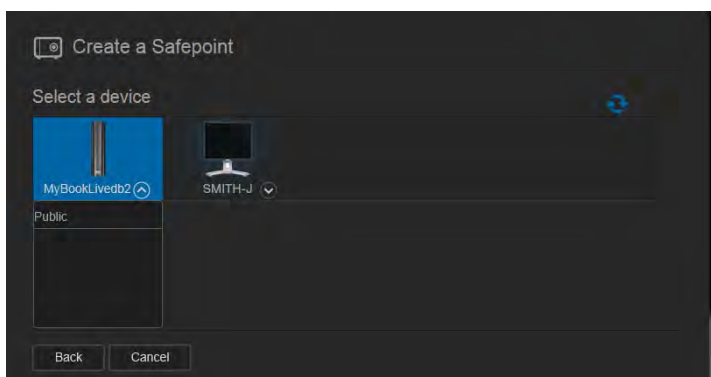

Network

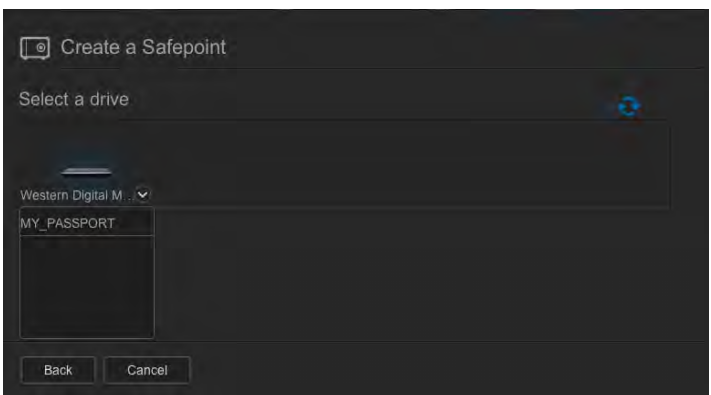

Local Scan

Note: To rescan the network at any time, click the blue refresh/rediscover icon  in the upper right.

Important: If you create a safepoint with shares you wish to keep private, create the safepoint on a private share.

- Select the target device and the share for the operation and click **Next**. If the share is password protected, enter appropriate credentials.

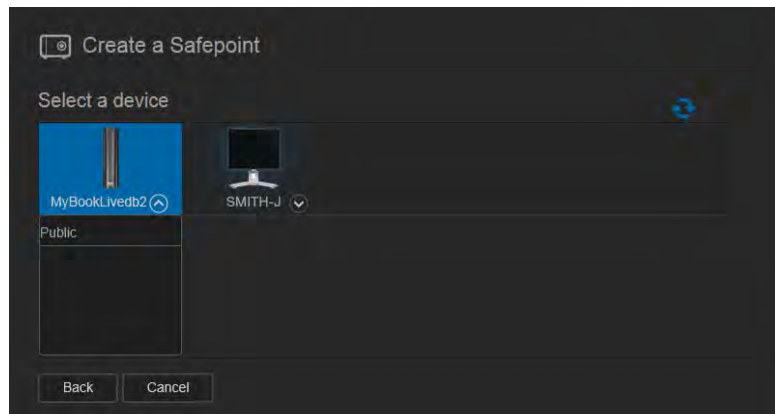

Important: If you create a safepoint with shares you wish to keep private, create the safepoint on a private share.

The Create a Safepoint dialog box displays.

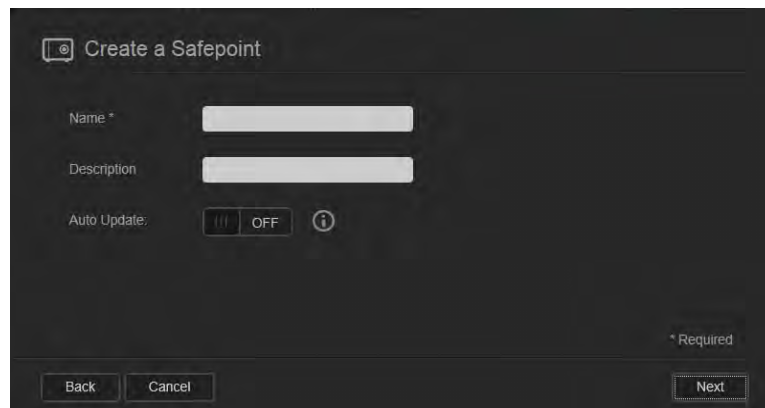

- Enter a name and description for the safepoint.

Note: The name must include 1-32 characters and cannot contain spaces or symbols except underscores. It is case sensitive.

Auto updates help keep your safepoint up to date with the content on your WD My Cloud device by copying changes since the last update. If you want the new safepoint to be updated automatically:

- Turn **Auto Update** on.
- Indicate the **Frequency, Day, and Time** to automatically update the safepoint.

Note: You may choose to enable auto updates at another time. See “Updating a Safepoint” on page 98).

- Click **Next**. The Create now or later dialog box displays:

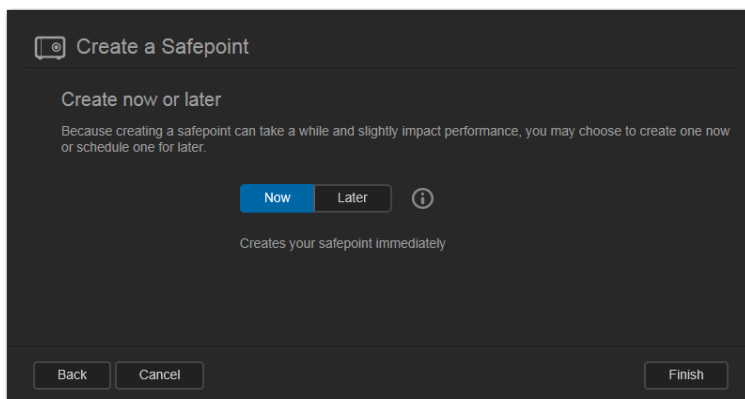

7. You have two options:

- Create Now:** To create a safepoint on the share immediately, click **Now**, and then click **Finish**. A progress message and the safepoint profile display:

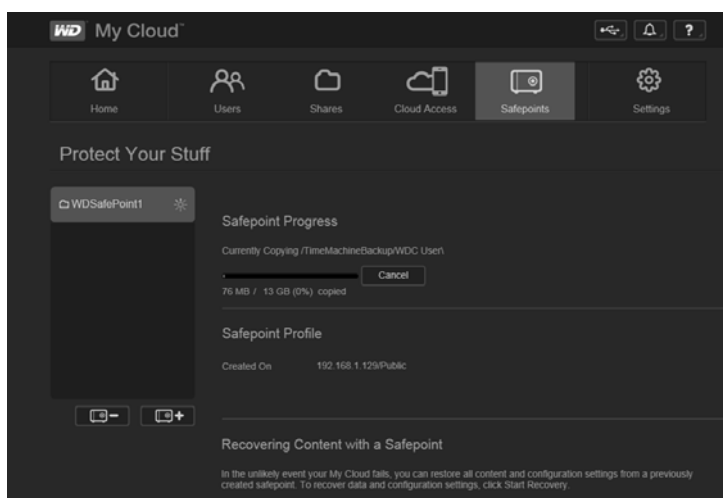

Note: The time it takes to create a safepoint varies based on the speed of your network and the number and size of files you have stored on your WD My Cloud device. For a given amount of total data, fewer larger files replicate quicker than many smaller files. Other factors such as what processes are running on the WD My Cloud device and on the speed and availability of your target have an effect on how long it takes.

- **Create Later:** If you want to schedule the creation of the safepoint, click **Later** and enter a date and time you want the safepoint to be created.

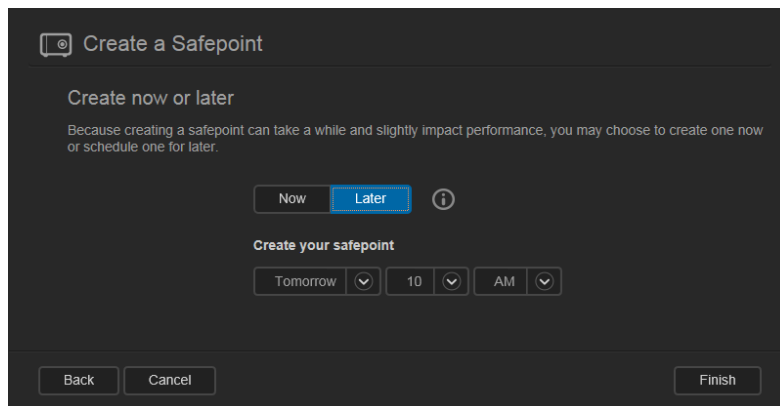

Important: Changes made while safepoint operations are in progress are not guaranteed to be backed up immediately.

Note: If the creation process was not successful or was interrupted, click the safepoint's retry icon  to resume the operation.

The safepoint profile and schedule display.

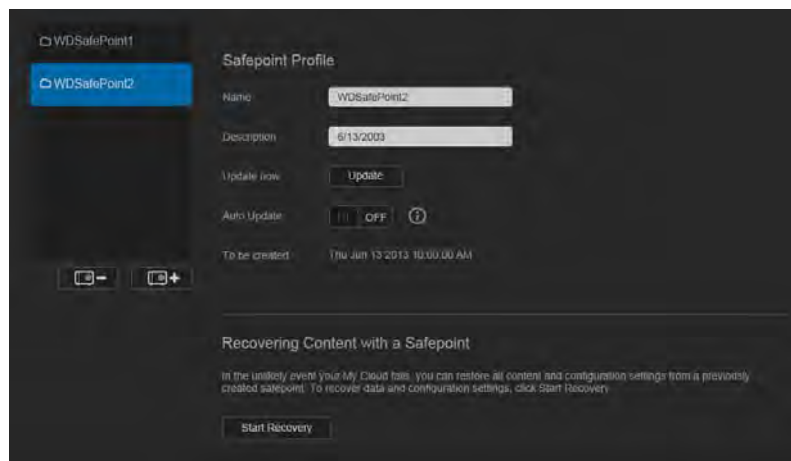

Note: To see the content of the safepoint stored on another device, access the folder on the device where you stored it. The path is `/sharename/_WDPROT/WDSAFE/name of safepoint created`.

Updating a Safepoint

There are two ways to update a safepoint:

- Automatically - you set the frequency, date, and time when the update occurs
- Manually

To update a safepoint automatically:

1. On the Navigation bar, click **Safepoints** to display the Protect Your Stuff page.
2. In the left pane, select the safepoint you want to update.
3. Turn on **Auto Update** to display the Safepoint Update Schedule dialog box.

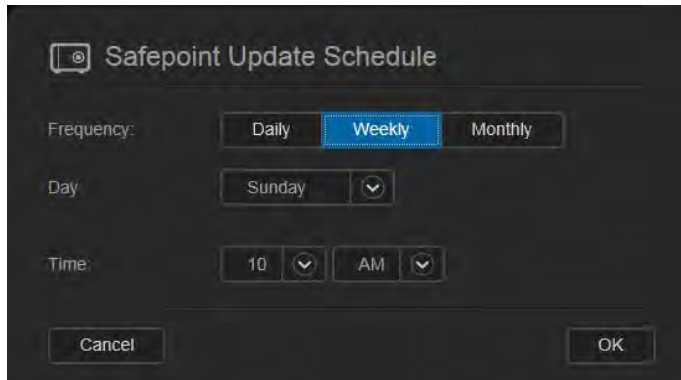

4. Indicate the **Frequency, Day, and Time** to automatically update the safepoint, and then click **OK**.

To update a safepoint manually now:

1. On the Navigation bar, click **Safepoints** to display the Protect Your Stuff page.
2. In the left pane, select the safepoint you want to update.
3. Click **Update**. A progress bar displays.
4. In the Safepoint Update Schedule dialog box, make your changes to the safepoint (**Frequency, Date, and Time**), and then click **OK**.

The progress bar in the status area displays detailed information about the operation, such as the files being copied and the extent completed.

Important: Changes made to data while safepoint operations are in progress are not guaranteed to be backed up immediately.

Recovering a Safepoint

The Recover section enables you to restore your data from a safepoint to a factory-fresh WD My Cloud device.

Important: Make sure the replacement WD My Cloud device is new or is in factory fresh state. (See “System Factory Restore” on page 84.) The capacity of the replacement device must be the same or larger than the safepoint you created.

1. Open the dashboard of a factory fresh unit.
2. On the Navigation bar, click **Safepoints** to display the Protect Your Stuff page.

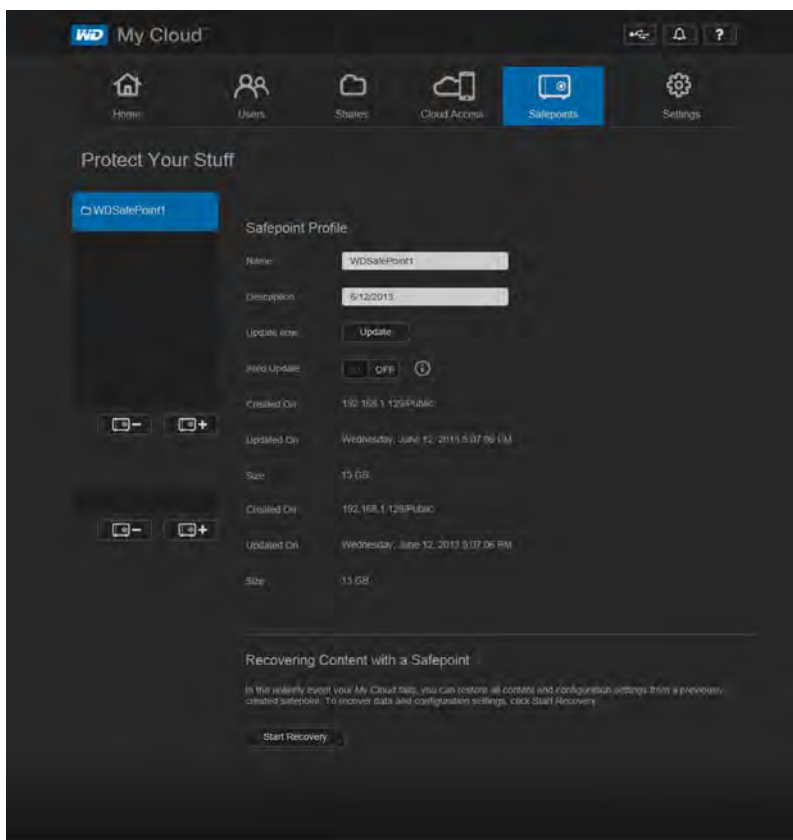

3. Click **Start Recovery** at the bottom of the page to display the Recover Content with a Safepoint dialog box:



4. Click **Network** or **Local** (for USB devices) to display a list of available devices on your network:

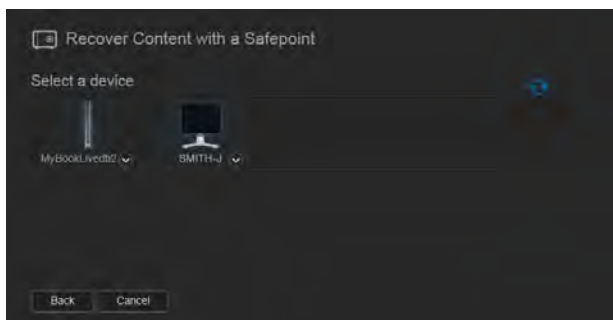

5. Select a device to display the list of its available shares:

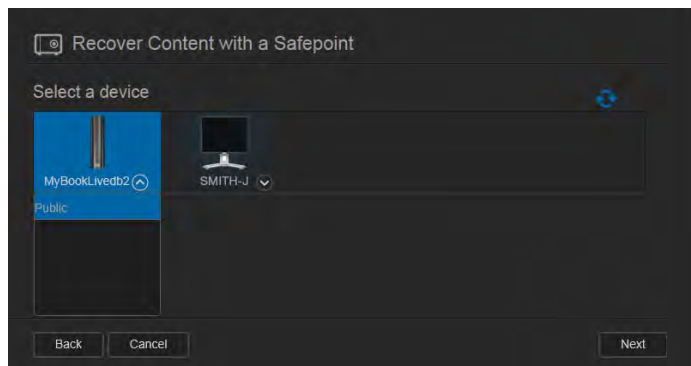

6. Select the share that has the safepoint and click the **Next** button. If the share is password protected, enter appropriate credentials:

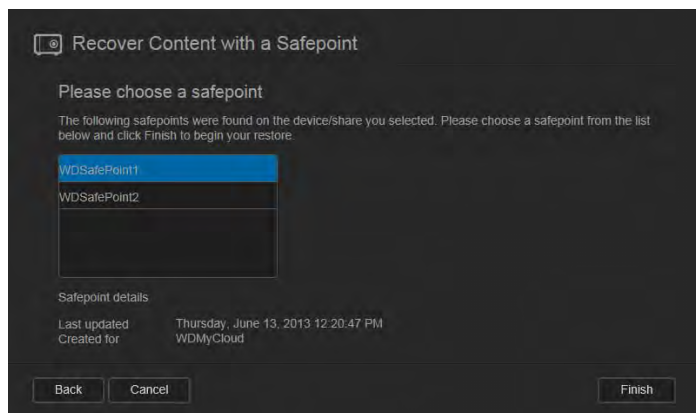

7. Choose the safepoint you want to recover and click **Recover**:
If the device you are restoring to is not in a factory restored state, a message with instructions appears. (See "Utilities" on page 83.)
8. If there are no errors, the recovery operation begins and a progress bar appears. Wait for the operation to finish. Your device restarts after the recovery operation and then can be used in place of your original WD My Cloud device.

Deleting a Safepoint

1. On the navigation bar, select **Safepoints** to display the Protect Your Stuff page.
2. To delete a safepoint and all of its contents, select the safepoint and click the delete safepoint icon .
3. In response to the confirmation question, click **OK**.

Note: The path /sharename/_WDPROT/WDSAFE path remains where you stored your safepoint, but the name of the file is no longer at the end.

Playing/Streaming Videos, Photos, & Music

[Media Servers](#)

[Media Storage](#)

[Enabling/Disabling DLNA and iTunes](#)

[Accessing Your Personal Cloud Using Media Players](#)

[Accessing Your Personal Cloud Using iTunes](#)

Media Servers

The WD My Cloud Personal Cloud Storage device is designed to serve as your home's media server. It enables you to stream photos, music, and videos to your DLNA-compatible devices and music to your iTunes-compatible devices.

Both DLNA-compatible and iTunes-compatible devices search for media stored in any public or private share that has media serving enabled. When the WD My Cloud device is new, only the Public share defaults to DLNA on. WD SmartWare, Time Machine, and new shares default to DLNA off.

If you do not want DLNA to display specific media files, place them in a private share that is set to disable media sharing. (See "Making a Share Private" on page 57.) Both the DLNA and iTunes servers are pre-set, so you can just transfer your multimedia content to the Public share on your WD My Cloud device, and you are ready to stream and view content on your home entertainment center, game consoles (for example, Xbox 360 or PlayStation 3), WD TV Live HD media player, DLNA 1.5 Digital Media players, and other PCs on your home network. Visit <http://www.dlna.org> for further information on DLNA.

TwonkyMedia Overview

The WD My Cloud device uses TwonkyMedia as its DLNA media server. It streams your music, photos and videos to compatible devices in your home. Playing media on a compatible device is easy.



The TwonkyMedia server searches for all the media stored in the Public share on the WD My Cloud device connected to your home network. The server is pre-set, so you can just transfer your multimedia content to the Public share on your WD My Cloud device, and you are ready to stream and view content on your home entertainment center, game consoles (for example, Xbox 360 or PlayStation 3), WD TV HD Live media player, or DLNA 1.5 Digital Media Adapters), and other PCs on your home network. Visit <http://www.twonkymedia.com> for further information about TwonkyMedia.

iTunes Overview

You or anyone connected to the WD My Cloud device can use iTunes to play stored music files. iTunes creates a virtual music library on the device and treats it as an iTunes repository, making it possible to stream music files from the WD My Cloud device to Windows or Mac computers running iTunes.

iTunes scans any shares that have the Media Serving setting enabled, including the Public share by default.

Media Types Supported by DLNA

 Audio Files	 Video Files	 Image Files
3GP	3GP	BMP
AAC	AVI	GIF
AC3	DivX	JPEG
AIF	DVR-MS	PNG
ASF	FLV	TIF
FLAC	M1V	TIFF
LPCM	M4V	
M4A	MKV	
M4B	MOV	
MP1	MP1	
MP2	MP4	
MP3	MPE	
MP4	MTS	
MPA	MPV	
OGG	MPG	
WAV	MPEG2	
WMA	SPTS	
	VDR	
	VOB	
	WMV	
	Xvid	

Note: Some devices may not support playback of all these files. Please refer to your device's user manual to see which formats are supported.

Media Types Supported by iTunes

Note: iTunes 10.4 or later only supports music files. See Knowledge Base Answer ID 8412 for additional information on iTunes supported versions.

The iTunes Media Server supports the following file extensions: FLAC, M4A, MP3, MP4A and WAV.

Note: Some devices may not support playback of all these files. Please refer to your device's user manual to see which formats are supported.

Media Storage

You can access and store media content on the WD My Cloud device by means of network shares. Shares, similar to folders or directories, are areas set up to organize media and access them from your network. Shares can be shared with everyone (public) or with selected users on your network (private).

The device comes pre-configured with the Public network share, which contains the following subfolders for media storage:

- **Shared Music**—Stores music files you want to share with other users
- **Shared Pictures**—Stores image files you want to share with other users
- **Shared Videos**—Stores video files you want to share with other users

These folders are for your convenience; you can put any supported media file in any share.

Note: You will notice that the Public share's Shared Music and Shared Pictures shares contain mirrored and uploaded subfolders. These folders are needed by Twonky 7.2. You can now upload all media types to the uploaded subfolder from a DLNA client with "upload" capability. Go to the Twonky configuration site (NAS_IP:9000) to aggregate content from all NAS devices with DLNA capability on your network to the mirrored folder. Uploading and mirroring are best left to expert users, as these features are not supported by WD customer support.

Enabling/Disabling DLNA and iTunes

The Media page on the WD My Cloud dashboard allows you to enable or disable the DLNA and iTunes media servers. Media server utilities for re-scanning the NAS or fully rebuilding the DLNA database are also on the Media page.

1. On the Navigation bar, click **Settings** and then click **Media** in the left panel.

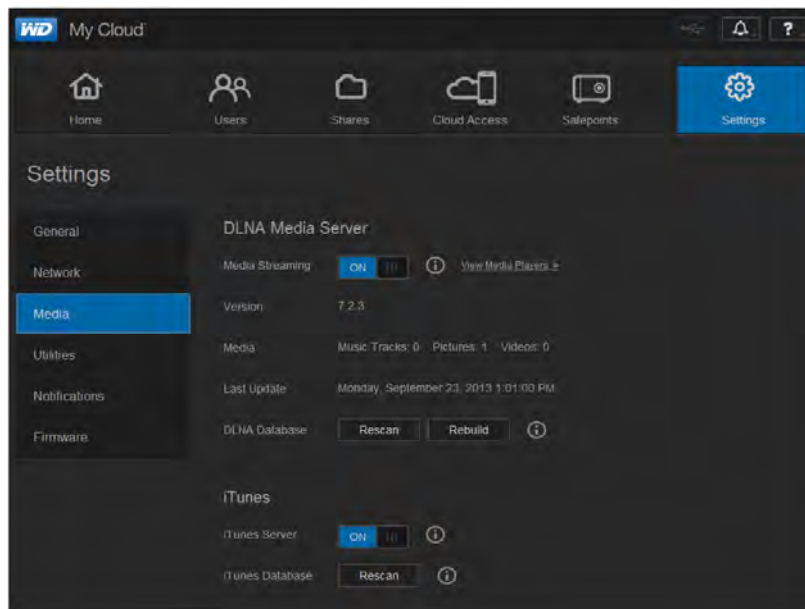

To view all players on the LAN and enable or disable streaming to them:

1. **Media Streaming** is **ON** for all shares by default. To disable streaming to all shares, switch it to **OFF**.

You can view the status information, including the version of the DLNA software, the date and time your settings were updated, and the number of music tracks, pictures, and videos that were streamed.

- To view a list of your media players/receivers on your home network, click the **View Media Players** link. The Media Streaming Options dialog box displays.

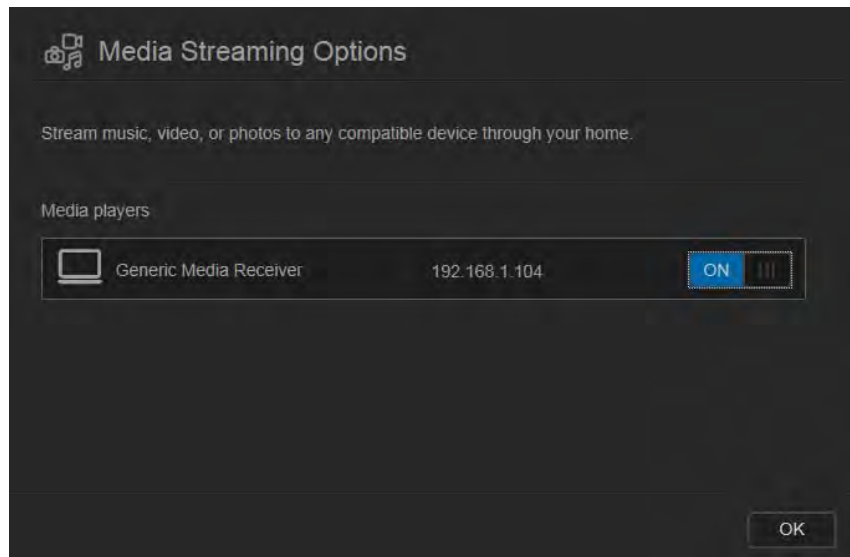

- To block or unblock access for a DLNA device on the Media Streaming Options dialog box, find the device whose access you want to change and toggle the switch as appropriate:
 - ON:** Allows access (default)
 - OFF:** Denies access
- Click **OK** to return to the Media page.
- If you encounter a mismatch in the amount of WD My Cloud content accessible or viewable by a DLNA device, you can click one of the following:

Note: Re-scanning and rebuilding take place automatically. You only need to use the buttons if you are having a problem. Only the file types listed on page page 101 are supported and will be counted.

Important: Use caution when completing this procedure. Rebuilding the DLNA server database could take a considerable amount of time, depending on the number and size of the files involved.

- Rescan:** The WD My Cloud device searches for changes made to your media libraries. Try this first.
- Rebuild:** The WD My Cloud device rebuilds the DLNA database from scratch.

To enable or disable iTunes:

- To enable iTunes to access your music files through your iTunes player, click the **iTunes Server** toggle switch as appropriate:
 - ON:** Allows access (default setting)
 - OFF:** Denies access
- Click **Rescan** to update your media files. When the “iTunes rescan has been initiated” message displays, click **OK**.

Adding Media Content to the Folders

1. Open **Windows Explorer** or **Mac Finder**:

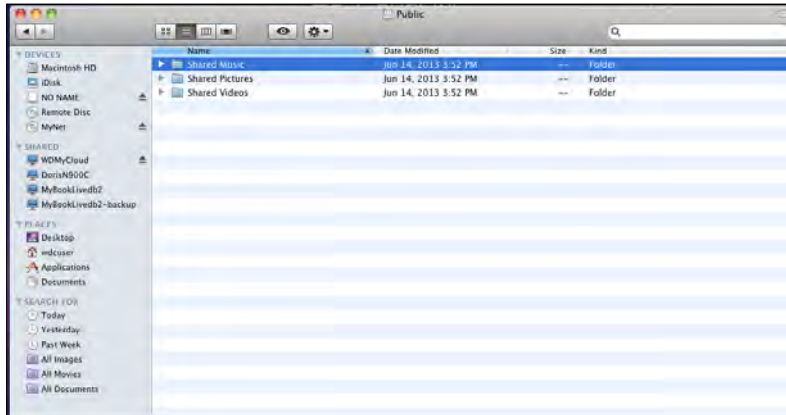

2. Copy your music files to the Shared Music folder.
3. Follow the same process to place your videos and pictures into their respective Pictures and Video folders.

Note: You can put media files in any public and private shares to which you have access.

Accessing Your Personal Cloud Using Media Players

Now that you have copied your files to one of the Shared folders, you can use a variety of DLNA-compatible media players to stream media. The following types are supported:

- Windows Media Player 11 (comes with Windows Vista)
- Windows Media Player 12 (comes with Windows 7 and Windows 8)
- WD TV Live/Live Plus HD Media Players
- Xbox 360
- PlayStation 3
- Other DLNA-compatible media players:
 - Blu Ray players
 - Network-connected TVs
 - Digital picture frames
 - Network music player

Note: For specific information on using and updating the media player, go to the appropriate support site.

WD Media Players

You can connect the various WD Media Players to your home network for access to media content stored in a network drive such as the WD My Cloud device. For details on using a WD Media Player to access files on your WD My Cloud device, see Knowledge Base Answer ID 2676 or refer to your WD Media Player User Guide.

Other Media Players

Following are general steps for setting up devices such as digital picture frames, Blu Ray players, network connected TVs, and digital media adapters:

1. Make sure that your WD My Cloud device is connected to your home's local network and is powered on.
2. Follow the user instructions provided with your media player to proceed through any initial setup or installation of drivers.
3. Using the navigation feature on your player, scan and detect your WD My Cloud device on your network.
4. Depending on the player you have, you may need to access a Settings/Network Setup page in the user interface to establish connection so that your player can link to your WD My Cloud device. Please refer to your player's user guide for specific instructions.

DLNA Devices

See specific DLNA media device user manuals for instructions on connecting a DLNA device to your local area network so you can access content on the WD My Cloud device. Go to <http://www.dlna.org> for a list of DLNA-certified devices and for further information.

Accessing Your Personal Cloud Using iTunes

Streaming Media in iTunes

iTunes is enabled by default in the dashboard. See "Media" on page 82 for more information.

1. Launch iTunes on your computer.
2. Click **WDMYCloud** under the Shared section of the left pane. If you have copied music to the /Public/Shared Music folder or a video to /Public/Shared Videos, and it is in a format supported by iTunes, it should be listed in the right pane.

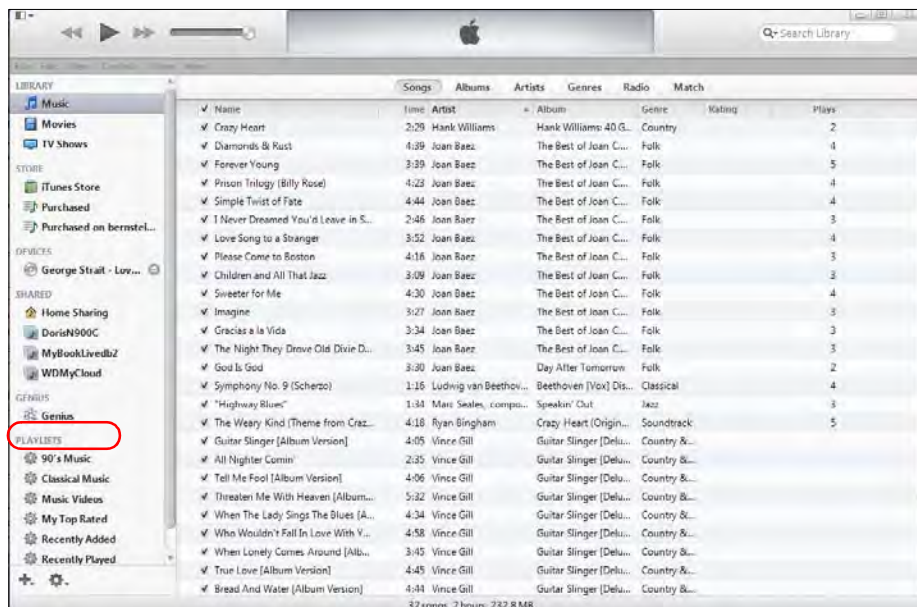

3. Double-click a media file to play it.

13

Connecting a USB Hard Drive

[Overview](#)

[Connecting A USB Drive](#)

[Mapping A USB Drive \(Windows Only\)](#)

[Creating a Shortcut to the USB Drive \(Windows only\)](#)

Overview

When you attach a USB drive to the WD My Cloud device's USB 3.0 expansion port, it becomes a network drive. Now the USB drive has the following capabilities:

- When you connect an external USB drive such as a WD Passport, a memory stick, or a camera to the WD My Cloud device, you can access it with Windows Explorer or Mac Finder.
- The USB drive can serve as a target for backups in WD SmartWare, Windows, or Time Machine.
- You can map the drive as a user share drive (Windows) or an alias (Mac).
- If a WD external drive has been locked, when it is attached to the WD My Cloud device, it maintains that security and can be unlocked or relocked using the Dashboard.
- You can attach a powered USB hub to the external USB port and attach up to seven USB devices to the hub.

Connecting A USB Drive

Connect a USB hard drive to the USB port on the rear of your WD My Cloud device for additional storage. The USB drive appears as a share on the WD My Cloud dashboard. (See "Managing Shares" on page 55.)

The WD My Cloud device supports the following formats for externally attached USB drives:

- FAT32
- NTFS (read and write capability)
- HFS+J
- Linux Ext2, Ext3/Ext4
- XFS

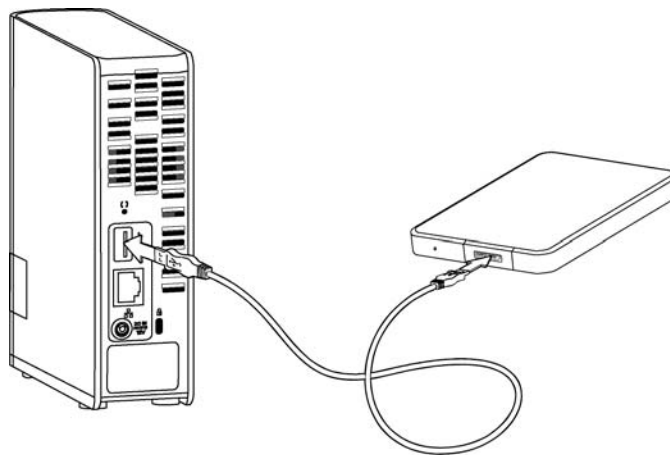

Mapping A USB Drive (Windows Only)

1. Right- or left-click the WD Quick View icon  in the system tray to display a menu.
2. Move the pointer over or click to select your USB drive and display a submenu:

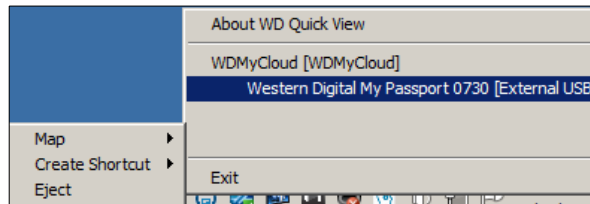

3. Select **Map** [USB name] on the WD Quick View submenu. The Map Network Drive dialog box displays:

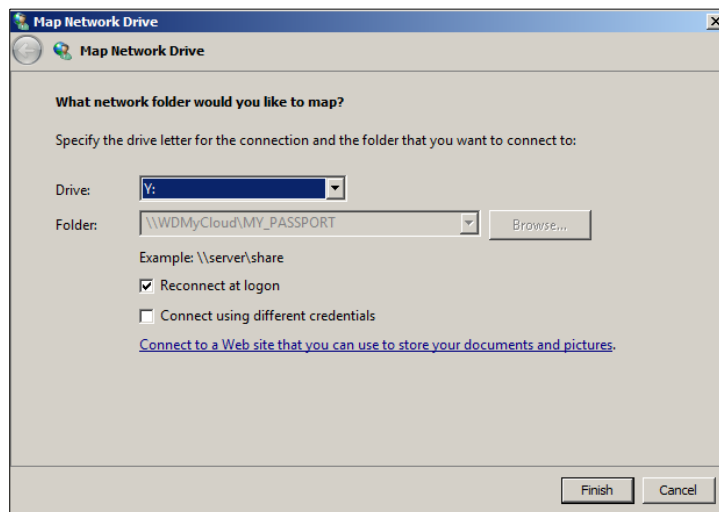

4. Select the desired letter from the **Drive** drop-down list.
5. Click the **Finish** button.

Note: When Windows attempts to reconnect a Mapped Network Drive after a restart, the “Unable to reconnect mapped network drives” error may appear. This can occur if the username and password of the WD My Cloud drive do not match the current Window's username and password information.

During the automatic reconnection process, Windows may attempt to send the current Windows username and password instead of the WD My Cloud device username and password specified during setup. Attempting to open the mapped network drive prompts a new login window. Enter the WD My Cloud device username and password to reconnect the share, allowing it to be accessible again (until the next reboot). For more information on this problem, see Knowledge Base Answer ID 6745.

Creating a Shortcut to the USB Drive (Windows only)

Select **Create Shortcut** on the WD Quick View submenu for your USB Drive. An icon representing the USB drive displays on the desktop.

Appendix A: Specifications

Ethernet	High performance (100/1000) Gigabit Ethernet connection
Internal hard drive	WD 3.5-inch SATA hard drive
Supported protocols	CIFS/SMB, NFS, FTP, AFP
I/O ports Data transfer rate	Gigabit Ethernet (RJ-45) port USB 3.0 up to 5 Gb/s USB 2.0 up to 480 Mb/s <i>*A USB 3.0 host and USB 3.0 certified cable are required to obtain USB 3.0 performance.</i>
Compatibility <i>Note: Compatibility may vary depending on user's hardware configuration and operating system.</i>	Operating systems: <ul style="list-style-type: none"> • Windows 8.1 and earlier • Windows 7 • Windows Vista • Windows XP (SP3)* • Mac OS X Mavericks • Mac OS X Mountain Lion • Mac OS X Lion • Mac OS X Snow Leopard Browsers: <ul style="list-style-type: none"> • Internet Explorer 8.0 and later on supported Windows computers • Safari 5.0 and later on supported Mac computers • Firefox 12 and later on supported Windows and Mac computers • Google Chrome 14 and later on supported Windows and Mac computers DLNA®/UPnP® devices for streaming Internet connection
Physical dimensions	
Width	1.9 in (49 mm)
Length	5.5 in (139.3 mm)
Height	6.7 in (170.6 mm)
Weight	2 TB 2.11 lb (0.96 kg) 3 TB 2.11 lb (0.96 kg) 4 TB 2.25 lb (1.02 kg)
Power supply	Input voltage: 100V to 240V AC Input frequency: 50 to 60 Hz Output voltage: 12V DC, 1.5A Power supply: 18W
Temperature	Operating temperature: 5°C to 35°C (41°F to 95 °F) Non-operating temperature: -20°C to 65°C (-4°F to 149 °F)
RoHs compliant	Yes

Appendix B: Troubleshooting

[First Steps Checklist](#)

[Resetting the WD My Cloud Device](#)

[Specific Problems and Corrective Actions](#)

First Steps Checklist

- Are all cables correctly connected and secured?
- Is the WD provided power adapter plugged directly into a wall outlet and the device?
 - This helps rule out power issues if the wrong adapter is used.
 - If a surge protector or extension cord is being used, please plug the device's power cord directly into a wall outlet.
- Is the status indicator solid blue? If not, see "Resetting the WD My Cloud Device," below.
- For any issue related to function, first ensure that you are using the latest firmware for the WD My Cloud device. See "Firmware" on page 89 for update instructions.

Resetting the WD My Cloud Device

Resetting with Power On

If you have set a password or a static IP address on the WD My Cloud dashboard and have forgotten it, pressing the reset button while the device is powered up resets the password to the default value of none and to default IP settings. The default IP setting is DHCP. Resetting does not erase your files.

Follow the instructions below to reset the device using the reset button:

WARNING! Do not move the unit while it is turned on. If you do not have access to the back of the unit, unplug the device from the power source, turn the device around so you do have access, and then plug the device in again.

1. With the device powered on, insert a paper clip or narrow-tipped pen into the reset button slot on the back of the unit:
2. Press and hold down the reset button for four seconds. The device reboots (this may take up to three minutes).

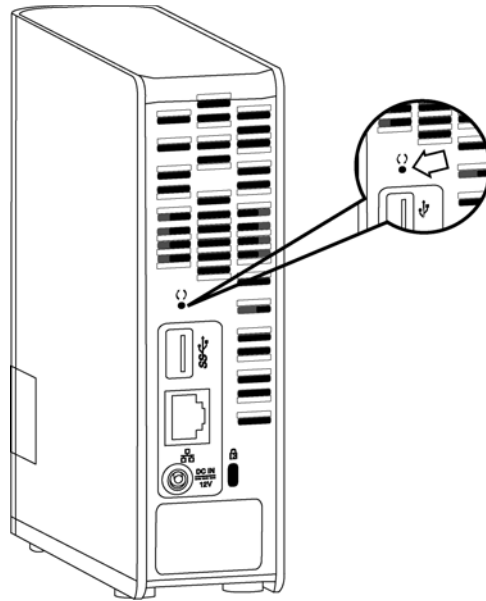

Resetting with Power Off

At the same time as you plug power into the WD My Cloud device, press the **Reset** button and hold for about 40 seconds. The device undergoes a system restore and powers on.

Specific Problems and Corrective Actions

The following contains specific problems that may arise during the use of the WD My Cloud device. Possible solutions are listed for each problem.

LEDs do not light up.

- Make sure the power cord is connected correctly.
- Make sure that the wall outlet has power. Test it by plugging in another device.

The WD My Cloud Device's front panel light is yellow and the unit's Network Adapter LEDs do not light.

1. Confirm the network cable is properly connected to the WD My Cloud Personal Cloud Storage device and the network switch or router.
2. Make sure the network switch or router has power.
3. Use a different network cable and port on the network switch or router. Temporarily swapping the WD My Cloud device's cable port with a working network device may identify any failing cables and ports.

My router has failed. How do you manually map the drive letter?

1. Power down the device.
2. Connect the device directly to the computer's Ethernet port.
3. Power up the device. Wait until the LED turns blue before proceeding.
4. For Windows XP and Windows 7, on the Start menu:
 - a. Click **(My) Computer**.
 - b. Click **My Network Places** (Windows XP) or **Network** (Windows Vista/Windows 7).

- c. Select **wdmycloud**.
- d. On the Tools menu, click **Map Network Drive**.
5. For Windows 8:
 - a. Click the **File Explorer** icon , and in the ribbon (top of page), click **Computer > Map Network Drive**.
6. Select **wdmycloud**.
7. Leave the drive set to the default letter.
8. In the **Folder** box, type the following path: **\\device name\public**.

Note: The default device name is WDMYCloud.

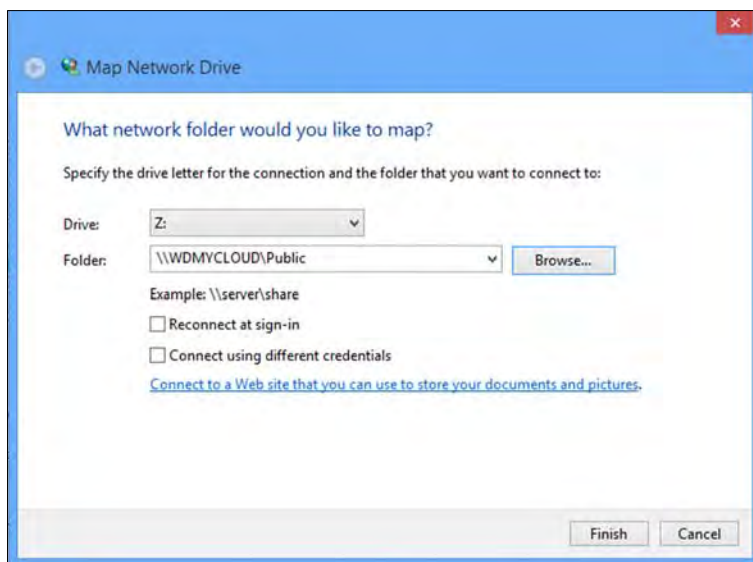

9. Click **Finish**.
10. Go back to the opening window of (My) Computer to view the Public folder of your device under Network Drives.

Setup or WD SmartWare is unable to detect a WD My Cloud device.

If Setup or WD SmartWare is unable to detect a WD My Cloud device, then certain network protocols may be blocked on the network or the computer. In those cases, the WD My Cloud device is available through a direct IP or network name connection. For example, you can open the WD My Cloud dashboard using `http://<device IP address>/` or `http://wdmycloud/`.

- If the computer is on a wireless network, connect using an Ethernet cable and try again.
- Temporarily disable any computer firewalls or security software and retry.
- Check your local router for any firewalls or security software. If present, please check your router documentation on temporarily disabling the software or configuring the software to allow UPnP or UDP traffic.

Important: Disabling your firewalls or security software may leave you vulnerable to security threats on your computer. Remember to restore your firewall/security settings after you perform the above steps.

I am unable to play music, videos and/or view pictures through my digital media adapter.

- There are many kinds of file formats for pictures, videos and music; your particular digital media adapter may not support a format to play or display it. Depending on the digital media adapter device that you have (for example, Xbox 360 or PlayStation 3), you may need to update your device to support the media format that you want to play. Refer to your digital media adapter's user manual for further information.
- Make sure the share containing your media content is enabled to serve that type of media. See "Creating a New Share" on page 56.
- Try re-encoding the media file.
- Test the media file on a PC/MAC running a different media server to help determine if the file is not corrupted, plays on a other media players, etc.

I am having trouble shutting down the WD My Cloud Device.

If you are unable to shut down the device using the WD My Cloud dashboard or the WD Quick View icon:

1. Double-check every computer on the network to ensure no files are open or transfers are in progress.
2. Check the following:
 - If the LED is solid blue (indicating the device is idle) or pulsing blue (indicating the device is on standby), the device is ready to shut down.
 - If the LED is white (may look somewhat violet), the firmware is being updated. **Do not allow power to be lost to your device as this could corrupt the firmware in the device and cause data loss.** Loss of power may also cause the device to become inaccessible.
 - If the LED is any other color, wait for it to turn blue. If it does not turn blue, consult "Checking the Front Panel LED" on page 10.
3. Disconnect the power cable (if steps 1-3 do not resolve the issue).
4. Wait 30 seconds.
5. Reconnect the Ethernet cable and power cord, and then power on the device.

I need to migrate a large amount of data (50 GB or more) from a USB external drive to my My Cloud device.

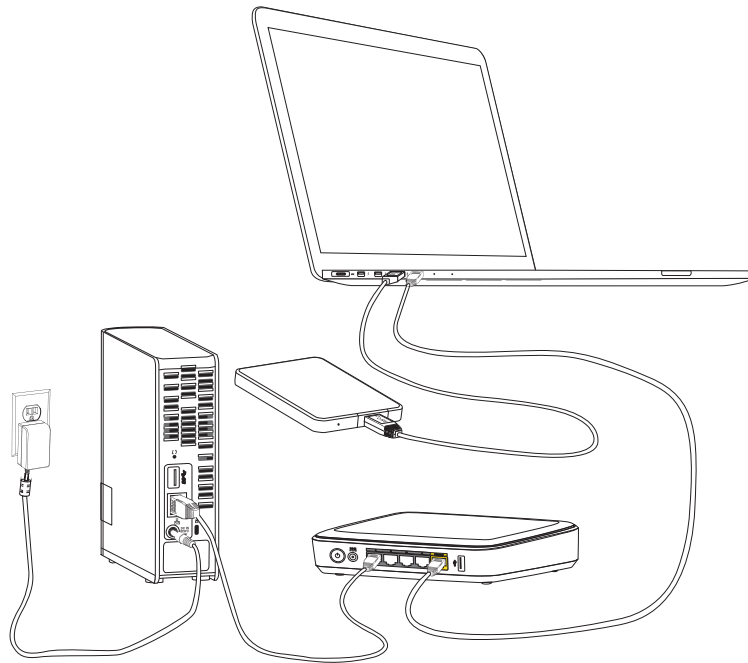

1. Connect the USB drive to your computer for optimal performance.
2. Connect your computer and the My Cloud device directly to your router with a wired Ethernet connection.
3. Copy your data from your external USB drive (or your computer) to your My Cloud device.

Network performance optimization guidelines for data migration:

- Data transfer over a wireless connection between your computer and the My Cloud device will generally result in slower data transfer performance.
- A wired connection between your computer and your router is recommended.
- Using a Gigabit router for optimum performance is recommended.
- For wireless data transfer, it is recommended that you move the wireless computer into the same room as your wireless router.
- Data transfer speeds through a wireless connection will be higher if your router and computer are connected using Wi-Fi 802.11n or 802.11ac

Appendix C: Regulatory and Warranty Information

[Regulatory Compliance](#)

[Warranty Information \(All Regions Except Australia/New Zealand\)](#)

[Warranty Information \(Australia/New Zealand only\)](#)

Regulatory Compliance

Federal Communications Commission (FCC) Class B Information

Operation of this device is subject to the following two conditions:

1. This device may not cause harmful interference.
2. This device must accept any interference received, including interference that may cause undesired operation.

Changes or modifications not expressly approved by the party responsible for compliance could void the user's authority to operate the equipment.

FCC Requirements, Part 15

This equipment has been tested and found to comply with the limits for a Class B digital device pursuant to Part 15 of the FCC Rules. These limits are designed to provide reasonable protection against harmful interference in a residential installation. This equipment generates, uses, and can radiate radio frequency energy and, if not installed and used in accordance with the manufacturer's instruction manual, may cause interference with radio communications. However, there is no guarantee that interference will not occur in a particular installation. If this equipment does cause harmful interference to radio or television reception, which can be determined by turning the equipment off and on, you are encouraged to try to correct the interference by one or more of the following measures:

- Reorient or relocate the receiving antenna.
- Increase the separation between the equipment and the receiver.
- Connect the equipment into an outlet on a circuit different from that to which the receiver is connected.
- Consult the retailer or an experienced radio/television technician for help.

Any changes or modifications not expressly approved by WD could void the user's authority to operate the equipment.

ICES/NMB-003 Compliance

Cet appareil de la classe B est conforme à la norme NMB-003 du Canada.

This device complies with Canadian ICES-003 Class B.

Safety Compliance

Approved for US and Canada. CAN/CSA-C22.2 No. 60950-1, UL 60950-1: Safety of Information Technology Equipment.

Approuvé pour les Etats-Unis et le Canada. CAN/CSA-C22.2 No. 60950-1 : Sûreté d'équipement de technologie de l'information.

This product is intended to be supplied by a listed limited power source, double insulated, or direct plug-in power unit marked "Class 2."

CE Compliance for Europe

Verified to comply with EN55022 for RF emission; EN-55024 for Generic Immunity, as applicable; and EN-60950 for Safety.

GS Mark (Germany only)

Machine noise - regulation 3. GPSGV: Unless declared otherwise, the highest level of sound pressure from this product is 70db(A) or less, per EN ISO 7779. Maschinenlärminformations-Verordnung 3. GPSGV: Der höchste Schalldruckpegel beträgt 70 db(A) oder weniger gemäß EN ISO 7779, falls nicht anders gekennzeichnet oder spezifiziert.

KC Notice (Republic of Korea only)

기종별	사용자 안내문
B 급기기 (가정용방송통신기자재)	이 기기는 가정용(B 급) 전자파적합기기로서 주로 가정에서 사용하는 것을 목적으로 하며, 모든 지역에서 사용할 수 있습니다.

Environmental Compliance (China)

部件编号	铅 (Pb)	Mercury (Hg)	Cadmium (Cd)	六价铬 (Cr (VI))	多溴联苯(PBB)	多溴联苯醚(PBDE)
PCBA	X	○	○	○	○	○
适配器主体	X	○	○	○	○	○
电缆	○	○	○	○	○	○
螺丝	○	○	○	○	○	○
脚垫	○	○	○	○	○	○
金属	○	○	○	○	○	○
塑料	○	○	○	○	○	○
木箱	○	○	○	○	○	○
标签	○	○	○	○	○	○

○: 表示元件构成同种材料不含有杂质或所含杂质符合 SJ/T 11363-2006 规范所规定的最大允许掺杂范围。

X: 表示元件所含物质超出 SJ/T 11363-2006 规范

Warranty Information (All Regions Except Australia/New Zealand)

Obtaining Service

WD values your business and always attempts to provide you the very best of service. If this Product requires maintenance, either contact the dealer from whom you originally purchased the Product or visit our product support Web site at <http://support.wd.com> for information on how to obtain service or a Return Material Authorization (RMA). If it is determined that the Product may be defective, you will be given an RMA number and instructions for Product return. An unauthorized return (i.e., one for which an RMA number has not been issued) will be returned to you at your expense. Authorized returns must be shipped in an approved shipping container, prepaid and insured, to the address provided on your return paperwork. Your original box and packaging materials should be kept for storing or shipping your WD product. To conclusively establish the period of warranty, check the warranty expiration (serial number required) via <http://support.wd.com>. WD shall have no liability for lost data regardless of the cause, recovery of lost data, or data contained in any Product placed in its possession.

Limited Warranty

WD warrants that the Product, in the course of its normal use, will for the term defined below, be free from defects in material and workmanship and will conform to WD's specification therefor. The term of your limited warranty depends on the country in which your Product was purchased. The term of your limited warranty is for 2 years in the North, South and Central America region, 2 years in the Europe, the Middle East and Africa region, and 2 years in the Asia Pacific region, unless otherwise required by law. The term of your limited warranty period shall commence on the purchase date appearing on your purchase receipt. WD may at its discretion make extended warranties available for purchase. WD shall have no liability for any Product returned if WD determines that the Product was stolen from WD or that the asserted defect a) is not present, b) cannot reasonably be rectified because of damage occurring before WD receives the Product, or c) is attributable to misuse, improper installation, alteration (including removing or obliterating labels and opening or removing external enclosures, unless the product is on the list of limited user-serviceable products and the specific alteration is within the scope of the applicable instructions, as found at <http://support.wd.com>), accident or mishandling while in the possession of someone other than WD. Subject to the limitations specified above, your sole and exclusive warranty shall be, during the period of warranty specified above and at WD's option, the repair or replacement of the Product with an equivalent or better Product. The foregoing warranty of WD shall extend to repaired or replaced Products for the balance of the applicable period of the original warranty or ninety (90) days from the date of shipment of a repaired or replaced Product, whichever is longer.

The foregoing limited warranty is WD's sole warranty and is applicable only to products sold as new. The remedies provided herein are in lieu of a) any and all other remedies and warranties, whether expressed, implied or statutory, including but not limited to, any implied warranty of merchantability or fitness for a particular purpose, and b) any and all obligations and liabilities of WD for damages including, but not limited to accidental, consequential, or special damages, or any financial loss, lost profits or expenses, or lost data arising out of or in connection with the purchase, use, or performance of the Product, even if WD has been advised of the possibility

of such damages. In the United States, some states do not allow exclusion or limitations of incidental or consequential damages, so the limitations above may not apply to you. This warranty gives you specific legal rights, and you may also have other rights which vary from state to state.

Warranty Information (Australia/New Zealand only)

For consumers purchasing products in Australia and New Zealand, please refer to this warranty information.

Nothing in this warranty modifies or excludes your legal rights under the Australian Competition and Consumer Act or the New Zealand Consumer Guarantees Act. This warranty identifies WD's preferred approach to resolving warranty claims which is likely to be quick and simple for all parties.

No other warranties either express or implied by law, including but not limited to those contained in the Sale of Goods Act, are made with respect to the Product. If you purchased your Product in New Zealand for the purposes of a business, you acknowledge and agree that the New Zealand Consumer Guarantees Act does not apply.

In Australia, our goods come with guarantees that cannot be excluded under the Australian Consumer Law. You are entitled to a replacement or refund for a major failure and compensation for any other reasonably foreseeable loss or damage. You are also entitled to have the goods repaired or replaced if goods fail to be of acceptable quality and the failure does not amount to a major failure. What constitutes a major failure is set out in the Australian Consumer Law.

Warranty

WD warrants that the Product, in the course of its normal use, will for the term defined below, be free from defects in material and workmanship and will conform to WD's specifications. The term of your warranty is 2 years in Australia and New Zealand, unless otherwise required by law. The term of your warranty period shall commence on the purchase date appearing on your purchase receipt from an authorized distributor or authorized reseller. Proof of purchase shall be required to be eligible for this warranty and to establish the commencement date of this warranty. Warranty service will not be provided unless the Product is returned to an authorized distributor, authorized reseller or regional WD return center where the Product was first shipped by WD. WD may at its discretion make extended warranties available for purchase. WD shall have no liability for any Product returned if WD determines that the Product was (i) not purchased from an authorized distributor or authorized reseller, (ii) not used in accordance with WD specifications and instructions, (iii) not used for its intended function, or (iv) stolen from WD, or that the asserted defect a) is not present, b) cannot reasonably be rectified because of damage occurring before WD receives the Product, or c) is attributable to misuse, improper installation, alteration (including removing or obliterating labels and opening or removing external enclosures, including the mounting frame, unless the product is on the list of limited user-serviceable products and the specific alteration is within the scope of the applicable instructions, as found at <http://support.wd.com>), accident or mishandling while in the possession of someone other than WD.

PRODUCTS ARE COMPLEX AND FRAGILE ITEMS THAT MAY OCCASSIONALLY FAIL DUE TO (A) EXTERNAL CAUSES, INCLUDING WITHOUT LIMITATION, MISHANDLING, EXPOSURE TO HEAT, COLD, AND HUMIDITY, AND POWER FAILURES, OR (B) INTERNAL FAULTS. SUCH FAILURES CAN RESULT IN THE LOSS, CORRUPTION, DELETION OR ALTERATION OF DATA. NOTE THAT YOU SHALL BE RESPONSIBLE FOR THE LOSS, CORRUPTION, DELETION OR ALTERATION OF DATA HOWSOEVER CAUSED, AND FOR BACKING UP AND PROTECTING DATA AGAINST LOSS, CORRUPTION, DELETION OR ALTERATION. YOU AGREE TO CONTINUALLY BACK UP ALL DATA ON THE PRODUCT, AND TO COMPLETE A BACKUP PRIOR TO SEEKING ANY GENERAL SERVICE AND TECHNICAL SUPPORT FROM WD.

In Australia, if the Product is not of a kind ordinarily acquired for personal, domestic or household use or consumption, provided it is fair and reasonable to do so, WD limits its liability to replacement of the Product or supply of equivalent or better Product.

This warranty shall extend to repaired or replaced Products for the balance of the applicable period of the original warranty or ninety (90) days from the date of shipment of a repaired or replaced Product, whichever is longer. This warranty is WD's sole manufacturer's warranty and is applicable only to Products sold as new.

Obtaining Service

WD values your business and always attempts to provide you the very best of service. Should you encounter any problem, please give us an opportunity to address it before returning this Product. Most technical support questions can be answered through our knowledge base or e-mail support service at <http://support.wd.com>. If the answer is not available or, if you prefer, please contact WD at the applicable telephone number shown in the front of this document.

If you wish to make a claim, you should initially contact the dealer from whom you originally purchased the Product. If you are unable to contact the dealer from whom you originally purchased the Product, please visit our product support Web site at <http://support.wd.com> for information on how to obtain service or a Return Material Authorization (RMA). If it is determined that the Product may be defective, you will be given an RMA number and instructions for Product return. An unauthorized return (i.e., one for which an RMA number has not been issued)

will be returned to you at your expense. Authorized returns must be shipped in an approved shipping container, prepaid and insured, to the address provided with your RMA number. If following receipt of a qualifying claim under this warranty, WD or the dealer from whom you originally purchased the Product determines that your claim is valid, WD or such dealer shall, at its discretion, either repair or replace the Product with an equivalent or better Product or refund the cost of the Product to you. You are responsible for any expenses associated with a claim under this warranty. The benefits provided to you under this warranty are in addition to other rights and remedies available to you under the Australian Competition and Consumer Act or the New Zealand Consumer Guarantees Act.

Your original box and packaging materials should be kept for storing or shipping your WD product. To conclusively establish the period of warranty, check the warranty expiration (serial number required) via <http://support.wd.com>.

Western Digital Technologies, Inc.
3355 Michelson Drive, Suite 100
Irvine, California 92612
Phone: 949-672-7000
E-mail: support@wd.com

Index

A

Accessing

- personal cloud on the web 70
- your personal cloud remotely 60

Accessories 5

Alerts

- dashboard icons 43
- monitoring with WD Quick View 38

Apple Time Machine 27

B

Backing up

- Apple Time Machine 27
- Windows 7 Backup and Restore 26
- Windows 8 File History 27

Box contents 5

C

Capacity 44

China RoHS 125

Cloud access

- accessing your cloud remotely 60
- enabling for all users 76
- status 77

Cloud devices, adding 46

Compliance

- regulatory 124
- safety 124

Connecting the device 9, 13, 101, 105

Content scan 48

Customer Support 48

D

Dashboard Home page 42

Diagnosis 44

Disconnecting safely 122

Do not unplug your WD My Cloud device while a restore is in progress. 84

Drive configurations, saving and importing 87

Drive status 44

Drive, viewing properties 37

E

Enabling cloud access

- for a user 60
- for the device 60

Energy saver 78

Environmental compliance (China) 125

F

Failed router, troubleshooting 120

Features 3

Firmware updates 45

G

Getting started

- with online setup installer 11, 103
- without online setup installer 21, 113

H

h 124

höchste 124

How do I? 50

I

ICES/NMB-003 compliance 124

Icons

- information 43
- navigation 43

Installer software 11, 103

Installing

- WD My Cloud app 66
- WD My Cloud desktop app 17, 109
- WD Photos 63
- WD SmartWare software 24

Internet connection 6

L

LAN

- configuration 79
- requirements 6

Language settings 75

Launching

- WD My Cloud Dashboard 36
- WD SmartWare 25, 35

LEDs

- back panel 11, 103
- front panel 10, 102

Log files, sending to Customer Support 49

M

Mac

- Apple Time Machine 27
- enabling backup 78

Making a share private 57

Managing

- users and shares 51
- using Quick View 32

Mapping

- Public share 23, 115
- USB drive 117
- using WD Quick View 36

- Media
 - enabling streaming 82
- Media setting, DLNA and iTunes 82
- Mobile apps
 - installing WD My Cloud 66
 - installing WD Photos 63
- Mobilizing your files,overview 62
- Monitoring storage 37
- N**
- Navigating through the system 43
- Network services settings 80
- Network settings 79
- Notifications, types 88
- O**
- Obtaining service 125
- Online Help for WD SmartWare 26
- Online Learning Center 4, 24, 32
- Online setup installer 11, 103
- Opening shares 35
- Operating system requirements 6
- P**
- Package contents 5
- Password, changing 53
- Password,changing 53
- Personal cloud 14, 106
 - accessing on the web 70
- Precautions 7
- Pre-installation requirements 7
- Private share
 - creating for a user 53
 - making public 57
 - opening 35
- Product registration iii
- Product warranty 125, 126
- Public share
 - accessing with Mac OS X/Snow Leopard/Lion/Mountain Lion 23, 115
 - accessing with Windows 8 21, 113
 - accessing with Windows Vista/Windows 7 22, 114
 - converting from a private share 57
- R**
- Rebooting safely 85
- Registration
 - online iii
- Regulatory compliance 124
- Remote access 14, 60, 106
- Remote access for sharing files 73
- Requirements, operating systems 6
- Resetting the WD My Cloud device 119
- Restoring to factory defaults 84
- RoHS 125
- S**
- Safepoint
 - creating 93
 - deleting 100
 - managing 93
 - recovering 98
 - updating 98
- Safety
 - compliance 124
 - instructions 1
- Scanning content 48
- Service,obtaining 125
- Settings
 - configuration 74
 - general 74
 - media 82
 - network services 80
 - system diagnostics 83
 - utilities 83
 - workgroup 82
- Share 47
 - accessing 35
 - accessing contents locally 58
 - changing from Public to private 57
 - creating 56
 - deleting 58
 - settings 51
 - user name and password 53
- Sharing files remotely 73
- Shortcut
 - to a public share 37
 - to a USB drive 117
- Shutting down safely
 - troubleshooting 122
 - using dashboard 85
 - using the WD Quick View icon 38
- Specifications 118
- Support resouces 50
- System diagnostics 83
- System requirements 6
- T**
- Time settings 75
- Troubleshooting 119
 - can't shut down 122
 - cannot play media through digital media adapter 122

- checklist 119
 - drive not connecting to network 120
 - failed router 120
 - LEDs don't light up 120
 - manually mapping the drive letter 120
 - resetting the system 119
 - Setup or WD SmartWare cannot detect my drive 121
- U**
- Uninstalling WD Quick View 40
 - USB hard drive
 - connect and manage 116
 - creating a shortcut (Windows Only) 117
 - creating shortcut to mapping 117
 - User
 - creating 53
 - creating private share for 53
 - enabling cloud access for password 53
 - settings 51
 - viewing list of 51
 - Users 47
 - Utilities 83
- W**
- WAN 6
 - Warning
 - deleting a share 58
 - do not move drive 119
 - interrupting the factory restore 84
 - unplugging drive during reboot or shutdown 85
 - Warranty information
 - all regions except Australia/New Zealand 125
 - Australia/New Zealand 126
 - WD My Cloud
 - accessing contents of shares locally 58
 - changing user password 53
 - configuration settings 87
 - creating a share 56
 - deleting a share 58
 - factory restore 84
 - managing users 51
 - notifications 88
 - private shares 53
 - safepoints 93
 - user settings 51
 - WD My Cloud Dashboard, launching 36, 41
 - WD My Cloud mobile app
 - installing 66
 - overview 66
 - WD Photos mobile app 63
 - WD Quick View
 - alerts 39
 - managing 32
 - mapping the drive 36
 - monitoring storage 37
 - opening shares 35
 - safely shutting down 38
 - shortcut to public share 37
 - shortcuts 34
 - uninstalling 40
 - viewing drive properties 37
 - WD SmartWare
 - exiting safely 35
 - installing 24
 - launching 25, 35
 - online Help 26
 - overview 24
 - WDMycloud.com, accessing 70
 - Web browser compatibility 6
 - Windows 7 Backup and Restore 26
 - Windows 8 File History 27
 - Workgroup setting 82

Information furnished by WD is believed to be accurate and reliable; however, no responsibility is assumed by WD for its use nor for any infringement of patents or other rights of third parties which may result from its use. No license is granted by implication or otherwise under any patent or patent rights of WD. WD reserves the right to change specifications at any time without notice.

Western Digital, WD, the WD logo, My Book, My Passport, and WD TV are registered trademarks in the U.S. and other countries; and WD My Cloud, WD SmartWare, WD GreenPower, WD My Cloud, WD Photos, WD TV Live, WD TV Live Plus are trademarks of Western Digital Technologies, Inc. Other marks may be mentioned herein that belong to other companies.

© 2013 Western Digital Technologies, Inc. All rights reserved.

Western Digital
3355 Michelson Drive, Suite 100
Irvine, California 92612 U.S.A.

4779-705103-A01 Nov 2013

Free Manuals Download Website

<http://myh66.com>

<http://usermanuals.us>

<http://www.somanuals.com>

<http://www.4manuals.cc>

<http://www.manual-lib.com>

<http://www.404manual.com>

<http://www.luxmanual.com>

<http://aubethermostatmanual.com>

Golf course search by state

<http://golfingnear.com>

Email search by domain

<http://emailbydomain.com>

Auto manuals search

<http://auto.somanuals.com>

TV manuals search

<http://tv.somanuals.com>