

DVR 560

Digital Video Recorder

User Manual



Vivitar[®]
we make it easy[™]

© 2010 Sakar International, Inc. All rights reserved.

Windows and the Windows logo are registered trademarks of Microsoft Corporation.

All other trademarks are the property of their respective companies.

Contents

Introduction	2
What's Included.....	2
Parts of the Camera	3
Initial Camera Setup.....	4
Main Camera Modes	7
Camera Technical Specifications.....	8
Computer System Requirements – WINDOWS OS	9
Computer System Requirements – MAC OS	9
Using Your Digital Camera	10
Changing Camera Mode	10
Navigating the Menus.....	11
Video Capture Mode	12
Video Playback Mode.....	21
Photo Capture Mode	25
Photo Playback Mode	35
Connecting the Camera to a TV	39
Connecting the Camera to a Headset	40
Installing the Software	41
Connecting the Camera to the Computer.....	42
Getting Photos and Videos from your Camera to Your Computer	43
Get started!.....	44
Transfer media from my camera to my computer manually (Using Windows).....	44
Transfer media from my camera to my computer manually (Using Macintosh).....	45
Camera Maintenance	45
Sakar Warranty Card.....	46
Technical Support.....	47
Troubleshooting.....	47

Introduction

Thank you for purchasing this digital video recorder. Everything you need to take quality digital photos and videos is included with your camera.

Vivitar makes capturing those special moments as easy as possible.

Please read this manual carefully first in order to get the most out of your digital camera.

Note:

- *Your digital video recorder supports an SD Memory Card (up to 32GB).*
- *In order to use your digital video recorder normally, it is strongly recommended to insert the SD Memory card before use.*
- *SD Memory cards are not included and need to be purchased separately.*

What's Included

1. Digital Video Recorder
2. USB cable
3. TV Cable
4. Vivitar Experience Image Manager software Installation CD
5. Wrist Strap



Note: *SD Memory Card not included*

Parts of the Camera

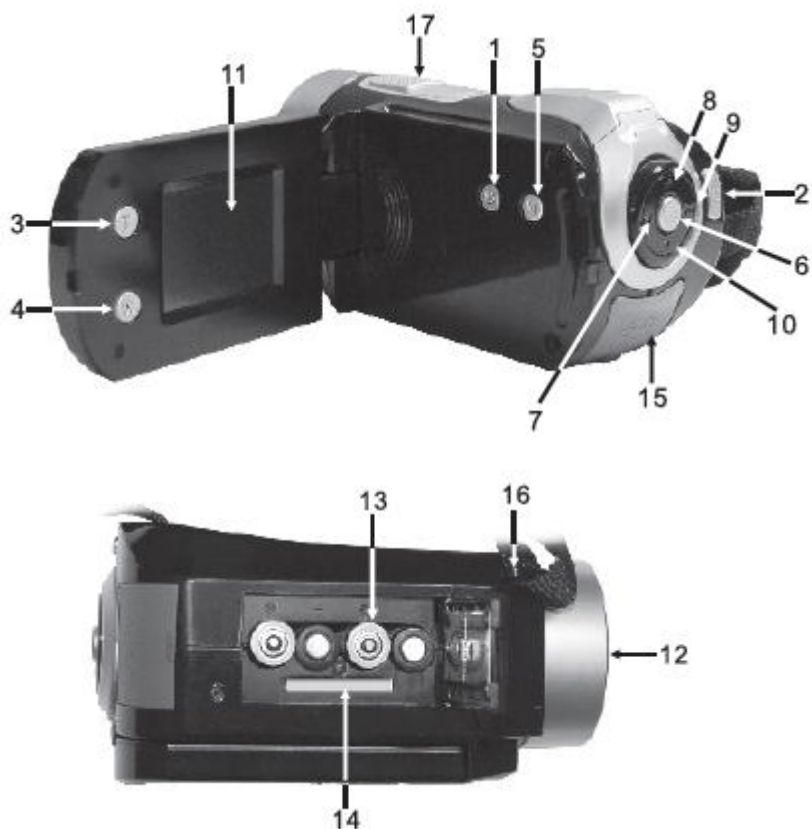

- | | |
|-------------------------------|---------------------------|
| 1. Power | 10. Down / ViviLink |
| 2. Photo/Video Shutter | 11. LCD Screen |
| 3. T / Zoom In | 12. Lens |
| 4. W / Zoom Out | 13. Battery Compartment |
| 5. MODE | 14. SD Memory Card Slot |
| 6. SET | 15. USB/AV Slot |
| 7. Left / Scene | 16. Wrist Strap Connector |
| 8. Up / Exposure / Slide Show | 17. Microphone /Speaker |
| 9. Right / Delete | |

Initial Camera Setup

Installing the Batteries



Insert 4 x AAA batteries.

Installing the Memory Card



Insert SD Memory card (up to 32GB) before use.

Turning On the Camera



Using the Camera

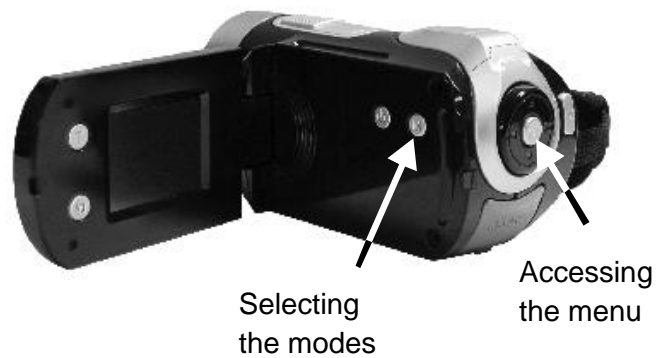

Selecting the modes

Accessing the menu

When powering the digital video recorder ON for the **first time** the digital video recorder will take you through the initial setup.

Powering the Digital video recorder ON

1. Make sure the batteries have been inserted properly into your digital video recorder. Use 4 x AAA (1.5v) batteries. Rechargeable batteries are not recommended for use.
2. Make sure an SD card has been properly inserted into your digital video recorder (inserted until a click sound is heard).

Note: *After the digital video recorder is powered on, an SD icon will appear on the LCD display. If you do not see the SD icon on the display, please check if the card was inserted properly.*

3. Flip open the LCD screen and press the **POWER** button  , located on the inside wall, to turn on the digital video recorder.

Setting the Language

1. You will first be prompted to select a language for the camera. The Language selection menu will appear. Select the language of your choice and press the **SET** button to confirm the selection.
2. After selecting a language, you will be asked if you would like to continue with the initial camera setup. A message will appear: "Setup Camera?" Select "Yes" to continue or "Cancel" to exit the setup.

Note: *If you select "Cancel" and decide to leave the camera setup, the camera will be set to its default settings. These settings can be adjusted at any time manually using the menus in the camera.*

Setting the Vivilink Default Option

Once the Language has been set, you will be asked to “Confirm Vivilink Photo and Video Social Network site” to set the default Vivilink destination for photos and videos taken with your camera. The Vivilink technology allows you to quickly and easily upload your camera’s photos and videos to the social networks of your choice with the accompanying software application.

1. First you will be asked to choose the default Vivilink social network for Photos.
2. Highlight the desired default social network and press the **SET** button to confirm the selection.
3. Next you will be asked to choose the default Vivilink social network for Videos.
4. Highlight the desired default social network and press the **SET** button to confirm the selection.
5. After the Vivilink Video option is confirmed the camera is now ready to use.

Main Camera Modes

Your camera has different modes for the various camera functions.

You can switch modes by pressing the **MODE (M)** button on your camera after the camera has been powered ON.



Video Capture Mode

Use this mode to capture videos with your digital camera.

This is the default mode when the camera is powered ON.

To take a video, aim your camera as desired and press the **Shutter** button to start the record. A red record indicator will appear on the LCD screen while record is in progress. To stop the record, press the **Shutter** button again. The video will be automatically saved to your camera's memory card.

To access the various menus for the Video Capture mode, press the **SET** button while in the Video Capture mode.



Photo Capture Mode

Use this mode to capture pictures with your camera.

After turning on your camera, press the **MODE (M)** button once to open the Photo Capture mode.

To take a picture, aim your camera as desired and press the **Shutter** button.

The picture will be automatically saved to your camera's memory card.

To access the various menus for the Photo Capture mode, press the **SET** button while in the Photo Capture mode.



Playback Mode (Photos & Videos)

Use this mode to view and manage the photos and videos on your camera.

After turning on your camera, press the **MODE (M)** button twice to open the Playback mode for photos and videos. You can scroll through the photos and videos that you've previously taken to view, edit or delete them as desired.

To access the various menus for the Playback mode for photos and videos, press the **SET** button while in the Playback mode.

Camera Technical Specifications

Image Sensor	CMOS Sensor
Image Resolution	(5M) 2592 x 1944 pixels, (3M) 2048 x 1536 pixels, (2M) 1600 x 1200 pixels, (2M HD) 1920 x 1080 pixels and (VGA) 640 x 480 pixels
Video Resolution	640X480 pixels (30 fps), 320X240 pixels (30 fps)
File Format	JPEG/AVI
External Memory	SD Card (up to 32GB)
LCD Display	1.8 Inch TFT
Lens	3P
Zoom	4X Digital Zoom
Exposure	-3.0EV ~ +3.0EV
White Balance	Auto, Daylight, Cloudy, Incandescent , Fluorescent
Scene	Auto / Scenery / Portrait / Night Scenery / Night Portrait / High Sensitivity / Sport / Beach / Party
Color Effect	Standard, Sepia, Monochrome, Vivid
Microphone	Yes
Speaker	Yes
Self-Timer	2, 5 or 10 second delay
Multi Snapshots (Burst)	Yes
Language	English, French, Spanish, Portuguese, German, Dutch, Italian
Interface	USB 2.0
System Requirements	Windows XP and above / Mac OSX 10.5 and above
Battery	4 * AAA (1.5V) batteries
Working Temperature	-20~45°C

Computer System Requirements – WINDOWS OS

To be able to download photos and videos to your PC, you will need the following minimum configuration:

- Pentium 4 processor or above with Windows XP service pack 2, Windows Vista or Windows 7
- 512 MB RAM, with 100MB of free disk space
- 1024 x 768 Recommended screen resolution
- 16-bit color or higher display adaptor
- CD-ROM Drive
- QuickTime 6 or higher
- Microsoft Internet Explorer 7 or higher
- Windows Media Player 10 or higher
- Internet connection required

Computer System Requirements – MAC OS

- Macintosh with Intel processor running Mac OS X v10.5 or later
- 256 MB RAM, 100 MB free disk space
- Display: 1024 x 768 or higher-resolution monitor
- QuickTime 6 or higher
- Internet connection required

Using Your Digital Camera

- Make sure the batteries have been inserted properly into your digital camera.
- If your camera comes with a rechargeable lithium battery, make sure it is fully charged before the first use.
- Make sure an SD card has been inserted into your camera.

Powering the camera ON

Press the **Power** button  to turn your camera ON.

The camera will be in Video Capture mode to start.

Powering the camera OFF

While the camera is on, you can press the **Power** button  again at any point to turn your camera OFF. You will see a “Goodbye” splash screen and then the camera will power off completely.

Note: *Your digital camera also has an Auto Power Off feature that will automatically turn off your camera after a specific period of time that your camera is left idle. The Auto Power Off settings can be set from the Auto Power Off settings menu.*

Changing Camera Mode

Your camera has three main modes:

1. **Video Capture Mode** - Use this mode to capture videos with your camera.
2. **Photo Capture Mode** - Use this mode to capture photos with your camera.
3. **Playback Mode (for photos and videos)** - Use this mode to view the photos and videos you have already taken with your camera.

When the camera is first powered ON, the Video Capture Mode will be active. The icons that appear on the LCD screen are the best default settings so that you can begin to capture and enjoy clear quality videos and photos.

To change the active camera mode, make sure the camera is powered ON and press the **MODE (M)** button.



When in Video Capture Mode, this icon will display on the top-left corner of the LCD display



When in Photo Capture Mode, this icon will display on the top-left corner of the LCD display



When in Playback Mode, this icon will display on the top-left corner of the LCD display

Navigating the Menus

Each camera mode has a set of menus specific to that mode.



1. Press the **SET** button to open the menus for the current mode.
2. Press the **LEFT** or **RIGHT** direction control buttons to scroll between the various menus for the current mode.
3. Press the **UP** or **DOWN** direction control buttons to highlight the desired menu option.
4. Press the **SET** button to select and save the highlighted menu option.
5. If the selection can be remembered by the camera, a  selection icon will appear to the right of the selected menu option. Changes made to these options will remain as is until you decide to change them again at a later time.
6. Some menu options are single-use functions that are not remembered by the camera and do not display this icon when selected.
7. At any time you can press the **MODE (M)** button to exit the menus and return to the previous screen.

Video Capture Mode

The Video Capture Mode allows you to capture videos with your digital camera.









When the camera is first powered ON, the camera will be in Video Capture Mode.

Taking a Video

1. While in Video Capture Mode use the LCD display to direct the camera at the scene you would like to capture.
2.  Click the **T/Zoom In** and **W/Zoom Out** buttons to better set the camera display if desired.
Note: The actual shape of these buttons may vary per camera model.
3.  Press the **Shutter** button on the right of the directional pad to start the video capture.
4. You will see a red blinking icon at the top of the LCD indicating that the record is in progress.
5. To stop the video record, press the **Shutter** button again.
6. The video will automatically be saved to the camera's SD card.

Video Capture Mode Quick Function Buttons

Your digital camera has a four-directional pad that functions as Quick Function buttons.

Button	Function
 Left	 Scene Selection: Opens the Scene menu
 Up	 Light Exposure Selection: Opens the Light Exposure menu
 Right	 Delete: Opens the 'Delete Last Video' option and allows you to delete the last video you captured
 Down	 ViviLink Selection: Opens the ViviLink for Videos menu

Hide/Show the LCD Icons

The display of the icons on the LCD screen can be hidden or visible as desired.

1. Hold the **MODE** button for 2 seconds to hide the display of the icons on the screen.
2. Press the **MODE** button again to redisplay the icons on the screen

Video Capture Mode Menus

The following are the menus that appear in your camera's Video Capture Mode:

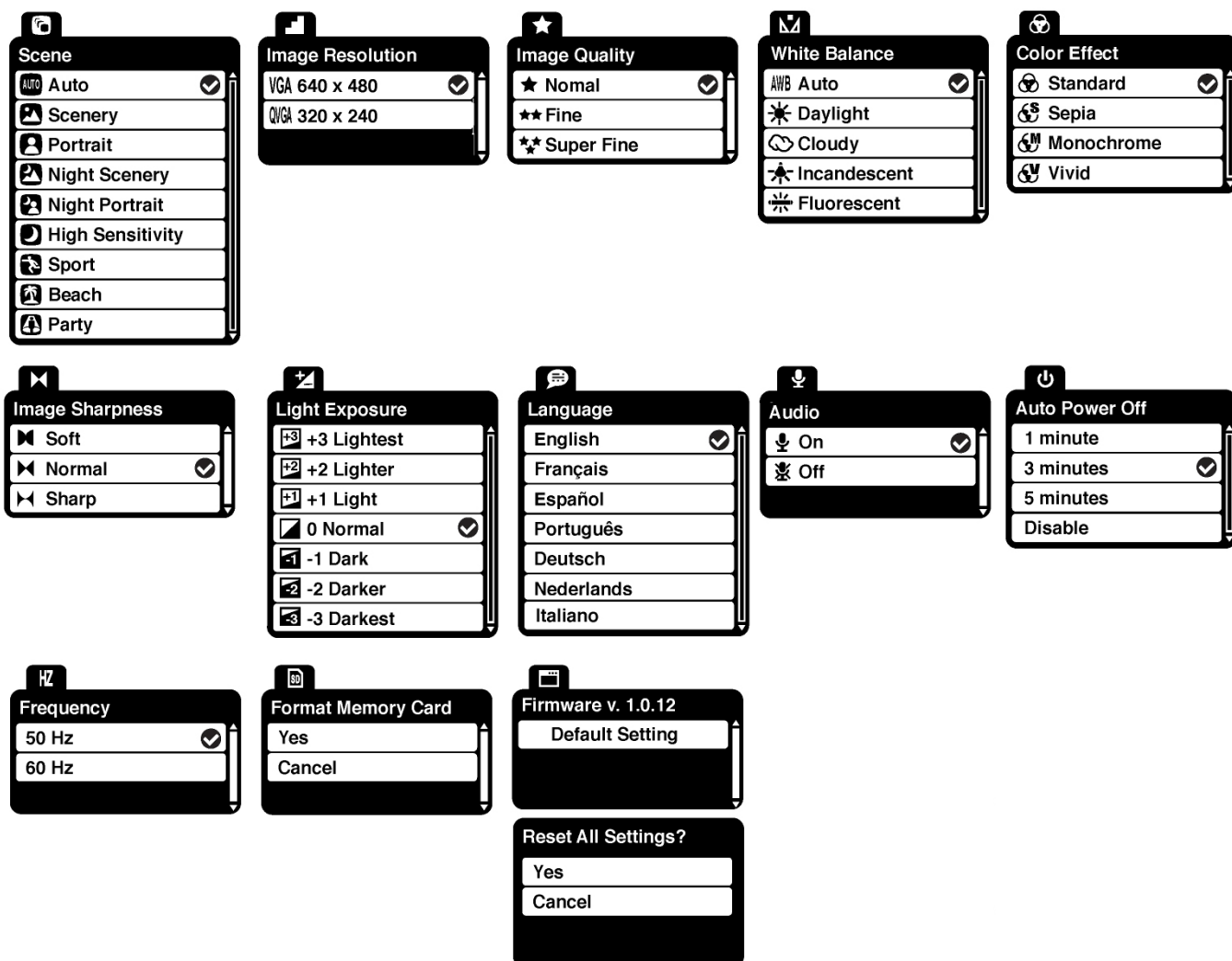

Scene Menu

The Scene Menu allows you to choose scene settings that allow your camera to adapt properly to your current environment.

1. Press the **SET** button to open the menus for the current mode.
2. Press the **LEFT** or **RIGHT** direction control buttons to scroll and select the Scene menu.
3. Press the **UP** or **DOWN** direction control buttons to highlight the desired menu option.
4. Press the **SET** button to select and save the desired option.
5. A  selected option icon will appear on the selected item.
6. Press the **LEFT** or **RIGHT** button to select the next menu item.
7. Press the **MODE** button to exit the menu and return to your previous mode.
8. An icon reflecting your selection will display on the LCD screen.
9. Remember that this setting will be saved by your camera until you manually change the setting or restore the camera's default factory settings.

Image Resolution Menu

The Image Resolution menu allows you to choose the desired size of the images taken by your camera. Keep in mind that images with a higher resolution will also take up more of your camera's memory.



1. Press the **SET** button to open the menus for the current mode.
2. Press the **LEFT** or **RIGHT** direction control buttons to scroll and select the Image Resolution menu.
3. Press the **UP** or **DOWN** direction control buttons to highlight the desired menu option.
4. Press the **SET** button to select and save the desired option.
5. A  selected option icon will appear on the selected item.
6. Press the **LEFT** or **RIGHT** button to select the next menu item.
7. Press the **MODE** button to exit the menu and return to your previous mode.
8. An icon reflecting your selection will display on the LCD screen.
9. Remember that this setting will be saved by your camera until you manually change the setting or restore the camera's default factory settings.

Image Quality Menu ★

The Image Quality menu allows you to select the desired quality level of the images taken by your camera. Keep in mind that images with a higher image quality level will also take up more memory on your camera.

1. Press the **SET** button to open the menus for the current mode.
2. Press the **LEFT** or **RIGHT** direction control buttons to scroll and select the Image Quality menu.
3. Press the **UP** or **DOWN** direction control buttons to highlight the desired menu option.
4. Press the **SET** button to select and save the desired option.
5. A  selected option icon will appear on the selected item.
6. Press the **LEFT** or **RIGHT** button to select the next menu item.
7. Press the **MODE** button to exit the menu and return to your previous mode.
8. An icon reflecting your selection will display on the LCD screen.
9. Remember that this setting will be saved by your camera until you manually change the setting or restore the camera's default factory settings.

White Balance Menu ⏏

The White Balance feature allows your camera to adjust the coloring of the captured images depending on the type of light source in the current environment.

Properly adjusting the White Balance setting to match your current environment will allow the camera to properly balance the colors in the images that are taken with your camera.

1. Press the **SET** button to open the menus for the current mode.
2. Press the **LEFT** or **RIGHT** direction control buttons to scroll and select the White Balance menu.
3. Press the **UP** or **DOWN** direction control buttons to highlight the desired menu option.
4. Press the **SET** button to select and save the desired option.
5. A  selected option icon will appear on the selected item.
6. Press the **LEFT** or **RIGHT** button to select the next menu item.
7. Press the **MODE** button to exit the menu and return to your previous mode.
8. An icon reflecting your selection will display on the LCD screen.
9. Remember that this setting will be saved by your camera until you manually change the setting or restore the camera's default factory settings.

Color Effect Menu

You can choose to add a color effect to the images taken with your camera.



1. Press the **SET** button to open the menus for the current mode.
2. Press the **LEFT** or **RIGHT** direction control buttons to scroll and select the Color Effect menu.
3. Press the **UP** or **DOWN** direction control buttons to highlight the desired menu option.
4. Press the **SET** button to select and save the desired option.
5. A  selected option icon will appear on the selected item.
6. Press the **LEFT** or **RIGHT** button to select the next menu item.
7. Press the **MODE** button to exit the menu and return to your previous mode.
8. Remember that this setting will be saved by your camera until you manually change the setting or restore the camera's default factory settings.

Image Sharpness Menu

You can set the level of sharpness in the images taken with your camera. The sharpness level dictates if the edges of objects in the image are more or less distinct.

1. Press the **SET** button to open the menus for the current mode.
2. Press the **LEFT** or **RIGHT** direction control buttons to scroll and select the Image Sharpness menu.
3. Press the **UP** or **DOWN** direction control buttons to highlight the desired menu option.
4. Press the **SET** button to select and save the desired option.
5. A  selected option icon will appear on the selected item.
6. Press the **LEFT** or **RIGHT** button to select the next menu item.
7. Press the **MODE** button to exit the menu and return to your previous mode.
8. An icon reflecting your selection will display on the LCD screen
9. Remember that this setting will be saved by your camera until you manually change the setting or restore the camera's default factory settings.

Light Exposure Menu

The Light Exposure setting helps you control the amount of light that enters your camera's lens. This setting should be adjusted when the environment is lighter or darker than normal.

When the environment has more light than is needed, reduce the exposure setting (by using the negative - count) to reduce the amount of light allowed into the lens by your camera.

If the environment has less light (darker) than is needed, increase the exposure setting (by using the positive + count) to increase the amount of light allowed into the lens by your camera.

1. Press the **SET** button to open the menus for the current mode.
2. Press the **LEFT** or **RIGHT** direction control buttons to scroll and select the Light Exposure menu.
3. Press the **UP** or **DOWN** direction control buttons to highlight the desired menu option.
4. Press the **SET** button to select and save the desired option.
5. A  selected option icon will appear on the selected item.
6. Press the **LEFT** or **RIGHT** button to select the next menu item.
7. Press the **MODE** button to exit the menu and return to your previous mode.
8. An icon reflecting your selection will display on the LCD screen.
9. Remember that this setting will be saved by your camera until you manually change the setting or restore the camera's default factory settings.

Language Menu

You can select your camera's language setting by selecting the desired language from the Language menu.

1. Press the **SET** button to open the menus for the current mode.
2. Press the **LEFT** or **RIGHT** direction control buttons to scroll and select the Language menu.
3. Press the **UP** or **DOWN** direction control buttons to highlight the desired menu option.
4. Press the **SET** button to select and save the desired option.

5. A  selected option icon will appear on the selected item.
6. Press the **LEFT** or **RIGHT** button to select the next menu item.
7. Press the **MODE** button to exit the menu and return to your previous mode.
8. Remember that this setting will be saved by your camera until you manually change the setting or restore the camera's default factory settings.

Audio Menu

The Audio menu allows you to control the camera's ability to record audio in the video clips recorded with your camera in addition to the video record.

Note: *The Audio menu may not be available in some versions of this camera.*

1. Press the **SET** button to open the menus for the current mode.
2. Press the **LEFT** or **RIGHT** direction control buttons to scroll and select the Audio menu.
3. Press the **UP** or **DOWN** direction control buttons to highlight the desired menu option.
4. Press the **SET** button to select and save the desired option.
5. A  selected option icon will appear on the selected item.
6. Press the **LEFT** or **RIGHT** button to select the next menu item.
7. Press the **MODE** button to exit the menu and return to your previous mode.
8. An icon reflecting your selection will display on the LCD screen.
9. Remember that this setting will be saved by your camera until you manually change the setting or restore the camera's default factory settings.

Auto Power Off Menu

You can use the Auto Power Off feature in order to conserve you camera's battery life. The designated time represents when your camera will automatically power off.

When the digital video recorder sits idle for the designated period of time, the digital video recorder will shut off completely and will need to be turned on again with the power button before the next use.

1. Press the **SET** button to open the menus for the current mode.
2. Press the **LEFT** or **RIGHT** direction control buttons to scroll and select the Auto Power Off menu.

3. Press the **UP** or **DOWN** direction control buttons to highlight the desired menu option.
4. Press the **SET** button to select and save the desired option.
5. A  selected option icon will appear on the selected item.
6. Press the **LEFT** or **RIGHT** button to select the next menu item.
7. Press the **MODE** button to exit the menu and return to your previous mode.
8. Remember that this setting will be saved by your camera until you manually change the setting or restore the camera's default factory settings.

Frequency Menu ^{HZ}

The options in the Frequency menu represent the frequency of the electrical current in fluorescent lighting sources in your locale. If your camera is set to a frequency that does not match your country's electric current, you may see flickering or waves on the images taken by your camera.

50Hz – UK, Europe and Australia

60Hz – US, Canada and South America

1. Press the **SET** button to open the menus for the current mode.
2. Press the **LEFT** or **RIGHT** direction control buttons to scroll and select the Frequency menu.
3. Press the **UP** or **DOWN** direction control buttons to highlight the desired menu option.
4. Press the **SET** button to select and save the desired option.
5. A  selected option icon will appear on the selected item.
6. Press the **LEFT** or **RIGHT** button to select the next menu item.
7. Press the **MODE** button to exit the menu and return to your previous mode.
8. Remember that this setting will be saved by your camera until you manually change the setting or restore the camera's default factory settings.

Format Memory Card Menu

You can use the Format Memory Card menu to delete all of the content that is currently on your camera's memory card.

Keep in mind that formatting the memory card will permanently delete all of the content on your camera's memory card.

This option can only delete all of the content at one time. If you would like to delete individual images, use the Delete menu in the camera's Playback mode.

1. Press the **SET** button to open the menus for the current mode.
2. Press the **LEFT** or **RIGHT** direction control buttons to scroll and select the Format Memory Card menu.
3. Press the **UP** or **DOWN** direction control buttons to highlight the desired menu option.
4. Press the **MODE** button to exit the menu and return to your previous mode.
5. To Format the Memory Card:
 - If you would like to proceed with the format, select 'Yes' and press the **SET** button to confirm.
 - The memory card will be completely formatted.
 - You will automatically exit the menu and return to the previous mode.
6. To Exit the Format Memory Card Menu:
 - If you would like to exit the format without formatting the memory card, select 'Cancel' and press the **SET** button.
 - You will automatically exit the menu and return to the previous mode.

Firmware (Factory Default Settings) Menu

Use this menu to view the Firmware version on your camera or to reset your camera settings to the Factory Default Settings.

1. Press the **SET** button to open the menus for the current mode.
2. Press the **LEFT** or **RIGHT** direction control buttons to scroll and select the Firmware menu.
3. Press the **MODE** button to exit the menu and return to your previous mode.
4. To RESET the digital video recorder's settings to the Factory Default Settings, press the **SET** button to select 'Default Setting'.
 - If you would like to proceed with the reset, select 'Yes' and press the **SET** button to confirm.The settings will be reset.

You will automatically exit the menu and return to the previous mode with the digital video recorder settings set to the Factory Default Settings.

- If you would like to exit the format, select 'Cancel and press the **SET** button. You will automatically exit the menu and return to the previous mode.

Note: After *RESETTING* to the Factory settings and turning your digital video recorder off then on again, you will be prompted to select a system Language and *ViviLink* for Videos and Photos.

Video Playback Mode

When you first turn on the camera, the camera will be in Video Capture mode by default. Press the **MODE** button twice to open the **Playback** Mode. The Playback mode will allow you to review and edit photos and videos that you've already taken with you camera.

Playing Videos on Your Digital Video Recorder

1. Select your Video:
 - Once in Playback mode, press **LEFT** or **RIGHT** direction buttons to scroll through the images on your digital video recorder's memory card until you find the video you would like to view.
 - Each captured image (videos and photos) will display on the LCD screen.
 - Videos will appear with an '**AVI**' icon on the top left of the LCD screen.
2. Play your selected video:
 - Press the **Shutter** button to start playing the video.
 - Press the **Shutter** button again to pause the video and to continue playing and pausing as needed.
 - While the Video is playing all the icons on the top section of the LCD disappear.
 - To fully stop the video and restore the icons to the LCD, press the **UP** button.

Thumbnail View

Use the **W/Zoom Out** button to display the images on your camera in Thumbnail View.

The images (videos and photos) on your camera will be displayed in a 3 X 3 matrix where you can scroll and select images from the thumbnails.





1. Press the **W/Zoom Out** button.

All the images on your camera will appear in the Thumbnail View.

2. Use the **UP / DOWN / LEFT / RIGHT** direction buttons to scroll and select the image you wish to view.
3. Press the **SET** or **Shutter** button to enlarge the image full size.
4. Once the selected video is full size you can play and view the video.

Video Playback Mode Quick Function Buttons

Your digital camera has a four-directional pad that functions as Quick Function buttons.

Button	Function
 Left	<ol style="list-style-type: none">1. Displays the PREVIOUS image2. Navigates in the Thumbnail View
 Up	<ol style="list-style-type: none">1. STOPS a playing video2. Navigates in the Thumbnail View
 Right	<ol style="list-style-type: none">1. Displays the NEXT image2. DELETE: Holding the button down for 3 seconds opens the Delete Menu for the selected image (and for all images).3. Navigates in the Thumbnail View
 Down	<ol style="list-style-type: none">1.  Opens the ViviLink for Videos menu2. Navigates in the Thumbnail View

Other:

Shutter	PLAYS and PAUSES Video Playback
W/Zoom Out	Opens the Thumbnail View

Video Playback Mode Menus

The following are the menus that appear in your camera's Video Playback Mode:

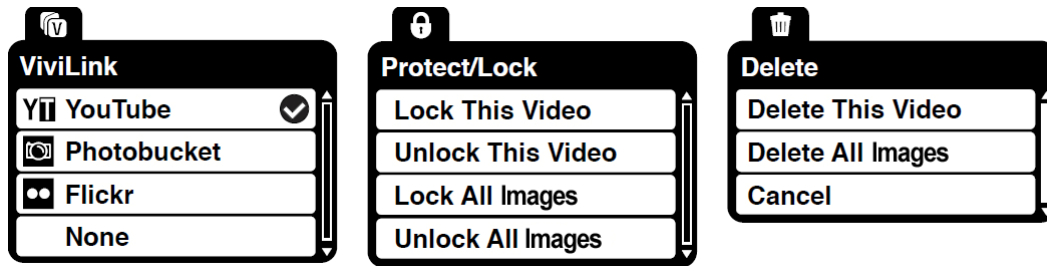

Note: The order of the menus may vary.

ViviLink Menu

The ViviLink technology allows you to quickly and easily upload your camera's photos and videos to the social networks of your choice with the accompanying Vivitar Experience Image Manager application.

1. Press the **SET** button to open the menus for the current mode.
2. Press the **LEFT** or **RIGHT** direction control buttons to scroll and select the ViviLink menu.
3. Press the **UP** or **DOWN** direction control buttons to highlight the desired menu option.
4. Press the **SET** button to select and save the desired option.
5. A  selected option icon will appear on the selected item
6. Press the **MODE** button to exit the menu and return to your previous mode.
7. An icon will appear on the image with the selected ViviLink destination site.
8. Changing the ViviLink destination site will also make the selected site the new default ViviLink option. A new default can be selected at any time through this menu.

Remember: The ViviLink menu can also be accessed simply by pushing the **DOWN** Quick Function Button.

Protect/Lock Menu

Pictures and Videos taken with your camera can be protected or "locked" to prevent any deletion or alteration being made to the files.

1. Press the **SET** button to open the menus for the current mode.
2. Press the **LEFT** or **RIGHT** direction control buttons to scroll and select the Protect/Lock

menu.

3. Press the **UP** or **DOWN** direction control buttons to highlight the desired menu option.
4. Press the **SET** button to select and save the desired option.
5. Press the **MODE** button to exit the menu and return to your previous mode.
6. Any image that is locked will display a lock symbol on the LCD screen when viewing that image in the Playback mode. Videos that are not locked will not display the lock symbol.

Remember: *Protected/Locked videos cannot be deleted.*

Delete Menu 🗑️

While in the Playback mode, you can delete videos from your camera using the Delete menu.

1. View the image you would like to delete.
2. Press the **SET** button to open the menus for the current mode.
3. Press the **LEFT** or **RIGHT** direction control buttons to scroll and select the Delete menu.
4. Press the **UP** or **DOWN** direction control buttons to highlight the desired menu option.
5. To delete the selected video, select “Delete This Video” and press **SET** button.
 - If you would like to proceed with deleting the current image: select ‘Yes’ and press the **SET** button to confirm. The video will be deleted and you will exit the menu and return to the Playback mode.
 - If you do not want to delete the current image, select ‘Cancel’ and press the **SET** button. The video will not be deleted and you will exit the menu and return to the Playback mode.
6. To delete all the images (videos and photos) you have saved on your SD Memory card, select ‘Delete All Images’ and press the **SET** button.
 - If you would like to proceed with deleting all the videos and photos, select ‘Yes’ and press the **SET** button to confirm.

All of your images will be permanently deleted.

A blank ‘No Files Exist’ screen will appear.

Press the **MODE** button to exit the ‘No Files Exist’ screen and return to Video Capture mode.

Remember: *All your images will be deleted except images that are Protected/Locked. To delete a locked image, first unlock the image, then select delete.*

- If you do not want to delete all of your videos and photos, select 'Cancel' and press the **SET** button. All images will remain on your SD card and you will exit the menu and return to the Playback mode.

Remember: The Delete menu can also be accessed simply by pushing and holding down the **Right Quick Function Button** for 3 seconds.

Photo Capture Mode

The Photo Capture mode allows you to capture pictures with your digital camera.

Taking a Picture

1. While in Photo Capture mode, use the LCD display to direct the camera at the scene you would like to capture.

2.  Click the **T/Zoom In** and **W/Zoom Out** buttons to better set the camera display if desired.

Note: The actual shape of these buttons may vary per camera model.







3.  Click the **Shutter** button to take the picture.
4. The picture will automatically be saved to the memory or SD card.

Photo Capture Mode Quick Function Buttons

Your digital camera has a four-directional pad that functions as Quick Function buttons:

Button	Function
 Left	 Scene Selection: Opens the Scene menu
 Right	 Delete Last Photo: Opens the 'Delete Last Photo?' option and allows you to delete the last photo you captured
 Down	 ViviLink: Opens the ViviLink for Photos menu

Hide/Show the LCD Icons

The display of the icons on the LCD screen can be hidden or visible as desired.

1. Hold the **MODE** button for 2 seconds to hide the display of the icons on the screen.
2. Press the **MODE** button again to redisplay the icons on the screen.

Photo Capture Mode Menus

The following are the menus that appear in your camera's Photo Capture Mode:

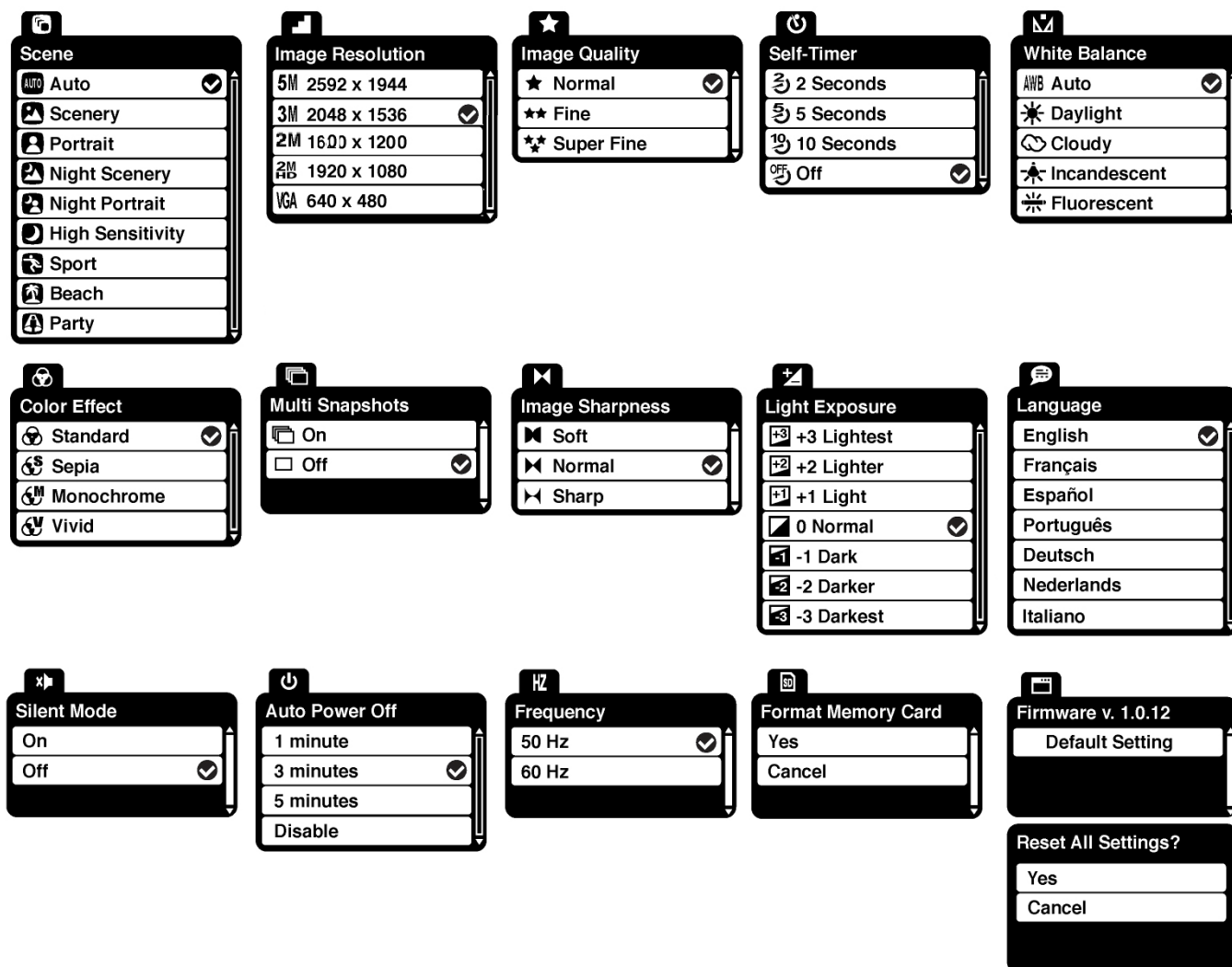

Scene Menu

The Scene Menu allows you to choose scene settings that allow your camera to adapt properly to your current environment.

1. Press the **SET** button to open the menus for the current mode.
2. Press the **LEFT** or **RIGHT** direction control buttons to scroll and select the Scene menu.
3. Press the **UP** or **DOWN** direction control buttons to highlight the desired menu option.
4. Press the **SET** button to select and save the desired option.
5. A  selected option icon will appear on the selected item.
6. Press the **LEFT** or **RIGHT** button to select the next menu item.
7. Press the **MODE** button to exit the menu and return to your previous mode.
8. An icon reflecting your selection will display on the LCD screen.
9. Remember that this setting will be saved by your camera until you manually change the setting or restore the camera's default factory settings.

Image Resolution Menu

The Image Resolution menu allows you to choose the desired size of the images taken by your camera. Keep in mind that images with a higher resolution will also take up more of your camera's memory.



1. Press the **SET** button to open the menus for the current mode.
2. Press the **LEFT** or **RIGHT** direction control buttons to scroll and select the Image Resolution menu.
3. Press the **UP** or **DOWN** direction control buttons to highlight the desired menu option.
4. Press the **SET** button to select and save the desired option.
5. A  selected option icon will appear on the selected item.
6. Press the **LEFT** or **RIGHT** button to select the next menu item.
7. Press the **MODE** button to exit the menu and return to your previous mode.
8. An icon reflecting your selection will display on the LCD screen.
9. Remember that this setting will be saved by your camera until you manually change the setting or restore the camera's default factory settings.

Image Quality Menu ★

The Image Quality menu allows you to select the desired quality level of the images taken by your camera. Keep in mind that images with a higher image quality level will also take up more memory on your camera.

1. Press the **SET** button to open the menus for the current mode.
2. Press the **LEFT** or **RIGHT** direction control buttons to scroll and select the Image Quality menu.
3. Press the **UP** or **DOWN** direction control buttons to highlight the desired menu option.
4. Press the **SET** button to select and save the desired option.
5. A  selected option icon will appear on the selected item.
6. Press the **LEFT** or **RIGHT** button to select the next menu item.
7. Press the **MODE** button to exit the menu and return to your previous mode.
8. An icon reflecting your selection will display on the LCD screen.
9. Remember that this setting will be saved by your camera until you manually change the setting or restore the camera's default factory settings.

Self-Timer Menu ⏰

The Self-Timer menu allows you to set a delay between the time that the camera's shutter button is pressed and the actual capture of the picture.

This is an optimal feature if you don't just want to take the picture but would also like to be in the picture yourself. Just set the desired self-timer delay, press the shutter button on your camera and position yourself in front of the camera as desired.

1. Press the **SET** button to open the menus for the current mode.
2. Press the **LEFT** or **RIGHT** direction control buttons to scroll and select the Self-Timer menu.
3. Press the **UP** or **DOWN** direction control buttons to highlight the desired menu option.
4. Press the **SET** button to select and save the desired option.
5. A  selected option icon will appear on the selected item.
6. Press the **LEFT** or **RIGHT** button to select the next menu item.
7. Press the **MODE** button to exit the menu and return to your previous mode.

8. An icon reflecting your selection will display on the LCD screen.
9. Remember that this setting will be saved by your camera until you manually change the setting or restore the camera's default factory settings.

White Balance Menu

The White Balance feature allows your camera to adjust the coloring of the captured images depending on the type of light source in the current environment.

Properly adjusting the White Balance setting to match your current environment will allow the camera to properly balance the colors in the images that are taken with your camera.

1. Press the **SET** button to open the menus for the current mode.
2. Press the **LEFT** or **RIGHT** direction control buttons to scroll and select the White Balance menu.
3. Press the **UP** or **DOWN** direction control buttons to highlight the desired menu option.
4. Press the **SET** button to select and save the desired option.
5. A  selected option icon will appear on the selected item.
6. Press the **LEFT** or **RIGHT** button to select the next menu item.
7. Press the **MODE** button to exit the menu and return to your previous mode.
8. An icon reflecting your selection will display on the LCD screen
9. Remember that this setting will be saved by your camera until you manually change the setting or restore the camera's default factory settings.

Color Effect Menu

You can choose to add a color effect to the images taken with your camera.

1. Press the **SET** button to open the menus for the current mode.
2. Press the **LEFT** or **RIGHT** direction control buttons to scroll and select the Color Effect menu.
3. Press the **UP** or **DOWN** direction control buttons to highlight the desired menu option.
4. Press the **SET** button to select and save the desired option.
5. A  selected option icon will appear on the selected item.

6. Press the **LEFT** or **RIGHT** button to select the next menu item.
7. Press the **MODE** button to exit the menu and return to your previous mode.
8. Remember that this setting will be saved by your camera until you manually change the setting or restore the camera's default factory settings.

Multi Snapshots Menu

When enabled, the Multi Snapshots feature allows you to take five rapid snapshots in a row with a single click of the shutter button.

This feature can be effective when trying to capture a particular moment in a sporting event or other scenes with quick movements.



1. Press the **SET** button to open the menus for the current mode.
2. Press the **LEFT** or **RIGHT** direction control buttons to scroll and select the Multi Snapshots menu.
3. Press the **UP** or **DOWN** direction control buttons to highlight the desired menu option.
4. Press the **SET** button to select and save the desired option.
5. A  selected option icon will appear on the selected item.
6. Press the **LEFT** or **RIGHT** button to select the next menu item.
7. Press the **MODE** button to exit the menu and return to your previous mode.
8. An icon reflecting your selection will display on the LCD screen
9. Remember that this setting will be saved by your camera until you manually change the setting or restore the camera's default factory settings.

Image Sharpness Menu

You can set the level of sharpness in the images taken with your camera. The sharpness level dictates if the edges of objects in the image are more or less distinct.

1. Press the **SET** button to open the menus for the current mode.
2. Press the **LEFT** or **RIGHT** direction control buttons to scroll and select the Image Sharpness menu.
3. Press the **UP** or **DOWN** direction control buttons to highlight the desired menu option.
4. Press the **SET** button to select and save the desired option.

5. A  selected option icon will appear on the selected item.
6. Press the **LEFT** or **RIGHT** button to select the next menu item.
7. Press the **MODE** button to exit the menu and return to your previous mode.
8. An icon reflecting your selection will display on the LCD screen
9. Remember that this setting will be saved by your camera until you manually change the setting or restore the camera's default factory settings.

Light Exposure Menu

The Light Exposure setting helps you control the amount of light that enters your camera's lens. This setting should be adjusted when the environment is lighter or darker than normal.

When the environment has more light than is needed, reduce the exposure setting (by using the negative - count) to reduce the amount of light allowed into the lens by your camera.

If the environment has less light (darker) than is needed, increase the exposure setting (by using the positive + count) to increase the amount of light allowed into the lens by your camera.

1. Press the **SET** button to open the menus for the current mode.
2. Press the **LEFT** or **RIGHT** direction control buttons to scroll and select the Light Exposure menu.
3. Press the **UP** or **DOWN** direction control buttons to highlight the desired menu option.
4. Press the **SET** button to select and save the desired option.
5. A  selected option icon will appear on the selected item.
6. Press the **LEFT** or **RIGHT** button to select the next menu item.
7. Press the **MODE** button to exit the menu and return to your previous mode.
8. An icon reflecting your selection will display on the LCD screen
9. Remember that this setting will be saved by your camera until you manually change the setting or restore the camera's default factory settings.

Language Menu

You can select your camera's language setting by selecting the desired language from the Language menu.

1. Press the **SET** button to open the menus for the current mode.

2. Press the **LEFT** or **RIGHT** direction control buttons to scroll and select the Language menu.
3. Press the **UP** or **DOWN** direction control buttons to highlight the desired menu option.
4. Press the **SET** button to select and save the desired option.
5. A  selected option icon will appear on the selected item.
6. Press the **LEFT** or **RIGHT** button to select the next menu item.
7. Press the **MODE** button to exit the menu and return to your previous mode.
8. Remember that this setting will be saved by your camera until you manually change the setting or restore the camera's default factory settings.

Silent Mode Menu

You have the option of activating the camera's Silent mode to disable all of the sound effects that the camera emits when performing camera functions.

Note: *In some versions of this camera the Self-Timer countdown will emit sounds even when the Silent mode is on.*

1. Press the **SET** button to open the menus for the current mode.
2. Press the **LEFT** or **RIGHT** direction control buttons to scroll and select the Silent Mode menu.
3. Press the **UP** or **DOWN** direction control buttons to highlight the desired menu option.
4. Press the **SET** button to select and save the desired option.
5. A  selected option icon will appear on the selected item.
6. Press the **LEFT** or **RIGHT** button to select the next menu item.
7. Press the **MODE** button to exit the menu and return to your previous mode.
8. Remember that this setting will be saved by your camera until you manually change the setting or restore the camera's default factory settings.

Auto Power Off Menu

You can use the Auto Power Off feature in order to conserve your camera's battery life. The designated time represents when your camera will automatically power off.

When the camera sits idle for the designated period of time, the camera will shut off completely and will need to be powered on again with the power button before the next use.

1. Press the **SET** button to open the menus for the current mode.
2. Press the **LEFT** or **RIGHT** direction control buttons to scroll and select the Auto Power Off menu.
3. Press the **UP** or **DOWN** direction control buttons to highlight the desired menu option.
4. Press the **SET** button to select and save the desired option.
5. A  selected option icon will appear on the selected item.
6. Press the **LEFT** or **RIGHT** button to select the next menu item.
7. Press the **MODE** button to exit the menu and return to your previous mode.
8. Remember that this setting will be saved by your camera until you manually change the setting or restore the camera's default factory settings.

Frequency Menu^{HZ}

The options in the Frequency menu represent the frequency of the electrical current in fluorescent lighting sources in your locale. If your camera is set to a frequency that does not match your country's electric current, you may see waves on the images taken by your camera.

50Hz – UK, Europe and Australia

60Hz – US, Canada and South America

1. Press the **SET** button to open the menus for the current mode.
2. Press the **LEFT** or **RIGHT** direction control buttons to scroll and select the Frequency menu.
3. Press the **UP** or **DOWN** direction control buttons to highlight the desired menu option.
4. Press the **SET** button to select and save the desired option.
5. A  selected option icon will appear on the selected item.
6. Press the **LEFT** or **RIGHT** button to select the next menu item.
7. Press the **MODE** button to exit the menu and return to your previous mode.
8. Remember that this setting will be saved by your camera until you manually change the setting or restore the camera's default factory settings.

Format Memory Card Menu

You can use the Format Memory Card menu to delete all of the content that is currently on your camera's memory card.

Keep in mind that formatting the memory card will permanently delete all of the content on your camera's memory card.

This option can only delete all of the content at one time. If you would like to delete individual images, use the Delete menu in the camera's Playback mode.

1. Press the **SET** button to open the menus for the current mode.
2. Press the **LEFT** or **RIGHT** direction control buttons to scroll and select the Format Memory Card menu.
3. Press the **UP** or **DOWN** direction control buttons to highlight the desired menu option.
4. Press the **MODE** button to exit the menu and return to your previous mode.
5. To Format the Memory Card:
 - If you would like to proceed with the format, select 'Yes' and press the **SET** button to confirm.
 - The memory card will be completely formatted.
 - You will automatically exit the menu and return to the previous mode.
6. To Exit the Format Memory Card Menu:
 - If you would like to exit the format without formatting the memory card, select 'Cancel' and press the **SET** button.
 - You will automatically exit the menu and return to the previous mode.

Firmware (Factory Default Settings) Menu

Use this menu to view the Firmware version on your camera or to reset your camera settings to the Factory Default Settings.

1. Press the **SET** button to open the menus for the current mode.
2. Press the **LEFT** or **RIGHT** direction control buttons to scroll and select the Firmware menu.
3. Press the **MODE** button to exit the menu and return to your previous mode.
4. To RESET the digital video recorder's settings to the Factory Default Settings, press the **SET** button to select 'Default Setting'.

- If you would like to proceed with the reset, select 'Yes' and press the **SET** button to confirm.

The settings will be reset.

You will automatically exit the menu and return to the previous mode with the digital video recorder settings set to the Factory Default Settings.

- If you would like to exit the format, select 'Cancel' and press the **SET** button.
You will automatically exit the menu and return to the previous mode.

Note: After *RESETTING* to the Factory settings and turning your digital video recorder off then on again, you will be prompted to select a system Language and *ViviLink* for Videos and Photos.

Photo Playback Mode

When you first turn on the camera, the camera will be in Video Capture mode by default. Press the **MODE** button twice to open the Playback Mode. The Playback mode will allow you to review and edit photos and videos that you've already taken with your camera.

Viewing Photos on Your Digital Video Recorder

1. Select your Photo:
 - Once in Playback mode, press **LEFT** or **RIGHT** direction buttons to scroll through the images on your digital video recorder's memory card until you find the image you would like to view.
 - Each captured image (videos and photos) will display on the LCD screen.
 - Photos will appear with a **JPG** icon on the top left of the LCD screen.
2. Zooming In/Out of your selected Photo:
 - Press the **T / Zoom In** button to Zoom In and magnify the selected photo.
Use the **UP / DOWN / LEFT / RIGHT** direction buttons to navigate around the photo.
 - Press the **W/Zoom Out** button to Zoom Out of the selected photo.
Use the **UP / DOWN / LEFT / RIGHT** direction buttons to navigate around the photo.

Thumbnail View

Use the **W/Zoom Out** button to display the images on your camera in Thumbnail View.

The images (videos and photos) on your camera will be displayed in a 3 X 3 matrix where you can scroll and select images from the thumbnails.





1. Press the **W/Zoom Out** button.

All the images on your camera will appear in the Thumbnail View.

2. Use the **UP / DOWN / LEFT / RIGHT** direction buttons to scroll and select the image you wish to view.
3. Press the **SET** or **Shutter** button to enlarge the image full size.

Photo Playback Mode Quick Function Buttons

Your digital camera has a four-directional pad that functions as Quick Function buttons.

Button	Function
 Left	<ol style="list-style-type: none">1. Displays the PREVIOUS image2. Navigates in the Thumbnail View
 Up	<ol style="list-style-type: none">1. Views all the Photos as a Slide Show with 3, 5 or 10 second intervals2. Navigates in the Thumbnail View
 Right	<ol style="list-style-type: none">1. Displays the NEXT image2. DELETE: Holding the button down for 3 seconds opens the Delete Menu for the selected image (and for all images).3. Navigates in the Thumbnail View
 Down	<ol style="list-style-type: none">1.  Opens the ViviLink for Photos menu2. Navigates in the Thumbnail View

Other:

W/Zoom Out	Opens the Thumbnail View
-------------------	---------------------------------

Photo Playback Mode Menus

The following are the menus that appear in your camera's Photo Playback Mode:

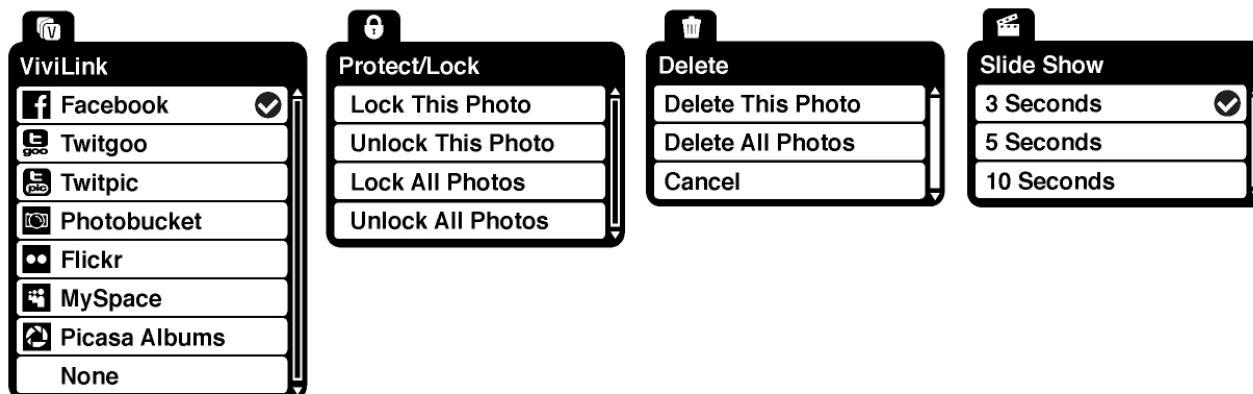

Note: The order of the menus may vary.

ViviLink Menu

The ViviLink technology allows you to quickly and easily upload your camera's photos and videos to the social networks of your choice with the accompanying Vivitar Experience Image Manager application.

1. Press the **SET** button to open the menus for the current mode.
2. Press the **LEFT** or **RIGHT** direction control buttons to scroll and select the ViviLink menu.
3. Press the **UP** or **DOWN** direction control buttons to highlight the desired menu option.
4. Press the **SET** button to select and save the desired option.
5. A  selected option icon will appear on the selected item.
6. An icon will appear on the image with the selected ViviLink destination site when you return to the Playback display.
7. Changing the ViviLink destination site will also make the selected site the new default ViviLink option. A new default can be selected at any time through this menu.
8. Press the **LEFT** or **RIGHT** button to select the next menu item.
9. Press the **MODE** button to exit the menu and return to your previous mode.
10. Remember: The ViviLink menu can also be accessed simply by pushing the **Down** Quick Function Button.

Protect/Lock Menu

Pictures and Videos taken with your camera can be protected or “locked” to prevent any deletion or alteration being made to the files.

1. Press the **SET** button to open the menus for the current mode.
2. Press the **LEFT** or **RIGHT** direction control buttons to scroll and select the Protect/Lock menu.
3. Press the **UP** or **DOWN** direction control buttons to highlight the desired menu option.
4. Press the **SET** button to select and save the desired option.
5. Press the **LEFT** or **RIGHT** button to select the next menu item.
6. Press the **MODE** button to exit the menu and return to your previous mode.
7. Any image that is locked will display a lock symbol on the LCD screen when viewing that image in the Playback mode. Photos that are not locked will not display the lock symbol.
8. Remember that you cannot delete or edit photos while they are locked.

Delete Menu

While in the Playback Mode, you can delete pictures from your camera through the Delete menu.

1. View the image you would like to delete.
2. Press the **SET** button to open the menus for the current mode.
3. Press the **LEFT** or **RIGHT** direction control buttons to scroll and select the Delete menu.
4. Press the **UP** or **DOWN** direction control buttons to highlight the desired menu option.
5. To delete the selected photo, select “Delete This Photo” and press **SET** button.
 - If you would like to proceed with deleting the current image: select ‘Yes’ and press the **SET** button to confirm. The photo will be deleted and you will exit the menu and return to the Playback mode.
 - If you do not want to delete the current image, select ‘Cancel’ and press the **SET** button. The photo will not be deleted and you will exit the menu and return to the Playback mode.
6. To delete all the images (videos and photos) you have saved on your SD Memory card, select ‘Delete All Images’ and press the **SET** button.
 - If you would like to proceed with deleting all the videos and photos, select ‘Yes’ and press the **SET** button to confirm.

All of your images will be permanently deleted.

A blank 'No Files Exist' screen will appear.

Press the **MODE** button to exit the 'No Files Exist' screen and return to Video Capture mode.

Remember: *All your images will be deleted except images that are Protected/Locked. To delete a locked image, first unlock the image, then select delete.*

- If you do not want to delete all of your videos and photos, select 'Cancel' and press the **SET** button. All images will remain on your SD card and you will exit the menu and return to the Playback mode.

Remember: *The Delete menu can also be accessed simply by pushing and holding down the **Right Quick Function Button** for 3 seconds.*

Slide Show Menu

The Slideshow menu allows you to set the interval length of time that each picture will display during the slide show.

1. Press the **SET** button to open the menus for the current mode.
2. Press the **LEFT** or **RIGHT** direction control buttons to scroll and select the Slide Show menu.
3. Press the **UP** or **DOWN** direction control buttons to highlight the desired menu option.
4. Press the **SET** button to select and save the desired option.
5. A  selected option icon will appear on the selected item.
6. Press the **LEFT** or **RIGHT** button to select the next menu item.
7. Press the **MODE** button to exit the menu and return to your previous mode.
8. Press any button to exit the slide show and return to the previous mode.

Remember: *You can view a Slide Show of all the pictures taken with your camera by pressing the **UP Quick Function button** while in the Photo Playback mode.*

Connecting the Camera to a TV

The camera has an AV port to use your larger TV screen in place of the camera's LCD screen.

On plugging the TV Cable (supplied) to the camera's AV slot and to the TV, the LCD screen turns blank. Use the digital video recorder as you would to capture and playback photos and videos. The images will appear on the TV instead of on the LCD screen.

Note: *The only limitation of using the TV screen is that the camera is now not portable.*

1. Connect the camera to a TV with the TV cable (supplied).
Connect the black jack into the camera's AV slot.
Connect the yellow jack into the TV – Video port.
Connect the white jack into the TV – Audio port.
2. Turn On the TV and the camera, and then set the TV to "AV" mode.
3. You will need to set the TV format on the camera to suit the TV format of your TV set.
4. Make sure the camera is set to the correct TV Output setting. On plugging in the TV out cable a message will appear on the LCD screen to select NTSC or PAL for the type of TV you are using.
5. Select the option as per the format (NTSC or PAL) of the TV set you are using and press the **SET** button.
6. When the camera is set to Video or Photo capture mode, you can preview the subjects you want to record on the TV screen and view the recording on the TV.
7. When the camera is set to Playback mode, you can review all the stored photos and videos on the TV.
8. To view images in Playback Mode, push the **Left** or **Right** button to select the image file to view. To play a selected Video, press the **Shutter** button.

Connecting the Camera to a Headset

The camera has an AV port that is also used as a headset port. Plug your headset or speaker system into the port to listen to the video sound track.

1. Connect the headphone jack to the AV port of the camera.
2. A 'Connect to Device' menu will appear on the LCD.
3. Press the **Up** or **Down** buttons to select the **Headset** option.
4. When the camera is set to Playback mode, you can hear the sound track of the videos through the headset.

Installing the Software

You must be connected to the internet to install and run the Vivitar Experience Image Manager software.

1. Insert the installation CD into your CD-ROM drive. The installation screen should automatically open.



2. On PC: The Vivitar Experience Image Manager Installer window appears. If the window does not appear, open the application's CD/DVD drive and click on "Setup.exe" to launch the installer.
3. On Macintosh: Click the icon that appears on the desktop to install the Vivitar Experience Image Manager.
4. If you do not have internet access at the time of inserting the CD-ROM, connect to the internet and then click the "Install Vivitar Experience Image Manager" button to begin the installation.



Note: If you do not have internet access, you can still download media from the camera. Click the "How to transfer photos and videos from my camera to my computer" button for instructions.

5. If you have internet access, the “Choose your language” window opens, choose your language and click “Next” to open the next window.
6. Select your camera model from the list and click “Next” to open the next window.
7. Click “Next” to confirm your camera model selection and to install the application.
8. Please wait while the application is being installed on your computer.
9. Please review the license terms.
On PC and Macintosh: Click the “I accept the terms of this license agreement” and then click “Next” to continue.
10. On PC only: Let the “Vivitar Experience Image Manager” installer create the folder to where the program will be installed, and then click “Install”.
11. Please wait while the application continues the installation process on your computer.
12. On PC: Click the “Close” button when the installation is complete.
Click the “Launch Vivitar Experience Image Manager” to open the application.
13. On Macintosh: Click the “Quit” button when the installation is complete.
Click the “Launch Vivitar Experience Image Manager” to open the application.
14. If you close the application you can run the Vivitar Experience Image Manager from the Programs (PC) or Applications (Mac) menu on your computer.



Connecting the Camera to the Computer

1. Use the USB cable that came with your camera to connect your camera to your computer.
2. Power the camera ON.
3. The first time you connect the device to the computer you will have to wait a few seconds until the computer recognizes the device.

Getting Photos and Videos from your Camera to Your Computer

An SD card needs to be inserted. Do not disconnect the cable during transfer. Doing so will cancel the transfer of any files on their way to your computer.

1. Select the “Get Images” button from the Main menu.



2. The “Get Images from device” window opens.
3. You can select to download photos, videos or both.
4. Select your camera (removable disk) from the device window. If your camera is the only USB device connected then it will be selected automatically.
5. Select a location on the computer where to place the new photo and video files.
6. Add the new photo and video files to albums if desired.
7. Select to remove the media files from the selected device (removable disk) after the import.
8. Click the “Get Images” button to transfer the photos and videos from your camera to your computer.
9. A media download progress bar appears on the bottom left showing the number of media files downloading to your computer. A message appears when the download is complete.
10. The photo and video files that you selected are now downloaded to your computer to the selected folder and albums ready for your use.

Get started!

Using the Vivitar Experience Image Manager, you can:

- Upload and manage photos and videos to and from the most popular photo sharing and social networking sites - Facebook, Flickr, Picasa, MySpace, Photobucket, Twitpic, Twitgoo and YouTube
- Seamlessly transfer photos and videos from one social network to another
- Organize your images by creating offline and online albums
- Edit images using automatic and manual tools
- Use automatic “Geotagging” with built in Google Maps

For more details on how to use the Vivitar Experience Image Manager open the Help file or click the “Take the Tour” button on the application`s Home page.

Transfer media from my camera to my computer manually (Using Windows)

1. Use the USB cable that came with your camera to connect your camera to your computer.
2. MSDC appears on the LCD.
3. A window appears with a list of options, select “Open folder to view files” and click OK.
4. Open the DCIM folder and the folder inside to view the media files.
5. Select the media and copy the files from this folder into your computer. Optionally, select the files and choose Copy from the Edit menu. Then select a folder and choose Paste from the Edit menu.
6. We recommend that you copy the images into the Pictures/My Pictures folder and the videos into the Videos/My Videos folder.
7. Do not disconnect the cable during transfer. Doing so will cancel the transfer of any files on their way to your computer.

Transfer media from my camera to my computer manually (Using Macintosh)

1. Use the USB cable that came with your camera to connect your camera to your computer.
2. MSDC appears on the LCD.
3. The camera's device icon appears on the desktop.
4. Click on the device icon and open the DCIM folder and the folder inside to view the media files.
5. Select the files and drag them into your computer. Optionally, select the files and choose Copy from the Finder's Edit menu. Then select a folder and choose Paste from the Edit menu.
6. We recommend that you copy the images into the Pictures folder and the videos into the Movies folder.
7. Do not disconnect the cable during transfer. Doing so will cancel the transfer of any files on their way to your computer.

Camera Maintenance

The digital camera is a delicate device. Please handle your camera with care to avoid damaging it.

Do not expose your camera to heat sources.

Do not use you camera in wet or moist conditions.

Sakar Warranty Card

This warranty covers for the original consumer purchaser only and is not transferable. Products that fail to function properly **UNDER NORMAL USAGE**, due to defects in material or workmanship will be repaired at no charge for parts or labor for a period of one year from the time of purchase.

What Is Not Covered By Warranty:

Damages or malfunctions not resulting from defects in material or workmanship and damages or malfunctions from other than normal use, including but limited to, repair by unauthorized parties, tampering, modification or accident.

What to Do When Service Is Required:

When returning your defective product (postage pre-paid) for service, your package should include:

1. Copy of **original** bill of sale
2. A detailed written description of the problem.
3. Your return address and telephone number (Daytime)

MAIL TO ADDRESS BELOW:

<u>Sakar US</u>	<u>Sakar UK/Europe</u>	<u>Sakar Australia</u>
Sakar International Attention: Service Department 195 Carter Drive Edison, NJ 08817	Attention: Service Department 2D, Siskin Parkway East 4020 Middlemarch Business Park Coventry, CV3 4PE	Return faulty camera to the Refund Counter at the store where purchased

Technical Support

For technical support issues please visit our website at **www.vivitar.com**. You can find manuals, software and FAQ's at the website. Can't find what you are looking for? E-mail us at **support@vivitar.com** and one of our technical support team members will answer your questions. For phone support in the US please call 1-800-592-9541, in the UK call 0800 917 4831, in Australia call 1800-006-614. If you would like to call from anywhere else, please visit **www.vivitar.com** for your local toll free number.

Troubleshooting

Q: I have taken photos and selected the "Get Images" button. I get a message that the images were successfully transferred but the photos do not appear on my computer.

What do I do?

First ensure that you have in fact taken photos. Press the Shutter button to take some sample photos and then try downloading them again.

With test photos if the camera powers off before you upload them to the computer the photos are not stored in the camera's memory. These photos should be uploaded quickly before the camera powers off. If the photos are saved to the SD memory card then all the photos should appear.

Q: How do I make sure I don't lose important pictures?

This camera requires an SD card for normal use. If the camera powers off nothing will happen to the images stored on the SD memory card. We recommend always downloading your photos to your computer as soon as possible to prevent unintentional data loss.

Q: I deleted images using the Vivitar Experience Image Manager. The images were also deleted from my computer. How do I recover images that I accidentally deleted?

All images deleted using the Vivitar Experience Image Manager are sent to your computer's Recycle or Trash Bin and can be retrieved from there.

Free Manuals Download Website

<http://myh66.com>

<http://usermanuals.us>

<http://www.somanuals.com>

<http://www.4manuals.cc>

<http://www.manual-lib.com>

<http://www.404manual.com>

<http://www.luxmanual.com>

<http://aubethermostatmanual.com>

Golf course search by state

<http://golfingnear.com>

Email search by domain

<http://emailbydomain.com>

Auto manuals search

<http://auto.somanuals.com>

TV manuals search

<http://tv.somanuals.com>