



# VBrick EtherneTV Portal Server

---

## EtherneTV v4.4 Portal Server Admin Guide



January 15, 2009  
4410-0118-0009

---

## Copyright

© 2009 VBrick Systems, Inc. All rights reserved.  
12 Beaumont Road  
Wallingford, Connecticut 06492, USA  
[www.VBrick.com](http://www.VBrick.com)

This publication contains confidential, proprietary, and trade secret information. No part of this document may be copied, photocopied, reproduced, translated, or reduced to any machine-readable or electronic format without prior written permission from VBrick. Information in this document is subject to change without notice and VBrick Systems assumes no responsibility or liability for any errors or inaccuracies. VBrick, VBrick Systems, the VBrick logo, StreamPlayer, and StreamPlayer Plus are trademarks or registered trademarks in the United States and other countries. Windows Media is a trademarked name of Microsoft Corporation in the United States and other countries. All other products or services mentioned in this document are identified by the trademarks, service marks, or product names as designated by the companies who market those products. Inquiries should be made directly to those companies. This document may also have links to third-party web pages that are beyond the control of VBrick. The presence of such links does not imply that VBrick endorses or recommends the content of any third-party web pages. VBrick acknowledges the use of third-party open source software and licenses in some VBrick products. This freely available source code is posted at <http://www.vbrick.com/opensource>.

## About VBrick Systems

Founded in 1997, VBrick Systems, an ISO 9001 certified vendor, is a privately held company that has enjoyed rapid growth by helping our customers successfully introduce mission critical video applications across their enterprise networks. Since our founding, VBrick has been setting the standard for quality, performance and innovation in the delivery of live and stored video over IP networks—LANs, WANs and the Internet. With thousands of video appliances installed world-wide, VBrick is the recognized leader in reliable, high-performance, easy-to-use networked video solutions.

VBrick is an active participant in the development of industry standards and continues to play an influential role in the Internet Streaming Media Alliance (ISMA), the MPEG Industry Forum, and Internet2. In 1998 VBrick invented and shipped the world's first MPEG Video Network Appliance designed to provide affordable DVD-quality video across the network. Since then, VBrick's video solutions have grown to include Video on Demand, Management, Security and Access Control, Scheduling, and Rich Media Integration. VBrick solutions are successfully supporting a broad variety of applications including distance learning and training, conferencing and remote office communications, security, process monitoring, traffic monitoring, business and news feeds to the desktop, webcasting, corporate communications, collaboration, command and control, and telemedicine. VBrick serves customers in education, government, healthcare, and financial services markets among others.

---

# Contents

## Portal Server v4.4 Admin Guide

Organization .....	ix
Getting Help .....	x
Font Conventions .....	xi
Related Documents .....	xi
Printer-Friendly .....	xi

### 1. Introduction

Portal Server Overview .....	1
Server Requirements .....	2
Desktop Requirements .....	2
Copyright Protection .....	3
MySQL .....	4
Portal Server Features .....	4
End User Features .....	4
Administrative Features .....	5
Portal Server Components .....	6
VBrick Encoders/Decoders .....	6
ETV VOD Servers .....	6
ETV IP Receiver .....	8
ETV Network Video Recorder .....	8
VB-PC Remote Controller .....	9
Amino Set Top Box .....	10
WM IP Receiver .....	10
Portal Server Installation .....	10
Downloading Components .....	10
Decoder Closed Captioning Support .....	13
Port Requirements .....	13
Installing Serial Numbers and License Files .....	15
Admin Console Login .....	17
Admin Console Options .....	18
Internet Explorer 7.0 Configuration .....	20

### 2. Global Settings

Global Assignments .....	21
Custom Fields .....	28
Stream Restrictions .....	29
Servers .....	30
Adding VOD Servers .....	31
Adding FTP Servers .....	36
Adding File Servers .....	37
Add/Modify Video On Demand Content Folders .....	41

VBricks . . . . .	43
VBrick Configuration . . . . .	43
Advanced Settings . . . . .	45
Multimedia VBrick Configuration . . . . .	46
Control Devices . . . . .	47
Adding Control Devices . . . . .	48
Adding User-Defined VBIRs . . . . .	50
Connecting Control Devices . . . . .	51
Configuring Control Devices . . . . .	52
Updating the VBIR Command Set . . . . .	53
IP Receivers . . . . .	53
Recorders . . . . .	55
Synchronizing the Portal Server and the NVR . . . . .	57
Script Devices . . . . .	57
Scripts . . . . .	59
Creating a Script . . . . .	59
Finding VBrick Parameters and Values . . . . .	61
URLs . . . . .	62
Add/Modify a URL for a Live Video Stream . . . . .	62
Add VOD Content . . . . .	64
Add Non-VOD Content . . . . .	65
Priority Alert . . . . .	66
Program Names . . . . .	70
Manage Playlists . . . . .	71
Access Logging . . . . .	72
Extended Logging Properties . . . . .	73
Using EthernetTV Reporter . . . . .	74
Using an Excel Spreadsheet . . . . .	74
Zones . . . . .	75

### 3. Server Administration

Channels . . . . .	77
Channel Guide . . . . .	77
Stations . . . . .	79
Custom Programs . . . . .	83
Modify VOD Content . . . . .	85
Purchased Content Expiration . . . . .	85
Diagnostics . . . . .	87
Status . . . . .	88
Expired Content Log . . . . .	89
Access Control . . . . .	89
Use LDAP Database . . . . .	90
Using LDAP with Single Sign-On . . . . .	93
Using LDAP with SSL . . . . .	94
Use RSA Authentication . . . . .	96
Live Presentations . . . . .	98

Users .....	99
User Groups.....	99
Resource Groups .....	99
Help .....	99
About.....	100
Logout .....	101

## 4. Users and User Groups

Overview .....	103
User-Related Definitions .....	103
Configuring Users and User Groups .....	104
1. Setup and Configure ETV Components .....	104
2. Choose an Authentication Method .....	105
3. Create User Groups on the Portal Server .....	106
4. Create Resource Groups on the Portal Server .....	106
5. Create Users on the ETV Portal Server .....	107
6. Assign Resources to Users or User Groups .....	107
Configuring Users .....	107
Add/Modify User Information.....	109
Add/Modify User's Group Assignments .....	110
Add/Modify User's Resource Group Assignments .....	110
Add/Modify Live Channel Privileges .....	110
Add/Modify Live Program Privileges.....	110
Allow Access to Specific FTP Servers .....	110
Allow Access to Specific Recorder Servers.....	110
Allow Access to Specific VOD Servers .....	111
Allow Access to Specific VOD Content.....	111
Allow Viewing by Content Type.....	111
Allow Content Publishing.....	111
Allow Content Recording .....	112
Default Content Recording.....	112
Allow VBrick Access.....	112
IPR Access .....	112
Schedule Privileges .....	112
Priority Alert Privileges.....	112
Copyright Restrictions & Expiration Privileges .....	113
Content Edit Permissions .....	113
Configuring User Groups .....	113
Add/Modify Group Information .....	113
Add/Modify Group's User Assignments .....	114
Add/Modify Group's Resource Assignments.....	114
Resource Groups .....	114
Add/Modify Resource Group Information .....	115
Add/Modify User's Resource Assignments .....	115
Add/Modify Group's Resource Assignments.....	115
IPR Authentication .....	116

Authentication by PIN .....	116
Authentication by Host Name or IP Address .....	117

## 5. Configuring for SSL

Overview .....	119
SSL Prerequisites .....	120
1. Generate a Certificate Request .....	120
2. Submit a Certificate Request .....	121
3. Install the Certificate .....	121
4. Configure ETV Resources for SSL .....	121
Configuring Hardened SSL .....	122
Configuring Non-Hardened SSL .....	124

## 6. Network Video Recording

NVR Overview .....	127
NVR Hardware .....	128
NVR Performance Considerations .....	129
NVR Types .....	129
Standard NVR .....	129
Standalone NVR .....	129
NVR Installation .....	130
Synchronizing the Portal Server and the NVR .....	130
NVR Configuration .....	130
Configuring a Standard NVR .....	130
Configuring a Standalone NVR .....	131
Using an NVR .....	131

## 7. VBPresenter

Overview .....	133
Working with Presentations .....	134
Configuring MCS for VBPresenter .....	134
Configuring an MCS FTP User Account .....	134
Configuring an MCS Presentation User .....	135
Configuring for Live Presentations .....	135
Configuring for Stored Presentations .....	137

## 8. Auto Content Ingestion

AutoIngest Content .....	139
AutoIngest Content via XML .....	141
AutoIngestXML Modes .....	142
Using the XML Template .....	142
Removing MPEG-4 Closed Captions .....	144

## 9. EtherneTV Backup

Overview .....	145
----------------	-----

ETV Backup Profiles . . . . .	146
Configuring ETV Backup . . . . .	147
1. Enter License Key . . . . .	147
2. Set Profile IP Addresses . . . . .	147
3. Configure the Scheduler . . . . .	148
4. Reset Database Backup Versioning . . . . .	149
5. Enable the Warm Backup Server. . . . .	149
6. Test the Configuration . . . . .	150
Turning a Warm Backup Server into a Live Server . . . . .	152
Bringing a Failed Machine Back Online. . . . .	153
Bringing a Failed Machine Back Online as a Warm Backup . . . . .	153
Bringing a Failed Machine Back Online as a Primary Server . . . . .	153
Software Installation . . . . .	154
<b>10. Amino Set Top Box</b>	
Overview . . . . .	155
Connecting the Amino. . . . .	155
Configuring the Amino . . . . .	156
Changing the IP Address . . . . .	157
Configuring a Direct Connection . . . . .	158
Configuring the Remote Control for a TV . . . . .	158
Configuring the Amino for a Widescreen . . . . .	158
Setting the TV Display Format . . . . .	159
<b>11. ACNS Configuration</b>	
Overview . . . . .	161
ACNS Configuration . . . . .	161
VOD-W Server Configuration . . . . .	161
Portal Server Configuration . . . . .	162
ACNS Server Configuration . . . . .	163
Verify Installation. . . . .	164
<b>12. Rebranding the User Interface</b>	
Customizing the Portal Server . . . . .	165
Changing the Title and Header Image . . . . .	165
Rebranding the Portal Server . . . . .	166
Portal Server . . . . .	166
Rebranding Other ETV Components . . . . .	169
VBrick IP Receiver . . . . .	169
Amino Set Top Box . . . . .	170
VBrick IP Receiver . . . . .	170
<b>13. NXG-to-VOD-W Content Migration</b>	
Creating an Asset List . . . . .	171
Sample Asset List . . . . .	172

---

Using the Migration Tool.....	172
Increasing the Ingestion Rate.....	172
Running the Migration Tool.....	173
Recovering from Migration Errors.....	175
Verifying the Migration.....	175
<b>14. Purchased Content Ingestion</b>	
Overview.....	177
Configuring IIS.....	177
Ingesting Content.....	179
Configuring a VOD-W Server.....	179
Ingesting Purchased Content.....	180
Backing Up the Database.....	181
<b>15. Manual System Backup</b>	
System Backup.....	183
System Restore.....	184
<b>16. VBrick Internet Streaming</b>	
Overview.....	185
Streaming Service Workflow.....	185
Portal Server Hosting.....	186
VBrick Configuration.....	186
Portal Server Configuration.....	187



---

# Portal Server v4.4 Admin Guide

This *Portal Server Admin Guide* is written for anyone who will be using or evaluating the VBrick EtherneTV Portal Server. This includes system administrators, software developers, network technicians, and others. The ETV Portal Server is a web-based portal for accessing and managing video assets including both live or stored audio and video files. The ETV Portal Server is a key component in VBrick's EtherneTV Media Distribution System. The ETV Portal Server provides a simple, intuitive interface that auto-discovers available media assets in your network. Key components in VBrick's EtherneTV solution include:

- EtherneTV-VOD Video-on-Demand Servers – Provide all standard Video-on-Demand (VOD) features including support for MPEG, Windows Media, and H.264 for maximum flexibility.
- VBrick Hardware Encoders/Decoders – Rugged, reliable video appliances that can reside anywhere on your network to provide either distributed or high-density centralized encoding/decoding of MPEG-1, MPEG-2, MPEG-4, WM (Windows Media), and H.264 video.
- EtherneTV IP Receivers – Leading-edge digital set top boxes that provide a low-cost standalone decoder for MPEG, Windows Media, and H.264 video assets.

---

**Note** The Amino STB is a compact set top box that plays MPEG-2 streams only. It is fully integrated with the Portal Server and provides access to *most* Portal Server viewer functionality. *It does not, however, support* Access Logging, Scheduling, Device Control, Emergency Broadcast, or Copyright Restrictions.

---

## Organization

<u>Introduction</u>	provides an overview of the application including server and desktop requirements and an overview of features and functionality.
<u>Global Settings</u>	explains high-level configuration settings and parameters that apply to the entire system.
<u>Server Administration</u>	provides detailed explanations of all ETV Portal Server global settings and configuration options, as well as diagnostics and status windows.
<u>Users and User Groups</u>	explains how to configure the system for access control. It explains how to create users and groups with specific permissions and access to resources.
<u>Configuring for SSL</u>	explains how to securely configure the system using the Secure Sockets Layer.
<u>Network Video Recording</u>	explains how to configure and use an NVR to offload recording tasks from the Portal Server to a separate "recorder server" machine.

<a href="#"><u>VBPresenter</u></a>	explains how to configure and launch rich media presentation from the Portal Server including those created with VBPresenter.
<a href="#"><u>Auto Content Ingestion</u></a>	explains auto content ingestion. This is the process whereby video content is automatically populated on the portal server.
<a href="#"><u>EtherneTV Backup</u></a>	explains how to automatically backup the MySQL database and other key directories if you purchased EtherneTV Backup.
<a href="#"><u>Amino Set Top Box</u></a>	explains how to connect and use the Amino set top box to view MPEG-2 streams.
<a href="#"><u>ACNS Configuration</u></a>	explains how to configure the Portal Server and Cisco's Application and Content Networking System (ACNS) to work together.
<a href="#"><u>Rebranding the User Interface</u></a>	explains how to modify the Portal Server "user" interface. You can simply replace images or you can modify the .css stylesheets and thoroughly rebrand the look-and-feel of the application.
<a href="#"><u>NXG-to-VOD-W Content Migration</u></a>	explains how to migrate MPEG-1 and MPEG-2 video files from a VBrick NXG (Linux) VOD server to a VBrick VOD-W (Windows) VOD server.
<a href="#"><u>Purchased Content Ingestion</u></a>	explains how to mass ingest separately purchased video content to any or all configured VOD servers.
<a href="#"><u>Manual System Backup</u></a>	explains how to manually backup the MySQL database and other key directories if you did not purchase EtherneTV Backup.
<a href="#"><u>VBrick Internet Streaming</u></a>	The VBrick Streaming Service is available for those users who wish to extend the ability to view live events to Internet clients.

## Getting Help

**If you need help, or more information about any topic, use the online help system.** The online help is cross-referenced and searchable and can usually find the information in a few seconds. Use the tree controls in the left pane to open documents and the up and down arrows to page through them. Use the **Search** box to find specific information. Simply enter one or more words in the box and press Enter. The search results will return pages that have all of the words you entered—highlighted in yellow (Internet Explorer only). The **Search** box is not case-sensitive and does not recognize articles (a, an, the), operators (+ and -), or quotation marks. You can narrow the search by *adding* words.

If you can't find the information you need from the online help, or from your certified VBrick reseller, you can contact VBrick [Support Services](#) on the web. Support Services can usually answer your technical questions in 24 business hours or less. Also note that our publications team is committed to accurate and reliable documentation and we appreciate your feedback. If you find errors or omissions in any of our documents, please send e-mail to [documentation@vbrick.com](mailto:documentation@vbrick.com) and let us know. For more information about any VBrick

---

products, all of our product documentation is available on the web. Go to [www.vbrick.com/documentation](http://www.vbrick.com/documentation) to search or download VBrick product documentation.

## Font Conventions

**Arial bold** is used to describe dialog boxes and menu choices, for example: **Start > All Programs > VBrick**

`Courier fixed-width font` is used for scripts, code examples, or keyboard commands.

**Courier bold fixed-width font** is used for user input in scripts, code examples, or keyboard commands.

**This bold black font** is used to strongly emphasise important words or phrases.

Folder names and user examples in text are displayed in this sans serif font.

**User input in text** is displayed in this bold sans serif font.

*Italics are used in text* to emphasize specific words or phrases.

## Related Documents

[ETV Portal Server User Guide](#)

[ETV Reporter User Guide](#)

[IPR Receiver Admin Guide](#)

[STB Admin Guide](#)

[STB Quick Start Guide](#)

[NXG Server Quick Start Guide](#)

[VOD-W Server Admin Guide](#)

[VOD-WM Server Admin Guide](#)

[VBPresenter User Guide](#)

## Printer-Friendly

Click on the following link to print a hard copy of the document.

[ETV Portal Server User Guide](#)

[ETV Portal Server Admin Guide](#)

[ETV Portal Server Release Notes](#)

▼ To save or print a PDF document

1. Click once to open the PDF document in Acrobat Reader.
2. To save or print a PDF document, right-click and select **Save Target As** or **Print Target**.



---

## Introduction

### Topics in this section

Portal Server Overview .....	1
Portal Server Features .....	4
Portal Server Components.....	6
Portal Server Installation .....	10
Admin Console Login .....	17

## Portal Server Overview

VBrick's EtherneTV Media Distribution System consists of a group of products that includes the EtherneTV Portal (ETV Portal Server), EtherneTV Encoders, the EtherneTV-VOD Video-on-Demand Server, EtherneTV IP Receivers and StreamPlayer software. This integrated system delivers both live and on-demand audio and video over an IP-based infrastructure. The ETV Portal Server functions as a video portal, permitting end users to view live and on-demand MPEG, WM (Windows Media), and H.264 streams on a Window PC, a Macintosh, a Linux PC (or a set top box). The ETV Portal Server comes as software-only solution that can be installed on a Windows Server or as a pre-configured hardware/software combination.

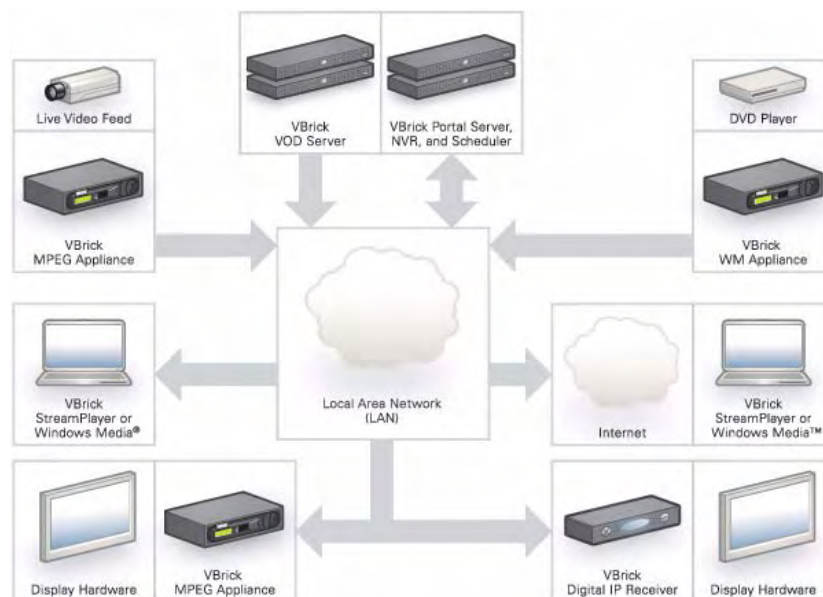

**Figure 1.** EtherneTV Media Control Server Suite

The VBrick EtherneTV (ETV) Portal Server is a web-based portal for accessing Live and On-Demand audio and video files. A key component of VBrick's EtherneTV Media Distribution System, the ETV Portal Server provides a simple interface to easily locate available media assets on your network. Upon accessing the main portal page, users can

navigate or search for specific videos, select the video, and immediately begin viewing DVD quality video. For on-demand videos, users can **Fast Forward/Rewind** and **Seek** to specific points in the video. Standard access control functionality provides restriction of certain content to particular users, user groups, or IP receivers. An optional scheduling module allows users to schedule devices to send video, receive video, record video, or to initiate a two-way conference.

## Server Requirements

The *minimum* server requirements include:

- Windows Server 2003 (Web Edition or Standard Edition with Service Pack 2).
- Pentium IV or Xeon Processor 1.26 GHz Minimum (2 GHz or higher recommended).
- RAM 512 MB Minimum (1 GB or more recommended).
- Hard Drive 36 GB Minimum (larger for frequent recording).

**Note** VBrick has tested the ETV Portal Server on Windows 2003 Server Web Edition and Standard Edition. Note also that ETV Portal Server also will not operate correctly on a server that is configured as a primary domain controller or with other network-related services and software.

## Desktop Requirements

Windows-based PC and Macintosh users access the ETV Portal Server through a web browser. For Windows-based PCs, on the first access to the server, VBrick StreamPlayer software is automatically downloaded to the PC. StreamPlayer software lets end users select a stream and view TV-quality video directly on a PC. Macintosh users view MPEG-4 video through the QuickTime player.

**Table 1.** Desktop Requirements

PC Type	Requirements
Windows PCs	<ul style="list-style-type: none"> <li>• Windows 2000, XP (Service Pack 3), or Vista.</li> <li>• 750 MHz Pentium III processor (Pentium IV required for H.264).</li> <li>• 512 MB RAM (1 GB recommended for H.264).</li> <li>• SVGA video card 1024x768, video card acceleration and 32 bit color recommended.</li> <li>• Minimum 250 MB hard disk space for installation.</li> <li>• Microsoft Internet Explorer 6.0 or higher.</li> <li>• Microsoft Windows Media Player 9.0 or higher.</li> <li>• Firefox 2.0 or higher.</li> <li>• DirectX Media Version 8.1 and higher.</li> </ul>
Macintosh PCs	<ul style="list-style-type: none"> <li>• Mac OS X 10.3 or higher for PowerPC.</li> <li>• Mac OS X 10.4 or higher for Intel-based PC.</li> <li>• Firefox for Macintosh 2.0 or higher.</li> <li>• QuickTime Player 6.0 or higher.</li> <li>• Internet Explorer on a Macintosh is not supported.</li> </ul>
Linux PCs	<ul style="list-style-type: none"> <li>• Red Hat Fedora 9.1</li> <li>• Firefox 2.0.</li> <li>• 512 MB RAM.</li> </ul>

## *Copyright Protection*

The Portal Server uses copyright restrictions and content expiration to protect the rights of content owners and to enforce rules against unauthorized usage or distribution. Copyright restrictions are specifically used to enforce license requirements. Content is often restricted to a limited number of viewers and you may need a license, for example, to view MPEG-2 content. In the Portal Server, **Max. Concurrent Viewers** is used to enforce copyright restrictions for any live, stored, or recorded video. If the number of concurrent viewers exceeds the configured value, the content will not play. (The **Max. Concurrent Users** restriction does not apply to viewers who tune in to a scheduled broadcast.)

Content expiration controls the length of time that specific content can be viewed. Content expiration is used for time-sensitive, copyrighted, or otherwise protected content that cannot be legally displayed after a specified date or a period of time. Users with appropriate permissions (see [Copyright Restrictions & Expiration Privileges](#) on page 113) can assign expiration dates or a viewing period when they use the **Add Video** feature. The viewing period starts at the time the content is added to the server. If desired, administrators can restrict expiration privileges to particular users or groups in which case only those specified users or groups (and administrators) can set content to expire.

Administrators can also assign an **Expiration Date** or **Viewing Period** for any stored video using the [Modify VOD Content](#) page. By default, recordings from live streams have no expiration date. However administrators can set default viewing periods for content recorded from specific live streams (see "Viewing Periods" in [Stream Restrictions](#) on page 29).

The ETV Portal Server enforces content expiration by preventing the streaming or scheduling of content that is expired or will expire before the scheduled event. Once content has expired, administrators can set a new expiration date or viewing period. By default, expired content will remain in storage indefinitely unless you choose to delete it automatically using the **Set Expired VOD Content Treatment** option in [Global Assignments](#).

The Portal Server writes to a log that tracks content expirations; administrators can view or purge this log as necessary (see [Expired Content Log](#) on page 89). In many installations an administrator is assigned to monitor and/or renew content that is about to expire. To facilitate this process, the Portal Server can be configured to automatically generate e-mail that notifies the designated administrator when content is about to expire by using the option in [Global Assignments](#).

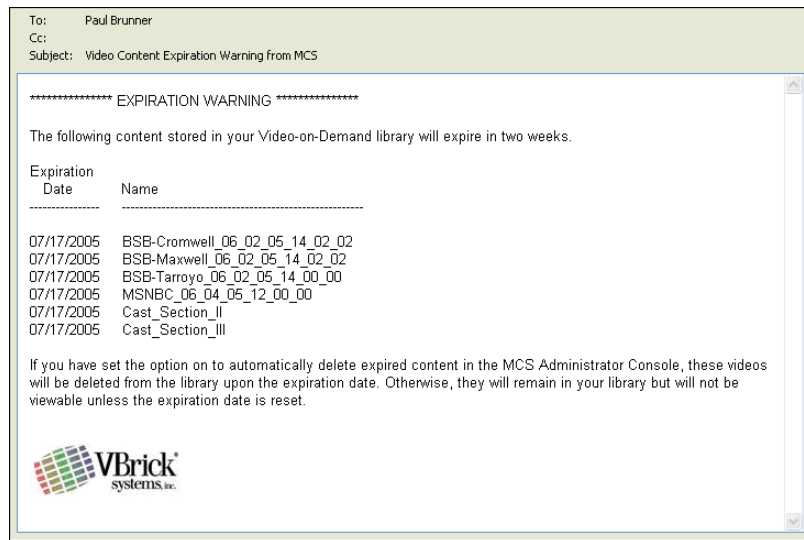

## MySQL

EtherneTV Portal Server is shipped with MySQL as the database. The MySQL database is installed as part of the Portal Server installation package. If the hardware/software combination was purchased from VBrick, MySQL will already be installed on your machine; the default user name is `root`. To protect the integrity of the database, you should change the default password (`vbrick_18`) after initial installation and periodically thereafter as explained below. To backup the MySQL database, see [EtherneTV Backup](#) on page 145.

**Note** MySQL Query Browser is an Open Source front-end that provides a graphical interface to the MySQL database. MySQL Query Browser is available with the free software/open source GNU General Public License at to <http://www.mysql.com>

- ▼ To change the MySQL password
1. Open a Command Prompt window.
  2. At the C: prompt type `cd program files\mysql\mysql server 4.1\bin` and press **Enter**.
  3. Type `mysql -uroot -pvbrick_18` and press **Enter**.
  4. Type `set password for 'root'@'localhost' = password ('new_password');` (where `'new_password'` in single quotes is the new password) and press **Enter**.
  5. Type `exit`.

## Portal Server Features

### End User Features

- Windows-based PCs, Macintoshes, or IPRs (connected to televisions or display monitors) can all access the Portal Server.
- Users can view video at **Full Screen** for a television-like user experience.
- Users can view Video-On-Demand assets with full VCR/DVD control, including **Play, Pause, Stop, Fast Forward, Rewind, and Seek**.
- Video can be viewed in a preview window or launched in multiple external, re-sizeable player windows (PC and Macintosh).



- IP Receiver users can use familiar **Channel Up/Down** keys and other hot keys on the IR remote control to navigate through video listings.
- Users can search through the list of Live or On-Demand videos by **Title**, **Keyword**, **Description**, or other custom fields defined by an ETV Portal Server administrator.
- Users can record and store videos on the EtherneTV-VOD Video-on-Demand server via ETV Portal Server.
- Users can publish pre-recorded content and thumbnails directly to the VOD server.
- Users can view closed caption text (Windows-based PCs and IP Receivers only).
- Users can launch pre-configured emergency broadcasts. (Optional. Requires Scheduling module.)
- Users can schedule recordings or broadcasts. (Optional. Requires Scheduling module.)

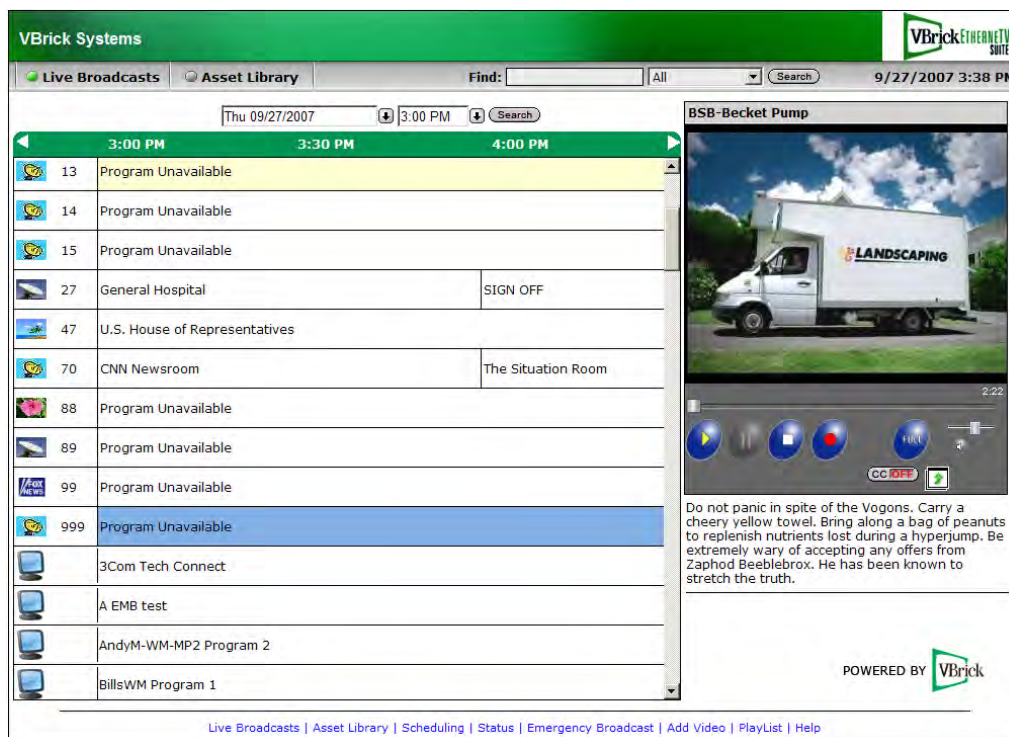

**Figure 2.** ETV Portal Server Live Broadcasts

### *Administrative Features*

- Access Control - allows administrators to allow/deny access to specific functions of the ETV Portal Server server. Access control functionality can use the local ETV Portal Server database or authenticate to an LDAP directory server.
- Clustering support – multiple EtherneTV-VOD Video-on-Demand servers can be clustered to increase total throughput. The ETV Portal Server will automatically load balance all servers defined in ETV Portal Server; no additional configuration is necessary. See [Servers](#) on page 30 for more.
- SSL/TLS security – the ETV Portal Server can be set up to provide encrypted access to the Login pages and/or the Admin pages. See [Configuring for SSL](#) on page 119.

- Customer defined URLs – can be entered into the system and displayed in the ETV Portal Server interface. The URLs can point to video assets or other assets such as PDFs or PowerPoint documents.
- Autoingestion to the EtherneTV-VOD server – content placed in autoingestion folders on the ETV Portal Server will be automatically transferred and ingested into the EtherneTV-VOD server.
- Customized global messages can display on the ETV Portal Server interface.
- Channel numbers can be assigned to live streams.
- Define a startup channel for IPRs – the IPR will automatically tune into this channel when users select the **Live TV** option.
- Emergency broadcasts – can define pre-configured emergency broadcast templates that can be launched instantaneously. See [Priority Alert](#) on page 66 for more.
- Status window – shows the status of videos being added, recorded, or ingested.
- Diagnostics window – displays a complete log of system events by source, time, and IP address.
- Custom fields and streams – the ability to add customized information and search parameters to live and stored streams.
- A Channel Guide Server can be configured to automatically provide third-party programming data for configured TV Stations.

## Portal Server Components

### *VBrick Encoders/Decoders*

VBrick's VB4000-5000-6000 Series MPEG-2 network video appliances provide DVD quality video and CD quality audio at 1–15 Mbps of bandwidth. MPEG-2 is the world's most popular digital compression technology and is used to encode DVDs as well as Digital Cable and Digital Satellite broadcasts. VBrick's VB4000-5000-6000 Series MPEG-4 encoders and decoders are versatile and reliable video appliances for one or two-way interactive communications over low or medium bandwidth IP networks. The VBrick MPEG-4 encoder/decoder can be used for webcasting, multicasting, transcoding, and two-way interactive video. Designed for streaming over the Internet at lower bit rates (56K, 128K, 384K) and over a LAN at higher rates (1Mbps and above). VBrick's WM (Windows Media) video appliances provide scalable quality at webcasting rates up to 2 Mbps. It features built-in live streaming server, automatic multicasting, and state-of-the-art reliability. A key benefit of the WM appliance is its compatibility with the Windows Media Player, thus eliminating the need for desktop player installation. VBrick H.264 appliances represent VBrick's newest networked video appliances. The new H.264 appliances can deliver vastly improved quality for a given bit rate, allowing organizations to deliver a better customer experience for any given bandwidth.

### *ETV VOD Servers*

EtherneTV Video on Demand (VOD) servers provide the ETV Portal Server with a source of available video content organized in folders. The VOD content is displayed by name in the ETV Portal Server user interface, along with the duration of the video, and associated descriptions, key words, and other custom information entered by an administrator. You play content from the VOD server by selecting the program name from the application interface (see the *Portal Server User Guide* for details). The ETV Portal Server currently supports all of

the VOD servers shown in Table 2. The configuration for each server is essentially the same (see [Servers](#) on page 30 for details) and there is little difference in functionality for end users.

ETV servers can be LAN-based or Internet-based depending on how the range of Internet addresses is defined (see "Assign LAN/Internet Address Range" in [Global Assignments](#) on page 21). VOD servers accessible to Internet users are called Internet-zone servers; VOD servers assessable to LAN users only (within a secured corporate network and behind a firewall) are called LAN-zone servers.

Content added by users in the LAN zone will be ingested to all VOD servers for which they have permissions using the **Add Video** page. Users in the Internet zone have the **Add Video** page available only if they have permissions for at least one VOD server that is also in the Internet zone. Content added by LAN users is added to all configured servers that can handle the content (for example you cannot add MPEG content to a Windows Media server) and for which you have permission. The content available for viewing may also be limited by the server type. For example, Internet users will see only MPEG-4 and Windows Media content on VOD-D and VOD-WM servers respectively. LAN users however will see all content on all servers.

**Table 2.** Supported EthernetTV VOD Servers

Server Type	Description	Zone
NXG	Linux-based NXG1/2 VOD server.	LAN only
VOD-W	Windows-based VOD-W VOD server. Available in three versions depending on throughput: VOD-50W, VOD-125W, and VOD-300W	LAN only
VOD-D	Darwin Open Source server for Linux, Windows, Mac, etc. Ingests and plays MPEG-4 content only. Requires an FTP server.	LAN or Internet
VOD-WM-Standard	Microsoft Windows Media Server (unicast only). Requires an FTP server.	LAN or Internet
VOD-WM-Enterprise	Microsoft Windows Media Server (unicast or multicast). Requires an FTP server.	LAN or Internet

### ETV Internet-Based Servers

ETV Portal Server supports the installation of LAN-based servers and Internet-based servers. As part of an ETV Server installation, you can configure a VOD server to run in the "zones" (LAN or Internet) specified in Table 2. Before server configuration, you assign a range of IP addresses that define the LAN domain, or vice versa, that define the Internet domain. Any IP address outside that range will assumed to be from an Internet source, or vice versa, from a LAN source. (See "Assign LAN/Internet Address Range" in [Global Assignments](#) on page 21.)

You can purchase an Internet-based VOD-W or VODWM server from VBrick (in which case they are configured by VBrick) or you can purchase and configure a VOD-WM yourself using the Microsoft documentation (not recommended). You can also install a Darwin Open Source server which is fully-compatible with ETV Portal Server but is not sold or supported by VBrick. (For more about downloading, installing, and configuring a Darwin server, go to: <http://developer.apple.com/opensource/server/streaming/index.html>) As noted, ETV users can be on the Internet or on a LAN; Internet users can only access MPEG-4 and Windows Media content stored on Internet-based servers. LAN users can access all content

---

on all servers both inside and outside the firewall. To summarize, *Internet-based* servers and users are subject to the following limitations:

- Internet servers support MPEG-4 and Windows Media content only.
- Internet servers support unicast only (they do not support multicast).
- Internet ETV users can add video only to VOD servers in the Internet zone.
- Internet users can only see MPEG-4 and Windows Media content stored on Internet-based servers.
- Internet servers do not support ETV scheduling features.

### ***ETV IP Receiver***

EtherneTV-IPRs access the ETV Portal Server through a web browser within the IP Receiver. Using the IP Receiver remote control, users can navigate and search for specific on-demand content or live video streams, select a stream, and begin viewing television-quality video. IP Receiver users can also record video directly on the ETV Portal Server using the remote control or the wireless keyboard. See the IP Receiver documentation for more about how to configure and use an ETV IP Receiver.

### ***ETV Network Video Recorder***

The ETV Network Video Recorder and the ETV Live Portal Server are optional components that are purchased and installed separately. They have different license files that must be installed separately. See [Installing Serial Numbers and License Files](#) on page 15. The ETV Network Video Recorder lets you off-load all recording tasks from the ETV Portal Server machine to one or more separate "recorder server" machines. This optimizes recording performance and improves ETV Portal Server performance as well. The Network Video Recorder uses ETV

Portal Server components and typically requires two machines: the ETV Portal Server is installed on one machine; the Network Video Recorder software is installed on a different machine. Once installed, the NVR machine is used for all ETV Portal Server recording tasks. See [Network Video Recording](#) on page 127 for more information.

---

**Note** A standard ETV Portal Server permits two concurrent recording operations. If you purchase a Network Video Recorder, the number of concurrent recording operations (10 or 40) is fixed by the terms of your licensing agreement with VBrick.

---

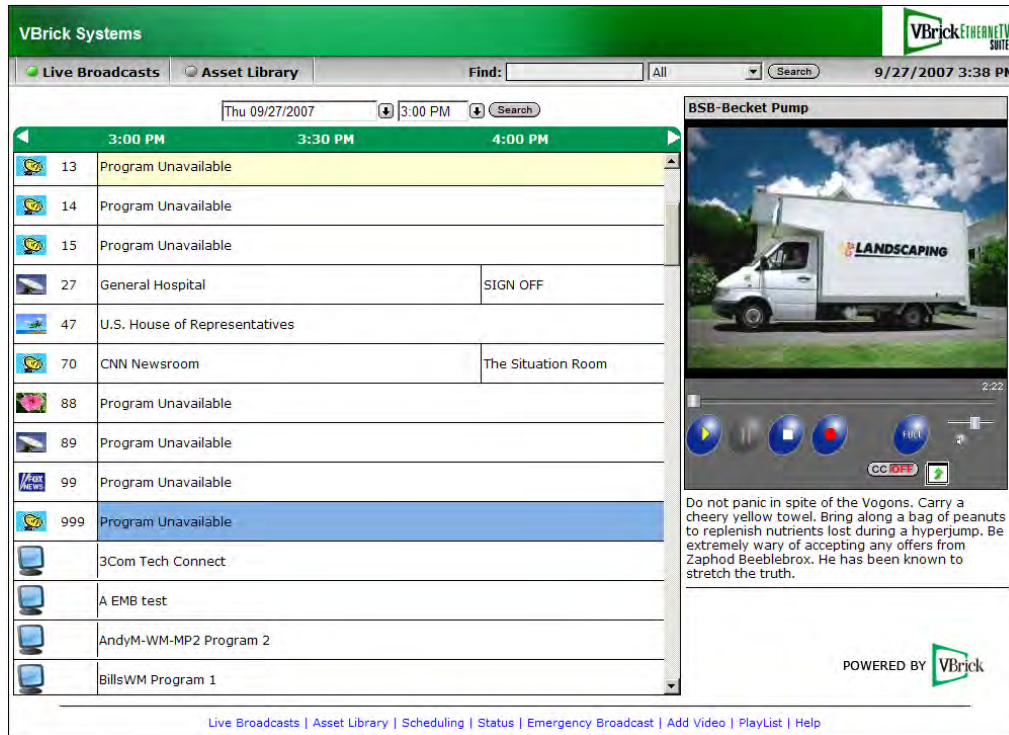

**Figure 3.** Live Portal Server User Interface

### *VB-PC Remote Controller*

The VB-PC Remote is a handheld infrared device you can use to control (stop/start/pause, etc.) any stream running on the Portal Server. The VB-PC Remote is compatible with Internet Explorer 6.0 or higher; it is not compatible with Firefox. The VB-PC Remote can be used for all Portal Server streams (MPEG, WM, and H.264) and has a line-of-sight range of approximately 40 feet.



After you *manually* start a stream using the Portal Server interface, you can use the VB-PC Remote to control it. When using the remote controller, the computer running the Portal Server basically acts like an IP Receiver that you can control with the remote control. The VB-PC Remote includes an IR Remote Control and an IR Remote Receiver. The computer to which it's attached must have an available (1.1 or 2.0) USB port. Note that the VB-PC Remote is installed on client machines connected to the Portal Server. *It is not part of the Portal Server installation and must be installed separately on each client machine.* See the *VB-PC Remote Product CD* for details and installation instructions.

---

## *Amino Set Top Box*

The AmiNet110 is a compact set top box for the Portal Server manufactured by [Amino Systems](#). It connects to a standard TV and only plays MPEG-2 streams; no other streams are selectable for viewing on the Portal Server interface. There is no software installation required. Simply connect and configure the device as explained in [Amino Set Top Box](#) on page 155. The *Portal Server User Guide* explains how to use the Amino infrared remote control unit that comes with the device.

## *WM IP Receiver*

VBrick's WM IP Receiver is similar to a conventional set top box but is significantly more stable, rugged, and reliable. It is designed for 24x7 operation, and built for enterprise networks that require a high degree of stability, security, and scalability. The WM IP Receiver is a robust, state-of-art device that meets the demanding requirements of VBrick's EtherneTV Media Distribution System. The WM IPR plays Windows Media streams from VBrick WM appliances and Windows Media servers. The WM IPR is also a fully-featured VBrick EtherneTV client. This means that in addition to the ability to deliver video, subsequent WM IPR releases will provide scheduling, access logging, and device control from the Portal Server. For more information about the WM IPR, see the *IPR Admin Guide* in the Portal Server online help.

## Portal Server Installation

Complete installation instructions for the Portal Server are provided in the *ETV Portal Server Release Notes*. Once the Portal Server is installed, end users on Windows, Macintosh, and Linux machines may be prompted for additional download components as explained below. This only happens the first time they access the Portal Server. The Portal Server supports a wide variety of clients and video formats. See [Supported VBrick Clients and Video Formats](#) for a complete list.

## *Downloading Components*

### Windows PCs

If configured with the appropriate components, Windows PCs (with Internet Explorer or Firefox) can play all stream types including MPEG, Windows Media, and H.264. For Windows-based PC users, the Portal Server uses VBrick StreamPlayer software-based components to decode video streams on user desktops. The Portal Server downloads these components to each client machine the first time you access the Portal Server (depending on the **Specify Components to Download to Clients** setting in [Global Assignments](#)). No download is necessary for subsequent access. If this is a new installation, end users must answer Yes to security requests to download these components. After a download, you don't have to restart your computer but must you must close the browser. These components are downloaded using .cab files.

In certain circumstances however, the use of .cabs is either not allowed or not feasible. In these cases, VBrick provides an .msi installer called `VBrickComponents.msi`. This installer installs the same components and allows end-users who cannot download .cabs to have full Portal Server functionality. This installer is located in the `Program Files\VBrick\MCS\utils` folder.

---

**Note** The component download setting will not affect previously-installed components. For example if you have StreamPlayer installed, you will be able to play MPEG-2 streams regardless of what components you specify for download.

---

With Firefox, users will also be prompted to install additional components the first time they launch a stream—if they are configured to receive these download components. Links for the appropriate stream types (MPEG, WM, or H.264) will be displayed in the area where the embedded player is normally displayed. These additional plugins *must* be installed. Firefox users will also be required to install an additional plugin when they use **Add Video** for the first time (again, if they are configured with this privilege).

**Table 3.** Supported Operating Systems and Browsers – Windows

Operating System	Browser
Windows 2000	Internet Explorer 6.0 †, Firefox 2.0 †
Windows XP	Internet Explorer 6.0 †, Firefox 2.0 †
Windows Vista	Internet Explorer 6.0 †, Firefox 2.0 †

† or higher

## Locked-Down Windows PCs

As described above, the Portal Server automatically downloads components to client PCs depending on the Global Assignment setting. This download can be an issue in environments that have restrictions on client software installation. For playback of WM files, Portal Server uses the existing Windows Media Player components on the client PC and there is no need for the extra components to be downloaded. This means that Portal Server and WM can be used in some but not all restrictive or "locked-down" environments.

Even if downloads are configured, a client PC will still refuse to accept the component download if the Internet Explorer security feature **Download signed ActiveX controls** is disabled. When using Portal Server 4.0 exclusively with WM streams and a WM VOD, the client PC can refuse to accept the downloaded components and all Portal Server features except **Add Video** will work. In this case you should uncheck the **Add Video Utility** in Global Assignments.

Some sites also require that their PCs be configured with certain Internet Explorer security settings. The Portal Server will not work on clients with Internet Explorer security set to **High**. The Portal Server *will* work at any level at or below **Medium**. If you start at **High**, the client will still work with Portal Server if you enable **Run ActiveX controls and plug-ins**, **Script ActiveX controls marked safe for scripting**, and **Active scripting**.

Since firewalls on LAN client PCs can also cause problems with Portal Server, it is recommended that firewalls be disabled on LAN clients. (In Windows XP with Service Pack 2, the firewall is enabled by default.) Portal Server's support for Internet clients is designed to work through firewalls. If you have Internet clients with firewalls see the description of LAN/Internet address ranges in [Global Assignments](#) on page 21.

## Macintosh PCs

If configured with the appropriate components, Macintosh PCs (with Safari or Firefox) can play all stream types including MPEG, Windows Media, and H.264. In a Macintosh environment, if downloads are configured in Global Assignments, when you launch the ETV Portal Server for the first time, the Home page (see Figure 2) displays a link prompting you to

download components that are appropriate for your computer. If you agree, these components are automatically installed and no additional download is necessary for subsequent access. On Macintosh PCs, Portal Server functionality is the same as in Windows except that the **Add Video** feature is not available. Table 4 shows the stream types supported for each environment; Table 5 shows the operating systems that are tested and supported. Note that there are certain performance limitations in Macintosh environments; see the *ETV Portal Server Release Notes* for information and recommendations.

### Configuring a Macintosh for Tunneled Streams

You may need to perform certain configuration steps on a Macintosh before you can use QuickTime to view streams tunneled over HTTP from a VOD-W server.

- ▼ To configure QuickTime for tunneled streams
  1. Launch QuickTime on a Macintosh and click on the **Apple QuickTime** player to set focus on the task bar at the top of the screen.
  2. Click **QuickTime Player** in the task bar and go to **QuickTime Preferences**.
  3. On the **Advanced** tab, click on **Transport Setup** and then **Custom**.
  4. Check the **Port ID** used for the **HTTP Transport Protocol**. The **Port ID** must match the **HTTP Tunneling Port** set on the Portal Server for the VOD-W server (default = 8000). If necessary, get this port number from your system administrator. See the *VOD-W Admin Guide* for more information.

### Linux PCs

If configured with the appropriate components, Linux PCs running Fedora or Red Hat (on Firefox) can play MPEG, WM, and H.264 streams. However, the Portal Server must download Linux components to *each-end user desktop* before any streams will play. This should only be performed by a system administrator. When you access the Portal Server for the first time, you will see a message in the embedded player window indicating that the appropriate plugins are not installed. See "Installing Linux Components" in the *Portal Server Release Notes* for detailed instructions. On Linux PCs, Portal Server functionality is the same as in Windows except that the **Add Video** feature is not available. Table 4 shows the stream types supported for each environment; Table 5 shows the operating systems that are tested and supported. Note that there are certain performance limitations in Linux environments; see the *ETV Portal Server Release Notes* for information and recommendations.

**Table 4.** Supported Stream Types – Macintosh and Linux

Environment	Supported Streams	Closed Captions †
Macintosh	Safari – MPEG-1, MPEG-2, MPEG-4, WM, H.264.	Supported for MPEG-1/MPEG-2 streams, and for MPEG-4 and WM with VBrick plugin.
	Firefox – MPEG-1, MPEG-2, MPEG-4, WM, H.264.	Supported for MPEG-1/MPEG-2 streams, and for MPEG-4 and WM with VBrick plugin.
Linux	Firefox – MPEG-1, MPEG-2, MPEG-4, WM, H.264.	Supported for MPEG-1, MPEG-2, MPEG-4, and WM streams.

† Closed captions are not currently supported on H.264 streams.



**Table 5.** Supported Operating Systems and Browsers – Macintosh and Linux

Operating System	Browser †
Mac OS X 10.3 (Panther)	Safari 3.1.1, Firefox 2.0
Mac OS X 10.4 (Tiger)	Safari 3.1.1, Firefox 2.0
Mac OS X 10.5 (Leopard)	Safari 3.1.1, Firefox 2.0
Linux Red Hat 9.0	Firefox 2.0
Linux Fedora Core 9.1	Firefox 2.0

† Use version shown or higher.

### *Decoder Closed Captioning Support*

The Portal Server supports live streams with closed captioning. It also supports closed captioning for MPEG-4 stored content as long as the content is recorded with closed captioning and stored on a VOD-W server. Closed captioning is not supported for NXG MPEG-4 stored content. The following table shows closed captioning support for VBrick decoders/IPRs, cross-referenced by live and stored content.

**Table 6.** Decoder Closed Captioning Support

	Live Content	Stored Content			
		VOD-W	VOD-WM	NXG	VOD-D
MPEG-4 Decoder	Yes	Yes	N/A	No	MPEG-4 only
MPEG-2 Decoder	Yes	Yes	N/A	Yes	N/A
Digital IP Receiver (STB)	Yes	Yes	N/A	MPEG-1/2 (no MPEG-4)	MPEG-4 only
WM-IP Receiver	No	N/A	No	N/A	N/A

### *Port Requirements*

The drawing below, and the table that follows, show the required port configuration for various Portal Server devices. *All ports in the drawing are TCP except as noted.*

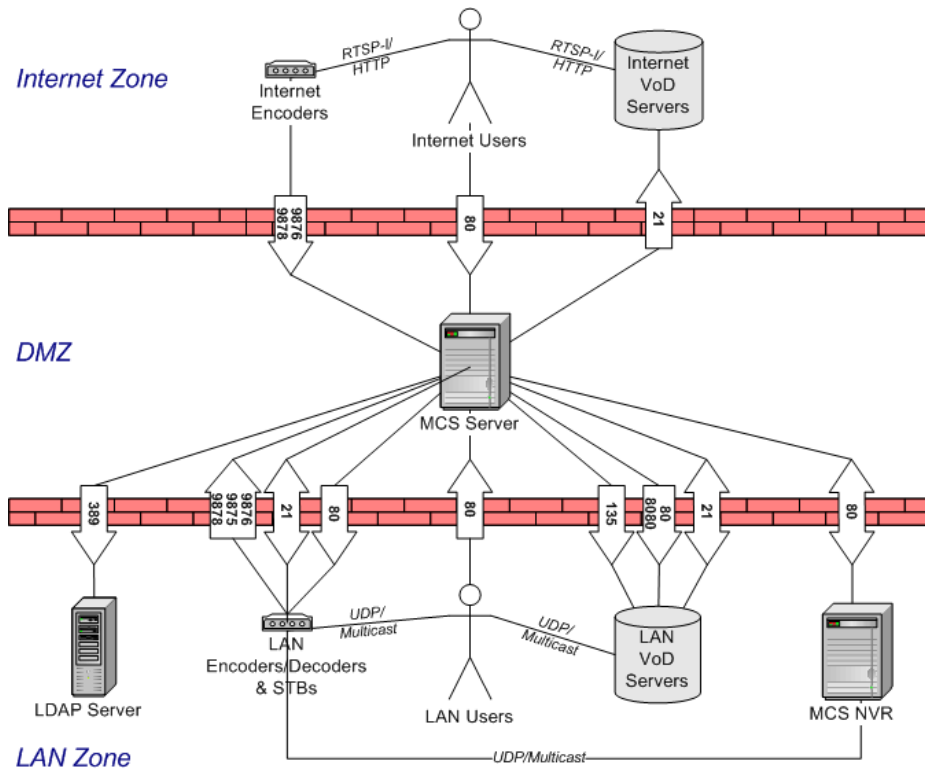

**Table 7.** Port Requirements †

Zone	Port(s)	Protocol	Description
Internet > DMZ	80	TCP	Web request from client to MCS.
Internet > DMZ	9876/9878	UDP	Management/RTSP SAP announce from VBrick to MCS.
DMZ > Internet	21	TCP	FTP from MCS to VOD Server (Darwin/Windows Media/FTP).
LAN > DMZ	80	TCP	Web request from client to MCS.
LAN > DMZ	9875/9876/9878	UDP	Multicast/Management/RTSP SAP announce from VBrick to MCS.
LAN > DMZ	21	TCP	FTP from VBStar to MCS (auto-FTP to MCS autoingest directory).
DMZ > LAN	21	TCP	FTP from MCS to VBStar (content discovery).
DMZ > LAN	80	TCP	Management command from MCS to VBrick/IPR.
DMZ > LAN	80/8080	TCP	Web service request from MCS to VOD Server (VOD-W/NXG).
DMZ > LAN	21	TCP	FTP from MCS to VOD Server (Darwin/Windows Media/FTP).
LAN > DMZ	21	TCP	FTP from VOD Server (NXG/VOD-W) to MCS.
DMZ > LAN	135	TCP	Management command from MCS to Windows Media (DCOM).
DMZ > LAN	80	TCP	Web service request from MCS to Network Video Recorder.

Zone	Port(s)	Protocol	Description
DMZ > LAN	80	TCP	Web service request from Network Video Recorder to MCS.
DMZ > LAN	389	TCP	LDAP lookup from MCS to LDAP Server (e.g. Active Directory).

† All ports are TCP except as noted.

## *Installing Serial Numbers and License Files*

You are prompted to install serial numbers and license files (.lic) as part of the Portal Server installation process. Different Portal Server functionality is available depending on the type of license you purchase and install. (For example if you do not install a Scheduler license, you will not see a **Scheduling** option in the Portal Server client application.) After initial installation you can install a different license as necessary using **Add or Remove Programs**.

- ▼ To install or modify serial numbers and license files
  1. Go to **Start > Control Panel > Add or Remove Programs > VBrick Media Control Server Suite**.
  2. Click the **Change/Remove** button, select a license file type, and click **Next** (license file types are explained in Table 8).

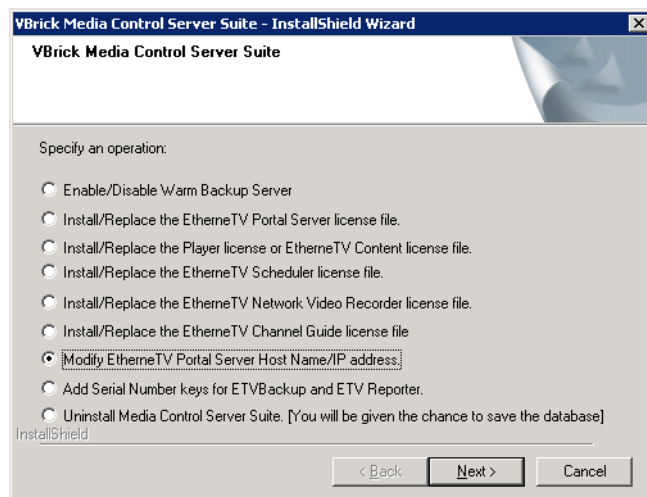

3. A serial number is required for some components. Enter a serial number and confirm if necessary. If the serial number window pops up and is already filled in, click **Next** to continue. If the serial number field is empty, enter the serial number you received from VBrick Support Services (or from the "License Activation Keys & Serial Numbers" card that was included with the EtherneTV Product CD), and click **Next**.

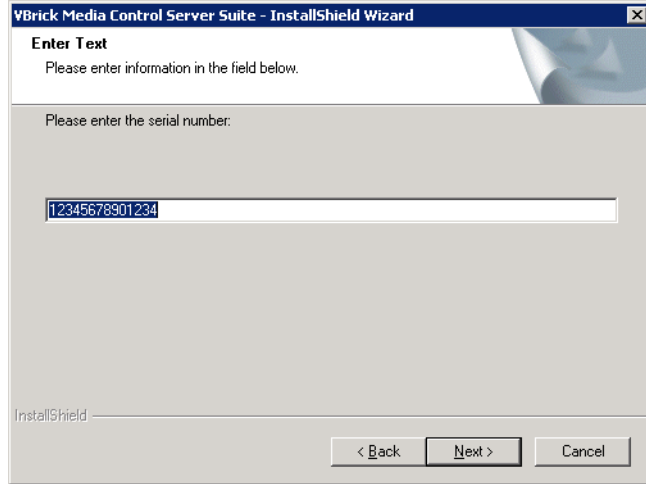

4. When prompted, navigate to the folder with your license (.lic) file. License files are obtained by using the "License Activation Keys & Serial Numbers" card included with the Product CD. The "Software License Activation" document, also included, explains how to activate your licenses using these keys. Note that multiple license files may be shown if you purchased optional EtherneTV components. *Select the appropriate license file.* (For more about license files, see "Installing Serial Numbers and License Files" in the *Portal Server Admin Guide*.)
5. **Repeat these steps for each EtherneTV component.** When done, manually close the window and launch the application. There is no need to restart the host machine.

**Table 8.** Portal Server License File Types

License File	Description	License Errors
Warm Backup Server	If you purchased ETV Backup, two Portal Servers will be present—one of which must be configured as a warm backup. Use this option (and the popup shown below) to enable or disable the backup server. If you enable one server, you must disable the other. Default = Disable.	Not applicable.
Portal Server	Use this option, as directed, to install a Portal Server license file.	Not applicable.

License File	Description	License Errors
Player/Content	<ul style="list-style-type: none"> <li>• Player License: The embedded Windows Media Player has restrictions on the number of licensed users. Use this option to select a license file that modifies the number of allowed users for various MPEG-1, MPEG-2, and MPEG-4 streams.</li> <li>• Content License: Used to install third-party content purchased from VBrick.</li> </ul>	<p>If player license not installed, popup message displayed when you try to launch a stream.</p> <p>If content license not installed, the purchased content ingestion will fail.</p>
Scheduler	Enables the broadcast or recording of future events. See the <i>ETV Portal Server User Guide</i> for more information.	If not installed, the Add option will not be shown on Scheduler page.
Network Video Recorder	A Network Video Recorder is a standalone recorder option that can speed up recording operations and/or enhance Portal Server performance. (See <a href="#">ETV Network Video Recorder</a> on page 8.)	If not installed, there will be a "record" failure for more than two concurrent record requests.
Channel Guide Server	Enables access to the Channel Guide Server for TV Stations that are typically provided by a third-part content provider.	If not installed, there will be no TV Stations or access to the Channel Guide server.
Modify Host Name or IP Address	Lets you auto-detect or manually change the Portal Server Host Name. This name must match the machine name on which ETV Portal Server is installed. If you change the host machine name, use this option to change the Portal Server Host Name.	Not applicable.
ETVBackup/ETV Reporter	Required for optional Backup and Reporter components.	If not installed, the applications will not run.
Uninstall Media Control Server Suite	Remove all ETV Portal Server components. You are prompted to save the database as desired.	Not applicable.

## Admin Console Login

**The ETV Portal Server can be administered from Windows-based PCs using Internet Explorer 6.0 or higher only.** The Admin Console pages are best viewed at 1024x768 resolution. The Admin Console is not supported on Macintoshes or IP Receiver, or with Firefox or other browsers. In order to access the administrative functions enter the following address in the Internet Explorer browser of the PC where `myserveraddress` is the host name or IP address of the ETV Portal Server. The session will timeout after 20 minutes of inactivity. `admin` is both the default user name and password.

<http://myserveraddress/admin/>

---

VBrick EnergyTV  
SUITE

## Administrator Login

User Name

Password

Login

v4.2.0.2

© 2007 VBrick Systems, Inc. All rights reserved.

---

**Note** As a standard best practice, VBrick recommends changing the default administrator User Name and Password. Go to **Global Settings > Global Assignments** on the Admin Console.

---

### *Admin Console Options*

Login to the ETV Portal Server Admin pages with a valid user name and password to display the following window. This window provides access to all admin configuration options.

**Welcome to the Media Control Server Suite Admin Console Pages**

The Media Control Server (MCS) Admin Console Pages have been designed to let MCS Suite Administrators quickly and easily set up and manage the MCS Suite system. All MCS Suite functionality is available from these pages. The information below provides a brief description of the function tabs on the left side of this page. (Note that the function tabs for **User Groups** and **Resource Groups** are only displayed if Access Control is enabled.) For more information about any feature or function, click on the **Help** button and search the *Admin Guide* for the information you need. These MCS Suite Admin Pages are best viewed at 1024 X 768 or higher screen resolution using Normal size (96 DPI) fonts.

Getting Started	Returns you to this splash page.
Global Settings	Provides configuration parameters to connect to VBrick encoders and VOD servers and customize the look-and-feel of Portal Server pages.
Modify VOD Content	Lets you Move, Rename, or Delete content on the VBrick Video-on-Demand server (not supported on some legacy NXG servers).
Channels	Lets you define TV stations and custom stations that automatically obtain programming data from a third-party provider.
Diagnostics	Displays system log messages by source, time, and (generally) IP address.
Status	Shows the status of events in progress including recordings, Add Video commands, ingestion to the VOD server, and FTP downloads.
Expired Content Log	Shows all expired content still present on the Portal Server.
Access Control	Provides the ability to limit access to the MCS Suite to different users or groups of users.
Live Presentations	Provides the ability to view and remove current rich media presentations from the MCS Live Broadcast Page.
Users	Used in conjunction with Access Control to limit access to the MCS Suite to specified users.
User Groups	Used in conjunction with Access Control to limit access to the MCS Suite to specified groups of users.
Resource Groups	Used in conjunction with Access Control to group resources which are available to users or user groups.
Help	Opens a new window containing the EtherneTV Online Help.
Logout	Logs out the user who is currently logged in.

**Table 9.** Admin Options

Option	Description
Getting Started	The ETV Portal Server splash page shown above.
Global Settings	Provides system-wide configuration parameters to connect to VBrick encoders and VOD servers as well as to customize the look of the ETV Portal Server pages.
Channels	Lets you define TV stations and custom stations that obtain programming data from a third-party provider.
Modify VOD Content	Provides the ability to Move, Rename, or Delete assets on the EtherneTV-VOD Video-on-Demand server. (Not supported on some legacy NXG servers.)
Diagnostics	Displays system log messages by source, time, and (generally) IP address.
Status	Shows the status of events in progress including recordings, Add Video commands, ingestion to the VOD server, and FTP downloads.
Expired Content Log	Shows all expired content still present on the Portal Server. Use Purge All to delete unwanted content.

Option	Description
Access Control	Provides the ability to limit access to the ETV Portal Server system to different users or groups of users.
Live Presentations	Provides the ability to view and remove current live presentations from the Live Broadcasts page.
Users†	Used in conjunction with Access Control to limit access to the ETV Portal Server system to different users.
User Groups†	Used in conjunction with Access Control to limit access to the ETV Portal Server system to different groups of users.
Resource Groups†	Used in conjunction with Access Control to group resources which can then be provided to users or user groups.
Help	Displays the ETV Portal Server online help system in a new window.
About	Displays the MCS version number as well as the license and serial number status for each installed module.
Logout	Logs out the user who is currently logged in.

† Users, User Groups, and Resource Groups are only displayed if Access Control is enabled. See [Users and User Groups](#) on page 103 for a description of these functions.

## *Internet Explorer 7.0 Configuration*

The Admin Console and the Portal Server user interface support the browsers shown in Table 3 and in Table 5. When using Internet Explorer 7.0, there are additional security settings required for compatibility with the Portal Server.

- ▼ To configure the Portal Server for Internet Explorer 7.0
  1. Go to **Tools > Internet Options > Security** and select **Custom level**.
  2. Under **Active X controls and plug-ins** set the following parameters:
    - **Allow previously unused ActiveX controls to run without prompt** – Enable
    - **Automatic prompting for ActiveX controls** – Disable
    - **Display video and animation on a webpage that does not use external media player** – Enable
    - **Download signed ActiveX controls** – Prompt
    - **Run ActiveX controls and plug-ins** – Enable
    - **Script ActiveX controls marked as safe for scripting** – Enable



# Global Settings

Global Settings include configuration settings and parameters that apply to the entire system. Global Settings include all of the following.

### *Topics in this section*

Global Assignments . . . . .	21
Custom Fields . . . . .	28
Stream Restrictions . . . . .	29
Servers . . . . .	30
VBricks . . . . .	43
Control Devices . . . . .	47
IP Receivers . . . . .	53
Recorders . . . . .	55
Script Devices . . . . .	57
Scripts . . . . .	59
URLs . . . . .	62
Priority Alert . . . . .	66
Program Names . . . . .	70
Manage Playlists . . . . .	71
Access Logging . . . . .	72
Zones . . . . .	75

## Global Assignments

Global Assignment are listed below. Most are self-explanatory and consist of text boxes where you enter appropriate values.

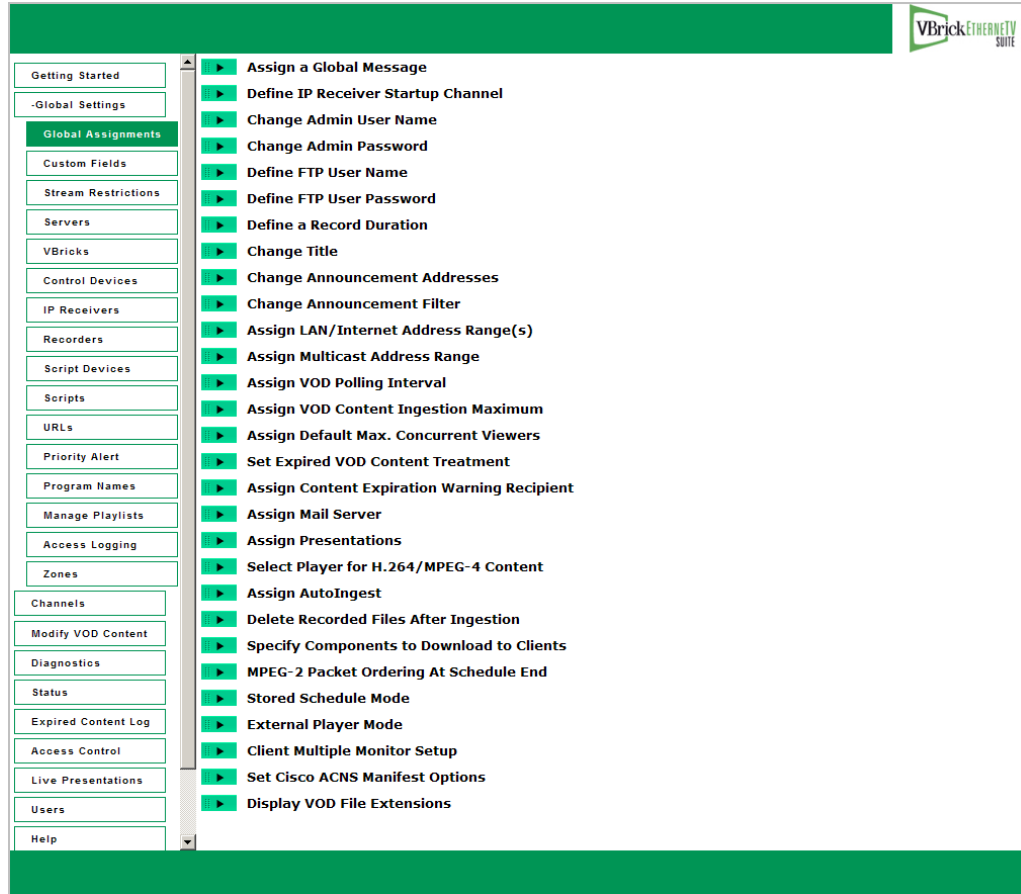

**Table 10.** Global Assignments

Item	Description
Assign a Global Message	The global message will be displayed in the message area of the Portal Server user interface when there is no program information available. Enter the message text and click Submit. Example: <i>There will be an all hands meeting today at 4:00 PM in the boardroom.</i> Note that if you are running the Portal Server on a IP Receiver, the message area will not display more than 4 lines of text.
Define IP Receiver Startup Channel	When an IP Receiver (in ETV Portal Server Start mode) accesses the <b>Watch live broadcasts</b> page, it can be set to automatically play a defined channel in the Preview Window. Highlight that channel from the list and click Submit. If there are no channels listed, channels must first be defined as Customized Live Streams.
Change Admin User Name	Change the default admin user name of <code>admin</code> . Use any combination of alphanumeric and special characters <i>except</i> slashes, quotes, or commas.
Change Admin Password	Change the default admin password of <code>admin</code> . Use any combination of alphanumeric and special characters <i>except</i> slashes, quotes, or commas.

Item	Description
Define FTP User Name	ETV Portal Server is defaulted for "anonymous" FTP access which is configured in Windows IIS Default FTP Site. If a more secure FTP access is desired, the User Name can be changed in IIS (see the Windows Server documentation for details). The same User Name should be entered here. Use any combination of alphanumeric and special characters <i>except</i> slashes, quotes, or commas. If configuring for VBPresenter, see <a href="#">Configuring an MCS FTP User Account</a> on page 134.
Define FTP User Password	ETV Portal Server is defaulted for "anonymous" FTP access which is configured in Windows IIS Default FTP Site. If a more secure FTP access is desired, the Password can be changed in IIS (see the Windows Server documentation for details). The same Password should be entered here. Use any combination of alphanumeric and special characters <i>except</i> slashes, quotes, or commas. If configuring for VBPresenter, see <a href="#">Configuring an MCS FTP User Account</a> on page 134.
Define a Record Duration	Applies to the on-demand <b>Record</b> pushbutton only (not to scheduled recording). Defines the maximum duration (default 120 minutes) allowed for a continuous recording. Maximum record duration limited only by size of hard drive.
Change Title	Changes the text (i.e. VBrick Systems) that is displayed on the upper left hand corner of the Portal Server User Interface. To leave blank, enter at least one space. Note that the title text is white and cannot be changed.
Change Announcement Addresses	<i>Changing these from the defaults is highly discouraged and should only be done if advised by a VBrick technician or Network Administrator.</i> Changes the Management, Multicast, and RTSP addresses on which Announcements (SAPs) are received. By default all VBrick devices are set to the same addresses and ports as the defaults in ETV Portal Server. These have to match on all devices for proper functionality.
Change Announcement Filter	Filters SAP announcements so that only the specified IP addresses are shown on the Live Broadcasts page in ETV Portal Server. Wildcards are allowed. For example 255.*.*.* displays only those addresses in the range 255.0.0.0 – 255.255.255.255.

Item	Description
Assign LAN/Internet Address Range(s)	<p>Define the range(s) of IP addresses that define the LAN or the Internet domain. Any IP addresses outside the range are assumed to be from the domain you did <i>not</i> select. Check one option and, if necessary, use the text box to enter the range(s) separated by a comma, a semicolon, or a new line. For details, see <a href="#">ETV Internet-Based Servers</a> on page 7.</p> <ul style="list-style-type: none"> <li>• All Users, Servers, and VBricks are in the LAN Domain (default).</li> <li>• All Users, Servers, and VBricks are in the Internet Domain.</li> <li>• Specify LAN Address Range(s); assume users/servers/VBricks outside this range(s) are in the Internet domain.</li> <li>• Specify Internet Address Range(s); assume users/servers/VBricks outside this range(s) are in the LAN domain.</li> <li>• Always use TCP protocol (HTTP Tunneling/RTSP Interleaving) for MPEG-4 and Windows Media content – Use only with Internet-compatible (VOD-D, VOD-W, and VOD-WM) servers. If checked, the Portal Server will always use HTTP tunneling or RTSP interleaving using the <b>HTTP Tunneling Port</b> defined for the server (see <a href="#">Adding VOD Servers</a> on page 31).</li> </ul> <p><b>Note:</b> Standard VBrick IP Receivers do not support HTTP tunneling and will not play MPEG-4 content if this option is selected.</p>
Assign Multicast Address Range	<p>Defines the current multicast IP address range and port range. The default multicast IP range is 225.1.1.0–239.128.255.255. The default port range is 1040–65534.</p>
Assign VOD Polling Interval	<p>Not generally changed. Defines the interval at which the Portal Server polls the VOD server(s) for new content (default 120 minutes). This is only used to poll for content added to the VOD from an interface <i>other than ETV Portal Server</i>. When adding a server, use <b>Sync Now</b> to sync the program listings on the client Browse Video Library page with the content on the new server.</p> <p>Use <b>Hide content for VOD Servers experiencing connection problems</b> to prevent end users from seeing unavailable content and to enable rollover to the <b>Default Server Address(es)</b> specified on the <b>Zones</b> page (see <a href="#">Zones</a> on page 75 for more information). Default = checked. If this option is unchecked, there will be no rollover to default servers in the event of a server failure.</p>

Item	Description
Assign VoD Content Ingestion Maximum	Defines the maximum number of simultaneous video files that can be ingested to the VOD Video-on-Demand server. The default is set to 2. Increasing the default may increase the speed at which files will be transferred to the VOD server, but may result in playback issues from the Video-on-Demand server. VBrick recommends keeping the default of 2 for all supported VOD servers.
Assign Default Max. Concurrent Viewers	Defines the <i>default</i> maximum concurrent viewers allowed for new live or stored (VOD) content. An entry on the <b>Stream Restrictions</b> page or the <b>Modify VOD Content</b> page will override these value for live and stored streams respectively.
Set Expired VOD Content Treatment	Specifies whether expired content will be kept or automatically deleted at the expiration date.
Assign Content Expiration Warning Recipient	Enter one e-mail address for the person who is responsible for renewing copyrighted or otherwise protected content. When you configure or change either the recipient or the mail server, the Portal Server will attempt to send a test message. Check that this message is successfully delivered. The Portal Server validates the e-mail address but cannot detect other mail delivery failures. If the user's mail box is full, for example, the message will not reach its intended recipient to warn of impending content expiration. For more about content expiration, see <a href="#">Copyright Protection</a> on page 3. When configuring the Warning Recipient, the e-mail address for the recipient must be in the local domain.
Assign Mail Server	Required field. SMTP mail server name. In Microsoft Exchange, for example, go to Tools > E-mail Accounts > E-mail > Microsoft Exchange Server > servername. An e-mail to the assigned Content Expiration Warning Recipient is generated when you configure or change this field.

Item	Description
Assign Presentations	<p>VBPresenter is used to create multimedia presentations that can be launched from the Portal Server. The <b>Current Presentations Directory</b> defines the virtual directory on the Portal Server where the live presentations are stored—the default is <b>Presentations</b>. During a new Portal Server installation, the required virtual and physical directories are automatically created. To use a different virtual directory, create the virtual directory in IIS and enter only the virtual directory name in this field—<i>do not enter the complete path</i>. The <b>Current Presentations User</b> is a pseudo VBPresenter user who will be given permission to publish to specified directories and VOD servers. <a href="#">Configuring an MCS Presentation User</a> on page 135 explains how to create this user; contact <a href="#">VBrick Support Services</a> if you need help.</p> <p>If you are upgrading from Portal Server v4.0.1 or earlier and using VBPresenter, you will need to manually create two virtual directories (<b>Presentations</b> for live presentations and <b>MCSPresentations</b> for stored presentations), giving the user <b>Everyone</b> full permissions, and mapping the local paths respectively to:</p> <p><a href="#">C:\Program Files\VBrick\MCS\Presentations</a>  <a href="#">C:\Program Files\VBrick\MCS\MCSPresentations</a></p>
Select Player for H.264/MPEG-4 Content	<p>Select the player to use for H.264/MPEG-4 content on Windows/Macintosh clients:</p> <ul style="list-style-type: none"> <li>• VBrick Player – users will be prompted to install a VBrick plugin the first time they launch H.264/MPEG-4 content.</li> <li>• Apple QuickTime Player – VBrick plugin not required. Does not support access logging.</li> </ul>
Assign AutoIngest	<p>The current autoingest via XML user name that has access and publishing rights to a VOD server. See <a href="#">AutoIngest Content via XML</a> on page 141 for more information.</p>
Delete Recorded Files After Ingestion	<p>Used with scheduled recording and push button recording. Specifies whether or not to delete the recorded file from the NVR after ingestion. Enabled by default.</p>

Item	Description
Specify Components to Download to Clients	<p>This setting defines whether the Portal Server will download additional components to client machines when the client first makes contact with the Portal Server—before any streams or assets are selected for playback (see <a href="#">Downloading Components</a> on page 10 for more information.) <i>Any changes to these settings apply to new client machines only and will not affect previously configured machines.</i> The settings here apply to Internet and/or LAN users as defined in the <b>Assign LAN/Internet Address Range(s)</b> in Global Assignments (see above). The default is to download all components to all clients. For Windows clients you can selectively choose any combination of settings; for Macintosh or Linux clients, any one selection will download all components for all clients.</p> <ul style="list-style-type: none"> <li>• MPEG-1 Video Support – makes MPEG-1 files playable.</li> <li>• MPEG-2/1 Video Support – makes both MPEG-2 and MPEG-1 files playable.</li> <li>• MPEG-4/H.264 – makes MPEG-4/H.264 files playable.</li> <li>• WM Video Support for Firefox on Windows PC – makes Windows Media files playable on Firefox.</li> <li>• 'Add Video' Utility – enables or disables the "add video" functionality on client machines.</li> </ul>
MPEG-2 Packet Ordering at Schedule End	<p>Network hardware infrastructure determines the order in which packets arrive at a destination. To improve video quality, VBrick MPEG-2 appliances reorder packets by default. Since this reordering can cause an increase in latency and affect applications like video conferencing, you can set packet ordering to disabled at schedule end.</p>
Stored Schedule Mode	<p>Used when creating a live broadcast schedule for stored content. Note that the following parameters are "sticky." They remain associated with the schedule even if the Stored Schedule Mode is subsequently changed.</p> <ul style="list-style-type: none"> <li>• Content Centric – content titles are shown; content servers are not shown. The content is downloaded from load-balanced servers.</li> <li>• Server Centric – content servers are shown with a tree control for selecting content. The content is downloaded from a specific server and is not load balanced.</li> </ul>
External Player Mode	<p>Windows only. Determines whether or not multiple streams can be displayed by launching external player windows. Default = Single. You can launch multiple windows but you can only record one stream at a time.</p>
Client Multiple Monitor Setup	<p>The Portal Server supports dual client monitors. However, if you experience problems when using a second monitor, disable the DirectX component VMR9.</p>

Item	Description
Set Cisco ACNS Manifest Options	Check the box to enable generation of a Cisco ACNS Manifest File. (The Cisco ACNS server must be configured to point to this file.) Select the files (MPEG-4 and/or WM) to include in the file, and specify a Manifest Generation Interval (default = 10 minutes) that defines how often the file will be regenerated. Click Generate Now to create an "on demand" file. ACNS copies all MPEG-2 and WM video files to all (Windows Media, Darwin, and VOD-W) servers in your EtherneTV system. Additional configuration steps are required on the VOD-W server only. See <a href="#">ACNS Configuration</a> on page 161 for more about ACNS.
Display VOD File Extensions	Check the box to display file extensions (for example .mp4 or .wmv) in the Portal Server Asset Library.

## Custom Fields

Custom fields are used to add additional fields to the Info pages associated with stored videos and live broadcast streams. All stored videos, and those live streams that have been "customized," have an **Info** hyperlink. By default, the Info page has fields for **Description** and **Keywords**. The Custom Fields functionality lets you add additional "custom" fields that are appropriate to your business or application. This lets you provide more information on the page and it also makes it easier to search for specific streams. (All defined fields are listed in the dropdown list box next to the **Search** button.)

When you add a custom field using this function, the field is available to administrators as a selection in the **Customize Streams** window. It is also available to end users as the **Modify Info** button on the Info pages associated with stored videos (if they have content publishing permissions).

▼ To create a Custom Field

1. Go to **Global Settings > Custom Fields**.



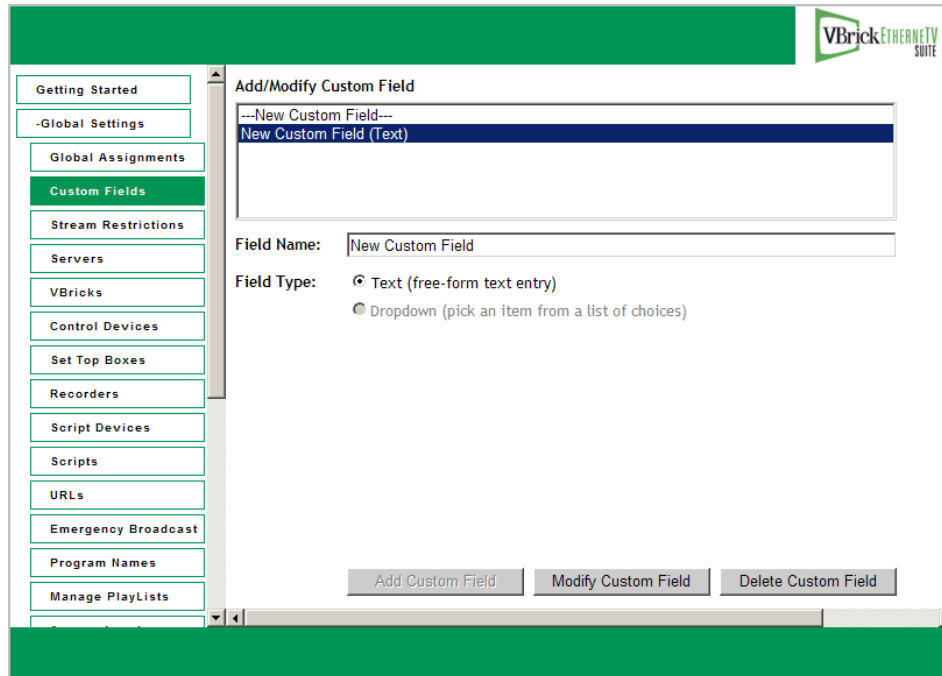

2. Enter a **Field Name** and a **Field Type**. If you select **Dropdown**, you can add items one at a time followed by **Add Item**. These items will populate a dropdown list box on the **Customize Streams** page.
3. When done, click **Add Custom Field**. The field will be added to the panel at the top of the window; it will also be available as an option when you are customizing a stream.

Add/Modify Custom Field	This panel shows the existing custom fields that have previously been defined.
Field Name	The field name you want to display on the Info page for this stream or video.
Field Type	This determines how the field will be displayed on the <b>Customize Streams</b> page, either as a text field or as a dropdown list box.

## Stream Restrictions

Use this page to set and the viewing period for live stream recordings and the maximum number of concurrent viewers. There are no default expiration dates for live streams when a recording is made but administrators can automatically set the content from a specific stream to expire by setting a viewing period. For more about content expiration see [Copyright Protection](#) on page 3.

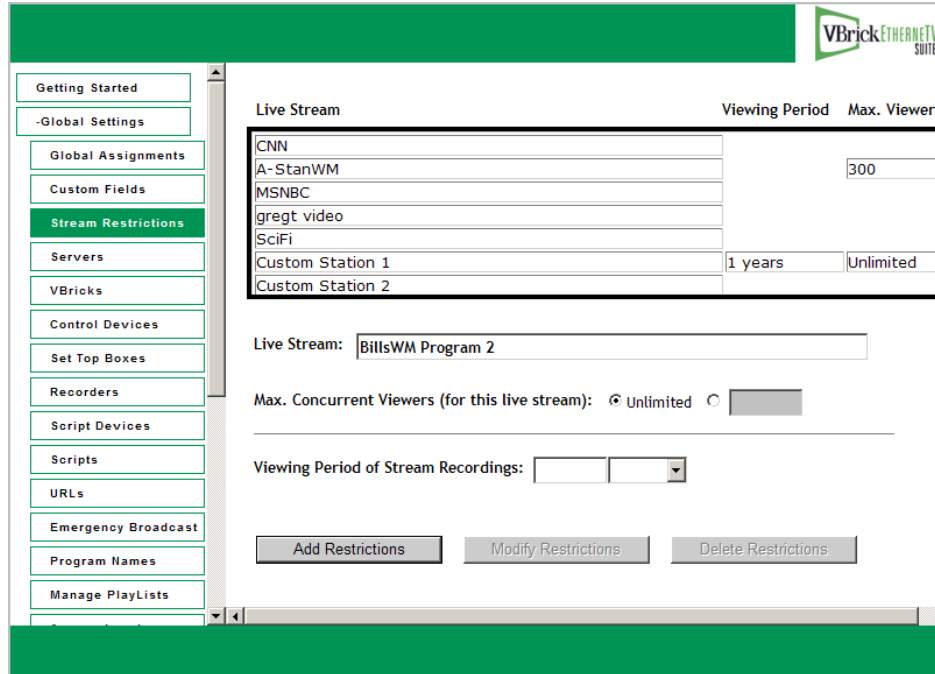

Live Stream	Click on any live stream shown in the list to populate this field.
Max. Concurrent Viewers	Set the maximum number of concurrent viewers for this stream to unlimited or any number greater than zero.
Viewing Period of Stream Recordings	Set the length of the viewing period for a file recorded with this stream in hours, days, weeks, months, or years. The file will no longer be available for viewing at the end of the period and will be deleted or saved as configured in Global Assignments > Set Expired VOD Content Treatment.

## Servers

Use the **Servers** page to add or modify VOD, FTP, and file servers, or to add or modify VOD Content Folders. Note that you can cluster multiple servers to increase throughput: the ETV Portal Server will automatically load balance all servers defined on the **Servers** page; no additional configuration is necessary. Note that content added by users in the Internet zone will only be ingested to VOD servers in the Internet zone for which they have permissions. Content added by users in the LAN zone will be ingested to all VOD servers for which they have permissions. See [ETV VOD Servers](#) on page 6 for more about ETV servers.

**Note** It may take up to 20 minutes for new server content to be displayed in the ETV Portal Server. To make content available immediately, go to **Global Settings > Global Assignments > Assign VOD Polling Interval** and click **Sync Now**.

Adding VOD Servers . . . . .	31
Adding FTP Servers . . . . .	36
Adding File Servers . . . . .	37

## Adding VOD Servers

Use this window to add Video-On-Demand Server(s) to the ETV Portal Server. If the network supports Windows 98 users, you *must* use the IP address of the VOD server—not the host name. After selecting a **Server Type** VBrick recommends you keep the default settings for FTP Password, Publishing Local Path, Publishing Directory, etc. unless there is a compelling reason to change them. Nor is it necessary to create a Streaming Alias. Leave this parameter blank unless you are using HTTP Tunneling.

### Adding VOD-W, VOD-D, and NXG Servers

IP or Domain	Server Description	FTP User Name	Server Type
172.17.119.120	Frodo	vbrickuser	NXG
172.22.2.112	Silver	vbrickuser	VOD-WM-STANDARD
172.22.2.63	Alpha-WM-1	vbrickuser	VOD-WM-ENTERPRISE

vbrickuser

FTP Password:   Enable URL Password Protection:   
 Confirm Password:  Confirm Password:   
 Publishing Local Path:   
 Publishing Directory:  Web Service Port (HTTP):   
 Streaming Alias (IP or Domain):   
 HTTP Tunneling Port:   Supports HTTP Tunneling?  
 Secondary Server Address:  (IP or Domain of second NIC or NAT)

Figure 4. Add VOD-W Server

IP or Domain	This is the primary IP address or Host Name of the VOD server for LAN users (see also <b>Secondary Server Address</b> below). The Server Name or IP address entered into the ETV Portal Server must be accessible by the ETV Portal Server. (If the network supports Windows 98 users, you <i>must</i> use the IP address.)
Server Description	This allows the administrator to define a descriptor such as location.
FTP User Name	This is the FTP user name that the Portal Server uses when publishing content to the server. The default user name for NXG, VOD-D, VOD-WM, and FTP servers is <b>vbrickuser</b> . The default user name for VOD-W servers is <b>anonymous</b> . The FTP User Name refers to a user account that already exists on the server. If the FTP User Name is changed on any VOD server, it must be changed here as well. Use any combination of alphanumeric and special characters.

Server Type	<ul style="list-style-type: none"> <li>• NXG – Linux-based Kasenna VOD server.</li> <li>• VOD-W – Windows-based InfoValue VOD server.</li> <li>• VOD-D – Darwin Open Source server for Linux, Windows, Mac, etc. Ingests and plays MPEG4 content only. Requires an FTP server. See <a href="#">Creating a VOD-D FTP Server</a> on page 37.</li> <li>• VOD-WM-Standard – Microsoft Windows Media Server (unicast only). Requires an FTP server. See <a href="#">Creating a VOD-WM FTP Server</a> on page 36.</li> <li>• VOD-WM-Enterprise – Microsoft Windows Media Server (unicast or multicast). Requires an FTP server. See <a href="#">Creating a VOD-WM FTP Server</a> on page 36.</li> <li>• FTP – Use FTP only if you want to copy from the Recorder server to another FTP server in which case it records to <code>ftp:\root</code>.</li> <li>• File-Server – Any Windows computer with an FTP server running can be configured as a progressive download file server. See <a href="#">Adding File Servers</a> on page 37.</li> </ul>
FTP Password	The FTP password the Portal Server uses when publishing content to the server. The default FTP password for NXG, VOD-D, VOD-WM, and FTP servers is <code>vbrickuser</code> . The default FTP password for VOD-W servers is <code>anonymous</code> . If the FTP Password is changed on the server, it must be changed here as well. Use any combination of alphanumeric and special characters.
Publishing Local Path	Maps the Publishing Directory to the physical location on the VOD server.
Publishing Directory	Used for Add Video, FTP, or Record. The logical path to a folder under <code>FTP</code> root. This is the staging area on the VOD server from which files are ingested to the destination folder.
Streaming Alias (IP or Domain)	Some content hosts (PowerStream, Akamai, etc.) use one host name for FTPing and indexing content, and another host name for streaming content. If necessary, use this field to identify the host name alias for streaming content.
HTTP Tunneling Port	VOD-W, VOD-WM and VOD-D servers can stream to clients via the HTTP protocol. By default this uses port 80. If another process on the server (for example a web server) is also using the HTTP protocol, there will be a conflict on this port. This setting lets you select a different port (1–65535 with limitations) to be used when streaming via HTTP. This setting <i>must</i> correspond with the port setting on the server. See "Assign LAN/Internet Address Range > Always use TCP protocol for MPEG-4 content" in <a href="#">Global Assignments</a> on page 21.
Secondary Server Address	A VOD server can have two addresses: one for Internet users and one for LAN users (see also <b>IP or Domain</b> name above). This is the secondary server address for Internet users. It is the IP address or domain name of a second NIC or a NAT.

Supports HTTP Tunneling?	<i>VOD-W only.</i> Determines whether or not the server supports HTTP tunneling. Default = checked. Go to Global Assignments to actually enable HTTP tunneling. See "Assign LAN/Internet Address Range > Always use TCP protocol for MPEG-4 content" in <a href="#">Global Assignments</a> on page 21. Uncheck if you are using a VOD-W server installed <i>before</i> Portal Server v4.2.
Web Service Port (HTTP)	The Portal Server and the VOD-W communicate using a web service configured to use port 80 by default. If you choose to tunnel over port 80, you must use a different port for the web service communication using this parameter. You must configure the VOD-W to use this same port for the web service. See "Using HTTP Tunneling" in the <i>VOD-W Admin Guide</i> for more details.
Enable URL Password Protection	<i>VOD-W only.</i> Default = unchecked. To enable URL password protection, check the box and enter and confirm a password. <i>The password must match the password configured on the VOD-W server.</i> Default password = <b>vbrickkey</b> . If checked, all video requests sent to VOD-W servers by the ETV Portal Server will have a security token embedded in the URL. The VOD-W server will validate and deny the request if the token is absent or invalid.

## Adding VOD-WM Servers

Although the VOD-WM Enterprise server supports numerous multicast types, the Portal Server creates and displays only "File" multicasts which stream a single file. A Windows Media server administrator can create other multicast types using the Windows Media Services interface but these multicast types are not supported and may not be displayed in the Asset Library. Note that the **Free Space** option (see below) is only available if you run the [EnableQueryDiskSpace.reg](#) utility.

The screenshot shows the 'Add/Modify VoD/FTP Servers' configuration page in the VBrick ETV Portal Server Admin Guide. The interface includes a sidebar with navigation options like 'Getting Started', 'Global Settings', 'Global Assignments', 'Custom Fields', 'Stream Restrictions', 'Servers', 'VBricks', 'Control Devices', 'Set Top Boxes', 'Recorders', 'Script Devices', 'Scripts', 'URLs', 'Emergency Broadcast', 'Program Names', 'Manage PlayLists', 'Access Logging', 'Channels', and 'Modify VOD Content'.

The main content area is titled 'Add/Modify VoD/FTP Servers' and features a table of existing servers:

IP or Domain	Server Description	FTP User Name	Server Type
172.22.115.25	kasenna	vbrickuser	NXG
172.22.130.20	infovalue	vbrickuser	VOD-W
scottmde	windowsmedia	vbrickuser	VOD-WM-STANDARD

Below the table is a form for adding a new server. The 'Server Type' dropdown is set to 'VOD-WM-ENTERPRISE'. The form includes fields for:

- FTP Password: [masked]
- Confirm Password: [masked]
- Domain or Machine Name: [VODWM]
- User Name: [vbrickuser]
- User Password: [masked]
- Confirm Password: [masked]
- Streaming Alias (IP or Domain): [ ]
- HTTP Tunneling Port: [80]
- Secondary Server Address: [ ] (IP or Domain of second NIC or NAT)

At the bottom, there is a table for 'WM Publishing Points':

Name	Source	FTP Directory	Low Space Threshold (MB)	Free Space (GB)
VBP	d:/wmpub/WMRoot	/	20	

Buttons for 'Add', 'Modify', 'Delete', and 'Clear' are located below the table.

Figure 5. Add VOD-WM Server

Domain or Machine Name	When the ETV Portal Server and the VOD-WM server reside in the same domain, this is the name of that domain. When workgroups are being used, this is the machine name of the VOD-WM server. Note: the machine name is <i>not</i> the IP address of the server.	
User Name	The name of a valid user that has administration privileges on the VOD-WM server or the network domain. If the VOD-WM Server is within a domain, the name entered here will be a domain user. That domain user must have administration privileges on the VOD-WM Server. If the VOD-WM Server is part of a workgroup, the name entered here will be a local user with administration privileges on the VOD-WM Server. A local user with administrator privileges having the same name must also exist on the MCS Portal Server.  Note: The MCS Portal Server and VOD-WM Server(s) must all be within a domain or part of a workgroup. Any topology that mixes servers in domains and servers in workgroups will not work or will be extremely slow.	
User Password	The valid password of the user specified above.	
WM Publishing Points	Name	The publishing point on the VOD-WM (default = VBP) server where content will be accessed and managed by the ETV Portal Server. <i>Note: this setting must correspond to an existing, valid publishing point on the server.</i>
	Source	Local path to the publishing point. Default = <b>d:/wmpub/WMRoot</b> . Do not change for first publishing point.
	FTP Directory	Path to user-created FTP directory. See <a href="#">Creating a VOD-WM FTP Server</a> .
	Low Space Threshold	Optional. Default = 20 MB. If the available disk space on this publishing point is less than the specified value, the publishing point with the largest amount of free space will be used.
	Free Space	Optional. This option automatically calculates the free space (in GB) available on disk when you add a new publishing point or refresh the publishing point list. This feature can consume server resources and is disabled by default. To enable (or disable) this option (on VOD-WM servers or File Servers), go to <code>&lt;install_dir&gt;\program files\VBrick\MCS\utils</code> , run <a href="#">EnableQueryDiskSpace.reg</a> or <a href="#">DisableQueryDiskSpace.reg</a> respectively, and reboot the server when done.

### ***Adding Publishing Points to a VOD-WM Server***

In a typical scenario, first you configure the publishing point on the Windows Media server, *then* you configure the publishing point on the Portal Server with matching values. Additional publishing points are required to make content available when you add disk space to a Windows Media server. As shown on the previous window, a Windows Media Server supports multiple publishing points. *In this context, publishing points are used to discover your content via FTP.* Use the following steps, **in the order shown**, to create a new publishing point. Note that as explained below, you must create a virtual FTP directory in IIS for *each* publishing point on the WM Server.

- 
- ▼ To add a publishing point
1. Create an FTP server on the WM server. See [Creating a VOD-WM FTP Server](#) on page 36.
  2. Create a publishing point on the WM Server.
    - a. Go to **Start > Administrative Tools > Windows Media Services**.
    - b. Right-click on the server\_name and select **Add Publishing Point (Wizard)**.
    - c. Add a meaningful publishing point name and click Next.
    - d. Select **Files (digital media or playlists) in a directory** and click Next.
    - e. Select **On-demand publishing point** and click Next.
    - f. Specify the location of your content, for example **d:\WMPub\WMRoot** and click Next.
    - g. Skip through the remaining steps and click **Finish** when done.
  3. To create a virtual directory on the WM server for this publishing point:
    - a. Go to **Start > Administrative Tools > Internet Information Services (IIS) Manager**.
    - b. Navigate to the Default FTP Website. Right-click and select **New > Virtual Directory**.
    - c. For **Alias**, use the Publishing Point name from Step 3 above and click Next.
    - d. Enter the path to the content directory for this FTP site and click Next.
    - e. Allow **Read** and **Write** permissions and click Next.
    - f. Click **Finish** when done.
  4. In the Portal Server, configure the publishing point **Name**, **Source**, and **FTP Directory** to match the values you used for the publishing point on the Windows Media server.

- 
- Note**
- The publishing point name within a server must be unique. You cannot add a publishing point that already exists in MCS database.
  - The publishing point FTP directory within a server must be unique.
  - If free space information is available at the time a publishing point is added, it must be greater than the entered **Low Space Threshold**.
  - Publishing points located within another publishing point are not supported although publishing points on the same drive are supported. For example, two publishing points with **Source c:\pub1** and **c:\pub2** are supported but two publishing points with **Source c:\pub1** and **c:\pub1\pub2** are not supported.
-

## Adding FTP Servers

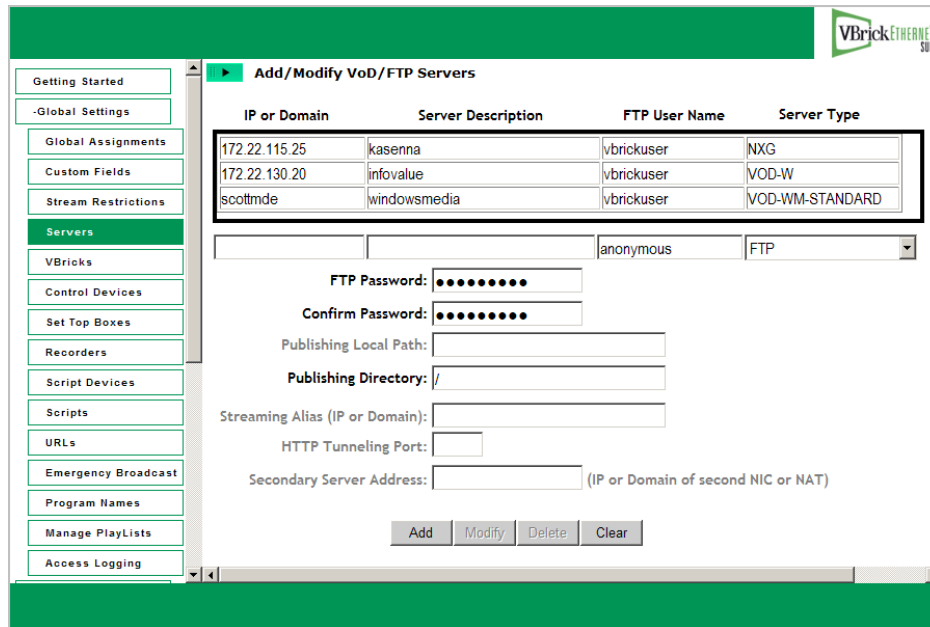

Figure 6. Add FTP Server

### Using Secure FTP

In Portal Server v4.2 or higher, VBrick's FTP client supports secure FTP connections from the end user (client), Portal Server and NVR to the VOD servers. This is accomplished using FTP over SSL (FTPS protocol). Having a client that supports FTPS however, is not enough to have secure FTP connections throughout the system. The FTP servers on all VOD servers also need to support FTPS for a secure connection to exist. If a secure connection cannot be established, the client will revert to the standard FTP protocol. The FTP server on Windows platforms (IIS) does not currently support FTPS. *Therefore, to have secure connections, you must install a third-party add-in on all Windows VOD servers.* Of the various solutions available, VBrick recommends FTP Guardian. FTP Guardian is a wrapper for IIS that serves as a proxy between a secure client and an unsecured IIS. You change the FTP port of IIS to an arbitrary port (10021 for example), then you start the FTP Guardian service. It binds to port 21 and all incoming FTP clients communicate using a secure front that proxies the calls to IIS on port 10021. Be aware that this add-on, for Windows servers only, is not sold or supported by VBrick. It requires a server wrapper and additional .dlls.

#### ▼ To install FTP Guardian

1. Go to [http://www.tcpdata.com/ftpg\\_license.shtml](http://www.tcpdata.com/ftpg_license.shtml)
2. Click and run **Download ftp Guardian Server Wrapper - 600K** on the VOD server.
3. Click **Download SSL Libraries - 380K** on the VOD server.

Then open the .zip file and copy [libeay32.dll](#) and [ssleay32.dll](#) into [C:\Program Files\ftpgs](#)

### Creating a VOD-WM FTP Server

If you are using a VOD-WM-Enterprise or VOD-WM-Standard (Microsoft Windows Media) server, you must install and configure a standard FTP server on the VOD-WM server as explained below. (For more about Microsoft Windows Media servers see [ETV VOD Servers](#) on page 6.)



▼ To create a Microsoft Windows Media FTP server

*On the Microsoft Windows Media Server:*

1. Install the FTP server.
2. Set the default FTP directory to the Microsoft Windows Media Server's default Publishing Point directory.
3. Create and configure an FTP user account with full permissions (read/write, rename/delete etc.) on the directory specified above. If using the VBrick default, this account's user name is **vbrickuser** and the password is **vbrickuser**. Hint: use the settings of the **anonymous** account as an example.
4. Verify that the directory specified in Step 2 above is set to allow the FTP user account full permissions.

*On the Portal Server:*

5. When the Microsoft Windows Media Server is created or modified, specify the user name and password created in Step 3 above in the **FTP User Name** and **FTP Password** fields on the **Add/Modify VOD/FTP Servers** page.

### Creating a VOD-D FTP Server

If you are using a VOD-D (Darwin) server, you must install and configure a standard FTP server on the VOD-D server as explained below. (For more about Darwin servers see [ETV VOD Servers](#) on page 6.)

▼ To create a Darwin FTP server

*On the Darwin Server:*

1. Install a standard FTP server on port 21.
2. Set the default FTP directory to the Darwin Server's Media Folder directory (also called the Publishing Point) or create a virtual directory of the FTP root pointing to the Darwin server's Media Folder.
3. Create and configure an FTP user account with full permissions (read/write, rename/delete etc.) on the directory created above. If using the VBrick default, this account's user name is **vbrickuser** and the password is **vbrickuser**. Hint: use the settings of the **anonymous** account as an example.
4. Verify that the directory created in Step 2 above is set to allow the FTP user account full permissions.

*On the Portal Server:*

5. When the Darwin Server is created or modified, specify the user name and password created in Step 3 above in the **FTP User Name** and **FTP Password** fields on the **Add/Modify VOD/FTP Servers** page.

### Adding File Servers

Any Windows computer with an FTP server running can be configured as a progressive download file server (for Windows Media files only). Progressive download is a method of delivering audio and video that involves caching and playing the downloaded portion of a file while a download is still in progress via FTP. Recorded WM files are automatically ingested to all VOD and file servers if the user has access rights and publishing permissions. A progressive download file server can provide secure (encrypted) playback if configured for SSL. (Note: You can also use a WM encoder with a hard drive for progressive download. See

VBrick Configuration on page 43.) Note that the **Free Space** option (see below) is only available if you run the [EnableQueryDiskSpace.reg](#) utility.

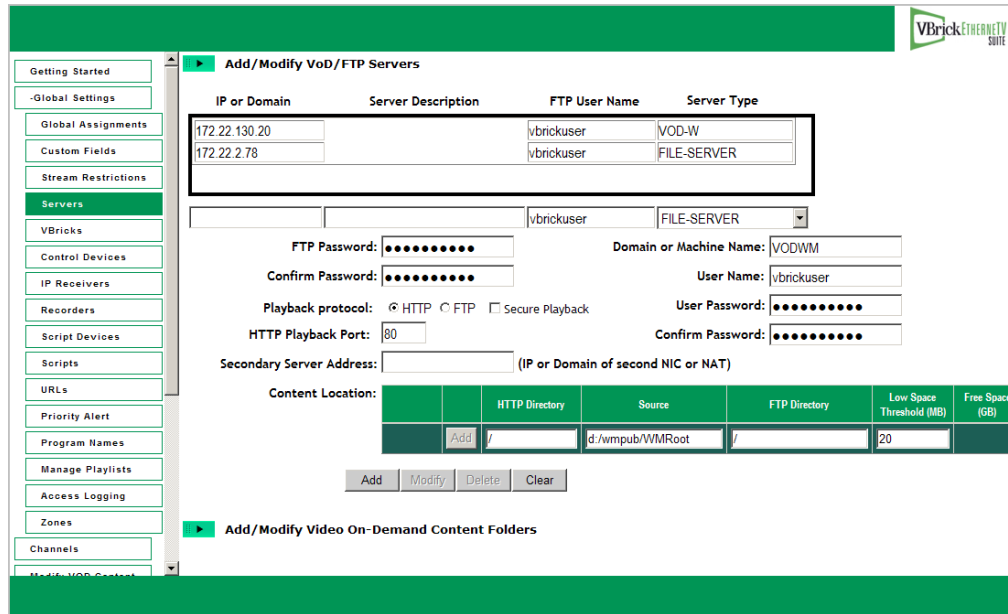

**Figure 7.** Add File Server

Playback Protocol	<ul style="list-style-type: none"> <li>• HTTP – Use HTTP if there is a web server running on the file server. For details, see <a href="#">Using HTTP Playback</a> below.</li> <li>• FTP – Use FTP if there is no web server running on the file server. For details, see <a href="#">Using FTP Playback</a> below.</li> <li>• Secure Playback – Use Secure Playback if the file server is configured for SSL. For details, see <a href="#">Using Secure Playback</a> below.</li> </ul>
HTTP Playback Port	<ul style="list-style-type: none"> <li>• 80 – default port for HTTP playback.</li> <li>• 443 – default port for HTTPS playback. To use Secure Playback, the file server must be configured for SSL.</li> </ul>
Domain or Machine Name	Displayed when <b>Free Space</b> option is enabled. When the Portal Server and the file server reside in the same domain, this is the name of that domain. When workgroups are being used, this is the machine name of the file server. Note: the machine name is <i>not</i> the IP address of the server.

User Name	<p>Displayed when <b>Free Space</b> option is enabled. The name of a valid user that has administration privileges on the file server or the network domain. If the file server is within a domain, the name entered here will be a domain user. That domain user must have administration privileges on the file server. If the file server is part of a workgroup, the name entered here will be a local user with administration privileges on the file server. A local user with administrator privileges having the same name must also exist on the Portal Server.</p> <p>Note: The MCS Portal Server and file server(s) must all be within a domain or part of a workgroup. Any topology that mixes servers in domains and servers in workgroups will not work or will be extremely slow.</p>	
User Password	<p>Displayed when <b>Free Space</b> option is enabled. The valid password of the user specified above.</p>	
Content Location	HTTP Directory	<p>Shown if playback protocol is HTTP. The virtual directory on the file server where content will be accessed and managed by the ETV Portal Server.</p>
	Source	<p>The complete path to the physical location of the content on the file server.</p>
	FTP Directory	<p>Path to a user-created virtual FTP directory. See <a href="#">Adding FTP Servers</a> on page 36 for more information.</p>
	Low Space Threshold	<p>Optional. Default = 20 MB. If the available disk space on this publishing point is less than the specified value, the publishing point with the largest amount of free space will be used.</p>
	Free Space	<p>Optional. This option automatically calculates the free space (in GB) available on disk when you add a new publishing point or refresh the publishing point list. This feature can consume server resources and is disabled by default. To enable (or disable) this option (on VOD-WM servers or File Servers), go to &lt;install_dir&gt;\program files\VBrick\MCS\utils, run <a href="#">EnableQueryDiskSpace.reg</a> or <a href="#">DisableQueryDiskSpace.reg</a> respectively, and reboot the server when done.</p>

## Using HTTP Playback

If you select HTTP for **Playback Protocol**, Figure 8 shows sample content location. The FTP server has three corresponding publishing directories that map to three local paths. These publishing directories are needed for the Portal Server to discover contents in the file server and to publish new content. The file server also has a web server running with three corresponding HTTP directories that map to those three local paths. The Portal Server constructs an HTTP URL for each file and the Portal Server client downloads the file from the web server inside the file server. By default, HTTP is played back over Port 80.

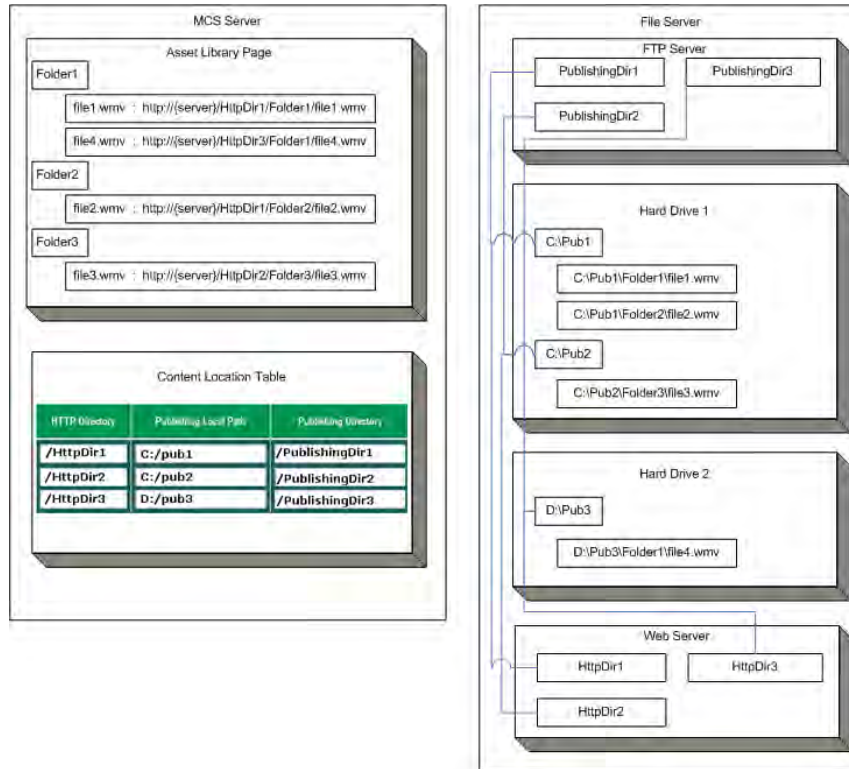

**Figure 8.** Content Location for HTTP Playback

## Using FTP Playback

If you select FTP for **Playback Protocol**, Figure 9 shows sample content location. In the example there are three folders: **c:\Pub1**, **c:\Pub2** and **d:\Pub3**. The FTP server has three publishing directories that map to those three folders. (Note that only one publishing point is actually required.) The Portal Server constructs an FTP URL for each file and the Portal Server client downloads the file from the FTP server inside the file server. Multiple content locations can on the same hard drive. For example, **c:\pub1** and **c:\pub2** are on drive C. This is necessary to preserve the current file structure on the file server but you cannot create a content location inside another content location. Secure FTP playback is not supported. Note that Portal Server users cannot create thumbnails when **Playback Protocol** is set to FTP.

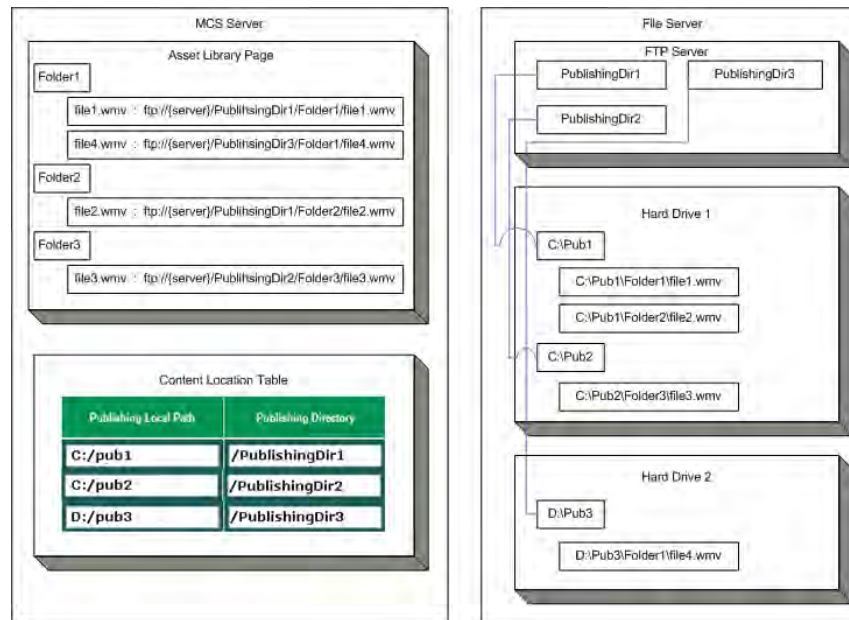

**Figure 9.** Content Location for FTP Playback

## Using Secure Playback

If you select Secure Playback for **Playback Protocol**, the file is progressively downloaded *and* encrypted. In order to use secure playback, the *file server* must be configured for SSL with a digital X.509 certificate from a trusted certificate authority. Secure download is only valid for HTTPS. By default, HTTPS is played back over Port 443. Note that Portal Server users cannot create thumbnails when **Playback Protocol** is set to Secure Playback.

**Note** A file server using secure playback can be configured with an IP address or a host name. If the server certificate is issued for an IP address, you must use the IP address; if issued for a host name, you must use the host name. Otherwise, the video will not play and a message will indicate the security certificate was issued for a different website.

## Add/Modify Video On Demand Content Folders

**Add/Modify Video On Demand Content Folders** can be used to organize content on a specific Video-on-Demand server. The Portal Server periodically polls certain folders for presence of content and if found ingests the content onto multiple VOD servers. Any files FTPed into a particular folder in the Autoingest folder will automatically be ingested into the corresponding folder on the VOD server(s). You must add these folders using the window shown below. (See [Auto Content Ingestion](#) on page 139 for more about autoingestion.) Existing folder structures on a VOD server will be mirrored in the Portal Server. However you will still need to associate those folders with other server(s) if the file is to be autoingested onto multiple servers.

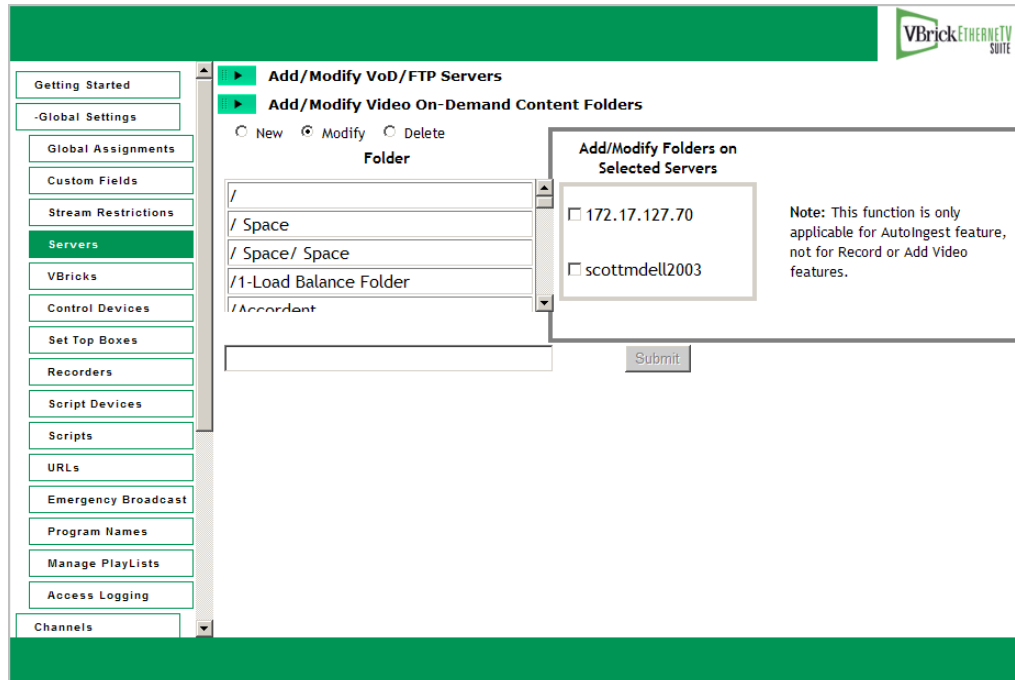

This function is useful for VBrick VBStar appliances to easily transfer content from their hard drives to the VOD server. (It can also be helpful for users who acquire content outside of the ETV Portal Server, for example from StreamPlayer Plus.) When a folder is created, you must check a box in **Add/Modify Folders on Selected Servers** to associate the folder with a server for autoingestion. ETV Portal Server checks these folders every 5 minutes and ingests new content if present. This feature only applies to Autoingest; it does not apply to **Record** or **Add Video**.

Note that empty folders are not displayed on the Portal Server client interface. These folders are only displayed when they have content. As the folder structure is created in this section, autoingest folders will be created in the FTP root path. For example, if the FTP root path is `d:\inetpub\ftproot`, then folders that are created in the **Add/Modify On-Demand** content folders will also be created in the `d:\inetpub\ftproot\mcs\autoingest` folder.

Autoingested content can go into any folder that has been associated with a server or servers using the **Add/Modify Folders on Selected Servers** check boxes shown above. If using a VBStar, be sure to associate a folder with a server for autoingest. This enables the folder that the VBStar will FTP files into. This function is not associated with a user or group permission and is controlled only by the Administrator. See [Auto Content Ingestion](#) on page 139 for a more detailed description of the Autoingestion functionality.

---

**Note** Use the **Delete** button to remove non-empty folders only. Use the **Modify** button to change AutoIngest settings in the **Add/Modify Folders on Selected Servers** pane.

---

## Creating Subfolders

Use the following steps to create a subfolder in an existing folder.

▼ To create a subfolder

1. Highlight any existing folder name, for example `/Bill` as shown in the previous window, and click **New**.

2. Type the new subfolder name in the text field, preceded by a forward slash, for example `/Bill/temp`, and click **Submit** when done.

## VBricks

All VBricks must be configured in ETV Portal Server before they can be managed and used for scheduled events. (VBrick configuration is only required if you are using the **Scheduling** feature. Once configured, all VBricks in the system are shown on the following window. In the ETV Portal Server, SAP (Session Announcement Protocol) announcements are sent to the Portal Server by network-connected VBrick devices (encoders and/or decoders). The **Select VBrick** panel in the next screen shows VBrick appliances (encoders and decoders) that have announced their presence on the network but have not been configured for use in ETV Portal Server. (Note that if you delete a VBrick from the **Currently Configured VBrick List**, it will not be shown as available until you logout and log back in to the Admin Console.)

### VBrick Configuration

- ▼ To add a VBrick configuration
  1. Go to **Global Settings > VBricks**. The information in the panel indicates whether a VBrick can be used for multimedia or for progressive download (as a VOD server).

Use this page to manage the VBricks Configuration of the system. Here you can:

- Add VBricks
- Modify VBricks
- Delete VBricks

or you can select an operation to perform (i.e. Modify or Delete), select item[s] from the list located to the right and click the Submit button.

VBrick Host Name	IP Address	Model Number	Multimedia VBrick	VOD Server
App-7101H-1	172.22.118.69	920X-42XX-0XXX	No	
JohnS-WM-3	172.22.2.103	919X-42XX-YXXX	No	Capable

2. Select **Add VBricks** and click **Submit**.

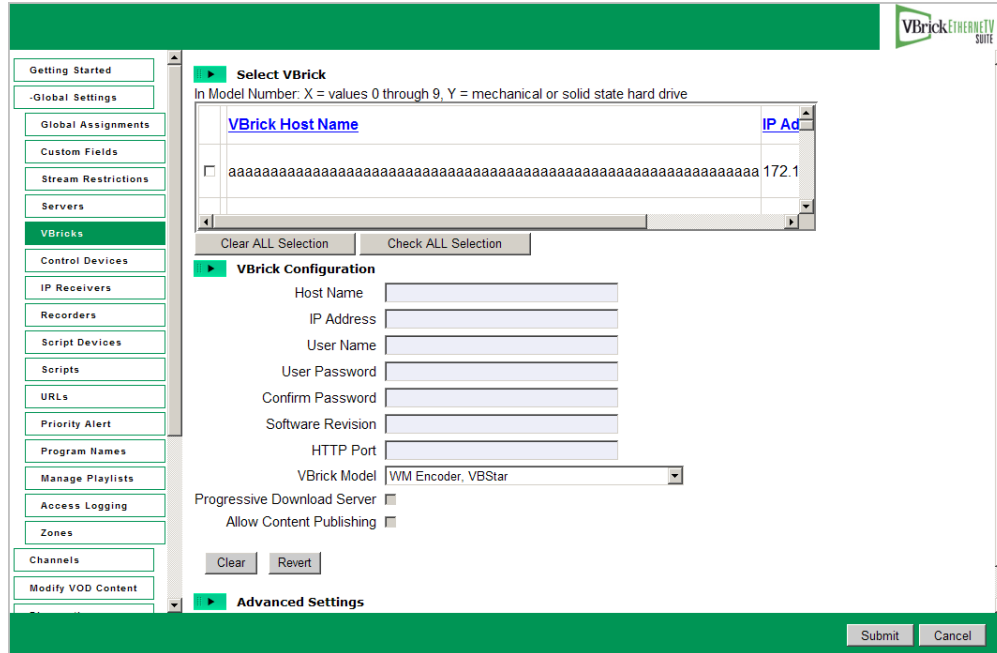

3. In **Select VBrick**, select one or more existing VBricks for which a SAP has been received. If you select one VBrick, this populates the **VBrick Configuration** panel. (If you select multiple VBricks, it does not populate the panel; if you need to configure the VBricks, you must add them one at a time.)
4. Complete or modify the fields in **VBrick Configuration** as necessary. Note that you must enter a User Name and Password and confirm that Password or the configuration will fail.
5. Click **Submit** when done. This adds the new configuration to the list of configured VBricks shown on the previous page.

**Note** The only time you will manually complete the VBrick Configuration fields is when you are defining the configuration for a VBrick that will be added to the network at a later time. In this case, you will need to know the following configuration data in advance.

Host Name	Required. Host name of VBrick.
IP Address	Required. IP address of VBrick.
User Name	Defaults to system-defined value if blank.
User Password	Defaults to system-defined value if blank.
Confirm Password	Defaults to system-defined value if blank. Must match User Password if entered above.
Software Revision	Optional. To get the Software Revision, use IWS (for MPEG and WM) or VBAdmin (for H.624).
HTTP Port	Optional. To get the HTTP Port, use IWS (for MPEG and WM) or VBAdmin (for H.624).
VBrick Model	Select from the dropdown. Advanced settings are enabled if you select an encoder or a VBStar.



Progressive Download Server	Check this box to enable a WM encoder (with v4.2.1 or higher software) with a hard drive (a VBStar) as a progressive download server. All .wmv files stored in the D:\public folder of the VBStar will be available in the Asset Library for progressive download. (You can also use a file server for progressive download. See <a href="#">Adding File Servers</a> on page 37.)
Allow Content Publishing	All WM recordings will be published to the VOD servers <i>and</i> to this VBStar if the user has access rights and publishing permissions. Note that ingestions to the VBStar will fail when the 60 GB hard drive is full.

## Advanced Settings

Advanced settings are enabled if you select a VBrick encoder or a VBStar. *Note that the Portal Server will attempt to retrieve and autofill the Multicast IP addresses and Port numbers.* You can modify these fields as necessary.

**Note** The following values are stored in the Portal Server database only. Depending on how a scheduled event is configured, they may be saved and written back to the VBrick device after the scheduled event runs.

Multicast IP	Destination multicast IP address.
Video Port	Destination video port.
Audio Port	MPEG-4 devices only. Destination audio port.
CC Port	MPEG-4 devices only. Closed captioning port.

## Multimedia VBrick Configuration

These settings are only enabled when you add or modify a VBrick that has a WM encoder in at least one slot. By completing these fields you are defining the encoder as a **Multimedia VBrick** that can be used in specialized end-user environments. For example, in some environments, the Portal Server can be configured to use a multimedia VBrick for rich media presentations. In this scenario, the settings for **Resolution**, **Target Bit Rate**, and **Audio Bit Rate** are used at presentation runtime and will override existing settings on the VBrick encoder.

The screenshot shows the VBrick Configuration interface. On the left is a navigation menu with options like 'Getting Started', 'Global Settings', 'Global Assignments', 'Custom Fields', 'Stream Restrictions', 'Servers', 'VBricks', 'Control Devices', 'IP Receivers', 'Recorders', 'Script Devices', 'Scripts', 'URLs', 'Priority Alert', 'Program Names', 'Manage Playlists', 'Access Logging', 'Zones', and 'Channels'. The 'VBricks' section is selected. The main area is titled 'VBrick Configuration' and 'Advanced Settings'. Under 'Multimedia VBrick Config', 'VBrick Slot 1' is shown with the following settings: 'Slot 1 is a Multimedia Slot' (checked), 'Include CC and Metadata' (checked), 'Description' (BW:), 'Resolution' (As Configured), 'Target Bit Rate' (blank), 'Audio Bit Rate' (As Configured), and 'E-Mail Template' (dial in # 044-435-2451). There is a table for 'URL' with one entry: 'http://172.22.2.52/vodafone1' with 'Edit Row' and 'Delete' links. At the bottom, there are 'Add Viewing URL', 'Add Publishing Point', and 'No Publishing Points currently exist' buttons. 'Submit' and 'Cancel' buttons are at the bottom right.

Slot 1 is a Multimedia Slot	Default = not checked. Lets you define the multimedia-specific fields listed below. Slot 2 (if present) can also be configured for multimedia.
Include CC and Metadata	Default = not checked. Include closed captions and metadata if available in the stream.
Description	Text field used for descriptive text.
Resolution	Select an available resolution from the dropdown or choose <b>As Configured</b> to use the current VBrick setting.
Target Bit Rate	Enter desired value. Blank = use current VBrick setting.
Audio Bit Rate	Select from an available audio bit rate from the dropdown or choose <b>As Configured</b> to use the current VBrick setting.
E-Mail Template	This field, used with custom applications, adds the specified text to an auto-generated e-mail and ensures that the e-mail recipient can connect to the right VBrick encoder.

Add Viewing URL	To see this field, you must first "Add" the VBrick and then go back in and select "Modify". Enter a fully qualified path to the Windows Media Server and Publishing Point that will be hosting the video. For example: <a href="http://www.WM_Server_IP_Address/Publishing_Point">http://www.WM_Server_IP_Address/Publishing_Point</a>
Add Publishing Point	Do not use. This field is reserved for future use.

## Control Devices

 Control devices let you configure a video source device so that it can be controlled by end users from the Portal Server user interface. (An example of a video source device is a DVD or VCR directly connected to a VBrick encoder.) Once configured, a special icon on the **Live Broadcasts** page indicates you can control the stream using a "virtual" remote control panel as shown in Figure 10 below. VBrick currently supports DVDs and VCRs from several different manufacturers as well as the VBrick VBIR remote controller that can be customized for use with a wide variety of source devices. See [Adding User-Defined VBIRs](#) below for more about VBIRs.

**Note** In some cases you may be able to control a source device using the front panel or the handheld remote that came with the unit, but this is not always possible. For example, if the remote gets lost or the source DVD and/or VCRs are rack-mounted in an inaccessible metal enclosure, you *must* use the Portal Server interface or a VBIR.

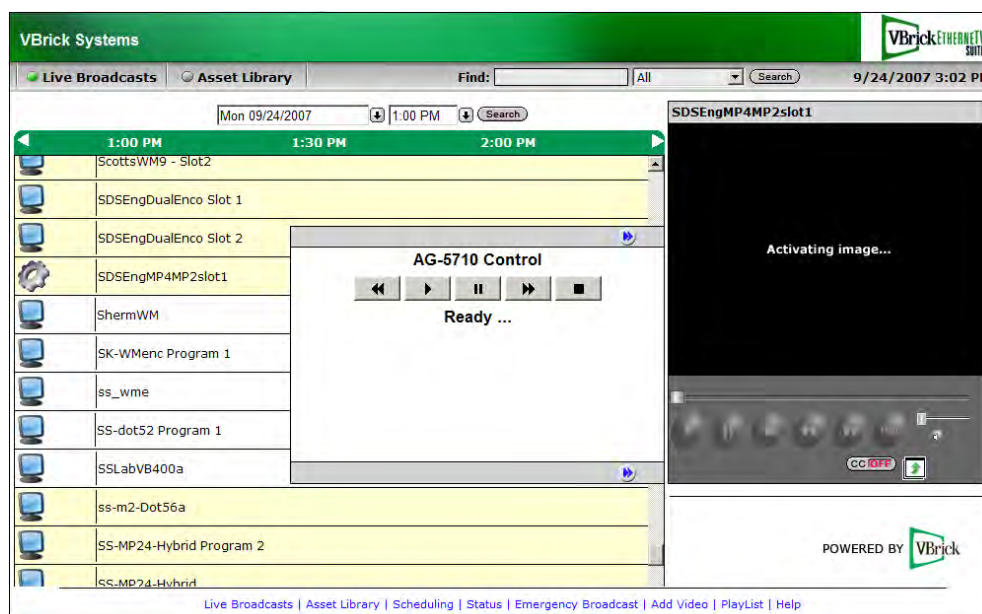

**Figure 10.** "Virtual" Remote Control Panel on Live Broadcasts Page

As shown in Figure 11 below, the remote control panel will have a different graphical user interface depending on whether the source device is directly attached (via a serial port connection) or uses a VBIR. The control panel interface for direct-connect devices varies according to the specific device you select; the control panel interface for VBIR-connected devices is the same for all VBIR devices (unless manually changed as in Figure 12).

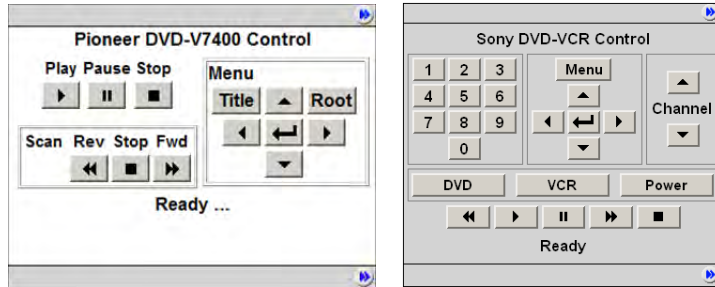

**Figure 11.** Control Panel for Direct-Connect Devices (left) and VBIR Devices (right)

**Note** The Amino set top box does not recognize "control devices." Any video source devices configured as **Control Devices** in the Portal Server will not display a "virtual" remote control panel on the Amino set top box.

## Adding Control Devices

Use the following windows to define or modify control devices. As noted, these devices will be displayed on the **Live Broadcasts** page with a special icon for any users with access to that encoder. *If the device is used as a source encoder for a scheduled broadcast, however, only the user who actually created the schedule will have access during the scheduled period.* This prevents other users from potentially interrupting the broadcast. If the Portal Server does not have a Scheduling license, all control devices are available at any time to any user with VBrick access and other permissions. See "Using the Scheduler" in the *Portal Server User Guide* for an explanation of how to schedule events for control devices.

▼ To define a control device

1. Go to **Global Settings > Control Devices** and select **Add Control Devices**.

Use this page to manage VBrick Control Devices in the system. Here you can:

- Add a Control Device
- Modify a Control Device
- Delete Control Devices

or you can select an operation to perform (i.e. Modify or Delete), select item[s] from the list located to below and click the Submit button.

**Control Devices List**

Name	Device	Source	Slot #	Live Video Stream URL
AG-5710	Panasonic AG-5710	SDSEngMP4MP2	1	-
Sony VCR/DVD	Sony SLV-D380P - SpitFIRE III	ScottsMPEG2	1	-
Stan JVC	JVC SR-S365U	-	-	A-Stan_WM

Submit

2. Complete the fields on the next screen as explained below and click **Submit**.

Name	Enter a unique, descriptive name that will be displayed on the virtual remote. For example in Figure 10, "Sony DVD" is the configured name shown on the controller. No embedded spaces or special characters are allowed.
Device	Select a device from the dropdown list. The list shows serial port direct-connect devices and VBIR (SpitFire) commanded devices that are tested and supported by VBrick. It also shows any custom VBIR devices you have added. Creating User Defined VBIR custom devices is explained below. <b>You cannot create custom serial port direct-connect devices.</b> If the source device you wish to control does not have a serial port, you must use a VBIR for remote control.
Source	Select as the source either a VBrick encoder or a Live Video Stream URL (identified by URL) from the dropdown list. The Device that was selected above will be associated with the specified Source. Selecting a Live Video Stream URL requires that you specify an IP address and port. Enter these in the IP and Port fields that are displayed when you select a Live Video Stream URL. <div data-bbox="609 1522 1015 1659" style="border: 1px solid gray; padding: 5px; margin: 10px 0;"> Name: <input type="text" value="Stan JVC"/>  Device: <input type="text" value="JVC SR-S365U"/>  Source: <input type="text" value="A-Stan_WM - URL"/>  IP: <input type="text" value="172.22.2.1"/> Port: <input type="text" value="4321"/> </div>
User Defined VBIRs	Select the SpitFire version you have (SpitFire II or III) and enter a Description and a three-digit Code (see <a href="#">Adding User-Defined VBIRs</a> below).

## Adding User-Defined VBIRs

The VBrick VBIR is an external hardware device that uses the passthrough port on a VBrick to send control commands *via an infrared link* to third-party devices like VCRs, DVDs, etc. (see Figure 13 for a visual schematic). You must use a VBIR if the target third-party device does not have a serial port that can directly connect to a VBrick encoder. The VBIR can be programmed with codes representing IR command sets that are compatible with devices from many manufacturers. Use the following window to create a custom **User Defined VBIR**. Enter a device description (20 characters or less), a three-digit code, and select the SpitFire model. When done, the new device is added to the **User Defined VBIRs** list as well as to the **Source Device** dropdown list. For a current list of VCR/ DVD device codes for SpitFire II models, go to <http://innotech.com/spitfire-ii-device-codes.pdf> For SpitFire III models, go to <http://innotechsystems.com/Spitfire/SpitFire III.pdf> Be aware that the device codes at this link are not tested or supported by VBrick. If you can't find the code you need, or have trouble controlling a non-supported device, check the product documentation or contact the manufacturer.

**Note** The VBIR Model SpitFire III can be programmed to use IR commands much like a universal remote controller. These "learned" commands are stored in VBIR memory. See [Updating the VBIR Command Set](#) on page 53 for details.

The screenshot shows the 'Control Device Configuration' window in the VBrick EthernetTV Suite. The 'User Defined VBIRs' section is active, displaying a table for defining VBIRs. The table has columns for Description, Code, SpitFIRE Model, Button, Text, Function, and Command. An example entry is shown for 'Sony DVD-VCR Control' with a code of 49 and a function of XIR49. The window also includes a sidebar with navigation options and a 'Submit' button.

Description	Code	SpitFIRE Model	Button	Text	Function	Command
Sony DVD-VCR Control	49	III	Aux 1	DVD	XIR49	49
			Aux 2	VCR	XIR50	50
			Aux 3	Power	Power	22

## Adding a SpitFire Model III VBIR

The VBIR user interface on the Portal Server is designed for the Sony SLV-D380P DVD-VCR player (supported by VBrick). The default interface is shown on the left in Figure 12 but can be modified for use with other devices. You can add your own labels and functionality to the **Aux 1**, **Aux 2**, and **Aux 3** buttons as shown on the right in Figure 12.

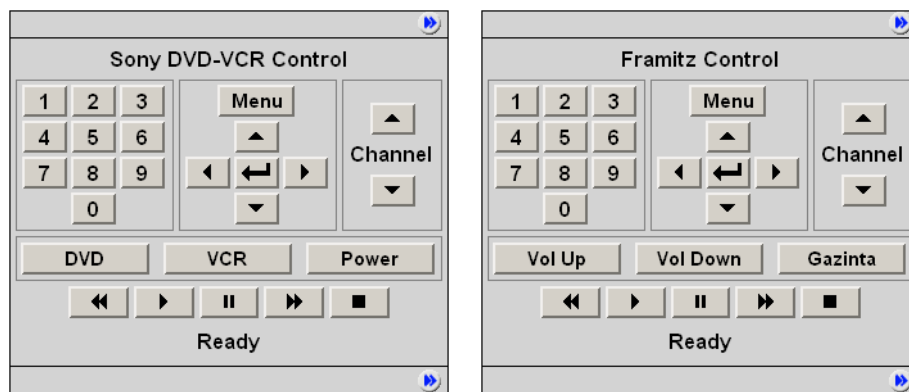

**Figure 12.** Modifying the SpitFire III Control Panel

In the default configuration there are three "auxiliary" buttons for toggling between **DVD** mode and **VCR** mode plus a **Power** button. The auxiliary buttons are configurable in that you can modify the button label and the associated instruction that will be sent to the VBIR. For example, suppose you want to support the Framitz device, and instead of buttons for DVD, VCR and Power, you want **Vol Up**, **Vol Down** and the special **Gazinta** function.

You can do this by selecting a SpitFire Model III. The auxiliary button definitions will initially display the default values (corresponding to the Sony SLV-D380P). You define the **Text**, **Function** and/or **Command** for each Aux button with an appropriate value—usually obtained in advance from the manufacturer. *It is the customer's responsibility to determine which functions and/or commands to specify for the buttons.* When done, The User Defined VBIR is saved and configured with a VBrick. The buttons will map properly and correctly perform the defined functions.

## Connecting Control Devices

To set up a device that can be remotely controlled from the Portal Server, you connect the serial interface on the source device (the DVD or VCR) to the passthrough port (COM1 or COM2 for Slots 1 and 2 respectively) on the VBrick encoder using an appropriate cable (see Table 11) from those shipped with the encoder. For more about Serial Port Passthrough, see the online help for the encoder. You can also control devices using VBrick's VBIR remote controller. To use the VBIR remote controller, you connect the VBIR SpitFire device to COM1 or COM2 on the VBrick encoder. The VBIR subsequently communicates with the DVD or VCR via infrared commands (see Figure 13) at the configured baud rate.

If necessary, connect one end of the XIR emitter cable to the SpitFire and the other to the DVD or VCR making sure the adhesive lead is securely attached to the device. The emitter is used when there is no direct line-of-sight to a control device (for example when the VCR is in a cabinet) and you can't use the remote control. On the back of the VBIR, be sure the SpitFire is in RS-232 mode.

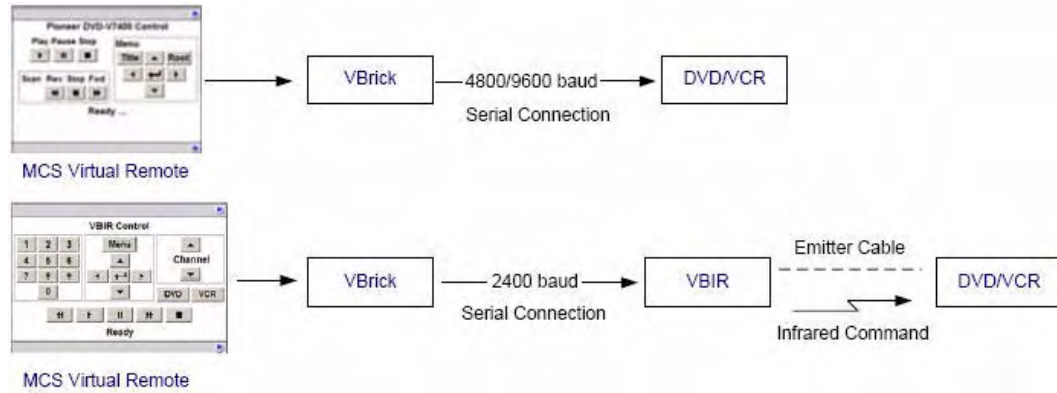

**Figure 13.** Connecting Control Devices

**Table 11.** Device Connectors

Device	Connector
VCR	DB-9 †
DVD	DB-15 †
MPEG-1 Encoder	DB-9
MPEG-2/4/WM Encoders	RJ-45

† Typical device connector.

### *Configuring Control Devices*

You also need to configure the baud rate and passthrough state of the VBrick associated with a control device. In VAdmin, go to the **System Configuration > Advanced Configurations > Passthrough** page and set these values as follows:

**Table 12.** Baud Rate and Passthrough State

Device	Baud Rate	Passthrough State
DVD	4800	Responder
VCR	9600	Responder
VBIR	2400	N/A



The screenshot shows the VBrick Integrated Web Server Administration/Configuration interface. The page title is "INTEGRATED WEB SERVER Administration/Configuration". A navigation bar at the top includes links for CONFIGURATION, STATUS, DIAGNOSTIC, MAINTENANCE, HELP, HOME, and LOGOUT. On the left, a "Configuration" sidebar lists options: Network, Encoder, Reflector, FTP File Transfer, Passthrough (selected), System, and Script Management. Below the sidebar are "END EDIT" and "SAVE CONFIG" buttons. The main content area is titled "Configuration: Passthrough" and features a text input field containing "COM1 COM2". Below this is a "Passthrough State" dropdown menu set to "Responder" and an "APPLY" button. Further down, several settings are listed with dropdown menus: Baud Rate (4800), Stop Bits (1), Parity (None), RTS Control (Automatic), and DTR Control (Automatic). The "Operational State" is shown as "Ready". At the bottom of the configuration area are three buttons: "APPLY", "REVERT", and "DEFAULTS".

## Updating the VBIR Command Set

EtherneTV Portal Server Control Devices use SpitFire model VBIRs to manipulate DVDs, VCRs or other devices controlled by IR commands. The VBIR contains an internal library of several hundred IR command sets stored in flash memory. The internal library is accessed by a three digit code. The VBIR internal library supports a wide range of devices from many, but not all, device manufacturers. If the IR command set for a particular device is not stored in the internal library there are two ways (as explained below) that the VBIR can be enhanced to control the device.

### Learning IR Commands

The VBIR (Spitfire Model III only) can be set to learn and store IR commands like a universal remote controller. Learned commands are stored in VBIR memory areas called slots and are accessed by reserved three-digit codes. The six slots are available are: AUX (994), TV (995), VCR (996), DVD (997), AUD (998), and CBL/SAT (999). Once learned IR commands are stored on a VBIR they can be written as an external library file on a PC. The IR commands in an external library file can be learned by other VBIRs through the process of cloning. For more information, see the application note [Learning IR Commands on the VBIR](#) on the [www.vbrick.com/documentation](http://www.vbrick.com/documentation) page.

### Downloading External Libraries

The VBIR can be upgraded by downloading an external library file. External library files contain IR command sets for a specific device or devices. External library files are supplied by a third party or created using the SpitFire VBIR learning mode. For more information, see the application note [Downloading External Libraries to the VBIR](#) on the [www.vbrick.com/documentation](http://www.vbrick.com/documentation) page.

## IP Receivers

IP Receivers (formerly called STBs or Set Top Boxes) must be configured in ETV Portal Server before they can be managed and used for scheduled events. (IP Receiver version must also be 3.7.1 or higher.) Once configured, all IP Receivers in the system are shown on the

following window. The **Select IPR** panel in the next screen shows IPRs that have announced their presence on the network but have not been configured for use in the Portal Server.

▼ To add an IPR configuration

1. Go to **Global Settings > IP Receivers**.

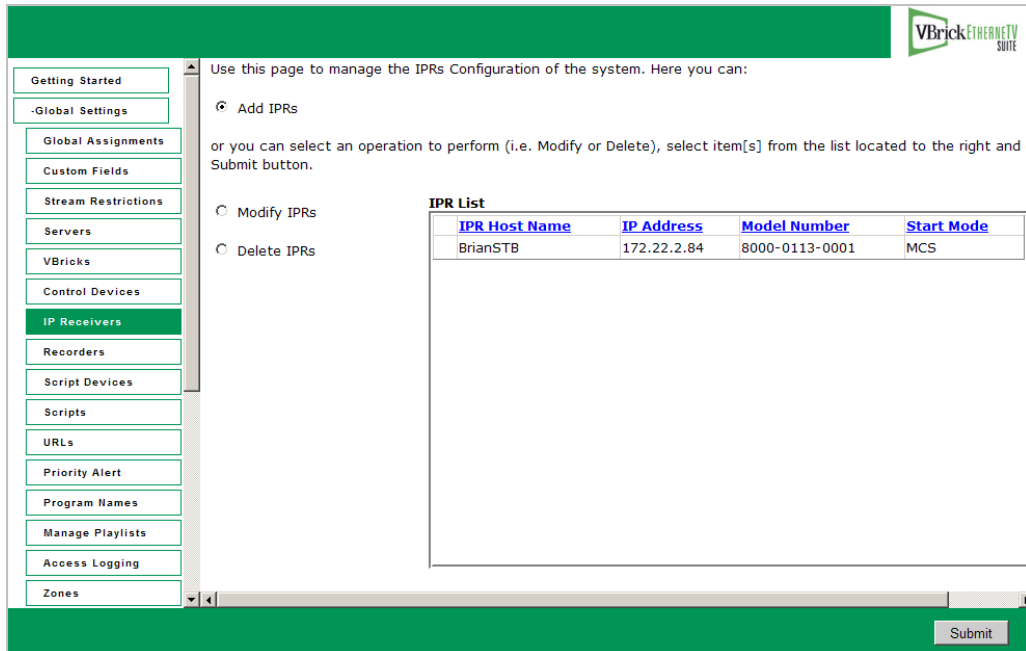

2. Select **Add IPRs** and click **Submit**.

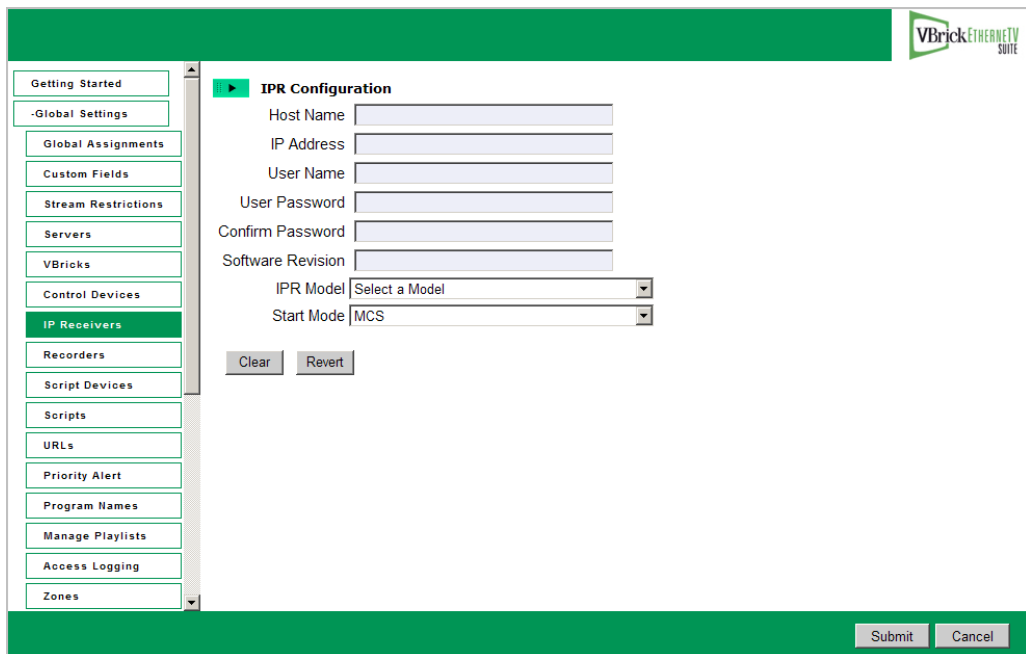

3. In **Select IPR**, select one or more existing IPR for which a SAP has been received. This populates the **IPR Configuration** panel. (If you select multiple IPRs, it does not populate the panel; if you need to configure the IPRs, you must add them one at a time.)

4. Complete or modify the fields in **IPR Configuration** as necessary and click **Submit**. This adds the new configuration to the list of configured IPRs shown on the previous page.

---

**Note** The only time you will manually complete the IPR Configuration fields is when you are defining the configuration for an IPR that will be added to the network at a later time. In this case, you will need to know the configuration data in advance.

---

Host Name	Required. Host name of IPR.
IP Address	Required. IP address of IPR.
User Name	Defaults to system-defined value if blank.
User Password	Defaults to system-defined value if blank.
Confirm Password	Defaults to system-defined value if blank. Must match User Password if entered above.
Software Revision	Optional.
IPR Model	Select from the dropdown.
Start Mode	Select from the dropdown: ETV Portal Server, Local, or Local-Fullscreen

## Recorders

A Recorder server enables recording by Portal Server users. If a recorder server is not created here, any attempt to record a live stream or a stored video will fail. Once enabled, users must also be assigned the appropriate permissions (see [Allow Content Recording](#) on page 112). (Note: Do not confuse a Recorder server with a Network Video Recorder which is a separate product. See the *ETV Network Video Recorder Release Notes* for more information.)

---

**Note** By installation default, all recordings are stored on the D: drive. If you install ETV Portal Server on a system without a D: drive, you must subsequently go to **Global Settings > Recorders** and change the record path as necessary. Also, the **Max Recording** field shows the default number of concurrent recording sessions allowed. *If you need more than 2 concurrent recording sessions, you must purchase a Network Video Recorder.*

---

- ▼ To add a Recorder configuration
  1. Go to **Global Settings > Recorders**.

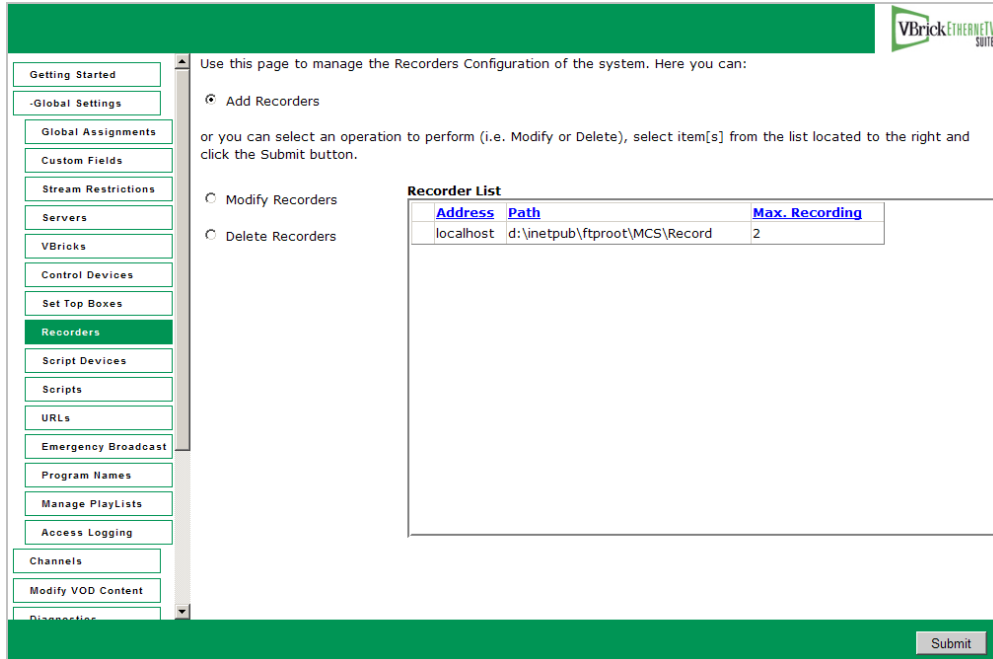

2. Select **Add Recorders** and click **Submit**.

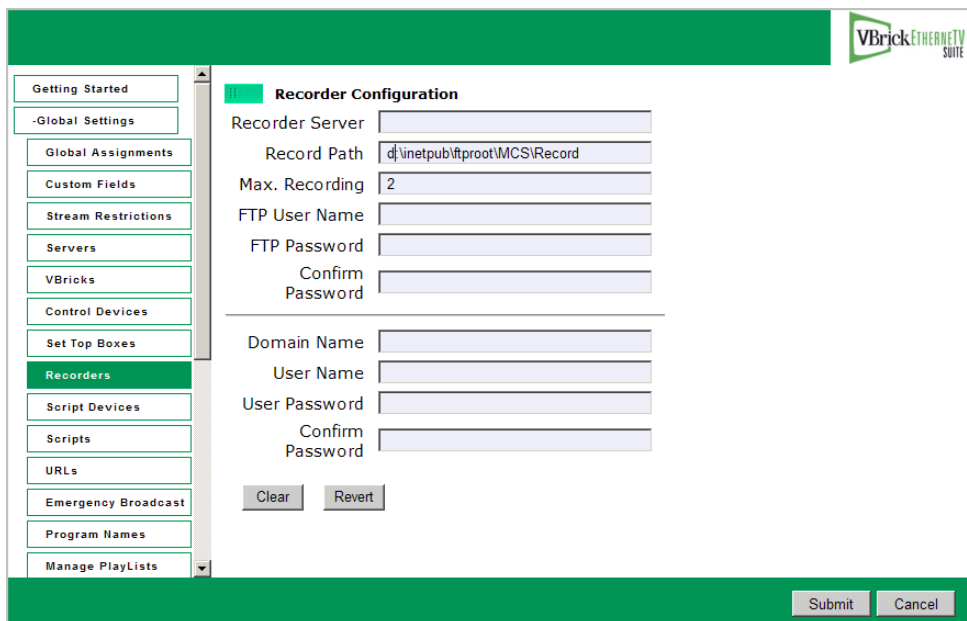

3. Complete the fields in **Recorder Configuration** window and click **Submit**. This adds the newly configured recorder to the previous window. If necessary see [Synchronizing the Portal Server and the NVR](#) below.

Recorder Server	IP address or host name of recorder server. Defaults to localhost if recorder server is on the same machine as ETV Portal Server.
-----------------	---

Record Path	Path and folder where all recording are stored. By default, recordings are stored on the D: drive. If you install ETV Portal Server on a system without a D: drive, you must change the path. Also, in order to record multiple streams, the Record Path must be under FTP root. For example, if root is <code>C:\inetpub\ftproot</code> the Record Path must be <code>C:\inetpub\ftproot\<i>&lt;your_folder&gt;</i></code>
Max. Recording	The default number of concurrent recording sessions allowed is 2. If you exceed 2, you must purchase a Network Video Recorder. Without an NVR, any attempt to record more than 2 concurrent sessions will fail.
FTP User Name	FTP user name in operating system of Recorder server.
FTP Password	FTP password in operating system of Recorder server.
Confirm Password	FTP password in operating system of Recorder server.
Domain Name	<i>This field is required only if the Recorder server is not on the local network.</i> Enter the domain name if the Record Path above points to a server in a different domain,
User Name	The user name who has access to the specified path.
User Password	The corresponding password for this user name.

## Synchronizing the Portal Server and the NVR

The internal clocks on the Portal Server and the NVR must be synchronized for recording functionality to work properly. You can use the `Net time` command as explained below or you can use an external time server. In order to run the `Net time` command on *either* server, the server must be on the domain, and the user logged onto the server must have admin privileges *and* be part of the domain. To synchronize the Portal Server and the NVR use the following command:

- Windows 2003 Server – Open a command prompt on the *Portal Server* and type:  
`Net time \\{NVR IP Address} /SET`

## Script Devices

Script devices work with scripts and can be used to control VBricks, or other devices attached to a VBrick via the serial port. In order to use a script, the device (a VBrick, IP Receiver, camera, VCR, etc.) must be defined in the Portal Server database as a script device. Once defined, they can be subsequently controlled by a script (see [Scripts](#) on page 59) launched from the Portal Server Scheduler. A script device must be physically connected to the network and must be available at the runtime of a scheduled event. For example, PTZ cameras respond to pan, tilt, and zoom commands. Once defined as a script device, pan, zoom, and tilt commands can be scripted and executed from ETV Portal Server to control the movement of the camera at a specific date, time, and recurrence.

---

**Note** You can also write a script (launched from the Portal Server) that uses TCP/IP to communicate with any compatible device on the network. Contact VBrick [Support Services](#) for more information.

---

- ▼ To add a Script Device configuration
- 1. Go to **Global Settings > Script Devices**.

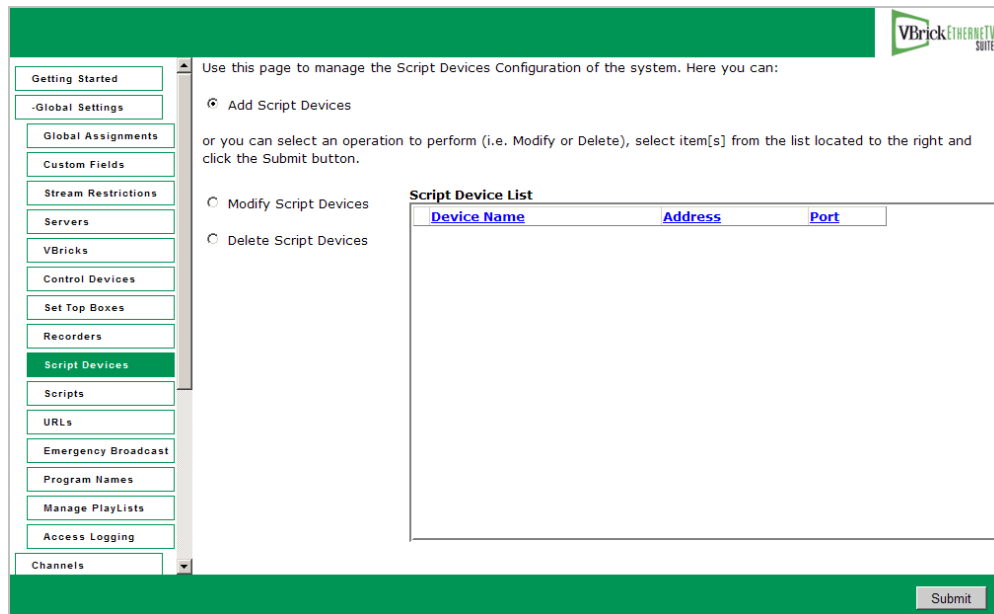

- 2. Select **Add Script Devices** and click **Submit**.

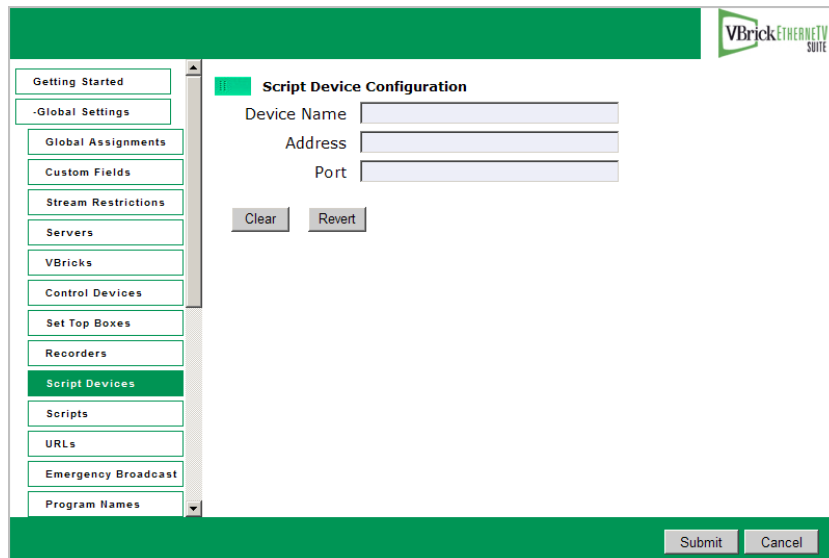

- 3. In **Script Device Configuration**, complete the following fields and click **Submit**. This adds the newly configured script device to the list of devices shown in the previous window. To modify a Script Device, first delete the device and then repeat these steps.

Device Name	Any user-defined name.
Address	Hard-coded device IP address. This is usually the address of the VBrick or the address of the VBrick to which a device is connected but it can be the address of any device.

Port	TCP/IP port number range = <b>1040–65534</b> . If using serial port passthrough, use the VBrick's passthrough port number: <b>4439</b> for COM1, <b>4414</b> for COM2
------	---

## Scripts

Scripts work with previously defined script devices such as VBricks, IP Receivers, or other devices attached to a VBrick. Scripts can be used to control any type of VBrick or to control other devices like cameras and VCRs that are attached to a VBrick. To script VBrick commands, you select the VBrick and build a script by choosing parameters from a dropdown list—the parameters vary depending on the type of VBrick you select (MPEG1, MPEG2, etc.). You can script commands to change any of the parameters (in the MIB database) that are available through IWS (MPEG and WM) or VAdmin (H.264).

For non-VBrick (**Other**) devices, you write a script from scratch using the native language for that device. This scripting functionality is designed for advanced users and you must know the instruction set for the device in order to script commands that will control that device. You can use a text-based script or a binary script to control devices connected to the serial passthrough port (COM1 or COM2) on a VBrick encoder.

You can control devices that require binary input by pasting binary input into the **Script Content** text box. Binary scripts let you provide a sequence of commands for devices that require binary input. This type of script will pass binary input through the serial passthrough port on a VBrick to the specified device. You will typically connect your device to the serial passthrough port using the port number previously defined for the device (**4439** for COM1, **4414** for COM2).

---

**Note** If you are scheduling an event, any device for which you write a script must be available to the network at runtime. If the device is not available the script will fail.

---

### *Creating a Script*

- ▼ To create a script that can be executed from the Portal Server
  1. Go to **Global Settings > Scripts**.

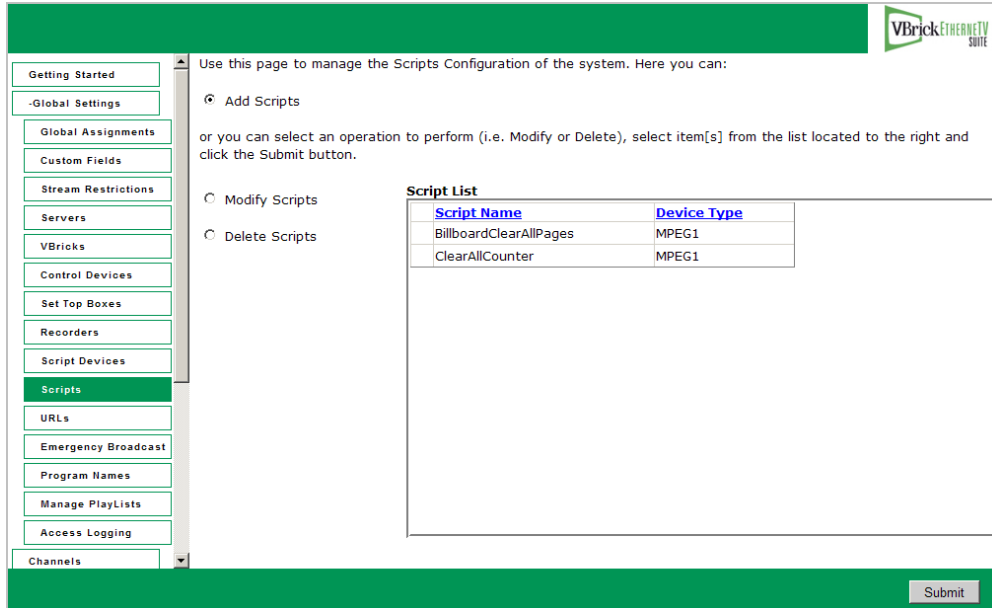

2. Select **Add Scripts** and click **Submit**.

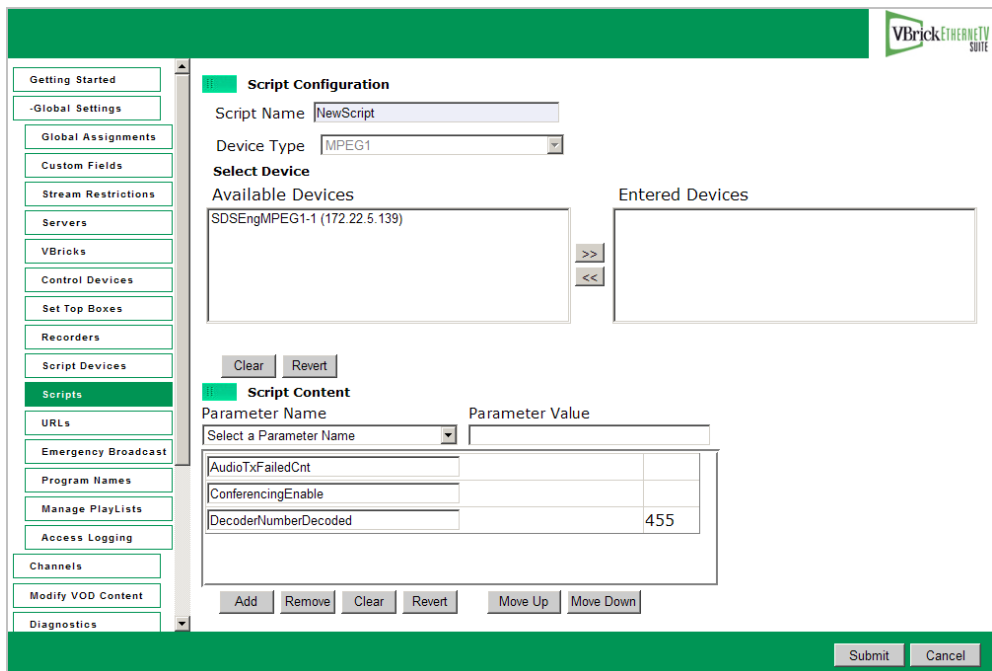

3. In **Script Configuration**, enter a **Script Name** and select a **Device Type** (MPEG1, MPEG2/MPEG4/WM, or Other) from the dropdown list—and wait a few seconds for ETV Portal Server to populate the panel with a list of devices.
4. In **Select Device**, highlight one or more devices and use the arrow buttons to populate the right panel.
5. Create the **Script Content**.
  - a. For VBrick devices, select a **Parameter Name** from the dropdown list, enter a **Parameter Value**, and click **Add**. Repeat as many times as necessary and click **Submit** when done. Note that the order in which you add parameters is critical. This is the



order in which the commands will be executed at runtime. (See [Finding VBrick Parameters and Values](#) for more information.)

- b. For non-VBrick (**Other**) devices, write the script in a native language compatible with the device (or copy and paste binary input) and click **Submit** when done.

To run a previously created script, login to ETV Portal Server and click **Scheduled Programs**. Then create a schedule by selecting a date, time, and (optionally) a recurrence pattern. When done, click **Script** and select the script you want to run on the schedule you just defined.

## Example

The following example shows binary input for a VBrick VBIR device. In a typical scenario you will need to set the **Passthrough State** and other parameters on the encoder before you can run the script. See "Serial Port Passthrough" in the *VB4000-5000-6000 Admin Guide* for more information. The following example programs a VBrick VBIR device to device code 351 and sends the Play command. This is just a brief example. If you need help or want more information about using binary scripts, please contact VBrick [Support Services](#).

*Begin instruction set, program for following device code. This set of instructions is used in all scripts.*

```
<-script->
<-send binary 0xc1 0x0d->
<-receive 2->
<-send binary 0xc0 0x0d->
<-receive 2->
```

*Program three-digit device code. Here code is 351.*

```
<-send binary 0x83 0x0d->
<-receive 2->
<-send binary 0x85 0x0d->
<-receive 2->
<-send binary 0x81 0x0d->
<-receive 2->
```

*End device code programming, set for command. This set of instructions is used in all scripts.*

```
<-send binary 0xc0 0x0d->
<-receive 2->
<-send binary 0xd3 0x0d->
<-receive 2->
```

*Command. Here Play.*

```
<-send binary 0x91 0x0d->
<-receive 2->
```

## Finding VBrick Parameters and Values

In order to create scripts, you need to determine the correct parameters and values to use. The following procedures explain how to locate parameters from the VBAAdmin page and how to find the value associated with that parameter using a standard MIB browser or text editor. These brief procedures simply outline the basic steps which are typically performed by a programmer or a system administrator. Contact VBrick Customer Service or see the *VBrick SDK User Guide* for more information.

- 
- ▼ To locate a parameter name by viewing the source code:
    1. Find the **Parameter Name** in the VBAAdmin page.
    2. Then locate the parameter name by viewing the source code of the page.
  - ▼ To find the parameter value:
    1. Locate the parameter name as described above.
    2. Find the **Parameter Value** by examining the MIB file with either a standard MIB browser or a text editor.

## URLs

### *Add/Modify a URL for a Live Video Stream*

Administrators can manually enter URLs to live video streams that will not automatically be displayed by the Portal Server. For example, the administrator may wish to have the Announcements (SAPs) disabled on the VBrick encoders for security purposes. Or the Administrator may want to enter the address of an off-network stream such as an MPEG-4 Stream from an Apple Darwin Server or a stream coming from a hosting provider. Additionally, this feature lets you enter the addresses of non-MPEG streams such as Windows Media and Real Networks. Note that the Access Control feature Allow Viewing by Content Type does not apply to manually added URLs. You can also filter and control which live streams are shown in the Portal Server by using a bit mask on the VBrick encoder. For more about this feature, refer to the Category parameter in the appropriate MPEG, WM, or H.264 encoder documentation.

---

**Note** For any non-MPEG video, the correct player (such as Windows Media Player or QuickTime) must be present on the desktop for the client to be able to receive the stream.

---

- ▼ To add a URL for a live video stream
  1. Enter the URL or IP address in the **URL** field.
  2. Enter the **Type** and **Title** and click **Add** to add the URL to the list of streams shown.

URL	Enter a valid URL or IP address. See examples above.
Type	Choose MPEG, WM, H.264, or Other. Select Other for most non-MPEG streams; select WM for .swf Flash streams.
Title	Title is what will display to clients in the ETV Portal Server viewing pages.

### Valid URL Examples

The following examples show valid URL syntax for live video streams. All URLs are case sensitive and the syntax must be accurate because there is no internal validation of user input.

Stream Type	URL Syntax
MPEG-1/MPEG-2	<pre>vbricksys://ip=239.1.1.1&amp;port=4444</pre> <p>Where <code>239.1.1.1</code> is the multicast IP address and <code>4444</code> is the multicast port.</p>
MPEG-4	<pre>rtsp://172.1.1.1/vbrickvideo1</pre> <pre>vbrtsp://172.1.1.1/vbrickvideo1</pre> <p>Where <code>172.1.1.1</code> is the source IP address and <code>vbrickvideo1</code> is the program name.</p> <pre>vbhttp://172.1.1.1/vbs2d1.sdp</pre> <p>Where <code>172.1.1.1</code> is the source IP address and <code>vbs2d1.sdp</code> is the SDP file name.</p>
WM	<pre>http://172.22.2.147/vbs1http.asx</pre> <pre>http://172.22.2.147/vbrickvideo1</pre> <p>Where <code>172.22.2.147</code> is the source IP address and <code>vbrickvideo1</code> is the program name. <i>Note that the WM IPR does not support RTSP streams.</i></p>

Stream Type	URL Syntax
H.264	<p><code>rtsp://172.1.1.1/vbStream1S1</code>  <code>vbrtsp://172.1.1.1/vbStream1S1</code></p> <p>Where 172.1.1.1 is the source IP address and <code>vbStream1S1</code> is the resource name.</p> <p><code>vbhttp://172.1.1.1/vbStream1T1.sdp</code></p> <p>Where 172.1.1.1 is the source IP address and <code>vbStream1T1.sdp</code> is the SDP file name.</p>
Other	<p><u>ASX Files</u></p> <p><code>http://172.1.1.1/file.asx</code>  <code>http://myHost/file.asx</code>  <code>http://www.myCompany.com/files/file.asx</code></p> <p><u>MP3 and WMA Files</u></p> <p><code>http://172.1.1.1/file.mp3</code>  <code>http://myHost/file.mp3</code>  <code>http://172.1.1.1/file.wma</code>  <code>http://myHost/file.wma</code></p> <p><u>WMV Files</u></p> <p><code>http://www.myCompany.com/files/file.wmv</code>  <code>mms://www.myCompany.com/files/file.wmv</code></p>

### *Add VOD Content*

Administrators can manually enter URLs to VOD content that is not automatically displayed by the Portal Server. These URLs can be to content that is located on a non-NXG Video-on-Demand server, such as the QuickTime/Darwin server, a Windows Media server, or a Helix Real server. This is valuable feature if you want to enter an off-network stream such as an MPEG-4 Stream from an Apple Darwin Server or if there is Windows Media or Real Networks content that needs to be displayed through the Portal Server interface.

URL	Enter a valid URL or IP address. For example: <code>rtsp://ipaddress/programname</code> <code>mms://ipaddress/videoname.wmv</code>
Type	Choose MPEG-1, MPEG-2, MPEG-4, MPEG-4 NXG, Document, WM, H.264, or Other. If you are creating a URL for stored video that points to <a href="http://www.yahoo.com">www.yahoo.com</a> , for example, select Document in this field—not Other. Select WM for .swf Flash streams.
Title	This is what will display to clients in the ETV Portal Server viewing pages
Folder	This is the folder on the VOD server in which the video will be displayed.
Keywords	Enter keywords that can be searched from the user interface.
Max. Concurrent Viewers	Set the maximum number of concurrent viewers for this stream to unlimited or any number greater than zero.

Press **Add** to add the VOD content to the list. VOD content also can be Modified or Deleted. Simply select the VOD content, make modifications (if required), and click **Modify** or **Delete**.

### Add Non-VOD Content

**PC Users Only.** In the **VoD Content** section, administrators can also link to external documents such as PDF files, PowerPoint files, web pages, or anything that can be displayed in a browser or other external program. For content that needs to run with a specific application (for example, PowerPoint slides), the application must be present on the desktop for that file to be viewed. Use the content **Type** field to identify the content. Select a stream type (MPEG-1, MPEG-2, etc.) to add video content from an outside source. Select type **Document** for PDFs or Word documents, or type **Other** for PowerPoint presentations, Flash demos, etc. Each content type has a different icon on the **Video Library** page.

---

The URL must point to a web server or a local drive. The Portal Server server can act as the web server for this content, if the content is placed in the `c:\program files\vbrick\mcs` directory on the ETV Portal Server (or in any subdirectory you create, e.g. `... mcs\test_files\test.doc`). A local path or network shared path also can be entered. Content accessed from a local drive (or network shared path) needs to be entered in the format `c:/path/file` (it will fail if you use back slashes, for example `c:\path\file`). Also, this drive needs to be accessible by those that have access to the link.

## Priority Alert

These pages are used to create priority alert templates that Portal Server users can subsequently use to launch a priority alert. *Priority alerts are launched from the Portal Server user interface—not from the Admin console.* A priority alert is a schedule that can be executed by Portal Server users with appropriate permissions. This schedule broadcasts a live or stored video to specified VBricks or IP Receivers in case of an emergency. The schedule is executed instantly, for a specified duration or indefinitely. When done (or manually stopped) all preempted schedules automatically resume.

A priority alert template pre-defines all parameters for the broadcast so that it can be launched immediately; it pre-empts all other broadcasts. Very simply, you define the source stream (live or stored) and the downstream targets (VBricks or IP Receivers) and then save the template for future use. It is important to note that priority alert streams are shown only on monitors or TVs attached to VBricks and IPRs respectively. *They are not shown on the Portal Server user interface.* If you are watching a stream in the embedded player on the user interface browser, you will not see a priority alert.

---

**Note** Live and stored broadcasts, in this context, refer to content that is being streamed over your IP multicast-enabled network. This does not mean there is IP broadcasting to your entire network.

---

▼ To create a Priority Alert Template

1. Go to **Global Settings > Priority Alert**. This page shows a list of previously defined templates (if any).

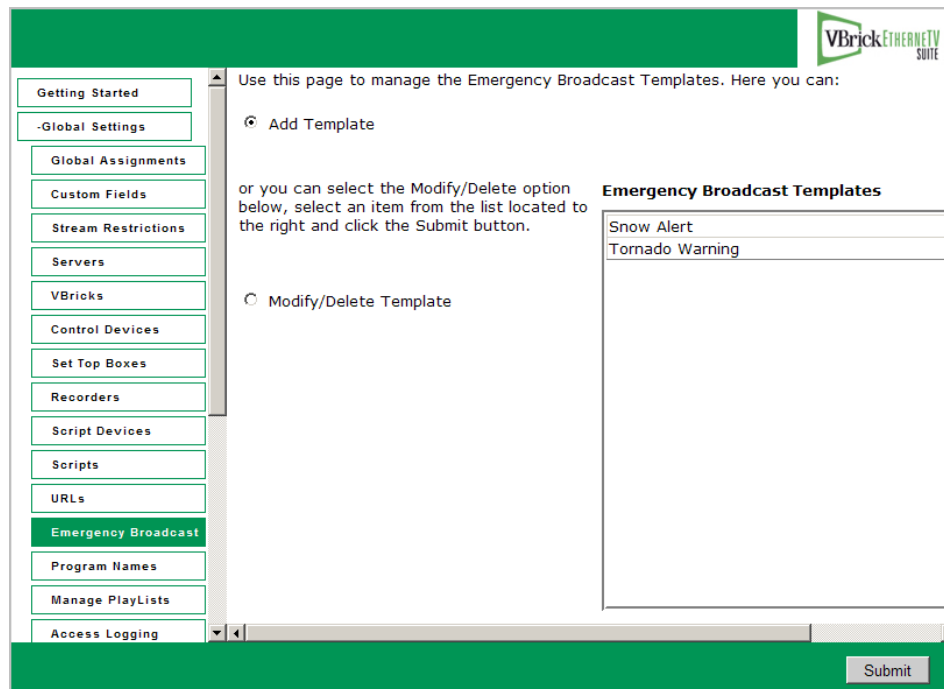

2. Select **Add Template** and click **Submit** to display the following window.

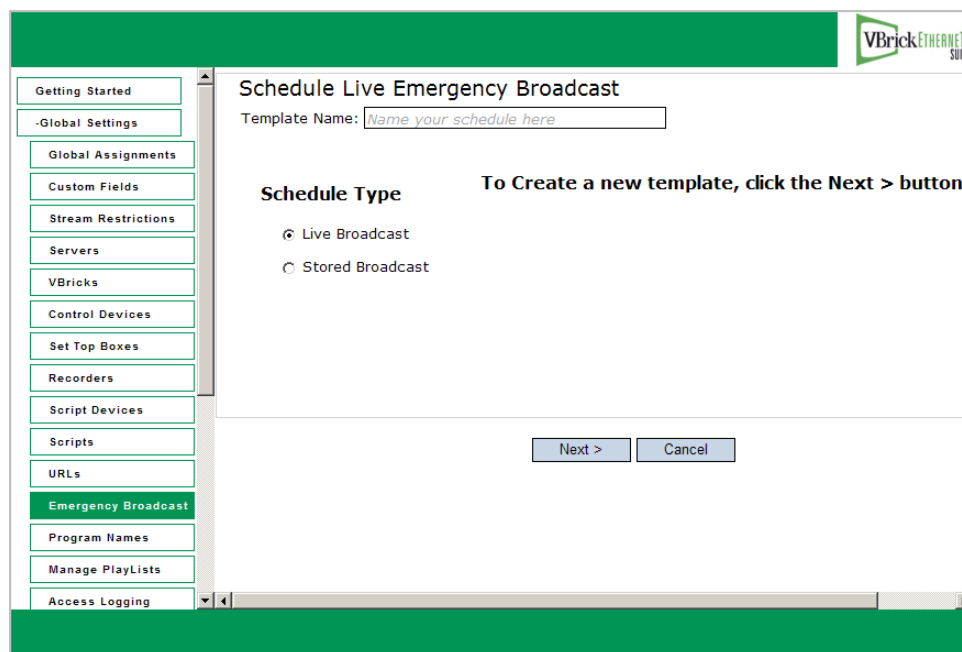

3. Enter a **Template Name**, select a **Schedule Type**, and click **Next**. (Duplicate template names are allowed but not recommended.)

Each **Schedule Type** subsequently has a different wizard depending on the selections you make but basically, you select the video source (which can be a live or stored broadcast), the downstream targets (VBricks or IP Receivers) to which it will be broadcast, and configure any **Advanced Settings** (see note below) for the VBricks or IPRs. When done the template you created is available to authorized Portal Server users as a Priority Alert template. See the *ETV Portal Server User Guide* for more information.

---

**Note** **Advanced Settings** are available to configure VBricks and IPRs with exceptional configuration parameters. It is unlikely you will ever need to change these settings. In all cases you can safely ignore the **Advanced Settings** and use the defaults provided by ETV Portal Server.

---

Template name	Alphanumeric characters or spaces. No special characters.
Schedule Type	<u>Live Broadcast</u> <ul style="list-style-type: none"> <li>• VBrick – Select a live stream by VBrick Name. Then select the destination VBricks or IPRs.</li> <li>• Program Name – Select a live stream by Program Name from all available. Then select the destination IPRs.</li> <li>• Enter Manually – Select an MPEG or WM source residing at a specified IP address. Then select the destination IPRs.</li> </ul>
	<u>Stored Broadcast</u> <ul style="list-style-type: none"> <li>• VoD Name – Select a VOD server and a source video. Then select the destination VBricks or IPRs.</li> <li>• VBrick Name – Select a VBrick (or VBStar) and a source video. Then select the destination VBricks or IPRs.</li> </ul>

4. Configure **Advanced Settings** for VBricks and IPRs as necessary. As noted, it is unlikely you will ever need to change these settings. In all cases you can safely ignore these settings and use the defaults provided by the Portal Server.

These settings generally set configuration options for source devices and destination devices (VBricks and IPRs) so that they are configured properly (e.g. transmit/receive enabled/disabled) at the beginning and end of a priority alert. All required devices must be present and enabled for a successful priority alert. The settings differ depending on the device (e.g. MPEG, WM, or H.264) you select and may include some or all of the fields explained below.



**Schedule Live Emergency Broadcast**

Template Name:

Select Video Source:  VBrick  Program Name  Enter Manually

Hostname	Slot	Type
Andy-ATM	1	MPEG-2
AndyM-WM-MP2	1	WM
AndyM-WM-MP2	2	MPEG-2
A-StanWM	1	WM
BillsWM	1	WM
BillsWM	2	WM
BLDG-Frnt-Camera-1	1	MPEG-4
BLDG-Rear-Camera-1	1	MPEG-4
BoardRoom	1	MPEG-2
BoardRoomWM	1	WM
BruceMP2	1	MPEG-2
BruceWM	1	WM

**Advanced Settings**

Host Name: **Andy-ATM** IP Address: **172.22.162.11**

Schedule Start Options -

Program Name:  Current setting is used if entry is empty.

Destination:  Mode:  Port:

Transmit:  Closed Captioning:

Schedule End Options -

Transmit:  Closed Captioning:

### Schedule Start Options

Enter values that describe the device state at schedule start.

- Program Name – Program name selected above.
- Template – MPEG only. Screen varies for MPEG-1, 2, or 4.
- Destination – Destination 1, Destination 2, RTSP Server.
- Destination Address – Enter value.
- Video Port – Enter value.
- Audio Port – Enter value.
- Closed Captioning Port – Enter value.
- Video – Enabled, Disabled, As Configured.
- Audio – Enabled, Disabled, As Configured.
- Closed Captioning – Enabled, Disabled, As Configured.

### Schedule End Options

Enter values that describe the device state at schedule end.

- Video – Enabled, Disabled, As Configured.
- Audio – Enabled, Disabled, As Configured.
- Closed Captioning – Enabled, Disabled, As Configured.

5. Click **Next** to page through each wizard.
6. Click **Finish** when done.
7. Verify the information and click **Create Schedule** when prompted (or use the **Back** button to make changes). When finished, the template is added to the list of Priority

Alert Templates available to ETV Portal Server users from the Portal Server application. See the *ETV Portal Server User Guide* for more information.

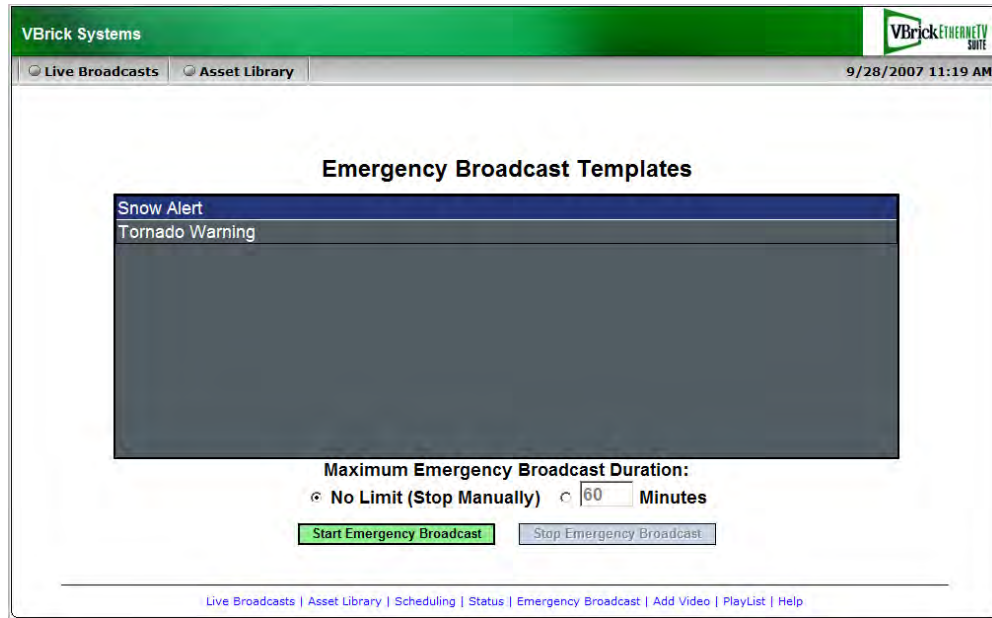

## Program Names

Program Names are used with live presentations. A **Program Name** is the title that will be displayed on the **Live Broadcasts** page during a live, rich media presentation—if users have Live Channel privileges. Program names are also used to set permissions for live presentations and all defined Program Names are displayed in the **Add/Modify Live Channel Privileges** window. You can allow or deny viewing of any presentation by adjusting privileges in this window. A **Program Name** (e.g. **HR Presentation**) can be pre-configured (with permissions) in advance for use with VBPresenter. When you use this same name in the **MCS Program Name** field in VBPresenter for example, **HR Presentation** will be displayed on the Portal Server's **Live Broadcasts** page. See [Configuring for Live Presentations](#) on page 135 for more about program names.

Use this page to administer program names.  
Program names are used for permissions of live presentations content.

Select an entered live program name or add to enter a new program name:

Mayan History
Undersea Travel

Program Name:

## Manage Playlists

Use this window to change playlist attributes including **Folder**, **Title**, and **Owner**. If Access Control is not enabled, the owner for all playlists defaults to **MCSCClient**. Note that if Access Control is subsequently enabled, any previously created playlists will not be available unless they are re-assigned from **MCSCClient** to other valid users.

Name	Owner
/Stan/Craigs List	MCSCClient
300KHighMotionTemplateCBR.asf_9_11_2007_12_28	MCSCClient
300KHighMotionTemplateCBR.asf_9_11_2007_12_29	MCSCClient
/06paulbru sequence	MCSCClient
Stan	MCSCClient
0_absouletepathWM.wmv_9_11_2007_17_24	MCSCClient
0_absouletepathWM.wmv_9_11_2007_17_24	MCSCClient
JohnS_WM Program 1_02_24_06_13_39_03.wmv_9_12_2007_9_13	MCSCClient
JohnS_WM Program 1_02_24_06_13_39_03.wmv_9_12_2007_9_14	MCSCClient

Folders:

Title:

Owner:

Folders	Select a folder location for the playlist. The default folder is the private <b>MyMedia</b> folder of the playlist owner.
Title	Use any alphanumeric characters <i>except</i> ' ^ : * ?   [ ] ( ) < > % #
Owner	The owner is the logged-in user who created the playlist.

## Access Logging

Access logging tracks Portal Server usage. It creates logs that let you review who has watched what content, when, and for how long. Specifically, it logs access to live or VOD content, and to user-initiated recordings. **There are two output logs; one is used for live/VOD content and the other is for recordings.** The logs are created in a standard format and can be viewed with EtherneTV Reporter (VBrick's powerful log analysis tool or with a customized Excel spreadsheet. Use the various configuration options described below to save the logs to a different computer, set log time periods, etc. By default, access logging is set to off and the logs are saved in **Program Files\VBrick\MCS\Logs**. *Note that log entries are written to the log file only after viewing or recording is complete.* To see what is *currently* being viewed or recorded, open the Logged Programs table in MCS using MySQL Query Browser or a similar tool. (MySQL Query Browser is available free of charge with the free software/open source GNU General Public License at <http://www.mysql.com>) Be aware that the access logger has certain constraints; for example, it:

- does not log web page access. This is an IIS function that can be set and controlled by system administrators.
- does not work with the Apple QuickTime player.
- does not have a built-in parser. The logs can be viewed as text files or can be managed and viewed using third-party reporting and analysis tools.

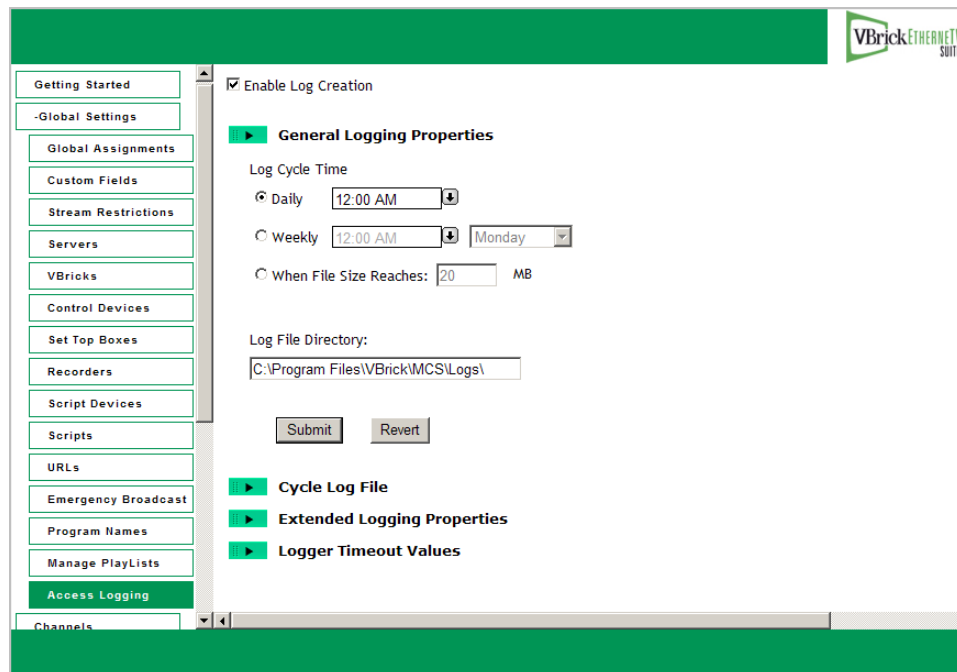

Enable Access Logging	Sets access logging on or off. Default = off. The log files are saved in <b>Program Files\VBrick\MCS\Logs</b> .
Log Cycle Time	New log files can be created daily, weekly, or when the file reaches a certain size. Old files are never deleted or written over.
Log File Directory	Specifies where the log files are saved. This can be on the same machine as the Portal Server or on a different machine in the same network.
Cycle Log File	Click <b>Cycle Now</b> to close the existing log files and create new files.
Extended Logging Properties	See <a href="#">Extended Logging Properties</a> below. Determines what fields are logged.
Logger Timeout Values	The timeout values (default two hours for stored content, four hours for live content) are typically used when a client machine crashes or hangs.

### *Extended Logging Properties*

Use the following window to specify which fields are logged. **If you are using EtherneTV Reporter, all fields must be selected.** The items in parentheses (e.g. **cs-username**) refer to the header field shown in the actual log file (see Figure 15 below). The fields are self-explanatory and most are standard W3C fields. (See <http://www.w3.org/TR/WD-logfile.html> for more about W3C log file formats.) Note that the fields used in each log will vary slightly and unused fields are marked with a hyphen "-". Note that the following non-standard fields may be incompatible with some reporting tools and can be de-selected: **x-address**, **x-port**, and **x-duration**. For best results with log analysis tools, do not de-select any other fields.

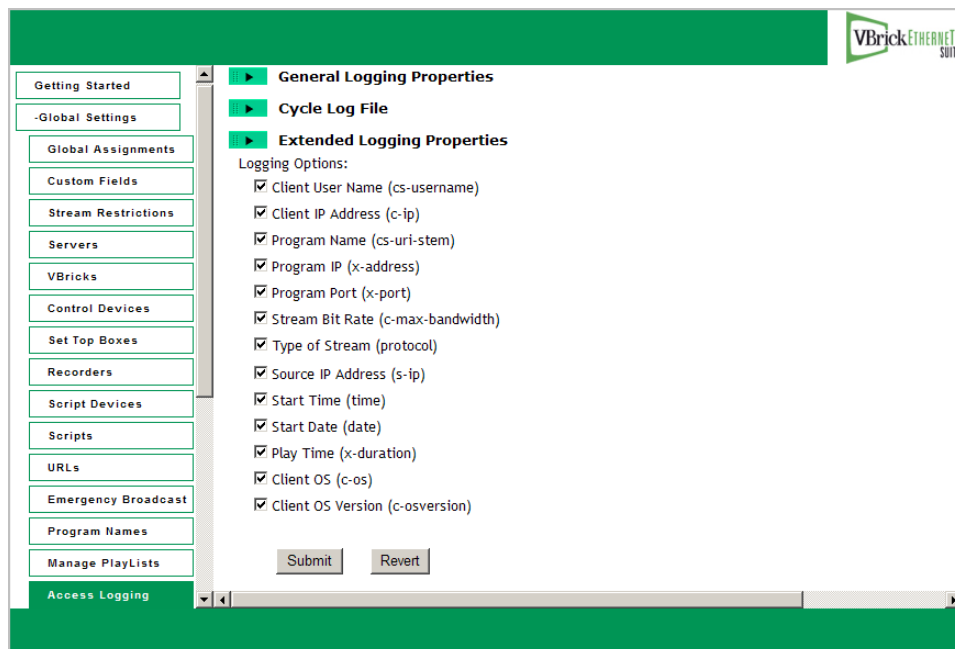

## Using EthernetTV Reporter

If you purchased a separate license, you can use VBrick's powerful "EthernetTV Reporter" log analysis tool to examine the access logs. EthernetTV Reporter is a dedicated log file analysis tool. It reads individual log files generated by the Portal Server and generates a graphical statistical report based on the contents of the log data. Each log entry contains multiple fields, and EthernetTV Reporter extracts those field values from the log data and populates the report. EthernetTV Reporter is closely integrated with the Portal Server and has its own documentation. See the [EthernetTV Reporter User Guide](#) in the online help for more information.

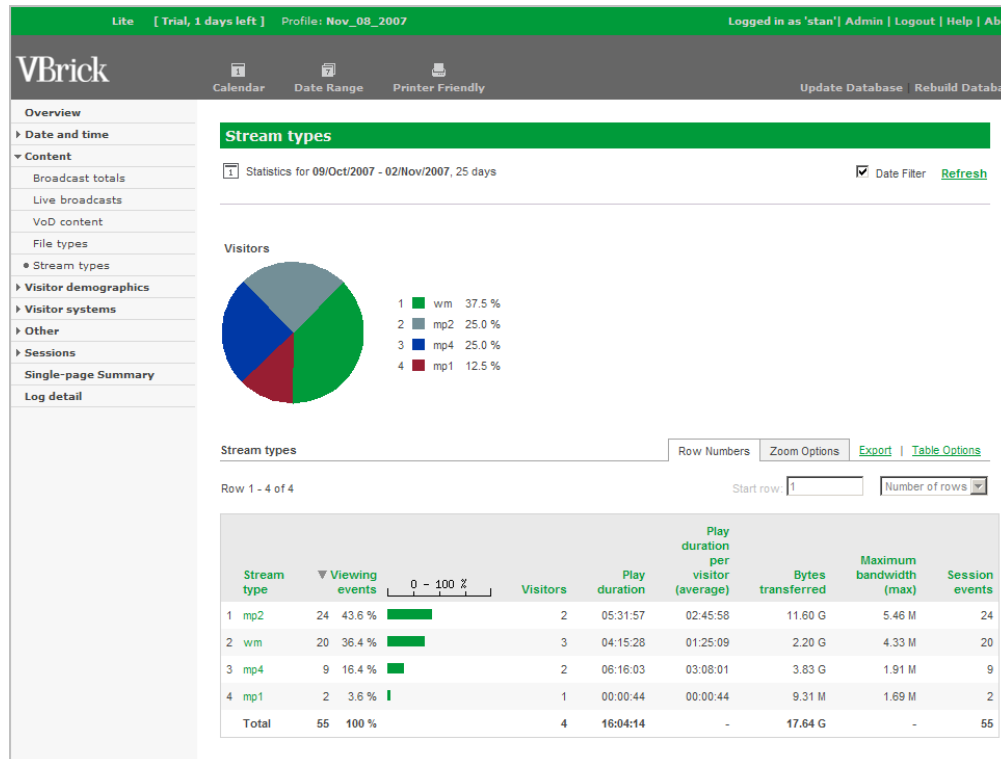

Figure 14. Sample ETV Reporter Output

## Using an Excel Spreadsheet

You can also use a standard editor like Notepad and the Excel spreadsheet template provided by VBrick to examine the logs. The [MCSS Access Log.xlt](#) template file makes it easy to view and sort log files. You can also use this template to build Pivot Tables to analyze the log data in greater detail. Pivot Tables are a powerful tool used to analyze multi-dimensional data. Pivot Tables are beyond the scope of this document and are not explained here. For an introduction to Pivot Tables, there are a variety of resources on the web including the Microsoft Office online demo at <http://office.microsoft.com/en-us/assistance/HA011989031033.aspx>

▼ To create a pivot table

1. Navigate to **C:\Program Files\VBrick\MCS\Utils** and double-click **MCSS Access Log.xlt**
2. When prompted, select **Enable Macros**.
3. Click **Import Log(s)** and navigate to the log files in **Program Files\VBrick\MCS\Logs**
4. Select one or more log files by holding down the **Ctrl** or **Shift** keys while selecting files.

- Once the window is populated with log data (Figure 15) you can view or sort any of the columns as necessary.
- Click **Pivot Table Wizard** and follow the prompts to build a Pivot Table.

cs-username	c-ip	cs-media-n	x-ip	x-port	c-max-banc	x-type	s-ip	time
stan	172.22.2.80	/1_CNN2_05_1	-	-	-	mp2	-	15:34:41
stan	172.22.2.80	/1_CNN2_10_0	-	-	-	mp2	-	15:35:18
stan	172.22.2.80	1-MSNBC	239.16.120.98	4443	-	mp2	172.16.120.101	15:35:38
stan	172.22.2.80	1-CNN2	239.16.120.3	4444	-	mp2	172.22.2.84	17:21:37
MCSSClient	172.22.2.80	/_CD_MPEG1	-	-	-	mp1	-	14:15:58
MCSSClient	172.22.2.80	ScottsMPEG2	239.22.118.225	4444	-	mp2	172.22.5.94	10:39:44
MCSSClient	172.22.2.80	ScottsMPEG2	239.22.118.225	4444	-	mp2	172.22.5.94	10:41:17
MCSSClient	172.22.2.80	ScottsMPEG2	239.22.118.225	4444	-	mp2	172.22.5.94	10:52:18
MCSSClient	172.22.2.80	rich'd_WM	239.16.161.3va	4444va	-	wm	172.16.161.3	10:52:22
MCSSClient	172.22.2.80	ScottsMPEG2	239.22.118.225	4444	-	mp2	172.22.5.94	10:52:25
MCSSClient	172.22.2.80	SDSEngMP4M	rtsp://172.22.5.1	-	-	-	-	10:53:03
MCSSClient	172.22.2.80	ScottsMPEG2	239.22.118.225	4444	-	mp2	172.22.5.94	10:59:13
MCSSClient	172.22.2.80	ScottsMPEG2	239.22.118.225	4444	-	mp2	172.22.5.94	11:20:42
MCSSClient	172.22.2.80	SDSEngDualE	239.22.170.224	4444	-	mp2	172.22.5.146	11:22:49
MCSSClient	172.22.2.80	ScottsMPEG2	239.22.118.225	4444	-	mp2	172.22.5.94	11:34:16
MCSSClient	172.22.2.80	PlatEng9-RDG	239.16.2.165	4444	-	mp2	172.16.2.50	11:37:17
MCSSClient	172.22.2.80	ScottsMPEG2	239.22.118.225	4444	-	mp2	172.22.5.94	11:49:04
MCSSClient	172.22.2.80	ScottsMPEG2	239.22.118.225	4444	-	mp2	172.22.5.94	12:02:04
stan	172.22.2.80	_CD-MPEG2-0	239.22.123.96	2093	-	mp2	172.22.123.93	16:00:48
stan	172.22.2.80	1-CNN2	239.16.120.3	4444	-	mp2	172.22.2.84	16:01:01
stan	172.22.2.80	1-FOX_NEWS	239.16.120.99	4444	-	mp2	172.16.120.101	16:01:05
stan	172.22.2.80	1-MSNBC-2	239.22.120.33	4444	-	mp2	172.22.2.84	16:01:08
stan	172.22.2.80	_CD-MPEG1-2	239.22.123.2	2002	-	mp1	172.22.123.2	16:01:14
stan	172.22.2.80	1-MSNBC	239.16.120.98	4443	-	mp2	172.16.120.101	16:01:18
stan	172.22.2.80	Andy-MP2-4-L	239.30.0.1vc	4444,4844vc	-	mp4	172.22.2.120	16:01:36

Figure 15. Imported Access Log

## Zones

In a standard Portal Server configuration, a client selecting a video is algorithmically directed to a load-balanced (Internet or LAN) server. This is normal Portal Server behavior and the Zones page is not used. The Zones page, *if used*, directs Portal Server clients (or a range of clients) to *specific* servers (or a range of servers). It associates each incoming network address with one or more server addresses. If using this page, you will typically create different named zones with different sets of client and server IP addresses. Note that if a client IP address is not included in the **Client Address(es)** list, that client is directed to the **Server Address(es)**.

This page is also used to redirect clients when there is a server failure. The Portal Server polls all networked VOD servers at the polling interval specified in Global Settings. If the poll indicates a server failure, the specified Portal Server clients are automatically redirected to the default server(s) only if the **Hide Content** option is checked on the **Assign VOD Polling Interval** page. If unchecked, there will be no rollover to the specified default servers in the event of a server failure.

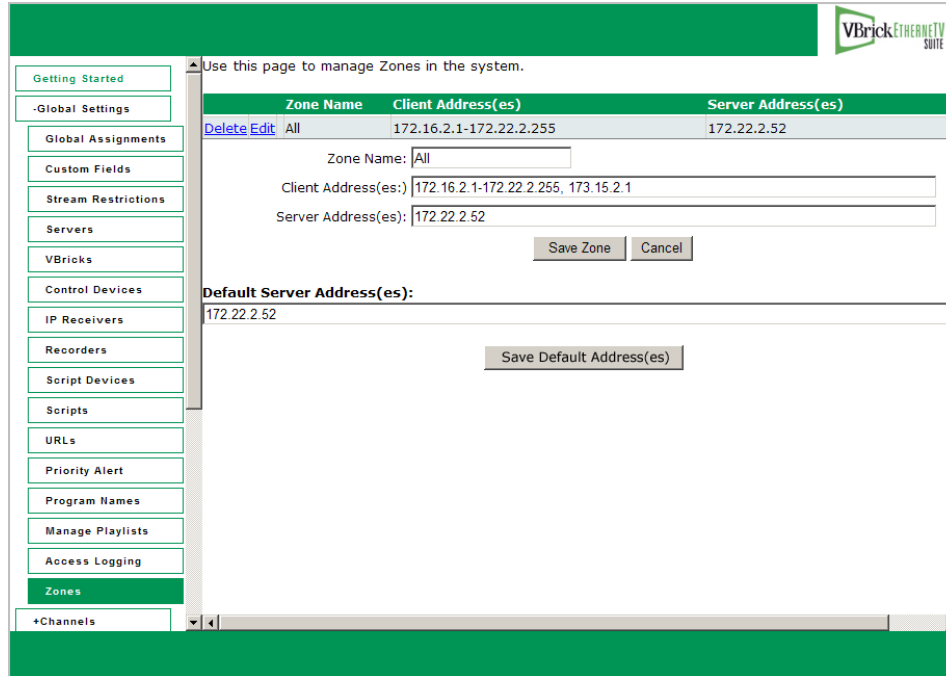

Zone Name	User-defined string that identifies the zone.
Client Address(es)	Enter individual, comma-separated client IP addresses and/or a range of client IP addresses. For example: <b>172.15.2.1</b> , <b>172.16.2.1-172.22.2.255</b>
Server Address(es)	Enter individual, comma-separated server IP addresses and/or a range of server IP addresses to which the specified client(s) will be directed.
Save Zone	Saves the zone information in the upper panel.
Default Server Address(es)	The server address to which a client is directed if the client IP address is not included in the <b>Client Address(es)</b> field.
Save Default Address(es)	Saves the default server information in the lower panel.

**Note VBPresenter Only.** If no zones are configured (the default), then all live and stored content (including VBPresenter presentations) will be visible in the Portal Server. However, if you do configure zones, then all content will be filtered based on the defined **Server Address(es)**. For VBPresenter Presentations hosted on the Portal Server, zones must be configured to include the users' appropriate Portal Server IP Address.



# Server Administration

### *Topics in this section*

Channels . . . . .	77
Modify VOD Content . . . . .	85
Diagnostics . . . . .	87
Status . . . . .	88
Expired Content Log . . . . .	89
Access Control . . . . .	89
Live Presentations . . . . .	98
Users . . . . .	99
User Groups . . . . .	99
Resource Groups . . . . .	99
Help . . . . .	99
About . . . . .	100
Logout . . . . .	101

## Channels

### *Channel Guide*

VBrick has partnered with a leading content provider, to provide news, information, and entertainment programming for the Portal Server. This is optional service that requires a license and may not be supported at your site. The program listing includes some 80+ television programs. These programs are generally all "network" listings, such as ABC, CBS, NBC, CNN, "National Geographic Channel, etc. The listing comes from a VBrick-maintained server. This page is used to define the location and update parameters for the Channel Guide Server. This server is typically a VBrick Apache machine that can be used to connect to a third-party content provider. In this type of scenario, the third-party provider provides *programming* data that is shown on the user interface in the Channel Guide. This functionality requires a Channel Server license. If this license is not installed, the options for server **Location** and **Security** (password) are not shown on the Channel Guide page.

### **Changing the Time Zone**

The times for Channel Guide listings on the Portal Server are in UCT (Universal Coordinated Time). The program times are calculated by the Portal Server software using the time zone setting in Windows. For example, if a program is listed as beginning at 1800 hours UCT, and your time zone is U.S. Eastern, the "offset" from UCT is -5 and the program will be listed at 1300 hours. If your time zone is U.S. Pacific, the "offset" is -8 and the program will be listed at 1000 hours. To get accurate program listings, your local time zone must be properly configured in Windows. The Portal Server computer is shipped with U.S. Eastern time and

should be reconfigured to match your own time zone. Use the following steps to set the time zone and verify that it was successfully changed.

▼ To change the time zone

1. For reference purposes, note the currently scheduled time for any program in the Channel Guide.
2. Go to **Start > Control Panel > Date and Time** and select the Time Zone where the Portal Server is located.
3. When done reboot the Portal Server and open the Admin Console.
4. Go to **Channels > Channel Guide > Channel Guide Update** and click **Update Now**.
5. Wait approximately 20 minutes for the Channel Guide to update.
6. Verify that the time zone has been updated. Check the scheduled time for the program you noted in Step 1 and verify it has been updated to match your current time zone.

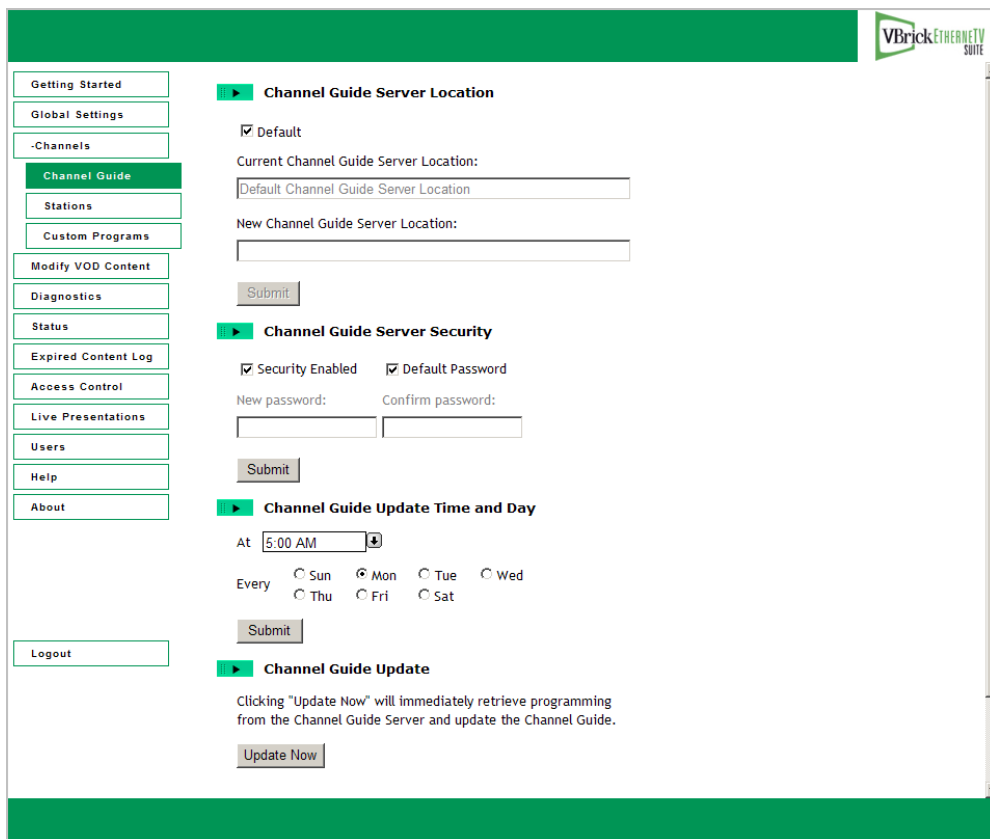

Channel Guide Server Location	The location of the VBrick Channel Guide Server. To enter a different location, uncheck the <b>Default</b> box and enter a valid URL in the following format: <a href="http://www.&lt;server_ip_address&gt;">http://www.&lt;server_ip_address&gt;</a> .
Channel Guide Server Security	By default, password security is enabled. Uncheck to disable, and then enter and confirm a different password.

Channel Guide Update Time and Day	Select the time and day when the Portal Server will connect to the specified Channel Guide Server for program updates. This updates the Channel Guide on the user interface. When <i>TV Station</i> program data is updated, all expired <i>Custom Station</i> program data (more than 14 days old) is purged.
Channel Guide Update	Click <b>Update Now</b> to immediately retrieve programming from the Channel Guide Server and/or update the Channel Guide on the user interface. An update purges all outdated programming information from the database.

## Stations

Use this page to add stations to the Channel Guide on the Portal Server "user" interface. There are two types of stations. **Custom Stations** are those for which *you* define program information and associate with a stream. **TV Stations** are those acquired through a third-party provider. **TV Stations** are also associated with a stream and already have program information provided by a Channel Guide Server. Note that the **Add TV Stations** option is not shown unless you have a Channel Guide Server license installed on the Portal Server (see [Installing Serial Numbers and License Files](#) on page 15 for more information). All currently defined stations are shown in the **Stations List**.

Use this page to manage VBrick Stations in the system. Here you can:

Add Custom Stations  
 Add TV Stations  
 Modify Station  
 Delete Stations

or you can select an operation to perform (i.e. Modify or Delete), select item[s] from the list located to below button.

Station	Channel	Name
	1	CNN
	2	FOX_Broadcasting_Co.
	3	A-Station
	4	MSNBC
	9	SciFi
	11	Custom Station 1
	12	Custom Station 2
	13	Custom Station 3
	14	Custom Station 4
	15	Custom Station 5
	47	Cable_Satellite_Public_Affairs_Network
	48	BruceWM Program 1
	70	Cable_News_Network

Submit

The Portal Server discovers all available live streams on the network. On a network with many live streams, the administrator can keep the stream list organized by assigning channel numbers. This also provides an environment for end users that is similar to television. When adding stations, you can assign or change the **Icon**, **Name**, **Channel** number etc. You can also enter a searchable **Description** that displays in the **View Info** popup when you mouseover the channel number in the user interface. You can also enter **Keywords** for searching, and values for any custom fields that have been defined (see [Custom Fields](#) on page 28).

**Note** For best viewing results after adding stations, click the **Live Broadcasts** button on the user interface to refresh the page and verify your changes. To avoid caching conflicts, do not use the browser refresh (F5) button.

## Add Custom Stations

▼ To add a custom station

1. Go to **Channels > Stations** and click **Add Custom Stations**.
2. Click on any *available* live stream to populate the window shown below. Note that only those streams not currently assigned to stations are displayed and available for use.

Getting Started  
Global Settings  
Channels  
Program Guide  
Stations  
Custom Programs  
Modify VOD Content  
Diagnostics  
Status  
Expired Content Log  
Access Control  
Live Presentations  
Users  
Help  
Logout

Modify Custom Station:

Available VBrick SAP Live Streams:  
/BSB-mp2-batch1.mpg  
AndyM-WM-MP2 Program 2  
BillsWM Program 1  
BillsWM Program 1  
BillsWM Program 2  
BLDG-Rear-Camera-1 Program 1  
BruceMP2 Program TDOT8mbit  
BruceWM Program 2

Icon Image:  Browse... Import Delete

Original SAP Name: BSB-Whitegate-PAL Address: 239.20.127.53 vnc Port: 4444 vnc

Name: BSB-Whitegate-PAL  
Channel: 89  
Description: 88  
Keywords: 88

Custom Programs:  
Edit Programs

Links:  
Title Web Page URL / Replacement File Delete  
Add New Link

Add Custom Station Modify Custom Station

3. Select an existing icon or **Browse** to a file and select **Import** to make additional icons available.
4. Change the station **Name** (optional) and enter a **Channel** number (required).
5. Add a **Description** of the channel and **Keywords**. These are displayed on the **Info** page shown when you mouseover the station icon. They are associated with the stream and make it easier to search for specific content.
6. When done click **Add Custom Station**. This creates the station, disables the **Add Custom Station** button, and enables the **Edit Programs** and **Add New Links** buttons.
7. Add custom programming information (see [Custom Programs](#)) and links (see [Add New Links](#)) as explained below.
8. Click **Modify Custom Station** when done to save your changes.

Available VBrick SAP Live Streams	Select an available live stream on your network. These were previously created and include VBrick SAPs (Session Announcements), multicasts from VOD servers, and URLs that were manually entered. See <a href="#">URLs</a> on page 62 for more information about manually-entered URLs. <i>Note that only those streams not currently assigned to stations are displayed in this list.</i>
Icon Image	Navigate to any valid image file (.jpg, .gif, or .png, only). Use an image that will scale appropriately. All images are resized to 18x30 px.
Name	Required. Name assigned to the station that will display on the popup when you mouseover the icon on the Live Broadcasts page. 
Channel	Required. Unique number that will display on the popup when you mouseover the icon on the Live Broadcasts page
Description	Optional. Description that will display on the View Info page.
Keywords	Optional. Enter searchable keyword(s) separated by commas or spaces that will display on the View Info page.
Custom Programs	Lets you add custom programming data. Note that you must add a Custom Station before creating programs for it.
Links	Optional. Add hyperlinks that will display on the View Info page. See <a href="#">Add New Links</a> below. Note that you must add a Custom Station before creating links for it.

## Add TV Stations

This option is not shown unless you have a license for a Channel Guide Server. If you do have a license, certain content is being made available from a third-party provider. Adding a **TV Station** is the same as adding a **Custom Station** (see above) with two important distinctions. First, you must select a **Station Name** from the pre-populated list, an example of which is shown below. Second, there is no button that will allow you to create custom programming. The programming for TV Stations is automatically provided by the specified Channel Guide Server and updated at regular specified intervals (see [Channel Guide](#) on page 77 for details).

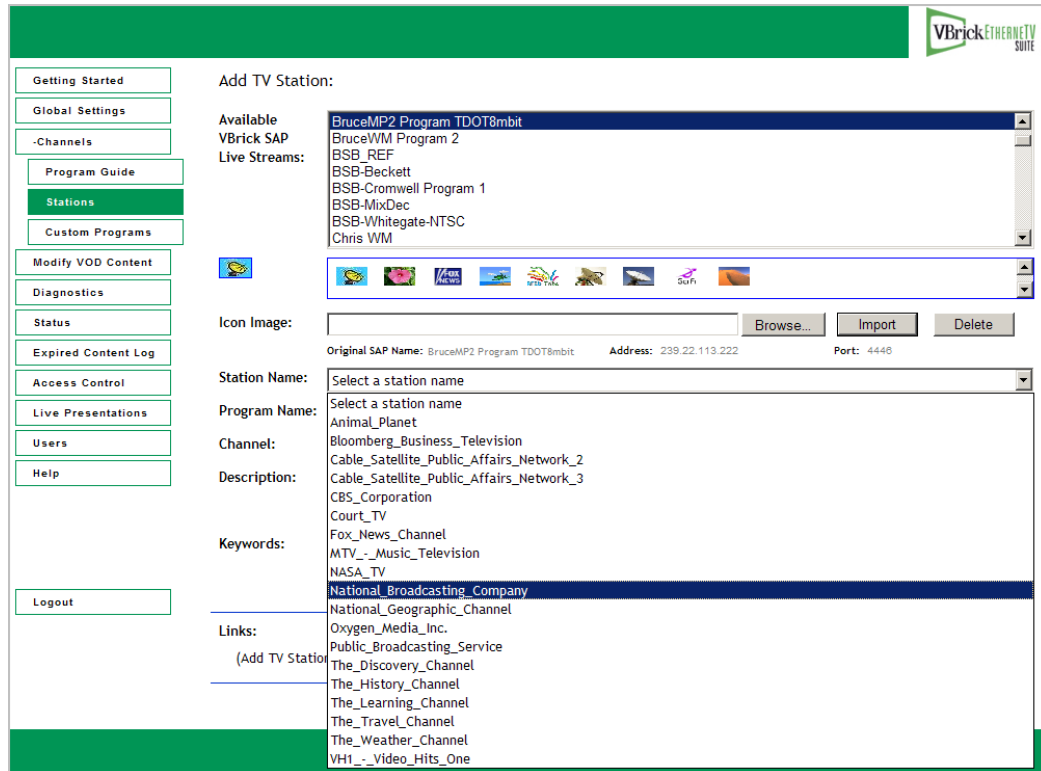

## Add New Links

This feature lets you add a hyperlink to the page you get by clicking the **View Info** link that is associated with each live stream.

### ▼ To add a new link

1. Click **Add New Link** and enter a **Link Title** and **Link Type**.
2. Enter a Web Page URL or navigate to an upload file (an image, a Microsoft Word document, etc.).
3. Click **Add Link** when done and repeat as many times as necessary.

### Add New Link

**Link Title:**   
(Enter Title that will be displayed in the View Info page.)

**Link Type:**

**Web Page URL**   
(Enter URL or copy/paste URL from your Web browser.)

**Uploaded File**

Link Title

The title actually displayed on the View Info page, for example "Additional Information."

Link Type	<ul style="list-style-type: none"> <li>• Web page URL – Enter a valid URL or copy and paste one from your web browser.</li> <li>• Uploaded File – Browse to select an upload file. This can be a PowerPoint, an image, or any file you want to make available to end users. The file is automatically uploaded to the Portal Server and the Portal Server creates a URL for end users to access it.</li> </ul>
-----------	--

## Custom Programs

This page is used to add programming information to an existing station. You can only program custom stations; TV stations (if present) are auto-programmed by a Channel Guide Server. You use the **Custom Programs** page to manually create programming data and associate it with a Custom Station. For example, you may want to modify the Channel Guide so that "Monday Night Football" is shown in the 8–10 P.M. time slot on Monday nights from September through January.

### Add Custom Programs

- ▼ To add custom programming to a custom station
  1. Click on **Custom Programs** to display the Custom Stations page.
  2. The "Custom Station" dropdown list shows all currently defined *custom* stations. Select a Custom Station from this list and then click **Add New Custom Program**.
  3. Use the fields explained below to create custom programming for the selected station. Click on the header titles as appropriate to sort the entries in the list.
  4. Use the horizontal slider bar to display all fields. When done, click **Add**. The program will be added to the specified time slot and you will see a view similar to Figure 16 when you mouseover the item in the Channel Guide on the user interface.

---

**Note** When *TV Station* program data is updated from the Channel Guide Server, all expired *Custom Station* program data (more than 14 days old) is purged.

---

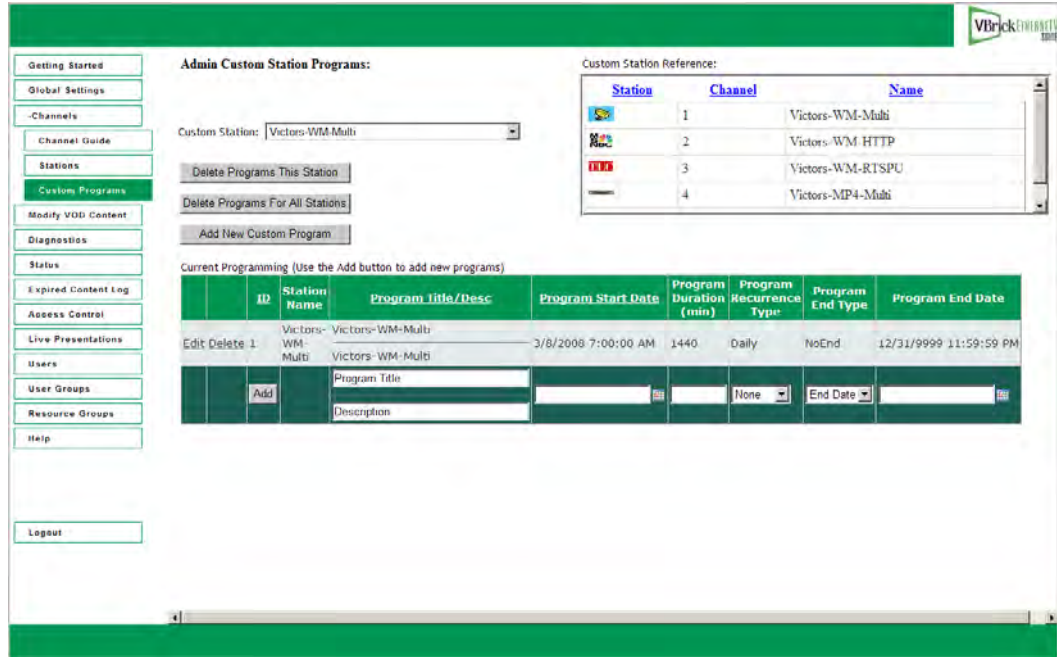

Custom Station	From the dropdown list, select a defined Custom Station for which you want to define a program.
Delete Programs This Station	Delete all programming data for the <i>selected</i> station.
Delete Programs For All Stations	Delete all programming data for <i>all</i> stations.
Add New Custom Program	Add a new line at the bottom of the "Current Programming" list for a new custom programming item.
ID	Program ID. Read only.
Station Name	Station Name. Read only.
Program Title/Desc	Program Title – is shown in the Channel Guide, for example "Monday Night Football." Description – is shown on the popup (see Figure 16) when you mouseover the item in the Channel Guide and click Info.
Program Start Date	Use the calendar to select the start date and start time. Alternately, you can manually enter the values in the proper format: for example: <b>3/10/2008 5:30:00 PM</b>
Program Duration	Required. Program length in minutes.
Program Recurrence Type	None   Daily   Weekly. If weekly, occurs on the same <i>day</i> as specified in Start Date.
Program End Type	Select NoEnd or EndDate and use calendar.
Program End Date	Use the calendar to select recurrence end date.



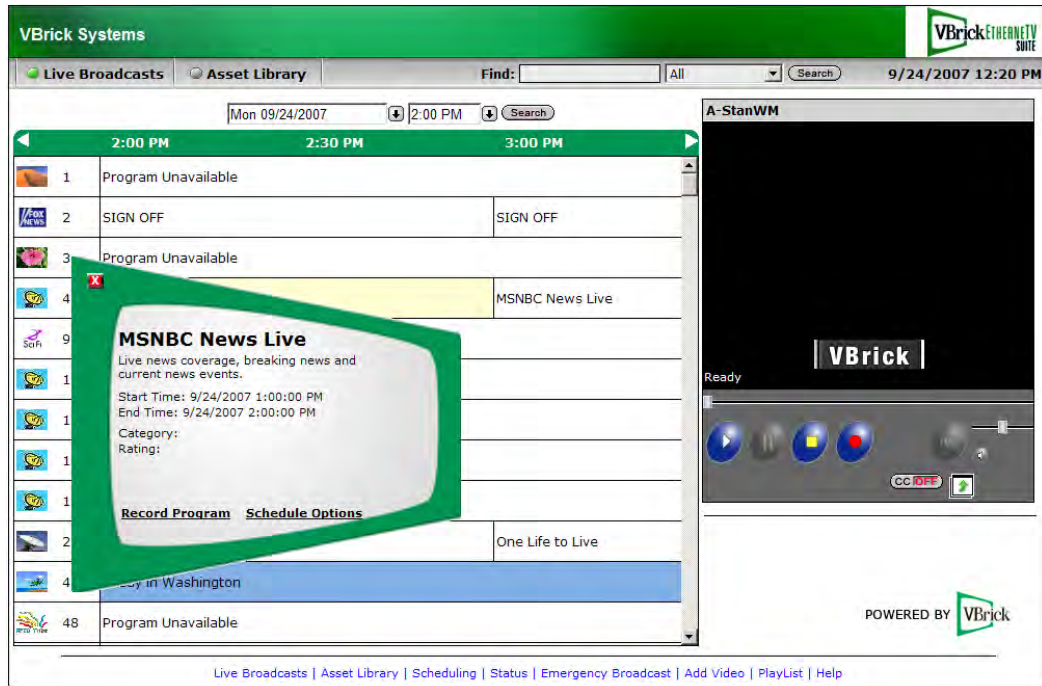

**Figure 16.** Custom Program Data

**Note** The message "Program Unavailable" in the Channel Guide means there is no programming data associated with the stream. *It does not mean the stream itself is unavailable.* You can still click on the stream to launch it in the preview window.

## Edit Custom Programs

▼ To edit a Custom Program

1. Navigate to the program you want to change and click **Edit**.
2. Manually edit any of the fields as necessary and click **Update** when done.

## Modify VOD Content

Video on Demand Servers only. Administrators and authorized users can modify and delete content located on their video on-demand servers. (Note that you cannot delete or modify any content files that are currently in use.) Administrators can find or filter the displayed assets by clicking on **All**, **Keyword**, **Title**, or **Expiration Date**. You can also use this window to set **Expiration**, define the maximum number of concurrent viewers, and update expiration dates for purchased content. Also, be aware that a user with publishing permissions can delete content by clicking the **Info** hyperlink and then **Delete Video**. To disable this user option, disable the user's content publishing permissions (see [Allow Content Publishing](#) on page 111).

### *Purchased Content Expiration*

Purchased content is protected against theft, piracy, or copyright violation by means of an expiration date or viewing period. Each piece of content has an optional expiration date in the database. If the current date is later than this expiration date, the content cannot be

viewed by a Portal Server user. When new content is added (for example using Add Video or autoingest), administrators can optionally enter an **Expiration Date** or **Viewing Period** and can limit the number of concurrent viewers. This data can be modified at anytime. The Expired Content Log shows all expired content on your system in chronological order with the oldest expiration date first. See Copyright Protection on page 3 for more information.

If third-party content is purchased from VBrick, however, the **Expiration Date** or **Viewing Period** are automatically populated with read-only data that cannot be changed without updating the license. (**Content Provider** and **Content Group** are only populated when you select purchased content.) If you purchased third-party content from VBrick, this content was installed on your VOD server(s) prior to shipment. If you purchased content later, this content can be mass-ingested into the Portal Server using a provided utility. See Purchased Content Ingestion on page 177 for more information.

Search box (All)	Search for specific assets by selecting All, Keyword, Title, or Expiration Date. Then click Refresh.
Filter Pattern	Search for specific assets using a filter pattern. Type any text string and click Refresh. For example, type <b>mp4</b> to search for assets with <b>mp4</b> in the title. The filter does not recognize "wildcards" and is not case-sensitive.
Name	Video content name. Click on <b>Refresh</b> to re-paint the screen or <b>Purge</b> button to remove the artifacts of failed Delete operations.

Expiration	Expiration date if any.
Folders	Use to navigate to a specific folder.
Filename	Click once on any named content in the list to populate this field.
Expiration	<ul style="list-style-type: none"> <li>Expiration Date – set date in <b>mm/dd/yyyy 12:00 AM</b> format.</li> <li>Viewing Period – set a value for viewing period in hours, days, weeks, months, or years.</li> </ul>
Max. Concurrent Users	Defines the maximum number of users who can view this stream at the same time. Select Unlimited or enter a value greater than zero.
Content Provider	This read-only field is populated with information when you select a video that was included in content purchased from VBrick.
Content Group	This read-only field is populated with information when you select a video that was included in content purchased from VBrick.
Valid Licenses	This dropdown displays a list of all currently valid licenses for content purchased from VBrick. Select the license you wish to update.
Update all content expiration for the selected license	Use this field to update the expiration dates of purchased content. First install the license you receive from VBrick (see <a href="#">Installing Serial Numbers and License Files</a> on page 15). Then check this box and click Submit to update the content expiration data for the select license.

▼ To modify VOD Content

1. Click on the content to be changed.
2. Enter a new filename and/or path for that file. Note that the file must be alphanumeric characters and cannot contain embedded spaces.
3. Set the **Expiration Date** or **Viewing Period** as necessary.
4. To delete a file, select the file and click **Delete**.

**Note** NXG1 only. You cannot rename or otherwise manage VOD files stored on some legacy NXG1 servers. This feature is supported on all NXG2 servers and on all other servers currently available with ETV Portal Server.

## Diagnostics

This window displays information about Scheduler events only. It displays system log messages by source and time and (generally) IP address. Use **Clear All** to empty the log.

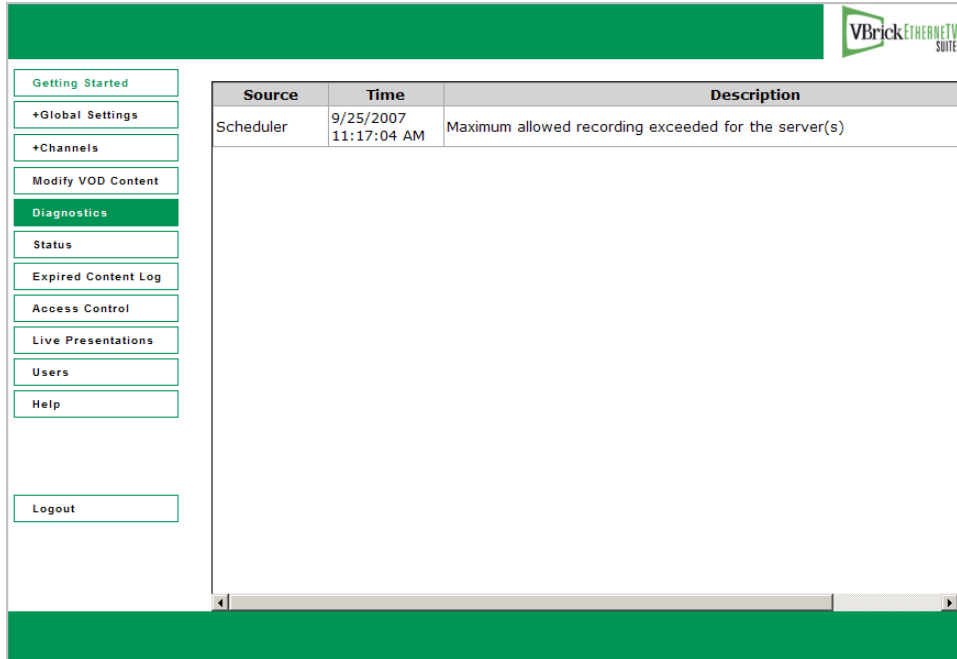

## Status

This window shows the status of videos being added or recorded. Use **Refresh** and **Purge** as necessary. Use the tree controls on the left to expand (or contract) individual entries. Click the Cancel icon  to the left of each to cancel a recording or ingestion in progress. This also cancels the recording on the **Live Broadcasts** page.

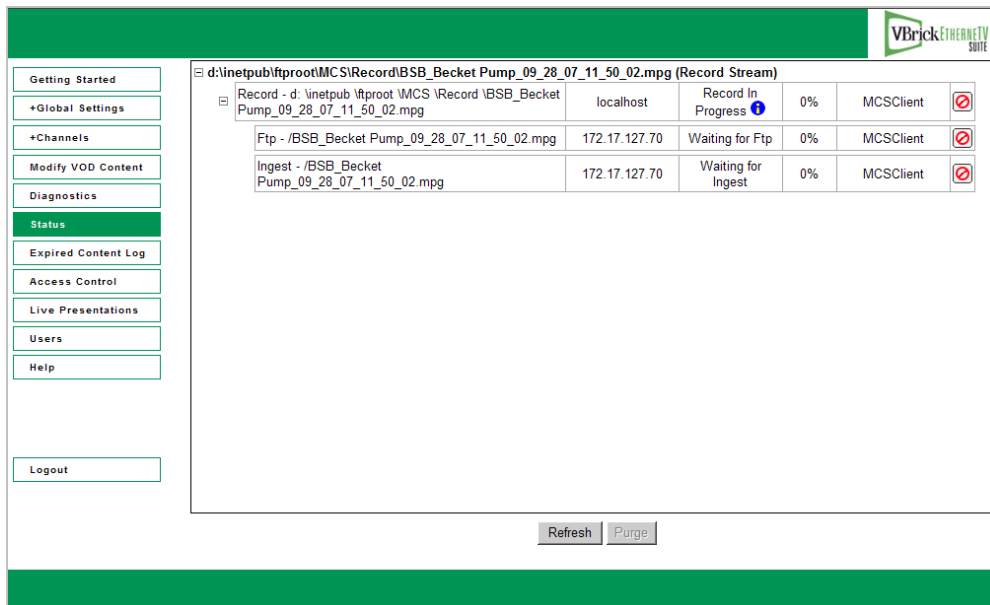

## Expired Content Log

This window shows all expired content in chronological order with the oldest expiration date first. Click **Purge All** to delete all records in the log. See [Modify VOD Content](#) on page 85 and [Stream Restrictions](#) on page 29 for more information.

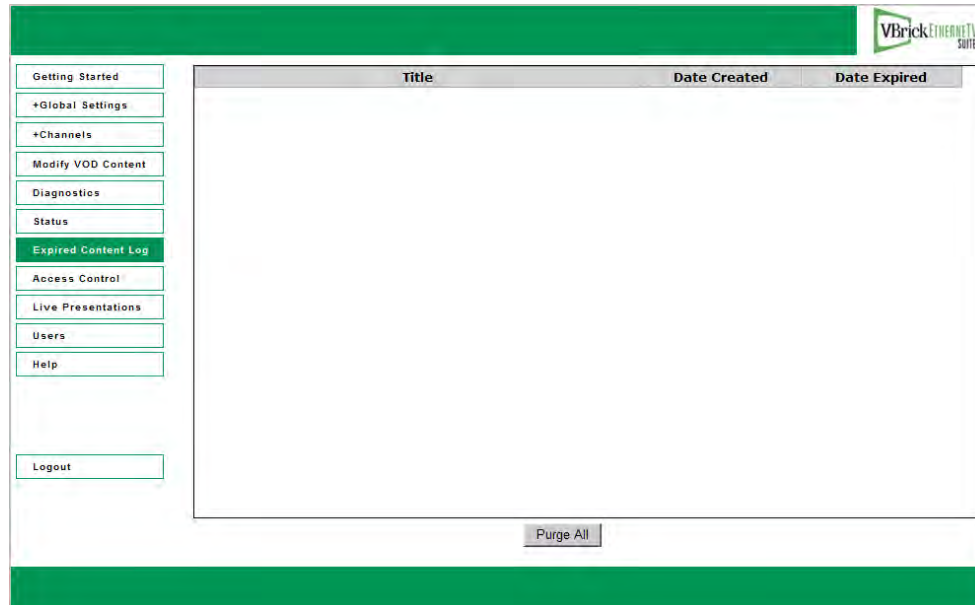

## Access Control

Under the Access Control section, administrators have the ability to enable Authentication and Authorization which requires users to login and be authenticated. By default **Enable Authentication and Authorization** is unchecked which allows everyone to access all content and all functions (recording, publishing, etc.). When Access Control is enabled, **User Groups**, and **Resource Groups** are shown on the navigation bar. Access control determines what functionality is available to each user. For example some users may have unlimited access, while others can only view certain live channels and may not have permission to record live channels or add videos to the VOD server. [Users and User Groups](#) on page 103 explains in detail how configure users and groups.

Access control also lets you specify which folders are used when individual users record live broadcasts, add videos, or autoingest content. If you do not enable **Authentication and Authorization**, all of these actions default to the root folder (which can quickly get cluttered).

---

**Note** As soon as you check **Enable Authentication and Authorization**, users will be prompted for User Names and Passwords. VBrick recommends configuring the system prior to user access or during off hours when the network is idle.

---

Enable Authentication and Authorization	Enable authentication and authorization which requires users to login and be authenticated. If not checked, all users have access to all functionality and content.
Use VBrick database	Use the VBrick (non LDAP) database provided with ETV Portal Server.
Use LDAP database	Use an LDAP database. VBrick supports major LDAP vendors but only Microsoft Active Directory and Novell eDirectory are fully tested and supported.
Use RSA authentication	Use RSA authentication provided by RSA, the Security Division of EMC.

### *Use LDAP Database*

Administrators have the option of using the onboard **VBrick database** for authentication, using an **LDAP database**, or using both. *VBrick supports major LDAP vendors but only Microsoft Active Directory, Novell eDirectory, and OpenLDAP are fully tested and supported.* The Portal Server supports multiple LDAP servers. Use the options on the following page to add or manage LDAP servers.

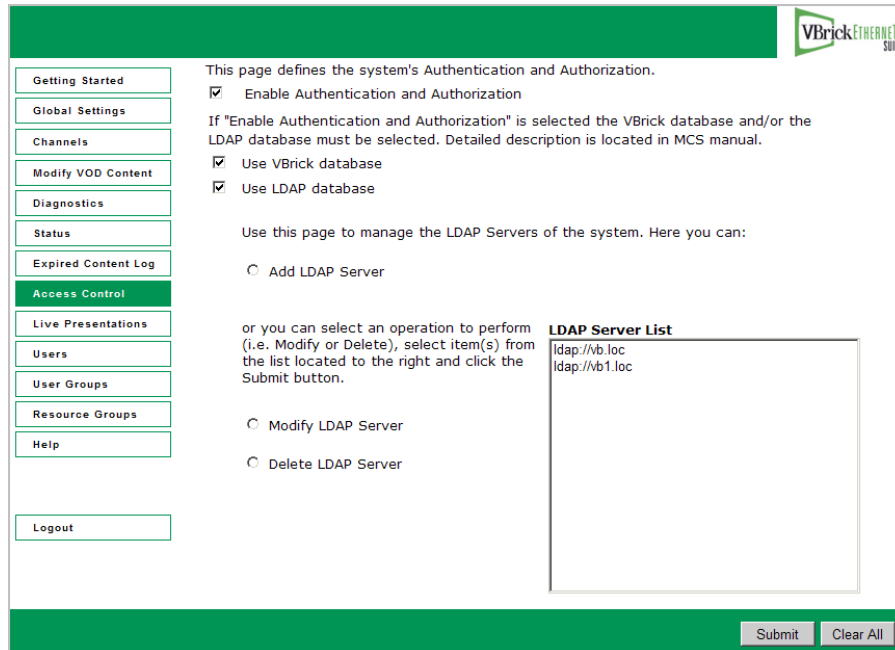

If authenticating against Microsoft's Active Directory, check the **LDAP Server is Microsoft Active Directory** check box and enter the path to the LDAP server in the **LDAP Path** box. If authenticating against a directory other than Microsoft Active Directory, do not check **LDAP Server is Microsoft Active Directory**. LDAP (Lightweight Directory Access Protocol) is a standardized method to access directories from multiple vendors. A complete discussion of LDAP is beyond the scope of this document.

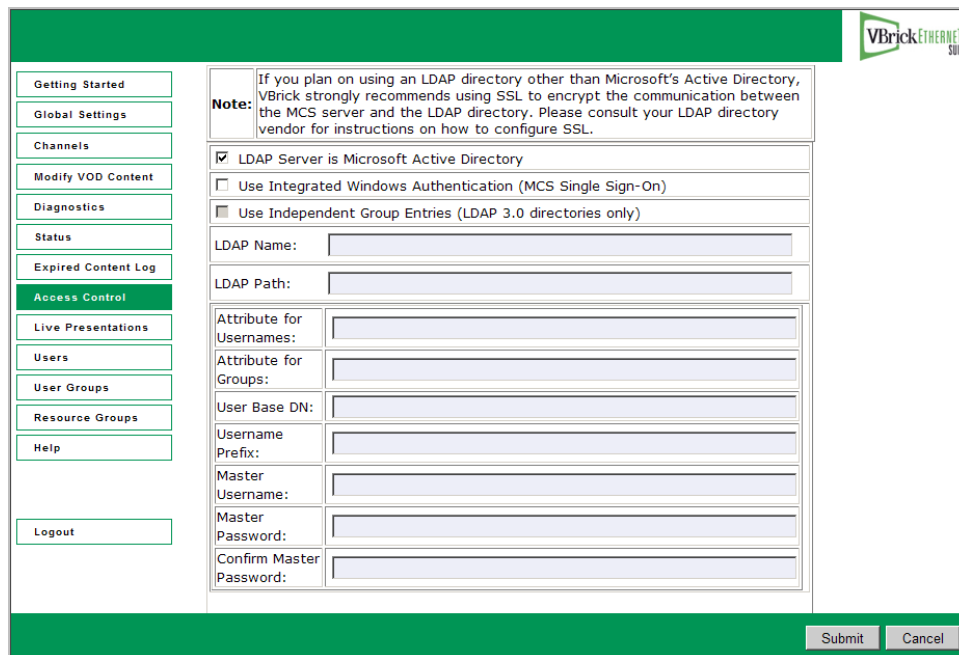

LDAP Server is Microsoft Active Directory

Check only if using Microsoft Active Directory.

Use Integrated Windows Authentication	Use "single sign-on." This means that once you login to your local network, you can open ETV Portal Server without re-entering your login credentials. See below <a href="#">Using LDAP with Single Sign-On</a> .
Use Independent Group Entries	If unchecked (the default), the user's group memberships are stored as attributes of the user's directory entry identified by the <b>Attribute for Groups</b> field. If checked, MCS will support LDAP models where group entries are independent of user entries. If checked, the Independent Group ObjectClass and Independent Group Identifier fields are required.
LDAP Path †	<i>Required by ETV Portal Server.</i> Case sensitive. Must begin with <b>LDAP://</b> Points to a specific position in the LDAP tree and also includes the machine IP address (or Domain name) on which the server is running. For example use <b>LDAP://myLDAPServer</b> with Microsoft Active Directory; use <b>LDAP://myLDAPServer:636</b> with Novell eDirectory. For more information, see <a href="#">Installing the Root Certificate</a> on page 94.
Attribute for Usernames †	<i>Required by ETV Portal Server.</i> Attribute to identify a user. The following sample username attributes are widely used but refer to a specific LDAP schema: <ul style="list-style-type: none"> <li>• Microsoft Active Directory: <b>sAMAccountName</b></li> <li>• Novell eDirectory: <b>uid</b></li> </ul>
Attribute for Groups †	<i>Required by ETV Portal Server.</i> Attribute to identify the group to which a user belongs. The following sample group attributes are widely used but refer to a particular LDAP schema: <ul style="list-style-type: none"> <li>• Microsoft Active Directory: <b>memberOf</b></li> <li>• Novell eDirectory: <b>groupMembership</b></li> </ul>
User Base DN	Base distinguishing name (DN) of user nod and/or the Base DN for the Master Username.
Username Prefix	Used in non-Active Directory environments where the user name is prefixed with a specific string such as <b>uid=</b> or <b>cn=</b> . The following sample prefixes are widely used but refer to a specific LDAP schema: <ul style="list-style-type: none"> <li>• <b>uid=</b></li> <li>• <b>cn=</b></li> </ul>
Master Username	Required for single-sign-on. User name that has admin permission to browse the LDAP tree. Used to browse the LDAP tree to get user groups.
Master Password	Required for single-sign-on. Password for Master Username.
Ind. GroupObjectClass	A group attribute in the LDAP database. Identifies which entries will be searched for user memberships.
Ind. Group Identifier	The group attribute that uniquely identifies a group. MCS will match the values returned for this attribute with group names entered on the <b>User Groups</b> page.

† ETV Portal Server required field. All others are optional.



---

**Note** The Softerra LDAP Browser 2.6 provides an Explorer-like LDAP client you can use to browse the LDAP tree. It is available for Windows only and can be downloaded free of charge from Softerra at <http://www.ldapbrowser.com>

---

## Using LDAP with Single Sign-On

To use single sign-on, go to **Access Control** and then check **Enable Authentication and Authorization** and **Use LDAP Database**. If the LDAP server is Microsoft Active Directory, you can select **Use Integrated Windows Authentication** to enable "MCS Single Sign-on." This means that once you login to your local network with your assigned credentials, you can open ETV Portal Server without re-entering your login credentials. ETV Portal Server uses your assigned credentials to authenticate and authorize your defined permissions within the application. (If using an LDAP directory other than Microsoft's Active Directory, VBrick strongly recommends using SSL to encrypt the communication between the Portal Server and the LDAP directory. Please consult your LDAP vendor documentation for instructions on how to configure SSL.) When configuring for Integrated Windows Authentication, keep the following points in mind:

- Integrated Windows Authentication is only valid when using LDAP Authentication with Microsoft Active Directory.
- You must perform an additional configuration step in IIS as explained below in [Configuring IIS for Single Sign-On](#).
- Integrated Windows Authentication only works seamlessly with Microsoft Internet Explorer browsers (Windows and Macintosh). When accessing ETV Portal Server, you will get a popup login window *only* if you have not previously logged in to the network.
- When using Integrated Windows Authentication, all single-sign-on users must have an Active Directory account and the Portal Server must be part of the Windows domain.
- When using Integrated Windows Authentication, Microsoft Internet Explorer's default behavior is that it will *not* prompt for an ID/password when the server is in the **Local Intranet Zone**. (By default, Internet Explorer assumes a URL without a period (.). This means <http://yourserver/> is in the **Local Intranet Zone** while <http://yourserver.yourcompany.com> (or <http://199.88.7.11>) is in the **Internet Zone**.

---

**Note** If single sign-on is enabled on multiple LDAP servers, when a user signs on for the first time, the system validates the login credentials against all servers configured for single sign-on. If you are validated by at least one server, you are automatically logged in. In most cases when single sign-on is enabled, the user will *not* be prompted for a **Domain** name at login.

---

## Configuring IIS for Single Sign-On

Use the following steps to configure IIS for single sign-on. *If you do not perform these steps, the login page will likely be blank when you launch the Portal Server.*

- ▼ To configure IIS for single sign-on
  1. Go to **Start > Administrative Tools > Computer Management**.
  2. Expand **Services and Applications** and expand **Internet Information Services (IIS) Manager**.
  3. Expand **Web Sites** and then right-click on **Default Web Site** and select **Properties**.

4. Go to **Directory Security > Authentication and access control** and make sure that **Integrated Windows authentication** is checked on the following window.

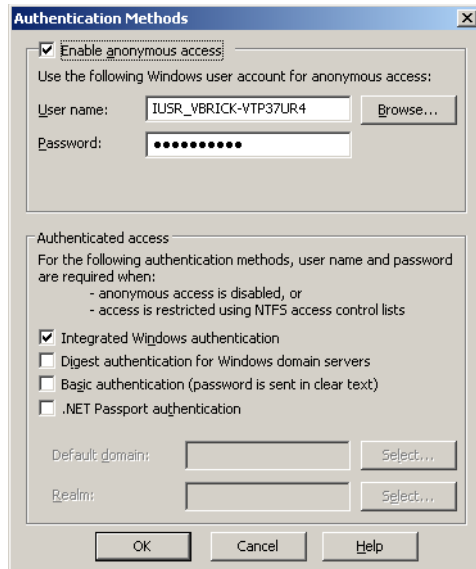

## Using Single Sign-On

- ▼ To use single-sign-on (and avoid username/password prompts), you must do **one** of the following
  - Access the Portal Server by the *alphabetical name* (for example <http://yourserver>).
  - Access the Portal Server by the *IP address* in which case you must also add the Portal Server to the **Local Intranet Zone (Internet Options > Security > Sites)**. This setting can be pushed company-wide by an administrator using security policies.
  - Change Internet Explorer's default settings to allow **Automatic logon with current username and password** (Go to **Internet Options > Security > Custom Level > User Authentication**).

## Using LDAP with SSL

### Installing the Root Certificate

If the LDAP server requires SSL (Secure Sockets Layer) for encryption and authentication, you will need to install the certificate locally on the ETV Portal Server as a **Trusted Root Certificate Authority**.

- ▼ To install the root certificate locally on the ETV Portal Server as Trusted Root Certificate Authority
  1. Open Internet Explorer.
  2. In the address bar type <https://LDAPSERVER:636> where **LDAPSERVER** is the address of the LDAP Server associated with Certificate Authority (See [Resolving Other Security Alerts](#) on page 96) and **636** is the SSL port used to authenticate with the LDAP Server.
  3. When Internet Explorer displays a Security Alert dialog (Internet Explorer 6) or certificate error screens (Internet Explorer 7), click **View Certificate**.
  4. A Certificate window will open, click on the **Certificate Path** tab.

**Note** Internet Explorer 6 only. All three items in the Security Alert window below must be in compliance. The first item can easily be installed using these instructions; for the middle item, the local CA will need to create a new certificate if it is out of date; for the last item, the name of the certificate will need to match the address entered in the address bar of your browser.

- If there is more than one certificate listed in the **Certificate Path** tab, choose the root certificate by selecting the top-most certificate and then clicking **View Certificate**.

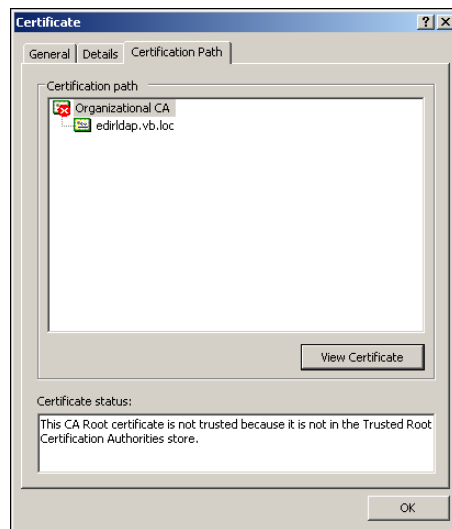

- Choose the **General** tab, and click **Install Certificate**.
- Click **Next**.

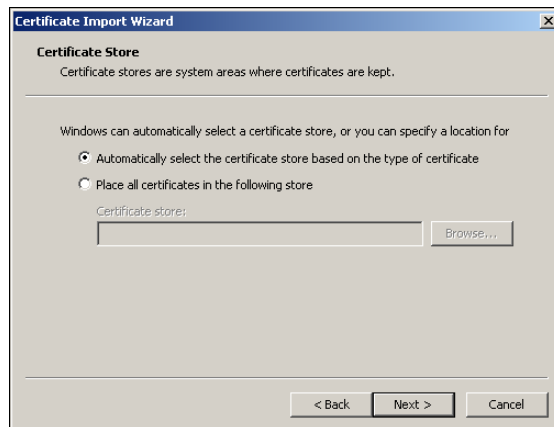

- Click **Place all certificates in the following store**.
- Click **Browse**.



10. Check **Show physical stores** check box.
11. Click the plus sign (+) next to **Trusted Root Certificate Authorities**.
12. Select **Local Computer** and click **OK**.
13. Click **Next** and **Finish** when done.

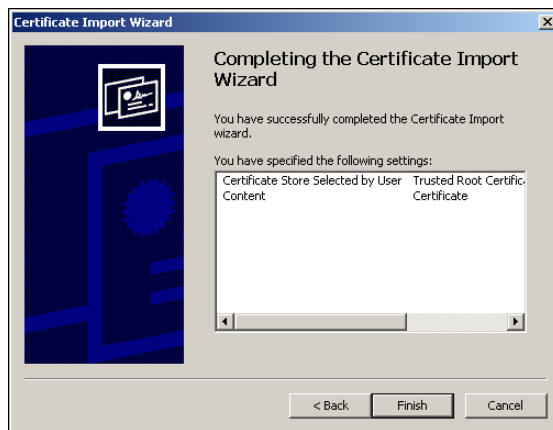

### *Resolving Other Security Alerts*

If you are receiving any other Security Alerts you will need to identify the problem as either "out of date" or **The name on the security certificate is invalid**. If the certificate has an invalid name, follow the steps below to determine the valid name. If the certificate has an "out of date" error, a new certificate must be created.

- ▼ To determine the valid certificate name
  1. Click **View Certificate**.
  2. The **General** tab shows who the Certificate is issued to; the address shown is the address that will need to be used in the browser address bar, as well as in the configuration of the LDAP Server.

For example: if the information is `edirldap.vb.loc` then the address bar should read `https://edirldap.vb.loc:636` and the LDAP Path should read `LDAP://edirldap.vb.loc:636` To find out if the address is accessible, ping the address given in a command prompt. If the address is not accessible you must create or add a DNS entry to the Host file on the local server or generate a new certificate with the correct information.

### *Use RSA Authentication*

EtherneTV Portal Server v4.3 or higher supports RSA authentication.

- ▼ To configure the Portal Server for RSA Authentication
1. Launch the Portal Server Admin Console and click on **Access Control** in the left navigation panel. (Note that the following screen shows sample data.)

2. Check the **Use RSA authentication** option to enable RSA authentication.
3. Populate the User ID, E-Mail, and Group fields as explained below:.

User ID Field Name	Name of the HTTP header field that will store the unique User ID. For Vodafone, this may be the VDUID or the E-Mail address.
E-Mail Field Name	Name of the HTTP header field that will store the user's e-mail address.
Group Field Name	Name of the HTTP header field that will store the user's group/organization membership. For Vodafone, this will be the <b>VfOpCoID</b> .
Use Group ID	Check this box if the Group Field Name (above) returns a group ID rather than a group name. For Vodafone, this should be checked.

### Configuring the Group ID

The **User Group ID** field (see below) will display only if the **Use Group ID** box is checked on the Access Control page. The **User Group ID** is a unique identifier for the group. To set the Group ID, go to **User Groups > Add User Groups > Add/Modify Group Information**.

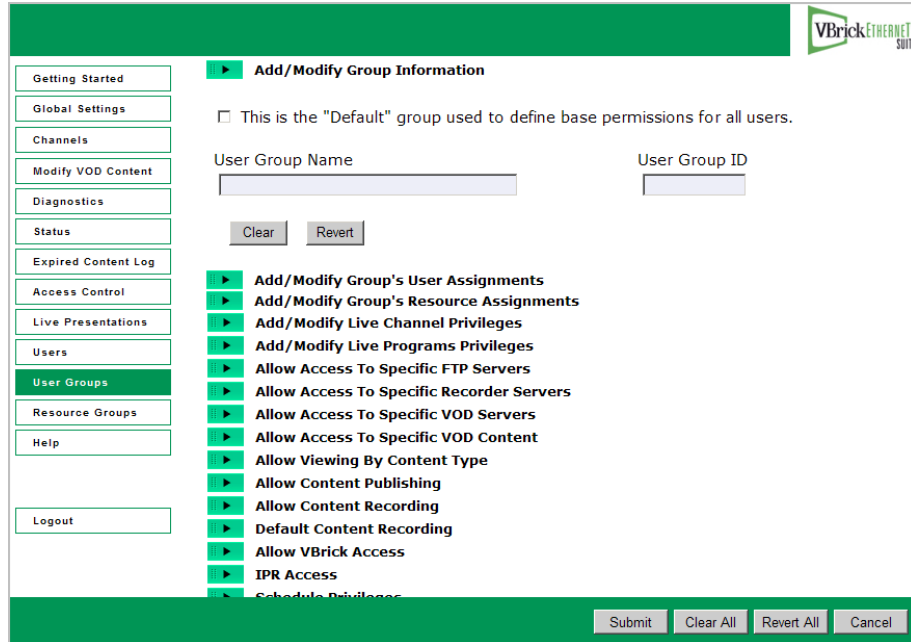

"Default" Group	This is the default group used to define base permissions for all users.
User Group Name	A unique name for the group.
User Group ID	The User Group ID is a unique identifier for the group.

## Live Presentations

Use this window to manually remove a live presentation listing from the **Live Broadcasts** page. If the presentation is terminated abnormally for any reason (for example if the presenter exits PowerPoint without going **OFFLINE**), you may need to manually remove the presentation links. See [VBPresenter](#) on page 133 for more about configuring live presentations.

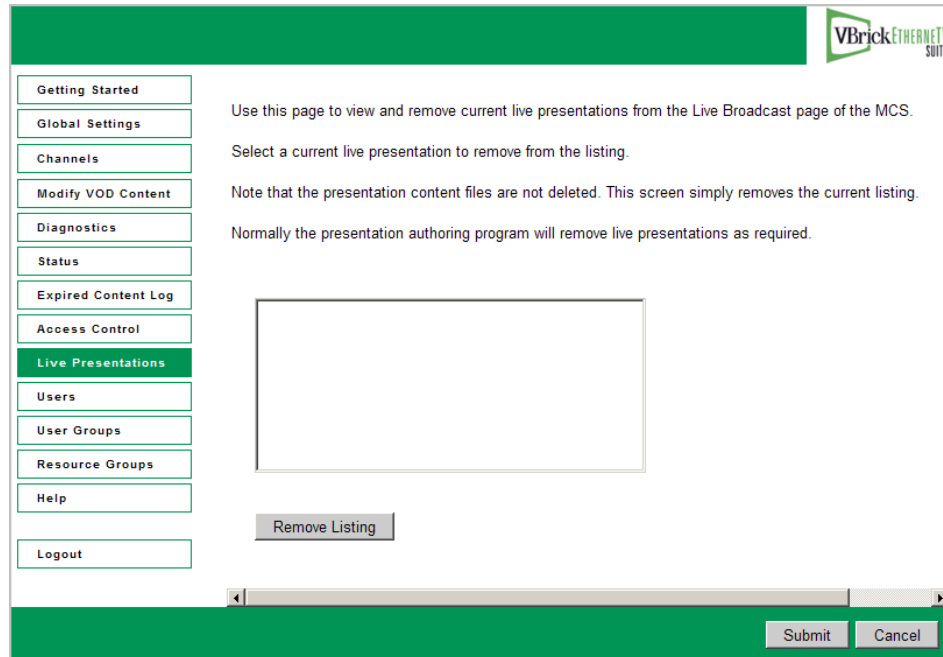

## Users

See [Configuring Users](#) on page 107.

## User Groups

See [Configuring User Groups](#) on page 113.

## Resource Groups

See [Resource Groups](#) on page 114.

## Help

This command launches the ETV Portal Server online help system in a new window. This online help system provide fast full-text search and makes it easy to find the information you need. To navigate in the help window, use the tree controls on the left to expand a topic and the navigation buttons at the top to move to a different page. Go to **About this Help > Using this Help** for information about how to Print pages and use the full text Search feature.

**Contents**   **Search**

**VBrick**

## Welcome

This online help is best viewed with **Internet Explorer 7.0** (Windows), **Safari 1.2** (Macintosh), or **Firefox 2.0** (Linux) at a minimum screen resolution of 1024x768. (The pages and the application may not display or function properly with earlier versions or other browsers.) For best results, please take a few minutes to upgrade your browser from the update pages at [Microsoft](#) , [Apple](#), or [Mozilla](#). Copyright © 2008 VBrick, Inc. All rights reserved. Last updated: October 27, 2008

### EtherneTV v4.4 Online Help

**This online help system provides access to all current VBrick EtherneTV documentation.** It has a powerful search engine so you can get answers to technical questions in seconds; it also has the complete documentation set in PDF format if you need hard-copy. Our publications team is committed to providing first-rate documentation and your feedback is important to us. If you find errors or omissions, click the e-mail icon in the upper-right corner of this window or send your feedback to [documentation@vbrick.com](mailto:documentation@vbrick.com). You can get online help from the Portal Server application or from the Admin pages and you can quickly search for information in the following documents without ever leaving the Portal Server application.

<a href="#">Portal Server User Guide</a>	Written for ETV Portal Server users. Explains all Portal Server user functionality. It explains how to use Portal Server to watch television and browse the video-on-demand library, as well as how to schedule recordings, broadcasts, and video conferences.
<a href="#">Portal Server Admin Guide</a>	Written for ETV Portal Server administrators. Explains how to configure and manage the complete ETV Portal Server environment. It explains how to manage global settings, add servers, and customize the system. It also explains how to manage access control and digital certificates.
<a href="#">WM IP Receiver Admin Guide</a>	Written for technicians or system administrators who will be configuring, upgrading, or using a VBrick WM IP Receiver.
<a href="#">Set Top Box Quick Start</a>	Written for anyone who will be installing or using a set top box. Provides a quick

## About

This page displays the Portal Server (MCS) version number (for example 4.4.0.0) as well as license and serial number data for each installed module. The serial numbers provide warranty and tracking information. You may be asked for the module serial number when requesting help from VBrick Support Services.

**VBrick EtherneTV SUITE**

Getting Started  
Global Settings  
Channels  
Modify VOD Content  
Diagnostics  
Status  
Expired Content Log  
Access Control  
Live Presentations  
Users  
Help  
**About**

MCS Version: 4.4.0.0

License	Description	Serial Number
Channel Guide	Channel Guide License Exists	123456789
MCS	MCS License Exists	123456789
Record	Record License Exists	123456789
Schedule	Schedule License Exists	123456789
Reporter		
Backup		

Logout



## Logout

This command logs you out of the application and lets you log back in as a different user. This may be necessary to gain access to certain functionality. For example, some users may not be allowed to create thumbnails and you may want to login as a user who has the permissions to do this.



## Users and User Groups

### *Topics in this section*

Overview .....	103
Configuring Users and User Groups .....	104
Configuring Users .....	107
Configuring User Groups .....	113
Resource Groups .....	114
IPR Authentication .....	116

### Overview

Adding the EtherneTV system to a network provides many benefits in the form of increasing access to rich media. However, because of the sensitive nature of some video assets, many customers want to limit access to different users or groups of users. VBrick's EtherneTV Portal Server allows Administrators to setup the system in just this manner. The ETV Portal Server makes it easy to provide different Users or User Groups access to different resources. The ETV Portal Server Access Control system allows administrators to allow/deny access to the Portal Server for Windows-based PCs, Macintoshes, and IP Receiver:

- Viewing of certain Live Channels
- Viewing of stored content from specific VOD folders
- Publishing content to specific VOD folders
- Recording content to a specific VOD folder
- Allow the viewing of content from only specific VOD servers on the network
- The ability to place bandwidth restrictions for viewing content
- The ability to limit certain users to only access Multicast or RTSP (unicast) content
- The ability to group content resources (Live Channels and/or VOD content) into Resource Groups, which allows the setup and modification of the Access Control functionality to take place much more easily.

The ETV Portal Server is permissive by default, meaning, authentication is not enabled and access to the entire functionality of the server is allowed. However, to follow good security practices, once the Access Control functionality is enabled on the Portal Server, all resources are by default *not* available to any users. Administrators need to provide access to resources to different users or user groups.

### *User-Related Definitions*

The ability to provide different users different access to resources on a network is typically referred to as access control, authentication and authorization, and/or access management. VBrick refers to this functionality as Access Control. In order to fully understand the range of functionality of the ETV Portal Server Access Control system, it is beneficial to define some of terms that are used in this section.

---

**Authentication** – Authentication is the process of identifying an individual, usually based on a username and password. In security systems, authentication is distinct from authorization (see below), which is the process of providing individuals access to resources based on their identity. Authentication merely ensures that the individual is who he or she claims to be, but says nothing about the access rights of the individual.

The ETV Portal Server Access Control system allows administrators to authenticate users against the ETV Portal Server database or authenticate users against an LDAP directory. More details on the different authentication databases are given below.

**Authorization** – Authorization is the process of granting or denying access to a network resource. Most computer security systems are based on a two-step process. The first stage is authentication, which ensures that a user is who he or she claims to be. The second stage is authorization, which allows the user access to various resources based on the user's identity. In the ETV Portal Server, all authorization is done directly on the ETV Portal Server, through the ETV Portal Server database.

**LDAP** – LDAP (Lightweight Directory Access Protocol) is a set of protocols for accessing information directories. The LDAP standard defines both a network protocol for accessing information from the directory and an extensible structure for defining how the information is organized in the directory. The advantage of using an LDAP directory is centralized management of users. For example, a new user needs only to be entered once into the LDAP directory and all future modifications to that user can be done in the same central location. Different applications can authenticate and/or authorize users against the LDAP directory.

There are numerous LDAP directory products on the market today, but the most popular are Microsoft Active Directory, Novell eDirectory, Sun iPlanet, and OpenLDAP. *VBrick supports major LDAP vendors but only Microsoft Active Directory and Novell eDirectory are fully tested and supported.*

**VBrick Database** – The ETV Portal Server server ships by default with the MySQL database, which is a fully ODBC-compliant database. (Open Database Connectivity is a standard database access method.) For those environments that have not migrated to an LDAP directory-based user management system, all of the authentication functionality can be done directly in the ETV Portal Server database itself. Also, for those environments that are using LDAP directories for Authentication, all of the Authorization functionality also takes place in the ETV Portal Server database. Additionally, to reduce the chance of system lockout, all Administrative Users are located in the ETV Portal Server database.

**Resources and Resource Groups** – In the ETV Portal Server, providing a user with Resources refers to providing them access to a particular functionality of the EtherneTV system. These include the ability to view Live Channels, to view VOD content, to publish content to the VOD, and to record content or schedule a recording. A unique feature of the ETV Portal Server software is the ability to group Resources into Resource Groups. This allows the administrator to quickly and easily assign several resources at once to specific Users or User Groups.

## Configuring Users and User Groups

### *1. Setup and Configure ETV Components*

The following products need to be setup and properly configured prior to configuring Access Control.

**ETV Portal Server** – The ETV Portal Server needs to be properly setup and configured on the network. The following items should be configured in the Portal Server interface:

- If there is a VOD server(s) in the system, the proper addresses for these servers need to be entered into the Portal Server Administrative pages and connectivity to those servers should be ensured.
- The folder structure on the VOD server should be defined (even if there is no content in these folders) as folders are how the Access Control functionality provides access to end users to view VOD content, publish content, and record content. When setting up the folder structure, the Administrator should be thinking about how they plan to provide access to different groups of users. For example, if a corporation wanted to provide certain content to the Engineering group and certain content to the Marketing group, then they would want to set up an Engineering folder and a Marketing folder on their VOD server.
- If there are live streams on the network, then those streams should be provided a channel number if the Administrator wants to provide access to live streams via channel number.
- If security is a concern, SSL should be turned on between clients and the ETV Portal Server server. This allows User Names and Passwords to be encrypted between the client and the server. See the section [Configuring for SSL](#) on page 119 for instructions on how to configure this.

**VBrick** – If there are VBricks in the network, they are auto-discovered but still need to be added to the Portal Server database.

**VOD Server** – If there are VOD servers in the network, again they need to have connectivity to the Portal Server and the folder structure needs to be configured.

**IP Receivers** – If there are IPRs to be deployed in the system, they should be configured with a Host Name, and should be configured to point to the ETV Portal Server.

Additionally, if an LDAP server is going to be used to authenticate users, then the administrator should know the address of the server, the group structures on the LDAP server, and the Context (if the server is not Microsoft's Active Directory).

---

**Note** In order to scan the Groups available in Microsoft's Active Directory, in Windows Explorer, go to **Tools > Folder Options**. On the **General** tab, make sure that the **Show common tasks in folders** is selected. Then go to **Start > My Network Places** and select **Network Tasks > Search Active Directory**.

---

## 2. Choose an Authentication Method

Select one of the following methods:

VBrick Database	The native ETV Portal Server user database provides local authentication for users and administrators.
LDAP Database	Enables the ETV Portal Server to authenticate against, and retrieve user and group data from, an existing LDAP server.

Both methods can be used simultaneously. If LDAP authentication is enabled, the ETV Portal Server will attempt to authenticate against the LDAP server first, and if this is unsuccessful, will attempt to authenticate against the local ETV Portal Server User Database.

---

## **VBrick Database**

If authentication is enabled, you must select a database (either VBrick or LDAP). The VBrick (ETV Portal Server) user database contains user, group, and resource information that provides the Portal Server with information to allow it to provide the appropriate privileges to users and IP Receivers that are accessing the system. Administrators should authenticate users with the native Portal Server user database if:

- User authentication is required, but the organization does not have an LDAP server.
- For IPRs, the organization wishes to use User PINs. Since User PINs are not available in the LDAP directory, the users need to be created in the ETV Portal Server database (Note: only those users that need PINs to access IPRs need to be created in the ETV Portal Server database. PC or Mac users can still be authenticated against LDAP).

## **LDAP Directory Server**

An LDAP directory server contains User and Group information which the ETV Portal Server can authenticate against to verify User's identities. The Portal Server then uses this information to authorize users to access the system. Administrators should authenticate users with an LDAP Directory server if:

- The organization has an LDAP server that they actively manage to allow products to authenticate.
- The ETV Portal Server administrator can obtain the necessary configuration information from the LDAP administrator to allow the authentication to occur.

Using LDAP reduces the amount of administrative time necessary to add and modify users from the ETV Portal Server system. VBrick Systems encourages customers who have LDAP directories implemented to use them for authentication with the ETV Portal Server.

### ***3. Create User Groups on the Portal Server***

Grouping users is common practice and makes administering access to the ETV Portal Server less complicated than administering access by individual user. The ETV Portal Server allows the administrator to create groups, specify group memberships for users, and set access privileges for the group. A user can be a member of one group or multiple groups. Group access privileges also can be set and modified on a per group basis. If an LDAP directory is being used for Authentication, the same group information that is available in the directory can be used to Authorize end users to access the ETV Portal Server. For example, if the organization has three User Groups in its LDAP directory—Marketing, Engineering, and Sales—they can simply create these groups in the ETV Portal Server system, and assign privileges to the groups.

### ***4. Create Resource Groups on the Portal Server***

In the Portal Server software, providing a user with Resources refers to providing them access to a particular functionality of the EtherneTV system. These include the ability to:

- View Live Channels.
- View VOD content.
- Publish content to the VOD.
- Record content or schedule a recording.
- Launch a priority alert.

A unique feature of the Portal Server software is the ability to group Resources into Resource Groups. This allows the administrator to quickly and easily assign several resources at once to more than one User or User Groups. This also makes the ongoing management of this content for these Users or User Groups much easier. For example, if the organization has three User Groups—Marketing, Engineering, and Sales—they might create four resource groups. These Resource Groups would be Full Access, which are resources that everyone can see, and one Resource Group for each of the user groups. Full Access would be assigned to all user groups, and the Marketing Resource Group would be assigned to the Marketing User Group, the Engineering Resource Group to the Engineering User Group, and the Sales Resource Group to the Sales User Group.

Resource Groups provide the added bonus that they allow the Administrator to quickly provide access to new content to Users and User Groups. For example, if the organization originally had ten Live Channels on the network, and another Live Channel was added, the Administrator would simply need to add that Channel to the appropriate Resource Groups and the channel would be available.

## ***5. Create Users on the ETV Portal Server***

Creating users is an optional step that can be completed for the following reasons.

- The organization needs to provide a single user with additional privileges above and beyond what is available to his or her User Group or Resource Group.
- The organization wants to authenticate IPR users using a PIN.
- Users can be assigned to multiple User Groups.

## ***6. Assign Resources to Users or User Groups***

The final step is to provide access to Resources to Users and/or User Groups. The administrator can assign individual resources to Users or User Groups, or can assign Resource Groups (if created) to Users or User Groups. Detailed information on the steps to configure access control and provide access to resources to Users and/or User Groups is provided in the following sections.

# **Configuring Users**

There are several different ways to provide privileges to different User and User Groups with the ETV Portal Server. The easiest way is to use the group structure of an existing LDAP database. LDAP User Groups can be added to the ETV Portal Server system and assigned permissions (see User Groups below). All of the users in this group will have the same permissions. For ease of implementation, VBrick recommends configuring User Groups and Resource Groups (see these sections below), prior to configuring users.

However, if further individual permissions need to be assigned, administrators can add them as a user. Under the users section, administrators have the ability to add, modify and delete users. Submit may be pressed at anytime during the process or can be done when everything has been added/modified. Users will have the permissions of the group as well as the additional permission that are assigned to them. The ETV Portal Server is additive in its permissions, meaning that it takes all of the permissions that are provided to a particular user and provides all of these to the user.

Users can be added by using the VBrick Database if LDAP authentication is not available or desired. Finally, in order to assign user PINs to access IP Receivers, a user assignment is

needed (see [IPR Authentication](#) section below). Note that IPR PIN access is dependent on the VBrick Database being enabled. See [Access Control](#) on page 89 for details.

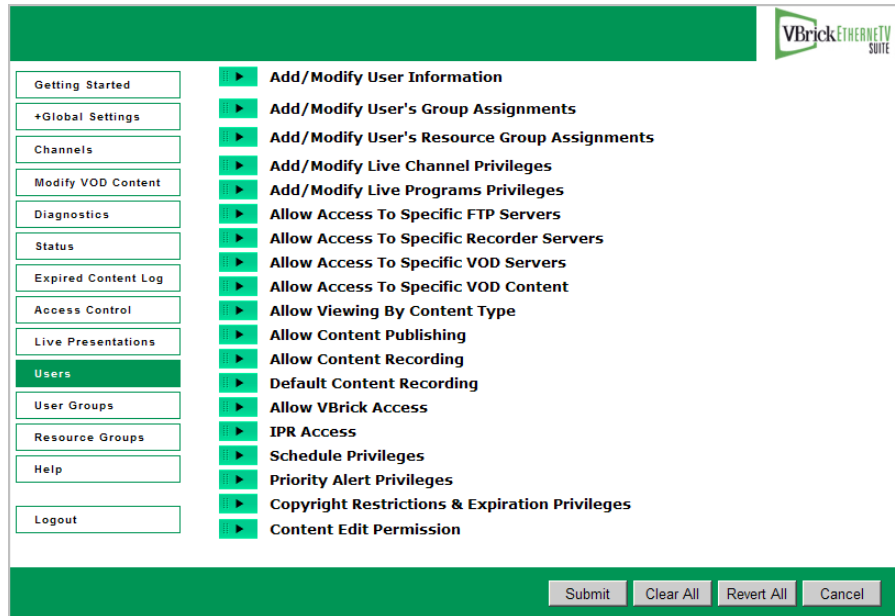

Submit	Save changes and/or navigate to the next window.
Add New	Takes the administrator to the Add New User, User Group, or Resource Group screen (depending on which section you are in)
Clear All	Clears any entries that have been entered in the individual sections.
Revert All	Returns all entries to the last state entered in the database. This selection is important if a mistake is made during entry.
Cancel	Cancels out of the page. Changes are not saved.
Clear	Clear eliminates or de-selects any entries in the particular section.
Revert	Returns the selection to the last state entered in the database. This selection is important if a mistake is made during entry.

Once all selections have been made, you can press **Submit** in the bottom right hand corner of the screen (or any of the other buttons shown above) to submit the information to the database. User privileges include the following options:

Add/Modify User Information . . . . .	109
Add/Modify User's Group Assignments . . . . .	110
Add/Modify User's Resource Group Assignments . . . . .	110
Add/Modify Live Channel Privileges . . . . .	110
Add/Modify Live Program Privileges . . . . .	110
Allow Access to Specific FTP Servers . . . . .	110
Allow Access to Specific Recorder Servers . . . . .	110
Allow Access to Specific VOD Servers . . . . .	111
Allow Access to Specific VOD Content . . . . .	111
Allow Viewing by Content Type . . . . .	111



Allow Content Publishing . . . . .	111
Allow Content Recording . . . . .	112
Default Content Recording . . . . .	112
Allow VBrick Access . . . . .	112
IPR Access . . . . .	112
Schedule Privileges . . . . .	112
Priority Alert Privileges . . . . .	112
Copyright Restrictions & Expiration Privileges . . . . .	113
Content Edit Permissions . . . . .	113

### *Add/Modify User Information*

To add or modify users, select **Users** from the navigation bar on the left.

User	<ul style="list-style-type: none"> <li>• User – Use this option if the EtherneTV system will be accessed by a PC or Mac user, or if Users will be authenticated to IPRs via PIN numbers. This access is not limited to a specific PC or IPR.</li> <li>• IP Receiver – Use this option if the EtherneTV system will be accessed via a IPR attached to a television or other video display. If IP Receiver is selected, then the privilege to the system will be on a per IPR basis. The authentication will take place automatically, so no end user interaction is required. When choosing IPR, the IPR's host name or IP address must be entered, as well as an optional location/description of the IPR.</li> </ul>
Username	To authenticate using an LDAP database, the user name must match exactly what is in the LDAP database (the Portal Server is case sensitive). A new user can also be assigned (if using the VBrick database option) that does not exist in the LDAP database.
Password	For LDAP authentication a password is not needed (the user will use their normal network login password). If using the VBrick database a password must be entered (passwords are case sensitive). Passwords cannot exceed 31 characters.
IPR Pin	Optional. A PIN number can be assigned to a user that allows them to access their content from any IPR, regardless of the IPR's privilege level. This works well when an IPR is going to be a shared resource. Note: IPR PIN access is dependent on VBrick Database being enabled.
First Name	Optional. User first name.
Last Name	Optional. User last name.
E-mail address	Optional. User e-mail address.
Location	Optional. User location.

### **Assigning Privileges to Users**

There are three ways to assign privileges to users:

- Assign the User to a User Group that has privileges assigned to it.
- Assign the User to a Resource Group that has privileges assigned to it.

- 
- Individually assign resources to the User.

These methods all can be combined. For example, to provide a User with access to the resources provided to a User Group but also provide them access to additional resources, the administrator can a) Assign the User to that Resource Group and b) Individually assign the additional resources to that user. Each of these methods is discussed below.

### *Add/Modify User's Group Assignments*

Users can be assigned to specific User Groups, and they will inherit the privileges of that group. If no User Groups appear, then none have been defined. Click User Groups in the main navigation to the left to create User Groups.

### *Add/Modify User's Resource Group Assignments*

Users can be assigned to specific Resource Groups, and they will inherit the privileges of that Resource Group. If no Resource Groups appear, then none of been defined. Click Resource Groups in the main navigation to the left to create Resource Groups.

### *Add/Modify Live Channel Privileges*

A "live channel" is a live stream that has been modified into a Custom station or a TV station and assigned a channel number. A list of available live channels will be displayed. A user can be provided access to all live channels or to individual live channels.

For live channels, both the Channel Number and the Station Name will appear in the Channel Guide. If the Channel number is selected, the ETV Portal Server will always provide access to the particular channel (for example, Channel 1) even if the Program Name of that channel changes. If the Station Name is selected, the ETV Portal Server will always provide access to the station (for example, CNN), even if the channel that it is associated with changes (for example, from Channel 2 to Channel 4).

---

**Note** The live streams shown in the Portal Server may also be restricted by a bit mask on a VBrick encoder. The Portal Server will parse the bitmask and send the live stream only to ETV clients with a IP address that matches the masked IP of the source VBrick. You can use this feature in addition to the Portal Server authorization features. See the Category parameter in the MPEG, WM, or H.264 documentation for more information.

---

### *Add/Modify Live Program Privileges*

"Live programs" are all live streams that are available. These are unmodified, unassociated streams. Use this option to restrict access to specific live streams.

### *Allow Access to Specific FTP Servers*

Allow or deny access to defined FTP servers.

### *Allow Access to Specific Recorder Servers*

Allow or deny access to defined recorder servers.

## *Allow Access to Specific VOD Servers*

Choose from a list of available VOD server(s) to which a user has access. A user can have access to multiple servers. This feature is particularly useful when VOD servers are located in different physical locations that are separated by low bandwidth links. For example, if a company has offices and VOD servers in both New York and Chicago, and these offices are separated by a T-1 link, then they would want to limit the users in the Chicago office to the Chicago VOD server and those in New York to the New York VOD server.

---

**Note** When a user is provided access to particular VOD server(s), and they are given the privilege to Publish or Record to a particular folder, when they Publish or Record, the video will be Published or Recorded to each server that they have access to. This is important for clustering purposes.

---

## *Allow Access to Specific VOD Content*

Choose from a list of folders to which a user can have access. A user can have access to multiple folders on multiple servers. If the user has access to multiple VOD servers, and the folder names are the same on both servers, only one folder name will show up in the list.

## *Allow Viewing by Content Type*

The Administrator can limit the types of content that a user can view and/or limit the bandwidth that specific users can view. Note that this setting does not apply to URLs that were manually added by an administrator (see [URLs](#) on page 62).

Do Not Allow Multicast viewing	This will limit users that are on a non-multicast capable part of the network from trying to view multicast video.
Restrict Multicast to Kbps	This will limit users to only viewing multicast streams that are a certain size or smaller. This works well to maintain bandwidth utilization over a particular WAN port.
Do Not Allow RTSP viewing	This will limit users from viewing RTSP Unicast Streams from MPEG-4 Encoders and from accessing RTSP unicast streams from a Video-on-Demand server (MPEG-1, MPEG-2, or MPEG-4). This works well to maintain bandwidth utilization over a particular LAN or WAN port.
Restrict RSTP viewing to Kbps	This will limit users to only viewing RTSP streams that are a certain size or smaller. This works well to maintain bandwidth utilization over a particular LAN or WAN port.

## *Allow Content Publishing*

Administrators can allow a user the ability to publish content to folder(s) on an VOD Video-On-Demand Server. This function allows the user access to the **Add Video** page, where users can add pre-recorded video content to a VOD. It also allows users to (1) create (and upload) **Thumbnails** for video files in the folders to which they can publish, to (2) delete video content from the VOD server, and (3) to add keyword and description data using the **Modify Info** button. To prevent users from deleting content, be sure this option is disabled.

---

**Note** If users are provided access to more than one VOD server, when they publish content, it will be published to each of the servers to which they have access. This is important for clustering purposes.

---

### *Allow Content Recording*

*Used for scheduled recording.* Administrators can allow a user the ability to schedule the recording of live content to a specific folder(s) on a VOD Video-On-Demand Server. They cannot record content to any other folder(s). You must select a folder here to enable **Default Content Recording** below. If there is no schedule license, **Allow Content Recording** is not shown as an option and **Default Content Recording** lets you select any folder. If you add a schedule license later (using **Start > Control Panel > Add or Remove Programs**), **Allow Content Recording** will be shown as an option with all folders selected. You may want to deselect specific folders in order to restrict recording privileges.

### *Default Content Recording*

*Used for on-demand recording.* You must select a folder above for **Allow Content Recording** before you can make a folder selection here. Administrators can allow a user the ability to record live content to a specific default folder on a VOD Server by pressing the **Record** push button below the Preview Window. For ease of use, the Administrator can only assign one default folder where a particular user can record content. This allows one button recording on the ETV Portal Server and is particularly important for IP Receiver users, who may not be able to enter a recording path with their IR remote control.

### *Allow VBrick Access*

Administrators can allow a user the ability to access all VBricks or only specific VBricks when scheduling events. When scheduling an event, users will see only those VBricks for which they have been granted access.

### *IPR Access*

Administrators can allow a user the ability to access all IPR or only specific IPR when scheduling events. When scheduling an event, users will see only those IPR for which they have been granted access.

### *Schedule Privileges*

Users may have full, partial, or no permission to schedule VBrick event. Users with full privileges can modify all configuration parameters in a schedule. Users with partial privileges *cannot* modify **Advanced Settings**.

- Super – can change all schedules.
- Full – can change only "owned" schedules.
- Partial – can change only "owned" schedules; no **Advanced** features.
- None – cannot create schedules; no **Add** button shown on Scheduling page.

### *Priority Alert Privileges*

Administrators can specify whether or not a user can launch Priority Alerts.

## Copyright Restrictions & Expiration Privileges

Administrators can allow users to set Copyright Restrictions and Expiration Privileges when adding stored content or scheduling a recording. Note that copyright restrictions apply only to Portal Server-initiated playback sessions (and not, for example to direct RTSP requests to a VOD server).

## Content Edit Permissions

In some specialized end-user environments, this option can be used to allow or deny access to certain administrative and content management features.

## Configuring User Groups

Grouping users is common practice and makes administering access to the ETV Portal Server less complicated than administering access by individual user. The ETV Portal Server server allows the administrator to create User Groups, specify group memberships for users, and set access privileges for the group. A user can be a member of one group or multiple groups. Group access privileges also can be set and modified on a per group basis.

If an LDAP directory is being used for Authentication, the same group information that is available in the directory can be used to Authorize end users to access the ETV Portal Server. For example, if the organization has three User Groups in its LDAP directory—Marketing, Engineering, and Sales—they can simply create these groups in the ETV Portal Server system, and assign privileges to the groups.



## Add/Modify Group Information

If LDAP is being used for authentication, then the group name has to exactly match the group name in the LDAP directory. If LDAP is not being used, Group Names can be entered directly into the ETV Portal Server database. If Microsoft's Active Directory is used, to find the available list of active groups in **Windows XP**, browse to **My Network Places** and click on the left-hand menu **Search Active Directory**. A new window will open. Click **Find now** to see

---

all available groups. In **Windows 2000**, go to **My Network Places > Entire Network > Directory**, the domain, and **Users**.

---

**Note** Windows XP needs to be configured to **Show Common Tasks in Folders**. To configure this, in **My Network Places**, go to **Tools > Folder Options**. In the **General > Tasks** section, select the radio button called **Show common tasks in folders**.

---

### *Add/Modify Group's User Assignments*

Users can be assigned to specific User Groups, and they will inherit the privileges of that group. If no Users appear, then none have been defined. However, if LDAP is being used for Authentication, no users need to be defined. When a user Authenticates to the system, the Authentication process will return the User's group information. The user will receive the privileges that are provided to that group.

### *Add/Modify Group's Resource Assignments*

Resource groups can be assigned to User Groups, and the User Group will inherit the privileges of that Resource Group. If no Resource Groups appear, then none of been defined. Click **Resource Groups** in the main navigation to the left to create Resource Groups.

---

**Note** The remaining options for **User Groups** (beginning with **Add/Modify Live Channel Privileges**) are the same as those described earlier for individual [Configuring Users](#) on page 107. The only difference is that the descriptions will apply to groups of users rather than to individual users.

---

## **Resource Groups**

In the ETV Portal Server software, providing a user with Resources refers to providing them access to a particular functionality of the EtherneTV system. These include the ability to view Live Channels, to view VOD content, to publish content to the VOD, and to record content. A unique feature of the ETV Portal Server software is the ability to group Resources into Resource Groups. This allows the administrator to quickly and easily assign several resources at once to more than one User or User Groups. This also makes the ongoing management of this content for these Users or User Groups much easier.



For example, if the organization has three User Groups—Marketing, Engineering, and Sales—they might create four resource groups. These Resource Groups would be Full Access, which are resources that everyone can see, and one Resource Group for each of the user groups. Full Access would be assigned to each user group, and the Marketing Resource Group would be assigned to the Marketing User Group, the Engineering Resource Group to the Engineering User Group, and the Sales Resource Group to the Sales User Group. Resource Groups provide the added bonus that they allow the Administrator to quickly provide access to new content to Users and User Groups. For example, if the organization originally had ten Live Channels on the network, and another Live Channel was added, the Administrator would simply need to add that Channel to the appropriate Resource Groups and the channel would be available.

### *Add/Modify Resource Group Information*

Add the Resource Group Name that is relevant for the Resource Group being created.

### *Add/Modify User's Resource Assignments*

Users can be assigned to specific Resource Groups, and they will inherit the privileges of that Resource Group. If no Users appear, then none have been defined. Click on the Users section to add Users.

### *Add/Modify Group's Resource Assignments*

User Groups can be assigned to Resource Groups, and the User Group will inherit the privileges of that Resource Group. If no User Groups appear, then none have been defined. Click User Groups in the main navigation to the left to create User Groups.

---

**Note** The remaining options for **Resource Groups** (beginning with **Add/Modify Live Channel Privileges**) are the same as those described earlier for individual [Configuring Users](#) on page 107. The only difference is that the descriptions will apply to resource groups rather than to individual users.

---

---

## IPR Authentication

There are two ways (IPR IP address or user PIN) to authenticate and authorize IP Receivers in the ETV Portal Server. IPR access control is slightly different from PC and Macintosh-based authentication (which uses the commonly employed User Name and Password mechanism). The two methods are outlined in the table below.

**Table 13.** Authentication Methods

Method	Description	User Interaction	Comment
User PIN	If Access Control is enabled, but the IPR is not defined in the system, then Access Control works based on a user PIN. This PIN is defined on a <i>per user</i> (not per IPR) basis, so that users need to be defined for this to work.	When the user logs into the system, they will be prompted for their PIN. The user simply enters the PIN with the remote control or the wireless keyboard, and can then access the video.	This implementation is appropriate for environments where multiple users with different privileges will be accessing the same IPR. An example of this would be a shared classroom where multiple teachers are accessing the IPR at different times.
IPR IP Address or Host Name	The ETV Portal Server system determines the content that the IPR can view based on its IP Address or Host Name.	No user interaction is required. The user simply turns on the IPR and only the content that the IPR user can view is displayed.	This implementation is similar to a cable TV setup, e.g. if the cable plan does not include CNN, that channel cannot be viewed. This implementation is easiest for end users because you do not have to remember user names or PINs. It is appropriate for environments where one or a few people with the same privileges access the same IPR.

### *Authentication by PIN*

When an end user accesses the ETV Portal Server via a IPR, the Portal Server takes the following steps to authorize users.

1. It determines if there is Authentication/Authorization information associated with the Host Name of the IPR. If so, based on the IPR Host Name, the ETV Portal Server will present the IPR with the information appropriate to its privileges. Note that the ETV Portal Server uses the least restrictive settings when providing access to the system.
2. If there is no Authentication/Authorization information associated with the Host Name of the IPR, the user will be prompted for a PIN. A PIN is a user-based mechanism to log onto the IPR. When the user enters his or her PIN, the ETV Portal Server authenticates the user against the Portal Server database.
3. Once the user is authenticated, the ETV Portal Server will check the User Groups and/or Resource Groups that the User is associated with and the privileges associated with those groups.
4. After checking the Groups privileges, the ETV Portal Server will check for any individual user privileges above the group privileges.
5. The user will be presented with the information appropriate to their privileges. Note that the ETV Portal Server uses the least restrictive settings when providing access to the system.



If Authentication and Authorization is enabled, but the IPR is not defined in the system, then Access Management works based on a User PIN. This PIN is defined on a **per user** (not per IPR) basis, so Users need to be setup in the system for this to work. When the user accesses the ETV Portal Server through the IPR, they will be prompted for their PIN. The user simply enters the PIN with the remote control or the wireless keyboard, and can then access the video for which they have privilege. This implementation is appropriate for environments where multiple users with different privileges will be accessing the same IPR. An example of this would be a shared classroom, where multiple teachers are accessing the IPR at different times.

### *Authentication by Host Name or IP Address*

The ETV Portal Server determines the content that the IPR can view based on its IP Address or Host Name. No user interaction is required. The user simply turns on the IPR, and only the content that the IPR user can view displays. This implementation is similar to a Cable Television setup—for example, if the plan does not include HBO, then that channel cannot be viewed. This implementation is easiest from the end user perspective because end users do not have to remember user names or PINs. This implementation is appropriate for environments where multiple people can access the same IPR.



## Configuring for SSL

### *Topics in this section*

Overview .....	119
1. Generate a Certificate Request .....	120
2. Submit a Certificate Request .....	121
3. Install the Certificate .....	121
4. Configure ETV Resources for SSL .....	121

### Overview

Secure Sockets Layer (SSL) provides endpoint authentication and communications privacy over the Internet using cryptography. Whenever there is a concern regarding confidentiality and integrity of *management* data being sent between ETV Portal Server and external clients, the ETV Portal Server should be configured with a digital X.509 certificate to enable SSL encryption. When SSL encryption is enabled, the Portal Server encrypts either all pages in the Portal Server Admin and client applications (see [Configuring Hardened SSL](#)) or all of the Portal Server Admin pages but only the Portal Server client *login page* (see [Configuring Non-Hardened SSL](#)).

It is important to note that only the management data (for example user requests or configuration data) is encrypted. *The actual video streams are never encrypted.* When SSL is enabled, the following elements can be encrypted:

- MCS Admin Console – All MCS Admin Console pages can be encrypted to protect management information and other sensitive data.
- MCS User Portal – All Portal Server client pages can be encrypted (hardened SSL) or only the login page can be encrypted (non-hardened SSL).
- LDAP Server – If using LDAP authentication, communications between the Portal Server and the LDAP Server can be encrypted by enabling encryption on the LDAP server.
- VOD-W Server – Communication between the Portal Server and a VOD-W server can be encrypted by enabling SSL on the VOD-W server. See "Secure Communication" in the *VOD-W Server Release Notes*.

By convention, URLs that require an SSL connection start with [https](#) instead of [http](#). The steps briefly listed here, and explained in detail on the following pages, explain how to set up and use SSL on the Portal Server.

- ▼ To set up SSL for client access to the ETV Portal Server
  1. Generate a Certificate Request.
  2. Submit a Certificate Request.
  3. Install the Certificate on the ETV Portal Server.
  4. Configure ETV Resources for SSL.

---

## SSL Prerequisites

- In order to use the Portal Server in secure (HTTPS) mode, you must have a signed and valid SSL certificate purchased from Verisign or another vendor. If the certificate is not signed, or if it is expired or otherwise invalid, video playback issues will occur.
- In an environment where the Portal Server is using SSL and a Network Video Recorder (NVR) is running on a separate server, the NVR server must also have an SSL Certificate installed in its IIS configuration or all NVR recording will fail.
- Be aware that hardened SSL encryption requires significant resources and can substantially impact performance. Use hardened SSL only when absolutely necessary in environments that require all pages to be encrypted.
- To use SSL, Amino set top box users must purchase a digital X.509 certificate from Verisign. Other certificates may work but Verisign is the only certificate currently tested and supported by VBrick.

## 1. Generate a Certificate Request

If your company does not have a X.509 certificate, or does not have one for the ETV Portal Server, a new certificate request must first be created.

- ▼ To generate a certificate request:
1. From the ETV Portal Server, start the Microsoft Internet Information Services (IIS) Manager.
  2. Expand the server name and select the web site for which the certificate will be installed.
  3. Right-click the web site, and then click **Properties**.
  4. Select the **Directory Security** tab.
  5. Select the **Server Certificate** button within **Secure** communications to launch the Web Server Certificate Wizard.
  6. Select **Next** on the Welcome dialog box.
  7. Select **Create a New Certificate** and then select **Next**. (If **Create a New Certificate** is unavailable, the certificate has probably been installed already. If that is the case, skip the rest of the steps, and go to Step 4. [Configure ETV Resources for SSL](#). If you want to create new certificate for ETV Portal Server, select **Remove the current certificate** to remove the certificate first, and then restart the procedure.)
  8. Select **Prepare the request now, but send it later** and then select **Next**.
  9. Type a descriptive name for the certificate in the **Name** field, type a bit length for the key in the **Bit length** field, and then select **Next**.
  10. Type an organization name (e.g. VBrick) in the **Organization** field and type an organizational unit (such as Sales Department) in the **Organizational unit** field, and select **Next**. (This information will be placed in the certificate request, so make sure it is accurate. The Certificate Authority will verify this information and will place it in the certificate. A user browsing the ETV Portal Server will want to see this information in order to decide if they should accept the certificate.)
  11. In the **Common name** field, type a common name, and then select **Next**. (**Important:** The common name is one of the most significant pieces of information that ends up in the certificate.)
  12. Enter the appropriate information in the **Country/Region**, **State/Province**, and **City/locality** fields, and then select **Next**.

13. Enter a file name for the certificate request. The file contains information similar to the following:

```
-----BEGIN NEW CERTIFICATE REQUEST -----
MIIDZjCCAs.....
-----END NEW CERTIFICATE REQUEST -----
```

This is a Base 64 encoded representation of the certificate request. The request contains the information entered into the wizard and also your public key and information signed with your private key.

14. Select **Next**. The wizard displays a summary of the information contained in the certificate request.
15. Select **Next** and select **Finish** to complete the request process.

## 2. Submit a Certificate Request

If a CA-signed Certificate from a trusted Certificate Authority (such as [VeriSign](#) or [Thawte](#)) is going to be purchased, the certificate can now be sent to a CA for verification and processing. After the certificate response is received from the CA, the installation process can continue on the ETV Portal Server. Purchasing a CA-signed certificate will cause a security alert in the browser upon access to the server.

## 3. Install the Certificate

- ▼ To install the certificate on the ETV Portal Server
  1. Start the Microsoft Internet Information Service (IIS) Manager.
  2. Expand the server name and select the web site for which the certificate will be installed.
  3. Right-click the web site and then select **Properties**.
  4. Select the **Directory Security** tab
  5. Select **Server Certificate** to launch the Web Server Certificate Wizard
  6. Select **Process the pending request and install the certificate** and then click **Next**.
  7. Enter the path and file name of the file that contains the response from the CA, and then click **Next**.
  8. Examine the certificate overview, click **Next**, and then click **Finish**. A certificate is now installed on the ETV Portal Server.

## 4. Configure ETV Resources for SSL

After installing the certificate on the ETV Portal Server, the ETV Portal Server can now be configured for SSL. As explained below, the Portal Server supports two different modes for SSL security:

- **Hardened SSL** – All pages in the Portal Server Admin and Portal Server client applications are secured with SSL. Users will see the padlock icon at the bottom of the screen on all pages.
- **Non-Hardened SSL** – All pages in the Portal Server Admin application; only the Portal Server client login page is secured.

---

**Note** You must select one and only one of these modes for configuring the Portal Server. The application cannot run with both modes enabled and attempting to do so will result in an application error.

---

---

## Configuring Hardened SSL

In hardened SSL mode, the Portal Server encrypts all pages in the Portal Server Admin application and all pages in the Portal Server client application.

---

**Note** Be aware that hardened SSL encryption requires significant resources and can substantially impact performance. Use hardened SSL only when absolutely necessary in environments that require all pages to be encrypted.

---

- ▼ To configure the Portal Server in Hardened SSL Mode
  1. Login to the Windows Server that is hosting the ETV Portal Server application with a valid local Windows administrator account or domain account with local administrative permissions.
  2. Launch the Internet Information Services Manager. Go to Start > Control Panel > Administrative Tools > Internet Information Services (IIS) Manager.
  3. Locate your server name in the tree control on the left and click the plus sign (+) to expand the node.
  4. Locate the node titled **Web Sites** and click the plus sign (+) next to it to expand the node. Your screen should look similar to this:

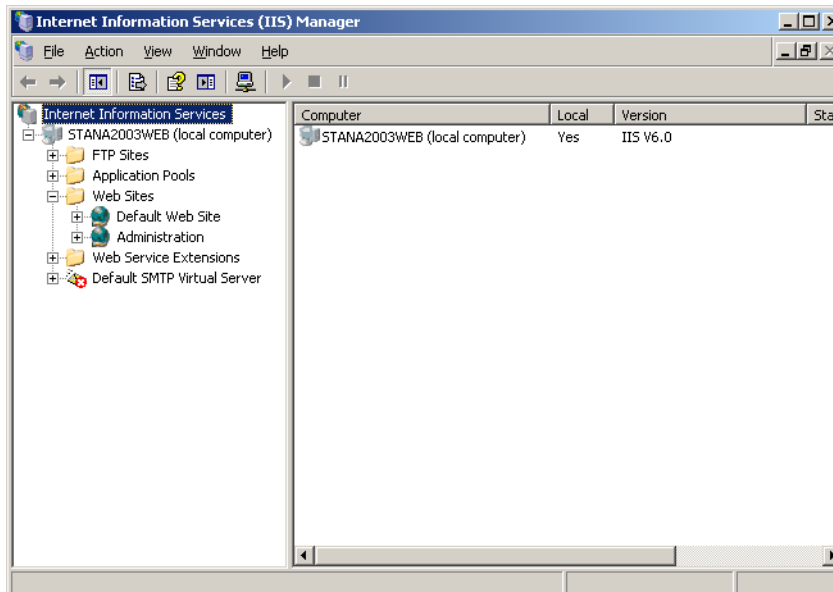

5. Right-click the **Default Web Site** node and click **Properties**.
6. Select the **Directory Security** tab. Your screen should look similar to this:

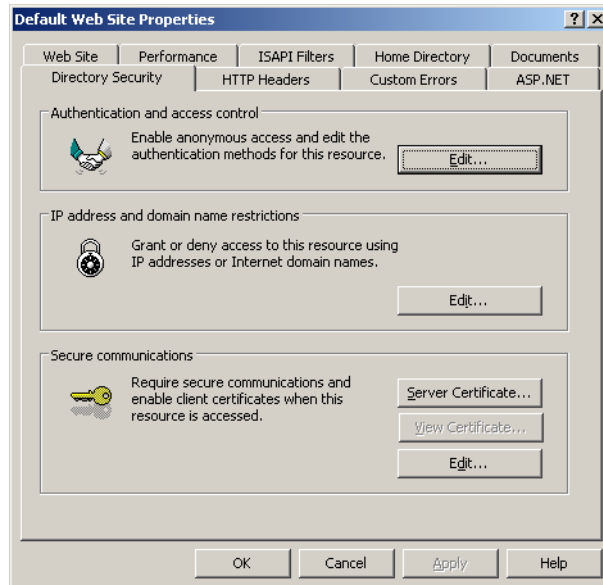

7. Go to **Secure communications** and click **Edit**.
8. Check the box marked **Require secure channel (SSL)** and click **OK**.

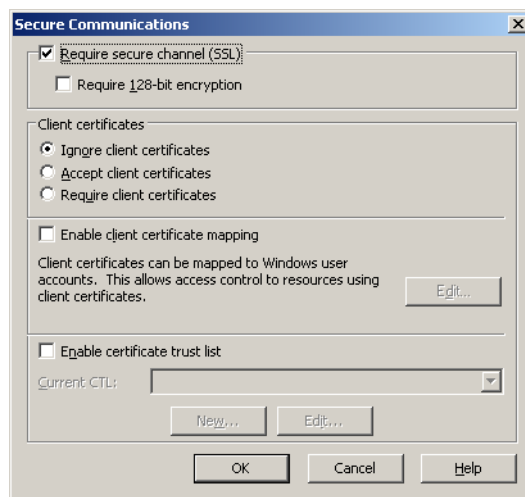

9. Click **OK** to close the **Default Web Site Properties** page.
10. Click the plus sign (+) in the tree next to **Default Web Site** to expand the node. Your screen should look similar to this:

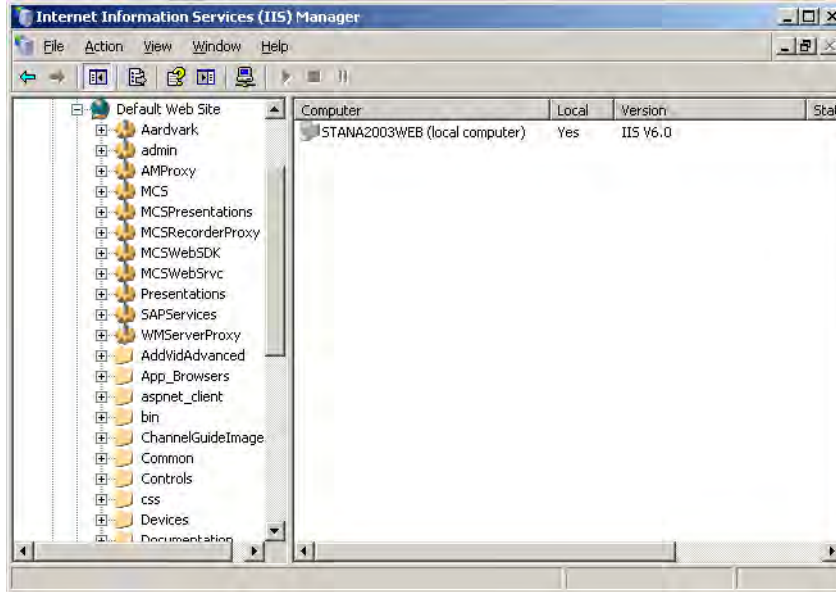

11. Right-click on **AMProxy** and select **Properties**.
12. Select the **Directory Security** tab, then go to **Secure communications** and click **Edit**.
13. Uncheck the box marked **Require secure channel (SSL)** and click **OK**.

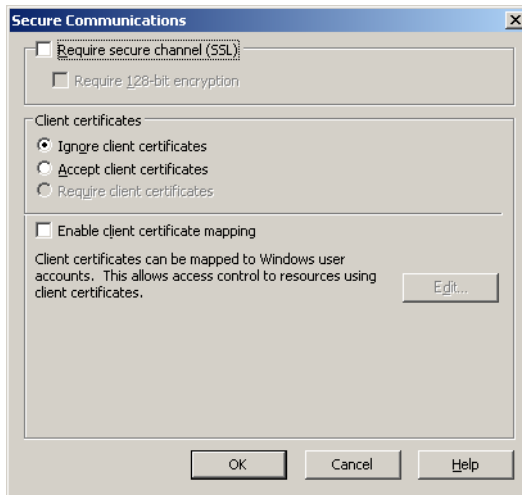

14. **Restart the Windows Server.**

After restarting the server, your users will be able to access the ETV Portal Server application. From this point forward, users must use an **HTTPS** URL to access the application, for example: **https://<server\_ip\_address>**. Be sure to update all bookmarks and stored links to reflect this address change.

## Configuring Non-Hardened SSL

In non-hardened SSL mode, the Portal Server encrypts all of the Portal Server Admin pages but only the Portal Server client *login page*. Configuring non-hardened SSL is a two-step process: (1) first you configure the Portal Server user login page for SSL access, and (2) configure the Portal Server Admin pages for secure SSL access. This means that when a user attempts to access the Portal Server user pages it will automatically bring them to **https://**



<ipaddressofserver> for the user pages. Users will notice a padlock icon at the bottom of their screen while logging into the Portal Server, however the padlock will disappear once they login. When an administrator attempts to access the Administration pages it will also force them to use <https://<ipaddressofserver>/admin>. The padlock icon will be visible at the throughout the entire Admin site.

## Securing the Portal Server User Pages

- ▼ To configure the ETV Portal Server User Pages for SSL access
  1. Go the Portal Server install location, typically `C:\Program Files\VBrick\MCS` and open `web.config` in a text editor.
  2. Uncomment the sections labeled Web Page Security 1, 2, and 3 by deleting only the `<!--` and `-->` characters shown below in red.

### Web Page Security 1

```
<!-- Web Page Security 1: Remove comments around the following section to enable
SSL on the login page. -->
<!--
<section name="secureWebPages"
type="Hyper.Web.Security.SecureWebPageSectionHandler, WebPageSecurity"
allowLocation="false" />
-->
```

### Web Page Security 2

```
<!-- Web Page Security 2: Remove comments around the following section to enable
SSL on the login page. -->
<!--
<secureWebPages mode="On" maintainPath="False" warningBypassMode="AlwaysBypass"
bypassQueryParamName="BypassSecurityWarning">
<file path="login.aspx" /> <file path="login4.aspx" /> </secureWebPages>
-->
```

### Web Page Security 3

```
<!-- Web Page Security 3: Remove comments around the following section to enable
SSL on the login page. -->
<!--
<add name="SecureWebPage" type="Hyper.Web.Security.SecureWebPageModule,
WebPageSecurity" />
-->
```

## Securing the Portal Server Admin Pages

- ▼ To configure the ETV Portal Server Admin pages for SSL access
  1. Go the Admin Console location, typically `C:\Program Files\VBrick\MCS\Common\MCS Admin Console` and open `web.config` in a text editor.
  2. Uncomment the sections labeled Web Page Security 1 and Web Page Security 2 by deleting only the `<!--` and `-->` characters shown below in red.

### Web Security 1

```
<!-- Web Page Security 1: Remove comments around the following section to enable
SSL on all Admin Console pages. -->
<!--
<section name="secureWebPages"
type="Hyper.Web.Security.SecureWebPageSectionHandler, WebPageSecurity"
allowLocation="false" />
-->
```

---

## *Web Security 2*

```
<!-- Web Page Security 2: Remove comments around the following section to enable  
SSL on all Admin Console pages. -->
```

```
<!--
```

```
<secureWebPages mode="On" maintainPath="False" warningBypassMode="AlwaysBypass"  
bypassQueryParamName="BypassSecurityWarning">
```

```
<directory path="/" recurse="True" />
```

```
</secureWebPages>
```

```
-->
```

## Network Video Recording

### *Topics in this section*

NVR Overview .....	127
NVR Types.....	129
NVR Installation .....	130
NVR Configuration .....	130
Using an NVR .....	131

### **NVR Overview**

The Network Video Recorder (NVR) provides a dedicated platform to perform multiple simultaneous recordings of live streams coming from VBrick encoders. The NVR lets you off-load all recording tasks from the ETV Portal Server machine to one or more separate "recorder server" machines. The NVR provides the ability to record live streams from the network, store these recorded video files on a specified location (a record server or other network location), and optionally automatically transfer the contents to selected locations, and/or ingest them to VOD servers.

The NVR is available in two versions—one that supports 10 simultaneous records and one that supports 40—and is ideal for environments that require large scale recording on a robust and reliable platform. The NVR is tightly integrated with the Portal Server, the Scheduler, and VBrick's Video-on-Demand servers. The NVR provides these standard features.

- Dedicated platform – NVR servers are available on a dedicated hardware platform which eliminates resource contention and guarantees successful recording.
- Software only – NVR servers are available as a software-only option which you can install on your own server hardware. See the *NVR Release Notes* for server hardware recommendations.
- Redundant storage – both NVR servers offer RAID 5 for storage redundancy as well as dual power supplies.
- Large storage capacity – the NVR 10 provides 720 GB of storage; the NVR 40 provides 1492 GB.
- Load Balancing – Load balancing is used when multiple NVR servers are installed. Rather than recording to a specified server, the system records to a dynamically selected server based on a load balancing algorithm.
- Software Development Kit – VBrick provides an SDK to interface with the Portal Server or the NVR. In a typical security, surveillance, and monitoring applications application (without a complete Portal Server), you can write a custom application that will record streams directly to a standalone NVR.

In a basic Portal Server installation (without an NVR), the standard recording functionality allows a maximum of two concurrent recordings. In order to expand this recording capability, you can purchase a Network Video Recorder to offload recording tasks and improve overall

performance. The Portal Server and/or the NVRs are delivered with all software installed or as a software-only option. The NVR comes in standard and standalone versions as explained below. The only difference is in functionality. *Both record either 10 or 40 concurrent streams depending on the license you purchase.* Both versions can be expanded to include multiple, additional NVRs so that your recording capacity is virtually unlimited.

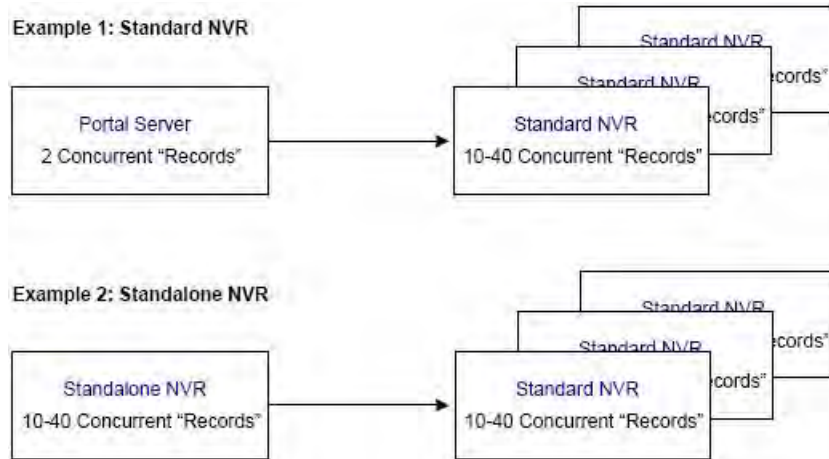

**Figure 17.** Standard and Standalone NVR Examples

## NVR Hardware

The NVR is comprised of both hardware and software. If you purchased the hardware/software combination from VBrick, each platform (standard or standalone) comes fully loaded with NVR software. The following table shows the hardware configuration relative to the number of purchased licenses. The license file determines the total maximum concurrent recordings allowed. *In a standard NVR installation the NVR license file is stored on the Portal Server; in a standalone NVR installation the NVR license file is stored on the Standalone NVR.*

**Table 14.** NVR Hardware Specifications

	NVR – 10 Record Licenses	NVR – 40 Record Licenses
Platform	Dell PowerEdge 2950	Dell PowerEdge 2950
Simultaneous records	10	40
Storage capacity	(2) 73 GB OS drives (4) 146 GB content drives	(2) 146 GB OS drives (4) 300 GB content drives
RAID Type	2 drive RAID1 for OS drives 4 drive RAID5 for content drives	2 drive RAID1 for OS drives 4 drive RAID5 for content drives
CPU	(1) 3 GHz dual core	(2) 3 GHz dual core
RAM	1 GB DDR RAM	2 GB DDR RAM
Chassis	2U	2U
Power supply	Redundant	Redundant
Operating System	Windows Server 2003 Web Edition or Standard Edition	Windows Server 2003 Web Edition or Standard Edition

## *NVR Performance Considerations*

The NVR 40 lets you record any combination of up to 40 MPEG, WM, and H.264 streams at a time. There are however performance considerations when recording multiple, simultaneous, high-rate MPEG-2, WM, or H.264 streams. At MPEG-2 rates up to 5.5Mbps or WM rates up to 1.2Mbps 40 simultaneous recordings are supported. At higher rates however the full licensing capacity cannot be used. For example, when using the **Best Quality** WM template at 4.5Mbps, 10 simultaneous records are supported; when using MPEG-2 at 15Mbps, 15 simultaneous recordings are supported.

## NVR Types

### *Standard NVR*

A Standard NVR's record capability is managed by a Portal Server or Standalone NVR. In a standard NVR installation, the full Portal Server or Standalone NVR application is installed on one machine and the NVR application is installed on a separate machine. If you need to add recording capacity, you can add multiple NVRs as necessary. You use the Portal Server or a Standalone NVR application to configure the Standard NVR (see [Configuring a Standard NVR](#)). A *standard* NVR has these characteristics:

- supports record only.
- records 10 or 40 concurrent streams depending on license.
- is configured with the standard Portal Server Admin Console *or* the Standalone NVR Console.
- records from the **Record** button *or* the **Scheduler** module.
- Supports "batch" recording where one large file is recorded into multiple smaller files.

---

**Note** When purchasing additional NVRs, VBrick provides a single combined license that includes recording capacity for all NVRs onsite.

---

### *Standalone NVR*

A Standalone NVR manages the record capability of itself and any attached Standard NVRs. *A standalone NVR is typically used in security, surveillance, and monitoring applications or anywhere where full Portal Server functionality is not required.* In a standalone NVR installation, a subset of the Portal Server application is installed on one machine and the NVR application is installed on the same machine *or on a different machine.* If you need to add recording capacity, you can add multiple Standard NVRs necessary. You use the subset of the Portal Server application to configure the NVR (see [Configuring a Standalone NVR](#)). A *standalone* NVR has these characteristics:

- supports record only.
- records 10 or 40 concurrent streams depending on license.
- is configured with a subset of the Portal Server Admin Console that has limited features—no VBricks, IPRs, etc.
- records from the **Scheduler** module only.
- has limited end user features. End users can see only the **Scheduler**, the **Status** page, and the **Help** system.
- supports "batch" recording where one large file is recorded into multiple smaller files.

- 
- has an API interface that lets you write custom applications to control the NVR.

---

**Note** When purchasing additional NVRs, VBrick provides a single combined license that includes recording capacity for all NVRs onsite (Standard and/or Standalone).

---

## NVR Installation

See the [NVR Release Notes](#) for complete installation instructions.

### *Synchronizing the Portal Server and the NVR*

The internal clocks on the Portal Server and the NVR must be synchronized for recording functionality to work properly. You can use the `Net time` command as explained below or you can use an external time server. In order to run the `Net time` command on *either* server, the server must be on the domain, and the user logged onto the server must have admin privileges *and* be part of the domain.

- ▼ To synchronize the Portal Server and the NVR
  1. Open a command prompt window on the Windows 2003 Server *Portal Server* machine.
  2. Type: `Net time \\{NVR IP Address} /SET`

## NVR Configuration

### *Configuring a Standard NVR*

A standard NVR is installed on a dedicated machine that comes fully loaded with all NVR software. However, you must still configure the NVR as explained below. NVR configuration is performed using the *Recorders* pages on the Portal Server's or Standalone NVR's Admin Console. See *Recorders* on page 43 for more information.

- ▼ To configure a standard NVR in a *Portal Server Installation*
  1. Login to the Portal Server Admin Console using *the host name or IP address of the Portal Server machine*. For example: <http://myserveraddress/admin>
  2. Define a Record server.
    - a. Set record **Path** if necessary. Set to local hard drive on NVR or to a network drive.
    - b. Set **Max. Recording**.
  3. Define VOD and FTP Servers (go to **Global Settings > Servers**).
    - a. Record only – VOD server not required.
    - b. Record and ingest – must define a VOD server.
    - c. Record, ingest, and FTP – must define VOD and FTP servers.
    - d. Record and FTP – must define an FTP server.
  4. If Access Control is enabled, you must create a user and grant the following permissions on the **Users** page in the Admin Console. See [Configuring Users](#) on page 107 for more information.
    - a. **Add/Modify Live Channel Privileges**
    - b. **Allow Access To Specific FTP Servers**
    - c. **Allow Access To Specific Recorder Servers**
    - d. **Allow Access To Specific VOD Servers**
    - e. **Allow Content Recording**

f. **Schedule Privileges**

## Configuring a Standalone NVR

- ▼ To configure a standard NVR in a *Standalone NVR Installation*
  1. Login to the Standalone NVR Admin Console *using the host name or IP address of the Standalone NVR machine*. For example: <http://myserveraddress/admin>
  2. Define a Record server.
    - a. Set record **Path** if necessary. Set to local hard drive on NVR or to a network drive.
    - b. Set **Max. Recording**.
  3. Define VOD and FTP Servers (go to **Global Settings > Servers**).
    - a. Record only – VOD server not required.
    - b. Record and ingest – must define a VOD server.
    - c. Record, ingest, and FTP – must define VOD and FTP servers.
    - d. Record and FTP – must define an FTP server.
  4. If Access Control is enabled, you must create a user and grant the following permissions on the **Users** page in the Admin Console. See [Users](#) on page 81 for more information.
    - a. **Allow Access To Specific FTP Servers**
    - b. **Allow Access To Specific Recorder Servers**
    - c. **Allow Access To Specific VOD Servers**
    - d. **Allow Content Recording**
    - e. **Schedule Privileges**

## Using an NVR

As noted, the Portal Server and the Network Video Recorder are installed on separate machines. Using the Admin Console, you configure the NVR by indicating where record files will be stored, and defining the maximum number of simultaneous recording the NVR will support (which is less than or equal to the licensed number of recordings). The record **Path** can be set to local hard drive on the NVR machine or to a network drive. In a Portal Server installation, from PCs or IPRs, end users can access NVR record features (record start/record stop) through using the Portal Server. When a recording is initiated using the **Record** button on the **Live Broadcasts** page of the Portal Server, the record file is be automatically ingested to available VOD servers, based on the stream type (e.g. MPEG2, MPEG4, etc.) and user's permissions. After ingestion, the record file can be automatically deleted from record server based on the Global Settings configuration.

When a record is initiated through Scheduler interface of Portal Server, end users can specify whether they want to FTP the recorded file to available FTP servers or to ingest the recorded file to available VOD servers. They can also specify whether or not to automatically delete the file after a successful FTP or ingestion. (These options are not available in "batch" mode. If you select **Enable Batch**, the files are not FTPed and ingested; they are saved to [D:\Inetpub\ftproot\MCS\Record](#) and all other options are disabled.)

In a *standard* NVR configuration, live streams can be recorded (1) by using the **Record** button on the embedded player or (2) by using the **Scheduler** module. In a *standalone* NVR installation, recording can *only* be initiated from the **Scheduler** module using the interface as shown below in Figure 18. For a complete description of the Scheduler, see "Using the Scheduler" in the *Portal Server User Guide*.

**Note** To use a standard NVR, the Portal Server and the NVR must be installed and running.  
To use a standalone NVR, only the NVR application must be running.

**VBrick Systems** VBrick ETHERNET TV SUITE

Live Broadcasts  Asset Library 10/1/2007 4:16 PM

### Schedule Record

Schedule Name:  Start:

End:

**► Recurrence**

Channel	Program Names	Type
2	1-CNN2	MPEG2
4	1-MSNBC	MPEG2
5	1-FOX_NEWS	MPEG2
6	1-MSNBC-2	MPEG2
9	VH1	MPEG2
10	SciFi	WMRTSP-VBStar
	CD-MPEG1-2	MPEG1
	A EMB test	MPEG2
	AndyM-WM-MP2 Program 1	WMRTSP-VBStar
	AndyM-WM-MP2 Program 1	WM-VBStar
	AndyM-WM-MP2 Program 2	MPEG2
	A EMB test	WM-VBStar

**► Advanced Settings**

**Record Source:**  Program Name  Manual Entry

**Record To:**  NVR  VBrick

[Live Broadcasts](#) | [Asset Library](#) | [Scheduling](#) | [Status](#) | [Emergency Broadcast](#) | [Add Video](#) | [Playlist](#) | [Help](#)

Figure 18. Portal Server "Schedule Record" Page



## VBPresenter

---

**Note** VBPresenter v2.x works with VBrick's WM or MPEG-4 appliances and uses the Windows Media Player interface. **VBPresenter v3.x supports VBrick WM video only.** It delivers an advanced interactive viewer interface using Microsoft's Silverlight technology. VBPresenter v3.x requires VBDNA v4.2 or above for direct streaming from a WM appliance to viewers. Earlier versions of firmware are acceptable when streaming via a service or from a Windows Media Server.

---

### *Topics in this section*

Overview .....	133
Configuring MCS for VBPresenter .....	134

## Overview

Rich media presentations include those with audio, video, graphics, animation and other multimedia features like synchronized PowerPoint slides. The Portal Server can display live and stored rich media presentations created by VBrick's VBPresenter PowerPoint Add-In. VBPresenter presentations run in Internet Explorer only. Live VBPresenter presentations like the one shown in Figure 19 are available for viewing from the **Live Broadcasts** page; stored presentation are available from the **Video Library** page (and have a special icon). Like other content, rich media presentations can only be seen by those viewers who have appropriate permissions. This document explains how to configure the Portal Server to work with VBPresenter. The *VBPresenter User Guide* explains in detail how to configure and use VBPresenter.

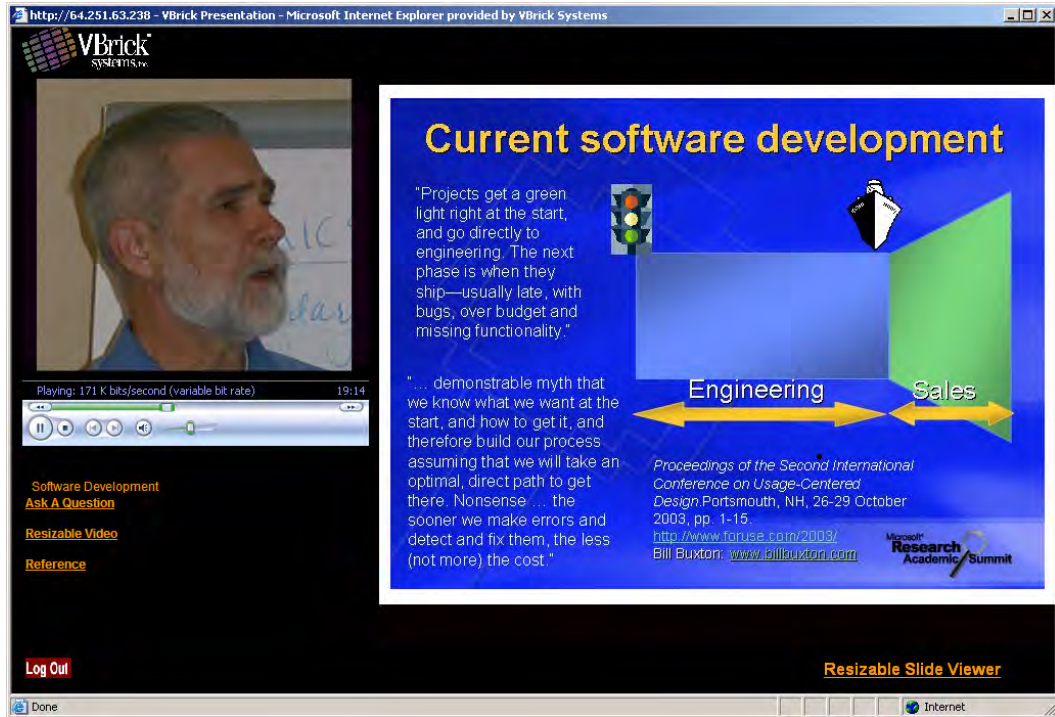

Figure 19. VBPresenter v2.x Rich Media Presentation

## Working with Presentations

If you will be working with VBPresenter presentations, be aware that they have the following unique characteristics and limitations.

- They launch in a new browser window in their native user interface—not in the Portal Server.
- They can only be uploaded from VBPresenter—they cannot be added directly or autoingested to the Portal Server.
- They do not work with the Portal Server Scheduler and cannot be scheduled to play in advance.
- They can be recorded for future use only in VBPresenter—they cannot be recorded using the Portal Server.

## Configuring MCS for VBPresenter

The following pages explain how to configure the MCS Portal Server to handle live and stored presentations. Once these steps are done, you use the native functionality in VBPresenter to make live or stored presentations available on the Portal Server. For more about configuring and using VBPresenter, see the *VBPresenter User Guide*.

### Configuring an MCS FTP User Account

The Portal Server's **FTP User Name** and **FTP User Password** must be set in the Admin console (**Global Settings > Global Assignments**) to the values that are configured in IIS. When a client logs on to the Portal Server's FTP account (for example from a Command Prompt window), this combination of FTP user name and password must place the user into the FTP root directory of the Portal Server. (This is *not* the same as the **Presentations** directory. The

**Presentations** directory is a virtual directory in IIS. This directory is the root folder for live presentations only.) There is an **MCS** directory at the FTP root directory. Note that the entries made in the Admin console are stored in the Portal Server and do not actually configure IIS. These values must reflect what IIS has been configured for.

---

**Note** The MCS setup program creates an additional user name and password with an FTP Home directory in the **Live Presentations** folder on the MCS server. This User Name (**Presentations**) and password (**Presentations**) are used in the **FTP/Web Server** section of the VBPresenter Setup window.

---

### *Configuring an MCS Presentation User*

Perform the following configuration *one time only* so that the presentation tool you are using can access the Portal Server. These steps will create a pseudo VBPresenter user who is associated with the authoring tool and has specific permissions on the Portal Server.

- ▼ To create a presentation user
  1. Open the Admin Console and go to **Users**.
  2. Add a user name (for example **PresentationUser**) and give this user the following permissions:
    - a. **Add/Modify Live Channel Privileges** – check the appropriate channels.
    - b. **Add/Modify Live Programs Privileges** – check the appropriate programs.
    - a. **Allow Access to Specific VOD Servers** – check the appropriate servers.
    - b. **Allow Access to Specific VOD Content** – check the appropriate folders.
    - c. **Allow Content Publishing** – check the appropriate folders.
  3. Go to **Global Settings > Global Assignments > Assign Presentations** and select the user you created above (for example **PresentationUser**) as the **New Presentation User**.

### *Configuring for Live Presentations*

You must perform the following steps to configure the Portal Server for *each* live presentation.

- ▼ To configure the Portal Server for a live presentation
  1. Go to **Global Settings > Program Names** and add a program name (for example **Live Presentation**). Then use this same name in the **MCS Program Name** field in VBPresenter. This is the title that will be displayed on the **Live Broadcasts** page during a live presentation.
  2. If necessary, give your end users access to this live presentation. Go to **Users > Add/Modify Live Channel Privileges** and select this **Program Name**.

---

**Hint** To pre-configure a presentation, create a **Program Name** in advance on the Portal Server and assign **Live Channel Privileges** to users. Then use the same name in the **MCS Program Name** field in VBPresenter when giving the presentation. The **MCS Program Name** will be available on the **Live Broadcasts** page for any users who have permissions to view that channel

---

## Launching a Live Presentation

The web server in VBPresenter can be configured with either a domain name or an IP address. If configured with an IP address, you must launch the MCS client using the IP address in order to view presentations successfully; if configured with a domain name, you must launch the MCS client using the domain name. You cannot mix-and-match domain names and IP addresses or Session Expired and Maximum Viewers Exceeded errors may be displayed by the Portal Server.

### ▼ To launch a live presentation

1. Once the Portal Server is configured as explained above, go to VBPresenter, upload your slides, go **LIVE ONLINE**, and begin the presentation. This makes the presentation immediately available to authorized users from a link on the **Live Broadcasts** page in the Portal Server. The link will be automatically removed from this page at the end of the presentation. If the presentation is terminated abnormally for any reason (for example if the presenter exits without going **OFFLINE**), you may need to manually remove the presentation link from the **Live Broadcasts** page. See [Live Presentations](#) on page 98 for details.

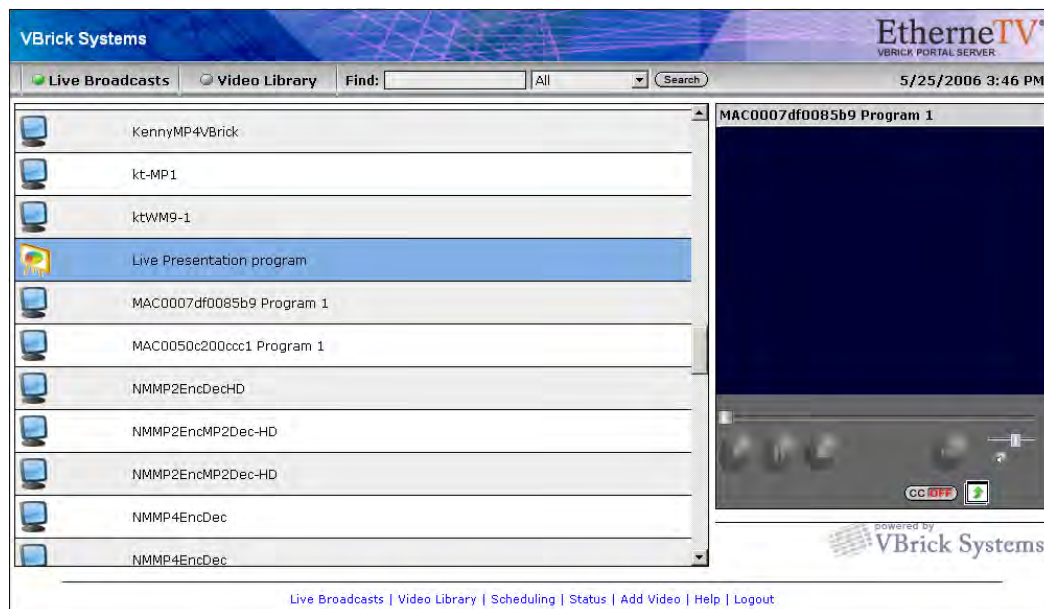

2. If you also want to record the presentation from VBPresenter, click **Record Start** to begin and **Record Stop** to end.
3. When finished recording, click **Publish Recorded Presentation** on the VBPresenter toolbar. This will FTP the recorded presentation to the Portal Server (with a unique name) and make it available to authorized users on the **Video Library** page. This may take a few minutes.

## Removing a Live Presentation

Use this window to manually remove a live presentation listing from the **Live Broadcasts** page. If the presentation is terminated abnormally for any reason (for example if the presenter exits PowerPoint without going **OFFLINE**), you may need to manually remove the presentation links.

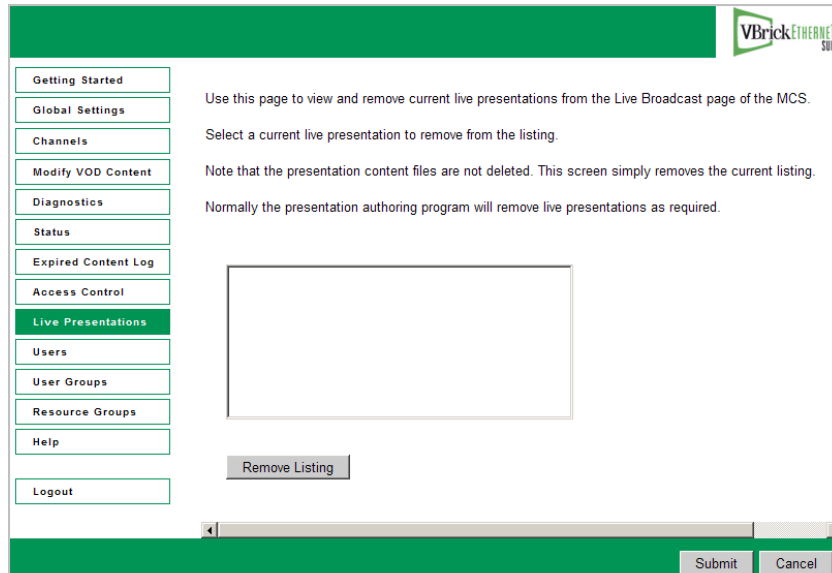

## Launching a Stored Presentation

- ▼ To launch a stored presentation
  1. Open the Portal Server user interface.
  2. On the **Video Library** page, navigate to the video name published from VBPresenter and click once to launch it in a browser.
  3. Mouse over the presentation name to display the **Info** button to the right. Use this popup window to enter **Keyword** and **Description** "metadata" that will make the presentation easy to find in a search.

## *Configuring for Stored Presentations*

There is no additional configuration for stored presentations.



## Auto Content Ingestion

### Topics in this section

AutoIngest Content . . . . .	139
AutoIngest Content via XML . . . . .	141
Removing MPEG-4 Closed Captions . . . . .	144

As explained in this chapter, there are two ways to autoingest content depending on your requirements. One method is to FTP or copy your video content to predefined folders on the Portal Server. The folders are monitored and the content is automatically ingested (autoingested) at periodic intervals. The second method is to use .xml files for content stored at remote locations or on mass storage devices. This method also supports metadata for search, copyright protection, maximum viewers, etc.

### AutoIngest Content

You can FTP or copy prerecorded content to the ETV Portal Server for easy ingestion to the VOD server(s). The ETV Portal Server periodically (every 5 minutes) polls certain folders for presence of content and if found ingests the content onto multiple VOD servers. This process is called *Automatic Content Ingestion* or *Autoingestion*. The content can come from a pushbutton recording on the Portal Server, a VBrick VBStar, or a file recorded with StreamPlayer Plus.

---

**Note** You cannot autoingest VBPresenter or other third-party presentations into the Portal Server. You must use the native FTP facilities in each application.

---

The content should be placed in a pre-defined sub-folder (`mcs\autoingest`) under the FTP root folder. This pre-defined folder is called the *autoingest root folder*. For example, if the FTP root is at `c:\inetpub\ftproot`, the content could be placed anywhere under `c:\inetpub\ftproot\MCS\AutoIngest`. In this example the `autoingest` root is `c:\inetpub\ftproot\MCS\AutoIngest`.

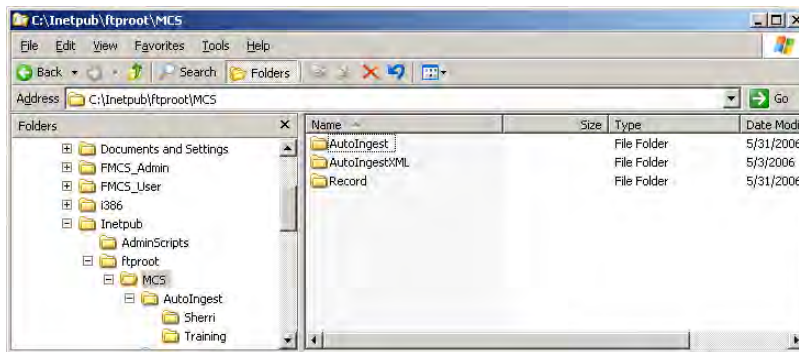

---

**Note** The default FTP path may be on a different drive, refer to the IIS default FTP configuration to confirm.

---

Content that is placed under the autoingest root folder on the ETV Portal Server will be ingested into the root video folder on the VOD server provided that it is configured using the ETV Portal Server Administrator interface. If you want to place content on a subfolder in the VOD server, that same folder would have to be created and configured using the ETV Portal Server Admin interface as described below.

Go to **Global Settings > Servers > Add/Modify Video On-Demand Content Folders**. Here an existing or new folder can be associated with selected VOD servers for autoingestion. The folders are listed on the left with the path relative to autoingest root. The VOD servers are listed on the right inside the **Add/Modify Folders on Selected Servers** box. Select the desired folder and then select the target VOD servers to ingest content. Press **Submit**. The folder is now created under the autoingest root folder and configured. See [Add/Modify Video On-Demand Content Folders](#) on page 41 for details.

### Example

If under the root video folder on the VOD Server you had a folder (or want to create a folder) called **Training** and you wanted **trainingvideo.mpg** to be placed there,



FTP the file to the Portal Server into `<drive:>\inetpub\ftproot\mcs\autoingest\training\`

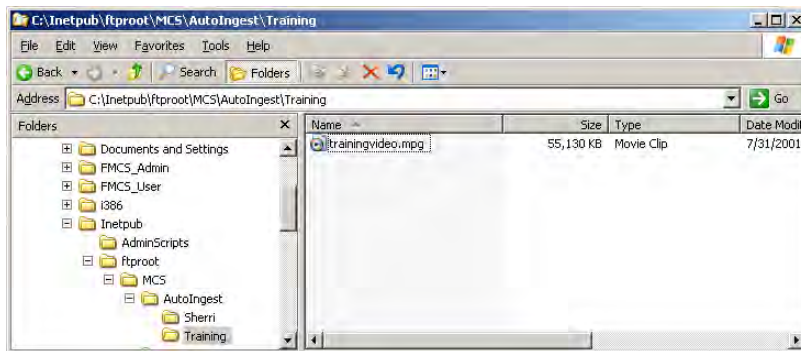

The ETV Portal Server will then ingest the file automatically into the folder on the VOD server(s) that this folder is associated with. The file **trainingvideo.mpg** would be displayed on the ETV Portal Server user interface in the Training folder.



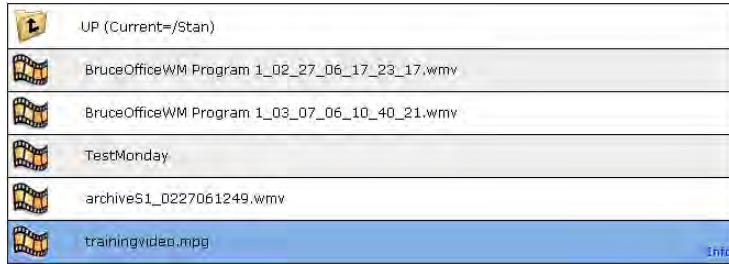

## AutoIngest Content via XML

This feature lets you autoingest video files by placing an .xml file in the **AutoIngestXML** folder on the Portal Server. It also lets you associate metadata with the video such as maximum number of viewers for copyright protection, keywords for searching, etc. As explained below there are three ways (see Table 15) to use this feature depending on where the source files are located. The Portal Server monitors this folder for .xml command files and autoingests any files at five-minute intervals. The **ingest** command, target video file name, target VOD folder, and metadata to associate with the video are contained in the .xml file. Autoingest permissions are associated with an autoingest user that is defined using the Admin Console.

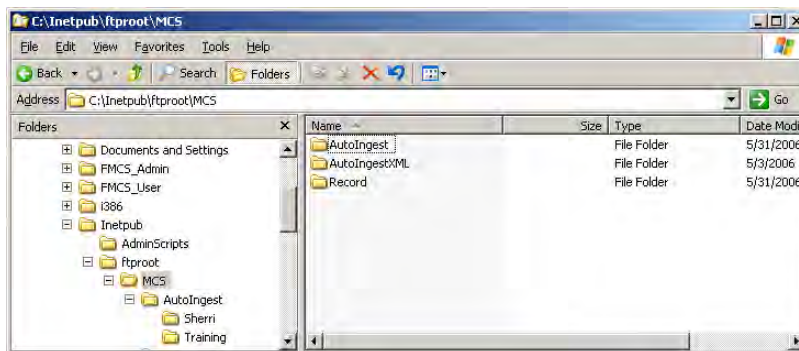

The Portal Server autoingest folder is under FTP root on the Portal Server at **/MCS/AutoIngestXML**. The video file and the .xml file must be FTPed (or copied) to this directory and the target video title must contain the fully qualified path to the destination. The autoingest user name as configured in the Portal Server Admin Console will be used to access available VOD servers. If the autoingest user does not have publishing rights for the VOD directory specified in the **MCSTitle**, the ingestion will fail.

Autoingest users must have VOD server access to at least one server capable of storing the video type (MPEG, WM, H.264). Only existing custom fields will be recognized and associated with the video (see [Custom Fields](#) on page 28 for more information). The Windows **Event Viewer** will log the ingest command, noting the full path and the .xml data contained in the command, and will also log the successful ingestion of the video.

### ▼ To create an autoingest user with publishing rights

1. Open the Admin Console, go to **Users > Add User**, and create an autoingest user, e.g. **AutoIngestUser**.
2. On the same page, go to **Allow Access to Specific VOD Servers** and select the servers this user can access.
3. On the same page, go to **Allow Content Publishing** and select the folders this user can publish to.

- Then go to **Global Settings > Global Assignments > Assign AutoIngest** and set the user you just defined as the **Current AutoIngest User**.

## AutoIngestXML Modes

There are three modes of operation as shown in Table 15. The mode you use depends on *where* the source files are located.

**Table 15.** AutoIngest Modes

Mode	Description
Direct	The target source video file is FTPed to the <b>AutoIngestXML</b> folder. The video file and the .xml file must both be FTPed to this folder. In Direct mode, you must FTP the video file first or the ingestion will fail.
Absolute	WM files only. The target source video file resides in a folder on the Portal Server. Only the .xml file is FTPed to the <b>AutoIngestXML</b> folder. This is useful for mass storage devices because you do not have to copy the files to the <b>AutoIngestXML</b> folder on the Portal Server.
Remote FTP †	MPEG Files only. The target source video file resides on a remote FTP server. Only the .xml file is FTPed to the <b>AutoIngestXML</b> folder.

† Not available for VOD-D (Darwin) servers. Use Direct mode only to AutoIngest to VOD-D servers.

## Using the XML Template

There are three named templates in the `vBrick\MCS\utils` folder for Direct, Absolute, and Remote FTP files. Use the appropriate template to manually create an .xml file for *each* video file. Use Notepad, TextPad, or a similar tool and then FTP this file (and the video in Direct mode) to the **AutoIngestXML** folder on the Portal Server. (In Direct mode, you must FTP the video file first or the ingestion will fail.) The filename can be any alphanumeric string with an .xml extension. The following code shows a sample .xml file that uses the Direct mode template. **The template for each mode is the same except for the SourceFileName and SourceFileType tags.** Table 16 explains the required format for these tags.

```
<?xml version="1.0" encoding="utf-8"?>
<AutoIngestCmd version="1.0">
  <Command>ingest</Command>
  <Ingest>
    <MCSTitle>/VODFolder/Spiderman Returns</MCSTitle>
    <Keywords>Ingest001</Keywords>
    <Description>My ingested Video</Description>
    <Expiration>20060430-1130</Expiration>
    <SourceFileName>Ingest002.wmv</SourceFileName>
    <SourceFileType>WM</SourceFileType>
    <MaxViewers>-1</MaxViewers>
    <FileLink filename="myfile.ppt" url="http://www.google.com/" />
    <FileLink filename="myother.ppt" url="http://www.google.com/" />
    <CustomFields>
      <Field name="CustomTextField1" value="Value1" />
      <Field name="CustomTextField2" value="Value2" />
      <Field name="CustomDropField1" value="one" />
    </CustomFields>
  </Ingest>
</AutoIngestCmd>
```

```

    <Field name="CustomDropField2" value="two" />
  </CustomFields>
</Ingest>
</AutoIngestCmd>

```

**Table 16.** AutoIngestXML Tags

Tag	Description
Command	Required. Must be set to <b>ingest</b> .
MCSTitle	Required. Cannot be blank. Must begin with "/" and contains fully qualified path to destination VOD folder/title on the Portal Server. The autoingest user name must have publishing rights for VOD target folder.
Keywords	Optional. Keywords associated with this video. Used for search.
Description	Optional. Description of the video. Used for search.
Expiration	Optional. Content expiration specifier, e.g. <b>20060430-1130</b> . Format: <b>yyyymmdd-hhmm</b> Used for copyright protection.
SourceFileName	<p>Required. Contains the source video file name to be ingested. The format of this data determines the mode of operation.</p> <ul style="list-style-type: none"> <li>• Direct – All files. This file must reside in the <b>AutoIngestXML</b> directory (<i>it must be FTPed first</i>) on the Portal Server. This file will ultimately be copied to one or more VOD servers. The format is simply the filename for example: <b>ingest001.wmv</b></li> <li>• Absolute – WM files only. This file must reside in a folder on the Portal Server. The format for this data is: <b>[absolutePath] &lt;FullLocPath&gt;</b> for example <b>[absolutePath]c:/Temp/ingest002.wmv</b></li> <li>• Remote FTP – MPEG Files only. This file resides on a remote FTP server. The format for this data is: <b>ftp://username:password@FTPServerURL/VirtuualDirectory/Filename</b> For example: <b>ftp://videos:videos@172.22.2.1/videos/ingest0003.mpg</b> where the FTP protocol string, username, password, FTP URL, virtual directory, and file name are specified in the string in a fixed format.</li> </ul>
SourceFileType	Format type of the video files: WM, H.264, MPEG-1, MPEG-2, MPEG-4. Required for Absolute and FTP Remote modes; not used with Direct.
MaxViewers	Optional. Maximum number of concurrent viewers allowed. -1 = unlimited. If unspecified, -1 (unlimited) is assumed.
FileLink	Optional. 0–n file reference links to associate with this video. Each file link requires a filename (e.g. "myfile.ppt") and a URL.

---

Tag	Description
CustomFields	Optional. 0–n custom fields to associate with this video. See <a href="#">Custom Fields</a> on page 28 for more information. Each custom field must contain: <ul style="list-style-type: none"><li>• name – must be already defined in Portal Server or field will be ignored.</li><li>• value – dropdown list boxes only; must be already defined in Portal Server or field will be ignored.</li></ul>

## Removing MPEG-4 Closed Captions

MPEG-4 files with closed captions cannot be added to NXG servers until the closed caption track is removed. The ETV Portal Server will display an error message if you try to add such files. VBrick provides a utility to remove the closed captions track from an MPEG-4 file if necessary. It is installed with ETV Portal Server in `c:\program files\vbrick\utils`

- ▼ To remove the closed captions track from MPEG-4 files
1. Go to `c:\program files\vbrick\MCS\utils` and double-click `CCTrackRemover.exe`
  2. Enter an **MPEG-4 File Name** and click **Remove CC Track**. Depending on the size of the file it may take a few moments to complete.
  3. When done, you can add or autoingest the video file as necessary.

## EtherneTV Backup

This chapter explains how to use ETV Backup to create a warm backup Portal Server. ETV Backup is an optional software application. If you did not purchase ETV Backup, you can backup key Portal Servers files and directories manually. See [Manual System Backup](#) on page 183 for details.

### Topics in this section

Overview .....	145
Configuring ETV Backup .....	147
Turning a Warm Backup Server into a Live Server .....	152
Bringing a Failed Machine Back Online. ....	152
Software Installation .....	154

### Overview

EtherneTV Backup is a highly-automated standalone application that backs up key directories on the Portal Server at periodic intervals. ETV Backup requires two separate Portal Server machines: a "warm backup" Portal Server and a "live" Portal Server. *They must both have the same version of the Portal Server software installed.* During a scheduled backup, ETV Backup copies new or changed files and ensures that the data on the warm backup always matches the data on the live Portal Server.

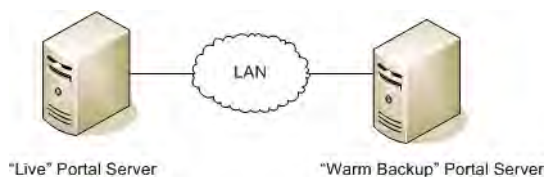

Warm backup is the process of copying key directories and files from a "live" (primary) Portal Server to a "warm backup" (secondary) MCS server. These directories and files are backed up on a scheduled periodic basis (every 10 minutes) and a configurable number of archive versions are kept on the backup server. The warm backup will not function as a Portal Server while it is in warm backup mode. If the live Portal Server fails for any reason, you can quickly convert the backup server into the live server by performing a few simple steps. The warm backup then becomes the "live" primary server.

ETV Backup is an optional EtherneTV component with its own license. *ETV Backup does not provide a redundant "hot" standby server, nor does it backup video content.* ETV Backup is designed to provide a "warm" backup server for key Portal Server data files and for the metadata describing your content. There is no installation procedure. ETV Backup is automatically installed and requires only a license key. This document describes how to configure a warm backup and how to turn a warm backup server into a live server. Once it is properly configured, ETV Backup will automatically run every ten minutes and no additional configuration or user action is required.

**Note** ETV Backup is tightly integrated with the Portal Server and backs up key directories and files. VBrick does not support any user customization of this product or any non-ETV Portal Server uses of the software.

## ETV Backup Profiles

The folders shown below are automatically backed up from the live server to the warm server. As shown in the window, each key Portal Server directory is preconfigured with a corresponding "profile." Note that Portal Server license files are specific to the server hardware on which they are installed. For this reason they are backed up on the warm server in an alternate location under the MCS application directory so that they do not overwrite the warm backup server's own license files.

Profile	Type	Last Run	Result	Next Run	Last Successful Run
MCS Warm Backup Group	Group	5/22/2008 3:41:32 PM	Success	5/22/2008 3:50...	
MCS Database Backup	Backup	5/22/2008 3:41:34 PM	Success	Not Scheduled	5/22/2008 3:41:34 PM
MCS LicensesBackup	Backup	5/22/2008 3:41:35 PM	Success	Not Scheduled	5/22/2008 3:41:35 PM
MCS Live Presentations Backup	Backup	5/22/2008 3:42:59 PM	Success	Not Scheduled	5/22/2008 3:42:59 PM
MCS Logs Backup	Backup	5/22/2008 3:43:00 PM	Success	Not Scheduled	5/22/2008 3:43:00 PM
MCS nsc Backup	Backup	5/22/2008 3:43:02 PM	Success	Not Scheduled	5/22/2008 3:43:02 PM
MCS sdp Backup	Backup	5/22/2008 3:47:23 PM	Success	Not Scheduled	5/22/2008 3:47:23 PM
MCS Station Icons Backup	Backup	5/22/2008 3:43:10 PM	Success	Not Scheduled	5/22/2008 3:43:10 PM
MCS Stored Presentations Ba...	Backup	5/22/2008 3:43:10 PM	Success	Not Scheduled	5/22/2008 3:43:10 PM
MCS Thumbnails Backup	Backup	5/22/2008 3:43:11 PM	Success	Not Scheduled	5/22/2008 3:43:11 PM

**Table 17.** ETV Reporter Backup Profiles

Profile Name	MCS Folder Location
MCS Database Backup	C:\Program Files\MySQL\MySQL Server 5.0
MCS LicensesBackup	C:\Program Files\VBrick\MCS\licenses
MCS Live Presentations Backup	MCSPresentations (virtual directory)
MCS Logs Backup	C:\Program Files\VBrick\MCS\Logs\
MCS nsc Backup	C:\Program Files\VBrick\MCS\nsc
MCS sdp Backup	C:\Program Files\VBrick\MCS\sdp
MCS Station Icons Backup	StationIcons (virtual directory under MCS application)
MCS Stored Presentations Backup	Presentations (virtual directory)
MCS Thumbnails Backup	C:\Program Files\VBrick\MCS\Images\Thumbnails

## Configuring ETV Backup

- ▼ To configure EthernéTV Backup, you must perform all of the following steps in the exact sequence shown
  1. Enter License Key.
  2. Set Profile IP Addresses.
  3. Configure the Scheduler.
  4. Reset Database Backup Versioning.
  5. Enable the Warm Backup Server.
  6. Test the Configuration.

### 1. Enter License Key

The first time you launch ETV Backup, you will be prompted for a license key. This key is attached to the "Software Activation Keys" card shipped with the EthernéTV server.

- ▼ To enter the license key
  1. Find your license key on the "Software Activation Keys" card, type it into Notepad, and copy it to the clipboard (Ctrl-C).
  2. Launch ETV Backup: go to **Start > All Programs > VBrick > ETV Backup**.
  3. When the Serial Number window is displayed, paste the license key into the window (Ctrl-V) and the ETV Backup application will automatically be launched.

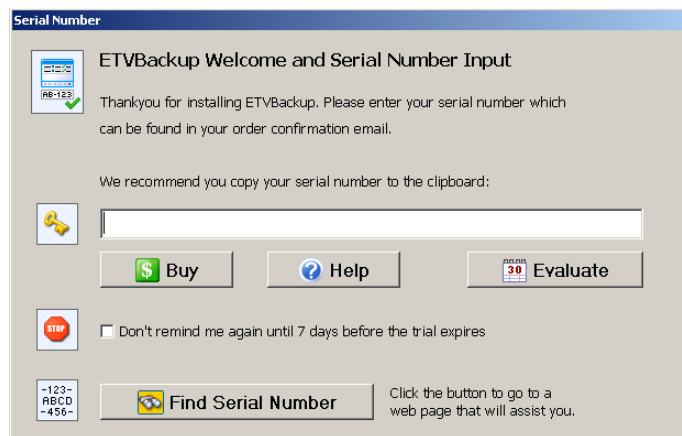

### 2. Set Profile IP Addresses

ETV Backup is shipped with a preconfigured profile "group" called **MCS Warm Backup Group**. This group has individual profiles corresponding to all of the key Portal Server directories that need to be backed up. All ETV Backup functions use this preconfigured group. Before you can run ETV Backup you need to set the IP addresses for *each* of the individual profiles in **MCS Warm Backup Group**. These addresses must correspond to the actual IP address of your live Portal Server.

- ▼ To set the profile IP addresses
  1. Double-click on the first profile (or right-click and select **Modify**) in the group which is **MCS Database Backup**. (This should open the following window. If not check that **Preferences > Double-click Action** is set to **Modify the profile**.)

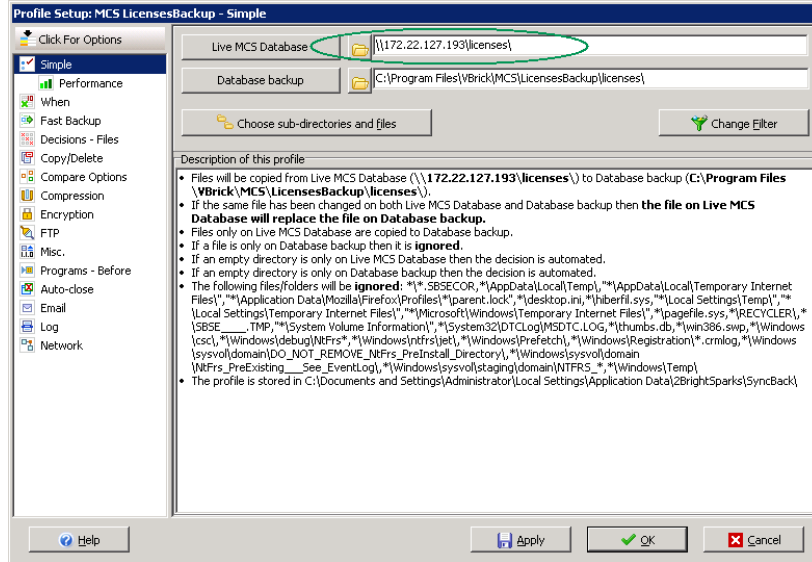

2. In the **Live MCS Database** field, replace the IP address shown with the IP address (or server machine name) of your live Portal Server. Do not change anything else in the path.
3. The **Database backup** field is populated automatically. Do not change anything in this field.
4. Click **OK** when done and repeat these steps for each of the other profiles.

### 3. Configure the Scheduler

▼ To configure the Scheduler

1. Right-click on **MCS Warm Backup Group** and select **Schedule**.
2. Click **Edit Schedule**.

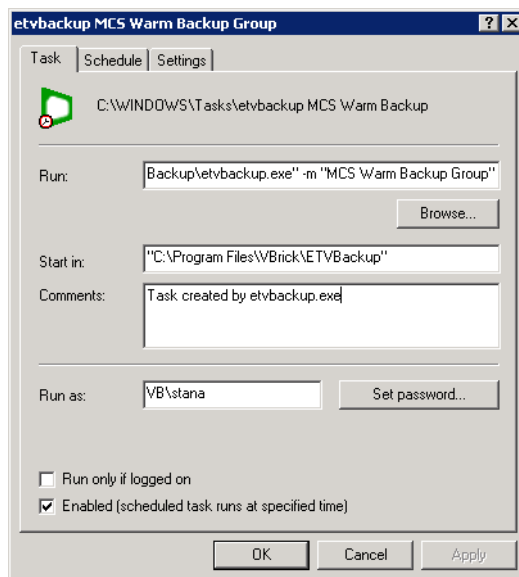

3. Be sure a user with administrative privileges on the server machine is shown in the **Run as** box. Press **Set Password** and enter the password associated with that user.



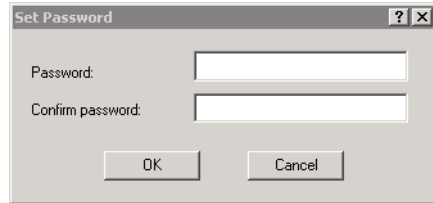

4. Press **OK** and **OK** and minimize the application—do not exit.

#### 4. Reset Database Backup Versioning

This step is important. Do not omit this step.

- ▼ To reset database backup versioning
  1. Right-click on **MCS Database Backup** and select **Modify**.
  2. Then go to **Copy/Delete > Versioning** and set maximum versions to **5** and maximum days to **7**.

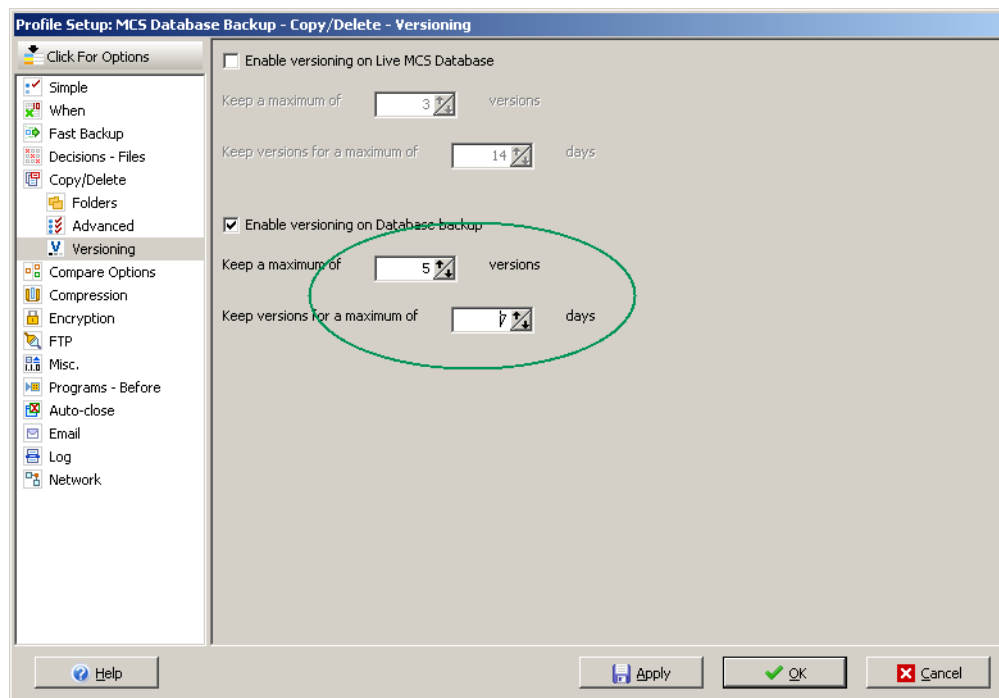

3. Click **OK** and minimize the application—do not exit.

#### 5. Enable the Warm Backup Server

If you purchased ETV Backup, two Portal Servers will be present at your site—one of which must be configured as a warm backup. *By default, the warm backup option is disabled on both servers.*

- ▼ To enable a warm backup server
  1. On the server machine that will be used as the warm backup, go to **Start > Control Panel > Add or Remove Programs > VBrick Media Control Server Suite**.
  2. Click **Change/Remove** and on the following window. Then select **Enable/Disable Warm Backup Server** and click **Next**.

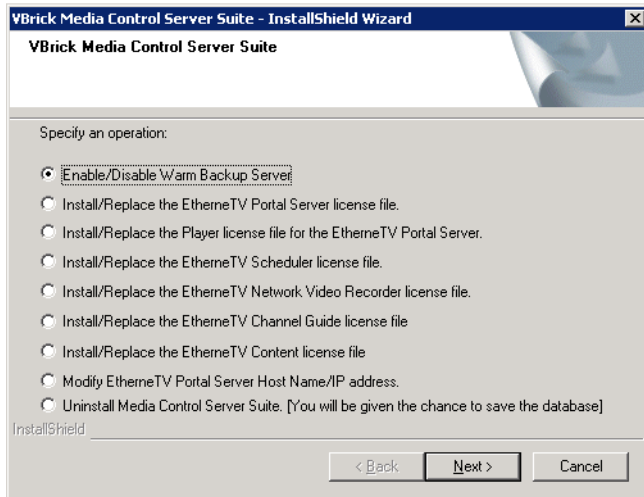

3. On the following window, select **Enable** and click **Next**, then **OK** to exit. This will enable the machine as a warm backup. This will complete the configuration and there is no need to reboot the server.

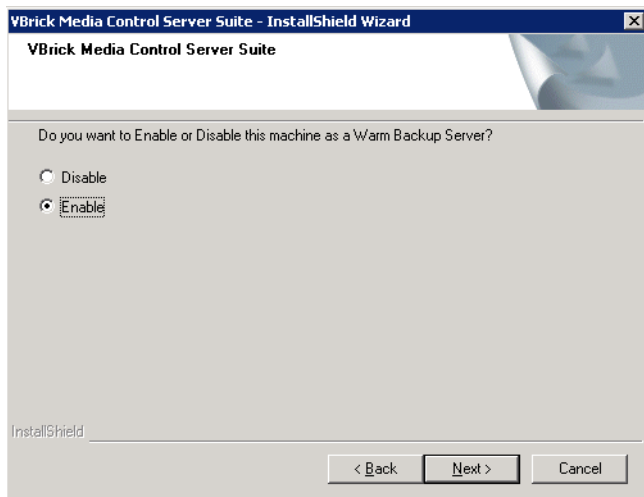

4. When finished, launch ETV Backup using the desktop icon.

## 6. Test the Configuration

When you are finished configuring the IP addresses, click the **Run**  icon in the navigation footer. All backup profiles should run without errors and a window similar to the one shown below will report a successful backup for each profile. If problems occur, for example if you entered an invalid IP address, the window will report any failures. Correct the problems using the information provided in the log window and try again.

▼ To test the configuration

1. Highlight the **MCS Warm Backup Group** and click **Run**.
2. Click **Continue Run** for each **Differences for profile: xxxxx** window and then **OK**.
3. If no errors occur, a window similar to the one shown below will be displayed.

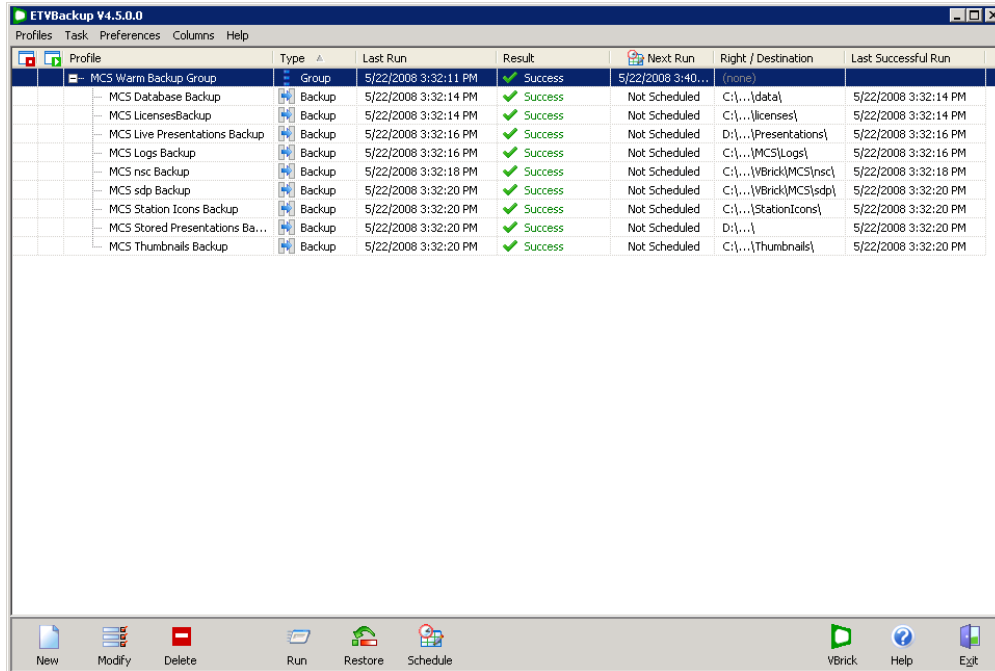

4. If errors occur, right-click on the failed profile and select **View Log > Newest**.

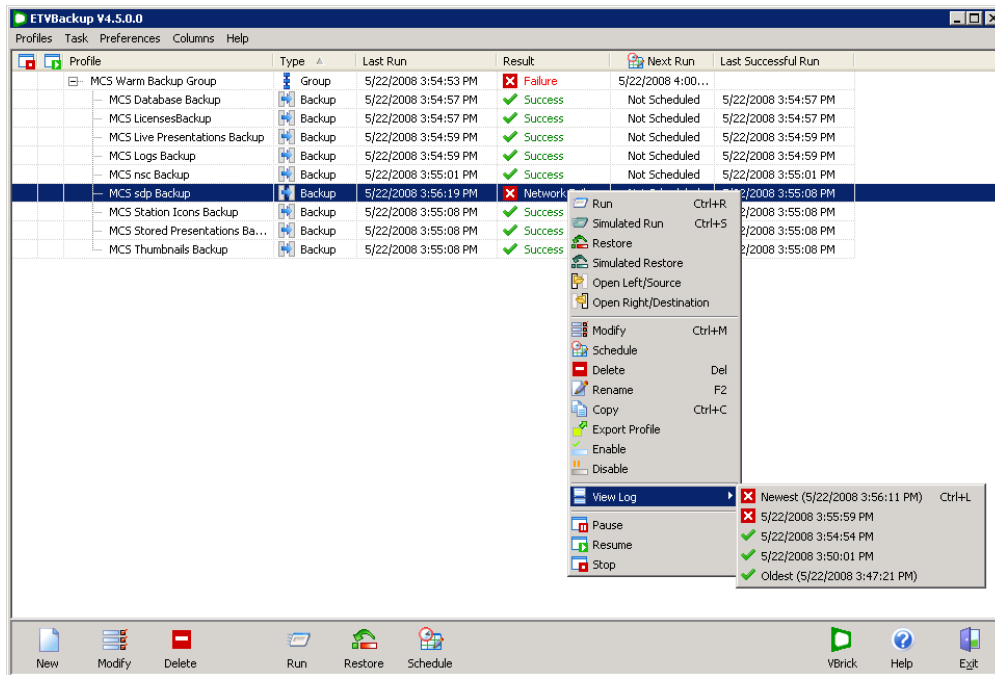

- This will displayed detailed information (see below) that you can use to correct the error.
- When done, highlight the failed profile and run again until successful.

**ETVBackup Log**  
Main Page

---

Select a link below to view detailed information about the task you carried out:

| Copied, deleted, and changed (0) | Skipped (0) | Warnings (0) | Errors (0) | Non-Critical Errors (0) |

Log Report: Overview			
Profile Name	MCS Database Backup		
Result	Scan Failure		
Unattended	No		
Username	VB\Stana	Computer Name	STANAXPNB05
Profile Start Time	3/4/2008 3:40:27 PM	Profile End Time	3/4/2008 3:40:50 PM (23 secs)

Log Report: Errors and Warnings	
Critical Error	Failed to prepare Live MCS Database : Directory \\172.22.130.22\MySQL Server 5.0\data does not exist and cannot be created

[Report produced by ETVBackup](#)

## Turning a Warm Backup Server into a Live Server

A Portal Server can experience a hardware failure for a variety of reasons. If the hardware fails, you may be unable to communicate with the server via a web browser, the Remote Desktop utility, or any other means. Since there will be no web access, end users may get a "404 page not found," server timeout, or similar message. If this happens, remove the server from service and turn the warm backup into the primary server as explained here. This procedure only takes a minute or two. *After fixing or replacing the failed primary server, you can then re-configure it as a warm backup or as the primary server.*

**Note** In most cases, the changeover to a warm backup server will be totally transparent to end user (client) viewers. If they are watching a live or a stored VOD video when the changeover occurs, there will be no disruption to the video viewing.

- ▼ To turn a warm backup server into a live server
  1. On the warm backup machine, open the **Add or Remove Programs** window on the **Control Panel** and click **Change/Remove** on the **VBrick Media Control Server Suite**.
  2. Then click **Disable** to disable the warm backup and make this machine your live server. *You will no longer have a warm backup server.*

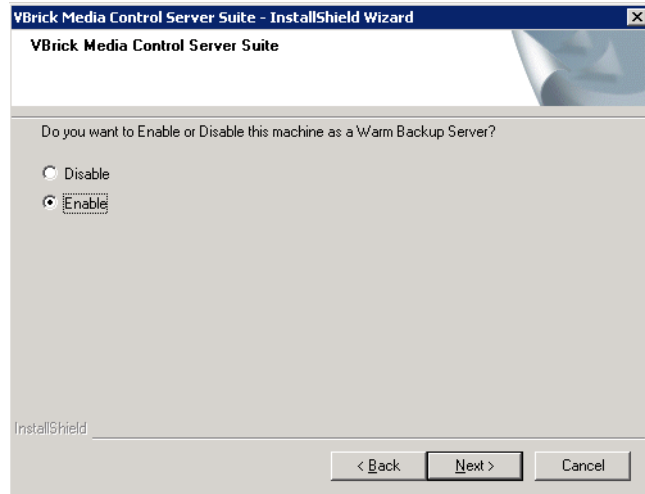

3. If you want viewers to use the same host name for the Portal Server after turning a warm backup into a live server, a network administrator will have to change the IP address or DNS entry to match the new address.

## Bringing a Failed Machine Back Online

### *Bringing a Failed Machine Back Online as a Warm Backup*

- ▼ To bring a failed machine back online as a *warm backup* server
  1. Configure the fixed machine as a warm backup. Repeat *all* of the configuration steps described earlier (see [Configuring ETV Backup](#) on page 147). Be sure to replace the profile IP addresses with the IP address (or server machine name) of the *new* live Portal Server. Make sure you don't put both the live server and the warm backup server online at the same time with the same IP address.
  2. After fixing or replacing the failed server, go to **Add or Remove Programs** and **Enable** this machine as a warm backup—not as a live Portal Server. You can only have one Live Portal server configured at a time.  
(If you want viewers to use the same host name for the Portal Server after turning a fixed machine into a warm backup, a network administrator will have to change the IP address or DNS entry to match the new address.)
  3. After performing these steps, the new primary server will acquire the backed up directories and files from the old primary server as soon as you test the configuration.

### *Bringing a Failed Machine Back Online as a Primary Server*

- ▼ To bring a failed machine back online as a *primary* server
  1. **Follow Steps 1–3 above to first bring a failed machine back online as a warm backup.** You must perform these steps first. *If you do not, you risk losing all existing backup data.*
  2. Go to **Add or Remove Programs** and **Disable** this machine as a warm backup.
  3. Go to **Add or Remove Programs** on the other server and **Enable** that machine as a warm back.

---

## Software Installation

EtherneTV Backup requires a license key. If your EtherneTV purchase included ETV Backup, the license key will be installed by VBrick prior to shipment. If you ever need to re-install the software, the license key is attached to the "Software Activation Keys" card that is included with the server. If you purchase ETV Backup separately, VBrick will send a "Software Activation Keys" card with the new license key attached. Launch ETV Backup and enter this license key, when prompted, to activate the software.

## Amino Set Top Box

### *Topics in this section*

Overview .....	155
Connecting the Amino.....	155
Configuring the Amino .....	156
Configuring the Remote Control for a TV .....	158
Configuring the Amino for a Widescreen .....	158

### Overview

The AmiNet110 is a compact set top box for the Portal Server manufactured by [Amino Systems](#). It connects to a standard TV and plays MPEG-2 streams only—no other streams are selectable for viewing or adding. These pages explain how to connect and configure the Amino set top box. There is no software installation required: simply connect and configure the device as explained below and you are done. The *Portal Server User Guide* explains how to use the Amino remote control unit to select streams and navigate Portal Server pages *after* the Amino is configured and running as explained here. The Amino *does not* support the following Portal Server functionality:

- Access Logging
- Scheduling
- Custom Fields
- Device Control
- Priority Alert
- Copyright Restrictions

### Connecting the Amino

Connect the Amino STB to a standard TV and to your Ethernet network as explained below. If necessary, refer to the illustrations in the *AmiNet110 User Guide* that came with the device. Check the components for damage as you unpack the device. The AmiNet110 includes a power supply, a mounting stand, a remote control, and an A/V cable.



- ▼ To setup and connect the Amino
  1. Mount the Amino either vertically or horizontally as explained in the *AmiNet110 User Guide*.

- 
2. Connect the Amino to your network using a standard Ethernet cable (not supplied) with an RJ-45 connector.
  3. Connect the Amino to the TV as follows.
    - a. Connect one end of the Amino A/V lead to the composite connector on the Amino.
    - b. Connect the other end to either the S-Video connector on the TV or to the red, white, and yellow audio and video connectors.
  4. Connect the power supply and install three AAA batteries in the remote control.

## Configuring the Amino

The Amino STB is shipped with a handheld IR remote control and an optional wireless keyboard. **You must use the Amino wireless keyboard to configure the set top box.**

- ▼ To configure the Amino using the wireless keyboard
1. Connect the Amino, the network, and the TV as explained above and power on the STB.
  2. When the Amino splash page is displayed, press **Alt-m** on the keyboard.
  3. Enter the read management password (default = **leaves**).

---

**Note** When the Amino Admin pages are displayed, you must use Shift + Arrow Up/Arrow Down to navigate through the menus.

---

4. If a DHCP server is present, the Amino IP address is automatically obtained from the DHCP server.
5. If a DHCP server is not present, and you want to set a static IP address, select **Network Configuration**, set **DHCP Info** to **Do not use**, and enter the new IP address and other network data.
6. Select **Trusted Domains** and add the Portal Server IP address or host name to the list of trusted domains in the format: **<ip\_address>** or **<hostname>** (do not use http://). Also verify that **Macrovision** and **JavaScript** are enabled.
7. Save changes and enter the write management password (default = **snake**).
8. Return to main menu and select **Browser Setup**.
9. In the **Home Page** field, enter the Portal Server URL as **http://<PortalServerIPAddress>**
10. Save your changes and push the **Home** button on the keyboard to launch the Amino MCS home page (Figure 20).



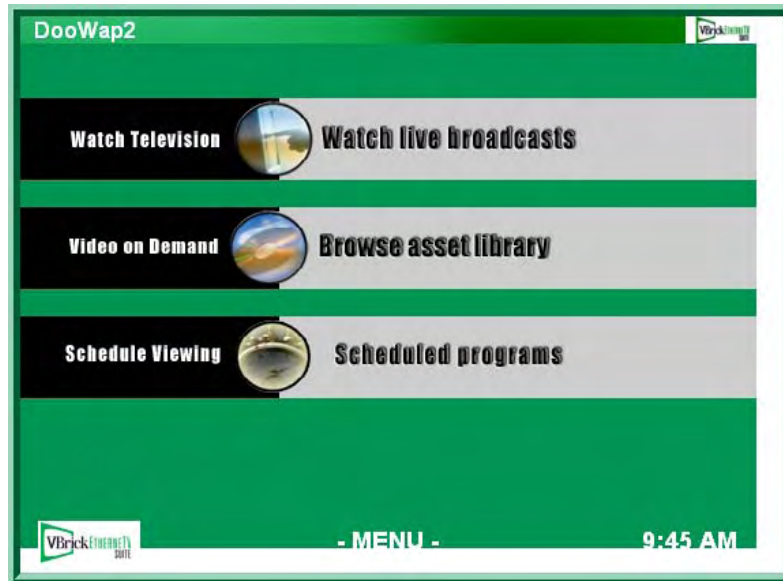

Figure 20. Amino MCS Home Page

11. Click on **Watch live broadcasts**, for example, to display the Live Broadcasts page (Figure 21). You can use this page to select any available MPEG-2 stream.

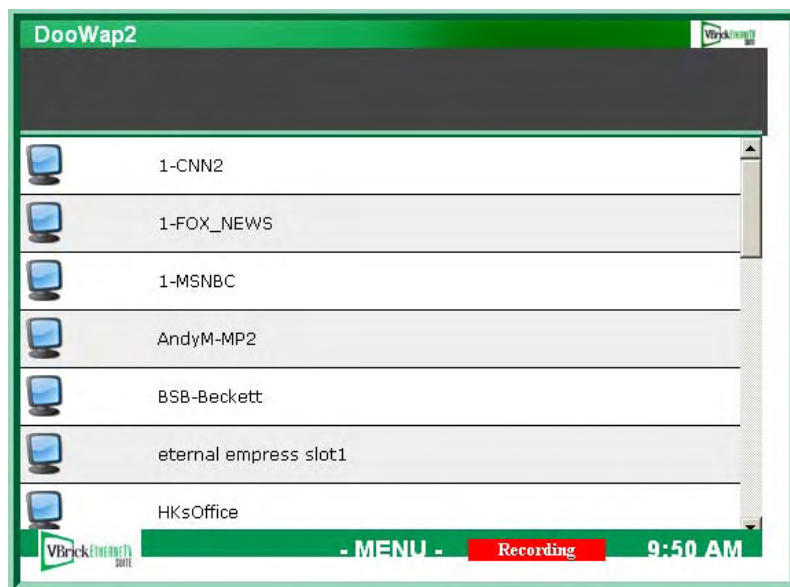

Figure 21. Live Broadcasts Page

### *Changing the IP Address*

Once the Amino is initially configured as explained above, you can change the IP address as necessary using the wireless keyboard.

- ▼ To change the IP address
  1. Go to the Amino MCS home page (Figure 20) and press **Ctrl** on the keyboard.
  2. Click **OK** to toggle the **Default Amino Keys** to **On**.

- 
3. Press **Alt-m** on the keyboard and use the steps listed above in [Configuring the Amino](#) to set a new IP address.
  4. Press **Ctrl** again to toggle off the **Default Amino Keys** and resume normal operation.

### *Configuring a Direct Connection*

In some cases you may wish to connect the Amino directly to a VBrick MPEG-2 appliance without using the Portal Server. In this case the attached monitor will display the single stream from the appliance in full screen mode.

- ▼ To connect an Amino directly to an MPEG-2 appliance
  1. Open the management interface on the Amino (**Alt-m**).
  2. Navigate to **Browser Setup > Home Page**.
  3. In the **Home Page** field, enter the IP address of the VBrick appliance in the following format: **igmp://<vbrick\_ipaddress>:port**
  4. Reboot the Amino to display the MPEG-2 stream from the VBrick in full screen mode on the monitor.

## Configuring the Remote Control for a TV

The Amino handheld IR remote control is designed to work with the Amino set top box. During normal operation, the **STB/TV** button (see the *Portal Server User Guide*) should be set for **STB**. It can, however, be configured to work with a standard TV. In order for the remote to transmit the correct signals to control the TV, it must be programmed with a 3-digit code that matches the TV. See the [Amino Remote Controls User Guide](#) for more information.

## Configuring the Amino for a Widescreen

This procedure explains how to configure an Amino Set Top Box for MPEG-2 output to a widescreen (16:9) TV. Use one of the following methods depending on whether you are using the handheld remote control or the wireless keyboard. *When done, repeat these steps if necessary for each Amino set top box.*

- ▼ To configure for widescreen with the wireless keyboard
  1. Press **Ctrl** to get into Amino keyboard mode.
  2. Press **Alt-p** to get to **Preferences**.
  3. On the **Preferences** menu select **TV system and Audio Settings**.
  4. Change the **TV Display Format** to **Widescreen TV**.
  5. Save changes, exit **Preferences**, and power cycle the STB.
  6. Be sure to set the widescreen TV monitor to **Full** mode.
- ▼ To configure for widescreen using the remote control
  1. Select the **Menu** button on the Remote Control to get to **Preferences**.
  2. On the **Preferences** menu select **TV system and Audio Settings**.
  3. Change the **TV Display Format** to **Widescreen TV**.
  4. Save changes, exit **Preferences**, and power cycle the STB.
  5. Be sure to set the widescreen TV monitor to **Full** mode.

## Setting the TV Display Format

As noted, you can change the **TV Display Format** from the **Preferences** menu. The following tables show the output from normal and widescreen TVs depending on how the **TV Display Format** is set. Be sure to power cycle the STB to implement any changes you make.

**Table 18.** Video Output with a Normal (4:3) TV

TV Display Format	Video Output
Standard (4:3) Mode	Normal (4:3) video plays normally and 16:9 video has the left and right sides cropped off (center cutout).
Letterbox Mode	Normal (4:3) video plays normally and 16:9 video has all the picture viewable with black bars on the top and bottom (letterbox).
Widescreen TV	Normal (4:3) video plays normally and 16:9 video displays all the picture but it is squashed in.

**Table 19.** Video Output with a Widescreen (16:9) TV

TV Display Format	Video Output
Widescreen TV	16:9 video plays normally and 4:3 video has black bars left and right (pillar box). This relies on the TV responding to aspect ratio switching signals on VBI line 23 (PAL only). On TVs that don't respond to this signal, you must set the TV aspect ratio manually to avoid a stretched or squashed picture.



## ACNS Configuration

### *Topics in this section*

Overview .....	161
ACNS Configuration .....	161
Verify Installation.....	164

### Overview

The Cisco Application and Content Networking System (**ACNS**) is a digital media delivery solution that reduces redundant digital media streaming traffic traversing a WAN from the data center to branch offices over satellite and terrestrial networks. Cisco ACNS offers a comprehensive set of streaming-media features that let you stream high-quality and long-playing digital videos live and simultaneously to thousands of users and media players and provide access on demand at a later time. By caching on-demand content, or prepositioning frequently accessed content, ACNS minimizes the need for the same digital media content to traverse WAN links from the data center to branch offices.

VBrick has partnered with Cisco to integrate VBrick's product line with Cisco's ACNS content distribution system. Integrated VBrick products include encoders, Video on Demand (VOD) servers, IP Receiver, PC and MAC clients, and the EtherneTV system. The integration of these two industry-leading products means that customers with legacy networks can retain their existing network infrastructure and still deploy the latest in video delivery systems. The benefits of this product integration include unlimited geographic reach for video, reduced network circuit costs, higher quality video, and improved system performance. Cisco ACNS also provides a flexible management system for efficient operation, automation, and central management of the digital media delivery network.

---

**Note** The integrated Portal Server and ACNS Server solution handles MPEG-4 and Windows Media video files residing on Darwin, Windows Media, and VOD-W servers only. MPEG-1, MPEG-2, and H.264 files are not supported; VBrick's NXG (Linux) servers are not supported.

---

### ACNS Configuration

To configure the Portal Server to work with ACNS you need to perform certain steps on the Portal Server and on the ACNS server. **If you have a VBrick VOD-W server, you will need to create a virtual directory in IIS before you configure the Portal Server or the ACNS server.** If you have a Darwin server or a Windows Media server, no additional configuration is required.

#### *VOD-W Server Configuration*

ACNS copies all MPEG-4 and WM video files from all (Windows Media, Darwin, and VOD-W) servers in your EtherneTV system. (ACNS does not support NXG servers; the

---

Windows Media and Darwin servers require no additional configuration.) Use the following steps to configure a VOD-W server to work with ACNS.

- ▼ To configure a VOD-W server to work with ACNS
  1. Login the VOD-W server.
  2. Go to **Start > Windows Explorer**.
  3. Expand the tree in the left pane under the drive labeled (C:).
  4. Expand **Program Files** under C: and then expand **InfoValue** under that.
  5. Click on **QuickVideo OnDemand Server**.
  6. Double-click on the file **QvcsConfig.ini**. The system should use Notepad to open the file.
  7. Locate the line that reads "[Ingest]".
  8. Locate the lines beginning with **StoragePathN=** shortly after the "[Ingest]" line where N is a number. Leave the Notepad window open.
  9. Go to **Start > Administrative Tools > Internet Information Services (IIS) Manager**.
  10. Expand the tree in the left pane and expand **FTP Sites**.
  11. For each **StoragePath** line found in step 8, configure a virtual directory for it as follows:
    - a. Right-click on the **Default FTP Site** and then select **New > Virtual Directory**.
    - b. Click **Next** in the Welcome to the Wizard window.
    - c. For **Virtual Directory Alias**, enter the text after the first backslash (\) from the **StoragePath** line whose data is being setup. For example, if the line reads **StoragePath1=D:\Content**, enter **Content** for the **Alias**. Click **Next**.
    - d. For **FTP Site Content Directory**, click **Browse** and navigate to the directory specified in the **StoragePath** line whose data is being setup. Click **OK** then **Next**.
    - e. In the **Access Permissions** window, click **Next** to select the default permission of **Read**.
    - f. Click **Finish** to complete creation of the new Virtual Directory.
  12. You will also need to configure the VOD-W Server to allow anonymous connections.
- ▼ To allow anonymous connections
  1. Go to **Start > Administrative Tools > Internet Information Services (IIS) Manager**.
  2. Expand the tree in the left pane and expand **FTP Sites**.
  3. Right-click on the **Default FTP Site** and select **Properties**.
  4. Go to the **Security Accounts** tab, check **Allow Anonymous Connections**, and click **OK**.

## *Portal Server Configuration*

Portal Server integration with Cisco's ACNS Server is available with Portal Server v4.0.1 or later software. The following procedures explain (1) how to configure a manifest file on the Portal Server that will be used by the ACNS server to ensure that the content on the ACNS Server matches the content on the Portal Server; and (2) how to verify that forced use of TCP for MPEG-4 content is disabled.

- ▼ To create a manifest file on the Portal Server
  1. Install MCS v4.0.1 or later from the EtherneTV Product CD See the *ETV Portal Server Release Notes* for detailed instructions.
  2. After installing the Portal Server, open the Portal Server Admin Console and go to **Global Settings > Global Assignments > Set Cisco ACNS Manifest Options**.

3. Check **Enable manifest generation**, select the files (MPEG-4 and/or WM) to include, and specify an interval (default = 10 minutes) that defines how often the file will be regenerated.
4. Click **Submit** when done.
5. Click **Generate Now** to create an "on demand" manifest file. The Portal Server will create (and periodically overwrite) a manifest file called **ACNSManifest.xml** in the **Program Files\VBrick\MCS\Cisco** folder. The **Cisco** subdirectory is automatically created.

When a Portal Server is configured to integrate with an ACNS network, content playback is redirected to stream from ACNS nodes only if RTSP is used for video transmission. To use RTSP, verify that the Portal Server option to "Always use TCP" is unchecked (this is the default).

▼ To verify that TCP is off

1. Go to **Global Settings > Global Assignments > Assign LAN/Internet Address Range(s)**.
2. Verify that **Always use TCP protocol (HTTP Tunneling/RTSP Interleaving) for MPEG-4 and Windows Media content?** is unchecked.

## *ACNS Server Configuration*

Note that installation, configuration, and support for ACNS must be provided by Cisco and/or their representatives. Use the following steps to point to the Portal Server manifest file and set other configuration options.

▼ To set configuration options and identify the manifest file

1. Be sure the ACNS Server is running and launch an Internet Explorer browser.
2. Go to the ACNS Management URL, for example <https://<ipaddress>:8443>.
3. Log into the ACNS Management Tool.  
Username: **admin**  
Password: **default**
4. Click on the **Services** tab at top of page.
5. Create a **Content Channel** for the VOD server.
6. Click on **Channel Content** on the left.
7. Near the top of the screen, set the **content acquisition method** to **specify external manifest file**.
8. In the **Manifest URL** field enter the Portal Server URL in the following format:  
<http://<MCSipaddress>/Cisco/ACNSManifest.xml>
9. Set the **Check manifest every** field to desired interval (60 minutes is recommended).
10. To check the manifest file, click **Validate** to open a pop-up that will show the manifest. The last message should indicate the manifest is correct.
11. Click **Fetch manifest now** to start content replication.
12. To check the status of the content replication click on **Replication Status** on the left side of page. The system is ready when the following is true:  
**Acquisition status** is **Completed**.  
**Device states** at the screen bottom are **Completed**, and the **In Process** counts are zero.

---

## Verify Installation

- ▼ Use the following steps to verify the MCS/ACNS integration is successful
  1. Be sure that the MCS Portal Server and ACNS are configured as explained above.
  2. Go into the ACNS management system and verify that the video content added via the ETV Portal Server has been pushed to the ACNS remote content engine's disk storage.
  3. Open a browser and launch a Portal Server client.
  4. Launch a stored MPEG-4 or WM video from the Portal Server user interface. The MPEG-4 or WM content should run and play successfully to conclusion.
  5. If you run a packet sniffer on the MCS client, a trace will show that the client was redirected to play the content from a Cisco node and not from a VBrick VOD server.



## Rebranding the User Interface

### *Topics in this section*

Customizing the Portal Server . . . . .	165
Rebranding the Portal Server . . . . .	166
Rebranding Other ETV Components . . . . .	169

As explained below, there are two ways to modify the EtherneTV Portal Server user interface. The first method (see [Customizing the Portal Server](#)) is to simply replace the title and the header image. This is fairly easy and can be done quickly by a novice administrator. The second way (see [Rebranding the Portal Server](#)) is to modify the .css stylesheets and thoroughly rebrand the look-and-feel of the application. This is more complex and requires an administrator or developer who is comfortable working with HTML and .css stylesheets. Note that you can only change the Portal server "user" interface; you cannot change the Admin Console pages.

### Customizing the Portal Server

#### *Changing the Title and Header Image*

You can change various images on the Portal Server user interface, the VBrick IP Receiver, the Amino set top box, and the WM IP Receiver. On the Portal Server you can also change the default title (**VBrick Systems**) that is superimposed on the header image (Figure 22). To change this title, open the Portal Server Admin Console and go to **Global Assignments > Change Title**; then enter a new title or leave the title blank by entering at least one space. (Note that the title is always displayed in white text and may not be visible if you use a light-colored background image.) This title change will be retained through subsequent software upgrades. You can also change the header images on the Portal Server and the IP Receiver but these changes are not retained when you upgrade the application. *In general, use care when making any changes.* It is always a good idea to copy and save the original image files. For best results, open and view each image in an editor before making any changes.



**Figure 22.** Header Image

Table 20 shows the images you can change on the Portal Server and the IP Receiver. Do not modify or change any other images. You can replace any .jpg image but it must have the same dimensions in pixels (for example 1003x50) as the original image. *It must also have the same security settings.* To view the dimensions and security settings, right-click on the image and select **Properties > Summary** or **Security**. If you are prompted for a user name and password when opening the Portal Server user interface after replacing an image, it is likely that the security profile of the new image does not match the profile of the image you just replaced.

**Table 20.** EtherneTV Replaceable Images

Interface	Image
Portal Server	Header image: C:\Program Files\VBrick\MCS\Images\topBanner-1003x50_PS.jpg
VBrick IPR	Header image for MCS Portal Server: C:\sfwapp\Components\WebApp\MCS\images\STB\EtherneTV-Top-STB_PS.jpg
	Header image for MCS Live Portal Server: C:\sfwapp\Components\WebApp\MCS\images\STB\EtherneTV-Top-STB_LPS.jpg
Amino STB	Header image: C:\sfwapp\Components\WebApp\MCS\MCS_Amino\images\EtherneTV_logo_STB_20.jpg
	Logo image: C:\sfwapp\Components\WebApp\MCS\MCS_Amino\images\vbrick_logo_stb.gif
WM IPR	Logo image: C:\sfwapp\Components\WebApp\MCS\WMIPR\banner.jpg

## Rebranding the Portal Server

This section explains how to thoroughly change or "rebrand" the look-and-feel of the Portal Server user interface (and the IP Receiver) by modifying the stylesheets. It addresses the Portal Server "user" interface only—not the Admin Console. The Portal Server stylesheets are located at C:\Program Files\VBrick\MCS\css. It is always a good practice to backup all files that you will be changing and to thoroughly test your results before you are finished. *This section describes some user interface elements that are only available in Portal Server v4.2 or higher.* If you have an earlier version, you can modify the corresponding classes present in your version.

**Note** The stylesheet changes listed below are not saved when you upgrade the Portal Server application. You can save and reapply your changed stylesheets but be aware that a subsequent upgrade may have additional .css classes.

### Portal Server

#### Webpage Background

Files to Change	css/MCSv4.css
Classes	body{}
Modify	Any background attribute to fit your requirements.
Example	Changing background image to color only (remove the background-image: tag and adjust the background-color: tag to your color in Hexadecimal (#ffffff) or by Color Name (White).

#### Header Image

Files to Change	css/PC_HighRes.css, css/PC_LowRes.css
Classes	#header, .headerLogo
Modify	#header tag – add: background-image: url(yourLogo.jpg); .headerLogo – change to: display:none;

## Header Client Branding

(Left hand text in header)

Files to Change	css/MCSv4.css
Classes	.header_ClientBranding
Modify	Any attributes for font and color.

## Page Margins and Borders

Files to Change	css/PC_HighRes.css, css/PC_LowRes.css
Classes	#workspace
Modify	Any attributes for margins, positioning, borders and master workspace background color/image.

## Header Search Bar Background

Files to Change	css/PC_HighRes.css, css/PC_LowRes.css
Classes	#searchbar
Modify	Any attributes.

## Header Search Bar Navigation Text

Files to Change	css/MCSv4.css
Classes	.searchbar_main_button
Modify	Font, color.

## Header Search Bar

Files to Change	css/MCSv4.css
Classes	.formtext_bold, .imagebutton, .searchbox
Modify	Font, color, etc.

## Header Search Bar Time

Files to Change	css/MCSv4.css
Classes	.clock
Modify	Font, color, etc.

## Player's Title Text

Files to Change	css/MCSv4.css
Classes	.player_titlebar_text

Modify	Font, color, etc.
--------	-------------------

### Channel Guide Search TextBox

Files to Change	css/ChanGuide_styles.css
Classes	.CHGuideSearchTextBox
Modify	Font, color, etc.

### Channel Guide Background Search Area

Files to Change	css/ChanGuide_styles.css
Classes	.timeHeadertableSearch
Modify	Background-color

### Channel Guide Time Navigation

Files to Change	css/ChanGuide_styles.css
Classes	.timeHeadertable, .timeHeaderCells, .CHGuidePrevBtn, .CHGuideNextBtn
Modify	Background-color, color, fonts, etc.
Button Images	/ChannelGuideImages/leftArrow.gif, /ChannelGuideImages/rightArrow.gif

### Channel Guide Program Menu Text

Files to Change	css/ChanGuide_styles.css
Classes	.ChGuideProgramMenuItemTitle, .ChGuideProgramMenuDesc, .ChGuideProgramMenuItemTitles, .ChGuideProgramMenuItemDesc, .ChGuideProgramMenuDescRecord, .ChGuideProgramMenuDescSchedule
Modify	Color, font, padding, etc.

### Channel Guide Program Menu Background

Files to Change	css/ChanGuide_styles.css
Classes	.CHMenu
Modify	Background-color, background-Image, etc.

### Channel Guide Station Menu

Files to Change	css/ChanGuide_styles.css
Classes	.ChGuideStationMenuPosition, .ChGuideStationMenuTable, .ChGuideStationMenuChannel, .ChGuideStationMenuItemTitle

Modify	Background-color, background-Image, fonts, color, dimensions, etc.
--------	--

### Channel Guide Content List

Files to Change	css/ChanGuide_styles.css
Classes	.ChguideTable, .ChGuideStationCells, .ChguideCells, .ChguideCellsRecording
Modify	Border, color, background-color, recording image, padding, etc.

### Live Content List

Files to Change	css/PC_HighRes.css, css/PC_LowRes.css
Classes	.ContentList
Modify	Border, background-color, scroll-bar.

### Footer

Files to Change	css/PC_HighRes.css, css/PC_LowRes.css, MCSv4.css
Classes	#menu, .menuitem
Modify	Color, background-color, fonts, size, etc.

### Messages Area

Files to Change	css/PC_HighRes.css, css/PC_LowRes.css
Classes	#messages, message_box_text
Modify	Positioning, background-image, color, font dimensions.

### Items in Current Playlist

Files to Change	css/PC_HighRes.css, css/PC_LowRes.css, css/MCSv4.css, css/MCSControls.css
Classes	.PlaylistAdminContentList, .PlaylistAdminDiv, .btn_varWidth, v4DataProgramTitle, .SubtitleCell, .MenuCell, .MenuItem
Modify	Font, color, background-color, dimensions.

## Rebranding Other ETV Components

### *VBrick IP Receiver*

#### IPR List and Related HTML

Files to Change	css/MCS_Styles_stb.css, layers/mainElement-background-stb.inc
Classes	all

---

Modify	Font size, color, background, padding, etc.
HTML	Any files in: layer/ directory ending with "-stb.inc"

### *Amino Set Top Box*

#### **STB List and Related HTML**

Files to Change	MCS_Amino/css/A_classes.css, A_layout.css, MCSControls.css
Classes	All
Modify	Font size, color, background-color, dimensions, padding, etc.

### *VBrick IP Receiver*

#### **IPR List and Related HTML**

Files to Change	WMIPR/css//wmipr.css
Classes	All
Modify	Font size, color, background, padding, etc.

## NXG-to-VOD-W Content Migration

### *Topics in this section*

Creating an Asset List .....	171
Using the Migration Tool.....	172
Verifying the Migration .....	175

This chapter explains how to migrate MPEG-1 and MPEG-2 video files from a VBrick NXG (Linux) VOD server to a VBrick VOD-W (Windows) VOD server. This migration is a two-step process:

- ▼ To migrate NXG files
  1. First run the Linux script **VListAssets.sh** on the NXG VOD server to create an asset list that identifies all video files present on the server.
  2. Then run the migration tool to replicate these files on the VOD-W server.

### Creating an Asset List

Use the steps listed below to run a script that will create an asset list (see [Sample Asset List](#)) of all video files on the NXG server. **The script requires that the following files be FTPed to the NXG server.** These files are located in the Portal Server utilities folder at: [C:\Program Files\Vbrick\MCS\utils\NXGtoVODWMigrationTools](#)

[VListAssets.awk](#)

[VListAssets.sh](#)

- ▼ To FTP the files and run the script
  1. Open a Command Prompt on your PC and change directories to the folder with the files listed above.  
**FTP <NXG\_ip\_address>**
  2. Login as user = **vbrickuser**; password = **vbrickuser**  
**ftp> bin** to transfer the files in binary mode.  
**ftp> mput VBL\*** to transfer the script to the server. When prompted, answer **y** to allow the file transfer.  
**ftp> quit** to exit FTP.
  3. Telnet to the NXG server to run the script.  
**telnet <NXG\_ip\_address>**
  4. Login as user = **vbrickuser**; password = **vbrickuser**  
**chmod 777 VBL\*** to make the script files executable (FTP will not do this).  
**./VListAssets.sh** to run the script.
  5. Wait approximately two minutes until the script completes. When prompted for password, type the root password (default = **omnibase**) and press **Enter**. The file **nxg\_asset\_list** will be created in the current directory. The script should not generate any output. If it does, note the output for analysis by VBrick Support Services.

- 
6. Copy `nxd_asset_list` to the Portal Server machine or use an FTP URL in the **Assets** field of the Migration Tool. For example:  
`ftp://vbrickuser:vbrickuser@<server_ip_address>/nxd_asset_list`

### *Sample Asset List*

This snippet shows sample assets included in the file `nxd_asset_list`. Each asset is described by name and location.

```
<assets>
  <asset>
    <name>/demo/TestAutoIngest4.mpg</name>
    <location>/vbrick/content_links/20071005113535_1</location>
  </asset>
  <asset>
    <name>/1_MSNBC_05_16_07_16_12_41.mpg</name>
    <location>/vbrick/content_links/20071005113535_2</location>
  </asset>
  <asset>
    <name>/Rec9.mpg</name>
    <location>/vbrick/content_links/20071005113535_3</location>
  </asset>
</assets>
```

## Using the Migration Tool

The Migration Tool is used to migrate MPEG-1 and MPEG-2 video files from a VBrick NXG VOD server to a VBrick VOD-W VOD server. The original content remains on the NXG server and is not affected. The Migration Tool is a Windows-based application that is installed with the Portal Server installation and should be run on the Portal Server machine. Once you have created an asset file, use the following steps to actually migrate files to the VOD-W server. Note that the ingestion process on the VOD-W server is CPU and bandwidth intensive. You may want to run the migration during off-peak hours and increase the ingestion rate as explained below. Be sure to read the following important notes.

- 
- Note**
- Both the **Source** and **Destination** VOD servers must be defined in MCS and must be running.
  - You must create an MCS user (or configure MCSClient, the default user) that can access the **Destination** VOD-W server but *cannot* access the **Source** NXG server. See [Configuring Users](#) on page 107 for details. The MCS user must be configured as follows.
    - Allow Access to Specific VOD Servers – select only the destination VOD-W.
    - Allow Access to Specific VOD Content – select all VOD Folders.
    - Allow Content Publishing – select all Available Folders.
  - The Migration Tool will not run if SSL is enabled on the Portal Server. To disable SSL, re-comment the `web.config` file for Portal Server User pages *and* the Portal Server Admin pages. See [Configuring for SSL](#) on page 119 for details.
- 

### *Increasing the Ingestion Rate*

You can make the migration process substantially faster by increasing the rate at which files are ingested on the VOD-W server.



- ▼ To increase the ingestion rate
- 1. On the VOD-W server, go to **Start > Control Panel > InfoValue QuickVideo > QVCS > Advanced**.

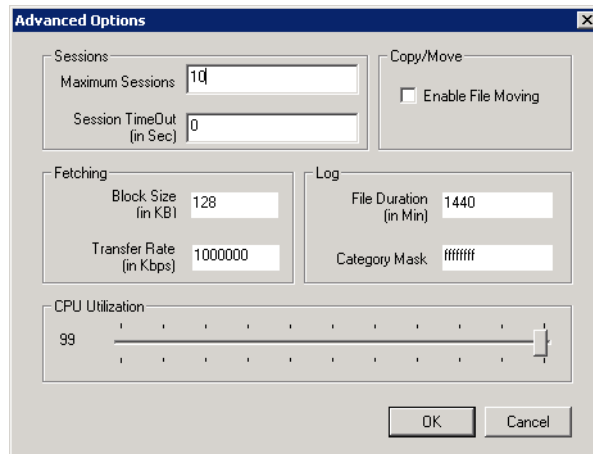

2. Set the **Transfer Rate** to **1000000** and click **OK**. Click **OK** again to exit.
3. When the content migration is complete, reset the **Transfer Rate** to the default (**10000**).

### *Running the Migration Tool*

- ▼ To migrate video files to the VOD-W
- 1. Launch the Migration Tool. Go to **C:\Program Files\Vbrick\MCS\utils\NXGtoVODWMigrationTools** and double-click on **VBMCSSReplicateContent.exe**
- 2. Complete all required fields as explained below.
- 3. Select **Save to File** to create a status file that will show which files were ingested successfully.
- 4. Click **Start** to begin the migration immediately, or use the scheduling options to run later.
- 5. If necessary, when the content migration is complete, reset the **Transfer Rate** to the default (**10000**).

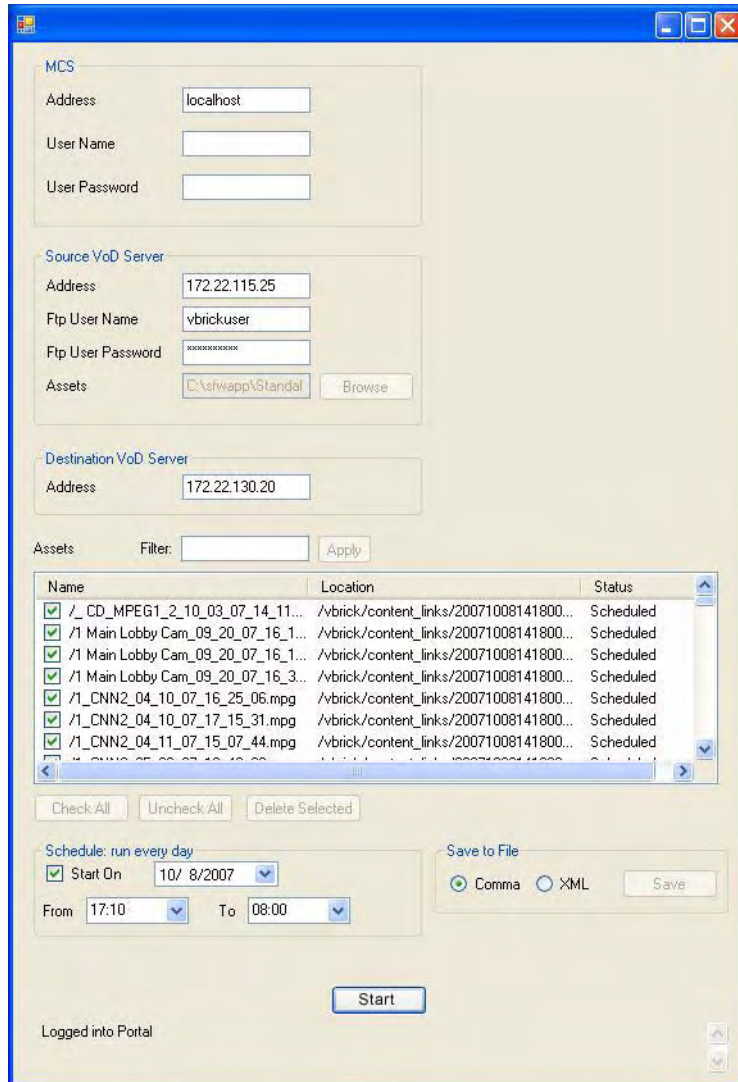

### MCS

Address	IP address of VBrick Portal Server.
User Name	User name for Portal Server.
User Password	User password for Portal Server.

### Source VoD Server

Address	IP address of source NXG server.
Ftp User Name	FTP user name of NXG server. Default = <b>vbrickuser</b>
Ftp User Password	FTP password of NXG server. Default = <b>vbrickuser</b>
Assets	Browse to the file <b>nxg_asset_list</b> or use an FTP URL in the following format:  <b>ftp://vbrickuser:vbrickuser@&lt;server_ip_address&gt;/nxg_asset_list</b>

### Destination VoD Server

Address	IP address of destination VOD-W server.
---------	---

Assets	
Filter	Optional. Enter an alphabetic substring to search for matching files and click <b>Apply</b> .
File Names	Select the video files to be migrated from the complete list of files in the asset list. Use <b>Check All</b> , <b>Uncheck All</b> , or <b>Delete Selected</b> as appropriate. Note that <b>Delete Selected</b> works with selected (i.e. highlighted) files and <i>not</i> checked files.
Schedule	
Start On	Start date. Default = unchecked. The tool will migrate files every day beginning at the specified hour.
From/To	The migration will run during the specified time period.
Save to File	This option saves a <b>status.xml</b> file that shows migration results. If some files fail to ingest during migration, you can point to this file in the <b>Assets</b> field and repeat the migration. <ul style="list-style-type: none"> <li>• Comma – save the status file as comma separated values. This can be displayed in a spreadsheet or an editor.</li> <li>• XML – save status file as an .xml file. This file is identical in format to the asset list (see <a href="#">Sample Asset List</a>) and can be used to repeat the migration.</li> </ul>
Start/Stop	Start a migration; stop a migration currently in progress. You may want to stop the migration and correct a problem if multiple failures are shown in the Status column. See <a href="#">Recovering from Migration Errors</a> below.

### ***Recovering from Migration Errors***

Migration errors are shown in the **Status** column. Once started, the migration will continue until each ingestion reports either success or failure. If you stop the migration, all queued ingestions are removed (click yes on the popup) from the Portal Server and you can correct the errors and restart the migration when ready.

If you ignore the popup window (click no on the popup), you will have to either remove queued ingestions manually from the Portal Server or wait until all ingestions are complete with either failure or success. Then you can fix the errors and restart. You may see duplicate asset file errors in the migration **Status** column. These errors indicate that the asset already exists on VOD-W and the Portal Server and can be safely ignored.

## **Verifying the Migration**

Use the **Save to File** (XML) option to create a **status.xml** file which lists the video files that failed to ingest. If some files fail to ingest during migration, you can point to this file in the **Assets** field and repeat the migration.



## Purchased Content Ingestion

### *Topics in this section*

Overview .....	177
Configuring IIS .....	177
Ingesting Purchased Content .....	180
Backing Up the Database .....	181

### Overview

EtherneTV users have the option of purchasing pre-packaged content from VBrick. If content was included on your original order, this purchased content is installed on your VOD servers prior to shipment. If content was not included with your original order, you will need to install this content on your VOD servers as explained here. *This procedure is highly technical and should be performed by a knowledgeable system administrator with suitable IT experience.* Note that VBrick does not support the ingestion of third-party content not purchased directly from VBrick.

The content package you purchased is shipped on a LaCie USB drive. If you open the USB drive in Windows Explorer, you will see that each content package is named by part number and text description. Each package has a corresponding Excel metadata spreadsheet describing the content in the package and a license file that contains content expiration data. The spreadsheet and license are used during the ingestion procedure. The Excel metadata spreadsheet for the package is inside the package folder with a name like **8000-0120 Clearvue HS MPEG Gold 7-17-08.xls**. You must copy this spreadsheet to your local C: drive. The license file has a name like **content\_34294950443.lic**. You must install the license using the Windows **Add or Remove Programs** utility. The Mass Ingestion Utility is installed with the Portal Server and is located in **C:\Program Files\VBrick\MCS\bin\MassIngestionUtils.exe**

---

**Note** Content Ingestion to an SSL-enabled VOD-W is not supported. To ingest content to an SSL-enabled VOD-W, first disable SSL and run the ingestion; then re-enable SSL when done. See [Configuring for SSL](#) on page 119 for more information.

---

### Configuring IIS

The following procedures explain how to ingest content to your VOD-W and/or VOD-WM servers. First you need to configure certain settings in IIS.

- ▼ To configure IIS for mass ingestion
- 1. Shutdown the Portal Server and attach the appropriate LaCie drive to a USB port.
  - a. Restart the server.
  - b. Copy **MassIngestionUtils.exe** and **MassIngestionUtils.exe.config** from the **\Utilities** directory on the LaCie drive to **C:\Program Files\VBrick\MCS\bin\** directory.
  - c. Copy **xlviewer.exe** from the **\Utilities** directory on the LaCie drive to the desktop. Then double click on **xlviewer.exe** to install Microsoft Office Excel Viewer 2003.

2. Open IIS Manager.
  - a. Expand the Local server and then the FTP server.

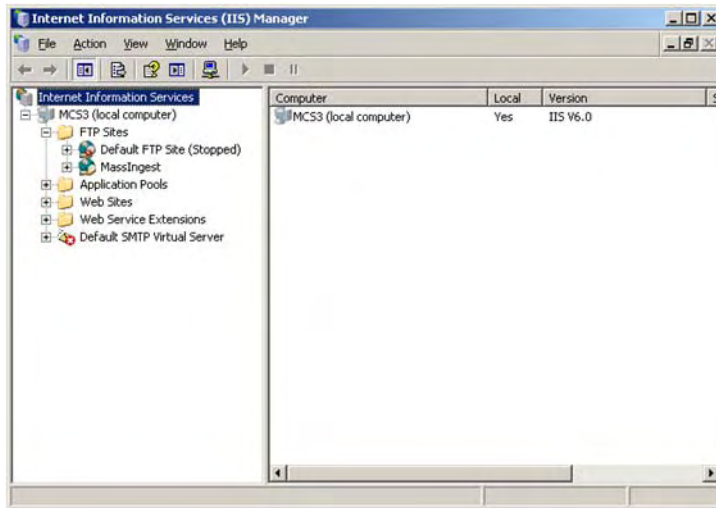

- b. Add an FTP site called **MassIngest**.

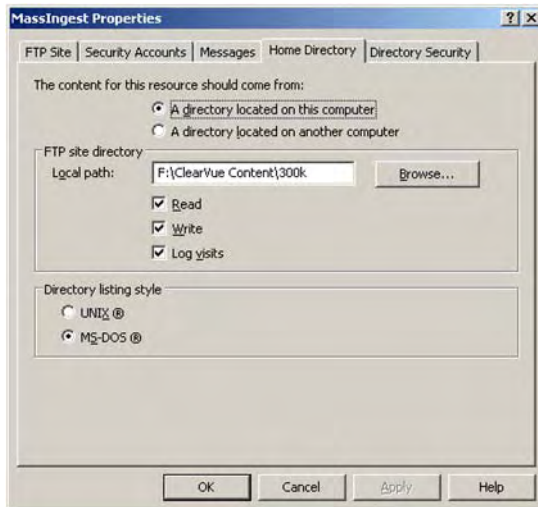

- c. Map the FTP site to the directory on the LaCie USB drive that has the video to be ingested.

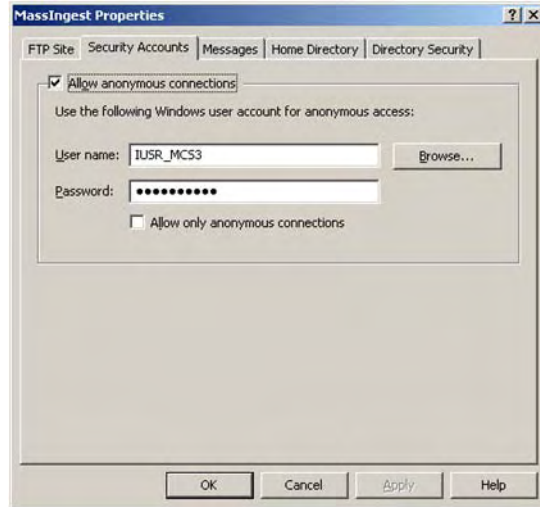

- d. Set permissions to allow for anonymous FTP and close IIS.
3. Copy the Excel spreadsheet from the flash drive to your C:\ drive.
4. Install the license file (for example [content\\_34294950443.lic](#)) using the Windows **Add or Remove Programs** utility.
  - a. Go to **Start > Control Panel > Add or Remove Programs > VBrick Media Control Server Suite**.
  - b. Click **Change/Remove** and select **Install/Replace the EtherneTV Content license file**.
  - c. Click **Next**, then browse to the file and click **Open**.
5. Manually close the window when done. See [Installing Serial Numbers and License Files](#) on page 15 for more information.

## Ingesting Content

### *Configuring a VOD-W Server*

VOD-W only. Use the following steps, prior to ingestion, to change the **Transfer Rate** from 10,000 to 1,000,000 Kbps. Make sure to change the ingestion limit back to 10,000 after all content has been ingested.

- ▼ To change the ingestion limit on a VOD-W
  1. Go to **Start > Control Panel**.
  2. Click on **VOD-W QuickVideo**.

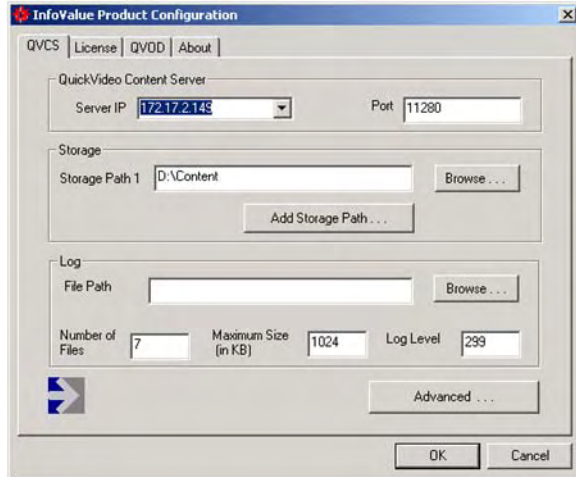

3. Click on the **Advanced** button.

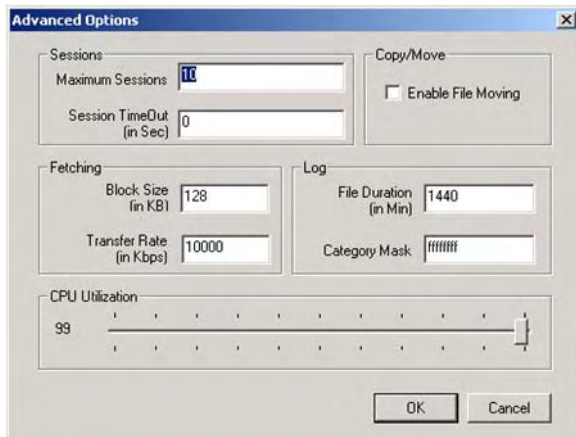

4. Change **Transfer Rate** from 10,000 to 1,000,000, click **OK** and **OK** again.
5. Reboot the VOD-W Server for the changes to take effect.

## *Ingesting Purchased Content*

- ▼ To ingest purchased content to your VOD servers
1. Run the `C:\Program Files\VBrick\MCS\bin\MassIngestionUtils.exe` program.
  2. When the window opens, go to **Options > Initiate Mass Ingestion**.
  3. When the Mass Ingestion utility starts:
    - a. Set **Local Video Content Path** to the actual path.
    - b. The **Ingest Source Directory** is `ftp://[Portal Server IP Address]/MassIngest`.
    - c. Set the **Metadata File Path** to the location of the Excel spreadsheet.
    - d. The **Sheet Name** should be `Sheet1`.
    - e. The **MCS Server IP** is the address of the Portal Server.
    - f. Select the **VoD Servers** to receive the content.
    - g. Press the **Validate** button.
    - h. Then press **Continue** and wait for the ingestion to complete. This may take from 2–8 hours.



4. After mass ingestion is complete, review the total results displayed on the Mass Ingestion utility. (The total results cannot be saved.) On the Portal Server, open Microsoft Office Excel Viewer 2003, view the Excel spreadsheet from the MCS C:\ drive and check for failures on columns A, C and E. The columns should be populated with True and if False is shown, a failure has occurred. This means that the video file with the False failed to ingest. Contact VBrick Support Services if any failures occur. Note: the .xls file will now contain failure information only and was modified during the ingestion process. **Be careful not to overwrite the original .xls file.**
5. When done, change the **Transfer Rate** on your VOD-W back to 10,000 Kbps. (See [Configuring a VOD-W Server](#) on page 179.)

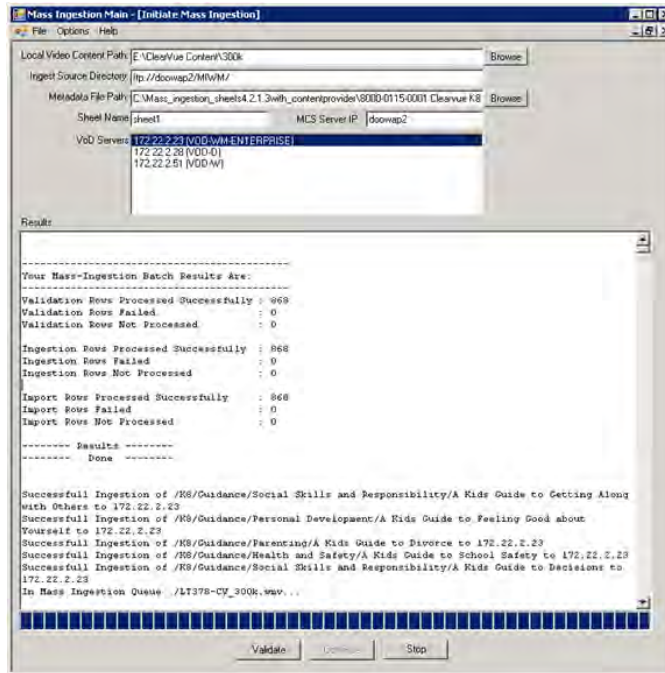

**Note** When a large ingestion completes, the utility may not respond to mouse commands for a few minutes. This is normal and for best results, wait a few minutes for it to recover.

## Backing Up the Database

Once Mass Ingestion is complete, it is recommended that you perform a full database backup. To ensure a successful database backup, you must follow the exact sequence of steps shown below. Also, since this process will interrupt any streaming video, you may want to schedule this procedure at night or during non-business hours.

**Note** If you purchased EtherneTV Backup, all key directories are backed up every ten minutes. With ETV Backup there is no need to perform a manual database backup.

- ▼ To backup the database
  1. Log into the Portal Server as the Administrator.

- 
2. The MySQL Service will need to be stopped in order to have a clean copy of the database. Go to **Start > Control Panel > Administrative Tools > Services**.
    - a. Right-click on **MySQL** in the right pane and select **Stop**. There will be a list of other services that will stop. Take note of these other services and select **Yes**.
    - b. The Service Control window will show the progress of the Services being stopped. After the services have stopped minimize the Services window.
  3. Open **My Computer** and save copies of the following directories (and the Metadata file) in **C:\VBrick Backup**.
    - C:\Program Files\MySQL\MySQL Server x.x\data**
    - C:\Program Files\VBrick\MCS\Images\Thumbnails**
    - C:\Program Files\VBrick\MCS\licenses**
  4. Copy the entire contents of the VBrick Backup directory to a flash drive and later burn a CD of these files.
  5. To restart the **Services**, maximize the **Services** window. Then right-click on **VBrick Object Starter** and select **Start**. This will start the **MySQL** services. If the EtherneTV Scheduler Module or other services were stopped above they will need to be started as well.

## Manual System Backup

**This chapter explains how to manually backup key system files and directories on the Portal Server. If you purchased EtherneTV Backup, this process is automatic. See [EtherneTV Backup](#) on page 145 for details.**

The EtherneTV Portal Server uses MySQL to manage the database of users and groups, and also the video *information* related to content on the VOD Servers. Note that this procedure backs up information in the MySQL database and key directories only. *It does not back up any video content you may have stored on attached VOD servers.* (To back up video content, you will likely need a backup strategy and a robust storage capability.) Use this procedure when removing the VOD server for troubleshooting purposes, or when upgrading the software, in order to avoid the loss of this content information. This procedure can also be helpful for load balancing and failover. It can simplify the task of maintaining multiple servers with the same information. Note that *In order to backup database files, you will need administrative access to the ETV Portal Server and a safe location to store the backup database and files.*

### Topics in this section

System Backup . . . . .	183
System Restore . . . . .	184

## System Backup

To ensure a successful system backup, you must follow the exact sequence of steps shown below. Also, since this process will interrupt any streaming video, you may want to schedule this procedure at night or during non-business hours.

- ▼ To back up the system
  1. Log into the Portal Server as the Administrator.
  2. The MySQL Service will need to be stopped in order to have a clean copy of the database. Go to **Start > Control Panel > Administrative Tools > Services**.
  3. Right-click on **MySQL** in the right pane and select **Stop**. There will be a list of other services that will stop. Take note of these other services and select **Yes**.
  4. The Service Control window will show the progress of the Services being stopped. After the services have stopped minimize the Services window.
  5. Open **My Computer** and save copies of the following directories in a safe backup location.

C:\Program Files\MySQL\MySQL Server x.x\data  
C:\Program Files\VBrick\MCS\licenses  
C:\Program Files\VBrick\MCS\MCSPresentations  
    or D:\VBrick\MCSPresentations  
C:\Program Files\VBrick\MCS\Presentations  
    or D:\VBrick\Presentations  
C:\Program Files\VBrick\MCS\Logs\  
C:\Program Files\VBrick\MCS\nsc

---

C:\Program Files\VBrick\MCS\sdp  
C:\Program Files\VBrick\MCS\StationIcons  
C:\Program Files\VBrick\MCS\Images\Thumbnails

6. To restart the **Services**, maximize the **Services** window.
7. Right-click on the **VBrick Object Starter** and select **Start**. This will start the **MySQL** services. If the EtherneTV Scheduler Module or other services were stopped in Step 3 above they will need to be started as well.

## System Restore

To ensure a successful system restore, it is critical that you follow the exact sequence of steps shown below. Also, since this process will interrupt any streaming video, you may want to schedule this procedure at night or during non-business hours.

---

**Note** The database cannot be restored from a different version number of ETV Portal Server or from the same version number after additional features (for example ETV Scheduler) have been installed. To ensure a successful restore, always perform a backup after an upgrade or after installing new features. Restore the database only to an ETV Portal Server instance with the same version number and with the same features installed.

---

▼ To restore the system

1. Log into the Portal Server as the Administrator.
2. The MySQL Service will need to be stopped in order to have a clean recovery of the database. Go to **Start > Control Panel > Administrative Tools > Services**.
3. Right-click on **MySQL** in the right pane and select **Stop**. There will be a list of other services that will stop. Take note of these other services and select **Yes**.
4. A Service Control window will show the progress of the Services that will be stopped. After the services have stopped, minimize the **Services** window.
5. Open **My Computer** and restore the following directories from the backup location.

C:\Program Files\MySQL\MySQL Server x.x\data  
C:\Program Files\VBrick\MCS\licenses  
C:\Program Files\VBrick\MCS\MCSPresentations

or D:\VBrick\MCSPresentations

C:\Program Files\VBrick\MCS\Presentations

or D:\VBrick\Presentations

C:\Program Files\VBrick\MCS\Logs\  
C:\Program Files\VBrick\MCS\nsc  
C:\Program Files\VBrick\MCS\sdp  
C:\Program Files\VBrick\MCS\StationIcons  
C:\Program Files\VBrick\MCS\Images\Thumbnails

6. To start the Services, maximize the **Services** window.
7. Right-click on the **VBrick Object Starter** and select **Start**. This will start the **MySQL** services. If the EtherneTV Scheduler Module or other services were stopped in Step 3 above they will need to be started as well.

## VBrick Internet Streaming

### *Topics in this section*

Overview .....	185
Portal Server Hosting.....	186

### Overview

The VBrick Internet Streaming is available for those users who wish to extend the ability to view live events to Internet clients. This document concentrates on users who intend to use the Internet Streaming service to provide additional services in Portal Server installations. In all cases, the basic scenario is that a user wants to schedule an event via the Portal Server, and wants the event to be made available to Internet users via a hosted service. VBrick Internet Streaming capabilities allow customers to extend the reach of their video to the Internet. In order to do this, the customer needs to do the following:

1. Choose whether they want end users to view the video through the Portal Server or via a different external web page (for example their external web site or VBrick's VBOSS site).
2. Purchase streaming bandwidth from a Content Distribution Network (CDN). VBrick offers this through our VBOSS service or the customer can purchase their own.
3. Configure the VBrick to send the stream to the CDN

Potential viewers fall into two categories as follows:

- Authenticated Internet-based Portal Server clients – In this option, streams are viewed via the Portal Server interface (multicast or unicast) and all viewers can be authenticated. In this mode, the Portal Server must be in the DMZ to allow access to the Portal Server web pages from the Internet.
- Non-Portal Server Internet web page viewers – These viewers are notified via e-mail that a stream is available. VBrick's Internet Streaming solution includes a bandwidth allowance and a hosted URL for live viewing. The service is available with a Windows Media (WM) VBrick appliance included or may be utilized by Portal Server customers who have purchased WM VBrick appliances. The viewing screen is configured as part of the VBOSS (VBrick Online Streaming Server) interface. Access to this interface may be limited via a password. For more information about customizing and using VBOSS, see the *VBOSS Broadcast Publisher Guide*.

### *Streaming Service Workflow*

The following information is required in order to properly configure the VBrick WM appliance. For customers who purchase the VBOSS service, this information will be provided to you when you order the service. Other customers need to obtain this information from their CDN. When you purchase the VBrick Online Streaming Service, the VBrick administrator will provide the following host configuration information:

- a. Server Name/IP and Port

- b. Publishing Point Name
- c. Publishing Point User Name
- d. Publishing Point Password
- e. Publishing Point Viewing URL
- f. Hosted Page Viewing URL

The information labelled a–c above is entered on the VBrick appliance Push configuration page. When the event is initiated (via the Scheduler), the Portal Server turns on the Push transmit and streams to the remote publishing point. Internal authenticated users are directed to view the multicast/unicast directly from the VBrick encoder appliance. **You can only initiate the push via a Portal Server "schedule" that turns on a local multicast or unicast server.** External viewers are directed to the publishing point of the service provider. If the event presenter wishes to provide event access to non-authenticated viewers via an e-mail, he would e-mail the interested viewers the hosted page viewing URL (f). This mode does not require access to the Portal Server and the video will be launched using a Windows Media Player.

## Portal Server Hosting

### VBrick Configuration

#### VBrick Push Configuration

Regardless of whether you are serving remote Portal Server clients or non-Portal Server Internet web page viewers, the VBrick must be configured to push the stream to the provided destination hosting URL. The information in a–c should be entered in the appropriate fields as shown below. See the *WM Appliance Admin Guide* for more information.

**Configuration: Encoder**

Template Video Audio Multicast Announce(SAP) Server Archiver Push

HTTP Push - Slot1

Maximum Push Destinations

Estimated Push Bit Rate 1219784

Total Estimated Push Bit Rate 0 REFRESH

Include Video Rate1

Include Audio Rate1

Include Closed Caption and Metadata

APPLY REVERT DEFAULTS

Index	Enable	Server:Port	Publishing/Mount Point	CopyFromPublishingPoint	Auto Remove
1	Disabled ▾				Disabled ▾

APPLY REVERT DEFAULTS

Figure 23. VBrick Push Configuration Page

Maximum Push Destinations	One push destination is required for this application.
Enable	Use to enable HTTP Push. Normally this is left as Disabled for this application. The Scheduler will set this field to enabled when the schedule starts.
Server:Port	Enter the information from (a) Server Name/IP and Port from above.
Publishing/Mount Point	Enter the information from (b) Publishing Point Name
Copy From Publishing Point	Leave blank.
Auto Remove	Leave blank.
User Name	Enter the information from (c) Publishing Point User Name
Password	Enter the information from (d) Publishing Point Password
Domain Name	Leave blank.

### VBrick Announce Configuration

- ▼ To configure the VBrick announce
  1. Launch IWS, then go to Configuration: Encoder > Server and scroll to bottom of page.
  2. Set the **Stream Advertisement** to **Push to Microsoft Reflector** as shown below.
  3. Enter the Portal Server IP Address in the **IP Address or Host Name** field.
  4. If you wish to provide viewing to remote Portal Server clients, enter (e) in **URL** field.

Announce External Server -- Slot1	
Transmit	<input checked="" type="checkbox"/> Enabled
Stream Advertisement	Push to Microsoft Reflector
Retransmit Time(sec)	25
Time To Live	64
Type Of Service	0
IP Address or Host Name	
Port	9878
URL	

**Figure 24.** Configuration: Encoder > Server > Announce(SAP)

IP Address or Host Name	The Portal Server IP address or broadcast IP.
URL	Enter (e) the Publishing Point URL.

### Portal Server Configuration

#### Portal Server Admin Configuration

- ▼ To configure the Portal Server
  1. Go to Global Settings > Global Assignments > Assign LAN/Internet Address Range(s).

2. Click on **Specify LAN Address Range(s)** and enter the address range of your local LAN. Internal users are identified by this range. Note: the VBrick encoder IP Address must be in this range.

## Portal Server User Configuration

If authentication is enabled on the Portal Server, users must be authenticated and given Live Channel Privileges. See the *Portal Server Admin Guide* for more information.

## Portal Server Scheduler Configuration

A live broadcast can only be initiated using the Portal Server Scheduler component. A stream will be pushed to the configured destination, from your VBrick appliance, at the configured date and time. You will also need to enable **Ext. SAP** and **HTTP Push** as explained below.

- ▼ To push the stream via the scheduler
  1. Launch the Scheduler and go to Schedule: **Live Broadcast**
  2. For **Video Source** select **VBrick**.
  3. Highlight your WM VBrick network appliance in the list of VBrick Host Names.
  4. If the local LAN is multicast-enabled select a multicast destination, otherwise select unicast destination.
  5. Go to **Advanced Settings** and enable **HTTP Push**.
  6. If you wish to allow access to remote Portal Server clients, Enable the **EXT SAP**, otherwise leave this disabled.
  7. Schedule End options should be left as **Disabled**.

► **Advanced Settings**

Host Name: **Chris-WM** IP Address: **172.22.115.3**

Schedule Start Options -

Program Name:

Destination:  Template:

IP Address:  Port:  Transmit:

Ext. SAP:  HTTP Push:

Schedule End Options -

Transmit:  Ext. SAP:  HTTP Push:

**Figure 25.** Portal Server Scheduler Page – Advanced Options







VBrick Systems, Inc.  
12 Beaumont Road  
Wallingford, Connecticut 06492, USA

## Free Manuals Download Website

<http://myh66.com>

<http://usermanuals.us>

<http://www.somanuals.com>

<http://www.4manuals.cc>

<http://www.manual-lib.com>

<http://www.404manual.com>

<http://www.luxmanual.com>

<http://aubethermostatmanual.com>

Golf course search by state

<http://golfingnear.com>

Email search by domain

<http://emailbydomain.com>

Auto manuals search

<http://auto.somanuals.com>

TV manuals search

<http://tv.somanuals.com>