

Transport GT14

B2933



Service Engineer's Manual

PREFACE

Copyright

This publication, including all photographs, illustrations, and software, is protected under international copyright laws, with all rights reserved. Neither this manual, nor any material contained herein, may be reproduced without written consent of the manufacturer.

Copyright 2007

Version 1.0

Disclaimer

Information contained in this document is furnished by TYAN Computer Corporation and has been reviewed for accuracy and reliability prior to printing. TYAN assumes no liability whatsoever, and disclaims any express or implied warranty, relating to sale and/or use of TYAN products including liability or warranties relating to fitness for a particular purpose or merchantability. TYAN retains the right to make changes to product descriptions and/or specifications at any time, without notice. In no event will TYAN be held liable for any direct or indirect, incidental or consequential damage, loss of use, loss of data or other malady resulting from errors or inaccuracies of information contained in this document.

Trademark Recognition

All registered and unregistered trademarks and company names contained in this manual are property of their respective owners including, but not limited to the following.

TYAN and Transport GT14 B2933 are trademarks of TYAN Computer Corporation.

AMD, Opteron, Athlon, and combinations thereof are trademarks of AMD Corporation.

AMI and AMIBIOS are trademarks of AMI Technologies.

Microsoft and Windows are trademarks of Microsoft Corporation.

SuSE is a trademark of SuSE AG.

Marvell is a trademark of Broadcom Corporation and/or its subsidiaries.

XGI and XG20 are trademarks of XGI Corporation

nVIDIA and nForce are trademarks of NVIDIA Corporation.

IBM, PC, AT, PS/2 are trademarks of IBM Corporation.

Winbond is a trademark of Winbond Electronics Corporation.

Portable Document Format (PDF) is a trademark of Adobe Corporation.

Federal Communications Commission (FCC)



Notice for the USA Compliance Information Statement (Declaration of Conformity Procedure) DoC FCC Part 15: This device complies with part 15 of the FCC Rules

Operation is subject to the following conditions:

- 1) This device may not cause harmful interference, and
- 2) This device must accept any interference received including interference that may cause undesired operation. If this equipment does cause harmful interference to radio or television reception, which can be determined by turning the equipment off and on, the user is encouraged to try one or more of the following measures:
 - Reorient or relocate the receiving antenna.
 - Increase the separation between the equipment and the receiver.
 - Plug the equipment into an outlet on a circuit different from that of the receiver.

Consult the dealer on an experienced radio/television technician for help.

Notice for Canada

This apparatus complies with the Class B limits for radio interference as specified in the Canadian Department of Communications Radio Interference Regulations. (Cet appareil est conforme aux normes de Classe B d'interference radio tel que specifie par le Ministere Canadien des Communications dans les reglements d'ineteference radio.)



Notice for Europe (CE Mark) This product is in conformity with the Council Directive 89/336/EEC, 92/31/EEC (EMC).

CAUTION: Lithium battery included with this board. Do not puncture, mutilate, or dispose of battery in fire. Danger of explosion if battery is incorrectly replaced. Replace only with the same or equivalent type recommended by manufacturer. Dispose of used battery according to manufacturer instructions and in accordance with your local regulations.

About this Manual

This manual provides you with instructions on installing your Transport GT14. This manual is intended for experienced users and integrators with hardware knowledge of personal computers.

This manual consists of the following parts

- Chapter 1:** Provides an Introduction to the Transport GT14 B2933 barebones, packing list, describes the external components, gives a table of key components, and provides block diagrams of the system.
- Chapter 2:** Covers procedures on installing the CPU, memory modules, a PCI Express card, and hard drives.
- Chapter 3:** Covers removal and replacement procedures for pre-installed components
- Appendix:** Describes the differences between mainboard BIOS and system BIOS. Provides the cable connection tables for reference of system setup. Instructions on installing the SMDC card and reversing the GT14 chassis are also provided.

For information on the mainboard, please refer to the attached mainboard user's manual. You can find the detailed description about jumper and BIOS settings from the motherboard manual.

SAFETY INFORMATION

Before installing and using the Transport GT14, take note of the following precautions:

- Read all instructions carefully.
- Do not place the unit on an unstable surface, cart, or stand.
- Do not block the slots and opening on the unit, which are provided for ventilation.
- Only use the power source indicated on the marking label. If you are not sure, contact the Power Company.
- The unit uses a three-wire ground cable, which is equipped with a third pin to ground the unit and prevent electric shock. Do not defeat the purpose of this pin. If your outlet does not support this kind of plug, contact your electrician to replace your obsolete outlet.
- Do not place anything on the power cord. Place the power cord where it will not be in the way of foot traffic.
- Follow all warnings and cautions in this manual and on the unit case.
- Do not push objects in the ventilation slots as they may touch high voltage components and result in shock and damage to the components.
- When replacing parts, ensure that you use parts specified by the manufacturer.
- When service or repairs have been done, perform routine safety checks to verify that the system is operating correctly.
- Avoid using the system near water, in direct sunlight, or near a heating device.
- Cover the unit when not in use.

Table of Contents

Chapter 1: Overview

1.1	About the Transport GT14 B2933	1
1.2	Product Model	1
1.3	Features	2
1.4	Unpacking	4
1.5	About the Product	7
1.5.1	Front View	7
1.5.2	Rear View	7
1.5.3	LED Definition	8
1.5.4	Internal View	9
1.5.5	Motherboard Block Diagram	10
1.5.6	Motherboard Layout	11
1.5.7	FRU List	13

Chapter 2: Setting Up

2.0.1	Before You Begin	17
2.0.2	Work Area	17
2.0.3	Tools	17
2.0.4	Precautions	18
2.1	Installing Motherboard Components	19
2.1.1	Removing the Top Chassis Cover	19
2.1.2	Installing the CPU and Heatsink	20
2.1.3	Installing the Memory	22
2.1.4	Installing the PCI-E Card	25
2.2	Installing the 3.5" Hard Drive	27
2.2.1	Installing a 3.5" Hard Drive (front location)	27
2.2.2	Installing a 3.5" Hard Drive (rear location)	30
2.3	Installing the 2.5" Hard Drive	33
2.3.1	Installing a 2.5" Hard Drive (front location)	33
2.3.2	Installing a 2.5" Hard Drive (rear location)	36
2.4	Installing Dual 2.5" Hard Drives (Option)	39
2.4.1	Installing Dual 2.5" Hard Drives (front location)	39
2.4.2	Installing Dual 2.5" Hard Drives (rear location)	44
2.5	Rack Mounting	47
2.5.1	Installing the Server in a Rack (with Rail kit A)	48
2.5.2	Installing the Server in an Open Rack (with Rail kit B)	53
2.6	LCD Software Setup	56
2.6.1	Configuring the System	56
2.6.2	M1000 Driver Installation for Windows	56
2.6.3	M1000 Driver Installation for Linux	56
2.7	LCD Console	57

2.7.1	Key Definition	57
2.7.2	DOS Mode and Windows Mode	58
2.7.3	Linux Mode	61

Chapter 3: Replacing Pre-Installed Components

3.1	Introduction	63
3.1.1	Work Area	63
3.1.2	Tools	63
3.1.3	Precautions	64
3.2	Disassembly Flowchart	65
3.3	Removing the Top Chassis Cover	66
3.4	Replacing Motherboard Components	67
3.4.1	Disconnecting All Motherboard Cables	67
3.4.2	Removing the Motherboard	68
3.5	Replacing the LCD Module and LED Board	69
3.5.1	M1017 LED Board Features	72
3.5.2	M1017 LED Board Connector Pin Definition	72
3.6	Replacing the USB Board	73
3.6.1	USB Board Features	74
3.6.2	USB Board Connector Pin Definition	74
3.7	Replacing the Cooling Fans	75
3.8	Replacing the Power Supply	77

Appendix I: BIOS Differences

Appendix II: Cable Connection Tables

Appendix III: Installing the SMDC Card

Appendix IV: Installing the M2061 Riser Card

Technical Support

Chapter 1: Overview

1.1 About the Transport GT14 B2933

Congratulations on your purchase of the TYAN Transport™ GT14 B2933, a highly-optimized rack-mountable barebone system. The Transport GT14 B2933 is designed to support up to 2 AMD® Athlon™ F Opteron™ 2000 1207-pin processors, providing a rich feature set and incredible performance. Leveraging advanced technology from AMD®, the Transport GT14 B2933 server system is capable of offering scalable 32 and 64-bit computing, high-bandwidth memory design, and a lightning-fast PCI-Express bus implementation. The Transport™ GT14 B2933 not only empowers your company in today's demanding IT environment but also offers a smooth path for future application usage.

TYAN is also proud to deliver the Transport™ GT14 B2933 in SATA flavor while supporting two (2) internal hard drives. The Transport™ GT14 B2933 uses TYAN's latest tooling-made chassis featuring a robust structure, tool-less and modularized design, and a solid mechanical enclosure. All of these provide the Transport™ GT14 B2933 the power and flexibility to meet the needs of nearly any server application.

1.2 Product Model

Model	HDD Bays	Hot-Swap Support
B2933G14S2M	Internal, 2 HDDs	No



1.3 Features

Enclosure

- Industry 19" rack-mountable 1U chassis
 - Supports the following HDD combination:
 - (1) 3.5" HDD + (1) 2.5" HDD
 - (2) 3.5" HDD (without PCIE support)
 - (3) 2.5" HDD (optional)
 - (4) 2.5" HDD (without PCIE support) (optional)
 - Dimensions:
 - With Bezel:
D 15.5 x W 17.2 x H 1.7 inch (394x436x43.7mm)
 - Without Bezel:
D 14.4 x W 17.2 x H 1.7 inch (365x436x43.7mm)
-

Processors

- Dual 1207-pin ZIF sockets
 - Supports up to 2 AMD[®] F Opteron™ 2000 series processors
 - Up to 1.0 GHz Hyper-Transport link support
-

Chipsets

- nVIDIA NFP3600 chipset
 - SMSC SCH5017
-

Memory

- Dual memory channels
 - Supports up to eight (4+4) DDR2 667/533/400 DIMMs
 - Up to 32 GB of registered, ECC memory
-

Expansion Slot

- One (1) PCI Express slot with x16 signal
-

Back I/O Ports

- Stacked PS/2 mouse & keyboard ports
 - Stacked two (2) USB 2.0 ports
 - One (1) 9-pin COM port
 - One (1) 15-pin VGA port
 - Two (2) LAN ports
-

Front Panel Features

- I/O: (2) USB 2.0 ports
 - LED indicators
 - Power LED
 - (2) LAN LEDs
 - HDD active LED
 - ID LED
 - Warning LED
 - Switches
 - Power switch
 - ID switch
-

Integrated Serial ATA II

- Supports up to 4 Serial ATA ports running at 3.0Gb/s
 - Serial ATA II specification compliant
 - nVidia Media Shield™ RAID supports for RAID 0, 1, 0+1, 5, JBOD
-

Storage

- Hard Disk Drives:
 - (1) 3.5" HDD + (1) 2.5" HDD
 - (2) 3.5" HDD (without PCIE support)
 - (3) 2.5" HDD (optional)
 - (4) 2.5" HDD (without PCIE support) (optional)
-

Networking

- Two NFP3600 integrated MAC with 2 Marvell 88E11116 port Gigabit Ethernet PHY
 - Integrated TCP offload Engine (TOE)
 - IEEE802.3 compliant, WOL/PXE support
 - Pin header for front panel LAN LED
-

Video

- XGI VolariZ7 (XG20)
 - 16MB Frame Buffer of video memory
-

Motherboard

- TYAN S2933G2NR
 - 10.4x9.4 inch (265mmx240mm) for GT14 1U chassis
 - 8 layers PCB
-

BIOS

- AMI BIOS on 8Mbit LPC Flash ROM
- Serial Console Redirect
- USB boot supported
- ACPI 2.0 supported
- PnP, DMI2.0, WfM2.0 power management

System Management

- SMSC SCH5017 w/ 2xEMC6D103
- 8x4 pin system fan headers with tachometer input and auto fan control
- Temperature and voltage monitoring
- Watch dog timer
- Port 80 code display LED

Server Management

- TYAN M3291, IPMI 2.0 (2x25pin) Remote system Mgmt card
- Renesas H8S2167 BMC controller
- BT, KCS, Logging support
- IPMI-over-LAN
- Remote power on/off
- Support TSM and LCM module

System Cooling

- (4) 4028 fans
- (1) passive CPU heatsink

Power Supply

- EPS 400W, 1U, 12V (24pin+8pin+4pin) power connectors

Regulatory

- FCC Class B (Declaration of Conformity)
- CE (Declaration of Conformity)

Environment Temperature

- Operating temperature 5°C~35°C
- Non-operating temperature -40°C ~ 70°C

1.4 Unpacking

If any items are missing or appear damaged, contact your retailer or browse to TYAN's Web site for service:
<http://www.tyan.com>.

The Web site also provides information on other TYAN products, plus FAQs, compatibility lists, BIOS settings, and more.



1 x Tyan driver CD



Power Cables
Left to right: Europe, US



HDD Screws



Barebone & Mainboard Manual



Air Duct with Heatsink x 1



LCD Bracket x 1



SATA Cable x 4



Mounting Ear Kit



Power SATA Adapter x 1

Rail Kit

Rail kit options: A, B, C

The following three rail kits are available to rackmount your GT14 B2933.

A. Rail for 4-post rack



Sliding Rails x2

Sliding Brackets x4 (Front L-Bracket x2, Rear L-Bracket x2)

Mounting Brackets x 4

M4-4L screw x 18pcs

M5-8L screw x 10pcs

M5-15L screw x 4pcs

B. Rail for 2-post rack



Inner Rail Brackets x2 (including screws)

Mounting Brackets x2

M5-8L screw x 14pcs

M4-4L screw x 8pcs

C. Rail for 4-post rack



- Inner Rails x2**
- Post Slide Mounting Brackets x4**
- Assembled Outer Sliding Rails x2**
- M4-4L screw x 30pcs**
- M5-8L screw x 10pcs**
- M5-15L screw x 4pcs**

NOTE: For detailed information on rail kit of C, please contact our sales representative.

1.5 About the Product

The following views show you the product.

1.5.1 Front View

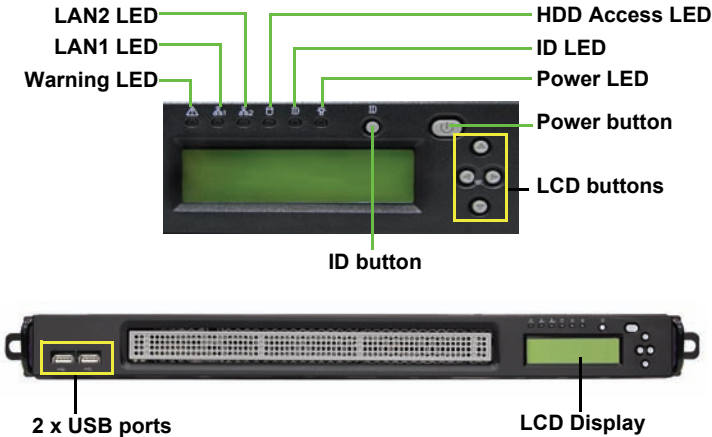

1.5.2 Rear View

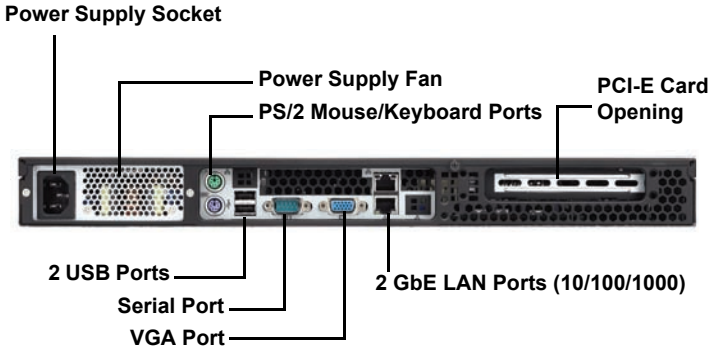

1.5.3 LED Definition

Front Panel

LED	Color	State	Description
Power	Green OFF	ON OFF	Power ON Power OFF
HDD Access	Amber OFF	Random Blink OFF	HDD access No disk activity
LAN1/LAN2 Activity	Green Green OFF	ON Blinking OFF	LAN linked LAN accessing No LAN linked
Warning	Red OFF	ON OFF	System fails (fan fail/ over voltage) Normal
ID LED	Blue OFF	ON OFF	System is identified System is not identified

Rear I/O LED

LED	Color	State	Description
LAN Linkage/ Activity (Left Side)	Green Green OFF	ON Blinking OFF	LAN linked LAN accessing No LAN linked
LAN Mode (Right Side)	Orange Green OFF	ON ON OFF	1000Mb mode 100Mb mode 10Mb mode or No LAN linked

1.5.4 Internal View

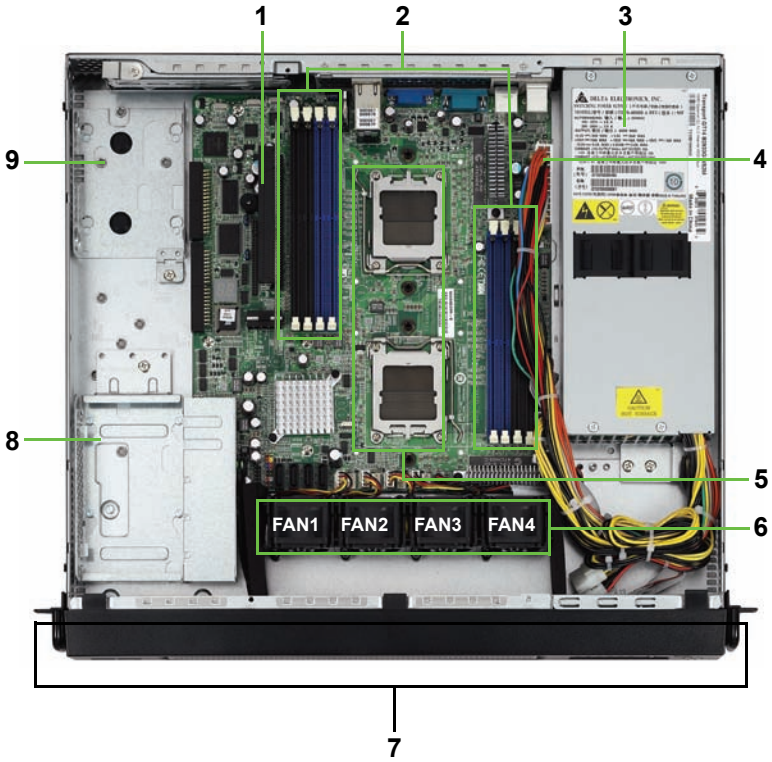

- 1. M2083 PCI-E Riser card
- 2. Memory slots
- 3. EPS Power supply
- 4. Power connector
- 5. CPU sockets
- 6. Fans (Left to Right: Fan1, Fan2, Fan3, Fan4)
- 7. Front LED panel
- 8. 3.5" Hard disk drive bracket
- 9. 2.5" Hard disk drive bracket

1.5.5 Motherboard Block Diagram

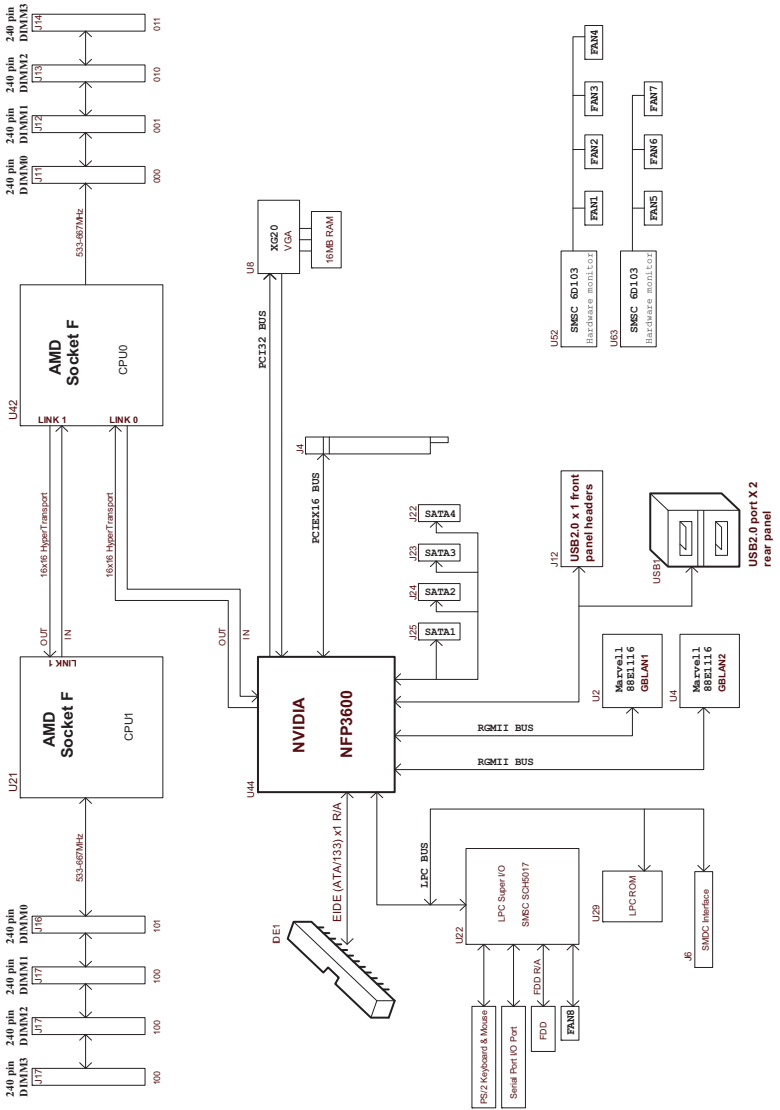



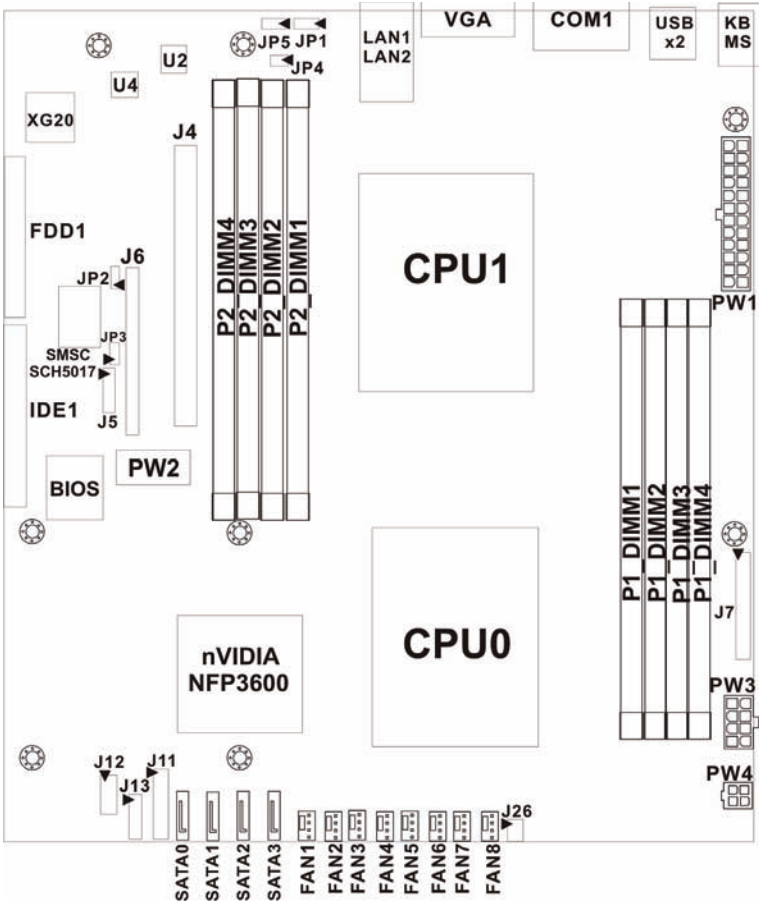







1.5.6 Motherboard Layout























Jumpers & Connectors

Jumper /Connector	Function
J14~J21	4-pin Fan Connectors with Speed Control J21: FAN1, J20: FAN2, J19: FAN3, J18: FAN4 J17: FAN5, J16: FAN6, J15: FAN7, J14: FAN8
J11	Front Panel Header
J6	SMDC Connector
J5	Barebone FAN Tachometer Pin Header
J12	Front Panel USB2.0 Connector
J26	LCM Connector
JP1	Onboard ID LED Enable/Disable Jumper Close Pin 1 & Pin 2: Enable (Default) Close Pin 2 & Pin 3: Disable
JP2	Onboard VGA Enable/Disable Jumper Close Pin 1 & Pin 2: Enable (Default) Close Pin 2 & Pin 3: Disable
JP3	Clear CMOS Jumper Close Pin 1 & Pin 2: Normal (Default) Close Pin 2 & Pin 3: Clear

1.5.7 FRU List

Item	Model Number	Picture	Quantity	Description
Standard Parts				
Motherboard	S2933G2NR		1	Dual 1207-pin ZIF sockets. Supports up to 2 AMD® F Opteron™ 2000 series processors.
Chassis Unit	CCHA-0220		1	Chassis Unit; for GT14 B2933
Power Supply	CPUS-0280		1	TF-Delta DPS-400BBA; 1U PSU
FAN	CFAN-0270		4	40*40*28mm, 4P, 14700RPM, 110mm, SANYO DENKI
Heat Sink & Cooler	CHSK-0290		1	TF-HEATSINK WITH FAN DUCT; CU, GT14 B2933
Backplane	M1017		1	TF-Front Panel Board
Riser Card	M2083		1	PCI-E X16 1U riser card
LCD Bracket	CMPT-0090		1	LCM Front Main-BKT with Button Assy
	CMPT-0091		1	LCM Front Main BKT with Standoff Assy
	CMPT-0080		1	Rear BKT with Bezel
LCD	M1000		1	TF-BM; GT24-M1000, LCD MODULE, R03

Item	Model Number	Picture	Quantity	Description
Mounting Ear Kit	CEAR-0120		1	Mounting Ear Kit, for GT14
Cable Set	CCBL-0340		1	TF-TYAN Front Panel Control Board Cable HS 2X14P/ HS 2X14P, L=250mm (Flat Cable)
	CCBL-035A		1	TF-USB Cable USB 2.0 Cable 2*5P K10P P2.54/2*5P K10P P2.54, L=200mm, GT14 B2933
	CCBL-0604		1	TF-LCM Cable 2.54Pitch, 2*3Pin, L=470mm, GT14 B2933
	CCBL-0468		1	TF-Power SATA Cable, B4P(M)/ SATA(F)*2, L=170mm/60mm, GT14 B2933
	CCBL-0326		4	TF-SATA Cable Black, HS/180-HS/180, L=250mm, GT24 B2932
	CCBL-0280		1	A/C power cord, L=1830mm, US type
	CCBL-0290		1	A/C power cord, L=1830mm, Germany type
3.5" Single HDD Bracket	CHDT-0120		1	TF-3.5" HDD bracket
Bezel	CFBZ-0120		1	Front bezel assembly chassis

Item	Model Number	Picture	Quantity	Description
Optional Parts				
Rack Mounting Part	CRAL-0110		1	GT14 Standard Rail Kit; Rail for 4-post
	CRBK-0030		1	GT14 Open Rail Kit; Rail for 2-post
	CRAL-0111		1	GT14 Dual Rail Kit; Rail for 4-post with 2 barebones
Cable Set	CCBL-046D		1	TF-Cable Assy; Power SATA Cable B4P(F)/SATA(M)*2, L=60mm/60mm, GT14 B2933
	CCBL-046E		1	TF-Cable Assy; Power Cable B4P(F)/B4P*2(M), L=120mm/70mm, GT14 B2933
	CCBL-046F		1	TF-Cable Assy; Power Cable B4P(F)/B4P*1, S4P*1(M), L=70mm/80mm, GT14 B2933 for M2061 riser card
	CCBL-0625		1	TF-Cable Assy; SMDC Cable 2*25P, P2.0, L=700mm, GT14 B2933
Riser Card	M2061		1	TF-Riser BD; M2061/PCI-E TO PCI-X RISER, R02
SMDC Kit	M3291		1	TF-SMDC; M3291-HWT/R03
2.5" Dual HDD Bracket	CHDT-0110		1	TF-2_5_HDD_BKT_ASSY;FOR_DUAL,GT14

Item	Model Number	Picture	Quantity	Description
2.5" Single HDD Bracket	CHDT-0111		1	TF-2_5_HDD_BKT_ASSY; GT14

Chapter 2: Setting Up

2.0.1 Before You Begin

This chapter explains how to install the CPU, CPU heatsink, memory modules, and hard drives. Instructions on inserting a PCI-E card are also given.

Take note of the precautions mentioned in this section when installing your system.

2.0.2 Work Area

Make sure you have a stable, clean working environment. Dust and dirt can get into components and cause malfunctions. Use containers to keep small components separated. Putting all small components in separate containers prevents them from becoming lost. Adequate lighting and proper tools can prevent you from accidentally damaging the internal components.

2.0.3 Tools

The following procedures require only a few tools, including the following:

- A cross head (Phillips) screwdriver
- A grounding strap or an anti-static pad

Most of the electrical and mechanical connections can be disconnected using your fingers. It is recommended that you do not use needle-nosed pliers to remove connectors as these can damage the soft metal or plastic parts of the connectors.

2.0.4 Precautions

Components and electronic circuit boards can be damaged by discharges of static electricity. Working on a system that is connected to a power supply can be extremely dangerous. Follow the guidelines below to avoid damage to the Transport GT14 or injury to yourself.

- Ground yourself properly before removing the top cover of the system. Unplug the power from the power supply and then touch a safely grounded object to release static charge (i.e. power supply case). If available, wear a grounded wrist strap. Alternatively, discharge any static electricity by touching the bare metal chassis of the unit case, or the bare metal body of any other grounded appliance.
- Avoid touching motherboard components, IC chips, connectors, memory modules, and leads.
- The motherboard is pre-installed in the system. When removing the motherboard, always place it on a grounded anti-static surface until you are ready to reinstall it.
- Hold electronic circuit boards by the edges only. Do not touch the components on the board unless it is necessary to do so. Do not flex or stress circuit boards.
- Leave all components inside the static-proof packaging that they ship with until they are ready for installation.
- After replacing optional devices, make sure all screws, springs, or other small parts are in place and are not left loose inside the case. Metallic parts or metal flakes can cause electrical shorts.

Notes:

- All connectors are keyed to only attach one way.
- Always use the correct screw size as indicated in the procedures.

2.1 Installing Motherboard Components

This section describes how to install components on to the motherboard, including CPU, memory modules and a PCI-E card.

2.1.1 Removing the Top Chassis Cover

Follow these instructions to remove the Transport GT14 top chassis cover.

1. Remove the screw on the back side and two on the top of the top chassis cover.



2. Slide the top chassis cover in the direction of arrow.



3. Lift the cover off.



2.1.2 Installing the CPU and Heatsink

Follow these instructions to install the CPU and CPU heatsink.

1. Locate the CPU sockets.

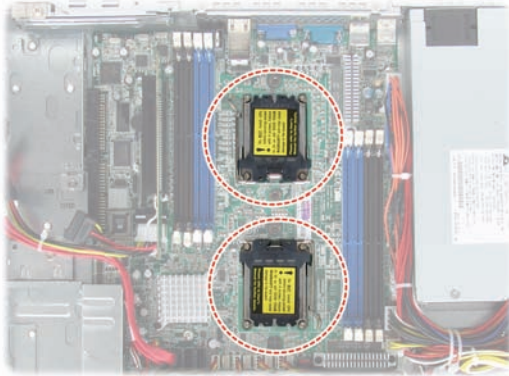

2. Remove the CPU socket cover.



3. Pull the CPU lever up to unlock the CPU socket (A). Then open the socket in the direction as shown (B).



- Place the CPU on the CPU socket, ensuring that pin 1 is located in the right direction.



- Close the CPU socket cover (A) and press the CPU socket lever down to secure the CPU (B).



- Place the air duct with heatsink on the top of the CPUs and attach with four screws as shown.

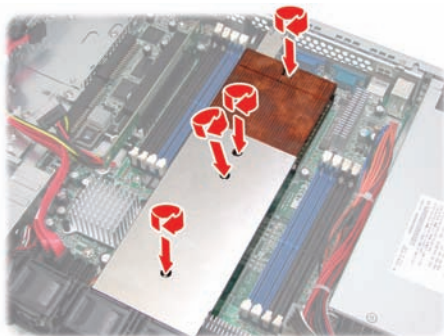

2.1.3 Installing the Memory

Follow these instructions to install the memory modules on the motherboard.

1. Locate the memory slots on the motherboard.

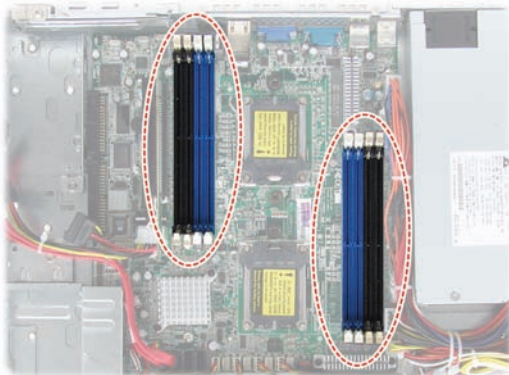

2. Press the memory slot locking levers in the direction of the arrows as shown in the following illustration.

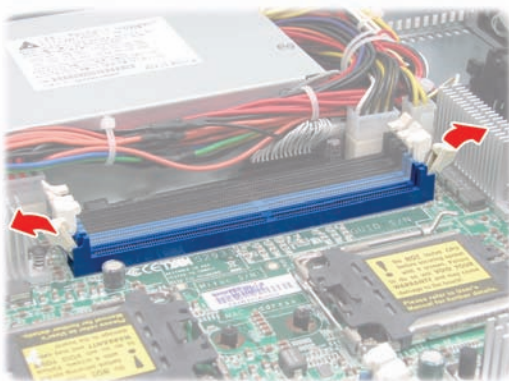

3. Align the memory module with the slot. The module has indentations that align with notches in the slots.
4. Insert the memory module into the slot as shown.

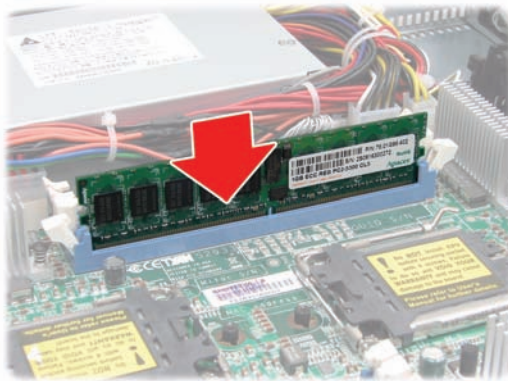

When inserted properly, the memory slot locking levers lock automatically onto the indentations at the ends of the module.

5. Always install the memory modules starting from the one close to the CPU. Subsequent memory modules must be installed in sequential order. See the population rules described in the following tables.

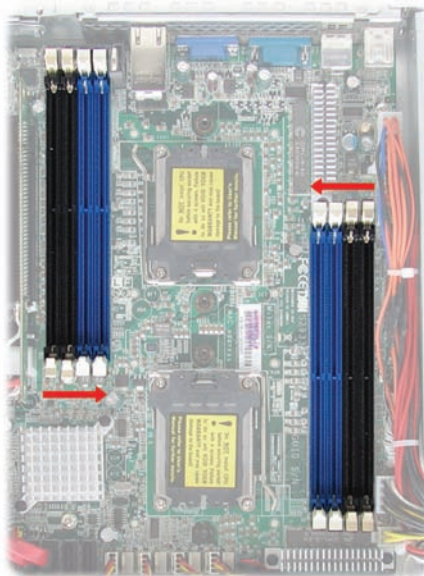

Refer to the following tables for supported DDR2 populations.
(Note: X indicates a populated DIMM slot.)

DDR2 DIMM population is always from back to front (black slot first).

DIMM slot	64bit-support							
P1_DIMM1			X			X		X
P1_DIMM3	X		X	X		X	X	X
P2_DIMM1					X		X	X
P2_DIMM3		X		X	X	X	X	X

※ Population order for 64-bit mode is **DIMM3** first, then **DIMM1**.

DIMM slot	128bit-support							
P1_DIMM1				X		X		X
P1_DIMM2				X		X		X
P1_DIMM3	X		X	X		X	X	X
P1_DIMM4	X		X	X		X	X	X
P2_DIMM1					X		X	X
P2_DIMM2					X		X	X
P2_DIMM3		X	X		X	X	X	X
P2_DIMM4		X	X		X	X	X	X

※ Population order for 128-bit mode is **DIMM3** and **DIMM4**, then **DIMM1** and **DIMM2**.

Attention!

1. If only memory module is installed, always install it in **DIMM3** slot.
2. Please note that population order for 64-bit mode does not support **DIMM2** and **DIMM4**.

2.1.4 Installing the PCI-E Card

Follow these instructions to install a PCI-E card.

1. Remove the screw securing the tab of PCI-E slot from the rear side of your GT14 B2933 system.

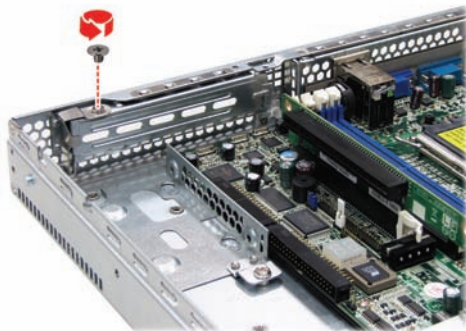

2. Pull the tab of PCI-E slot on the rear side in the direction as shown to release the I/O shield.

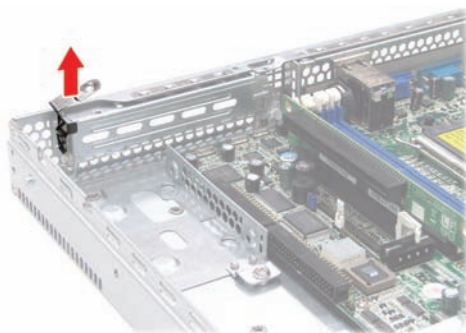

3. Move the I/O shield to left as shown and then take off the I/O shield.

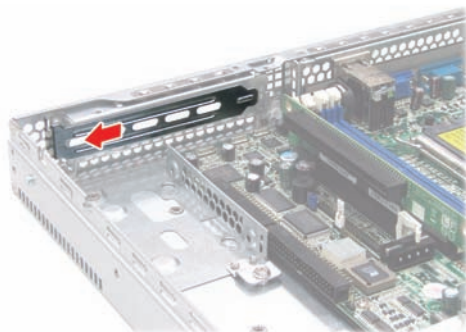

4. Insert the PCI-E card in the direction of arrows as shown.

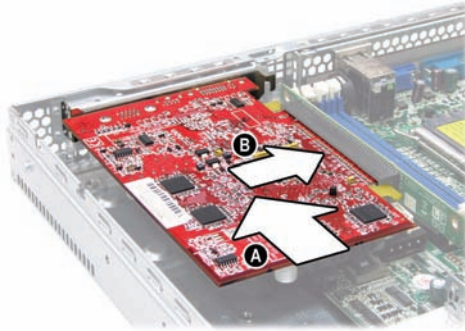

5. Push the tab of PCI-E slot on the rear side in the direction as shown to secure the PCI-E card.

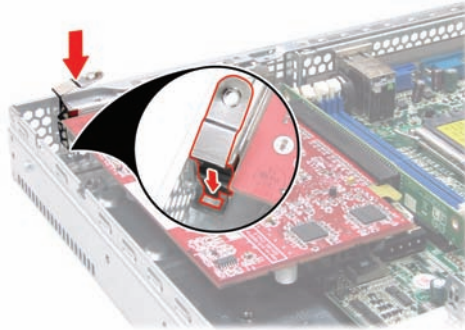

6. Secure the tab of PCI-E slot on the rear side with one screw as shown.

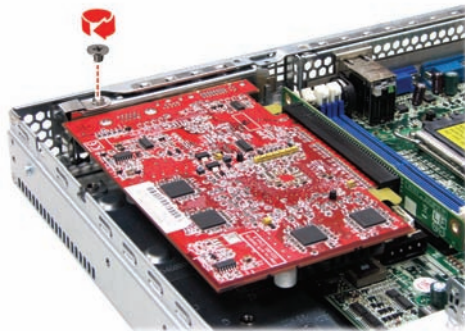

2.2 Installing the 3.5" Hard Drive

The GT14 chassis kit supports up to two 3.5" SATA hard drives without PCI-E support. One more 3.5" hard drive bracket is also provided in your accessory box. You can install a 3.5" hard drive from either the front or rear of the GT14 chassis. Follow these instructions to install a 3.5" hard drive.

2.2.1 Installing a 3.5" Hard Drive (front location)

1. Remove the screw securing the 3.5" drive bracket in the GT14 chassis.

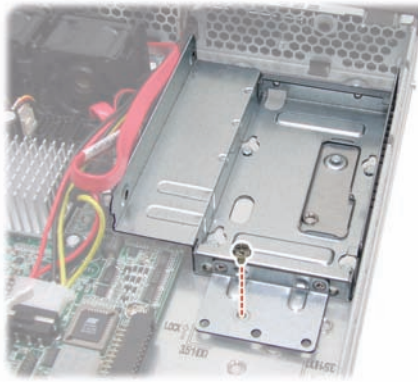

2. Slide the drive tray out (A) and lift the bracket out from the chassis (B).

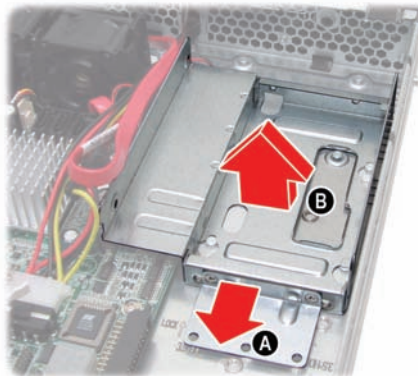

3. Place a 3.5" hard drive into the drive bracket.



4. Use 4 HDD screws to secure the hard drive.



5. Place the assembled hard drive with bracket in the spot you picked from the GT14 chassis (A) and slide it into place (B). Make sure the hard drive is placed correctly as the indication shown on the chassis.

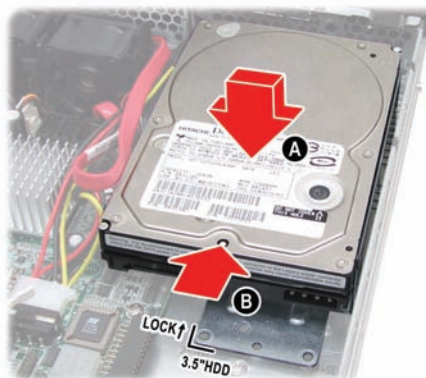

- Secure the assembled hard drive with the screw removed in step 1 to the screwhole indicated by "E" in the GT14 chassis.



- Connect the SATA drive data and power connectors.

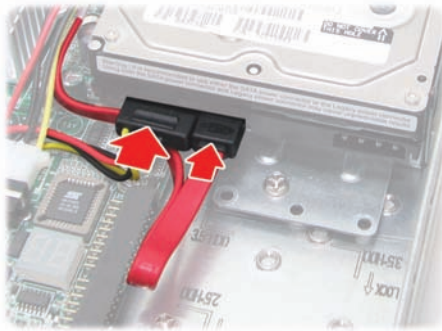

2.2.2 Installing a 3.5" Hard Drive (rear location)

1. Remove the M2083 PCI-E riser card from the PCI-E slot on the motherboard.

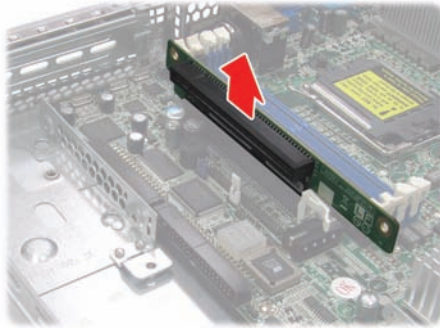

2. Remove the Hex screw securing the 2.5" drive bracket in the GT14 chassis.

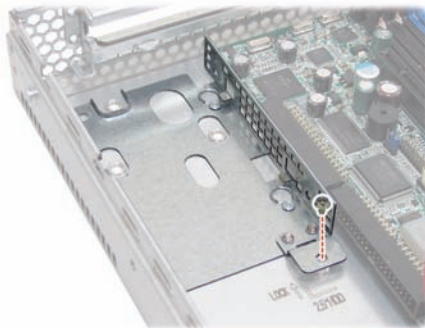

3. Slide the drive tray out (A) and lift the bracket out from the chassis (B).

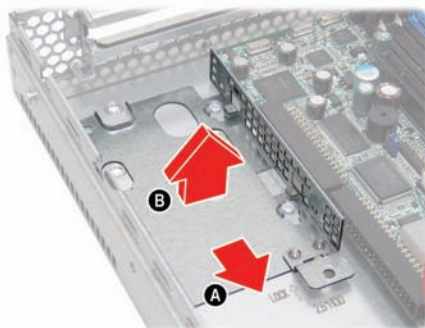

- Secure the stand-off screw removed from the "B" screw-hole to the one indicated by "D" in the GT14 chassis as shown.

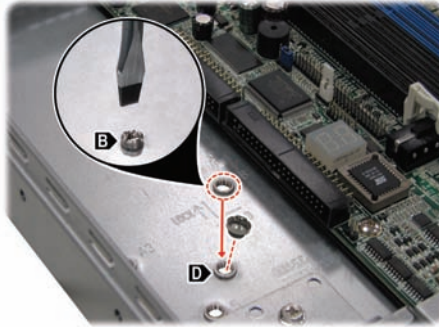

- Take out the supplied 3.5" hard drive bracket from the accessory box.

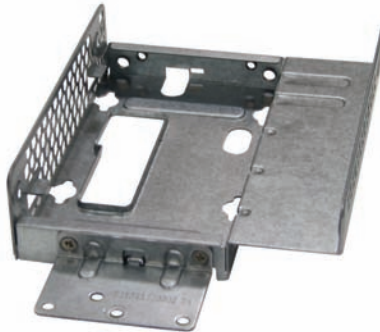

- Place a 3.5" hard drive into the drive bracket. Use 4 HDD screws to secure the hard drive.



7. Place the assembled hard drive with bracket in the spot you picked the 2.5" hard drive bracket from the GT14 chassis (A) and slide it into place (B).

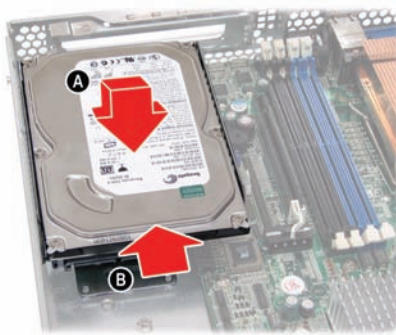

8. Secure the assembled hard drive with the screw removed in step 2.



9. Connect the SATA drive data and power connectors.

2.3 Installing the 2.5” Hard Drive

In addition to the installation of 3.5” hard drive, you can also install a 2.5” hard drive from either the front or rear of the GT14 chassis. Follow these instructions to install an internal SATA hard drive.

2.3.1 Installing a 2.5” Hard Drive (front location)

1. Remove the screw securing the 3.5” drive bracket in the GT14 chassis.

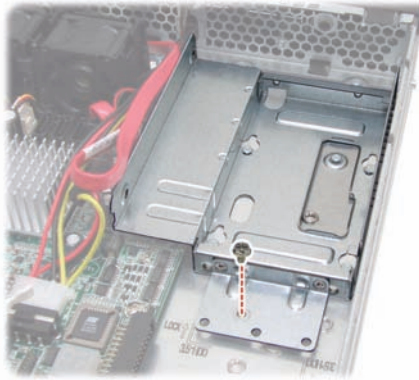

2. Slide the drive tray out (A) and lift the bracket out from the chassis (B).

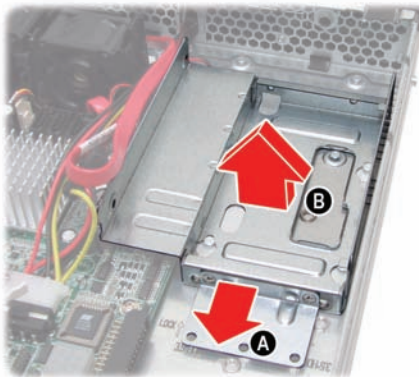

- Secure the stand-off screw removed from the "E" screw-hole to the one indicated by "C" in the GT14 chassis as shown.

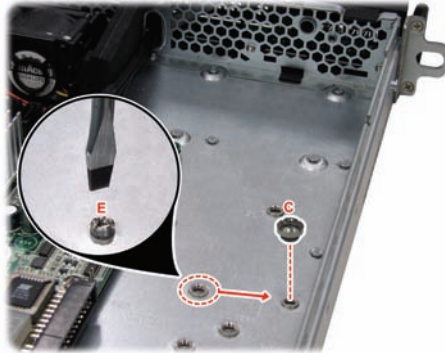

- Place a 2.5" hard drive into the 2.5" drive bracket.



- Use 4 HDD screws to secure the hard drive.



- Place the assembled hard drive with bracket in the spot you picked the 3.5" hard drive bracket from the GT14 chassis (A) and slide it into place (B). Make sure the hard drive is placed correctly as the indication shown on the chassis.

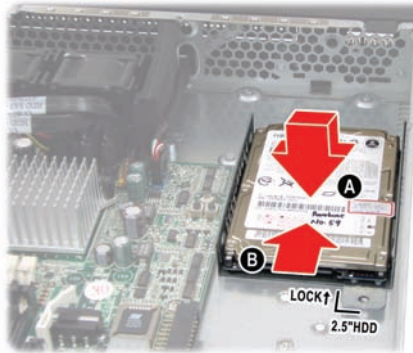

- Secure the assembled hard drive with the screw removed in step 1.



- Connect the SATA drive data and power connectors.

2.3.2 Installing a 2.5" Hard Drive (rear location)

1. Remove the screw securing the 2.5" drive bracket in the GT14 chassis.

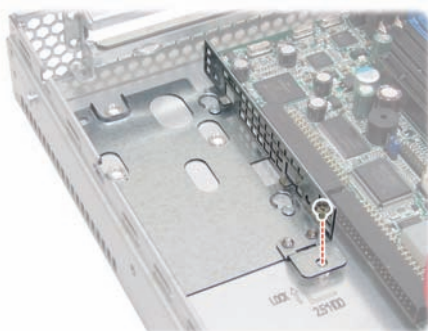

2. Slide the drive tray out (A) and lift the bracket out from the chassis (B).

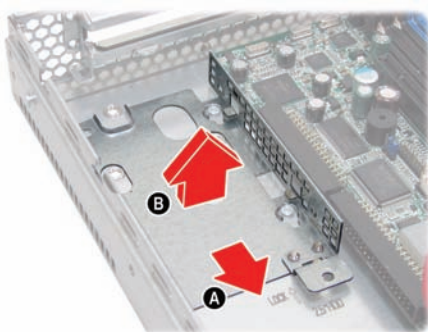

3. Place a 2.5" hard drive into the drive bracket.



4. Use 4 HDD screws to secure the hard drive.



5. Place the assembled hard drive with bracket in the spot you picked from the GT14 chassis (A) and slide it into place (B). Make sure the hard drive is placed correctly as the indication shown on the chassis.

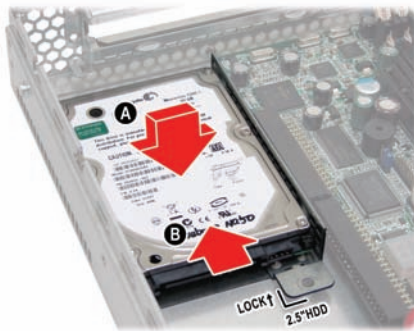

6. Secure the assembled hard drive with the screw removed in step 1.



7. Connect the SATA drive data and power connectors.



2.4 Installing Dual 2.5” Hard Drives (Option)

The GT14 chassis kit supports up to four internal SATA hard drives. You can also install dual 2.5” hard drives from either the front or rear of the GT14 chassis. Follow these instructions to install a dual 2.5” internal hard drive.

NOTE: To purchase the optional parts of dual 2.5” hard drive brackets and cables, please contact our sales representative.

2.4.1 Installing Dual 2.5” Hard Drives (front location)

1. Remove the screw securing the 3.5” drive bracket in the GT14 chassis.

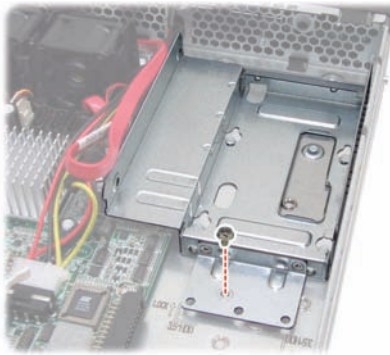

2. Slide the drive tray out (A) and lift the bracket out from the chassis (B).

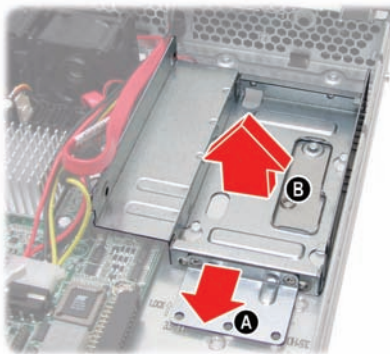

3. To proceed with the dual 2.5" hard drives installation, you need to purchase the 2.5" HDD dual bracket kit (CHDT0110) and additional cables.

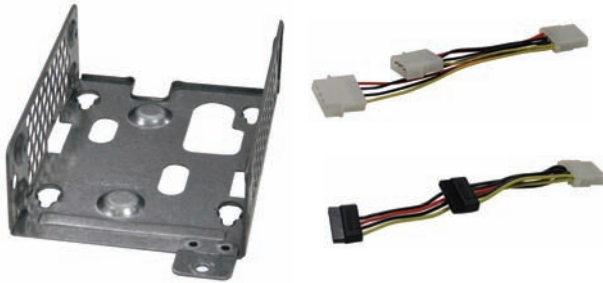

4. Place the two 2.5" hard drives into the 2.5" drive bracket (dual type). Use 8 HDD screws to secure the hard drives.



5. Remove the stand-off screw from the "E" screwhole to the one indicated by "C" in the GT14 chassis as shown.

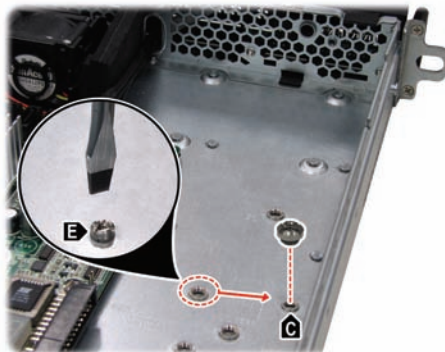

6. Place the assembled hard drives with bracket in the spot you picked the 3.5" hard drive bracket from the GT14 chassis (A) and slide it into place (B). Make sure the hard drive is placed correctly as the indication shown on the chassis.



7. Secure the assembled hard drive with the screw removed in step 1.



8. Take out the CCBL-046D and CCBL-046E cables from the purchased 2.5" HDD dual bracket kit.

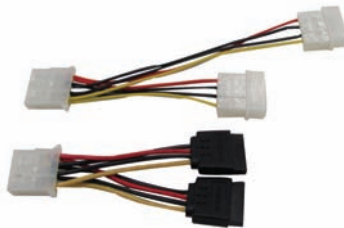

9. Connect the two cables as shown.



10. Connect the big 4-pin power connector to the motherboard as shown.



11. Connect the two SATA power connectors to the hard drives. Then connect the hard drives to the motherboard using two supplied SATA cables.



12. Bundle the cables with a cable tie and cut off any excess with a pair of wire cutters.

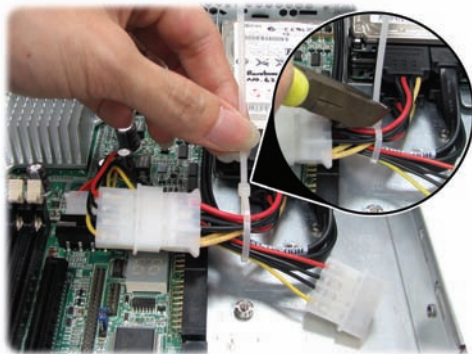

2.4.2 Installing Dual 2.5" Hard Drives (rear location)

1. Remove the screw securing the 2.5" drive bracket (single type) in the GT14 chassis.

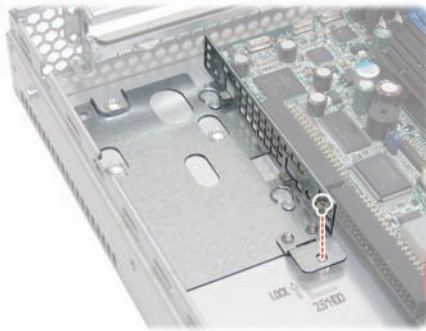

2. Slide the drive tray out (A) and lift the bracket out from the chassis (B).

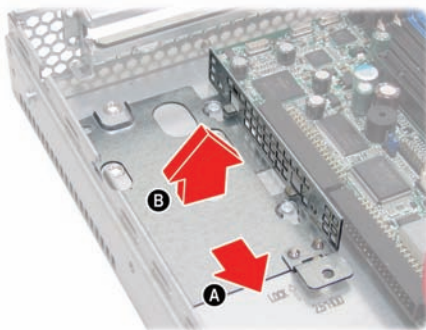

3. Place the two 2.5" hard drives into the 2.5" drive bracket (dual type). Use 8 HDD screws to secure the hard drives.



4. Place the assembled hard drive with bracket in the spot you picked the 2.5" hard drive bracket (single type) from the GT14 chassis (A) and slide it into place (B). Make sure the hard drive is placed correctly as the indication shown on the chassis.

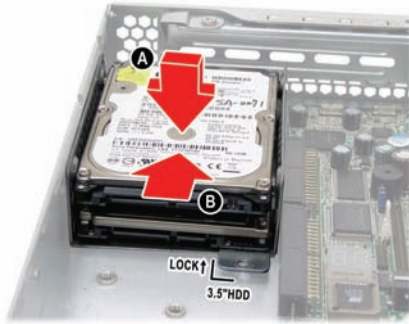

5. Secure the assembled hard drive with the screw removed in step 1.

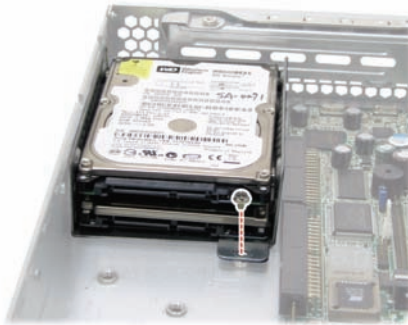

6. Take out the CCBL-046D and CCB-046E cables from the purchased 2.5" HDD dual bracket kit.



7. Connect the two cables as shown.



8. (A) Connect the big 4-pin power connector to the motherboard.
(B) Connect the two SATA power connectors to the hard drives.
(C) Then connect the hard drives to the motherboard using two supplied SATA cables.



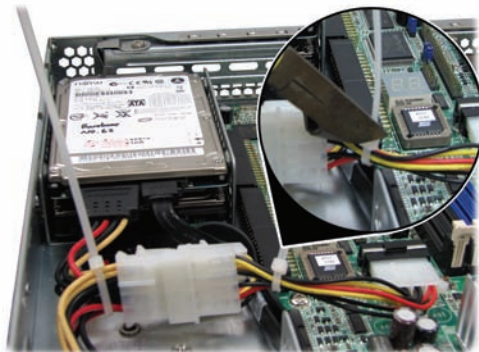

9. Bundle the cables with a cable tie and cut off any excess with a pair of wire cutters.



2.5 Rack Mounting

After installing the necessary components, the Transport GT14 can be mounted in a rack using the supplied rack mounting kit. The screw types are listed below for your reference.

Screws List

Rail for 4-post rack (Rail kit A)			
Item	Screw	Size	Quantity
A		M4-4L	18
B		M5-8L	10
C		M5-15L	4
Rail for 2-post rack (Rail kit B)			
Item	Screw	Size	Quantity
D		M5-8L	14
E		M4-4L	8
Mounting ear kit screws			
Item	Screw	Size	Quantity
F		M4-15L	2

For the complete contents in the rack mounting kit, see “**1.4 Unpacking**” on page 4 for more information.

2.5.1 Installing the Server in a Rack (with Rail kit A)

Follow these instructions to mount the GT14 into an industry standard 19" rack.



(Rail kit A)

NOTE: Before mounting the Transport GT14 in a rack, ensure that all internal components have been installed and that the unit has been fully tested. Maintenance can be performed on the unit while in a rack but it is preferable to install the device in a fully operational condition.

Installing the Inner Rails to Chassis

1. Screw the mounting ear to each side of GT14 as shown using 2 screws from the supplied mounting ear kit.



2. Press the latch and draw out the inner rails from rail assembly.

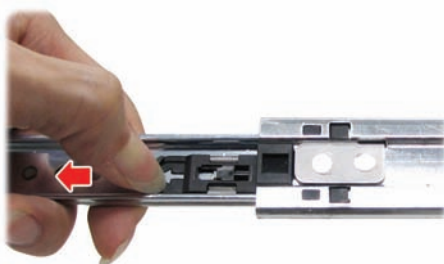

3. Install inner rails to left and right sides of chassis using 1 M4-4L(A) screw for each side.



Installing Outer Rails to the Rack

4. Measure the distance between inner side of the front and rear mounting brackets in the rack.



5. Reserve the distance same as in step 4 on rear racket. Secure the rear bracket to outer rail with 2 M4-4L(A) screws.

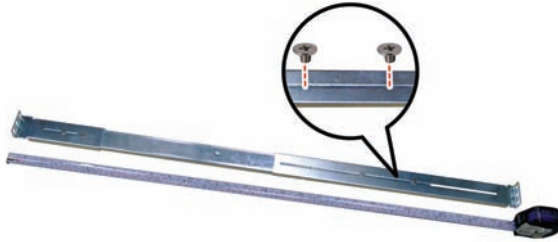

6. Secure the outer rails to the rack using 2 brackets and 5 M5-8L(B) screws for each side (2 at front side and 3 at rear side). Secure the mounting brackets from inside, not outside, of the rack.



Rackmounting the Server

7. Draw out the middle rails to the latch position.

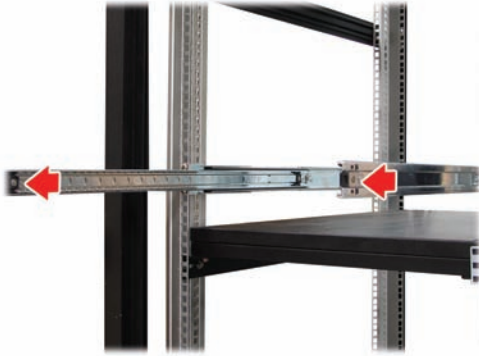

8. Lift the chassis and then insert the inner slide rails into the middle rails.



9. Push the chassis in and press the latch key (A). Then push the whole system into the rack (B).

A



B



10. Secure the mounting ears of chassis to the rack with one M4-15L(F) screw for each side.



NOTE: To avoid injury, it is strongly recommended that two people lift the GT14 into the place while a third person screws it to the rack.

2.5.2 Installing the Server in an Open Rack (with Rail kit B)

In addition to rackmounting the GT14 in a 4-post rack, you can also mount it in a 2-post rack. You *must* use rail kit B to mount the GT14 in this type of rack.



2-post open rack

NOTE: Before mounting the Transport GT14 in a rack, ensure that all internal components have been installed and that the unit has been fully tested. Maintenance can be performed on the unit while in a rack but it is preferable to install the device in a fully operational condition.

1. Install the inner rail brackets to left and right sides of chassis using 3 M4-4L(E) screws for each side.

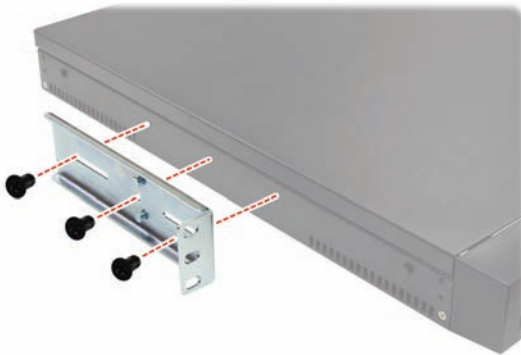

2. Lift the chassis and secure the mounting brackets to the front of rack using 3 M5-8L(D) screws for each side.



NOTE: To avoid injury, it is strongly recommended that two people lift the GT14 into the place while a third person screws it to the rack.

3. Locate the three small brackets at the rear of rack as shown. Adjust their positions to fit the mounting brackets to be secured in the following steps.



- Slide the mounting brackets into the rear of inner rail brackets as shown.

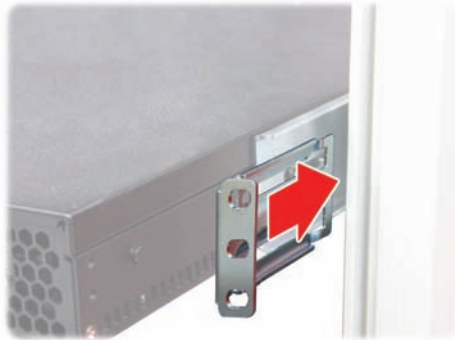

- Secure the mounting brackets with three M4-4L(E) screws for each side.



- The GT14 has been mounted to the rack as shown.



2.6 LCD Software Setup

2.6.1 Configuring the System

After you have made the network and power connections, you can configure the network settings using the LCD console.

Before You Begin

Before you begin, make sure that you have the following information ready:

- IP address assigned to the system
- Subnet mask of your network'

2.6.2 M1000 Driver Installation for Windows

Step 1. Install TYAN TSM program.

Step 2. Install M1000 driver for Windows.

2.6.3 M1000 Driver Installation for Linux

Step 1. Install M1000 driver for Linux

2.7 LCD Console

Here shows the LCD front panel and its four control buttons.

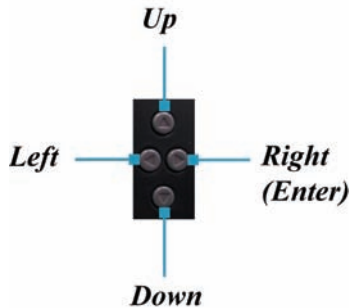
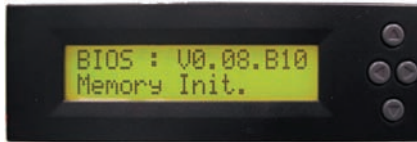

2.7.1 Key Definition

1. **Up**: Go to the previous selection.
2. **Left**: Go to the previous level selection.
3. **Right (Enter)**: Go to the next level selection; press again to execute command.
4. **Down**: Go to the next selection.

After you have installed the **TYAN TSM** and **M1000 driver for Windows** (for Windows OS) or the **M1000 driver for Linux** (for Linux OS), you can use the LCD front panel control buttons to get access to the information under each submenu.

2.7.2 DOS Mode and Windows Mode

M1000 supports both **DOS Mode** and **Windows Mode**.

DOS Mode

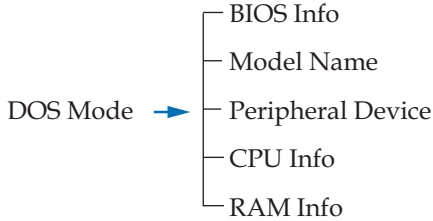

No.	Item	Screen Display
1	BIOS Info	V0.08.B10 memory Init.
2	Model Name	Transport GT14 MODEL-B2933
3	Peripheral Device	PCI Initialize & Resource Allocate
4	CPU Info	CPU: xxxx MHz
5	Memory Info	Memory: xxxx MB

Windows Mode

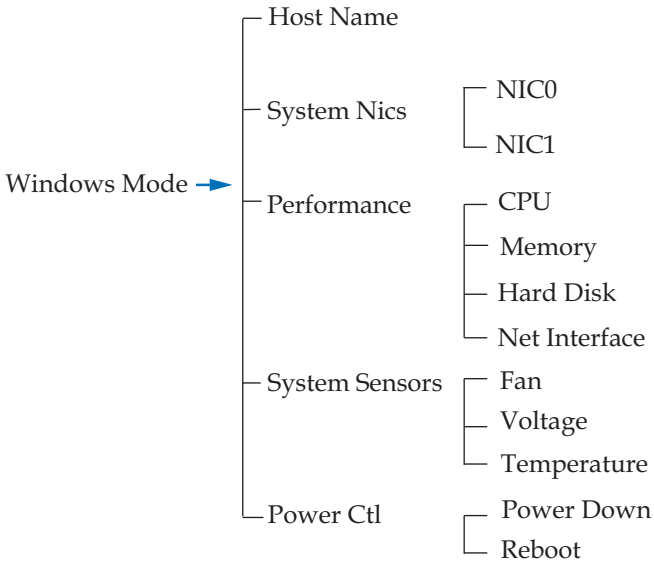

<i>Item</i>	<i>Screen Display</i>		
Host Name	TYAN Computer GT14 B2933		
1	System Nics		
	1.1	NIC0	DHCP IP Address: xx.xx.x.xxx Net Mask: xxx.xxx.xxx.0 Gateway: xxx.xxx.xxx.0
	1.2	NIC1	DHCP IP Address: xx.xx.x.xxx Net Mask: xxx.xxx.xxx.0 Gateway: xxx.xxx.xxx.0

Item	Screen Display		
Host Name	TYAN Computer GT14 B2933		
2	Performance		
	2.1	CPU	CPU Usage x.xx%
	2.2	Memory	Memory Usage xx%
	2.3	Harddisk	Disk Usage xx.xx%
	2.4	Net Interface	NIC0 Flow Speed x Bps NIC1 Flow Speed x Bps
3	System Sensors		
	3.1	Fan	System Fan1 xxxxRPM System Fan2 xxxxRPM System Fan3 xxxxRPM System Fan4 xxxxRPM
	3.2	Voltage	CPU1 Core Volt x.xxV CPU2 Core Volt x.xxV CPU1 DIMM 1.8V x.xxV CPU2 DIMM 1.8V x.xxV System Volt 3.3V x.xxV System Volt 5V x.xxV 3.3V standby x.xxV 5V standby x.xxV +12V for CPU1 x.xxV +12V for CPU2
	3.3	Temperature	CPU1 temp xx°C CPU2 temp xx°C System Temp1 xx°C System Temp2 xx°C
4	Power Ctrl		
	4.1	Power Down	Power Down
	4.2	Reboot	Reboot

2.7.3 Linux Mode

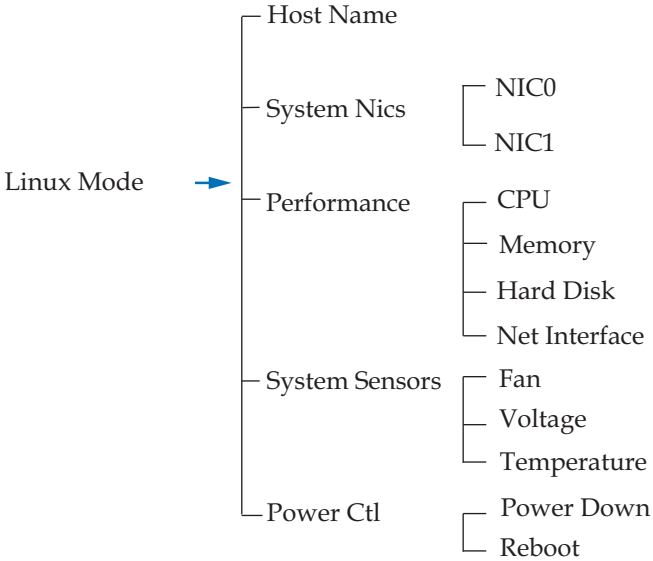

<i>Item</i>		<i>Screen Display</i>	
Host Name		TYAN Computer GT14 B2933	
1	System Nics		
	1.1	NIC0	DHCP IP Address: xx.xx.x.xxx Net Mask: xxx.xxx.xxx.0 Gateway: xxx.xxx.xxx.0
	1.2	NIC1	DHCP IP Address: xx.xx.x.xxx Net Mask: xxx.xxx.xxx.0 Gateway: xxx.xxx.xxx.0

Item	Screen Display		
Host Name	TYAN Computer GT14 B2933		
2	Performance		
	2.1	CPU	CPU Usage x.xx%
	2.2	Memory	Memory Usage xx%
	2.3	Harddisk	Disk Usage xx.xx%
	2.4	Net Interface	NIC0 Flow Speed x Bps NIC1 Flow Speed x Bps
3	System Sensors		
	3.1	Fan	System Fan1 xxxxRPM System Fan2 xxxxRPM System Fan3 xxxxRPM System Fan4 xxxxRPM
	3.2	Voltage	CPU1 Core Volt x.xxV CPU2 Core Volt x.xxV CPU1 DIMM 1.8V x.xxV CPU2 DIMM 1.8V x.xxV System Volt 3.3V x.xxV System Volt 5V x.xxV 3.3V standby x.xxV 5V standby x.xxV +12V for CPU1 x.xxV +12V for CPU2
	3.3	Temperature	CPU1 temp xx°C CPU2 temp xx°C System Temp1 xx°C System Temp2 xx°C
4	Power Ctrl		
	4.1	Power Down	Power Down
	4.2	Reboot	Reboot

Chapter 3: Replacing Pre-Installed Components

3.1 Introduction

This chapter explains how to replace pre installed components including the motherboard, LCD module, LED board, cooling fans, and power supply.

Take note of the precautions in this section when installing your system.

3.1.1 Work Area

Make sure you have a stable, clean working environment. Dust and dirt can get into components and cause malfunctions. Use containers to keep small components separated. Putting all small components in separate containers keeps them from becoming lost. Adequate lighting and proper tools can prevent you from accidentally damaging the internal components.

3.1.2 Tools

The procedures that follow require only a few tools, including the following:

- A cross head (Phillips) screwdriver
- A grounding strap or an anti-static pad

Most of the electrical and mechanical connections can be disconnected using your fingers. It is recommended that you do not use needle-nosed pliers to remove connectors as these can damage the soft metal or plastic parts of the connectors.

3.1.3 Precautions

Components and electronic circuit boards can be damaged by static electricity. Working on a system that is connected to a power supply can be extremely dangerous. Follow the guidelines below to avoid damage to the Transport GT14 or injury to yourself.

- Ground yourself properly before removing the top cover of the system. Unplug the power from your computer power supply and then touch a safely grounded object to release static charge (i.e. power supply case). If available, wear a grounded wrist strap. Alternatively, discharge any static electricity by touching the bare metal chassis of the unit case, or the bare metal body of any other grounded appliance.
- Avoid touching motherboard components, IC chips, connectors, memory modules, and leads.
- The motherboard is pre-installed in the system. When removing the motherboard, always place it on a grounded anti-static surface until you are ready to reinstall it.
- Hold electronic circuit boards by the edges only. Do not touch the components on the board unless it is necessary to do so. Do not flex or stress circuit boards.
- Leave all components inside the static-proof packaging that they ship with until they are ready for installation.
- After replacing optional devices, make sure all screws, springs, or other small parts are in place and are not left loose inside the case. Metallic parts or metal flakes can cause electrical shorts.

Notes:

- All connectors are keyed to only attach one way.
- Always use the correct screw size as indicated in the procedures.

3.2 Disassembly Flowchart

The following flowchart outlines the disassembly procedure.

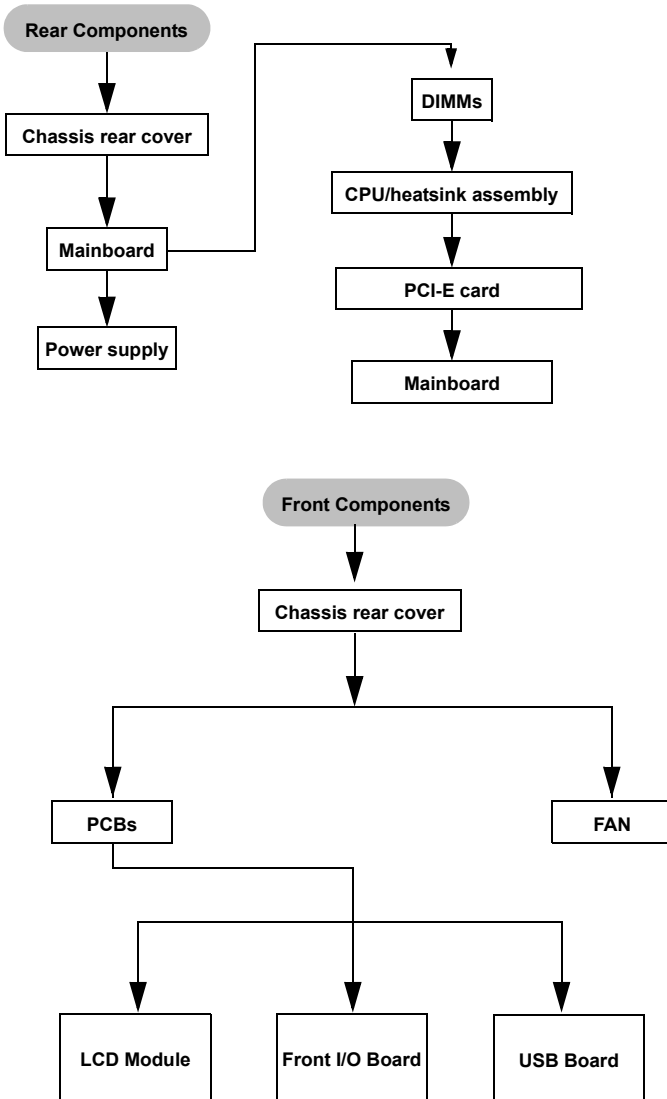

3.3 Removing the Top Chassis Cover

Before replacing any parts you must remove the top chassis cover.

Follow these instructions to remove the Transport GT14 top chassis cover.

1. Remove the screw on the back side and two on the top of the top chassis cover.



2. Slide the top chassis cover in the direction of arrow.



3. Lift the cover off.



3.4 Replacing Motherboard Components

Follow these instructions to replace motherboard components, including the motherboard.

3.4.1 Disconnecting All Motherboard Cables

Before replacing the motherboard or certain components, remove cables connected to the motherboard. Follow these instructions to remove all motherboard cabling.

1. Disconnect power cables and LED cable.

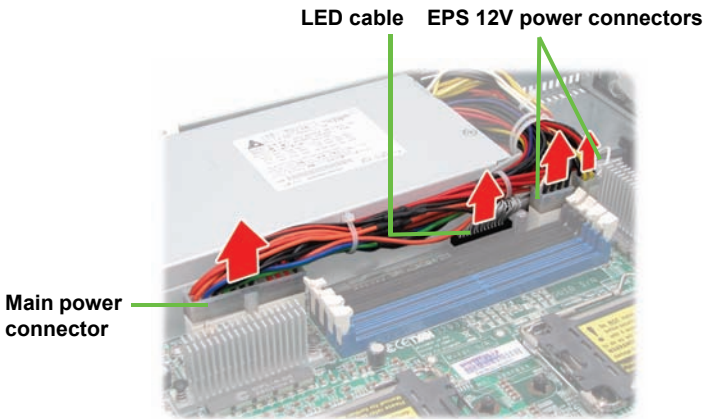

2. Disconnect the LCM cable connector, fan connectors, SATA cables, and USB cable.

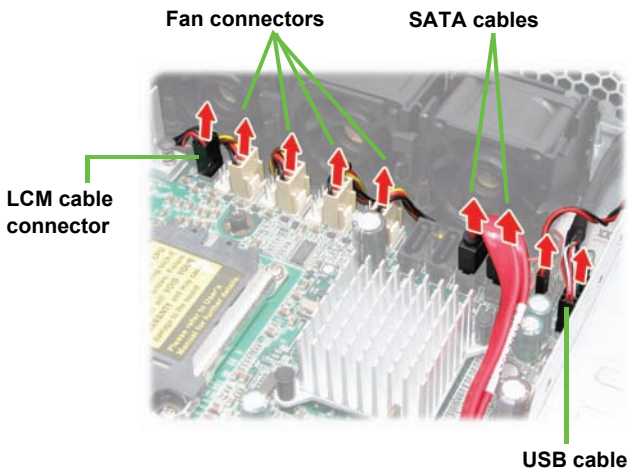

3.4.2 Removing the Motherboard

After removing all of the aforementioned cables, follow these instructions to remove the motherboard from the chassis.

1. Remove the eight screws securing the motherboard to the chassis.

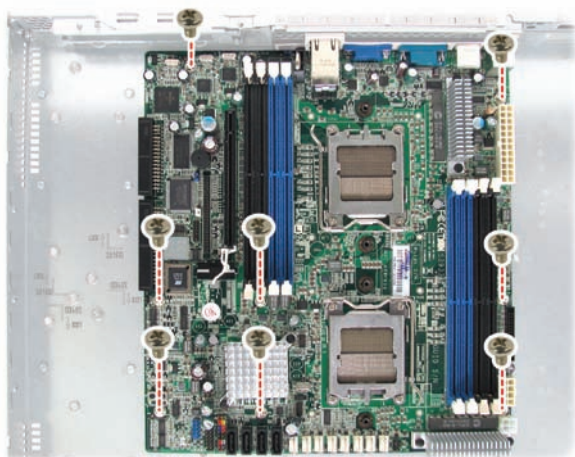

2. Remove the motherboard.

3.5 Replacing the LCD Module and LED Board

Follow these instructions to replace the LCD module in your GT14 B2933 system.

1. Remove the chassis front cover as shown.



2. Remove the two screws securing to the LCD module.



3. Disconnect the LCM and control board cables.

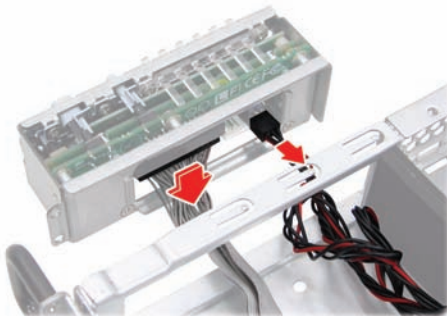

4. Remove the four screws on both sides of the LCD module.



5. Remove the LCD front bracket from the LCD module.

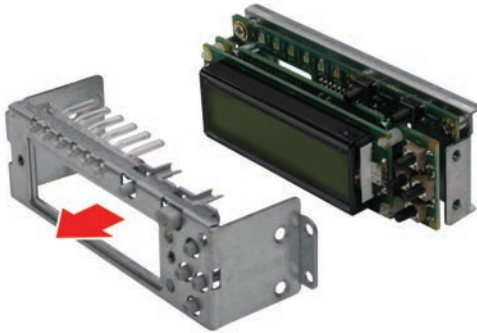

6. Remove the two screws from the rear LCD bracket.



7. Remove the three screws securing the LED board to the rear LCD bracket. Remove the LED board.

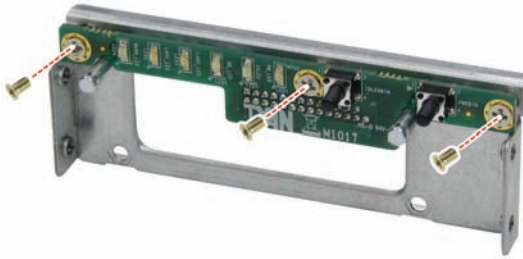

8. Place a new LCD module in position in the chassis following the above steps in reverse.

3.5.1 M1017 LED Board Features

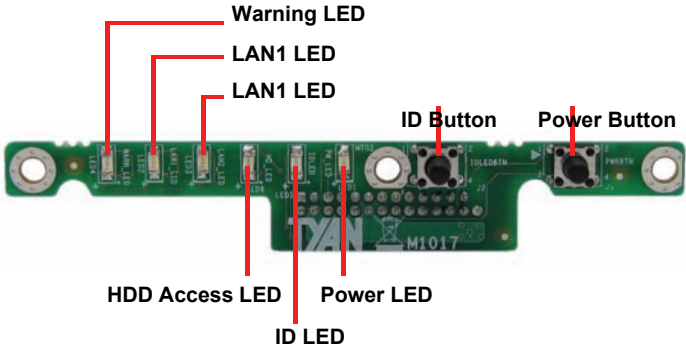

3.5.2 M1017 LED Board Connector Pin Definition

2 x 14 Pin Header

1	HD_LED+	2	HD_LED-
3	RST	4	GND
5	PW_LED+	6	GND
7	WARN_LED+	8	WLED-
9	PCI_SMBUSDA	10	PCI_SMBUSCL
11	FP_NMI_L	12	GND
13	NMI_PWR	14	INTRUDER_L
15	PWRSW-	16	GND
17	LAN1_LED+	18	LAN1_LEDLINK
19	LAN2_LED+	20	LAN2_LEDLINK
21	NC	22	NC
23	IDLED+	24	ID_LED-
25	IDLEDBTN-	26	ID_SW-
27	KEY	28	NC

3.6 Replacing the USB Board

Follow these instructions to replace the USB board in your GT14 B2933 system.

1. Remove the chassis front cover as shown.



2. Disconnect the USB cable from the USB board.

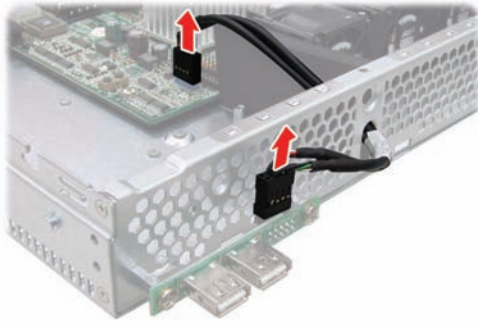

3. Remove the two screws securing the USB board to separate the USB board from the chassis.

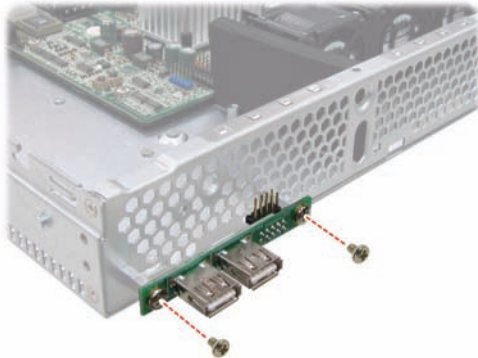

- Place a new USB board in position in the chassis following the above steps in reverse.

3.6.1 USB Board Features

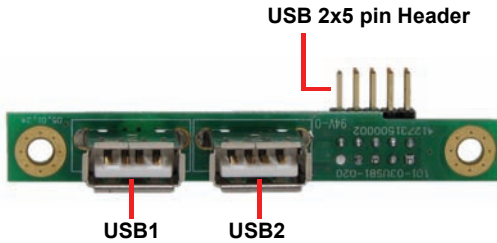

3.6.2 USB Board Connector Pin Definition

2 x 5 Pin USB Header

1	USB1 POWER	2	USB2 POWER
3	USB1 DATA -	4	USB2 DATA -
5	USB1 DATA +	6	USB2 DATA +
7	USB1 GND	8	USB2 GND
9	KEY PIN	10	NONE

3.7 Replacing the Cooling Fans

Follow these instructions to replace the cooling fans in your GT14 B2933 system.

1. Remove the fan cradle holders as shown.

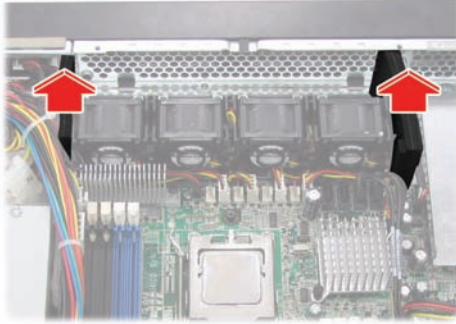

2. Remove the four fan connectors from the motherboard.

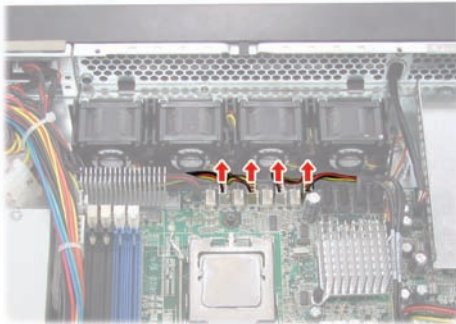

3. Remove the fan unit from the chassis.

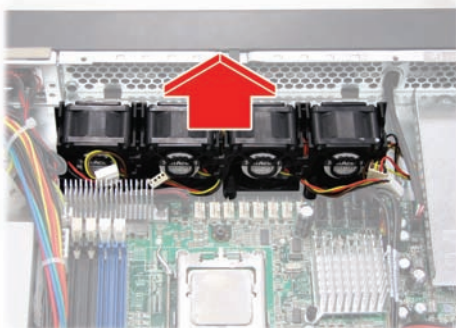

4. Remove the fan you want to replace in the direction of the arrow from the fan cradle.



5. Replace a new fan into the fan cradle following the above steps in reverse.

3.8 Replacing the Power Supply

Follow these instructions to replace the power supply in your GT14 B2933 system.

1. Remove the top chassis cover. See **“3.3 Removing the Top Chassis Cover”** on page 66 for more details.
2. Detach the power cables from the motherboard. See **“3.4.1 Disconnecting All Motherboard Cables”** on page 67 for more details.

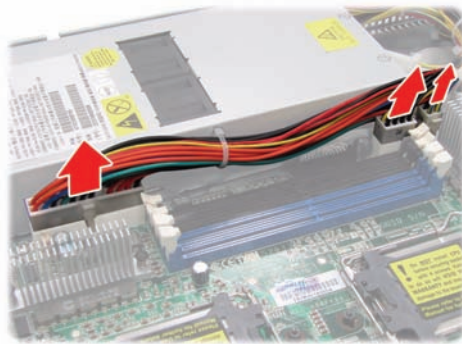

3. Remove the two screws that secure the power supply to the chassis.

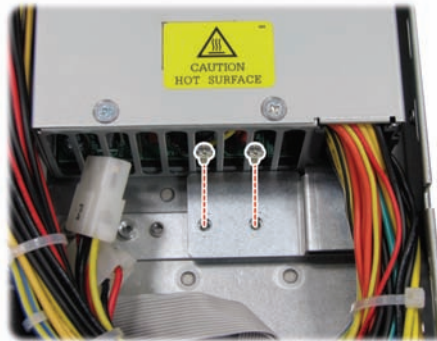

4. Remove the two screws securing the power supply to the chassis.



5. Lift the power supply free from the chassis.



6. Replace a new power supply into the chassis following the above steps in reverse.

Appendix I: BIOS Differences

The BIOS of B2933 is similar to the BIOS of S2933. However, there is something different. You may refer to the attached motherboard manual for the complete BIOS information. The difference between B2933 and S2933 is on the submenu “Hardware Health Configuration” under “Advanced” menu. See the following for the differences.

S2933 Advanced/Hardware Health Configuration

BIOS Setup Utility	
Advanced	
Hardware Health Configuration	Enables Hardware Health Monitoring Device
H/W Health Function [Enabled] Auto FAN Power Control [Disabled] FAN Fail LED Indicator [Disabled]	
Hardware Health Event Monitoring	
▶ Mainboard Voltages Report	
CPU1 Temperature	:xx °C/ xxx °F
CPU1 Temperature	:xx °C/ xxx °F
Ambient Temp (Near CPU2 URM)	:xx °C/ xxx °F
Ambient Temp (Near MCP55)	:xx °C/ xxx °F
FAN1 Speed (TACH1)	:xxxx RPM
FAN2 Speed (TACH2)	:xxxx RPM
FAN3 Speed (TACH3)	:xxxx RPM
FAN4 Speed (TACH4)	:xxxx RPM
FAN5 Speed (TACH5)	:xxxx RPM
FAN6 Speed (TACH6)	:xxxx RPM
FAN7 Speed (TACH7)	:xxxx RPM
FAN8 Speed (TACH8)	:xxxx RPM
	←→ Select Screen ↑↓ Select Item + - Change Option Tab Select Field F1 General Help F10 Save and Exit ESC Exit

B2933 Advanced/Hardware Health Configuration

BIOS Setup Utility		
Advanced		
Hardware Health Configuration		Enables Hardware Health Monitoring Device
H/W Health Function	[Enabled]	
Auto FAN Power Control	[Enabled]	
FAN Fail LED Indicator	[Enabled]	
Hardware Health Event Monitoring		
▶ Mainboard Voltages Report		
CPU1 Temperature	:xx °C/ xxx °F	
Ambient (Near SATA0) Temp	:xx °C/ xxx °F	
Ambient (Near MCP55) Temp	:xx °C/ xxx °F	
System FAN1 Speed	:xxxx RPM	← → Select Screen
System FAN2 Speed	:xxxx RPM	↑ ↓ Select Item
System FAN3 Speed	:xxxx RPM	+ - Change Option
System FAN4 Speed	:xxxx RPM	F1 General Help
		F10 Save and Exit
		ESC Exit

Table of Differences

	S2933	B2933
Auto Fan Power Control	Disabled	Enabled
PWM Minimal Duty Cycle	[30% Duty Cycle]	[20% Duty Cycle]
FAN Fail LED Indicator	Disabled	Enabled
Hardware Monitor Fan	FAN1 Speed (TACH1) FAN2 Speed (TACH2) FAN3 Speed (TACH3) FAN4 Speed (TACH4) FAN5 Speed (TACH5) FAN6 Speed (TACH6) FAN7 Speed (TACH7) FAN8 Speed (TACH8)	System FAN1 Speed System FAN2 Speed System FAN3 Speed System FAN4 Speed

Appendix II: Cable Connection Tables

SATA Cable

Table 1: GT14 B2933 Model

HDD	Connect to	Motherboard
HDD 1	→	SATA 0
HDD 2	→	SATA 1
HDD 3 (option)	→	SATA 2
HDD 4 (option)	→	SATA 3

FAN Cable

Table 2: System Fan to Motherboard

System Fan	Connect to	Motherboard
Fan 1	→	J21 Fan1 connector
Fan 2	→	J19 Fan3 connector
Fan 3	→	J17 Fan5 connector
Fan 4	→	J15 Fan7 connector

Power Supply Cable

Table 3: Power Supply to Motherboard

Power Supply	Connect to	Motherboard
P1 24-pin power cable	→	PW1 24-pin connector
P2 8-pin power cable	→	PW3 8-pin connector
P3 4-pin power cable	→	PW4 4-pin connector

Other Cables

Table 4: M1017 Front Panel LED Board Related Cable

M1017	→	Motherboard
M1017 LED connector	→	J7 connector

Table 5: USB Board Related Cable

USB Board	→	Motherboard
USB 2x5 pin header	→	J12 connector

Appendix III: Installing the SMDC Card

The following provides you with the information on installing M3291 SMDC card into your GT14 chassis.

1. Secure the three stand-off screws to the screwholes indicated by "A1" "A2", and "A3" in the GT14 chassis as shown.

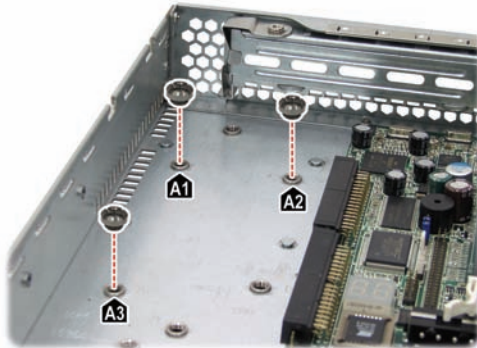

2. Align M3291 with the secured stand-off screws in step 1. Secure M3291 to the chassis with three screws.

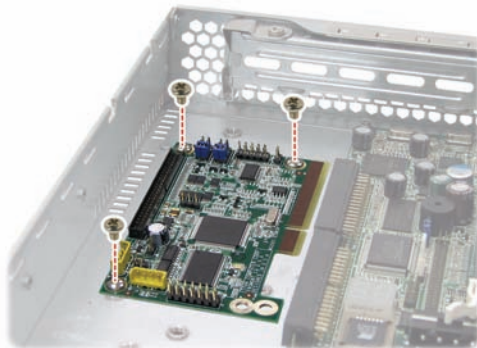

3. Connect the 2x25 pin SMDC cable to M3291 as shown.

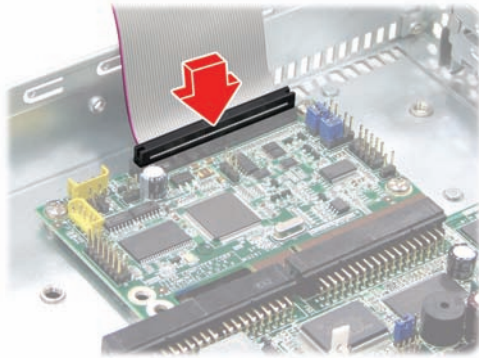

4. Connect the other end of SMDC cable to the SMDC connector (J6) on the motherboard.

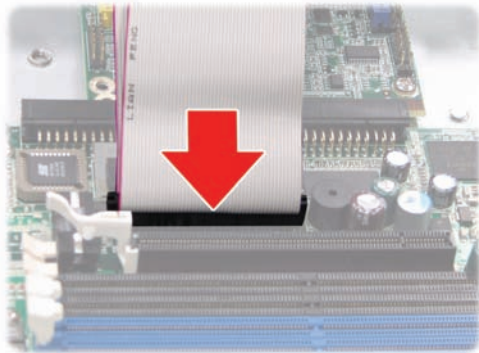

Cable Connection Table

SMDC Card (M3291)	Connects to	Motherboard
J1 connector	→	J6 SMDC connector

Appendix IV: Installing the M2061 Riser Card

The following provides you with the information on installing the optional M2061 riser card into your GT14 chassis. You need to purchase the M2061 riser card and additional cable. The cable connectors are illustrated as below.

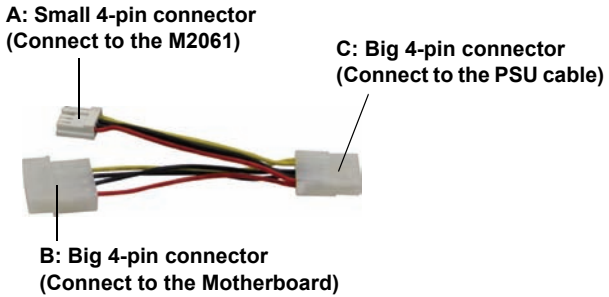

1. Connect the small 4-pin connector (A) of the power adapter cable (CCBL-046F) to the M2061 riser card as shown.



2. Connect the big 4-pin power connector (B) to the power connector (PW2) on the motherboard.

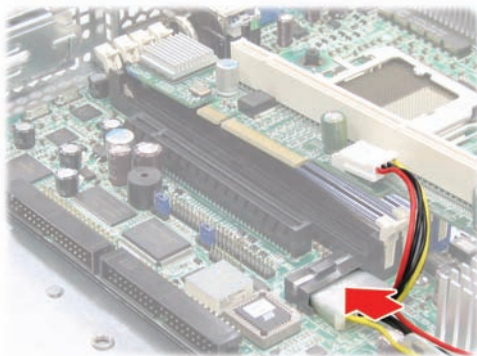

3. Insert the M2061 riser card to the PCI Express slot (J4) as shown.

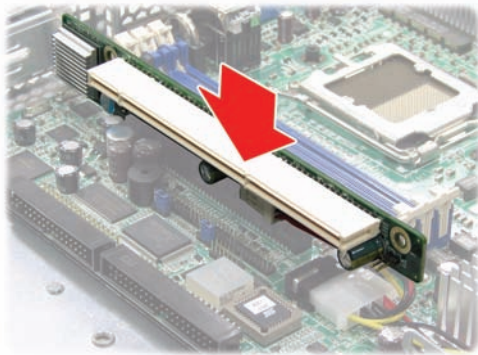

4. Connect the other end of power adapter cable to the power supply.

Technical Support

If a problem arises with your system, you should first turn to your dealer for direct support. Your system has most likely been configured or designed by them and they should have the best idea of what hardware and software your system contains. Hence, they should be of the most assistance for you. Furthermore, if you purchased your system from a dealer near you, take the system to them directly to have it serviced instead of attempting to do so yourself (which can have expensive consequences).

If these options are not available for you then Tyan Computer Corporation can help. Besides designing innovative and quality products for over a decade, Tyan has continuously offered customers service beyond their expectations. Tyan's website (www.tyan.com) provides easy-to-access resources such as in-depth Linux Online Support sections with downloadable Linux drivers and comprehensive compatibility reports for chassis, memory and much more. With all these convenient resources just a few keystrokes away, users can easily find the latest software and operating system components to keep their systems running as powerful and productive as possible. Tyan also ranks high for its commitment to fast and friendly customer support through email. By offering plenty of options for users, Tyan serves multiple market segments with the industry's most competitive services to support them.

"Tyan's tech support is some of the most impressive we've seen, with great response time and exceptional organization in general" - Anandtech.com

Please feel free to contact us directly for this service at tech-support@tyan.com

Help Resources:

1. See the beep codes section of this manual.
2. See the TYAN website for FAQ's, bulletins, driver updates, and other information: <http://www.tyan.com>

3. Contact your dealer for help BEFORE calling TYAN.
4. Check the TYAN user group: alt.comp.periphs.main-board.TYAN

Returning Merchandise for Service

During the warranty period, contact your distributor or system vendor FIRST for any product problems. This warranty only covers normal customer use and does not cover damages incurred during shipping or failure due to the alteration, misuse, abuse, or improper maintenance of products.

NOTE: A receipt or copy of your invoice marked with the date of purchase is required before any warranty service can be rendered. You may obtain service by calling the manufacturer for a Return Merchandise Authorization (RMA) number. The RMA number should be prominently displayed on the outside of the shipping carton and the package should be mailed prepaid. TYAN will pay to have the board shipped back to you.

Transport GT14 B2933 Service Engineer's Manual v1.0
Document part No. D1885-100

Free Manuals Download Website

<http://myh66.com>

<http://usermanuals.us>

<http://www.somanuals.com>

<http://www.4manuals.cc>

<http://www.manual-lib.com>

<http://www.404manual.com>

<http://www.luxmanual.com>

<http://aubethermostatmanual.com>

Golf course search by state

<http://golfingnear.com>

Email search by domain

<http://emailbydomain.com>

Auto manuals search

<http://auto.somanuals.com>

TV manuals search

<http://tv.somanuals.com>