

Sunbeam

Café Ristretto™

15 BAR pump espresso machine

Instruction Booklet
EM2300

Please read these instructions carefully
and retain for future reference.



Contents

Sunbeam's Safety Precautions	2
About espresso coffee	3
Features of your Café Ristretto™	4
Operations guide for your Café Ristretto™	7
Secrets to the perfect cup	10
Easy steps for frothing milk	11
Before using your Café Ristretto™	12
Functions of your Café Ristretto™	13
Care and Cleaning	16
Descaling	18
Trouble shooting guide	20
Recipes	22

تأكد من تفهيم احتياطات السلامة المذكورة اعلاه

請務必理解上述的安全預防措施。

Assurez-vous que les précautions ci-dessus relatives à la sécurité sont bien comprises

Versichern Sie sich daß die obenstehenden Sicherheitsmaßnahmen Verstanden werden

Βεβαιώνετε πως οι παραπάνω προφυλάξεις ασφαλείας γίνονται κατανοητές

Pastikan bahwa tindakan-tindakan keselamatan seperti di atas dimengerti anda

Accertatevi che le suddette norme di sicurezza siano comprese a dovere

上記の注意事項をよくお読みになり、安全を御確認ください

Уверете се дека погоре споменатите мерки на претпазливост се добро разбрани

Asegúrese de que las precauciones de seguridad precedentes sean bien comprendidas

کاری بکنید کہ احتیاطهای بالا حتماً درک بشوند

ต้องแน่ใจว่า ข้อควรระวังเรื่องความปลอดภัยข้างต้น เป็นที่เข้าใจกันดี

Yukarda belirtilen güvenliik önlemlerinin anlaşılığından emin olunuz

Xin kiểm chắc rằng những biện pháp làm an toàn kể trên được hiểu rõ

Sunbeam's Safety Precautions

SAFETY PRECAUTIONS FOR YOUR SUNBEAM ESPRESSO MACHINE.

- Always place the unit on a flat, level surface.
- Do not operate without water in reservoir.
- Do not remove the filter holder during water flow or coffee flow as the unit is under pressure. Removing the filter holder during operation can lead to a scalding or injury.
- Clean the steam nozzle only when the unit has been switched off and allowed to cool.

Sunbeam are very safety conscious when designing and manufacturing consumer products, but it is essential that the product user also exercise care when using an electrical appliance. Listed below are precautions which are essential for the safe use of an electrical appliance:

- Read carefully and save all the instructions provided with an appliance.
- Always turn the power off at the power outlet before you insert or remove a plug. Remove by grasping the plug - do not pull on the cord.
- Turn the power off and remove the plug when the appliance is not in use and before cleaning.
- Do not use your appliance with an extension cord unless this cord has been checked and tested by a qualified technician or service person.
- Always use your appliance from a power outlet of the voltage (A.C. only) marked on the appliance.
- Close supervision is necessary when your appliance is being used near children or infirm persons.
- Never leave an appliance unattended while in use.
- Young children should be supervised to ensure that they do not play with the appliance.

- Disconnect the plug from the power outlet if there is any problem during the coffee making process or prior to cleaning your appliance.
- Do not allow the power cord to come into contact with the hot parts of the appliance (cup warming plate, filter holder, steam nozzle).
- Keep hands away from hot parts of the appliance, including the cup warming plate, filter holder and steam nozzle.

- Do not use an appliance for any purpose other than its intended use.
- Do not place an appliance on or near a hot gas flame, electric element or on a heated oven. Do not place on top of any other appliance.
- Do not let the power cord of an appliance hang over the edge of a table or bench top or touch any hot surface.
- For safety reasons and to avoid maintenance by unskilled persons, some appliances are 'sealed' using tamperproof screws. Such appliances should always be returned to the nearest Sunbeam Appointed Service Centre for adjustment or repair if required.
- Do not operate any electrical appliance with a damaged cord or after the appliance has been dropped or damaged in any manner. If damage is suspected, return the appliance to the nearest Sunbeam Appointed Service Centre for examination, repair or adjustment.
- For additional protection, Sunbeam recommend the use of a residual current device (RCD) with a tripping current not exceeding 30mA in the electrical circuit supplying power to your appliances.
- Do not immerse the appliance in water or any other liquid unless recommended.

If you have any concerns regarding the performance and use of your appliance, please visit www.sunbeam.com.au or contact the Sunbeam Consumer Service Line. Ensure the above safety precautions are understood.

About espresso coffee

The Sunbeam range of espresso machines are sure to satisfy lovers of coffee. With its Italian designed and made 15 BAR pump, a 'boiler' heating system and Italian designed 'crema' system the Sunbeam Café Ristretto™ will provide endless cups of quality coffee. Coffee is an integral part of Australian culture. With café numbers increasing, the demand for the perfect cup combined with the right atmosphere is the goal of many coffee connoisseurs.

What makes a good coffee?

Sunbeam have consulted with experienced coffee makers and appreciators of coffee through every stage of design, to ensure the machine delivers a great coffee every time. There are many factors that contribute to the perfect coffee. The words 'taste' and 'aroma' are consistently used when describing the perfect cup.

The sweet aroma and taste of the perfect coffee is largely due to the correct combination of temperature and pressure during the brewing process. The 'boiler' heating system ensures the water is at the correct temperature, so that the full coffee flavour is extracted.

Secondly, the combination of the Italian designed and made 15 BAR pump, Italian designed dual-wall filter and stabilising baffle ensures the correct pressure at which the liquid espresso is released from the spout. The flow should consist of both liquid and cream. This cream is commonly known as the 'crema'. The perfect 'crema' should be thick and stable and preserve the coffee flavour, aroma and temperature.

We hope you have many enjoyable coffee experiences with the Sunbeam Café Ristretto™. Should you need any further assistance please don't hesitate to contact the Sunbeam coffee hotline on free call 1800 025 059.

Features of your Sunbeam Café Ristretto™

Warming plate

Gently pre-heats espresso cups and glasses before use.

Control Panel

Easy to operate - simply select the espresso function, or rotate the dial for steam.

Brewing head

Removable drip tray

The drip tray can be completely removed for easy cleaning.

Tamp

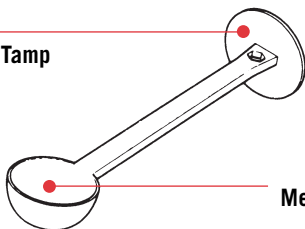

Measuring spoon

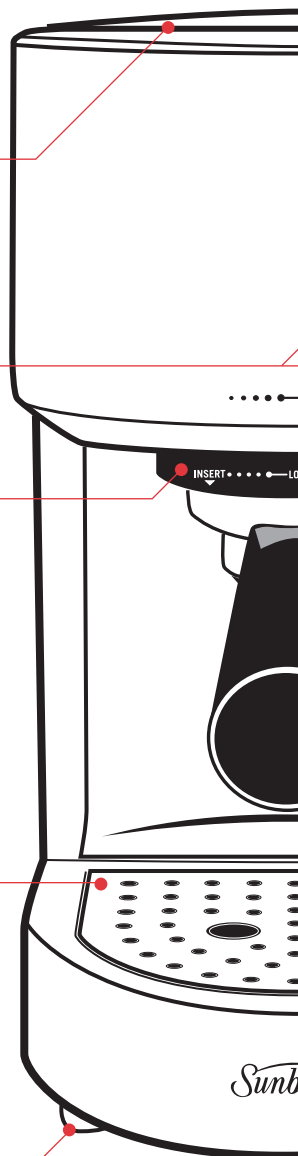

Non-slip rubber feet

Makes the unit sturdy, preventing it from slipping on the bench top.

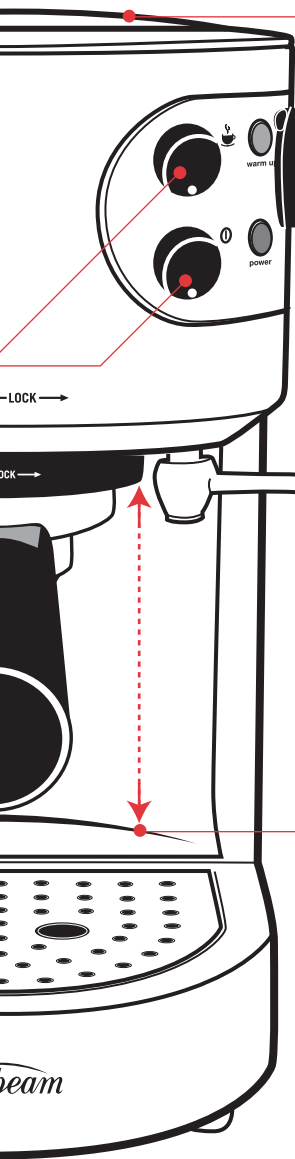

1.5L removable water reservoir

The water reservoir is removable for easy filling. Simply lift the lid, or remove reservoir in any direction and take to the tap.

Steam selector dial with Pre-heat

Steam arm/wand

Froth enhancing steam attachment

Designed for ease of use, the rubber froth attachment creates thick, dense and shiny milk froth in seconds.

Extra cup height clearance

Additional clearance between the coffee handle and the drip tray – designed to suit taller cups.

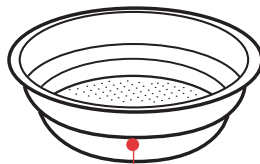

1 cup filter

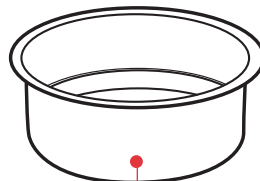

2 cup filter

Features of your Sunbeam Café Ristretto™

15 BAR pump

The Italian designed and made 15 BAR pump, supplies the correct and essential pressure necessary for full extraction of oils from the coffee grinds.

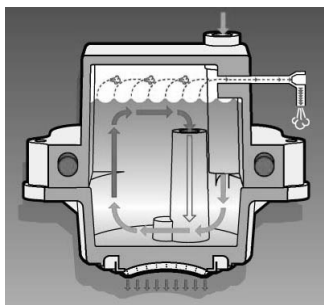
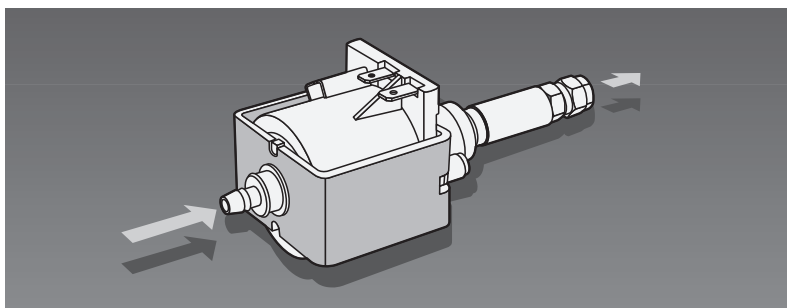

'Boiler' heating system

Ensures the precise temperature is achieved. Espresso needs to be made with hot, rather than boiling water. By heating the water to 92°C (just below boiling point), it allows the water to fully extract the oils from the coffee.

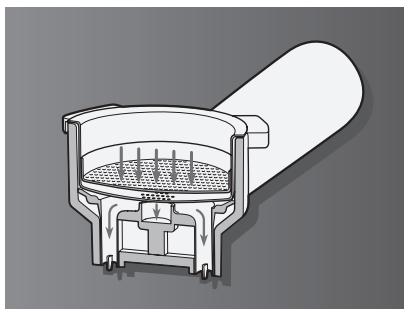

'Crema' system

Italian designed, the dual-wall filter creates additional back pressure and the stabilising baffle produces a steady pour.

Operations Guide for your Café Ristretto™

The diagrams below and on the following pages are to assist you in using your Sunbeam Café Ristretto™. Each of the diagrams is numbered. Throughout this instruction manual these numbers will be referred to.

For example: Fill the water reservoir (1) (2) (3) (4) (5) with cold tap water...

Each time you see these numbers please refer back to the diagrams at the front of the instruction manual.

Filling the water reservoir.

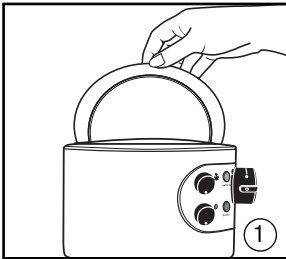

Open lid of water reservoir.

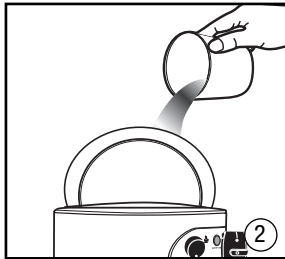

Fill in place with cold water, OR

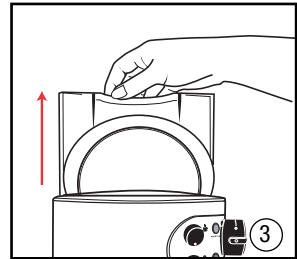

Remove water reservoir.

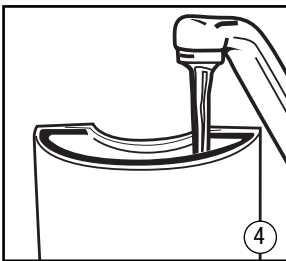

Fill at sink with cold water.

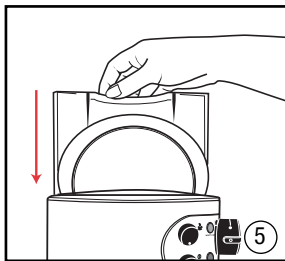

Replace the water reservoir.

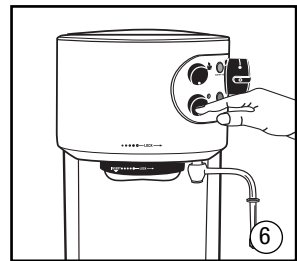

Press 'Power' button to
turn unit on.

Preparing the espresso machine.

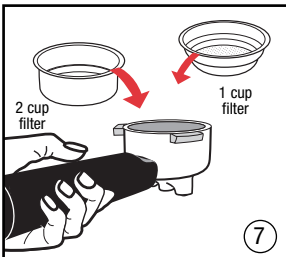

Select Filter.

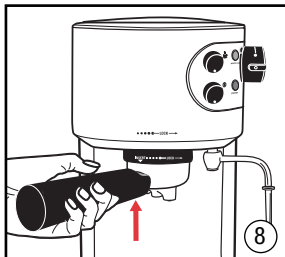

Place filter handle onto
brewing head.

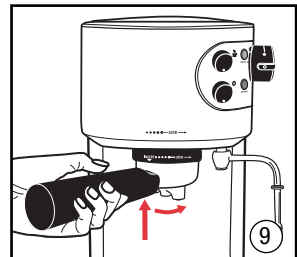

Turn filter handle
to the right.

Operations Guide for your Café Ristretto™ (continued)

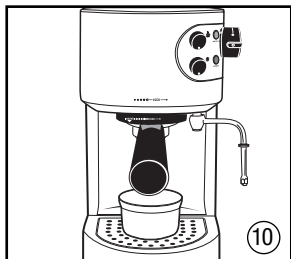

Place container under filter handle.

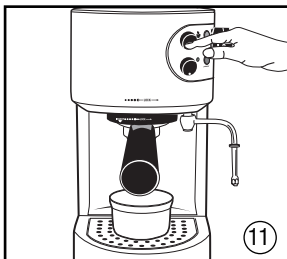

Press the ☕ button.

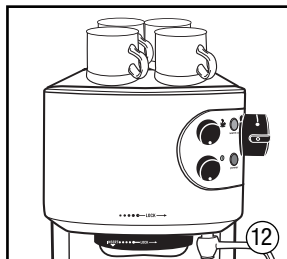

Warming espresso cups.

Making an Espresso.

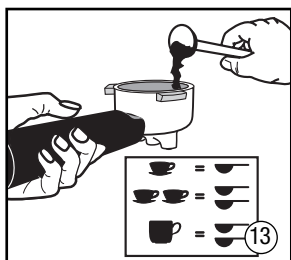

Place coffee in filter.

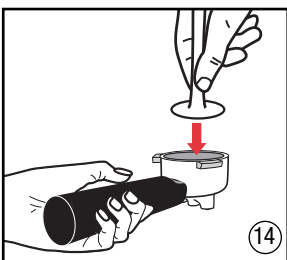

Tamp the coffee.

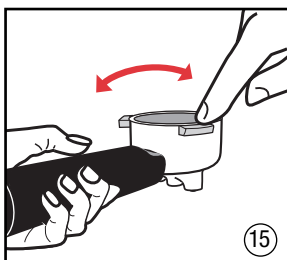

Wipe the edge of filter to remove any coffee grinds.

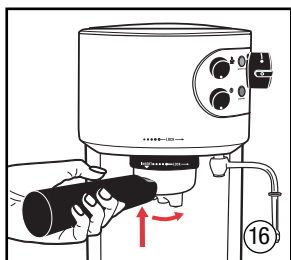

Place filter handle onto brewing head and turn handle to the right.

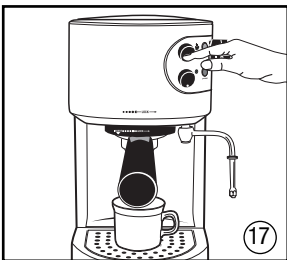

Press the ☕ button to make an espresso.

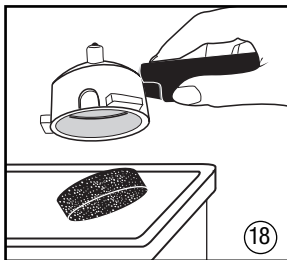

Remove used coffee grinds.

Frothing Milk.

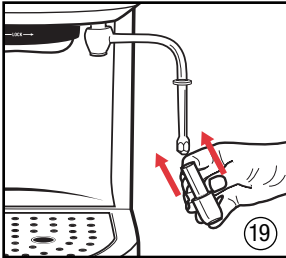

Attach the froth enhancing steam attachment to the steam arm.

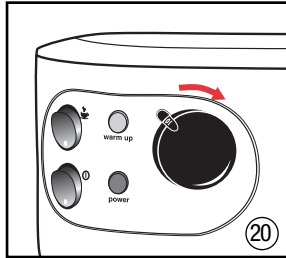

Turn the steam dial to the 'Pre-heat' setting.

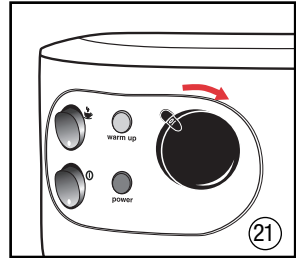

Turn the steam dial to the 'steam' setting to froth milk.

Care and Cleaning.

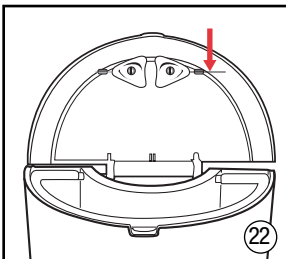

Remove the long 'black' steam nozzle cleaning wire from the underside of the water reservoir lid.

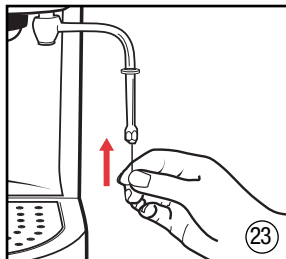

Insert cleaning wire into the hole in the base of the steam nozzle.

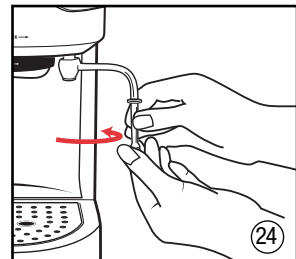

Remove steam nozzle from steam arm.

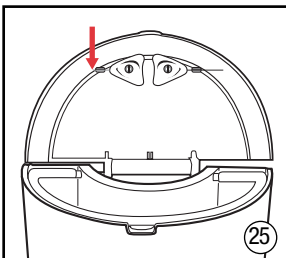

Remove the short 'grey' filter cleaning wire from the underside of the water reservoir lid.

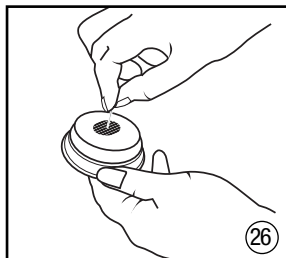

Insert the cleaning wire into the single hole in the base of the filter.

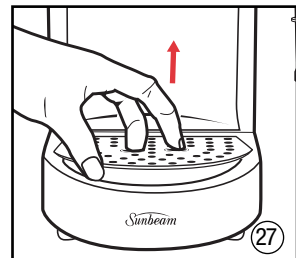

Remove the drip tray grid.

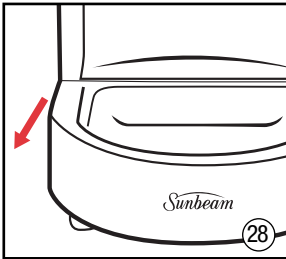

To remove drip tray, lift out and toward you.

Secrets to the perfect cup

With a Sunbeam pump espresso machine and a little experience, you can create café-quality coffee at home. Here are a few helpful suggestions:

- A single shot of espresso should result in only 30-35mls of coffee.
- The grind of coffee is critical. Use a fine to medium grind for domestic espresso machines.
- A common mistake is running too much water through the ground coffee, resulting in a thin and bitter tasting espresso.
- Ensure your coffee grinds are 'tamped' evenly. 'Tamping' refers to the amount of pressure with which coffee grinds are packed into the filter.
- If your espresso pours too slowly, tamp the coffee grind more lightly, or try a coarser grind.
- If your espresso is thin and watery, tamp the coffee grinds harder, or try a finer grind.
- Always use cold milk and a clean stainless steel jug when steaming.
- Don't boil the milk when steaming. The ideal temperature is when the jug becomes too hot to touch.
- Always use the freshest beans or ground coffee available and store in an airtight container in a cool, dry, dark place.
- Whole bean coffee stays fresh longer than ground coffee.
- When grinding your own coffee, never grind more than you will use for immediate brewing. Once ground, the coffee will begin to lose its flavour.
- Although not recommended, if you need to keep coffee for extended periods of time, it's best to freeze the coffee. Although before use, ensure that the coffee has been allowed to thaw to room temperature.
- Keep your espresso machine clean and thoroughly rinsed. Run water through the brewing head and flush the steaming arm in fresh water after each use.
- Little things count – warming your cups, using filtered water and serving the coffee immediately after brewing do make a difference.

Easy steps for frothing milk

Milk texturing is the steaming of milk to heat it and to create froth. Similar to making an espresso, perfecting the art of milk texturing takes time and practice.

- Attach the froth enhancing attachment to the end of the steam wand/arm on your espresso machine. You can also choose to steam the milk without the attachment.
- Using fresh, cold milk, fill a stainless steel frothing jug to no more than $\frac{1}{3}$ full.
- The amount of milk you steam should be adequate for the coffees you are preparing. Keep in mind that the volume of milk will increase or 'stretch' during the texturing process.
- Turn the steam dial to the 'Pre-Heat' setting (20), the 'Warm-Up' light will turn on. Place the steam wand/arm into the milk, about a centimetre below the surface. Once the 'Warm-Up' light turns off, turn the steam dial to the steam '☺' setting (21). Lower the jug so that the tip of the steam arm is just below the surface of the milk.
Note: You should hear a hissing sound. If you are creating large bubbles, raise the jug so that the tip of the steam arm is lowered into the milk.
- Position the tip of the steam arm to one side of the jug to create a whirlpool motion in the milk. As the milk begins to rise in the jug, follow the level of milk always keeping the steam arm just below the surface.

- Once the milk has stretched to double its original volume, lower the steam arm further into the milk and continue the whirlpool motion. This will give the milk a fine texture without big bubbles.
- Cease steaming when the frothing jug becomes too hot to continue holding the palm of your hand against the side.
- Pour the textured milk into your espresso as soon as possible.

Important cleaning instructions for the steam wand/arm

The steam wand/arm and froth enhancing attachment needs to be cleaned each time you froth milk. To clean the steam wand/arm, wipe with a damp cloth and rinse the froth enhancing attachment under warm water. Should your steam wand/arm become blocked, supplied with your espresso machine is a cleaning wire. The cleaning wire for the steam arm is the long BLACK pin, located on the underside of the water reservoir lid (22). With the cleaning wire insert it into the hole in the base of the steam wand/arm (23).

If the steam wand/arm remains blocked, using the measuring spoon/tamp unscrew the steam nozzle from the steam arm (24). Clean the steam nozzle by once again using the cleaning wire and then flush under running water.

Before using your Café Ristretto™

Before using your Café Ristretto™ for the first time or if you have not used it for some time, rinse the machine by running water through without coffee in the filter handle, as follows:

Note: Throughout these instructions the numbers you see highlighted and in brackets refer back to the diagrams at the start of this instruction manual.

- Open the lid of the water reservoir (1) and fill with cold water (2). Alternatively you can open the lid and remove the water reservoir using the handle (3). Then fill with cold water (4).
- Replace the water reservoir firmly into the unit (5) and close lid.
- Insert the power cord into a 230-240V AC power outlet and turn the power on. Start the unit (6) by pressing the 'Power' button. The power light will illuminate red and remain on until the power outlet is turned off. In addition, the 'Warm-Up' light will illuminate amber, this is to indicate that your espresso machine is 'On' and 'Heating' to the required temperature.

Note: Before turning 'On' your Café Ristretto™ ensure that the steam dial on the control panel is not in the '☁' steam or 'Pre-Heat' setting, but is in the '●' off position.

- Place one of the filters in the filter handle (7). Then position the filter handle onto the machines brewing head.
- To ensure that the filter handle is in the correct position, turn the handle so it points to the left and place the filter handle flat against the brewing head (8), then turn the handle towards the right (9), as far as it can go.

Note: Do not over tighten.

- Place a sufficiently large container under the filter handle (10).
- As soon as the amber 'Warm-Up' light goes out, this indicates that the Café Ristretto™ is ready to be used.

Tip: Remember that if the 'Warm-Up' light is 'On' it means the espresso machine is 'Heating'. If the 'Warm-Up' light is Off then you can start using the espresso machine.

- Press the ☕ button (11) and allow all the water in the water reservoir to run through.
- If necessary, you may need to stop the operation by pressing the ☕ button again, empty the container, then resume the operation.

Note: Make sure the water reservoir is clean and free of any debris, as any fine particles can block the water flow.

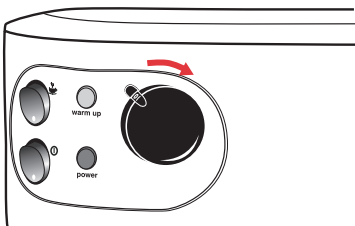

Functions of your Café Ristretto™

1. ESPRESSO FUNCTION

For best results, it is ideal to pre-heat your cups, filter handle and filter as follows:

- Insert the power cord into a 230-240V AC power outlet and turn the power on.
- Fill the water reservoir **(1) (2), (3) (4) (5)** with cold water and start the appliance **(6)**.
- Put the filter handle and an empty filter in place **(7) (8) (9)**, and place cups underneath the filter handle.
- As soon as the 'Warm-Up' light turns 'Off', this indicates that the Café Ristretto™ is ready to be used.

Tip: Remember that if the 'Warm-Up' light is 'On' it means the espresso machine is 'Heating'. If the 'Warm-Up' light is 'Off' then you can start using the espresso machine.

- Press the ☕ button **(11)**.
- When the cups are full of hot water, press the ☕ button again to stop the water flow.

Note: Once the appliance has been on for a while, the coffee cups can be warmed by placing them upside down on the cup warming plate **(12)**.

Preparing an espresso:

- Insert the power cord into a 230-240V AC power outlet and turn the power on.
- Fill the water reservoir **(1) (2), (3) (4) (5)** with cold water.
- Turn the Café Ristretto™ 'On' **(6)**. The power light will illuminate red and an amber 'Warm-Up' light will turn 'On' indicating that your espresso machine is 'On' and 'Heating' to the required temperature.
- Pre-heat your coffee cups.
- Select the required filter **(7)** for 1 or 2 cups of coffee and place in the filter handle.

- Using the measuring spoon supplied, place one or two measures of ground coffee into the filter **(13)**. With the other end of the measuring spoon, use the tamper to push (pack) down the coffee grinds **(14)**. Do not apply too much pressure.

Important: Be sure not to over-fill the filter with too much coffee. Wipe around the edge of the filter to remove any coffee grinds **(15)**.

- Place the filter handle on the machines brewing head. Position the handle so it points to the left, place the filter handle flat against the brewing head, then turn the handle towards the right **(16)** as far as it can go.



Note: Do not over tighten.

- Place 1 or 2 pre-heated cups below the pouring spouts.
- When the Café Ristretto™ is at the correct temperature the 'Warm-Up' light will turn 'Off'.

Tip: Remember that if the 'Warm-Up' light is 'On' it means the espresso machine is 'Heating'. If the 'Warm-Up' light is 'Off' then you can start using the espresso machine.

- To make an espresso press the ☕ button **(11)**. Once the cups are filled to the desired level, press the ☕ button again to stop the flow.
- Remove the filter handle and the filter by turning the filter handle to the left.
- To remove the used coffee grinds from the filter, simply turn the filter handle upside down in a bin and gently spoon out the used coffee grinds **(18)**.

Functions of your Café Ristretto™ (continued)

- For best results when making consecutive cups of espresso we recommend that you flush a small amount of water through the machine after each use. With the filter handle already removed from the brewing head simply press the  button and allow the water to run through. Once you have a consistent flow of water, press the  button again to stop. This will wash out any old or used coffee grinds stuck to the underside of the brewing head and also help ensure the correct water temperature for your next shot of espresso.

Note: Do not leave the filter handle locked in position for extended periods, or when machine is not in use. This shortens the life of the brew head rubber seal.

2. STEAM FUNCTION

The froth enhancing attachment makes it easy to produce textured milk.

Note: We recommend that you make the espresso first, then steam the milk.

- Attach the froth enhancing attachment to the end of the steam arm **(19)**. You may also choose to steam the milk without the attachment.
Important: For the froth enhancing attachment to work you must ensure that it is pushed firmly onto the steam arm.
- Fill the water reservoir **(1) (2) (3) (4) (5)** with cold water.
- Turn the Café Ristretto™ 'On' **(6)**. The power light will illuminate red and an amber 'Warm-Up' light will turn 'On' to indicate that your espresso machine is 'On' and 'Heating' to the required temperature.
- Swing the steam arm to the side of the machine.
- Pour cold milk into a stainless steel frothing jug to no more than $\frac{1}{3}$ full.

Note: For best results we recommend to use refrigerated milk and a stainless steel jug that is well chilled.

- When the Café Ristretto™ is at the correct temperature the 'Warm-Up' light will turn 'Off'.

Tip: Remember that if the 'Warm-Up' light is 'On' it means the espresso machine is 'Heating'. If the 'Warm-Up' light is 'Off' then you can start using the espresso machine.

- Turn the steam dial to the 'Pre-heat' setting **(20)**, the 'Warm-Up' light will turn 'On'. Place the steam wand/arm into the milk, about a centimetre below the surface. Once the 'Warm-Up' light turns 'Off', turn the steam dial to the steam  setting **(21)**. Lower the jug so that the tip of the steam arm is just below the surface of the milk.

Important: Do not allow the tip of the steam arm to touch the bottom of the container because this could obstruct the passage of the steam.

- Position the tip of steam arm to one side of the jug to create a whirlpool motion in the milk. As the milk begins to rise in the jug, follow the level of milk, always keeping the tip of the steam arm just below the surface.
- Cease steaming when the frothing jug becomes too hot to continue holding the palm of your hand against the side. Simply turn the steam dial to the '●' off position and remove the jug.

Note: Do not boil the milk.

- Pour the textured milk into your espresso as soon as possible.

Functions of your Café Ristretto™ (continued)

Cleaning the steam wand/arm and froth attachment

You must clean the steam wand/arm and froth attachment immediately after each use. Simply wipe the stainless steel steam wand/arm clean with a damp cloth and place the froth attachment under warm running water to remove any excess milk. Also, briefly turn the steam dial to '☁' steam setting, to clear any remaining milk out of the steam wand/arm.

Caution: Steam from the wand/arm is extremely hot and there is danger of scalding.

Note: Should your steam wand/arm become blocked, supplied with your espresso machine is a cleaning wire. The cleaning wire for the steam arm is the long BLACK pin, located on the underside of the water reservoir lid **(22)**. With the cleaning wire insert it into the hole in the base of the steam wand/arm **(23)**. Should the steam wand/arm remain blocked, using the measuring spoon/tamp unscrew the steam nozzle from the steam arm **(24)**. Clean the steam nozzle by once again using the cleaning wire and flush under running water.

Care and Cleaning

The coffee making process involves extracting oils out of coffee grinds to make espresso coffee. Deposits of these oils build up over time and affect the taste of the coffee and operation of the espresso machine.

Regular cleaning to remove these oils is essential for espresso machines to keep operating effectively. Flushing water, through the brewing head and the steam wand/arm, is the easiest way to keep your machine clean after making each coffee, and at the end of your coffee making session.

Important: Never wash your espresso machine accessories in the dishwasher.

Drip tray

Remove the grid and drip tray at regular intervals to empty **(27) (28)**.

Clean the drip tray and its grid with water and a little non-abrasive washing up liquid, rinse and dry.

The brewing head, filters & filter handle

The filter and filter handle should be washed after each use by rinsing them under warm water. Wash at regular intervals in warm soapy water using a mild detergent.

To clean the brewing head, flush water through and wipe the head and around the inside rim with a damp cloth.

To assist in keeping the filter and the brew head clean, at the end of each coffee making session we recommend you run the machine, with the filter in place, without coffee – using water only. Should the holes in the filters become clogged with coffee granules use a fine bristled brush to remove them.

Important: Should the filter remain blocked after normal cleaning, supplied with your espresso machine is a cleaning wire. The cleaning wire for the filter is the short GREY pin, located on the underside of the water reservoir lid **(25)**. With the cleaning wire insert it into the single hole in the base of the filter **(26)**.

Brew head rubber seal

This seal is located in the brewing head and creates a seal against the filter handle when making an espresso.

Note: When your Café Ristretto™ is not being used, we recommend that you do not leave the filter handle attached to the machine as this will reduce the life of the seal.

Over time this seal loses its elasticity and will require replacement – usually every 6-12 months. Signs that the seal is deteriorating are when: the filter handle rotates to the far right and feels loose, or steam/water escapes from around the brewing head during use.

The cup warming plate and exterior

Wipe over the unit with a damp cloth and wipe dry. Do not use abrasives or metal scourers, as these will scratch the exterior surface.

Steam wand/arm and froth attachment

The steam wand/arm and froth attachment needs to be cleaned each time you froth milk or heat any other liquid. To clean the steam wand/arm, wipe with a damp cloth and for the froth attachment, simply rinse it under warm water.

Care and Cleaning (continued)

On a monthly basis we recommend thoroughly cleaning the steam wand/arm. To do this soak the wand/arm in water, ensure that the water level in the jug is over the wand/arm. Run steam through the wand/arm for 30 seconds, then leave to soak overnight. In the morning turn the machine on and run steam through the wand/arm again for 30 seconds.

Important: Do not wash parts in the dishwasher. Do not immerse the unit in water.

Important: Should your steam wand/arm become blocked, supplied with your espresso

machine is a cleaning wire. The cleaning wire for the steam arm is the long BLACK pin, located on the underside of the water reservoir lid **(22)**. With the cleaning wire insert it into the hole in the base of the steam wand/arm **(23)**. Should the steam wand/arm remain blocked, using the measuring spoon/tamp unscrew the steam nozzle from the steam arm **(24)**. Clean the steam nozzle by once again using the cleaning wire and then flush under running water.

Descaling

After continued use, your espresso machine may develop a build-up of mineral deposits. Thus your machine will require occasional 'descaling'.









We recommend that you descale your machine every 2-3 months, although this period will depend on the hardness of water and frequency of use of the machine.

Descaling solution

Use Sunbeam Liquid Descaler, which is available at any Sunbeam Service Centre listed in the Guarantee leaflet. Alternatively, dissolve 3 tablespoons of vinegar in two litres of lukewarm water.

Descaling the espresso machine

Note: Ensure that the espresso machine is turned off and the power cord is unplugged.

1. Remove the water reservoir from the machine and if necessary empty any water.
2. Remove the drip tray and place it out of the way.
3. Remove the filter holder from the machine and rinse it thoroughly under running water and set aside.
4. Place a cloth/tea towel on the bench and carefully turn the machine upside down. The machine should now be on the warming plate resting on the cloth/tea towel.
5. Using a screwdriver, unscrew the brewing filter from the brewing head.
6. Remove and set aside the washer and screw in a safe place.
7. Remove the filter from the centre hole using the tip of a fork or a skewer. Wash the filter in hot soapy water, rinse and dry well. Set aside in a safe place.
8. Using a small brush, scrub in and around the area of the brewing head, removing all coffee granules.
9. Remove the froth enhancing steam attachment, wash thoroughly under running water and set aside. Wipe down the steam wand/arm with a small brush.
10. Turn the machine upright, so that it is now sitting correctly on the bench.
11. Fill the water reservoir with water to the 'MAX' line and add 1 capful of Sunbeam Liquid Descaler or alternatively fill the water reservoir with the vinegar solution. Place the water reservoir onto the espresso machine.
12. Place a large container under the brewing head and another container under the steam nozzle.
13. Insert the power cord into a 230-240V AC power outlet and turn the power 'On'.
14. Press the  button. Run through about $\frac{1}{3}$ of the liquid immediately.
15. Once you have run through about $\frac{1}{3}$ of the liquid press the  button to stop the water flow. Turn the steam dial to the '' steam setting and allow the solution come through the steam wand/arm for 2 minutes.
16. After 2 minutes stop the machine by pressing the 'Power' button on the machine. Now that the machine is 'Off', turn the steam dial to the '' off position.
17. Press the  button and allow $\frac{1}{2}$ of the rest of the descaler solution to run through the brewing head, then press the  button again to stop the water flow.
18. Turn the steam dial to the '' steam setting and allow the solution to come through the steam wand/arm. After 3-4 minutes turn the steam dial to the '' off position.

Descaling (continued)

19. To finish, press the ☕ button and allow the remaining water in the reservoir to run through the brewing head.
20. Remove and empty the containers placed under the brewing head and steam wand/arm. Once emptied, once again place one under the brewing head and the other under the steam nozzle.
21. Remove the water reservoir from the machine and rinse thoroughly under running water, ensuring that all traces of the descaling solution is removed. Fill the water reservoir with clean water and place onto the machine.
22. Run two (2) full water reservoirs through the brewing head. Refill the water reservoir and run the steam wand/arm for 4-5 minutes.
Note: Ensure that you continue to run water through the machine until the water runs clean and clear.
23. When this is finished, remove the water reservoir and set aside. Remove the water containers and give the machine a good wipe over.
24. Turn the machine upside down. The machine should now be on the warming plate resting on the cloth/tea towel once again.
25. Carefully replace the rubber seal, filter, washer and screw. Tighten well.
26. Turn the machine upright, so that it is now sitting correctly on the bench.
27. Replace the drip tray and froth enhancing steam attachment onto the steam nozzle.
28. Fill the water reservoir with water and position it on to the machine.

Trouble Shooting Guide

Problem	Possible cause	What to do
Coffee runs down the side of the filter handle	Filter handle is not attached correctly, or has not been tightened sufficiently.	See "Preparing an espresso" pg13.
	Edge of filter insert is not free of coffee granules.	Clean around the top edge of the filter and wipe the brewing head clean of coffee.
	The brewing head is dirty.	Wipe brewing head with a damp cloth.
	The brewing head is defective.	Contact a Sunbeam Service Centre.
	Brew head rubber seal is damaged or worn.	Contact a Sunbeam Service Centre.
No coffee runs through.	No water in the water reservoir.	Fill reservoir with water.
	Water reservoir not correctly assembled.	Press firmly down on the water reservoir to ensure it is correctly positioned.
	Steam dial set to '☺' setting.	Ensure the steam dial is in the '●' off position.
	Brewing filter may be blocked.	See "Descaling the espresso machine" pg18.
	The filter is blocked, the coffee grounds are too fine or tamped down too hard.	Empty out the filter and rinse under water to clean. Wipe the brewing head with a cloth. Repack the filter with coffee and tamp down coffee. See "Care & Cleaning" pg16.
Coffee pours out in drops.	Coffee grounds are too fine or are too compacted.	Ensure you are using an evenly ground coffee and do not compact the grounds so firmly.
	Machine blocked by scale build up.	See "Descaling the espresso machine" pg18.
Espresso does not have any Crema.	Coffee is old or dry.	Use fresh coffee and once you open the coffee be sure to store it in an airtight container.
	Coffee not compacted firmly enough.	Compact coffee grounds more firmly.
	Coffee too coarse.	Grind the coffee to a finer texture or change brands of espresso coffee to a finer grind.
	Not enough coffee in filter.	See "Functions of your Café Ristretto™" pg13.
Handle comes off during brewing.	Coffee tamped too hard.	Tamp the coffee grinds lighter.
	Coffee grind is too fine.	Change to a coarser grind of coffee.
	Filter handle is not attached correctly, or has not been tightened sufficiently.	See "Preparing an espresso" pg13.
	Top edge of filter is not free of coffee granules.	Clean around the edge of the filter and wipe the brewing head clean of coffee.

Trouble Shooting Guide (continued)

Problem	Possible cause	What to do
Handle comes off during brewing.	The brewing head is dirty.	Wipe brewing head with a damp cloth.
	The brewing head is defective.	Contact a Sunbeam Service Centre.
	Brew head rubber seal is worn or damaged.	Contact a Sunbeam Service Centre.
Coffee is too cold.	Cups, filter and filter handle are cold.	Pre-heat cups, filter, handle and filter See "Functions of your Café Ristretto™" pg13.
	If making a cappuccino or latte the milk may not be heated enough.	Ensure that milk is heated properly during frothing, but be sure not to boil the milk, See "Easy steps for frothing milk" pg11.
No steam from the steam wand/arm.	Steam wand/arm is blocked.	See "Care & Cleaning" pg16.
Not enough froth when frothing milk.	Milk is not fresh.	Ensure the milk is fresh.
	Milk temperature is too warm.	Ensure that the milk is well refrigerated before use.
	Frothing jug.	For best frothing results use a stainless steel jug and if possible refrigerate or run the jug under cold water before use.
	Steam wand/arm is blocked.	See "Care & Cleaning" pg16.
	Milk has been boiled.	Start again with fresh, chilled milk.
	The milk is making bubbles rather than frothing.	Ensure that the froth attachment is correctly positioned on the steam wand/arm. The tip of the steam wand/arm or frothing attachment should be positioned just below the surface of the milk.
Uneven cup filling.	Uneven tamping or obstruction in the pouring spouts.	Ensure coffee is tamped evenly and check that there is nothing obstructing the pouring spouts.
	Defective baffle in filter handle	Contact a Sunbeam Service Centre.
Espresso tastes burnt.	Type of coffee being used.	Experiment with different brands of coffee.
	Appliance has not been rinsed properly after descaling.	Run a reservoir full of water through the machine before making another coffee.
Pump makes an unusually loud noise.	No water in reservoir.	Fill the water reservoir.
	Water reservoir not correctly positioned.	Replace the water reservoir firmly into the unit.
Espresso machine does not operate.	Brewing filter may be blocked.	Remove filter holder and clean brewing head. See "Care & Cleaning" pg16.
	Machine blocked by scale build up.	See "Descaling the espresso machine" pg18.

Please contact Sunbeam directly on Freecall 1800 025 059, if this guide does not solve your query. We have experienced staff on hand to assist, Monday to Friday.

Recipes

ESPRESSO (SHORT BLACK)

Espresso is a concentrated, full bodied coffee with a stable layer of cream on top – known as 'crema'. An espresso is the foundation of all café coffee. Variations are achieved by adding different amounts of milk and froth.

- 90mL espresso glass or demitasse cup
- single espresso (30-35mL)



MACCHIATO

Macchiato, Italian for 'to stain or mark'. Traditionally served as a standard espresso with a dash of milk and a small dollop of froth into the middle of the 'crema'.

- 90mL espresso glass or demitasse cup
- single or double espresso
- marked with steamed milk froth



LONG BLACK

A standard espresso with hot water, served in a regular coffee cup or mug. The hot water is added first so that the 'crema' is maintained.

- 190mL cup
- hot water (to taste)
- single or double espresso



FLAT WHITE

Another old favourite, the Flat White is an espresso with steamed milk, served in a regular coffee cup or mug. The layer of frothed milk on top should be 2mm to seal the coffee.

- 190mL cup
- single or double espresso
- steamed milk



Recipes (continued)

CAFFE LATTE

An espresso with steamed milk, typically served in a glass. The layer of frothed milk on top should be 10mm to seal the coffee.

- 220mL glass or cup
- single or double espresso
- steamed milk



CAFFE MOCHA

Made in a similar way to a cappuccino but with the addition of drinking chocolate. Simply stir the chocolate into the espresso prior to adding the steamed milk and froth.

- 190-240mL cup or tall glass
- single or double espresso
- two teaspoons of drinking chocolate
- two-thirds milky coffee, one-third froth



CAPPUCCINO

This delicious drink is an espresso with steamed milk, topped with creamy froth and a dusting of chocolate. The resulting drink is approximately two-thirds milky coffee, one-third froth.

- 190-240mL cup
- single or double espresso
- two-thirds milky coffee, one-third froth
- dusted with chocolate



CON PANNA

A variation on the original Vienna coffee, this delicious drink is made up of an espresso topped with lightly whipped cream. It can also be dusted with cinnamon or drinking chocolate.

- 190mL cup
- single or double espresso
- lightly whipped cream
- dusted with cinnamon or chocolate



Notes



Consumer Hotline

Australia

1800 025 059

New Zealand

(09) 912 0747

Consumer information:

1800 025 059 or www.sunbeam.com.au



is a registered Trademark of Sunbeam Corporation Limited. ACN 000 006 771.

© Sunbeam Corporation Limited 2003.

Free Manuals Download Website

<http://myh66.com>

<http://usermanuals.us>

<http://www.somanuals.com>

<http://www.4manuals.cc>

<http://www.manual-lib.com>

<http://www.404manual.com>

<http://www.luxmanual.com>

<http://aubethermostatmanual.com>

Golf course search by state

<http://golfingnear.com>

Email search by domain

<http://emailbydomain.com>

Auto manuals search

<http://auto.somanuals.com>

TV manuals search

<http://tv.somanuals.com>