

Sunbeam

Convection Bake & Grill

17L Stainless Steel Convection Oven

Instruction Booklet
BT6700

Please read these instructions carefully
and retain for future reference.



Contents

Sunbeam's Safety Precautions	1
Features of your Convection Bake & Grill	2
Using your Convection Bake & Grill	7
Cooking Guide	11
Roasting Guide	12
Grilling Guide	13
Roasting tips for Vegetables	14
Care and Cleaning	15
Recipes	16

Important instructions – retain for future use.

تأكد من تفهم احتياطات السلامة المذكورة اعلاه

請務必理解上述的安全預防措施。

Assurez-vous que les précautions ci-dessus relatives à la sécurité sont bien comprises

Versichern Sie sich, dass die obenstehenden Sicherheitsmaßnahmen verstanden werden

Βεβαιώνετε πως οι παραπάνω προφυλάξεις ασφαλείας γίνονται κατανοητές

Pastikan bahwa tindakan-tindakan keselamatan seperti di atas dimengerti anda

Accertatevi che le suddette norme di sicurezza siano comprese a dovere

上記の注意事項をよくお読みになり、安全を御確認ください

Уверете се дека погоре споменатите мерки на претпазливост се добро разбрани

Asegúrese de que las precauciones de seguridad precedentes sean bien comprendidas

کاری بکنید کہ احتیاط‌های بالا حتماً درک بشوند

ต้องแน่ใจว่า ข้อควรระวังเรื่องความปลอดภัยข้างต้น เป็นที่เข้าใจกันดี

Yukarda belirtilen güvenlik önlemlerinin anlaşılığundan emin olunuz

Xin kiểm chắc rằng những biện pháp làm an toàn kể trên được hiểu rõ

Sunbeam's Safety Precautions

SAFETY PRECAUTIONS FOR YOUR SUNBEAM CONVECTION BAKE & GRILL, 17L STAINLESS STEEL CONVECTION OVEN.

- Always operate on a flat surface.
- Avoid contact with oven surfaces, including oven door, during and after use, as they will be hot.

- Use well away from walls and curtains.
- Do not place items on top of the oven whilst in use.
- Do not block or cover the air vents on the top, back or side of the oven.
- Do not use in confined spaces.
- Do not immerse the unit in water.

Sunbeam is very safety conscious when designing and manufacturing consumer products, but it is essential that the product user also exercise care when using an electrical appliance. Listed below are precautions which are essential for the safe use of an electrical appliance:

- Read carefully and save all the instructions provided with an appliance.
- Always turn the power off at the power outlet before you insert or remove a plug. Remove by grasping the plug - do not pull on the cord.
- Turn the power off and remove the plug when the appliance is not in use and before cleaning.
- Do not use your appliance with an extension cord unless this cord has been checked and tested by a qualified technician or service person.
- Always use your appliance from a power outlet of the voltage (A.C. only) marked on the appliance.
- This appliance is not intended for use by persons (including children) with reduced physical, sensory or mental capabilities, or lack of experience and knowledge, unless they have been given supervision or instruction concerning use of the appliance by a person responsible for their safety.
- Children should be supervised to ensure that they do not play with the appliance.
- The temperature of accessible surfaces may be high when the appliance is operating.

- Never leave an appliance unattended while in use.
- Do not use an appliance for any purpose other than its intended use.
- Do not place an appliance on or near a hot gas flame, electric element or on a heated oven.
- Do not place on top of any other appliance.
- Do not let the power cord of an appliance hang over the edge of a table or bench top or touch any hot surface.
- Do not operate any electrical appliance with a damaged cord or after the appliance has been damaged in any manner. If damage is suspected, return the appliance to the nearest Sunbeam Appointed Service Centre for examination, repair or adjustment.
- For additional protection, Sunbeam recommend the use of a residual current device (RCD) with a tripping current not exceeding 30mA in the electrical circuit supplying power to your appliances.
- Do not immerse the appliance in water or any other liquid unless recommended.
- Appliances are not intended to be operated by means of an external timer or separate remote control system.
- This appliance is intended to be used in household and similar applications such as: staff kitchen areas in shops, offices and other working environments; farm houses; by clients in hotels, motels and other residential type environments; bed and breakfast type environments.

If you have any concerns regarding the performance and use of your appliance, please visit www.sunbeam.com.au or contact the Sunbeam Consumer Service Line.

Ensure the above safety precautions are understood.

Features of your Sunbeam Convection Bake & Grill

Non-stick interior walls

Requires minimal effort for a quick and easy clean-up.

Rack support guides

With three rack support guides: upper, middle and lower, each cooking function is maximised.

Removable crumb tray

This conveniently positioned crumb tray slides out for emptying without the need to open the door and has a cool touch handle for added safety.

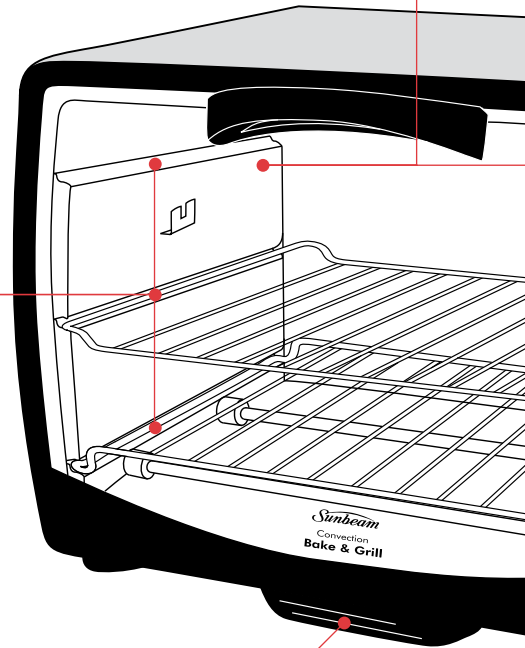

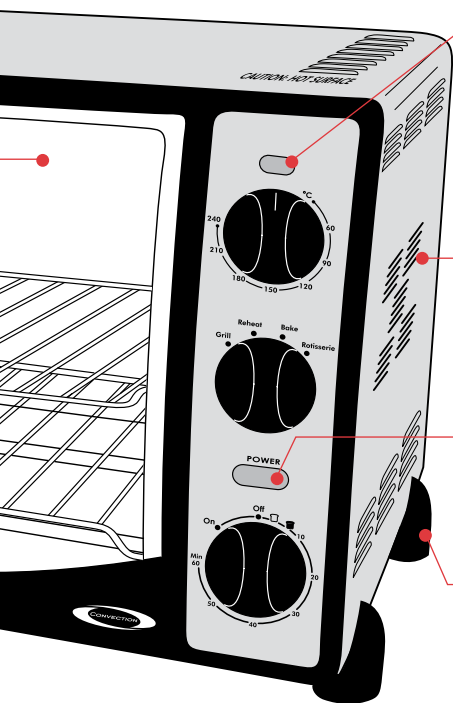

Thermostat light

Light on indicates that the oven is heating. When the set temperature is reached, the light will switch off. During the cooking process this light will turn on and off occasionally to ensure that the desired temperature is maintained constantly throughout the oven.

Fan-assisted convection technology

Fan-assisted convection technology combined with a powerful 1600 watt oven ensures even cooking results.

Power on light

Indicates when the oven is turned on. Will light up when the timer or 'on' setting has been selected.

Non-slip rubber feet

Keeps the oven secure on the bench top during use and prevents scratching of bench top surfaces.

Features of your Sunbeam Convection Bake & Grill (continued)

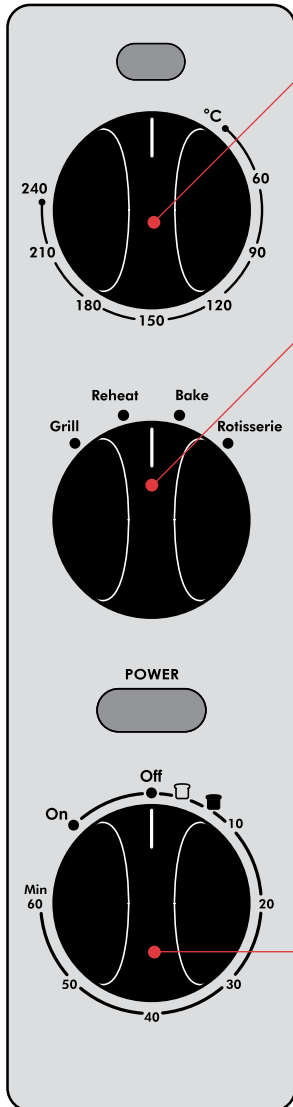

Temperature Control

Variable temperature control allows you to select the perfect temperature for each cooking task. Temperature range is from 60°C to 240°C.

Oven Settings

All oven settings operate with fan assistance. Select from Grill, Reheat, Bake, Rotisserie or Toast (located on the timer control).



Grill: Using the grill function is fast and efficient making it ideal for grilling open sandwiches, sausages and vegetables.



Reheat: Heats food from beneath and is ideal for perfectly reheating leftovers.



Bake: Suitable for roasting baked dinners of pork, lamb and veal as well as baking homemade biscuits, cakes and muffins.



Rotisserie: The rotisserie function roasts a variety of meats and poultry that are tender and juicy inside and browned to perfection on the outside.



Toast: Variable browning control allows you to toast a variety of breads to a desired colour. The white toast icon on the timer control represents the lightest toasting shade and the black toast icon represents the darkest toast shade.

60 minute timer and on/off control

The timer can be set up to 60 minutes and will automatically turn the oven off and sound a bell at the end of the cooking time. Alternatively, the dial can be set to the ON position for continuous operation, until it is turned off manually.

Features of your Sunbeam Convection Bake & Grill (continued)

Enamel baking pan

Enamel baking pan can be used on its own or with the drip tray insert.

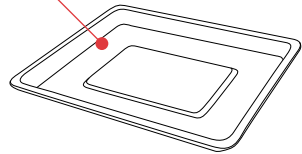

Enamel drip tray insert

The drip tray insert sits inside the baking pan and allows fats to drain away for fat-free cooking. The drip tray also helps to prevent spattering.

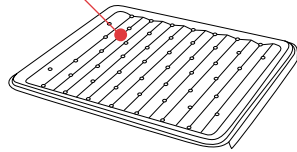

Chrome plated wire racks

The two removable wire racks are reversible and may be used in the raised or sunken position, giving you greater versatility when cooking.

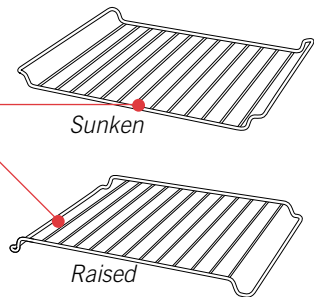

Biscuit trays

The two trays are ideal for baking cookies and pizza and fit securely to the wire racks in the sunken position.

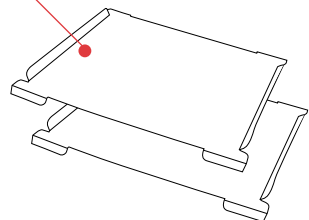

Features of your Sunbeam Convection Bake & Grill (continued)

Chrome plated rotisserie accessories

Rotisserie rod

The pointed end of the rod inserts into the drive socket located on the right hand side of the oven wall and the square end of the rod rests on the rod support located on the left hand side of the oven wall.

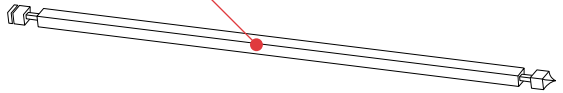

Rotisserie spikes and thumbscrews

The forks position the poultry/meat to the rod and are secured in place by firmly screwing the thumbscrews.

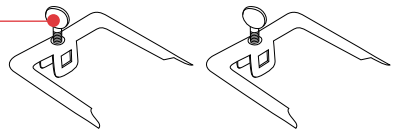

Rotisserie handle

Used for inserting and safely removing the rotisserie rod from the oven after the poultry / meat is cooked.

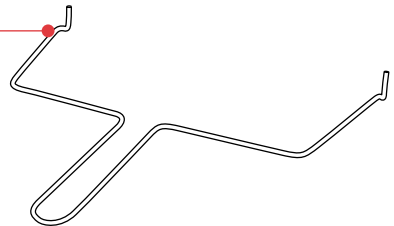

Using your Convection Bake & Grill

Position the oven on a dry, level surface, ensuring that the ventilation slots on the side and top of the appliance are not obstructed. Plug the power cord into a 230-240 volt power outlet and turn the power on.

Note: When turned on for the first time, your Convection Bake & Grill may give off vapours for up to 10 minutes. This is due to the initial heating of the materials used. It is safe, not detrimental to the performance of the oven and will not recoccur.

Important: Do not force open the oven door beyond its limit or let the door drop open as this will distort the doors ability to maintain a proper seal.

To bake or roast

The top two and bottom two elements will heat when the 'Bake' setting has been selected.

1. Place the wire rack, in either the raised or sunken position, into the desired rack support guide.
2. Place the food to be baked on the wire rack, using the appropriate pan, tray etc.
3. Turn the oven setting to 'Bake'.
4. Select the desired temperature on the temperature control.

Note: For best results, allow the oven to preheat for 5 -10 minutes or as per recipe instructions.

Important: If baking cakes, biscuits etc, using recipes other than those provided with this instruction booklet, it is recommended that oven temperatures for the 'Bake' setting be reduced by approximately 20-30°C. As the Convection Bake & Grill operates with fan-assistance, this will prevent excess browning on top of foods before they are fully cooked. The recipes in the back of this book have already been adjusted.

5. To turn the oven on, turn the timer control to the desired time. Alternatively,

for continuous operation, turn the timer control to the ON position.

6. When finished baking, the oven will switch off automatically and a bell will sound if the timer was selected. Alternatively, turn the timer control to OFF position if the continuous mode was selected.

To grill

The top two elements will heat when the 'Grill' setting has been selected.

1. Place the wire rack, in either the raised or sunken position, into the upper rack support guide.
2. Place the drip tray inside the baking pan and position the food on the drip tray. Place the baking pan on the wire rack.
3. Turn the oven setting to 'Grill'.
4. Set the temperature control to maximum 240°C.

Note: For best results, allow the griller to preheat for 5 -10 minutes or as per recipe instructions.

5. To turn the grill on, turn the timer control to the desired time. Alternatively, for continuous operation, turn the timer control to the ON position.
6. When finished grilling, the oven will switch off automatically and a bell will sound if the timer was selected. Alternatively, turn the timer control to OFF position if the continuous mode was selected.

To toast

The top two and bottom two elements will heat when the 'Bake' setting has been selected.

1. Place the wire rack, in the sunken position, into the middle rack support guide.
2. Arrange bread on the wire rack.
3. Turn the oven setting to 'Bake'.
4. Set the temperature control to the

maximum 240°C

Using your Convection Bake & Grill (continued)

5. Select the appropriate setting for your desired toast colour on the timer control, noting that the white toast icon represents the lightest toast shade and the black toast icon represents the darkest shade.
6. A bell will sound when the selected toast cycle has ended.

Note: Toasting times will vary depending on the type of bread used. Sweet and fruit breads generally take less time than white or wholemeal breads.

To reheat

The bottom two elements will heat when the 'Reheat' setting has been selected.

1. Place the wire rack in either the raised or sunken position, into the desired rack support guide, depending on the type of food / dish that is being reheated.
2. Place the food in an oven-proof dish.
3. Turn the oven setting to 'Reheat'.
4. Select the desired temperature on the temperature control. See page 11 for a guide.
5. To turn the oven on, turn the timer control to the desired time. Alternatively, for continuous operation, turn the timer control to the 'ON' position.
6. Stir food occasionally to ensure even reheating of food.

Note: Use oven mitts to remove dish as it will be very hot.

7. When finished reheating, the oven will switch off automatically and a bell will sound if the timer was selected. Alternatively turn the timer to the 'OFF' position if the continuous mode was selected.

Rotisserie

The top two elements will heat when the 'Rotisserie' setting has been selected.

1. Insert the pointed end of the rotisserie rod through one of the spikes, making sure the points of the spike face in the same direction as the pointed end of the rotisserie rod. See Figure 1. Slide the spike 6-7cm towards the squared off end of the rod and secure in place with the thumbscrew. See Figure 2.

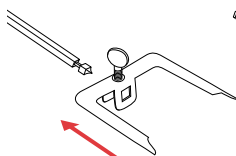

Figure 1

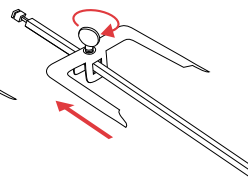

Figure 2

2. Place food to be cooked on the rotisserie rod by running the rod directly through the centre of the food. Continue to slide the food until the spike is securely imbedded in the food.
3. Slide the second spike onto the rotisserie rod at the other end of the food. See Figure 3. Continue to slide the spike until it is securely imbedded in the food and secure the spike with the thumbscrew. See Figure 4.

Using your Convection Bake & Grill (continued)

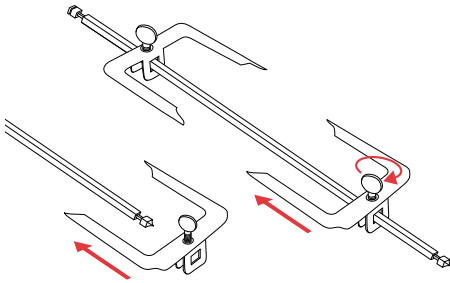

Figure 3

Figure 4

4. Check that the food is centered on the rotisserie rod.
5. Place the wire rack, in the sunken position, into the lower rack support guide.
6. Place the enamel baking pan, without drip tray, onto the wire rack to catch food drippings.
7. Turn the oven setting to 'Rotisserie'.
8. Preheat the oven to the maximum 240°C for 5 -10 minutes or as per recipe instructions.
9. To turn the rotisserie on, turn the timer control to the desired time. Alternatively, for continuous operation, turn the timer control to the ON position.

Note: Turning the rotisserie function on prior to inserting the rod will allow for easier insertion of the rod into the drive socket.

10. Use the rotisserie handle to lift the rotisserie rod, ensuring to place the hooks of the rotisserie handle under the grooves on either side of the rotisserie rod. See Figure 5.

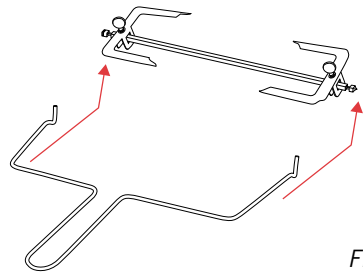
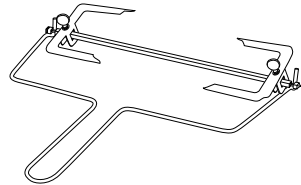

Figure 5



11. Insert the pointed end of the rotisserie rod into the drive socket, located on right-hand side of the oven wall ①, then position the squared off end of the rotisserie rod in the rotisserie rod support located on the left-hand side of the oven wall ②. See Figure 6.

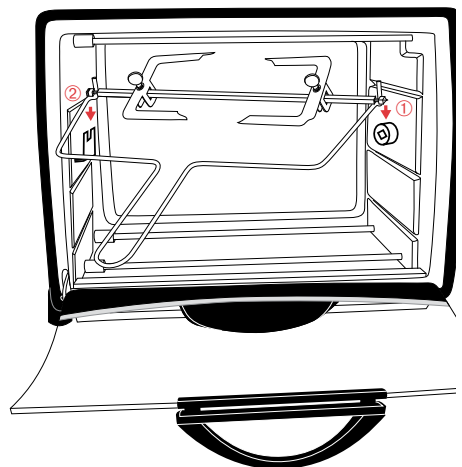

Figure 6

Using your Convection Bake & Grill (continued)

12. When finished cooking, the oven will switch off automatically and a bell will sound if the timer was selected. Alternatively, turn the timer control to OFF position if the continuous mode was selected.

Note: A meat thermometer may be used to check cooking progress.

13. Remove the rotisserie rod by placing the hooks of the rotisserie handle under the grooves on either side of the rotisserie rod. See Figure 5. Lift the left side of the rotisserie rod first, by lifting it up and out. Next, pull the rotisserie rod out of the drive socket using oven mitts and carefully remove the food from the oven.

14. Unscrew the spikes from the rotisserie rod and remove food.

Note: Allow food to rest before removing the rotisserie accessories as they will be hot.

Important: Use oven mitts when disassembling the rotisserie rod and removing food, as the rotisserie accessories will be hot.

Cooking Guide

TEMPERATURE SETTING °C	OVEN TEMPERATURE DESCRIPTION	FUNCTION/FOOD
Low / 60	Warm	Warming plates/dishes
90	Warm	Slow reheating
120	Moderately Warm	Shortbread
150	Moderately Warm	Cakes, reheating
180	Moderate	Roasts, biscuits, quiche
210	Moderately Hot	Pizza, frittata
240	Hot	Rotisserie, scones

Roasting Guide

For best results cook all beef, lamb, veal or pork at 200°C for 15 minutes, then reduce to 180°C and use the remaining cooking times from the chart below:

MEAT	Approximate Time per 500g Cooked at 180°C (after initial 15mins @ 200°C)
Beef – Rare	15 minutes
Beef – Medium	20 minutes
Beef – Well done	25 minutes
Lamb – Medium	20 minutes
Lamb – Well done	25 minutes
Veal – Well done	30 minutes
Pork – Well done	35 minutes

POULTRY	Approximate Time per 500g Cooked at 180°C
Chicken	25-30 minutes

Note: Chicken is cooked when the juices run clear after piercing with a skewer or knife.

Grilling Guide

Preheat compact oven to maximum heat for 5 minutes. Oven rack should be positioned in the highest rack support guide with the rack either sitting raised or sunken position depending on the height of your meat.

Place meat on baking pan with drip tray.

Food Type	Approximate Cooking Times
Thin Sausages – up to 10 sausages	11 minutes, turning occasionally
Thick sausages – up to 8 sausages	18 minutes, turning occasionally
Lamb Chops – up to 8 small chops	5-7 minutes, turning once
Steaks – 2-4 steaks, depending on size	5-10 minutes, turning once.

Note: Cooking time will vary depending on thickness of food and individual preferences.

Roasting tips for Vegetables

Grilled Capsicum

- Preheat compact oven to maximum heat using the Grill setting. Place rack in the top shelf in the sunken position.
- Cut capsicum in half and remove seeds and membrane. Spray with vegetable oil spray.
- Bake for 30 minutes or until skin blackens and blisters.
- Remove from compact oven, and cover with foil until cool enough to handle
- Peel off skin and cut into strips.

Caramelised Onion

- Preheat compact oven 200°C using the Bake setting. Place rack in the middle shelf in the sunken position.
- Line baking pan with aluminium foil; spray with vegetable oil spray.
- Peel and thinly slice one large onion (red is preferable).
- Mix through 1 tablespoon of olive oil and spread over baking tray.
- Bake 30 - 40 minutes, turning tray half way or until onion is soft and browned.

Roasted Sweet Potato or Potatoes

- Preheat compact oven to 180°C using the Bake setting. Place rack in the middle shelf in the sunken position.
- Grease baking tray with vegetable oil spray.
- Peel and chopped sweet potato or potato into 1-2 cm pieces, place on baking tray and spray generously with vegetable cooking spray. Season with sea salt and freshly ground black pepper.
- Bake for 30 minutes or until potato is cooked.

Note: If a cooking spray is not available, lightly apply oil using a brush.

Care and Cleaning

- Always turn the power off and remove the plug from power outlet after use and before cleaning. Allow the compact oven to cool before cleaning.
- It is recommended that you clean the compact oven after each use to prevent a build up of grease and to avoid unpleasant odours.

Note: Do not clean any part of the compact oven in the dishwasher.

- The wire racks, baking pan, drip tray, biscuit trays, crumb tray, rotisserie rod, rotisserie spikes and thumbscrews may be washed in warm soapy water and rinsed.

Note: Never immerse the compact oven in water.

- The non-stick walls and ceiling of the compact oven can be wiped with a mild detergent and a damp cloth.
- To clean the exterior of the compact oven, wipe the walls with a cloth dampened with mild detergent. Polish with a soft dry cloth.
- To clean the glass door, wipe with a damp sponge and dry.

Recipes

Stuffed Mushrooms

Makes 12

- 12 medium cup mushrooms
- 3 rashers bacon, chopped
- 250g cream cheese, softened
- 1 clove garlic, crushed
- ½ bunch chopped chives
- ⅓ cup grated fresh parmesan

1. Preheat compact oven to 210°C using the bake setting. Place wire rack on the middle shelf in the sunken position.
2. Remove stalks from mushrooms.
3. Cook the bacon in a small frying pan until crisp; drain on absorbent paper.
4. Combine bacon, cream cheese, garlic, chives; mix well. Divide mixture evenly among mushrooms caps; sprinkle with cheese. Place mushrooms onto baking pan.
5. Bake in oven for about 8-10 minutes or until the mushrooms have softened and the cheese has browned. Serve immediately.

Soya Sauce Chicken Wings

Makes 20

- 10 chicken wings
- ¼ cup honey
- ⅓ cup low salt soy sauce
- 2 teaspoons Chinese cooking wine
- 2 cloves garlic, crushed
- 3 teaspoons grated fresh ginger

1. Preheat compact oven to 240°C using the bake setting. Place wire rack on the middle shelf in the sunken position.
2. Cut wings at joints and discard tips.
3. Combine remaining ingredients in a jug.
4. Place wings in a single layer on baking tray. Pour sauce over wings and turn to coat.
5. Bake wings, turning occasionally. Cook for about 1 hour or until browned and cooked through.

Tip: Chinese cooking wine is available from Asian grocery stores. If you cannot find it simply replace with sherry or omit completely.

Sweet Potato and Rocket Frittata

Serves 8

- 1 small sweet potato
- 80g baby rocket leaves
- 200g fetta cheese, crumbled
- 250ml thickened cream
- 10 eggs
- Sea salt and freshly ground black pepper, to taste
- ½ cup grated tasty cheese

1. Preheat compact oven to 210°C using the bake setting. Place wire rack on the middle shelf in the sunken position.
2. Grease and line base of a 19cm square shallow cake tin.
3. Peel the sweet potato and slice thinly.
4. Place a layer of sweet potato then rocket then fetta into the cake tin and then repeat layers again. Reserve a few sweet potato slices if possible for the top.
5. Combine the eggs, cream, salt and pepper in a bowl; whisk together. Pour egg mixture into the cake tin and top with the grated cheese.
6. Place frittata into oven, reduce heat to 180°C and cook for about 30-35 minutes or until cooked through. If the frittata starts to brown too much before the inside is completely cooked lay a piece of foil over the top, this will stop excessive browning.

Recipes continued

Bacon and Cheese Quiche

Serves 6-8

1 large sheet frozen short crust pastry, thawed
4 bacon rashers, rind removed, roughly chopped
1 small onion, chopped finely
1 ½ cups grated tasty cheese
4 eggs
1 cup milk
½ cup cream
½ cup self raising flour
pepper to taste

1. Preheat compact oven to 180°C. Place wire rack in the middle shelf position in the sunken position.
2. Lightly spray a quiche dish with vegetable oil spray and line with shortcrust pastry, trimming edges.
3. Cook bacon and onion in a frying pan until tender, remove from pan and drain on absorbent paper; cool.
4. In a large bowl combine the bacon, onion and cheese.
5. Blend or process remaining ingredients until smooth.
6. Place the bacon mixture into the prepared quiche dish and pour the egg mixture over the top.
7. Bake in oven for about 50 minutes or until cooked, turning dish after 25 minutes. Stand for 10 minutes before cutting. Can be served hot or cold.

Note: If quiche starts to brown too much before the centre is cooked reduce heat to 150°C.

Pizza Dough

Makes 2

2 teaspoons (7g) dry yeast
1 teaspoon sugar
¾ cup warm water
2 cups plain flour
½ teaspoon salt

1. Combine the yeast, sugar and water in a bowl; stir to combine. Cover mixture and place in a warm area until the mixture starts to bubble.
2. Combine the yeast mixture, flour and salt in a large bowl and mix until combined. Turn dough onto a floured surface and knead for about 10 minutes or until the dough is firm and elastic. Place dough in a bowl and allow to rest in a warm place until the dough has doubled in size.
3. Using your fist, punch the dough down, fold sides to centre and turn dough over. Place dough onto a floured surface and lightly knead. Cut dough in half. Roll dough out to fit a round baking tray or you can use the biscuit trays provided to make a slab pizza. Dress pizza dough as desired.

Recipes continued

Supreme Pizza

Makes 2 pizzas

1 quantity pizza dough or 2 x 25cm ready made pizza bases

½-⅔ cup pizza sauce or tomato paste

1 small onion, chopped finely

1 small green capsicum, chopped finely

1 stick cabanossi, sliced

4 button mushrooms, sliced

100g diced ham

¼ cup sliced olives, optional

2 cups pizza cheese (blend of tasty and mozzarella)

1. Preheat compact oven to 210°C using the bake setting. Place wire rack in the middle shelf in the sunken position.

2. Spread pizza sauce over bases. Arrange remaining ingredients except cheese over the sauce. Top with cheese. Bake pizza, one at a time, for about 15-20 minutes or golden.

Tip: If you are using ready made bases you can place them either onto a biscuit tray or place directly onto the oven rack.

Gourmet Pizza

Makes 2

1 quantity pizza dough or 2 x 25cm ready made pizza bases

½-⅔ cup ready made pesto sauce

1 roasted red capsicum, sliced (see page 14)

1 caramelised onion (see page 14)

8 sliced pancetta, torn

200g goat's cheese, crumbled

80g baby rocket

1. Preheat compact oven to 210°C using the bake setting. Place wire rack in the middle shelf in the sunken position.

2. Spread pesto sauce over bases. Arrange remaining ingredients, except cheese and rocket, over the sauce. Top with cheese. Bake pizza, one at a time, for about 15-20 minutes or golden.

3. Serve with rocket on top and drizzle with a little extra virgin olive oil.

Tip: If you are using ready made bases you can place them either onto a biscuit tray or place directly onto the oven rack.

Lamb Rack with Garlic and Parmesan Crust

Serves 4

2 x 400g lamb rack roast, French trimmed

4 slices day old bread, crust removed and roughly chopped

2 cloves garlic, chopped

2 tablespoons grated fresh parmesan

1 tablespoon chopped fresh rosemary

2 tablespoon seeded mustard

Olive oil spray

1. Preheat compact oven on 180°C for 10 minutes. Place wire rack on the bottom shelf in the raised position.

2. Place lamb racks on the baking tray with drip insert, having the bones interlocked in the middle.

3. Combine bread, garlic, parmesan and rosemary in a food processor. Process until mixture resembles fine breadcrumbs.

4. Spread mustard evenly over the outside of the cutlet base.

5. Press the bread mixture over the mustard and spray well with olive oil spray.

6. Place lamb racks in oven and bake 40 - 45 minutes or until cooked as desired. Remove from oven and cover with foil. Allow to rest 10-15 minutes.

7. Cut lamb into individual cutlets and serve with hot roasted potatoes.

Recipes continued

Roast Pork with Nutty Rice

Serves 4-6

1.5kg loin of pork
olive oil
sea salt
freshly ground black pepper
kitchen string

Filling

20g butter, melted
1 small mushroom, chopped
1 brown shallot, finely chopped
pinch nutmeg
½ cup cooked brown rice
1 tablespoon pine nuts
1 egg yolk
1 tablespoon chopped fresh parsley

1. Preheat oven to 210°C. Place wire rack on the bottom shelf in the raised position.
2. Combine all filling ingredients in a bowl and mix well.
3. Slice pork through the centre of the meat and butterfly the meat in half without cutting all the way through. Score the rind. Fold meat back and fill centre with the stuffing, roll pork then tie tightly with the string.
4. Brush meat lightly with oil and season with salt and pepper.
5. Place pork onto baking pan with drip tray insert. Reduce heat to 180°C and cook for approximately 1½ hours or until cooked. Rest meat from 10 minutes before carving.

Marinated Lamb Roast

Serves 4

1 tablespoon olive oil
1 tablespoon chopped fresh rosemary
2 cloves garlic, crushed
1 teaspoon grated lemon rind
2 tablespoons lemon juice
2 teaspoons Dijon mustard
¼ cup mango chutney
1kg boned and rolled shoulder of lamb

1. Preheat oven to 210°C. Place wire rack on the bottom shelf in the raised position.
2. Combine oil, rosemary, garlic, rind, juice, mustard and chutney in a large zip lock bag or large dish.
3. Place lamb in marinade; cover and refrigerate for 4 hours or overnight.
4. Drain marinade from lamb; reserve marinade. Place lamb on the baking pan with drip tray insert and place in compact oven. Reduce heat to 180°C and cook for about 1 hour, brushing occasionally with reserved marinade, or until cooked as desired.
5. Stand lamb, covered, for 10 minutes before carving. Serve lamb with steamed vegetables.

Tip: You can use the rotisserie function for this recipe also.

Recipes continued

Roast Chicken without Rotisserie Serves 4-6

2kg whole fresh chicken

5 cloves garlic

4 sprigs rosemary

olive oil

sea salt

freshly ground black pepper

1. Preheat compact oven to 210°C for 10 minutes. Place wire rack on the bottom shelf in the raised position.
2. Wash and clean chicken thoroughly. Pat dry with paper towelling.
3. Place the garlic and rosemary inside the cavity of the chicken. Tuck the wings back and tie the base of the chicken with cooking string so that the legs are crossed and securely positioned.
4. Brush the chicken with oil and season with salt and pepper.
5. Place the chicken onto the baking pan with the drip tray insert. Reduce heat to 180°C and cook for approximately 1 hour and 45 minutes or until cooked.

Note: To check the chicken to see if it has cooked thoroughly, insert a skewer into the thigh. The chicken is cooked when the juices run clear.

Roast Vegetables Serves 2

200g butternut pumpkin

2 small onions

1 large carrot

4 small new potatoes

sea salt

freshly ground black pepper

40g butter, melted

3. Preheat oven to 210°C, using the bake setting. Place wire rack in the middle shelf in the raised position.
4. Cut pumpkin into wedges leaving the skin on. Cut onions into quarters. Cut carrot into 4 pieces lengthways.
5. Place vegetables into the baking pan, season with salt and pepper and drizzle with butter.
6. Reduce temperature to 180°C and bake for approximately 40 minutes or until baked and crisp.

Recipes continued

ROTISSERIE RECIPES

Spicy Middle Eastern Chicken Kebabs Serves 4

800g thigh fillets

1 tablespoon lemon juice

1 tablespoon Moroccan seasoning spice mix

1 clove garlic, crushed

2 tablespoons olive oil

1. Trim fat from thigh fillets and cut in half.
2. Combine remaining ingredients in a large bowl and marinate chicken for 3-4 hours in the refrigerator.
3. To assemble rotisserie, place one the spikes onto the rotisserie rod about 6-7cm towards the squared off end of the rod; lock in place with the thumbscrew.
4. Thread thigh fillets onto the rod, pushing them as close together as possible. Place the other spike onto the other end of the rotisserie rod and push the chicken together. Lock the spike with the thumbscrew. Reserve any remaining marinade.
5. Preheat compact oven on 240°C, using the rotisserie function. Place wire rack on the lower shelf in the sunken position with the baking pan in place to catch any drips.
6. Insert rotisserie rod into the compact oven using the rotisserie handle. Cook chicken, brushing occasionally with any remaining marinade for 25-30 minutes or until cooked through. Remove rod carefully with rotisserie handle.

Tip: Allow meat to rest before removing as the screws and spike will be very hot.

Serving suggestion: Serve chicken sliced with in pita bread with tomato, lettuce, onion and cucumber yogurt sauce.

Roast Chicken with Stuffing for Rotisserie

1.2kg whole fresh chicken

sea salt

freshly ground black pepper

Stuffing

2 cups fresh bread crumbs

rind from 1 lemon

1 rasher bacon, finely chopped

1 egg, lightly beaten

1 tablespoon chopped fresh parsley

1. Wash and clean chicken thoroughly. Pat dry with paper towelling.
2. Place the combined stuffing ingredients inside the cavity of the chicken. Tuck the wings back and tie the base of the chicken with cooking string so that the legs are crossed and securely positioned.
3. To assemble chicken on rotisserie, place one the spikes onto the rotisserie rod about 6-7cm towards the squared off end of the rod; lock in place with the thumbscrew.
4. Insert the rod through the chicken, place the other spike onto the other side of the chicken. Spear the spikes into the chicken on either side so that they hold the chicken securely in place. Secure spikes with thumbscrews.
5. Brush chicken with a little oil and salt and pepper.
6. Preheat compact oven to 240°C, using the rotisserie function. Place wire rack on the lower shelf in the sunken position with the baking pan in place to catch any drips.
7. Insert rotisserie rod into the compact oven using the rotisserie handle. Cook chicken for about 1 hour and 20 minutes or until cooked through. Remove rod carefully with rotisserie handle.

Tip: Allow chicken to rest before removing as the screws and spike will be very hot.

Recipes continued

Souvlaki Lamb Kebabs

Serves 4

- 2 cloves garlic, crushed
- 1 tablespoon chopped fresh oregano
- 2 tablespoons lemon juice
- ¼ cup olive oil
- 2 x 400g lamb mini roast, cut into quarters
- 1 yellow capsicum, deseeded and cut into 4
- 1 red capsicum, deseeded and cut into 4
- 1 large red onion, quartered

1. Combine garlic, oregano, lemon juice and olive oil, mix until combined.
2. Place lamb in marinade and allow marinating for a minimum one hour or overnight.
3. To assemble rotisserie, place one of the spikes onto the rotisserie rod about 6-7cm towards the squared off end of the rod; lock in place with the thumbscrew.
4. Thread one piece onto the rotisserie rod, followed by a piece of yellow capsicum. Repeat with the remaining ingredients.
5. Place the other spike onto the other end of the rotisserie rod and push the meat and vegetables together. Lock the spike with the thumbscrew. Reserve any remaining marinade.
6. Preheat compact oven on 240°C, using the rotisserie function. Place wire rack on the lower shelf in the sunken position with the baking pan in place to catch any drips.
7. Insert rotisserie rod into the compact oven using the rotisserie handle. Cook meat, brushing occasionally with any remaining marinade for 25-30 minutes or until cooked through. Remove rod carefully with rotisserie handle.

Tip: Allow meat to rest before removing as the screws and spike will be very hot.

8. Unthread meat and vegetables, serve with salad.

DESSERTS

Glazed Orange Poppy Seed Cake

Serves 8

- 125g butter, softened
- ¾ cup caster sugar
- 1 tablespoon finely grated orange rind
- 2 eggs
- 1 cup self raising flour
- ⅓ cup milk
- 1 teaspoon vanilla extract
- ¼ cup poppy seeds

Glaze

- 2 teaspoons orange zest
- ½ cup orange juice
- ½ cup caster sugar

1. Preheat oven to 150°C using the bake setting. Place wire rack on the middle shelf in the sunken position.

Note: The oven temperature has been reduced to make allowances for fan-assisted cooking.

2. Grease and line base of a 20cm cake tin.
3. Using an electric mixer, cream butter, sugar and rind until light and fluffy.
4. Add eggs one at a time, beating well between each addition.
5. Add flour and milk in two batches and mix until just combined. Fold through poppy seeds.
6. Place mixture into prepared tin and cook in oven for about 50 minutes or until cooked when tested with a skewer. If cake starts to brown too much before the inside is completely cooked, lay a piece of foil over the top of the cake, this will stop excessive browning.
7. Meanwhile combine the zest, orange juice and sugar in a small saucepan. Stir over a low heat until the sugar has dissolved; bring to the boil, simmer for 2 minutes.
8. Turn cake out onto a cooling tray with a baking tray underneath. Using a wooden skewer, poke several holes into the cake then pour the hot syrup over the hot cake.

Recipes continued

Lemon Scones

Makes about 15

3 cups self raising flour
1 tablespoon finely grated lemon rind
1 teaspoon icing sugar mixture
60g butter
420ml buttermilk

1. Preheat oven to 240°C using the bake setting. Place wire rack on the middle shelf in the sunken position. Grease a 19cm square tin.
2. Combine the flour, icing sugar mixture and butter in a food processor until the mixture resembles fine breadcrumbs. Transfer to a large bowl.
3. Add the buttermilk and mix until just combined.
4. Turn dough onto a floured surface and lightly knead until smooth.
5. Press dough out to about a 3cm thickness. Using a 5cm pastry cutter cut into rounds. Place rounds into tin and bake in oven for about 15 minutes or cooked.
6. Serve with lemon curd and whipped cream.

Tip: If the tops start to brown before the middle is properly cooked lay a piece of foil over the tops of the scones, this will prevent excess browning.

Chocolate Chip Cookies

Makes about 30

125g butter, softened
½ cup firmly packed soft brown sugar
½ cup caster sugar
1 teaspoon vanilla extract
1 egg
1 ¾ cup self raising flour
1 cup choc chips

1. Preheat compact oven to 180°C using the bake setting. Place wire racks on the middle shelf in sunken position. Line biscuit tray with baking paper.
2. Beat butter, sugars and vanilla with an electric mixer until light and creamy.
3. Add egg and mix and well combined. Add flour and mix well.
4. Fold through chocolate chips. Roll tablespoon amounts into balls and place onto biscuit trays; press lightly with the back of a fork. Ensure that the cookies are well spaced to allow for spreading.
5. Bake in oven for about 10 minutes or until golden. Do not overcook. Transfer cookies to wire racks to cool; repeat with remaining cookie dough.

Recipes continued

Chocolate Chunk Muffins

Makes 6

1 cup self raising flour

¼ cup plain flour

¼ cup cocoa powder

½ cup chocolate chips

½ cup firmly packed brown sugar

1 egg, lightly beaten

¾ cup milk

½ cup vegetable oil

1. Preheat compact oven to 180°C using the bake setting. Place wire rack on the middle shelf in the sunken position. Grease a six hole, ⅓ cup capacity muffin tray.
2. Combine all ingredients in a large bowl until just mixed. Divide mix into muffin holes.
3. Bake in oven for about 18 minutes or until cooked when tested. Cool on a wire rack.

12 Month Replacement Guarantee

In the unlikely event that this appliance develops any malfunction within 12 months of purchase (3 months commercial use) due to faulty materials or manufacture, we will replace it for you free of charge.

Should you experience any difficulties with your appliance, please phone our customer service line for advice on 1300 881 861 in Australia, or 0800 786 232 in New Zealand. Alternatively, you can send a written claim to Sunbeam at the address listed below. On receipt of your claim, Sunbeam will seek to resolve your difficulties or, if the appliance is defective, advise you on how to obtain a replacement or refund.

Your Sunbeam 12 Month Replacement Guarantee naturally does not cover misuse or negligent handling and normal wear and tear.

Similarly your 12 Month Replacement Guarantee does not cover freight or any other costs incurred in making a claim. Please retain your receipt as proof of purchase.

The benefits given to you by this guarantee are in addition to your other rights and remedies under any laws which relate to the appliance.

Our goods come with guarantees that cannot be excluded under the Australian Consumer Law and under the New Zealand Consumer Guarantees Act.

In Australia you are entitled to a replacement or refund for a major failure and for compensation for any other reasonably foreseeable loss or damage. You are also entitled to have the goods repaired or replaced if the goods fail to be of acceptable quality and the failure does not amount to a major failure.

Should your appliance require repair or service after the guarantee period, contact your nearest Sunbeam service centre.

For a complete list of Sunbeam's authorised service centres visit our website or call:

Australia

www.sunbeam.com.au

1300 881 861

Units 5 & 6, 13 Lord Street
Botany NSW 2019 Australia

New Zealand

www.sunbeam.co.nz

0800 786 232

26 Vestey Drive, Mt Wellington
Auckland, New Zealand

Need help with your appliance?

Contact our customer service team or visit our website for information and tips on getting the most from your appliance.

In Australia

Visit www.sunbeam.com.au

Or call 1300 881 861

In New Zealand

Visit www.sunbeam.co.nz

Or call 0800 786 232

 is a registered trademark.

Made in China.

Due to minor changes in design or otherwise, the product may differ from the one shown in this leaflet.

© Copyright. Sunbeam Corporation Limited 2005.

ABN 45 000 006 771

Units 5 & 6, 13 Lord Street
Botany NSW 2019 Australia

Unit 3, Building D

26 Vestey Drive

Mt Wellington Auckland

New Zealand

Sunbeam Corporation is a division of GUD Holdings Ltd.

Free Manuals Download Website

<http://myh66.com>

<http://usermanuals.us>

<http://www.somanuals.com>

<http://www.4manuals.cc>

<http://www.manual-lib.com>

<http://www.404manual.com>

<http://www.luxmanual.com>

<http://aubethermostatmanual.com>

Golf course search by state

<http://golfingnear.com>

Email search by domain

<http://emailbydomain.com>

Auto manuals search

<http://auto.somanuals.com>

TV manuals search

<http://tv.somanuals.com>