



# Sun Fire™ V490 Server Administration Guide

---

Sun Microsystems, Inc.  
[www.sun.com](http://www.sun.com)

Part No. 817-3951-10  
August 2004, Revision A

Submit comments about this document at: <http://www.sun.com/hwdocs/feedback>

Copyright 2004 Sun Microsystems, Inc., 4150 Network Circle, Santa Clara, California 95054, U.S.A. All rights reserved.

Sun Microsystems, Inc. has intellectual property rights relating to technology that is described in this document. In particular, and without limitation, these intellectual property rights may include one or more of the U.S. patents listed at <http://www.sun.com/patents> and one or more additional patents or pending patent applications in the U.S. and in other countries.

This document and the product to which it pertains are distributed under licenses restricting their use, copying, distribution, and decompilation. No part of the product or of this document may be reproduced in any form by any means without prior written authorization of Sun and its licensors, if any.

Third-party software, including font technology, is copyrighted and licensed from Sun suppliers.

Parts of the product may be derived from Berkeley BSD systems, licensed from the University of California. UNIX is a registered trademark in the U.S. and in other countries, exclusively licensed through X/Open Company, Ltd.

Sun, Sun Microsystems, the Sun logo, Sun Fire, Solaris, VIS, Sun StorEdge, Solstice DiskSuite, Java, SunVTS and the Solaris logo are trademarks or registered trademarks of Sun Microsystems, Inc. in the U.S. and in other countries.

All SPARC trademarks are used under license and are trademarks or registered trademarks of SPARC International, Inc. in the U.S. and in other countries. Products bearing SPARC trademarks are based upon an architecture developed by Sun Microsystems, Inc.

The OPEN LOOK and Sun™ Graphical User Interface was developed by Sun Microsystems, Inc. for its users and licensees. Sun acknowledges the pioneering efforts of Xerox in researching and developing the concept of visual or graphical user interfaces for the computer industry. Sun holds a non-exclusive license from Xerox to the Xerox Graphical User Interface, which license also covers Sun's licensees who implement OPEN LOOK GUIs and otherwise comply with Sun's written license agreements.

U.S. Government Rights—Commercial use. Government users are subject to the Sun Microsystems, Inc. standard license agreement and applicable provisions of the FAR and its supplements.

DOCUMENTATION IS PROVIDED "AS IS" AND ALL EXPRESS OR IMPLIED CONDITIONS, REPRESENTATIONS AND WARRANTIES, INCLUDING ANY IMPLIED WARRANTY OF MERCHANTABILITY, FITNESS FOR A PARTICULAR PURPOSE OR NON-INFRINGEMENT, ARE DISCLAIMED, EXCEPT TO THE EXTENT THAT SUCH DISCLAIMERS ARE HELD TO BE LEGALLY INVALID.

---

Copyright 2004 Sun Microsystems, Inc., 4150 Network Circle, Santa Clara, Californie 95054, Etats-Unis. Tous droits réservés.

Sun Microsystems, Inc. a les droits de propriété intellectuels relatants à la technologie qui est décrit dans ce document. En particulier, et sans la limitation, ces droits de propriété intellectuels peuvent inclure un ou plus des brevets américains énumérés à <http://www.sun.com/patents> et un ou les brevets plus supplémentaires ou les applications de brevet en attente dans les Etats-Unis et dans les autres pays.

Ce produit ou document est protégé par un copyright et distribué avec des licences qui en restreignent l'utilisation, la copie, la distribution, et la décompilation. Aucune partie de ce produit ou document ne peut être reproduite sous aucune forme, par quelque moyen que ce soit, sans l'autorisation préalable et écrite de Sun et de ses bailleurs de licence, s'il y en a.

Le logiciel détenu par des tiers, et qui comprend la technologie relative aux polices de caractères, est protégé par un copyright et licencié par des fournisseurs de Sun.

Des parties de ce produit pourront être dérivées des systèmes Berkeley BSD licenciés par l'Université de Californie. UNIX est une marque déposée aux Etats-Unis et dans d'autres pays et licenciée exclusivement par X/Open Company, Ltd.

Sun, Sun Microsystems, le logo Sun, Sun Fire, Solaris, VIS, Sun StorEdge, Solstice DiskSuite, Java, SunVTS et le logo Solaris sont des marques de fabrique ou des marques déposées de Sun Microsystems, Inc. aux Etats-Unis et dans d'autres pays.

Toutes les marques SPARC sont utilisées sous licence et sont des marques de fabrique ou des marques déposées de SPARC International, Inc. aux Etats-Unis et dans d'autres pays. Les produits portant les marques SPARC sont basés sur une architecture développée par Sun Microsystems, Inc.

L'interface d'utilisation graphique OPEN LOOK et Sun™ a été développée par Sun Microsystems, Inc. pour ses utilisateurs et licenciés. Sun reconnaît les efforts de pionniers de Xerox pour la recherche et le développement du concept des interfaces d'utilisation visuelle ou graphique pour l'industrie de l'informatique. Sun détient une licence non exclusive de Xerox sur l'interface d'utilisation graphique Xerox, cette licence couvrant également les licenciées de Sun qui mettent en place l'interface d'utilisation graphique OPEN LOOK et qui en outre se conforment aux licences écrites de Sun.

LA DOCUMENTATION EST FOURNIE "EN L'ÉTAT" ET TOUTES AUTRES CONDITIONS, DECLARATIONS ET GARANTIES EXPRESSES OU TACITES SONT FORMELLEMENT EXCLUES, DANS LA MESURE AUTORISEE PAR LA LOI APPLICABLE, Y COMPRIS NOTAMMENT TOUTE GARANTIE IMPLICITE RELATIVE A LA QUALITE MARCHANDE, A L'APTITUDE A UNE UTILISATION PARTICULIERE OU A L'ABSENCE DE CONTREFAÇON.



Adobe PostScript

# Contents

---

**Preface xxv**

**Part I Installation**

**1. Sun Fire V490 Server Installation 1**

About the Parts Shipped to You 1

How to Install the Sun Fire V490 Server 2

**Part II Background**

**2. System Overview 9**

About the Sun Fire V490 Server 9

Locating Front Panel Features 12

    Security Lock and Top Panel Lock 12

    LED Status Indicators 13

    Power Button 15

System Control Switch 15

Locating Back Panel Features 16

About Reliability, Availability, and Serviceability Features 19

    Hot-Pluggable and Hot-Swappable Components 19

    Power Supply Redundancy 20

    Environmental Monitoring and Control 20

Automatic System Recovery	21
MPxIO	21
Sun Remote System Control Software	22
Hardware Watchdog Mechanism and XIR	23
Dual-Loop Enabled FC-AL Subsystem	23
Support for RAID Storage Configurations	24
Error Correction and Parity Checking	24
<b>3. Hardware Configuration</b>	<b>25</b>
About Hot-Pluggable and Hot-Swappable Components	26
Power Supplies	26
Disk Drives	27
About the CPU/Memory Boards	27
About the Memory Modules	28
Memory Interleaving	30
Independent Memory Subsystems	30
Configuration Rules	31
About the PCI Cards and Buses	31
Configuration Rules	33
About the System Controller (SC) Card	33
Configuration Rules	35
About Hardware Jumpers	36
PCI Riser Board Jumpers	36
About the Power Supplies	38
Configuration Rule	39
About the Fan Trays	39
Configuration Rule	41
About FC-AL Technology	41
About the FC-AL Backplane	42

Configuration Rules	43
About the HSSDC FC-AL Port	43
About the FC-AL Host Adapters	44
Configuration Rules	44
About the Internal Disk Drives	44
Configuration Rule	45
About the Serial Port	45
About the USB Ports	46
<b>4. Network Interfaces and System Firmware</b>	<b>47</b>
About the Network Interfaces	47
About Redundant Network Interfaces	48
About the <code>ok</code> Prompt	49
What You Should Know About Accessing the <code>ok</code> Prompt	50
Ways of Reaching the <code>ok</code> Prompt	50
For More Information	51
About OpenBoot Environmental Monitoring	52
Enabling or Disabling the OpenBoot Environmental Monitor	52
Automatic System Shutdown	53
OpenBoot Environmental Status Information	53
About OpenBoot Emergency Procedures	54
Stop-A Functionality	54
Stop-D Functionality	54
Stop-F Functionality	55
Stop-N Functionality	55
About Automatic System Recovery	55
Auto-Boot Options	56
Error Handling Summary	57
Reset Scenarios	58

About Manually Configuring Devices	59
Deconfiguring Devices vs. Slots	59
Deconfiguring All System Processors	59
Device Paths	60
Reference for Device Identifiers	61
<b>5. System Administration Software</b>	<b>63</b>
About System Administration Software	63
About Multipathing Software	64
For More Information	65
About Volume Management Software	65
Multiplexed I/O (MPxIO)	66
RAID Concepts	66
For More Information	68
About Sun Cluster Software	69
For More Information	69
About Communicating With the System	69
What the System Console Does	70
Using the System Console	70
<b>6. Diagnostic Tools</b>	<b>73</b>
About the Diagnostic Tools	73
About Diagnostics and the Boot Process	77
Prologue: System Controller Boot	78
Stage One: OpenBoot Firmware and POST	78
Stage Two: OpenBoot Diagnostics Tests	85
Stage Three: The Operating System	93
Tools and the Boot Process: A Summary	99
About Isolating Faults in the System	100

About Monitoring the System	101
Monitoring the System Using Remote System Control Software	102
Monitoring the System Using Sun Management Center	103
About Exercising the System	105
Exercising the System Using SunVTS Software	106
Exercising the System Using Hardware Diagnostic Suite	108
Reference for OpenBoot Diagnostics Test Descriptions	109
Reference for Decoding I2C Diagnostic Test Messages	111
Reference for Terms in Diagnostic Output	114

### **Part III Instructions**

<b>7. Configuring Console Access</b>	<b>119</b>
How to Avoid Electrostatic Discharge	120
How to Power On the System	122
How to Power Off the System	125
How to Get to the ok Prompt	126
How to Attach a Twisted-Pair Ethernet Cable	127
How to Access the System Console via tip Connection	129
How to Modify the /etc/remote File	131
How to Verify Serial Port Settings	132
How to Set Up an Alphanumeric Terminal as the System Console	133
How to Configure a Local Graphics Terminal as the System Console	135
How to Initiate a Reconfiguration Boot	138
Reference for System Console OpenBoot Variable Settings	141

<b>8. Configuring Network Interfaces and the Boot Device</b>	<b>143</b>
How to Configure the Primary Network Interface	144
How to Configure Additional Network Interfaces	146
How to Select the Boot Device	149
<b>9. Configuring System Firmware</b>	<b>153</b>
How to Enable OpenBoot Environmental Monitoring	154
How to Disable OpenBoot Environmental Monitoring	154
How to Obtain OpenBoot Environmental Status Information	155
How to Enable the Watchdog Mechanism and Its Options	156
How to Enable ASR	157
How to Disable ASR	158
How to Obtain ASR Status Information	158
How to Redirect the System Console to the System Controller	159
How to Restore the Local System Console	161
How to Deconfigure a Device Manually	162
How to Reconfigure a Device Manually	163
How to Implement Stop-N Functionality	164
<b>10. Isolating Failed Parts</b>	<b>167</b>
How to Operate the Locator LED	168
How to Put the Server in Service Mode	170
How to Put the Server in Normal Mode	171
How to Isolate Faults Using LEDs	172
How to Isolate Faults Using POST Diagnostics	175
How to Isolate Faults Using Interactive OpenBoot Diagnostics Tests	177
How to View Diagnostic Test Results After the Fact	179
How to View and Set OpenBoot Configuration Variables	180
Reference for Choosing a Fault Isolation Tool	181



<b>11. Monitoring the System</b>	<b>185</b>
How to Monitor the System Using Sun Management Center Software	186
How to Monitor the System Using the System Controller and RSC Software	190
How to Use Solaris System Information Commands	197
How to Use OpenBoot Information Commands	198
<b>12. Exercising the System</b>	<b>201</b>
How to Exercise the System Using SunVTS Software	202
How to Check Whether SunVTS Software Is Installed	206
<b>A. Connector Pinouts</b>	<b>209</b>
Serial Port Connector	210
Serial Port Connector Diagram	210
Serial Port Connector Signals	210
USB Connector	211
USB Connector Diagram	211
USB Connector Signals	211
Twisted-Pair Ethernet Connector	212
TPE Connector Diagram	212
TPE Connector Signals	212
SC Ethernet Connector	213
SC Ethernet Connector Diagram	213
SC Ethernet Connector Signals	213
SC Serial Connector	214
SC Serial Connector Diagram	214
SC Serial Connector Signals	214
FC-AL Port HSSDC Connector	215
HSSDC Connector Diagram	215
HSSDC Connector Signal	215

<b>B. System Specifications</b>	<b>217</b>
Physical Specifications	217
Electrical Specifications	218
Environmental Specifications	219
Agency Compliance Specifications	220
Clearance and Service Access Specifications	220
<b>C. Safety Precautions</b>	<b>221</b>
<b>Index</b>	<b>239</b>

# Figures

---

FIGURE 2-1	Sun Fire V490 Server Front Panel Features	12
FIGURE 2-2	Four-Position System Control Switch in Locked Position	15
FIGURE 2-3	Sun Fire V490 Server Back Panel Features	17
FIGURE 2-4	Back Panel External Ports	18
FIGURE 3-1	Memory Module Groups A0, A1, B0, B1	29
FIGURE 3-2	PCI Slots	32
FIGURE 3-3	Sun System Controller (SC) Card	34
FIGURE 3-4	SC Card Ports	35
FIGURE 3-5	Jumper Identification Guide	36
FIGURE 3-6	Hardware Jumpers on PCI Riser Board	37
FIGURE 3-7	Power Supply Locations	38
FIGURE 3-8	Fan Trays	40
FIGURE 6-1	Simplified Schematic View of a Sun Fire V490 System	76
FIGURE 6-2	Boot PROM and IDPROM	79
FIGURE 6-3	POST Diagnostic Running Across FRUs	81
FIGURE 6-4	OpenBoot Diagnostics Interactive Test Menu	87
FIGURE 10-1	Choosing a Tool to Isolate Hardware Faults	182



# Tables

---

TABLE 2-1	System LEDs	14
TABLE 2-2	Fan Tray LEDs	14
TABLE 2-3	Hard Disk Drive LEDs	14
TABLE 2-4	System Control Switch Settings	16
TABLE 2-5	Ethernet LEDs	17
TABLE 2-6	Power Supply LEDs	18
TABLE 3-1	Association Between Processors and DIMM Groups	30
TABLE 3-2	PCI Bus Characteristics, Associated Bridge Chips, Centerplane Devices, and PCI Slots	32
TABLE 3-3	PCI Riser Board Jumper Functions	37
TABLE 3-4	FC-AL Features and Advantages	42
TABLE 4-1	Ethernet Port LEDs	48
TABLE 5-1	System Administration Tool Summary	64
TABLE 5-2	Ways of Communicating With the System	70
TABLE 6-1	Summary of Diagnostic Tools	74
TABLE 6-2	OpenBoot Configuration Variables	82
TABLE 6-3	Keywords for the <code>test-args</code> OpenBoot Configuration Variable	86
TABLE 6-4	Diagnostic Tool Availability	99
TABLE 6-5	FRU Coverage of Fault Isolating Tools	100
TABLE 6-6	FRUs Not Directly Isolated by Diagnostic Tools	101
TABLE 6-7	What RSC Software Monitors	102

TABLE 6-8	What Sun Management Center Software Monitors	103
TABLE 6-9	FRU Coverage of System Exercising Tools	106
TABLE 6-10	OpenBoot Diagnostics Menu Tests	109
TABLE 6-11	OpenBoot Diagnostics Test Menu Commands	110
TABLE 6-12	Sun Fire V490 I2C Bus Devices	111
TABLE 6-13	Abbreviations or Acronyms in Diagnostic Output	114
TABLE 7-1	Ways of Accessing the ok Prompt	127
TABLE 7-2	OpenBoot Configuration Variables That Affect the System Console	141
TABLE 11-1	Using Solaris Information Display Commands	197
TABLE 11-2	Using OpenBoot Information Commands	199
TABLE 12-1	Useful SunVTS Tests to Run on a Sun Fire V490 Server	205

# Declaration of Conformity

Compliance Model Number: 490  
Product Family Name: Sun Fire V490

## EMC

### European Union

This equipment complies with the following requirements of the EMC Directive 89/336/EEC:

*As Telecommunication Network Equipment (TNE) in both Telecom Centers and Other Than Telecom Centers per (as applicable):*

EN300-386 V.1.3.1 (09-2001) Required Limits:

EN55022/CISPR22	Class A
EN61000-3-2	Pass
EN61000-3-3	Pass
EN61000-4-2	6 kV (Direct), 8 kV (Air)
EN61000-4-3	3 V/m 80-1000MHz, 10 V/m 800-960 MHz and 1400-2000 MHz
EN61000-4-4	1 kV AC and DC Power Lines, 0.5 kV Signal Lines,
EN61000-4-5	2 kV AC Line-Gnd, 1 kV AC Line-Line and Outdoor Signal Lines, 0.5 kV Indoor Signal Lines > 10m.
EN61000-4-6	3 V
EN61000-4-11	Pass

*As Information Technology Equipment (ITE) Class A per (as applicable):*

EN55022:1998/CISPR22:1997 Class A

EN55024:1998 Required Limits:

EN61000-4-2	4 kV (Direct), 8 kV (Air)
EN61000-4-3	3 V/m
EN61000-4-4	1 kV AC Power Lines, 0.5 kV Signal and DC Power Lines
EN61000-4-5	1 kV AC Line-Line and Outdoor Signal Lines, 2 kV AC Line-Gnd, 0.5 kV DC Power Lines
EN61000-4-6	3 V
EN61000-4-8	1 A/m
EN61000-4-11	Pass

EN61000-3-2:1995 + A1, A2, A14 Pass

EN61000-3-3:1995 Pass

**Safety:** This equipment complies with the following requirements of the Low Voltage Directive 73/23/EEC:

EC Type Examination Certificates:

EN 60950-1:2001 TÜV Rheinland Certificate No. S72040123

IEC 60950-1:2001 CB Scheme Certificate No. -on file-

Evaluated to all CB Countries

UL 60950-1, First Edition; CSA C22.2 No. 60950-00 File: E113363

FDA DHHS Accession Number (Monitor Only)

**Supplementary Information:** This product was tested and complies with all the requirements for the CE Mark.

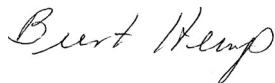

Burt Hemp  
Manager, Product Compliance

July 5, 2004

Sun Microsystems, Inc.  
One Network Circle, UBUR03-213  
Burlington, MA 01803  
USA

Tel: 781-442-2118  
Fax: 781-442-1673

/S/

Donald Cameron  
Program Manager

July 5, 2004

Sun Microsystems Scotland, Limited  
Blackness Road, Phase I, Main Bldg  
Springfield, EH49 7LR  
Scotland, United Kingdom

Tel: +44 1 506 672 539  
Fax: +44 1 506 670 011





# Regulatory Compliance Statements

Your Sun product is marked to indicate its compliance class:

- Federal Communications Commission (FCC) — USA
- Industry Canada Equipment Standard for Digital Equipment (ICES-003) — Canada
- Voluntary Control Council for Interference (VCCI) — Japan
- Bureau of Standards Metrology and Inspection (BSMI) — Taiwan

Please read the appropriate section that corresponds to the marking on your Sun product before attempting to install the product.

## FCC Class A Notice

This device complies with Part 15 of the FCC Rules. Operation is subject to the following two conditions:

1. This device may not cause harmful interference.
2. This device must accept any interference received, including interference that may cause undesired operation.

**Note:** This equipment has been tested and found to comply with the limits for a Class A digital device, pursuant to Part 15 of the FCC Rules. These limits are designed to provide reasonable protection against harmful interference when the equipment is operated in a commercial environment. This equipment generates, uses, and can radiate radio frequency energy, and if it is not installed and used in accordance with the instruction manual, it may cause harmful interference to radio communications. Operation of this equipment in a residential area is likely to cause harmful interference, in which case the user will be required to correct the interference at his own expense.

**Shielded Cables:** Connections between the workstation and peripherals must be made using shielded cables to comply with FCC radio frequency emission limits. Networking connections can be made using unshielded twisted-pair (UTP) cables.

**Modifications:** Any modifications made to this device that are not approved by Sun Microsystems, Inc. may void the authority granted to the user by the FCC to operate this equipment.

## FCC Class B Notice

This device complies with Part 15 of the FCC Rules. Operation is subject to the following two conditions:

1. This device may not cause harmful interference.
2. This device must accept any interference received, including interference that may cause undesired operation.

**Note:** This equipment has been tested and found to comply with the limits for a Class B digital device, pursuant to Part 15 of the FCC Rules. These limits are designed to provide reasonable protection against harmful interference in a residential installation. This equipment generates, uses and can radiate radio frequency energy and, if not installed and used in accordance with the instructions, may cause harmful interference to radio communications. However, there is no guarantee that interference will not occur in a particular installation. If this equipment does cause harmful interference to radio or television reception, which can be determined by turning the equipment off and on, the user is encouraged to try to correct the interference by one or more of the following measures:

- Reorient or relocate the receiving antenna.
- Increase the separation between the equipment and receiver.
- Connect the equipment into an outlet on a circuit different from that to which the receiver is connected.
- Consult the dealer or an experienced radio/television technician for help.

**Shielded Cables:** Connections between the workstation and peripherals must be made using shielded cables in order to maintain compliance with FCC radio frequency emission limits. Networking connections can be made using unshielded twisted pair (UTP) cables.

**Modifications:** Any modifications made to this device that are not approved by Sun Microsystems, Inc. may void the authority granted to the user by the FCC to operate this equipment.

## ICES-003 Class A Notice - Avis NMB-003, Classe A

This Class A digital apparatus complies with Canadian ICES-003.

Cet appareil numérique de la classe A est conforme à la norme NMB-003 du Canada.

## ICES-003 Class B Notice - Avis NMB-003, Classe B

This Class B digital apparatus complies with Canadian ICES-003.

Cet appareil numérique de la classe B est conforme à la norme NMB-003 du Canada.

## VCCI 基準について

### クラス A VCCI 基準について

クラス A VCCI の表示があるワークステーションおよびオプション製品は、クラス A 情報技術装置です。これらの製品には、下記の項目が該当します。

この装置は、情報処理装置等電波障害自主規制協議会 (VCCI) の基準に基づくクラス A 情報技術装置です。この装置を家庭環境で使用すると電波妨害を引き起こすことがあります。この場合には使用者が適切な対策を講ずるよう要求されることがあります。

### クラス B VCCI 基準について

クラス B VCCI の表示  があるワークステーションおよびオプション製品は、クラス B 情報技術装置です。これらの製品には、下記の項目が該当します。

この装置は、情報処理装置等電波障害自主規制協議会 (VCCI) の基準に基づくクラス B 情報技術装置です。この装置は、家庭環境で使用することを目的としていますが、この装置がラジオやテレビジョン受信機に近接して使用されると、受信障害を引き起こすことがあります。取扱説明書に従って正しい取り扱いをしてください。

## BSMI Class A Notice

The following statement is applicable to products shipped to Taiwan and marked as Class A on the product compliance label.

警告使用者：  
這是甲類的資訊產品，在居住的環境中使用時，可能會造成射頻干擾，在這種情況下，使用者會被要求採取某些適當的對策。



# Preface

---

The *Sun Fire V490 Server Administration Guide* is intended to be used by experienced system administrators. It includes general descriptive information about the Sun Fire™ V490 server and detailed instructions for installing, configuring, and administering the server and for diagnosing problems with the server. To use the information in this manual—particularly the instructional chapters—you must have working knowledge of computer network concepts and terms, and advanced familiarity with the Solaris™ Operating System.

---

## Before You Read This Book

While the first part of this manual focuses on installation of the Sun Fire V490 server, it does not deal with mounting the server in a cabinet or 2-post rack. For those instructions, see the *Sun Fire V490 Server Setup and Rackmounting Guide*. Rackmounting instructions are also printed on labels on the server chassis.

Follow the instructions for mounting the server in a cabinet or 2-post rack before continuing with the installation and configuration instructions in this manual.

---

## How This Book Is Organized

The *Sun Fire V490 Server Administration Guide* is divided into three parts:

- Part One – Installation
- Part Two – Background
- Part Three – Instructions

Each part of the book is divided into chapters.

### *Part One*

Chapter 1 describes and provides instructions for Sun Fire V490 server installation.

### *Part Two*

Chapter 2 presents an illustrated overview of the server and a description of the server's reliability, availability, and serviceability (RAS) features.

Chapter 3 describes and illustrates major system hardware.

Chapter 4 describes the network interfaces and system firmware, including OpenBoot™ environmental monitoring.

Chapter 5 offers conceptual information (not instructions) relating to system administration tasks.

Chapter 6 is a discussion of diagnostic tools.

### *Part Three*

Chapter 7 provides instructions for configuring system devices.

Chapter 8 provides instructions for configuring network interfaces and the boot drive.

Chapter 9 provides instructions for configuring system firmware.

Chapter 10 provides instructions for isolating failed parts.

Chapter 11 provides instructions for monitoring the system.

Chapter 12 provides instructions for exercising the system.

This manual also includes the following reference appendixes:

Appendix A details connector pinouts.

Appendix B provides tables of various system specifications.

Appendix C deals with safety precautions.

---

# Using UNIX Commands

This document might not contain information on basic UNIX<sup>®</sup> commands and procedures such as shutting down the system, booting the system, and configuring devices. Refer to the following for this information:

- Documentation that you received with your system
- Solaris Operating System documentation, which is at <http://docs.sun.com>

---

# Typographic Conventions

Typeface*	Meaning	Examples
AaBbCc123	The names of commands, files, and directories; on-screen computer output	Edit your <code>.login</code> file. Use <code>ls -a</code> to list all files. % You have mail.
AaBbCc123	What you type, when contrasted with on-screen computer output	% <b>su</b> Password:
AaBbCc123	Book titles, new words or terms, words to be emphasized	Read Chapter 6 in the <i>User's Guide</i> . These are called <i>class</i> options. You <i>must</i> be superuser to do this.
AaBbCc123	Command-line variable; replace with a real name or value	To delete a file, type <code>rm filename</code> .

\* The settings on your browser might differ from these settings.

---

# Shell Prompts

Shell	Prompt
C shell	<i>machine-name%</i>
C shell superuser	<i>machine-name#</i>
Bourne shell and Korn shell	\$
Bourne shell and Korn shell superuser	#

---

---

# Related Documentation

Application	Title	Part Number / Location
Site Planning	<i>Site Planning Guide for Entry-Level Servers, Version 1.5</i>	816-1613-15 Documentation CD
Rack installation	<i>Sun Fire V490 Server Setup and Rackmounting Guide</i>	817-3959-10 Documentation CD
	<i>Sun Fire V490 Server 4-Post Rackmounting Overview</i>	817-6884-10 Printed, included in box
Parts installation and removal	<i>Sun Fire V490 Server Parts Installation and Removal Guide</i>	817-3952-10 Documentation CD
Remote System Control (RSC) software	<i>Sun Remote System Control (RSC) 2.2 User's Guide</i>	816-3314-12 Documentation CD
Sun Validation Test Suite (SunVTS) software	<i>SunVTS 5.0 User's Guide</i>	816-1666-10 <a href="http://docs.sun.com">http://docs.sun.com</a>
	<i>SunVTS 5.0 Test Reference Manual</i>	816-1667-10 <a href="http://docs.sun.com">http://docs.sun.com</a>
Sun Management Center software	<i>Sun Management Center 3.5 Installation and Configuration Guide</i>	816-2678-10 <a href="http://www.sun.com/sunmanagementcenter">http://www.sun.com/sunmanagementcenter</a>
	<i>Sun Management Center 3.5 User's Guide</i>	816-2716-10 <a href="http://www.sun.com/sunmanagementcenter">http://www.sun.com/sunmanagementcenter</a>

---



Application	Title	Part Number / Location
Firmware configuration	<i>OpenBoot PROM Enhancements for Diagnostic Operation</i>	817-6957-10 Documentation CD
	<i>OpenBoot 4.x Command Reference Manual</i>	816-1177-10 <a href="http://docs.sun.com">http://docs.sun.com</a>
Late-breaking information	<i>Sun Fire V490 Server Product Notes</i>	817-4193-10 Documentation CD
	<i>Sun Remote System Control (RSC) 2.2.2 Release Notes</i>	816-3995-11 Documentation CD
	SunVTS README file	/opt/SUNWvts/

---

## Accessing Sun Documentation

You can view, print, or purchase a broad selection of Sun documentation, including localized versions, at:

<http://www.sun.com/documentation>

---

## Third-Party Web Sites

Sun is not responsible for the availability of third-party web sites mentioned in this document. Sun does not endorse and is not responsible or liable for any content, advertising, products, or other materials that are available on or through such sites or resources. Sun will not be responsible or liable for any actual or alleged damage or loss caused by or in connection with the use of or reliance on any such content, goods, or services that are available on or through such sites or resources.

---

# Contacting Sun Technical Support

If you have technical questions about this product that are not answered in this document, go to:

<http://www.sun.com/service/contacting>

---

# Sun Welcomes Your Comments

Sun is interested in improving its documentation and welcomes your comments and suggestions. You can submit your comments by going to:

<http://www.sun.com/hwdocs/feedback>

Please include the title and part number of your document with your feedback:

*Sun Fire V490 Server Administration Guide*, part number 817-3951-10

# PART I Installation

---

This one-chapter part of the *Sun Fire V490 Server Administration Guide* provides instructions for installing your server.

For illustrated background information about the hardware and software components of the Sun Fire V490 server, see the chapters in Part Two – Background.

For detailed instructions on how to configure and administer the server, and how to perform various diagnostic routines to resolve problems with the server, see the chapters in Part Three – Instructions.



# Sun Fire V490 Server Installation

---

This chapter provides both an overview of, and instructions for, the hardware and software tasks you need to accomplish to get the Sun Fire™ V490 server up and running. This chapter explains some of what you need to do, and points you to the appropriate section in this guide, or to other manuals for more information.

The following information is covered in this chapter:

- “About the Parts Shipped to You” on page 1
- “How to Install the Sun Fire V490 Server” on page 2

---

## About the Parts Shipped to You

Standard features for Sun Fire V490 systems are installed at the factory. However, if you ordered options such as a monitor, or keyboard and mouse, these will be shipped to you separately.

In addition, you should have received the media and documentation for all appropriate system software. Check that you have received everything you ordered.

---

**Note** – Inspect the shipping carton for evidence of physical damage. If a shipping carton is damaged, request that the carrier’s agent be present when the carton is opened. Keep all contents and packing material for the agent’s inspection.

---

Unpacking instructions are printed on the outside of the shipping carton.

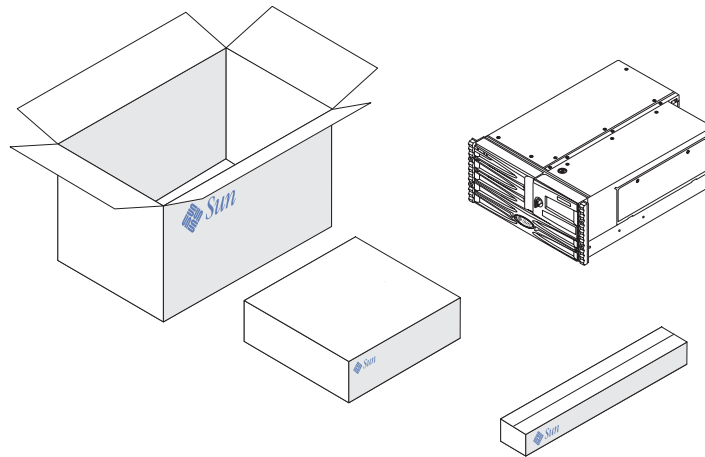

---

## How to Install the Sun Fire V490 Server

Each step in this procedure refers you to a particular document or to a section of this guide for instructions. Complete each step in the order listed.

The best way to begin your installation of a Sun Fire V490 server is by completing the rackmounting and setup procedures in the *Sun Fire V490 Server Setup and Rackmounting Guide*. This guide is shipped with your server in the ship kit box.

### Before You Begin

The Sun Fire V490 server is a general-purpose server, which you can use for many types of applications. Exactly how you set up your server depends on what you want it to do.

This procedure is intended to be as “generic” as possible, so as to cover the needs of most sites. Even so, you need to make certain decisions to complete the procedure:

- On which network or networks do you intend the machine to operate?

You need to provide specific networking information about the server when you install the Solaris™ Operating System (Solaris OS). For background information about network support, see “About the Network Interfaces” on page 47.

- How do you want to use and configure the machine’s internal disks?

For background information about the internal disks, see “About the Internal Disk Drives” on page 45.

- What software do you intend to load?

Software included in the Solaris media kit or other software products may impose certain disk space or disk partitioning requirements. Refer to the documentation accompanying this software to determine those requirements.

---

**Note** – A minimal Solaris 8 installation requires at least 64 Mbytes of memory and at least 1.7 Gbytes of disk space.

---

Once you have answered these questions, you are ready to begin the installation.

## What to Do

If you have completed the procedures in the *Sun Fire V490 Server Setup and Rackmounting Guide*, begin this procedure at Step 7.

- 1. Verify that you have received all the parts of your system.**

See “About the Parts Shipped to You” on page 1.

- 2. Install the system into either a 2-post rack or a 4-post cabinet, following all instructions in the *Sun Fire V490 Server Setup and Rackmounting Guide*.**

- 3. Set up a terminal or a console for installing your server.**

You must set up a terminal or console in order to install the Solaris OS and any application software.

You can either establish a `tip` connection from another server or use an alphanumeric (ASCII) terminal connected to the serial port. See “About Communicating With the System” on page 69 for background information, and then refer to the following procedures in this guide:

- “How to Access the System Console via `tip` Connection” on page 129
- “How to Set Up an Alphanumeric Terminal as the System Console” on page 133

---

**Note** – To set up a serial connection using a Sun workstation or an ASCII terminal, insert the RJ-45 serial cable into the DB-25 adapter (Sun part number 530-2889-03) supplied in the ship kit. Plug in the adapter to the DB-25 serial connector on the terminal or the Sun workstation. If you are using a network terminal server (NTS), refer to “Serial Port Connector” on page 210 to determine whether you need to use the adapter.

---

#### 4. Install any optional components shipped with your system.

If you ordered options that are not factory-installed, see the *Sun Fire V490 Server Parts Installation and Removal Guide* for installation instructions.

---

**Note** – Do not attempt to access any internal components unless you are a qualified service technician. Detailed service instructions can be found in the *Sun Fire V490 Server Parts Installation and Removal Guide*, which is included on the Sun Fire V490 Documentation CD.

---



---

**Caution** – The AC power cords provide a discharge path for static electricity, so they must remain plugged in when you install or handle internal components.

---

#### 5. Configure the network interface(s).

The Sun Fire V490 server provides two on-board Ethernet interfaces, which reside on the system centerplane and conform to the IEEE 802.3z Ethernet standard. Two back panel ports with RJ-45 connectors provide access to the on-board Ethernet interfaces. Each interface configures itself automatically for either 10-Mbps, 100-Mbps, or 1000-Mbps operation depending on network characteristics.

A variety of supported Peripheral Component Interconnect (PCI) cards can provide connections to additional Ethernet or other network types. For details about network interface options and configuration procedures, see:

- “About the Network Interfaces” on page 47
- “How to Configure the Primary Network Interface” on page 144
- “How to Configure Additional Network Interfaces” on page 146

---

**Note** – The system controller (SC) card serial and Ethernet interfaces are available only *after* you install the operating system software and the Remote System Control (RSC) software. Consult the *Sun Remote System Controller (RSC) User’s Guide* for more details about configuring these interfaces.

---



**6. Turn on power to your server.**

See “How to Power On the System” on page 122. For information about the LED status indicators that appear during power-on, see “LED Status Indicators” on page 13.

**7. Install and boot the Solaris OS software.**

See the installation instructions provided with your Solaris software. You should also consult the *Solaris on Sun Hardware Platform Guide* for your particular operating system which contains platform-specific information about software installation.

**8. Set any desired OpenBoot PROM configuration options.**

You can control several aspects of system behavior through OpenBoot™ PROM commands and configuration variables. For additional details, see Chapter 9.

**9. (Optional) Load additional software from the Solaris media kit.**

The Solaris media kit (sold separately) includes several CDs containing software to help you operate, configure, and administer your server. See the documentation provided with the Solaris media kit for a complete listing of included software and detailed installation instructions.

**10. Load online documentation from the Sun Fire V490 Documentation CD.**

You can copy the CD contents to a local or network disk drive, or view the documentation directly from the CD. See the installation instructions that accompany the CD in the Sun Fire V490 documentation set.

**11. (Optional) Install and configure Sun Remote System Control (RSC) software.**

Sun RSC software is included on the Solaris Software Supplement CD for your specific Solaris release. For installation instructions, see the *Solaris Sun Hardware Platform Guide* for the particular operating system provided in the Solaris media kit. For information about configuring and using RSC, see the *Sun Remote System Controller (RSC) User's Guide* provided on the Sun Fire V490 Documentation CD.

Once you install RSC software, you can configure the system to use RSC as the system console. For detailed instructions, see “How to Redirect the System Console to the System Controller” on page 159.

**12. (Optional) Install a local graphics terminal.**

After you have installed the Sun Fire V490 system and the Solaris OS, if you prefer to use a graphics terminal as your system console, you can install a graphics card and attach a monitor, mouse, and keyboard to the server. See “How to Configure a Local Graphics Terminal as the System Console” on page 135.



## PART II Background

---

The five chapters within this part of the *Sun Fire V490 Server Administration Guide* explain and illustrate in detail the various components of the server's hardware, software, and firmware. Use the chapters as a guided tour through the panels, cables, cards, switches, and so forth that make up your server.

For detailed instructions on how to configure and administer the server, and how to perform various diagnostic routines to resolve problems with the server, see the chapters in Part Three – Instructions.

Chapters included in Part Two are:

- Chapter 2 – System Overview
- Chapter 3 – Hardware Configuration
- Chapter 4 – Network Interfaces and System Firmware
- Chapter 5 – System Administration Software
- Chapter 6 – Diagnostic Tools



## System Overview

---

This chapter introduces you to the Sun Fire V490 server and describes some of its features.

The following information is covered in this chapter:

- “About the Sun Fire V490 Server” on page 9
  - “Locating Front Panel Features” on page 12
  - “Locating Back Panel Features” on page 16
  - “LED Status Indicators” on page 13
  - “About Reliability, Availability, and Serviceability Features” on page 19
- 

## About the Sun Fire V490 Server

The Sun Fire V490 system is a high-performance, shared memory, symmetric multiprocessing server that supports up to four UltraSPARC® IV processors. The UltraSPARC IV processor incorporates a chip with multithreading (CMT) design featuring two threads on each physical processor. The UltraSPARC IV processor implements the SPARC® V9 Instruction Set Architecture (ISA) and the Visual Instruction Set (VIS™) extensions that accelerate multimedia, networking, encryption, and Java™ software processing.

The system, which is mountable in a 4-post cabinet or 2-post rack, measures 8.75 inches (5 rack units - RU) high, 17.5 inches wide, and (without its plastic bezel) 24 inches deep (22.225 cm x 44.7 cm x 60.96 cm). The system weighs between 79 and 97 lbs (35.83 to 44 kg).

Processing power is provided by up to two dual CPU/Memory boards. Each board incorporates:

- Two UltraSPARC IV 1050-MHz processors

- 16 Mbytes of local static random access memory (SRAM) external cache memory per processor
- Slots for up to 16 dual inline memory modules (DIMMs)—eight per processor

A fully configured Sun Fire V490 system includes a total of four UltraSPARC IV processors residing on two CPU/Memory boards. For more information, see “About the CPU/Memory Boards” on page 27.

System main memory is provided by up to 32 DIMMs, which operate at a 75-MHz clock frequency. The system supports 512-Mbyte and 1-Gbyte DIMMs. Total system memory is shared by all processors in the system and ranges from a minimum of 8 Gbytes (one CPU/Memory board with eight 512-Mbyte DIMMs) to a maximum of 32 Gbytes (two boards fully populated with 1-Gbyte DIMMs). For more information about system memory, see “About the Memory Modules” on page 28.

System I/O is handled by four separate Peripheral Component Interconnect (PCI) buses. These industry-standard buses support all of the system’s on-board I/O controllers in addition to six slots for PCI interface cards. Four of the PCI slots operate at a 33-MHz clock rate, and two slots operate at either 33 or 66 MHz. All slots comply with PCI Local Bus Specification Revision 2.1. For additional details, see “About the PCI Cards and Buses” on page 31.

Internal disk storage is provided by up to two 1-inch, hot-pluggable, Fibre Channel-Arbitrated Loop (FC-AL) disk drives. Both single-loop and dual-loop configurations are supported. The basic system includes an FC-AL disk backplane that accommodates 73-Gbyte or 146-Gbyte disks. In addition, an external FC-AL port exists on the system’s back panel. For additional details, see “Locating Back Panel Features” on page 16.

The backplane provides dual-loop access to each of the FC-AL disk drives. One loop is controlled by an on-board FC-AL controller integrated into the system centerplane. The second loop is controlled by a PCI FC-AL host adapter card (available as a system option). This dual-loop configuration enables simultaneous access to internal storage via two different controllers, which increases available I/O bandwidth. A dual-loop configuration can also be combined with multipathing software to provide hardware redundancy and failover capability. Should a component failure render one loop inaccessible, the software can automatically switch data traffic to the second loop to maintain system availability. For more information about the system’s internal disk array, see “About FC-AL Technology” on page 41, “About the FC-AL Backplane” on page 43, and “About the FC-AL Host Adapters” on page 44.

External multidisk storage subsystems and redundant array of independent disks (RAID) storage arrays can be supported by installing single-channel or multichannel PCI host adapter cards along with the appropriate system software. Software drivers supporting FC-AL and other types of devices are included in the Solaris OS.

The system provides two on-board Ethernet host PCI adapters, which support several modes of operations at 10, 100, and 1000 megabits per second (Mbps).

Additional Ethernet interfaces or connections to other network types can be provided by installing the appropriate PCI interface cards. Multiple network interfaces can be combined with multipathing software to provide hardware redundancy and failover capability. Should one of the interfaces fail, the software can automatically switch all network traffic to an alternate interface to maintain network availability. For more information about network connections, see “How to Configure the Primary Network Interface” on page 144 and “How to Configure Additional Network Interfaces” on page 146.

The Sun Fire V490 server provides a serial communication port, which you can access through an RJ-45 connector located on the system’s back panel. For more information, see “About the Serial Port” on page 45.

The back panel also provides two Universal Serial Bus (USB) ports for connecting USB peripheral devices such as modems, printers, scanners, digital cameras, or a Sun Type-6 USB keyboard and mouse. The USB ports support both isochronous mode and asynchronous mode. The ports enable data transmission at speeds of 12 Mbps. For additional details, see “About the USB Ports” on page 46.

The local system console device can be either a standard ASCII character terminal or a local graphics console. The ASCII terminal connects to the system’s serial port, while a local graphics console requires installation of a PCI graphics card, monitor, USB keyboard, and mouse. You can also administer the system from a remote workstation connected to the Ethernet or from the system controller.

Sun Remote System Control (RSC) software is a secure server management tool that lets you monitor and control your server over a serial line or over a network. RSC provides remote system administration for geographically distributed or physically inaccessible systems. RSC software works in conjunction with the system controller (SC) card included in all Sun Fire V490 servers.

The SC card runs independently of the host server, and operates off of 5-volt standby power from the system’s power supplies. These features allow the SC to serve as a “lights out” management tool that continues to function even when the server operating system goes offline or when the server is powered off. For additional details, see “About the System Controller (SC) Card” on page 33.

The basic system includes two 1448-watt power supplies, each with two internal fans. The power supplies are plugged in directly to one power distribution board (PDB). One power supply provides sufficient power for a maximally configured system. The second power supply provides N+1 redundancy, allowing the system to continue operating should the first power supply fail. A power supply in a redundant configuration is hot-swappable, so that you can remove and replace a faulty power supply without shutting down the operating system or turning off the system power. For more information about the power supplies, see “About the Power Supplies” on page 38.

System reliability, availability, and serviceability (RAS) are enhanced by features that include hot-pluggable disk drives and redundant, hot-swappable power supplies. A full list of RAS features is in the section, “About Reliability, Availability, and Serviceability Features” on page 19.

---

## Locating Front Panel Features

The illustration below shows the system features that you can access from the front panel. In the illustration, the media door (upper right) and the power supply access panel (bottom) are removed.

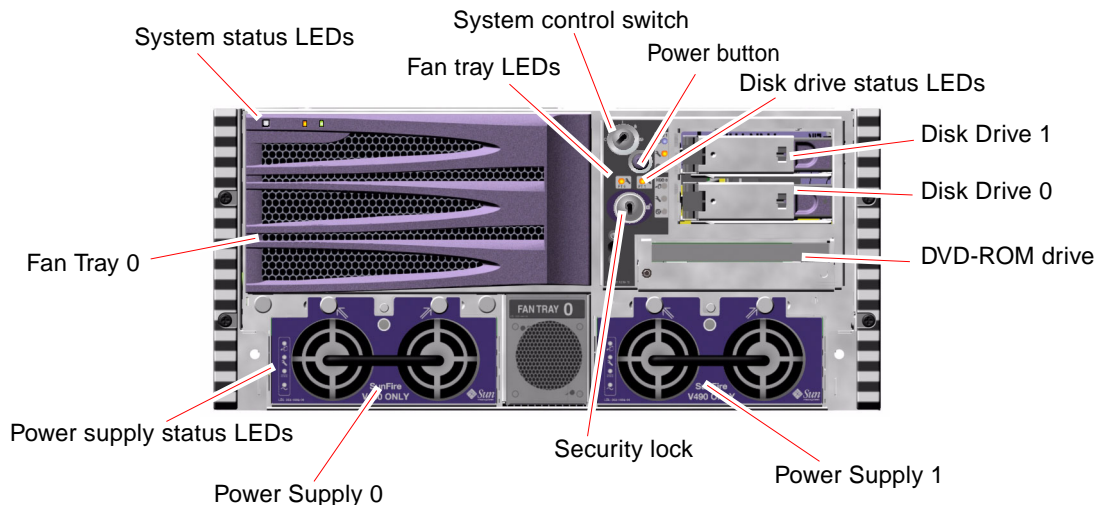

**FIGURE 2-1** Sun Fire V490 Server Front Panel Features

For information about front panel controls and indicators, see “LED Status Indicators” on page 13.

## Security Lock and Top Panel Lock

In addition to the security lock on the system’s front panel, a top panel lock on the top of the system controls entry to both the PCI access panel and the CPU access panel. When the key is in the upright position, the media door is unlocked. However, even if the top panel lock is in the Locked position, thereby locking both the PCI and CPU access panels, you can still unlock the *media door* security lock and



gain access to the disk drives, power supplies, and Fan Tray 0. If the media door is locked and the power supply access panel is in place, you will not be able to gain access to the power supplies, disk drives, and Fan Tray 0—even if the PCI access panel is unlocked.

---

**Note** – The same key operates the security lock, the system control switch (see “System Control Switch” on page 15), and the top panel lock for the PCI and CPU access panels.

---

The standard system is configured with two power supplies, which are accessible from the front of the system. LED indicators display power status. See “LED Status Indicators” on page 13 for additional details.

## LED Status Indicators

Several LED status indicators on both the front and back panels provide general system status, alert you to system problems, and help you to determine the location of system faults.

At the top left of the system as you look at its front are three general system LEDs. Two of these LEDs, the system *Fault* LED and the *Power/OK* LED, provide a snapshot of the overall system status. The *Locator* LED helps you to locate a specific system quickly, even though it may be one of dozens or even scores of systems in a room. The front panel Locator LED is at the far left in the cluster. The Locator LED is lit by command from the administrator. For instructions, see “How to Operate the Locator LED” on page 168.

Other LEDs located on the front of the system work in conjunction with specific fault LED icons. For example, a fault in the disk subsystem illuminates the disk drive Fault LED in the center of the LED cluster that is next to the affected disk drive. Since all front panel status LEDs are powered by the system’s 5-volt standby power source, Fault LEDs remain lit for any fault condition that results in a system shutdown.

Locator, Fault, and Power/OK LEDs are also found at the upper-left corner of the back panel. Also located on the back panel are LEDs for the system’s two power supplies and RJ-45 Ethernet ports.

See FIGURE 2-1 and FIGURE 2-3 for locations of the front panel and back panel LEDs.

During system startup, LEDs are toggled on and off to verify that each one is working correctly.

The following tables list and describe the LEDs on the front panel: system LEDs, fan tray LEDs, and hard disk drive LEDs.

Listed from left to right, the system LEDs operate as described in the following table.

**TABLE 2-1** System LEDs

Name	Description
Locator	This white LED is lit by the Sun Management Center, RSC software, or by the Solaris command to locate a system.
Fault	This amber LED lights when the system hardware or software has detected a system fault.
Power/OK	This green LED lights when the main power (48 VDC) is on.

The following table describes the fan tray LEDs.

**TABLE 2-2** Fan Tray LEDs

Name	Description
Fan Tray 0 (FT 0 Fault)	This amber LED lights when a fault is detected in the CPU fans.
Fan Tray 1 (FT 1 Fault)	This amber LED lights when a fault is detected in the PCI fans.

The following table describes the disk drive LEDs.

**TABLE 2-3** Hard Disk Drive LEDs

Name	Description
OK-to-Remove	This blue LED lights when it is safe to remove the hard disk drive from the system.
Fault	This amber LED lights when the system software detects a fault in the monitored hard disk drive. Note that the system Fault LED on the front panel will also be lit when this occurs.
Activity	This green LED lights when a disk is present in the monitored drive slot. This LED blinks <i>slowly</i> to indicate that the drive is spinning up or down, and <i>quickly</i> to indicate disk activity.

Further details about the diagnostic use of LEDs are discussed separately in the section, "How to Isolate Faults Using LEDs" on page 172.

# Power Button

The system Power button is recessed to prevent accidentally turning the system on or off. The ability of the Power button to turn the system on or off is controlled by the system control switch. See the section, “System Control Switch” on page 15.

If the operating system is running, pressing and releasing the Power button initiates a graceful software system shutdown. Pressing and holding in the Power button for five seconds causes an immediate hardware shutdown.



---

**Caution** – Whenever possible, you should use the graceful shutdown method. Forcing an immediate hardware shutdown may cause disk drive corruption and loss of data.

---

# System Control Switch



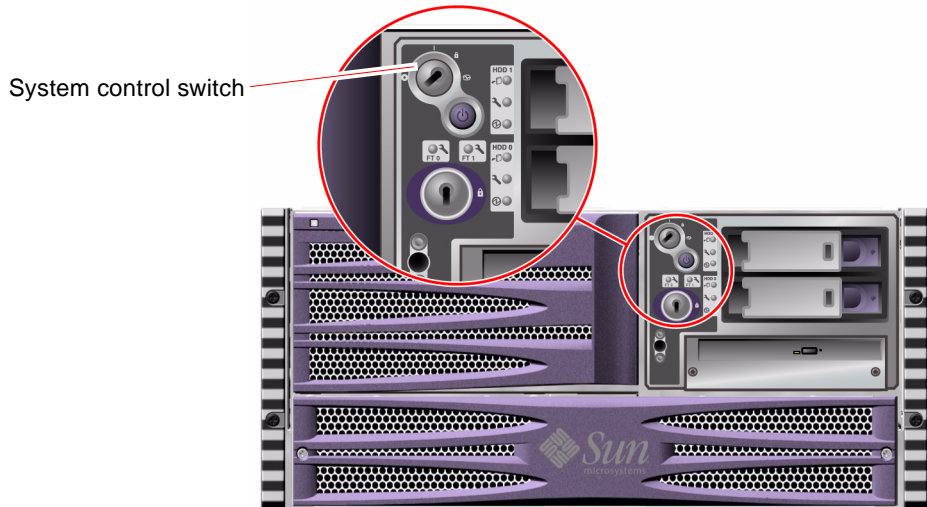

The four-position system control switch on the system’s status and control panel controls the power-on modes of the system and prevents unauthorized users from powering off the system or reprogramming system firmware. In the following illustration, the system control switch is in the Locked position.



**FIGURE 2-2** Four-Position System Control Switch in Locked Position

The following table describes the function of each system control switch setting.

**TABLE 2-4** System Control Switch Settings

Position	Icon	Description
Normal		This setting enables the system Power button to power the system on or off. If the operating system is running, pressing and releasing the Power button initiates a graceful software system shutdown. Pressing and holding the Power button in for five seconds causes an immediate hardware power off.
Locked		This setting disables the system Power button to prevent unauthorized users from powering the system on or off. It also disables the keyboard L1-A (Stop-A) command, terminal Break key command, and ~# tip window command, preventing users from suspending system operation to access the system ok prompt.  The Locked setting, used for normal day-to-day operations, also prevents unauthorized programming of the system Boot PROM.
Diagnostics		This setting forces the power-on self-test (POST) and OpenBoot Diagnostics software to run during system startup and system resets. The Power button functions the same as when the system control switch is in the Normal position.
Forced Off		This setting forces the system to power off immediately and to enter 5-volt standby mode. It also disables the system Power button. You may want to use this setting when AC power is interrupted and you do not want the system to restart automatically when power is restored. With the system control switch in any other position, if the system were running prior to losing power, it restarts automatically once power is restored.  The Forced Off setting also prevents a system controller console from restarting the system. However, the system controller card continues to operate using the system's 5-volt standby power.

## Locating Back Panel Features

The following figure shows the system features that you can access from the back panel.

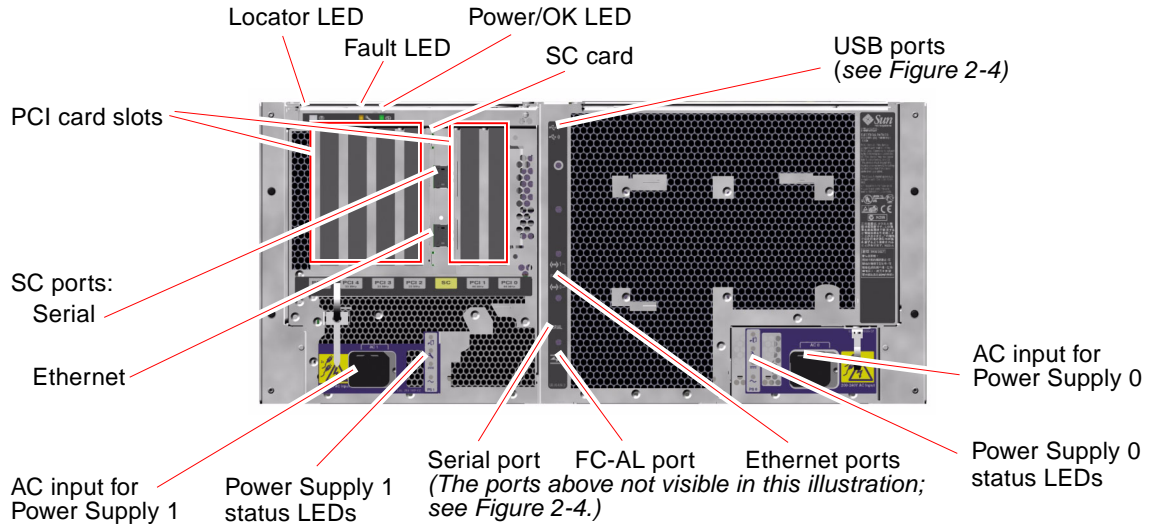

**FIGURE 2-3** Sun Fire V490 Server Back Panel Features

Main system LEDs—Locator, Fault, and Power/OK—are repeated on the back panel. (See TABLE 2-1, TABLE 2-2, and TABLE 2-3 for descriptions of front panel LEDs.) In addition, the back panel includes LEDs that display the status of each of the two power supplies and both on-board Ethernet connections. Two LEDs located on each Ethernet RJ-45 connector display the status of Ethernet activity. Each power supply is monitored by four LEDs.

Details of the diagnostic use of LEDs are discussed separately in the section, “How to Isolate Faults Using LEDs” on page 172.

TABLE 2-5 lists and describes the Ethernet LEDs on the system’s back panel.

**TABLE 2-5** Ethernet LEDs

Name	Description
Activity	This amber LED lights when data is either being transmitted or received by the particular port.
Link Up	This green LED lights when a link is established at the particular port with its link partner.

TABLE 2-6 lists and describes the power supply LEDs on the system's back panel.

**TABLE 2-6** Power Supply LEDs

Name	Description
OK-to-Remove	This blue LED lights when it is safe to remove the power supply from the system.
Fault	This amber LED lights when the power supply's internal microcontroller detects a fault in the monitored power supply. Note that the system Fault LED on the front panel will also be lit when this occurs.
DC Present	This green LED lights when the power supply is on and outputting regulated power within specified limits.
AC Present	This green LED lights when a proper AC voltage source is input to the power supply.

Also accessible from the back panel are:

- Inlets for both AC power supplies
- Six PCI card slots
- One system controller (SC) card slot
- Six external data ports: USB, serial, Ethernet, and FC-AL (see FIGURE 2-4)

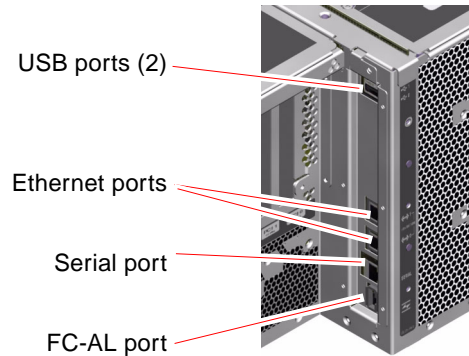

**FIGURE 2-4** Back Panel External Ports

---

# About Reliability, Availability, and Serviceability Features

Reliability, availability, and serviceability (RAS) are aspects of a system's design that affect its ability to operate continuously and to minimize the time necessary to service the system. Reliability refers to a system's ability to operate continuously without failures and to maintain data integrity. System availability refers to the percentage of time that a system remains accessible and usable. Serviceability relates to the time it takes to restore a system to service following a system failure. Together, reliability, availability, and serviceability features provide for near continuous system operation.

To deliver high levels of reliability, availability and serviceability, the Sun Fire V490 system offers the following features:

- Hot-pluggable disk drives
- Redundant, hot-swappable power supplies
- Environmental monitoring and fault detection
- Automatic system recovery (ASR) capabilities
- Multiplexed I/O (MPxIO)
- Remote “lights out” management capability
- Hardware watchdog mechanism and externally initiated reset (XIR)
- Dual-loop enabled FC-AL subsystem
- Support for disk and network multipathing with automatic failover capability
- Error correction and parity checking for improved data integrity

## Hot-Pluggable and Hot-Swappable Components

Sun Fire V490 hardware is designed to support hot-plugging of internal disk drives and hot-swapping of power supplies. With the proper software support, you can install or remove these components while the system is running. Hot-plug and hot-swap technology significantly increases the system's serviceability and availability, by providing the ability to:

- Increase storage capacity dynamically to handle larger work loads and improve system performance
- Replace disk drives and power supplies without service disruption

For additional information about the system's hot-pluggable and hot-swappable components—including a discussion of the differences between the two practices—see “About Hot-Pluggable and Hot-Swappable Components” on page 26.

# Power Supply Redundancy

The system features two hot-swappable power supplies, either of which is capable of handling the system's entire load. Thus, the system provides N+1 redundancy, allowing the system to continue operating should one of the power supplies or its AC power source fail. For more information about power supplies, redundancy, and configuration rules, see "About the Power Supplies" on page 38.

# Environmental Monitoring and Control

The Sun Fire V490 system features an environmental monitoring subsystem designed to protect against:

- Extreme temperatures
- Lack of adequate airflow through the system
- Power supply failures

Monitoring and control capabilities reside at the operating system level as well as in the system's Boot PROM firmware. This ensures that monitoring capabilities remain operational even if the system has halted or is unable to boot.

The environmental monitoring subsystem uses an industry-standard Inter-Integrated Circuit (I<sup>2</sup>C) bus. The I<sup>2</sup>C bus is a simple two-wire serial bus, used throughout the system to allow the monitoring and control of temperature sensors, fans, power supplies, status LEDs, and the front panel system control switch.

Temperature sensors are located throughout the system to monitor the ambient temperature of the system and the temperature of several application-specific integrated circuits (ASICs). The monitoring subsystem polls each sensor and uses the sampled temperatures to report and respond to any overtemperature or undertemperature conditions.

The hardware and software together ensure that the temperatures within the enclosure do not stray outside predetermined "safe operation" ranges. If the temperature observed by a sensor falls below a low-temperature warning threshold or rises above a high-temperature warning threshold, the monitoring subsystem software lights the system Fault LED on the front status and control panel.

All error and warning messages are displayed on the system console (if one is attached) and are logged in the `/var/adm/messages` file. Front panel Fault LEDs remain lit after an automatic system shutdown to aid in problem diagnosis.

The monitoring subsystem is also designed to detect fan failures. The system features two fan trays, which include a total of five individual fans. If any fan fails, the monitoring subsystem detects the failure and generates an error message and logs it in the `/var/adm/messages` file, lights the appropriate fan tray LED, and lights the system Fault LED.



The power subsystem is monitored in a similar fashion. Polling the power supply status registers periodically, the monitoring subsystem indicates the status of each supply's DC outputs.

If a power supply problem is detected, an error message is displayed on the system console and logged in the `/var/adm/messages` file. Additionally, LEDs located on each power supply are illuminated to indicate failures.

## Automatic System Recovery

To some, *automatic system recovery* (ASR) implies an ability to shield the operating system in the event of a hardware failure, allowing the operating system to remain up and running. The implementation of ASR on the Sun Fire V490 server is different. ASR on the Sun Fire V490 server provides for automatic fault isolation and restoration of the operating system following non-fatal faults or failures of these hardware components:

- Processors
- Memory modules
- PCI buses and cards
- FC-AL subsystem
- Ethernet interface
- USB interfaces
- Serial interface

In the event of such a hardware failure, firmware-based diagnostic tests isolate the problem and mark the device (using the 1275 Client Interface, via the device tree) as either *failed* or *disabled*. The OpenBoot firmware then deconfigures the failed device and reboots the operating system. This all occurs automatically, as long as the Sun Fire V490 system is capable of functioning without the failed component.

Once restored, the operating system will not attempt to access any deconfigured device. This prevents a faulty hardware component from keeping the entire system down or causing the system to crash repeatedly.

As long as the failed component is electrically dormant (that is, it does not cause random bus errors or introduce noise into signal lines), the system reboots automatically and resumes operation. Be sure to contact a qualified service technician about replacing the failed component.

## MPxIO

Multiplexed I/O (MPxIO), a feature found in the Solaris 8 Operating System, is a native multipathing solution for storage devices such as Sun StorEdge™ disk arrays. MPxIO provides:

- Host-level multipathing (there is no multipathing support for boot devices)
- Physical host controller interface (pHCI) support
- Sun StorEdge T3 and Sun StorEdge A5x00 support
- Load balancing
- Coexistence with Alternate Pathing (AP) and Dynamic Multipathing (DMP)

For further details about MPxIO, see “Multiplexed I/O (MPxIO)” on page 66. Also consult your Solaris documentation.

## Sun Remote System Control Software

Sun Remote System Control (RSC) software is a secure server management tool that lets you monitor and control your server over a serial line or over a network. RSC provides remote system administration for geographically distributed or physically inaccessible systems. The RSC software works with the system controller (SC) card on the Sun Fire V490 system PCI riser board. The SC card provides an Ethernet connection to a remote console and a serial connection to a local alphanumeric terminal.

Once RSC is configured to manage your server, you can use it to run diagnostic tests, view diagnostic and error messages, reboot your server, and display environmental status information from a remote console.

RSC provides the following features:

- Remote system monitoring and error reporting (including diagnostic output)
- Remote reboot, power-on, power-off, and reset functions
- Ability to monitor system environmental conditions remotely
- Ability to run diagnostic tests from a remote console
- Ability to capture and store the console log, which you may review or replay later, remotely
- Remote event notification for overtemperature conditions, power supply failures, fatal system errors, system shutdown, or system reset
- Remote access to detailed event logs
- Remote console functions via Ethernet or serial port

For more details about system controller hardware, see “About the System Controller (SC) Card” on page 33.

For further information, see “How to Monitor the System Using the System Controller and RSC Software” on page 190 and the *Sun Remote System Controller (RSC) User’s Guide* provided on the Sun Fire V490 Documentation CD.

# Hardware Watchdog Mechanism and XIR

To detect and respond to system hang conditions, the Sun Fire V490 system features a hardware watchdog mechanism—a hardware timer that is continually reset as long as the operating system is running. In the event of a system hang, the operating system is no longer able to reset the timer. The timer will then expire and cause an automatic externally initiated reset (XIR), eliminating the need for operator intervention. When the watchdog mechanism resets the system after sending information to the screen and depending upon the OBP variable, a core file might be created to give additional information.

---

**Note** – The hardware watchdog mechanism is not activated until you enable it. See “How to Enable the Watchdog Mechanism and Its Options” on page 156 for instructions.

---

The XIR feature is also available for you to invoke manually, by way of your RSC console. You use the `xir` command manually when the system is absolutely hung and an L1-A (Stop-A) keyboard command does not work. When you issue the `xir` command manually by way of RSC, the system is immediately returned to the OpenBoot PROM `ok` prompt. From there, you can use OpenBoot commands to debug the system.

## Dual-Loop Enabled FC-AL Subsystem

The system’s dual-ported Fibre Channel-Arbitrated Loop (FC-AL) disk drives and dual-loop enabled FC-AL backplane may be combined with an optional PCI FC-AL host adapter card to provide for fault tolerance and high availability of data. This dual-loop configuration allows each disk drive to be accessed through two separate and distinct data paths, providing both increased bandwidth and hardware redundancy; that is, dual-loop configuration provides the ability to sustain component failures in one path by switching all data transfers to an alternate path.

The FC-AL subsystem is described in greater detail in:

- “About FC-AL Technology” on page 41
- “About the FC-AL Backplane” on page 43
- “About the FC-AL Host Adapters” on page 44

# Support for RAID Storage Configurations

By attaching one or more external storage devices to the Sun Fire V490 server, you can use a software RAID application, such as Sun StorEdge™, to configure system disk storage in a variety of different RAID levels. Configuration options include RAID 0 (striping), RAID 1 (mirroring), RAID 0+1 (striping plus mirroring), RAID 1+0 (mirroring plus striping), and RAID 5 (striping with interleaved parity). You choose the appropriate RAID configuration based on the price, performance, and reliability and availability goals for your system. You can also configure one or more drives to serve as “hot spares” to fill in automatically for a defective drive in the event of a disk failure.

For more information, see “About Volume Management Software” on page 65.

## Error Correction and Parity Checking

Error correcting code (ECC) is used on all internal system data paths to ensure high levels of data integrity. All data that moves between processors, memory, and PCI bridge chips have end-to-end ECC protection.

The system reports and logs correctable ECC errors. A correctable ECC error is any single-bit error in a 128-bit field. Such errors are corrected as soon as they are detected. The ECC implementation can also detect double-bit errors in the same 128-bit field and multiple-bit errors in the same nibble (4 bits).

In addition to providing ECC protection for data, the system offers parity protection on all system address buses. Parity protection is also used on the PCI and SCSI buses, and in the UltraSPARC IV processors’ internal and external caches.

# Hardware Configuration

---

This chapter provides hardware configuration information for the Sun Fire V490 server.

The following topics are covered in this chapter:

- “About Hot-Pluggable and Hot-Swappable Components” on page 26
- “About the CPU/Memory Boards” on page 27
- “About the Memory Modules” on page 28
- “About the PCI Cards and Buses” on page 31
- “About the System Controller (SC) Card” on page 33
- “About Hardware Jumpers” on page 36
- “About the Power Supplies” on page 38
- “About the Fan Trays” on page 39
- “About FC-AL Technology” on page 41
- “About the FC-AL Backplane” on page 43
- “About the FC-AL Host Adapters” on page 44
- “About the Internal Disk Drives” on page 45
- “About the HSSDC FC-AL Port” on page 44
- “About the USB Ports” on page 46

For configuration information about network interfaces, see:

- “How to Configure the Primary Network Interface” on page 144
- “How to Configure Additional Network Interfaces” on page 146

---

# About Hot-Pluggable and Hot-Swappable Components

In a Sun Fire V490 system, the FC-AL disk drives are *hot-pluggable* components and the power supplies are *hot-swappable*. (No other component of the system is either hot-pluggable or hot-swappable.) Hot-pluggable components are those that you can install or remove while the system is running, without affecting the rest of the system's capabilities. However, in many cases, you must prepare the operating system prior to the hot-plug event by performing certain system administration tasks. The power supplies require no such preparation and are called hot-swappable components. These components can be removed or inserted at any time without preparing the operating system in advance. While all hot-swappable components are hot-pluggable, not every hot-pluggable component is hot-swappable.

Each component is discussed in more detail in the sections that follow. (Not discussed here are any devices that you may attach to the USB port, which are generally hot-pluggable.)



---

**Caution** – The SC card is *not* a hot-pluggable component. Do not attempt to access any internal components unless you are a qualified service technician. Detailed service instructions can be found in the *Sun Fire V490 Server Parts Installation and Removal Guide*, which is included on the Sun Fire V490 Documentation CD.

---

## Power Supplies

Sun Fire V490 power supplies are hot-swappable—they can be removed or inserted at any time without prior software preparation. Keep in mind that a power supply is hot-swappable only as long as it is part of a redundant power configuration—a system configured with both power supplies in working condition. (Logically, you cannot “hot-swap” a power supply if it is the only one in the system that still works.)

Unlike other hot-pluggable devices, you can install or remove a power supply while the system is operating at the `ok` prompt when the blue OK-to-Remove LED is lit.

For additional information, see “About the Power Supplies” on page 38. For instructions on removing or installing power supplies, see the *Sun Fire V490 Server Parts Installation and Removal Guide*.

# Disk Drives

Sun Fire V490 internal disk drives are hot-pluggable. However, certain software preparations are required prior to removing or installing a drive. To perform Sun Fire V490 disk drive hot-plug operations, you use the Solaris `luxadm` utility. The `luxadm` utility is a command-line tool for managing intelligent storage arrays such as Sun StorEdge A5x00 series disk arrays or Sun Fire V490 internal storage arrays. For more information about `luxadm`, see the `luxadm` man page. For detailed disk hot-plug instructions, see the *Sun Fire V490 Server Parts Installation and Removal Guide*, which is included on the Sun Fire V490 Documentation CD.



---

**Caution** – When hot-plugging a disk drive, first ensure that the drive's OK-to-Remove LED is lit. Then, after disconnecting the drive from the FC-AL backplane, allow 30 seconds or so for the drive to spin down completely before removing it.

---

---

## About the CPU/Memory Boards

The system centerplane provides slots for up to two CPU/Memory boards. Each CPU/Memory board incorporates two UltraSPARC IV 1050-MHz processors, with 16 Mbytes of static random access memory (SRAM) external cache memory per processor, and slots for up to 16 memory modules. The external cache memory cannot be upgraded.

The memory module slots are labeled A and B. The processors in the system are numbered from 0 to 3, depending on the slot where the processors reside.

### Module A

- Processor 0 - CPU 0, 16
- Processor 1 - CPU 2, 18

### Module B

- Processor 0 - CPU 1, 17
- Processor 1 - CPU 3, 19

---

**Note** – CPU/Memory boards on a Sun Fire V490 system are *not* hot-pluggable.

---

The UltraSPARC IV processor is a highly integrated processor implementing the SPARC V9 64-bit architecture. The UltraSPARC IV processor supports both 2D and 3D graphics, as well as image processing, video compression and decompression, and video effects through the sophisticated Visual Instruction Set (VIS) extension.

VIS provides high levels of multimedia performance, including real-time video compression and decompression and two streams of MPEG-2 decompression at full broadcast quality with no additional hardware support.

The Sun Fire V490 server employs a shared-memory multiprocessor architecture with all processors sharing the same physical address space. The system processors, main memory, and I/O subsystem communicate via a high-speed system interconnect bus, operating at a clock rate of 150 MHz. In a system configured with multiple CPU/Memory boards, all main memory is accessible from any processor over the system bus. The main memory is logically shared by all processors and I/O devices in the system.

For information about memory modules and memory configuration guidelines, see “About the Memory Modules” on page 28.

---

## About the Memory Modules

The Sun Fire V490 server uses 3.3-volt, high-capacity dual inline memory modules (DIMMs). The DIMMs are built with synchronous dynamic random access memory (SDRAM) chips that operate at a 75-MHz clock frequency. The system supports DIMMs with 512-Mbyte and 1-Gbyte capacities.

Each CPU/Memory board contains slots for 16 DIMMs. Total system memory ranges from a minimum of 8 Gbytes (one CPU/Memory board with eight 512-Mbyte DIMMs) to a maximum of 32 Gbytes (two boards fully populated with 1-Gbyte DIMMs).

Within each CPU/Memory board, the 16 DIMM slots are organized into groups of four. The system reads from, or writes to, all four DIMMs in a group simultaneously. DIMMs, therefore, must be added in sets of four. FIGURE 3-1 shows the DIMM slots and DIMM groups on a Sun Fire V490 CPU/Memory board. Every fourth slot belongs to the same DIMM group. The four groups are designated A0, A1, B0, and B1.



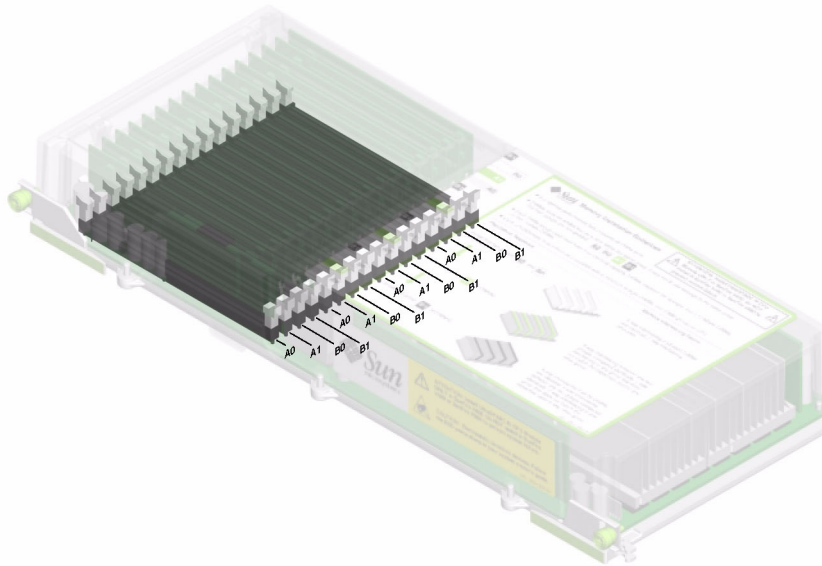

**FIGURE 3-1** Memory Module Groups A0, A1, B0, B1

You must physically remove a CPU/Memory board from the system before you can install or remove DIMMs. The DIMMs must be added four-at-a-time within the same DIMM group, and each group used must have four identical DIMMs installed—that is, all four DIMMs in the group must be from the same manufacturing vendor and must have the same capacity (for example, four 512-Mbyte DIMMs or four 1-Gbyte DIMMs).



---

**Caution** – DIMMs are made of electronic components that are extremely sensitive to static electricity. Static from your clothes or work environment can destroy the modules. Do not remove a DIMM from its antistatic packaging until you are ready to install it on the system board. Handle the modules only by their edges. Do not touch the components or any metal parts. Always wear an antistatic grounding strap when you handle the modules. For more information, see “How to Avoid Electrostatic Discharge” on page 120.

---

# Memory Interleaving

You can maximize the system's memory bandwidth by taking advantage of its memory interleaving capabilities. Sun Fire V490 systems support two-way, four-way, and eight-way memory interleaving. In most cases, higher interleaving factors result in greater system performance. However, actual performance results may vary depending on the system application.

The system's interleaving capabilities are summarized as follows:

- Memory interleaving is limited to memory within the same CPU/Memory board. Memory is not interleaved across CPU/Memory boards.
- Eight-way interleaving occurs automatically when all 16 DIMM slots in a CPU/Memory board are filled with identical capacity DIMMs (16 identical DIMMs).
- Four-way interleaving occurs automatically between any two DIMM groups that are configured identically (eight identical capacity DIMMs).
- Two-way interleaving occurs automatically in any DIMM group where the DIMM capacities do not match the capacities used in any other group.

## Independent Memory Subsystems

Each Sun Fire V490 CPU/Memory board contains two independent memory subsystems (one per UltraSPARC IV processor). Memory controller logic incorporated into the UltraSPARC IV processor allows each processor to control its own memory subsystem. One processor controls DIMM groups A0 and A1, while the other processor controls DIMM groups B0 and B1.

The Sun Fire V490 system uses a shared memory architecture. During normal system operations, the total system memory is shared by all processors in the system. However, in the event of a processor failure, the two DIMM groups associated with the failed processor become unavailable to the other processors in the system.

TABLE 3-1 shows the association between the processors and their corresponding DIMM groups.

**TABLE 3-1** Association Between Processors and DIMM Groups

CPU Number	CPU/Memory Slot	Associated Local DIMM Groups
CPU 0	Slot A	A0, A1

TABLE 3-1 Association Between Processors and DIMM Groups (Continued)

CPU Number	CPU/Memory Slot	Associated Local DIMM Groups
CPU 1	Slot B	B0, B1
CPU 2	Slot A	A0, A1
CPU 3	Slot B	B0, B1

## Configuration Rules

- DIMMs must be added four-at-a-time within the same group of DIMM slots; every fourth slot belongs to the same DIMM group.
- Each group used must have four identical DIMMs installed—that is, all four DIMMs must be from the same manufacturing vendor and must have the same capacity (for example, four 512-Mbyte DIMMs or four 1-Gbyte DIMMs).

For guidelines and complete instructions on how to install DIMMs in a CPU/Memory board, see the *Sun Fire V490 Server Parts Installation and Removal Guide*.

---

**Note** – Do not attempt to access any internal components unless you are a qualified service technician. Detailed service instructions can be found in the *Sun Fire V490 Server Parts Installation and Removal Guide*, which is included on the Sun Fire V490 Documentation CD.

---

---

## About the PCI Cards and Buses

All system communication with storage peripherals and network interface devices is mediated by two Peripheral Component Interconnect (PCI) bridge chips, located on the system's centerplane. Each bridge chip manages communication between the system's main interconnect bus and two PCI buses, giving the system a total of four separate PCI buses. The four PCI buses support up to six PCI interface cards and four centerplane devices.

TABLE 3-2 describes the PCI bus characteristics and maps each bus to its associated bridge chip, integrated devices, and PCI card slots. All slots comply with PCI Local Bus Specification Revision 2.1.

---

**Note** – PCI cards in a Sun Fire V490 system are *not* hot-pluggable.

---

**TABLE 3-2** PCI Bus Characteristics, Associated Bridge Chips, Centerplane Devices, and PCI Slots

PCI Bridge	PCI Bus	Clock Rate (MHz)/ Bandwidth (bits)/ Voltage (V)	Integrated Devices	PCI Slots
0	PCI A	66 MHz 64 bits 3.3V	None	Full-length slots 0 and 1
0	PCI B	33 MHz 64 bits 5V	IDE controller (interface to the DVD-ROM drive)	Full-length slot 2, short slots 3, 4, 5
1	PCI C	66 MHz 64 bits 3.3V	FC-AL controller Ethernet controller	None
1	PCI D	33 MHz 64 bits 5V	Ethernet controller RIO ASIC (USB and EBus interfaces)	None

FIGURE 3-2 shows the PCI card slots on the PCI riser board.

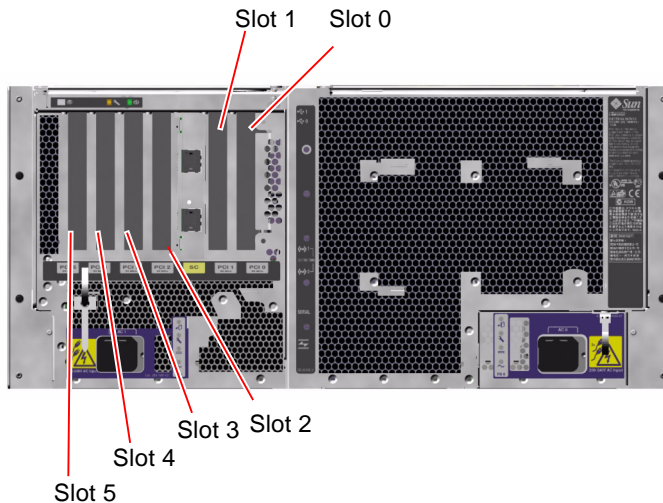

**FIGURE 3-2** PCI Slots

## Configuration Rules

- Three slots (0, 1, 2) accept short or long PCI cards, while the other three (3, 4, 5) support only short cards; that is, cards less than 7.5 inches (~19 cm) long.
- 33-MHz slots accept 5V PCI cards; 66-MHz slots are keyed as 3.3V only cards.
- All slots accept either 32-bit or 64-bit PCI cards.
- All slots comply with PCI Local Bus Specification Revision 2.1.
- Each slot can supply up to 25 watts of power. The *total* power used for all six slots must not exceed 90 watts.
- Compact PCI (cPCI) cards and SBus cards are not supported.
- A 33-MHz add-in card plugged in to either of the 66-MHz slots will cause that bus to operate at 33 MHz.
- You can improve overall system availability by installing redundant network or storage interfaces on separate PCI buses. For additional information, see “About Multipathing Software” on page 64.

---

**Note** – Do not attempt to access any internal components unless you are a qualified service technician. Detailed service instructions can be found in the *Sun Fire V490 Server Parts Installation and Removal Guide*, which is included on the Sun Fire V490 Documentation CD.

---

---

## About the System Controller (SC) Card

The system controller (SC) card enables access, monitoring, and control of the Sun Fire V490 server from a remote location. It is a fully independent processor card with its own resident firmware, power-on self-test (POST) diagnostics, and real-time operating system.

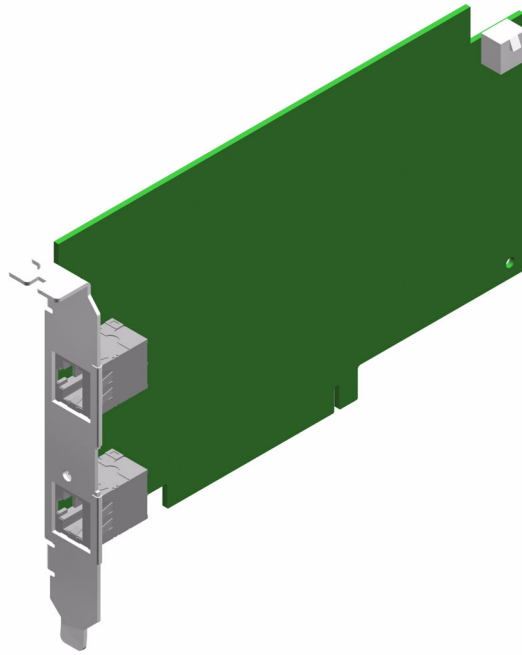

**FIGURE 3-3** Sun System Controller (SC) Card

The SC card features serial and Ethernet interfaces that provide simultaneous access to the Sun Fire V490 server for multiple RSC software users. RSC software users are provided secure access to the system's Solaris and OpenBoot console functions and have full control over power-on self-test (POST) and OpenBoot Diagnostics.

The SC card runs independently of the host server, and operates off of 5V standby power from the system's power supplies. The card features on-board devices that interface with the system's environmental monitoring subsystem and can automatically alert administrators to system problems. Together these features enable the SC card and RSC software to serve as a "lights out" management tool that continues to function even when the server operating system goes offline or when the system is powered off.

The SC card plugs in to a dedicated slot on the system PCI riser board and provides the following ports (listed in order from top to bottom, as shown in FIGURE 3-4) through an opening in the system's back panel:

- Serial communication port via an RJ-45 connector
- 10-Mbps Ethernet port via an RJ-45 twisted-pair Ethernet (TPE) connector

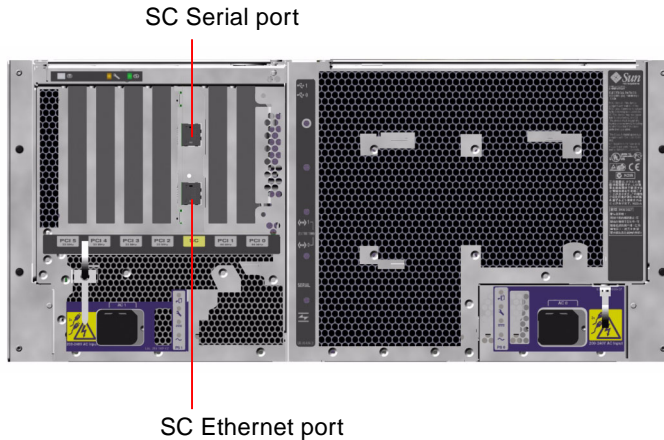

**FIGURE 3-4** SC Card Ports

Both SC connection ports can be used simultaneously or individually disabled.

---

**Note** – You must install the Solaris OS and the Sun Remote System Control software prior to setting up an SC console. For more information, see “How to Monitor the System Using the System Controller and RSC Software” on page 190.

---

Once you install the operating system and the RSC software, you can then configure the system to use the SC as the system console. For detailed instructions, see “How to Redirect the System Console to the System Controller” on page 159.

## Configuration Rules

- The SC card is installed in a dedicated slot on the system PCI riser board. Never move the SC card to another system slot, since it is *not* a PCI-compatible card.
- The SC card is *not* a hot-pluggable component. Before installing or removing an SC card, you must power off the system and disconnect all system power cords.

---

**Note** – Do not attempt to access any internal components unless you are a qualified service technician. Detailed service instructions can be found in the *Sun Fire V490 Server Parts Installation and Removal Guide*, which is included on the Sun Fire V490 Documentation CD.

---

---

# About Hardware Jumpers

Three jumpers are located on the Sun Fire V490 system's PCI riser board. Note that jumpers are set at the factory to ensure best system performance. Be aware that moving any jumper shunt from its default location can render the system unstable or unusable.

All jumpers are marked with identification numbers. For example, the jumpers on the system PCI riser board are marked J1102, J1103, and J1104. Jumper pins are located immediately adjacent to the identification number. The default jumper positions are indicated on the board by a white outline. Pin 1 is marked with asterisks (\*), as shown in FIGURE 3-5.

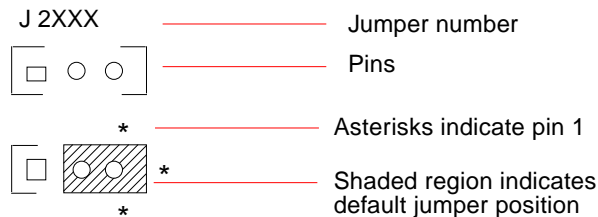
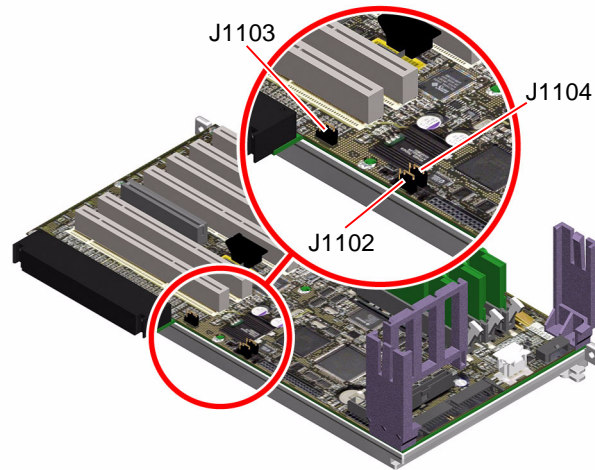

**FIGURE 3-5** Jumper Identification Guide

## PCI Riser Board Jumpers

On the PCI riser board are three jumpers, two of which affect transactions with the system Boot PROM and one of which is reserved for future use. FIGURE 3-6 illustrates the locations of these three jumpers.







**FIGURE 3-6** Hardware Jumpers on PCI Riser Board

The functions of the PCI riser board jumpers are shown in TABLE 3-3.

**TABLE 3-3** PCI Riser Board Jumper Functions

Jumper	Shunt on Pins 1 + 2 Selects	Shunt on Pins 2 + 3 Selects	Default Setting
J1102 	OpenBoot flash PROM	Optional debug device populating connector in position J1101	1 + 2
J1103 	Reserved for future use	Reserved for future use	1 + 2
J1104 	OpenBoot flash PROM Write-enabled	OpenBoot flash PROM Write-protected	1 + 2

Each jumper on the PCI riser board has two options, as described in the following list.

- J1102 – Labeled “CS” on the PCI riser board, this jumper is used to select the Boot PROM device. In the default position with the shunt covering pins 1 and 2, the system boots the OpenBoot flash PROM on the centerplane. In the other position, the system boots by way of an optional debug device that populates the connector at location J1101.

- J1103 – Labeled “Hi-Lo” on the PCI riser board, this jumper is reserved for future use.
- J1104 – Labeled “WREN” on the PCI riser board, this jumper controls write permissions for the system Boot PROM. In the default position with the shunt covering pins 1 and 2, the system Boot PROM is write-enabled. Moving the shunt to the other position prevents updating the PROM.

---

## About the Power Supplies

A central power distribution board (PDB) delivers DC power to all internal system components. The system’s two standard power supplies—called Power Supply 0 and Power Supply 1—plug in directly to connectors on this board, and all of the supplies installed share equally in satisfying the power demands of the system. AC power is brought into the PDB by way of two board-mounted IEC320 receptacles, each dedicated to one power supply.

The Sun Fire V490 system’s N+1 redundant power supplies are modular units, designed for fast, easy installation or removal, even while the system is fully operational. Power supplies are installed in bays at the front of the system, as shown in the following figure.



Location of Power Supply 0

Location of Power Supply 1

**FIGURE 3-7** Power Supply Locations

The power supplies operate over an AC input range of 200–240 VAC, 50–60 Hz, without user intervention. The power supplies are capable of providing up to 1448 watts of DC power. The basic system configuration comes with two power supplies installed, either of which is capable of providing sufficient power for a maximally configured system.

The power supplies provide 48-volt and 5-volt standby outputs to the system. The 48-volt output powers point-of-load DC/DC converters that provide 1.5V, 1.8V, 2.5V, 3.3V, 5V, and 12V to the system components. Output current is shared equally between both supplies via active current-sharing circuitry.

Power supplies in a redundant configuration feature a hot-swap capability. You can remove and replace a faulty power supply without shutting down the operating system or turning off the system power. For additional details, see “About Hot-Pluggable and Hot-Swappable Components” on page 26.

Each power supply has separate status LEDs to provide power and fault status information. For additional details, see “How to Isolate Faults Using LEDs” on page 172.

## Configuration Rule

- Good practice is to connect each power supply to a separate AC circuit, which will maintain N+1 redundancy and enable the system to remain operational if one of the AC circuits fails. Consult your local electrical codes for any additional requirements.



---

**Caution** – If any power supply fails, leave the supply in its bay until you are ready to install a replacement.

---

For information about installing power supplies, see the *Sun Fire V490 Server Parts Installation and Removal Guide*, which is included on the Sun Fire V490 Documentation CD.

---

## About the Fan Trays

The basic system is equipped with five fans mounted on two fan trays, providing front-to-rear cooling: Fan Tray 0, which holds three fans that cool the CPUs, and Fan Tray 1, which holds two fans that cool the FC-AL drives and PCI cards. Fan Tray 0 is accessible from the front of the system, while Fan Tray 1 requires that you remove the system’s PCI access panel to gain access to it. Power supplies are cooled separately, each with its own internal fans.



---

**Caution** – Fans on a Sun Fire V490 system are *not* hot-pluggable. Do not attempt to access any internal components unless you are a qualified service technician. Detailed service instructions can be found in the *Sun Fire V490 Server Parts Installation and Removal Guide*, which is included on the Sun Fire V490 Documentation CD.

---



---

**Caution** – A complete set of two working fan trays *must* be present in the system at *all* times. After removing a fan tray, you *must* install a replacement fan tray. Failure to install a replacement tray could lead to serious overheating of your system and result in severe damage to the system. For more information, see “Environmental Monitoring and Control” on page 20.

---

The following figure shows both fan trays. The figure on the left shows Fan Tray 0, which cools the CPUs. The figure on the right shows Fan Tray 1, which cools the FC-AL drives and PCI cards.

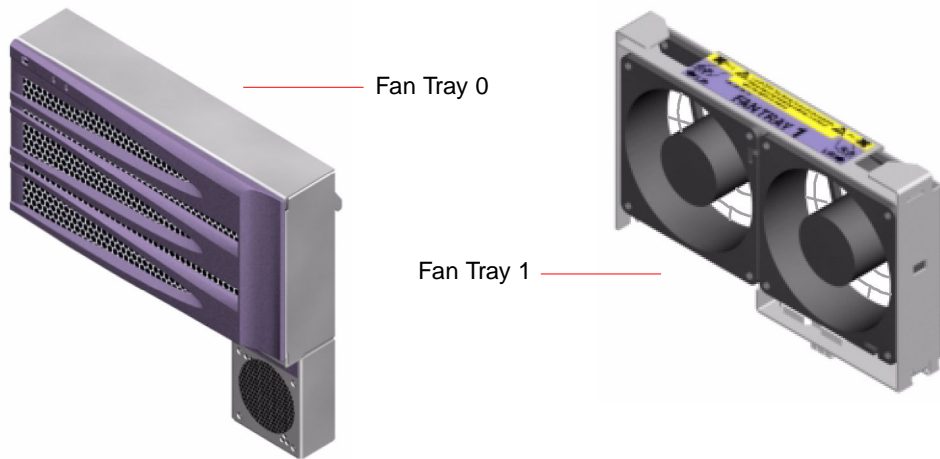

**FIGURE 3-8** Fan Trays

Status for each fan tray is indicated by separate LEDs on the system’s front panel, which are activated by the environmental monitoring subsystem. The fans operate at full speed all the time—speed is not adjustable. Should a fan speed fall below a predetermined threshold, the environmental monitoring subsystem prints a warning and lights the appropriate Fault LED. For additional details, see “How to Isolate Faults Using LEDs” on page 172.

For each fan in the system, the environmental monitoring subsystem monitors or controls the following:

- Fan speed in revolutions per minute (RPM) (monitored)
- Fan Fault LEDs (controlled)

## Configuration Rule

- The minimum system configuration requires a complete set of two working fan trays—Fan Tray 0 for the CPUs and Fan Tray 1 for the FC-AL drives and PCI cards.

---

**Note** – Do not attempt to access any internal components unless you are a qualified service technician. Detailed service instructions can be found in the *Sun Fire V490 Server Parts Installation and Removal Guide*, which is included on the Sun Fire V490 Documentation CD.

---

## About FC-AL Technology

Fibre Channel (FC) is a high-performance serial interconnect standard designed for bidirectional, point-to-point communication among servers, storage systems, workstations, switches, and hubs.

Fibre Channel-Arbitrated Loop (FC-AL) is an important enhancement to the FC standard, developed specifically to meet the needs of storage system interconnects. Employing a simple loop topology, FC-AL can support both simple configurations and complex arrangements of hubs, switches, servers, and storage systems.

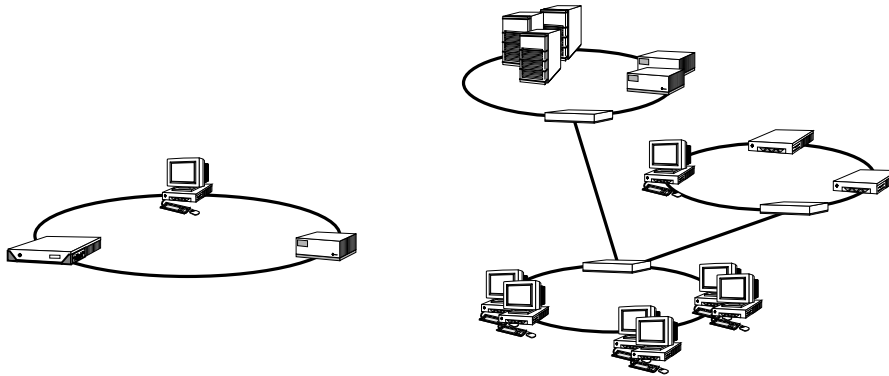

FC-AL devices employ a high-performance serial interface, which supports multiple standard protocols such as Small Computer Systems Interface (SCSI) and Asynchronous Transfer Mode (ATM). By supporting these standard protocols, FC-AL preserves any investment in legacy systems, firmware, applications, and software.

The unique features of FC-AL provide many advantages over other data transfer technologies. For additional information about FC-AL technology, visit the Fibre Channel Association Web site at <http://www.fibrechannel.org>.

The following table lists the features and advantages of FC-AL technology.

**TABLE 3-4** FC-AL Features and Advantages

FC-AL Features	Advantages
Supports 100-Mbyte per second data transfer rate (200 Mbytes per second with dual porting).	High throughput meets the demands of current generation high-performance processors and disks.
Capable of addressing up to 127 devices per loop (controlled by a single controller) <sup>1</sup> .	High connectivity controlled by one device allows flexible and simpler configurations.
Provides for reliability, availability, and serviceability (RAS) features such as hot-pluggable and dual-ported disks, redundant data paths, and multiple host connections.	RAS features provide improved fault tolerance and data availability.
Supports standard protocols.	Migration to FC-AL produces small or no impact on software and firmware.
Implements a simple serial protocol over copper or fiber cable.	Configurations that use serial connections are less complex because of the reduced number of cables per connection.
Supports redundant array of independent disks (RAID).	RAID support enhances data availability.

<sup>1</sup> The 127 supported devices include the FC-AL controller required to support each arbitrated loop.

---

# About the FC-AL Backplane

All Sun Fire V490 servers include a single FC-AL backplane with connections for two internal hard disks, both of which are hot-pluggable.

The FC-AL backplane accepts two, low-profile (1.0-inch, 2.54-cm), dual-ported FC-AL disk drives. Each disk drive is connected to the backplane via a standard 40-pin single connector attachment (SCA) interface. Incorporating all power and signal connections into a single, blind-mating connector, SCA technology makes it easy to add or remove disk drives from the system. Disks using SCA connectors provide higher availability and better serviceability than disks using other types of connectors.

The FC-AL backplane provides dual-loop access to both internal disk drives. Dual-loop configurations enable each disk drive to be accessed through two separate and distinct data paths. This capability provides:

- *Increased bandwidth* – Allowing faster data transfer rates than those for single-loop configurations
- *Hardware redundancy* – Providing the ability to sustain component failures in one path by switching all data transfers to an alternate path

---

**Note** – To take advantage of the dual-loop capability of the FC-AL backplane, an optional PCI FC-AL host adapter card must be installed to control the second loop (Loop B). For more information, see “About the FC-AL Host Adapters” on page 44.

---

Port bypass controllers (PBCs) on the disk backplane ensure loop integrity. When a disk or external device is unplugged or fails, the PBCs automatically bypass the device, closing the loop to maintain data availability.

## Configuration Rules

- The FC-AL backplane requires low-profile (1.0-inch, 2.54-cm) disk drives.
- The FC-AL *disks* are hot-pluggable.

For information about installing or removing an FC-AL disk or disk backplane, see the *Sun Fire V490 Server Parts Installation and Removal Guide*, which is included on the Sun Fire V490 Documentation CD.

---

## About the HSSDC FC-AL Port

The Sun Fire V490 system back panel includes an FC-AL port with a high-speed serial data connector (HSSDC).

---

**Note** – At this time, no Sun storage products are supported utilizing the HSSDC connector.

---

---

## About the FC-AL Host Adapters

The Sun Fire V490 server uses an intelligent Fibre Channel processor as its on-board FC-AL controller. Integrated into the system centerplane, the processor resides on PCI Bus C and supports a 64-bit, 66-MHz PCI interface. The on-board FC-AL controller controls FC-AL operations on *Loop A*.

To take advantage of the dual-loop capability of the FC-AL backplane, an optional PCI FC-AL host adapter card and optional cable are required to control the second loop (*Loop B*). For this purpose, Sun offers the Sun StorEdge PCI Dual Fibre Channel Host Adapter card. See the *Sun Fire V490 Server Parts Installation and Removal Guide*, which is included on the Sun Fire V490 Documentation CD, for installation instructions.

## Configuration Rules

- The Sun Fire V490 server does not support *all* FC-AL host adapter cards. Contact your Sun sales or support engineer for a list of supported cards.
- For best performance, install 66-MHz FC-AL host adapter cards into a 66-MHz PCI slot (slot 0 or 1, if available). See “About the PCI Cards and Buses” on page 31.

---

**Note** – Do not attempt to access any internal components unless you are a qualified service technician. Detailed service instructions can be found in the *Sun Fire V490 Server Parts Installation and Removal Guide*, which is included on the Sun Fire V490 Documentation CD.

---



---

## About the Internal Disk Drives

The Sun Fire V490 system includes two internal, low-profile (1.0-inch, 2.54-cm) FC-AL disk drives, attached to a backplane. (The system also includes an external FC-AL port; see the section, “About the HSSDC FC-AL Port” on page 44.) Internal disks are available in storage capacities of 73 or 146 Gbytes, with a rotation speed of 10,000 RPM. The maximum internal storage capacity is 292 Gbytes (using two 146-Gbyte disks), with larger capacities possible as disk storage capacities continue to grow.

Sun Fire V490 disk drives are dual-ported for multipath access. When used in a dual-loop configuration—with the optional addition of a second FC-AL controller on a PCI adapter card—each drive can be accessed through two separate and distinct data paths.

Sun Fire V490 disk drives are hot-pluggable. You can add, remove, or replace disks while the system continues to operate. This capability significantly reduces system downtime associated with disk drive replacement. Disk drive hot-plug procedures involve software commands for preparing the system prior to removing a disk drive and for reconfiguring the operating system after installing a drive. For detailed instructions, see the *Sun Fire V490 Server Parts Installation and Removal Guide*, which is included on the Sun Fire V490 Documentation CD.

Three LEDs are associated with each drive, indicating the drive’s operating status, hot-plug readiness, and any fault conditions associated with the drive. These status LEDs help you quickly to identify drives requiring service. See TABLE 2-3 for a description of these LEDs.

### Configuration Rule

- Disk drives must be Sun standard FC-AL disks with low-profile (1.0-inch, 2.54-cm) form factors.

---

## About the Serial Port

The system provides a serial communication port through an RJ-45 connector located on the back panel. The port supports baud rates of 50, 75, 110, 200, 300, 600, 1200, 1800, 2400, 4800, 9600, 19200, 38400, 57600, 76800, 115200, 153600, 230400, 307200, and 460800.

The port is accessible by connecting an RJ-45 serial cable to the back panel serial port connector. For your convenience, a serial port adapter (part number 530-2889-03) is included in your Sun Fire V490 server ship kit. This adapter enables you to use a standard RJ-45 serial cable to connect directly from the serial connector on the back panel to a Sun workstation, or to any other terminal that is equipped with a DB-25 serial connector.

For the serial port location, see “Locating Back Panel Features” on page 16. Also see Appendix A.

---

## About the USB Ports

The system’s back panel provides two external Universal Serial Bus (USB) ports for connection to USB peripheral devices such as:

- Sun Type-6 USB keyboard
- Sun opto-mechanical three-button USB mouse
- Printers
- Scanners
- Digital cameras

For USB port locations, see “Locating Back Panel Features” on page 16.

The USB ports are compliant with the Open Host Controller Interface (Open HCI) specification for USB Revision 1.0. Both ports support isochronous and asynchronous modes. The ports enable data transmission at speeds of 1.5 Mbps and 12 Mbps. Note that the USB data transmission speed is significantly faster than that of the standard serial ports, which operate at a maximum rate of 460.8 Kbaud.

The USB ports are accessible by connecting a USB cable to either back panel USB connector. The connectors at each end of a USB cable are different, so you cannot connect them incorrectly. One connector plugs in to the system or USB hub; the other plugs in to the peripheral device. Up to 126 USB devices can be connected to the bus simultaneously, through the use of USB hubs. The Universal Serial Bus provides power for smaller USB devices such as modems. Larger USB devices, such as scanners, require their own power source.

Both USB ports support hot-plugging. You can connect and disconnect the USB cable and peripheral devices while the system is running, without affecting system operations. However, you can only perform USB hot-plug operations while the operating system is running. USB hot-plug operations are not supported when the system `ok` prompt is displayed.

# Network Interfaces and System Firmware

---

This chapter describes the networking options of the system and provides background information about the system's firmware.

Information covered in this chapter includes:

- “About the Network Interfaces” on page 47
- “About Redundant Network Interfaces” on page 48
- “About the ok Prompt” on page 49
- “About OpenBoot Environmental Monitoring” on page 52
- “About OpenBoot Emergency Procedures” on page 54
- “About Automatic System Recovery” on page 55
- “About Manually Configuring Devices” on page 59
- “Reference for Device Identifiers” on page 61

---

## About the Network Interfaces

The Sun Fire V490 server provides two on-board Ethernet interfaces, which reside on the system centerplane and conform to the IEEE 802.3z Ethernet standard. For an illustration of the Ethernet ports, see FIGURE 2-4. The Ethernet interfaces operate at 10 Mbps, 100 Mbps, and 1000 Mbps.

Two back panel ports with RJ-45 connectors provide access to the on-board Ethernet interfaces. Each interface is configured with a unique media access control (MAC) address. Each connector features two LEDs, as described in TABLE 4-1.

TABLE 4-1 Ethernet Port LEDs

Name	Description
Activity	This amber LED lights when data is either being transmitted or received by the particular port.
Link Up	This green LED lights when a link is established at the particular port with its link partner.

Additional Ethernet interfaces or connections to other network types are available by installing the appropriate PCI interface cards. An additional network interface card can serve as a redundant network interface for one of the system's on-board interfaces. If the active network interface becomes unavailable, the system can automatically switch to the redundant interface to maintain availability. This capability is known as *automatic failover* and must be configured at the Solaris OS level. For additional details, see "About Redundant Network Interfaces" on page 48.

The Ethernet driver is installed automatically during the Solaris installation procedure.

For instructions on configuring the system network interfaces, see:

- "How to Configure the Primary Network Interface" on page 144
- "How to Configure Additional Network Interfaces" on page 146

---

## About Redundant Network Interfaces

You can configure your system with redundant network interfaces to provide a highly available network connection. Such a configuration relies on special Solaris software features to detect a failed or failing network interface and automatically switch all network traffic over to the redundant interface. This capability is known as *automatic failover*.

To set up redundant network interfaces, you can enable automatic failover between the two similar interfaces using the IP Network Multipathing feature of the Solaris OS. For additional details, see "About Multipathing Software" on page 64. You can also install a pair of identical PCI network interface cards, or add a single card that provides an interface identical to one of the two on-board Ethernet interfaces.

To help maximize system availability, make sure that any redundant network interfaces reside on separate PCI buses, supported by separate PCI bridges. For additional details, see “About the PCI Cards and Buses” on page 31.

---

## About the `ok` Prompt

A Sun Fire V490 system with Solaris OS software is capable of operating at different *run levels*. A synopsis of run levels follows; for a full description, see the Solaris system administration documentation.

Most of the time, you operate a Sun Fire V490 system at run level 2, or run level 3, which are multiuser states with access to full system and network resources. Occasionally, you may operate the system at run level 1, which is a single-user administrative state. However, the most basic state is run level 0. At this state, it is safe to turn off power to the system.

When a Sun Fire V490 system is at run level 0, the `ok` prompt appears. This prompt indicates that the OpenBoot firmware is in control of the system.

There are a number of scenarios in which this can happen.

- The system comes up under OpenBoot firmware control before the Solaris OS software is installed, or whenever the `auto-boot?` OpenBoot configuration variable is set to `false`.
- The system transitions to run level 0 in an orderly way when the Solaris OS software is halted.
- The system reverts to OpenBoot firmware control when the Solaris OS software crashes.
- During the boot process, there is a serious hardware problem that prevents the Solaris OS software from running, and the system reverts to OpenBoot firmware control.
- A serious hardware problem develops while the system is running, and the Solaris OS software transitions smoothly to run level 0.
- You deliberately place the Sun Fire V490 system under firmware control in order to execute firmware-based commands or run diagnostic tests.

It is the last of these scenarios that most often concerns you as an administrator, since there will be times when you need to reach the `ok` prompt. The several ways to do this are outlined in “Ways of Reaching the `ok` Prompt” on page 50. For detailed instructions, see “How to Get to the `ok` Prompt” on page 126.

# What You Should Know About Accessing the `ok` Prompt

It is important to understand that when you access the `ok` prompt from a functioning Sun Fire V490 system, you are suspending the Solaris OS software and placing the system under firmware control. Any processes that were running under the Solaris OS software are also suspended, and *the state of such processes may not be recoverable*.

The firmware-based tests and commands you run from the `ok` prompt have the potential to affect the state of the system. This means that it is not always possible to resume execution of the Solaris OS software from the point at which it was suspended. Although the `go` command will resume execution in most circumstances, in general, each time you drop the system down to the `ok` prompt, you should expect to have to reboot it to get back to the Solaris OS environment.

As a rule, before suspending the Solaris OS software, you should back up files, warn users of the impending shutdown, and halt the system in an orderly manner. However, it is not always possible to take such precautions, especially if the system is malfunctioning.

## Ways of Reaching the `ok` Prompt

There are several ways to get to the `ok` prompt, depending on the state of the system and the means by which you are accessing the system console. In order of desirability, these are:

- Graceful halt
- Stop-A or Break key sequence
- Externally initiated reset (XIR)
- Manual system reset

A discussion of each method follows. For instructions, see “How to Get to the `ok` Prompt” on page 126.

### Graceful Halt

The preferred method of reaching the `ok` prompt is to halt the operating system software by issuing an appropriate command (for example, the `shutdown`, `init`, `halt`, or `uadmin` command) as described in Solaris system administration documentation.

Gracefully halting the system prevents data loss, allows you to warn users beforehand, and causes minimal disruption. You can usually perform a graceful halt, provided Solaris OS software is running and the hardware has not experienced serious failure.

## Stop-A (L1-A) or Break Key Sequence

When it is impossible or impractical to halt the system gracefully, you can get to the `ok` prompt by typing the Stop-A (or L1-A) key sequence from a Sun keyboard, or, if you have an alphanumeric terminal attached to the Sun Fire V490 system, by pressing the Break key.

If you use this method to reach the `ok` prompt, be aware that issuing certain OpenBoot commands (like `probe-scsi`, `probe-scsi-all`, and `probe-ide`) may hang the system.

## Externally Initiated Reset (XIR)

Generating an externally initiated reset (XIR) has the advantage of allowing you to issue the `sync` command to preserve file systems and produce a dump file of part of the system state for diagnostic purposes. Forcing an XIR may be effective in breaking the deadlock that is hanging up the system, but it also precludes the orderly shutdown of applications, and so it is not the preferred method of reaching the `ok` prompt.

## Manual System Reset

Reaching the `ok` prompt by performing a manual system reset should be the method of last resort. Doing this results in the loss of all system coherence and state information. It also corrupts the machine's file systems, although the `fsck` command usually restores them. Use this method only if nothing else works.



---

**Caution** – Forcing a manual system reset results in loss of system state data and risks corrupting your file systems.

---

## For More Information

For more information about the OpenBoot firmware, see:

- *OpenBoot 4.x Command Reference Manual*

An online version of the manual is included with the Solaris Software Supplement CD that ships with Solaris software. It is also available at the following web site under Solaris on Sun Hardware:

<http://docs.sun.com>

---

## About OpenBoot Environmental Monitoring

Environmental monitoring and control capabilities for Sun Fire V490 systems reside at both the operating system level and the OpenBoot firmware level. This ensures that monitoring capabilities are operational even if the system has halted or is unable to boot. When the system is under OpenBoot control, the OpenBoot environmental monitor checks the state of the system power supplies, fans, and temperature sensors periodically. If it detects any voltage, current, fan speed, or temperature irregularities, the monitor generates a warning message to the system console.

For additional information about the system's environmental monitoring capabilities, see "Environmental Monitoring and Control" on page 20.

## Enabling or Disabling the OpenBoot Environmental Monitor

The OpenBoot environmental monitor is enabled by default when the system is operating at the `ok` prompt. However, you can enable or disable it yourself using the OpenBoot commands `env-on` and `env-off`. For more information, see:

- "How to Enable OpenBoot Environmental Monitoring" on page 154
- "How to Disable OpenBoot Environmental Monitoring" on page 154

The commands `env-on` and `env-off` only affect environmental monitoring at the firmware level. They have no effect on the system's environmental monitoring and control capabilities while the operating system is running.



---

**Note** – Using the Stop-A keyboard command to enter the OpenBoot environment during power-on or reset will immediately disable the OpenBoot environmental monitor. If you want the OpenBoot PROM environmental monitor enabled, you must reenable it prior to rebooting the system. If you enter the OpenBoot environment through any other means—by halting the operating system, by power-cycling the system, or as a result of a system panic—the OpenBoot environmental monitor will remain enabled.

---

## Automatic System Shutdown

If the OpenBoot environmental monitor detects a critical overtemperature condition, it will initiate an automatic system power off sequence. In this case, a warning similar to the following is generated to the system console:

```
WARNING: SYSTEM POWERING DOWN IN 30 SECONDS!  
Press Ctrl-C to cancel shutdown sequence and return to ok prompt.
```

If necessary, you can type Ctrl-C to abort the automatic shutdown and return to the system ok prompt; otherwise, after the 30 seconds expire, the system will power off automatically.

---

**Note** – Typing Ctrl-C to abort an impending shutdown also has the effect of disabling the OpenBoot environmental monitor. This gives you enough time to replace the component responsible for the critical condition without triggering another automatic shutdown sequence. After replacing the faulty component, you must type the `env-on` command to reinstate OpenBoot environmental monitoring.

---



---

**Caution** – If you type Ctrl-C to abort an impending shutdown, you should immediately replace the component responsible for the critical condition. If a replacement part is not immediately available, power off the system to avoid damaging system hardware.

---

## OpenBoot Environmental Status Information

The OpenBoot command `.env` enables you to obtain status on the current state of everything of interest to the OpenBoot environmental monitor. This includes information about the system's power supplies, fans, and temperature sensors.

You can obtain environmental status at any time, regardless of whether OpenBoot environmental monitoring is enabled or disabled. The `.env` status command simply reports the current environmental status information; it does not take action if anything is abnormal or out of range.

For an example of `.env` command output, see “How to Obtain OpenBoot Environmental Status Information” on page 155.

---

## About OpenBoot Emergency Procedures

The introduction of Universal Serial Bus (USB) keyboards has made it necessary to change some of the OpenBoot emergency procedures. Specifically, the Stop-D, Stop-F, and Stop-N commands that were available on systems with non-USB keyboards are not supported on systems that use USB keyboards, such as the Sun Fire V490 system. The following sections describe the OpenBoot emergency procedures for systems like the Sun Fire V490 server that accept USB keyboards.

### Stop-A Functionality

Stop-A (Abort) issues a break that drops the system into OpenBoot firmware control (indicated by the display of the `ok` prompt). The key sequence works the same on the Sun Fire V490 server as it does on older systems with non-USB keyboards, except that it does not work during the first few seconds after the machine is reset.

### Stop-D Functionality

The Stop-D (Diags) key sequence is not supported on systems with USB keyboards. However, the Stop-D functionality can be closely emulated by turning the system control switch to the Diagnostics position. For more information, see “System Control Switch” on page 15.

The RSC `bootmode diag` command also provides similar functionality. For more information, see the *Sun Remote System Control (RSC) 2.2 User's Guide*, which is included on the Sun Fire V490 Documentation CD.

## Stop-F Functionality

The Stop-F functionality is not available in systems with USB keyboards. However, the RSC `bootmode forth` command provides similar functionality. For more information, see the *Sun Remote System Control (RSC) 2.2 User's Guide*, which is included on the Sun Fire V490 Documentation CD.

## Stop-N Functionality

The Stop-N sequence is a method of bypassing problems typically encountered on systems with misconfigured OpenBoot configuration variables. On systems with older keyboards, you did this by pressing the Stop-N sequence while powering on the system.

On systems with USB keyboards, like the Sun Fire V490, the implementation involves waiting for the system to reach a particular state. For instructions, see “How to Implement Stop-N Functionality” on page 164.

The drawback of using Stop-N on a Sun Fire V490 system is that, if diagnostics are enabled, it can take some time for the system to reach the desired state. Fortunately, an alternative exists: Place the system control switch in the Diagnostics position.

Placing the system control switch in Diagnostics position will override OpenBoot configuration variable settings, allowing the system to recover to the `ok` prompt and letting you correct misconfigured settings.

Assuming you have access to RSC software, another possibility is to use the RSC `bootmode reset_nvram` command, which provides similar functionality. For more information, see the *Sun Remote System Control (RSC) 2.2 User's Guide*, which is included on the Sun Fire V490 Documentation CD.

---

## About Automatic System Recovery

The Sun Fire V490 system provides a feature called *automatic system recovery (ASR)*. To some, ASR implies an ability to shield the operating system in the event of a hardware failure, allowing the operating system to remain up and running. The implementation of ASR on the Sun Fire V490 server is different—it provides for automatic fault isolation and restoration of the operating system following non-fatal faults or failures of these hardware components:

- Processors
- Memory modules
- PCI buses and cards

- FC-AL subsystem
- Ethernet interface
- USB interface
- Serial interface

In the event of such a hardware failure, firmware-based diagnostic tests isolate the problem and mark the device (using the 1275 Client Interface, via the device tree) as either *failed* or *disabled*. The OpenBoot firmware then deconfigures the failed device and reboots the operating system. This all occurs automatically, as long as the Sun Fire V490 system is capable of functioning without the failed component.

Once restored, the operating system will not attempt to access any deconfigured device. This prevents a faulty hardware component from keeping the entire system down or causing the system to crash repeatedly.

As long as the failed component is electrically dormant (that is, it does not cause random bus errors or introduce noise into signal lines), the system reboots automatically and resumes operation. Be sure to contact a qualified service technician about replacing the failed component.

## Auto-Boot Options

The OpenBoot firmware provides an IDPROM-stored setting called `auto-boot?`, which controls whether the firmware will automatically boot the operating system after each reset. The default setting for Sun platforms is `true`.

If a system fails power-on diagnostics, then `auto-boot?` is ignored and the system does not start up unless an operator boots the system manually. This behavior obviously provides limited system availability. Therefore, the Sun Fire V490 OpenBoot firmware provides a second OpenBoot configuration variable switch called `auto-boot-on-error?`. This switch controls whether the system will attempt to boot when a subsystem failure is detected.

Both the `auto-boot?` and `auto-boot-on-error?` switches must be set to `true` (their default values) to enable an automatic boot following the firmware detection of a nonfatal subsystem failure.

```
ok setenv auto-boot? true
ok setenv auto-boot-on-error? true
```

The system will not attempt to boot if it is in service mode, or following any fatal nonrecoverable error. For examples of fatal nonrecoverable errors, see “Error Handling Summary” on page 57.

# Error Handling Summary

Error handling during the power-on sequence falls into one of three cases summarized in the following table.

Scenario	System Behavior	Notes
No errors are detected.	The system attempts to boot if <code>auto-boot?</code> is true.	By default, <code>auto-boot?</code> and <code>auto-boot-on-error?</code> are both true.
Nonfatal errors are detected.	The system attempts to boot if <code>auto-boot?</code> and <code>auto-boot-on-error?</code> are both true.	Nonfatal errors include: <ul style="list-style-type: none"><li>• FC-AL subsystem failure <sup>1</sup></li><li>• Ethernet interface failure</li><li>• USB interface failure</li><li>• Serial interface failure</li><li>• PCI card failure</li><li>• Processor failure <sup>2</sup></li><li>• Memory failure <sup>3</sup></li></ul>
Fatal nonrecoverable errors are detected.	The system will not boot regardless of OpenBoot configuration variable settings.	Fatal nonrecoverable errors include: <ul style="list-style-type: none"><li>• All processors failed</li><li>• All logical memory banks failed</li><li>• Flash RAM cyclical redundancy check (CRC) failure</li><li>• Critical FRU-ID EEPROM configuration data failure</li><li>• Critical application specific integrated circuit (ASIC) failure</li></ul>

1. A working alternate path to the boot disk is required. For more information, see “About Multipathing Software” on page 64.
2. A single processor failure causes the entire CPU/Memory module to be deconfigured. Reboot requires that another functional CPU/Memory module be present.
3. Since each physical DIMM belongs to two logical memory banks, the firmware deconfigures both memory banks associated with the affected DIMM. This leaves the CPU/Memory module operational, but with one of the processors having a reduced complement of memory.

---

**Note** – If POST or OpenBoot Diagnostics detects a nonfatal error associated with the normal boot device, the OpenBoot firmware automatically deconfigures the failed device and tries the next-in-line boot device, as specified by the `boot-device` configuration variable.

---

# Reset Scenarios

The system control switch position and three OpenBoot configuration variables, `service-mode?`, `diag-switch?`, and `diag-trigger`, control whether and how the system runs firmware diagnostics in response to system reset events.

When you set the system control switch to the Diagnostics position, the system is in service mode and runs tests at Sun-specified levels, disabling auto-booting and ignoring the settings of OpenBoot configuration variables.

Setting the `service-mode?` variable to `true` also puts the system in service mode, producing *exactly* the same results as setting the system control switch to the Diagnostics position.

When you set the system control switch to the Normal position, *and* when the OpenBoot `service-mode?` variable is set to `false` (its default value), the system is in normal mode. When the system is in this mode, you can control diagnostics and auto-boot behavior by setting OpenBoot configuration variables, principally `diag-switch?` and `diag-trigger`.

When `diag-switch?` is set to `false` (its default value), you can use `diag-trigger` to determine what kind of reset events trigger diagnostic tests. The following table describes the various settings (keywords) of the `diag-trigger` variable. You can use the first three of these keywords in any combination.

Keyword	Function
<code>power-on-reset</code> (default)	Reset caused by power-cycling the system.
<code>error-reset</code> (default)	Reset caused by certain hardware error events, such as a RED State Exception, Watchdog Reset, or Fatal Reset.
<code>user-reset</code>	Reset caused by operating system panics or by user-initiated commands from OpenBoot ( <code>reset-all</code> , <code>boot</code> ) or from Solaris OS ( <code>reboot</code> , <code>shutdown</code> , <code>init</code> ).
<code>all-resets</code>	Any kind of system reset.
<code>none</code>	Diagnostic tests are not executed.

See TABLE 6-2 for a fuller list of OpenBoot configuration variables affecting diagnostics and system behavior.

## Normal Mode and Service Mode Information

You will find a full description of normal and service modes, as well as detailed information about the OpenBoot configuration variables that affect ASR behavior, in *OpenBoot PROM Enhancements for Diagnostic Operation*, which is available on the Sun Fire V490 Documentation CD.

---

## About Manually Configuring Devices

This section explains the difference between deconfiguring a device and a slot, tells what happens if you try to deconfigure all of a system's processors, and also discusses how to obtain device paths.

### Deconfiguring Devices vs. Slots

For some devices, different things happen when you deconfigure a slot than when you deconfigure the device that resides within a slot.

If you deconfigure a PCI *device*, the device in question can still be probed by firmware and recognized by the operating system. Solaris OS "sees" such a device, reports it as *failed*, and refrains from using it.

If you deconfigure a PCI *slot*, firmware will not even probe the slot, and the operating system will not "know about" any devices that may be plugged in to the slot.

In both cases, the devices in question are rendered unusable. So why make the distinction? Occasionally, a device may fail in such a way that probing it disrupts the system. In cases such as these, deconfiguring the slot in which the device resides is more likely to contain the problem.

### Deconfiguring All System Processors

You can use the `asr-disable` command to deconfigure all system processors. Doing this will not crash the system. The OpenBoot system firmware, even though it reports all processors as deconfigured, in actuality keeps one processor functioning well enough to run the firmware.

# Device Paths

When manually deconfiguring and reconfiguring devices, you might need to determine the full physical paths to those devices. You can do this by typing:

```
ok show-devs
```

The `show-devs` command lists the system devices and displays the full path name of each device. An example of a path name for a Fast Ethernet PCI card is shown below:

```
/pci@8,700000/pci@2/SUNW,hme@0,1
```

You can display a list of current device aliases by typing:

```
ok devalias
```

You can also create your own device alias for a physical device by typing:

```
ok devalias alias_name physical_device_path
```

where *alias\_name* is the alias that you want to assign, and *physical\_device\_path* is the full physical device path for the device.

---

**Note** – If you manually deconfigure a device alias using `asr-disable`, and then assign a different alias to the device, the device will remain deconfigured even though the device alias has changed.

---

You can determine which devices are currently disabled by typing:

```
ok .asr
```

The related deconfiguration and reconfiguration procedures are covered in:

- “How to Deconfigure a Device Manually” on page 162
- “How to Reconfigure a Device Manually” on page 163

Device identifiers are listed in “Reference for Device Identifiers” on page 61.



---

# Reference for Device Identifiers

Refer to the following table when manually specifying which devices to deconfigure and reconfigure. The related procedures are covered in:

- “How to Deconfigure a Device Manually” on page 162
- “How to Reconfigure a Device Manually” on page 163

Device Identifiers	Devices
cmpx, where x is a number 0-3, or 16-19	Particular processors
cmpx-bank0, cmpx-bank1, cmpx-bank2, cmpx-bank3, where x is a number 0-3, or 16-19	Memory banks 0-3 for each processor
gptwo-slotA, gptwo-slotB, gptwo-slotC, gptwo-slotD	CPU/Memory board slots A-D
io-bridge8, io-bridge9	PCI bridge chips 0 and 1, respectively
ob-net0, ob-net1	On-board Ethernet controllers
ob-fcal	On-board FC-AL controller
pci-slot0, pci-slot1, ... pci-slot5	PCI slots 0-5

---

**Note** – The device identifiers above are not case-sensitive; you can type them as uppercase or lowercase characters.

---

You can use wild cards within device identifiers to reconfigure a range of devices, as shown in the following table.

Device Identifiers	Devices
*	All devices
cmp*	All processors
cmpx-bank*, where x is a number 0-3, or 16-19	All memory banks for each processor
gptwo-slot*	All CPU/Memory board slots
io-bridge*	All PCI bridge chips
pci*	All on-board PCI devices (on-board Ethernet, FC-AL) and all PCI slots
pci-slot*	All PCI slots

---

**Note** – You cannot *deconfigure* a range of devices. Wild cards are valid only for specifying a range of devices to *reconfigure*.

---



# System Administration Software

---

This chapter provides an introduction to system administration software tools supported on the Sun Fire V490 system.

The following information is covered in this chapter:

- “About System Administration Software” on page 63
- “About Multipathing Software” on page 64
- “About Volume Management Software” on page 65
- “About Sun Cluster Software” on page 69
- “About Communicating With the System” on page 69

---

## About System Administration Software

A number of software-based administration tools are available to help you configure your system for performance and availability, monitor and manage your system, and identify hardware problems. These administration tools include:

- Multipathing software
- Volume management software
- Sun Cluster software

The following table provides a summary of each tool with a pointer to additional information.

**TABLE 5-1** System Administration Tool Summary

Tool	Description	For More Information
Multipathing software	Multipathing software is used to define and control alternate (redundant) physical paths to I/O devices. If the active path to a device becomes unavailable, the software can automatically switch to an alternate path to maintain availability.	See “About Multipathing Software” on page 64.
Volume management software	Volume management applications, such as Solstice DiskSuite, provide easy-to-use online disk storage management for enterprise computing environments. Using advanced RAID technology, these products ensure high data availability, excellent I/O performance, and simplified administration.	See “About Volume Management Software” on page 65.
Sun Cluster software	Sun Cluster software enables you to interconnect multiple Sun servers so that they work together as a single, highly available and scalable system. Sun Cluster software delivers high availability—through automatic fault detection and recovery—and scalability, ensuring that mission-critical applications and services are always available when needed.	See “About Sun Cluster Software” on page 69.

## About Multipathing Software

Multipathing software lets you define and control redundant physical paths to I/O devices, such as storage devices and network interfaces. If the active path to a device becomes unavailable, the software can automatically switch to an alternate path to maintain availability. This capability is known as *automatic failover*. To take advantage of multipathing capabilities, you must configure the server with redundant hardware, such as redundant network interfaces or two FC-AL host bus adapters connected to the same dual-ported storage array.

For Sun Fire V490 systems, three different types of multipathing software are available:

- Solaris IP Network Multipathing software provides multipathing and load balancing capabilities for IP network interfaces.
- Sun StorEdge Traffic Manager software for the Solaris OS, which is part of the Sun SAN Foundation Suite, automates multipath I/O failover, failback, and SAN-wide load balancing.

- Multiplexed I/O (MPxIO) is a new architecture fully integrated within the Solaris OS (beginning with Solaris 8) that enables I/O devices to be accessed through multiple host controller interfaces from a single instance of the I/O device.

## For More Information

For information about setting up redundant hardware interfaces for storage devices or networks, see “About Redundant Network Interfaces” on page 48.

For instructions on how to configure and administer Solaris IP Network Multipathing, consult the *IP Network Multipathing Administration Guide* provided with your specific Solaris release.

For more information about Sun StorEdge Traffic Manager, see the *Sun Fire V490 Server Product Notes*.

For information about MPxIO, see “Multiplexed I/O (MPxIO)” on page 66 and refer to your Solaris OS documentation.

---

## About Volume Management Software

Sun Microsystems offers two different volume management applications for use on Sun Fire V490 systems:

- Sun StorEdge™ Traffic Manager
- Solstice DiskSuite™ software

Volume management software lets you create *disk volumes*. Volumes are logical disk devices comprising one or more physical disks or partitions from several different disks. Once you create a volume, the operating system uses and maintains the volume as if it were a single disk. By providing this logical volume management layer, the software overcomes the restrictions imposed by physical disk devices.

Sun’s volume management products also provide RAID data redundancy and performance features. RAID, which stands for *redundant array of independent disks*, is a technology that helps protect against disk and hardware failures. Through RAID technology, volume management software is able to provide high data availability, excellent I/O performance, and simplified administration.

Sun’s volume management applications offer the following features:

- Support for several types of RAID configurations, which provide varying degrees of availability, capacity, and performance
- Hot-spare facilities, which provide for automatic data recovery when disks fail

- Performance analysis tools, which enable you to monitor I/O performance and isolate bottlenecks
- A graphical user interface (GUI), which simplifies storage management
- Support for online resizing, which enables volumes and their file systems to grow and shrink online
- Online reconfiguration facilities, which let you change to a different RAID configuration or modify characteristics of an existing configuration

## Multiplexed I/O (MPxIO)

A newer alternative to dynamic multipathing (DMP) that is also supported by the Sun Fire V490 server is multiplexed I/O (MPxIO). Beginning with Solaris 8, MPxIO is fully integrated within the Solaris OS software's core I/O framework. MPxIO enables you more effectively to represent and manage devices that are accessible through multiple I/O controller interfaces within a single instance of the Solaris OS.

The MPxIO architecture:

- Helps protect against I/O outages due to I/O controller failures. Should one I/O controller fail, MPxIO automatically switches to an alternate controller.
- Increases I/O performance by load balancing across multiple I/O channels.

Both Sun StorEdge T3 and Sun StorEdge A5x00 storage arrays are supported by MPxIO on a Sun Fire V490 server. Supported I/O controllers are `usoc/fp` FC-AL disk controllers and `qlc/fp` FC-AL disk controllers.

## RAID Concepts

Solstice DiskSuite software supports RAID technology to optimize performance, availability, and user cost. RAID technology improves performance, reduces recovery time in the event of file system errors, and increases data availability even in the event of a disk failure. There are several levels of RAID configurations that provide varying degrees of data availability with corresponding trade-offs in performance and cost.

This section describes some of the most popular and useful of those configurations, including:

- Disk concatenation
- Disk mirroring (RAID 1)
- Disk striping (RAID 0)
- Disk striping with parity (RAID 5)
- Hot spares

## Disk Concatenation

Disk concatenation is a method for increasing logical volume size beyond the capacity of one disk drive by creating one large volume from two or more smaller drives. This lets you create arbitrarily large partitions.

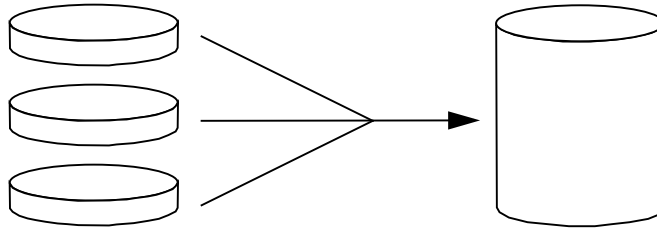

Using this method, the concatenated disks are filled with data sequentially, with the second disk being written to when no space remains on the first, the third when no room remains on the second, and so on.

## RAID 1: Disk Mirroring

Disk mirroring (RAID 1) is a technique that uses data redundancy—two complete copies of all data stored on two separate disks—to protect against loss of data due to disk failure. One logical volume is duplicated on two separate disks.

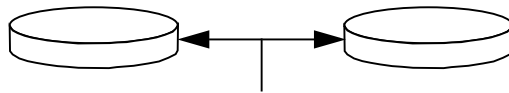

When the operating system needs to write to a mirrored volume, both disks are updated. The disks are maintained at all times with exactly the same information. When the operating system needs to read from the mirrored volume, it reads from whichever disk is more readily accessible at the moment, which can result in enhanced performance for read operations.

RAID 1 offers the highest level of data protection, but storage costs are high, and write performance is reduced since all data must be stored twice.

## RAID 0: Disk Striping

Disk striping (RAID 0) is a technique for increasing system throughput by using several disk drives in parallel. Whereas in non-striped disks the operating system writes a single block to a single disk, in a striped arrangement, each block is divided and portions of the data are written to different disks simultaneously.

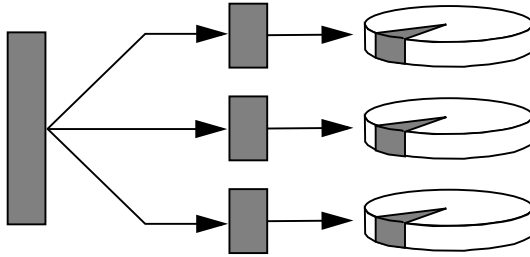

System performance using RAID 0 will be better than using RAID 1 or 5, but the possibility of data loss is greater because there is no way to retrieve or reconstruct data stored on a failed disk drive.

## RAID 5: Disk Striping With Parity

RAID 5 is an implementation of disk striping in which parity information is included with each disk write. The advantage of this technique is that if any one disk in a RAID 5 array fails, all the information on the failed drive can be reconstructed from the data and parity on the remaining disks.

System performance using RAID 5 will fall between that of RAID 0 and RAID 1; however, RAID 5 provides limited data redundancy. If more than one disk fails, all data is lost.

## Hot Spares (Hot Relocation)

In a *hot spares* arrangement, one or more disk drives are installed in the system but are unused during normal operation. Should one of the active drives fail, the data on the failed disk is automatically reconstructed and generated on a hot spare disk, enabling the entire data set to maintain its availability.

## For More Information

See the documentation supplied with Solstice DiskSuite software. For more information about MPxIO, see your Solaris system administration documentation.



---

# About Sun Cluster Software

Sun™ Cluster software lets you connect up to eight Sun servers in a cluster configuration. A *cluster* is a group of nodes that are interconnected to work as a single, highly available and scalable system. A *node* is a single instance of Solaris software—it may be running on a standalone server or on a domain within a standalone server. With Sun Cluster software, you can add or remove nodes while online, and mix and match servers to meet your specific needs.

Sun Cluster software delivers high availability through automatic fault detection and recovery, and scalability, ensuring that mission-critical applications and services are always available when needed.

With Sun Cluster software installed, other nodes in the cluster will automatically take over and assume the workload when a node goes down. It delivers predictability and fast recovery capabilities through features such as local application restart, individual application failover, and local network adapter failover. Sun Cluster software significantly reduces downtime and increases productivity by helping to ensure continuous service to all users.

The software lets you run both standard and parallel applications on the same cluster. It supports the dynamic addition or removal of nodes, and enables Sun servers and storage products to be clustered together in a variety of configurations. Existing resources are used more efficiently, resulting in additional cost savings.

Sun Cluster software allows nodes to be separated by up to 10 kilometers. This way, in the event of a disaster in one location, all mission-critical data and services remain available from the other unaffected locations.

## For More Information

See the documentation supplied with the Sun Cluster software.

---

# About Communicating With the System

To install your system software or to diagnose problems, you need some way to interact at a low level with the server. The *system console* is Sun's facility for doing this. You use the system console to view messages and issue commands. The system console is unique—there can be only one per system.

During initial installation of the Sun Fire V490 system and the Solaris OS software, you must use the built-in serial port (`ttya`) to access the system console. After installation, you can configure the system console to use different input and output devices. See TABLE 5-2 for a summary.

**TABLE 5-2** Ways of Communicating With the System

Devices Available for Accessing the System Console	During Installation	After Installation
An alphanumeric terminal attached to serial port A ( <code>ttya</code> ) (See “How to Set Up an Alphanumeric Terminal as the System Console” on page 133.)	✓	✓
A <code>tip</code> line attached to serial port A ( <code>ttya</code> ) (See “How to Access the System Console via <code>tip</code> Connection” on page 129.)	✓	✓
A local graphics terminal (frame buffer card, screen etc.) (See “How to Configure a Local Graphics Terminal as the System Console” on page 135.)		✓
The system controller (SC) (See “Sun Remote System Control Software” on page 22 and “How to Monitor the System Using the System Controller and RSC Software” on page 190.)		✓

## What the System Console Does

While the computer is starting up, the system console displays status and error messages generated by firmware-based tests. After those tests have been run, you can enter special commands that affect the firmware and alter the system’s behavior. For more information about tests that run during the boot process, see “About Diagnostics and the Boot Process” on page 77.

Once the Solaris OS software is booted, the system console displays UNIX system messages and accepts UNIX commands.

## Using the System Console

To use the system console, you need some means of getting data into and out of the server, which means attaching some kind of hardware to the server. Initially, you may have to configure that hardware, and load and configure appropriate software as well.

Instructions for attaching and configuring hardware to access the system console are given in Chapter 7. The following subsections, “Default System Console Configuration” on page 71 and “Alternative System Console Configuration” on page 71, provide background information and references to instructions appropriate for the particular device you choose to access the system console.

## Default System Console Configuration

On Sun Fire V490 servers, the system console comes preconfigured to allow input and output only by means of an alphanumeric terminal or `tip` line attached to the system’s built-in serial port, `ttya`. This provides for secure access at the installation site.

Using a `tip` line may be preferable to connecting an alphanumeric terminal, since `tip` lets you use windowing and operating system features.

For instructions on setting up an alphanumeric terminal as the system console, see “How to Set Up an Alphanumeric Terminal as the System Console” on page 133.

For instructions on accessing the system console via a `tip` line, see “How to Access the System Console via `tip` Connection” on page 129.

## Alternative System Console Configuration

*After initial system installation*, you can configure the system console to communicate via alternative devices, including a local graphics terminal, or the system controller.

To use a device other than the built-in serial port as the system console, you need to reset certain of the system’s OpenBoot configuration variables and properly install and configure the device in question.

### *Using a Local Graphics Terminal as the System Console*

The Sun Fire V490 server is shipped without a mouse, keyboard, monitor, or frame buffer for the display of graphics. To install a local graphics terminal on the server, you must install a graphics frame buffer card into a PCI slot, and attach a monitor, mouse, and keyboard to the appropriate back panel ports.

After starting the system you may need to install the correct software driver for the card you have installed. For detailed hardware instructions, see “How to Configure a Local Graphics Terminal as the System Console” on page 135.

---

**Note** – Power-on self-test (POST) diagnostics cannot display status and error messages to a local graphics terminal. If you configure a local graphics terminal as the system console, POST messages will be redirected to the serial port (`ttya`), but other system console messages will appear on the graphics terminal.

---

### *Using the System Controller as the System Console*

Once the system controller (SC) is set up and its software configured, you can use the SC and RSC software as the system console. This may be a useful option if you need to access the system console from remote locations. The system controller also provides system console access from workstations running various operating environments.

For instructions on setting up the system controller as the system console, see “How to Redirect the System Console to the System Controller” on page 159.

For instructions on configuring and using RSC software, see the *Sun Remote System Controller (RSC) User's Guide*.

# Diagnostic Tools

---

The Sun Fire V490 server and its accompanying software contain many tools and features that help you:

- *Isolate* problems when there is a failure of a field-replaceable component
- *Monitor* the status of a functioning system
- *Exercise* the system to disclose an intermittent or incipient problem

This chapter introduces the tools that let you accomplish these goals, and helps you to understand how the various tools fit together.

Topics in this chapter include:

- “About the Diagnostic Tools” on page 73
- “About Diagnostics and the Boot Process” on page 77
- “About Isolating Faults in the System” on page 100
- “About Monitoring the System” on page 101
- “About Exercising the System” on page 105
- “Reference for OpenBoot Diagnostics Test Descriptions” on page 109
- “Reference for Decoding I2C Diagnostic Test Messages” on page 111
- “Reference for Terms in Diagnostic Output” on page 114

*If you only want instructions for using diagnostic tools, skip this chapter and turn to Part Three of this manual. There, you can find chapters that tell you how to isolate failed parts (Chapter 10), monitor the system (Chapter 11), and exercise the system (Chapter 12).*

---

## About the Diagnostic Tools

Sun provides a wide spectrum of diagnostic tools for use with the Sun Fire V490 server. These tools range from the formal—like Sun’s comprehensive Validation Test Suite (SunVTS), to the informal—like log files that may contain clues helpful in narrowing down the possible sources of a problem.

The diagnostic tool spectrum also ranges from standalone software packages, to firmware-based power-on self-tests (POST), to hardware LEDs that tell you when the power supplies are operating.

Some diagnostic tools enable you to examine many computers from a single console, others do not. Some diagnostic tools stress the system by running tests in parallel, while other tools run sequential tests, enabling the machine to continue its normal functions. Some diagnostic tools function even when power is absent or the machine is out of commission, while others require the operating system to be up and running.

The full palette of tools discussed in this manual is summarized in TABLE 6-1.

**TABLE 6-1** Summary of Diagnostic Tools

<b>Diagnostic Tool</b>	<b>Type</b>	<b>What It Does</b>	<b>Accessibility and Availability</b>	<b>Remote Capability</b>
LEDs	Hardware	Indicate status of overall system and particular components	Accessed from system chassis. Available anytime power is available	Local, but can be viewed via SC
POST	Firmware	Tests core components of system	Runs automatically on startup. Available when the operating system is not running	Local, but can be viewed via SC
OpenBoot Diagnostics	Firmware	Tests system components, focusing on peripherals and I/O devices	Runs automatically or interactively. Available when the operating system is not running	Local, but can be viewed via SC
OpenBoot commands	Firmware	Display various kinds of system information	Available whether or not the operating system is running	Local, but can be accessed via SC
Solaris commands	Software	Display various kinds of system information	Requires operating system	Local, but can be accessed via SC
SunVTS	Software	Exercises and stresses the system, running tests in parallel	Requires operating system. Optional package may need to be installed	View and control over network

**TABLE 6-1** Summary of Diagnostic Tools (Continued)

<b>Diagnostic Tool</b>	<b>Type</b>	<b>What It Does</b>	<b>Accessibility and Availability</b>	<b>Remote Capability</b>
SC card and RSC software	Hardware and software	Monitors environmental conditions, performs basic fault isolation, and provides remote console access	Can function on standby power and without operating system	Designed for remote access
Sun Management Center	Software	Monitors both hardware environmental conditions and software performance of multiple machines. Generates alerts for various conditions	Requires operating system to be running on both monitored and master servers. Requires a dedicated database on the master server	Designed for remote access
Hardware Diagnostic Suite	Software	Exercises an operational system by running sequential tests. Also reports failed FRUs	Separately purchased optional add-on to Sun Management Center. Requires operating system and Sun Management Center	Designed for remote access

Why are there so many different diagnostic tools?

There are a number of reasons for the lack of a single all-in-one diagnostic test, starting with the complexity of the server systems.

Consider the data bus built into every Sun Fire V490 server. This bus features a five-way switch called a CDX that interconnects all processors and high-speed I/O interfaces (see FIGURE 6-1). This data switch enables multiple simultaneous transfers over its private data paths. This sophisticated high-speed interconnect represents just one facet of the Sun Fire V490 server's advanced architecture.

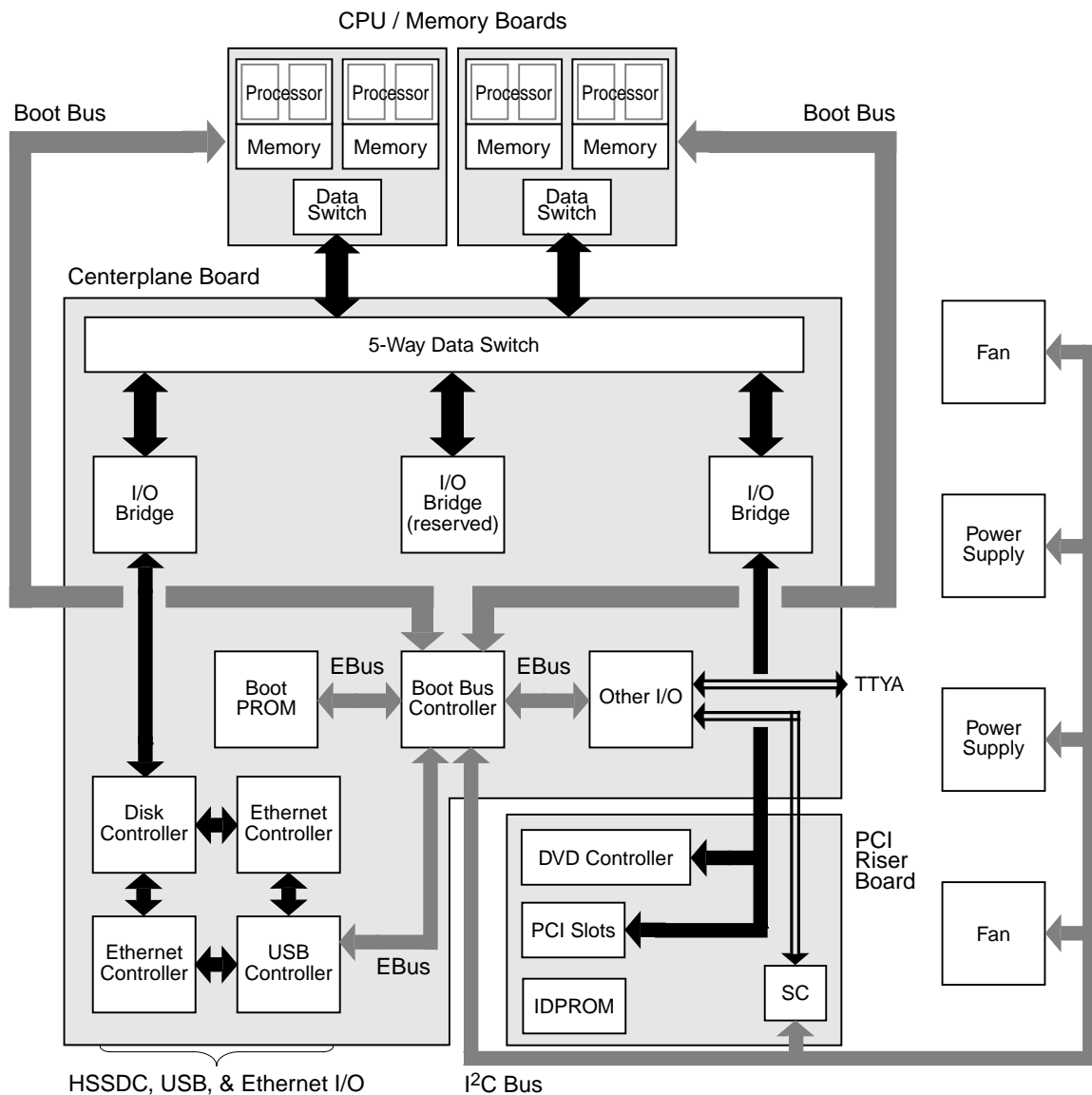

FIGURE 6-1 Simplified Schematic View of a Sun Fire V490 System

Consider also that some diagnostics must function even when the system fails to start. Any diagnostic capable of isolating problems when the system fails to start up must be independent of the operating system. But any diagnostic that is independent of the operating system will also be unable to make use of the operating system's considerable resources for getting at the more complex causes of failures.



Another complicating factor is that different installations have different diagnostic requirements. You may be administering a single computer or a whole data center full of equipment racks. Alternatively, your systems may be deployed remotely—perhaps in areas that are physically inaccessible.

Finally, consider the different tasks you expect to perform with your diagnostic tools:

- Isolating faults to a specific replaceable hardware component
- Exercising the system to disclose more subtle problems that may or may not be hardware related
- Monitoring the system to catch problems before they become serious enough to cause unplanned downtime

Not every diagnostic tool can be optimized for all these varied tasks.

Instead of one unified diagnostic tool, Sun provides a palette of tools each of which has its own specific strengths and applications. To appreciate how each tool fits into the larger picture, it is necessary to have some understanding of what happens when the server starts up, during the so-called *boot process*.

---

## About Diagnostics and the Boot Process

You have probably had the experience of powering on a Sun system and watching as it goes through its boot process. Perhaps you have watched as your console displays messages that look like the following:

```
0:0>
0:0>@(#) Sun Fire[TM] V480/V490 POST 4.15 2004/04/09 16:27
0:0>Copyright © 2004 Sun Microsystems, Inc. All rights reserved
      SUN PROPRIETARY/CONFIDENTIAL.
      Use is subject to license terms.
0:0>Jump from OBP->POST.
0:0>Diag level set to MIN.
0:0>Verbosity level set to NORMAL.
0:0>
0:0>Start selftest...
0:0>CPUs present in system: 0:0 1:0 2:0 3:0
0:0>Test CPU(s)...Done
```

It turns out these messages are not quite so inscrutable once you understand the boot process. These kinds of messages are discussed later.

It is important to understand that almost all of the firmware-based diagnostics can be disabled so as to minimize the amount of time it takes the server to start up. In the following discussion, assume that the system is configured to run its firmware-based tests.

## Prologue: System Controller Boot

As soon as you plug in the Sun Fire V490 server to an electrical outlet, and before you turn on power to the server, the *system controller (SC)* inside the server begins its self-diagnostic and boot cycle. During this time, the locator LED blinks. Running off standby power, the system controller card begins functioning before the server itself comes up.

The system controller provides access to a number of control and monitoring functions through Remote System Control (RSC) software. For more information about RSC software, see “Sun Remote System Control Software” on page 22.

## Stage One: OpenBoot Firmware and POST

Every Sun Fire V490 server includes a chip holding about 2 Mbytes of firmware-based code. This chip is called the *Boot PROM*. After you turn on system power, the first thing the system does is execute code that resides in the Boot PROM.

This code, which is referred to as the *OpenBoot firmware*, is a small-scale operating system unto itself. However, unlike a traditional operating system that can run multiple applications for multiple simultaneous users, OpenBoot firmware runs in single-user mode and is designed solely to test, configure, and boot the system, thereby ensuring that the hardware is sufficiently “healthy” to run its normal operating system software.

When system power is turned on, the OpenBoot firmware begins running directly out of the Boot PROM, since at this stage system memory has not been verified to work properly.

Soon after power is turned on, the system hardware determines that at least one processor is powered on, and is submitting a bus access request, which indicates that the processor in question is at least partly functional. This becomes the master processor, and is responsible for executing OpenBoot firmware instructions.

The OpenBoot firmware’s first actions are to check whether to run the *power-on self-test (POST)* diagnostics and other tests. The POST diagnostics constitute a separate chunk of code stored in a different area of the Boot PROM (see FIGURE 6-2).

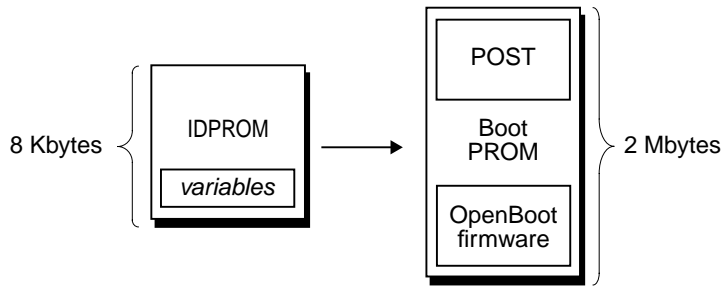

**FIGURE 6-2** Boot PROM and IDPROM

The extent of these power-on self-tests, and whether they are performed at all, is controlled by configuration variables stored in a separate firmware memory device called the IDPROM. These *OpenBoot configuration variables* are discussed in “Controlling POST Diagnostics” on page 82.

As soon as POST diagnostics can verify that some subset of system memory is functional, tests are loaded into system memory.

## The Purpose of POST Diagnostics

The POST diagnostics verify the core functionality of the system. A successful execution of the POST diagnostics does not ensure that there is nothing wrong with the server, but it does ensure that the server can proceed to the next stage of the boot process.

For a Sun Fire V490 server, this means:

- At least one of the processors is working.
- At least a subset of system memory is functional.
- Cache memory is functional.
- Data switches located both on the CPU/Memory boards and the centerplane are functioning.
- Input/output bridges located on the centerplane are functioning.
- The PCI bus is intact—that is, there are no electrical shorts.

It is possible for a system to pass all POST diagnostics and still be unable to boot the operating system. However, you can run POST diagnostics even when a system fails to boot, and these tests are likely to disclose the source of most hardware problems.

POST generally reports errors that are persistent in nature. To catch intermittent problems, consider running a system exercising tool. See “About Exercising the System” on page 105.

## What POST Diagnostics Do

Each POST diagnostic is a low-level test designed to pinpoint faults in a specific hardware component. For example, individual memory tests called *address bitwalk* and *data bitwalk* ensure that binary 0s and 1s can be written on each address and data line. During such a test, the POST may display output similar to this:

```
1:0>Data Bitwalk on Slave 3
1:0>  Test Bank 0.
```

In this example, processor 1 is the master processor, as indicated by the prompt 1:0>, and it is about to test the memory associated with processor 3, as indicated by the message “Slave 3.”

---

**Note** – The x:y numbering system identifies processors that have multiple cores.

---

The failure of such a test reveals precise information about particular integrated circuits, the memory registers inside them, or the data paths connecting them:

```
1:0>ERROR: TEST = Data Bitwalk on Slave 3
1:0>H/W under test = CPU3 Memory
1:0>MSG = ERROR:miscompare on mem test!
        Address: 00000030.001b0038
        Expected: 00000000.00100000
        Observed: 00000000.00000000
```

## What POST Error Messages Tell You

When a specific power-on self-test discloses an error, it reports different kinds of information about the error:

- The specific test that failed
- The specific circuit or subcomponent that is most likely at fault
- The field-replaceable units (FRUs) most likely to require replacement, in order of likelihood

Here is an excerpt of POST output showing another error message.

```
0:0>Schizo unit 1 PCI DMA C test
0:0> FAILED
0:0>ERROR: TEST = Schizo unit 1 PCI DMA C test
0:0>H/W under test = Motherboard/Centerplane Schizo 1, I/O Board, CPU ←
0:0>MSG =
0:0> Schizo Error - 16bit Data miss compare
0:0> address 0000060300012800
0:0> expected 0001020304050607
0:0> observed 0000000000000000
0:0>END_ERROR
```

CODE EXAMPLE 6-1 POST Error Message

### Identifying FRUs

An important feature of POST error messages is the `H/W under test` line. (See the arrow in CODE EXAMPLE 6-1.)

The `H/W under test` line indicates which FRU or FRUs may be responsible for the error. Note that in CODE EXAMPLE 6-1, three different FRUs are indicated. Using TABLE 6-13 to decode some of the terms, you can see that this POST error was most likely caused by a bad system interconnect circuit (Schizo) on the centerplane. However, the error message also indicates that the PCI riser board (I/O board) may be at fault. In the least likely case, the error might stem from the master processor, in this case processor 0.

### Why a POST Error May Implicate Multiple FRUs

Because each test operates at such a low level, the POST diagnostics are often more definite in reporting the minute details of the error, like the numerical values of expected and observed results, than they are about reporting which FRU is responsible. If this seems counter-intuitive, consider the block diagram of one data path within a Sun Fire V490 server, shown in FIGURE 6-3.

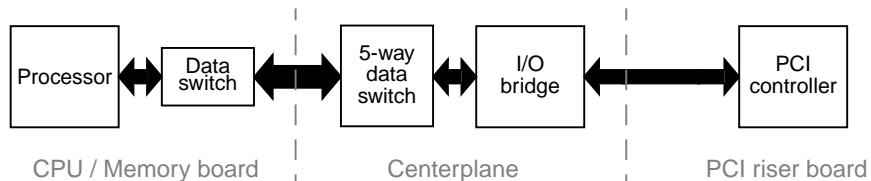

FIGURE 6-3 POST Diagnostic Running Across FRUs

The dashed lines in FIGURE 6-3 represent boundaries between FRUs. Suppose a POST diagnostic is running in the processor in the left part of the diagram. This diagnostic attempts to initiate a built-in self-test in a PCI device located in the right side of the diagram.

If this built-in self-test fails, there could be a fault in the PCI controller, or, less likely, in one of the data paths or components leading to that PCI controller. The POST diagnostic can tell you only that the test failed, but not *why*. So, though the POST may present very precise data about the nature of the test failure, any of three different FRUs could be implicated.

## Controlling POST Diagnostics

You control POST diagnostics (and other aspects of the boot process) by setting OpenBoot configuration variables in the IDPROM. Changes to OpenBoot configuration variables generally take effect only after the machine is restarted. These variables affect OpenBoot Diagnostics tests as well as POST diagnostics.

TABLE 6-2 lists the most important and useful of these variables. You can find more extensive lists and descriptions in *OpenBoot PROM Enhancements for Diagnostic Operation* and *OpenBoot 4.x Command Reference Manual*. The former is included on the Sun Fire V490 Documentation CD. The latter is included with the Solaris Software Supplement CD that ships with Solaris software.

You can find instructions for changing OpenBoot configuration variables in “How to View and Set OpenBoot Configuration Variables” on page 180.

**TABLE 6-2** OpenBoot Configuration Variables

OpenBoot Configuration Variable	Description and Keywords
auto-boot	Determines whether the operating system automatically starts up. Default is <code>true</code> . <ul style="list-style-type: none"> <li>• <code>true</code>—Operating system automatically starts once firmware tests finish.</li> <li>• <code>false</code>—System remains at <code>ok</code> prompt until you type <code>boot</code>.</li> </ul>
auto-boot-on-error?	Determines whether the system attempts to boot after a nonfatal error. Default is <code>true</code> . <ul style="list-style-type: none"> <li>• <code>true</code>—System automatically boots after a nonfatal error if the variable <code>auto-boot?</code> is also set to <code>true</code>.</li> <li>• <code>false</code>—System remains at the <code>ok</code> prompt.</li> </ul>
diag-level	Determines the level or type of diagnostics executed. Default is <code>max</code> . <ul style="list-style-type: none"> <li>• <code>off</code>—No testing.</li> <li>• <code>min</code>—Only basic tests are run.</li> <li>• <code>max</code>—More extensive tests may be run, depending on the device.</li> </ul>

TABLE 6-2 OpenBoot Configuration Variables (Continued)

OpenBoot Configuration Variable	Description and Keywords
diag-out-console	<p>Redirects diagnostic and console messages to the system controller. Default is <code>false</code>.</p> <ul style="list-style-type: none"> <li>• <code>true</code>—Display diagnostic messages via the SC console.</li> <li>• <code>false</code>—Display diagnostic messages via the serial port <code>ttya</code> or a graphics terminal.</li> </ul>
diag-script	<p>Determines which devices are tested by OpenBoot Diagnostics. Default is <code>normal</code>.</p> <ul style="list-style-type: none"> <li>• <code>none</code>—No devices are tested.</li> <li>• <code>normal</code>—On-board (centerplane-based) devices that have self-tests are tested.</li> <li>• <code>all</code>—All devices that have self-tests are tested.</li> </ul>
diag-switch?	<p>Controls diagnostic execution in normal mode. Default is <code>false</code>.</p> <ul style="list-style-type: none"> <li>• <code>true</code>—Diagnostics are <i>only</i> executed on power-on reset events, but the level of test coverage, verbosity, and output is determined by user-defined settings.</li> <li>• <code>false</code>—Diagnostics are executed upon next system reset, but only for those class of reset events specified by the OpenBoot configuration variable <code>diag-trigger</code>. The level of test coverage, verbosity, and output is determined by user-defined settings.</li> </ul> <p><b>Note:</b> The above behaviors only apply to server machines like the Sun Fire V490 server. Workstations behave differently. For details, see <i>OpenBoot PROM Enhancements for Diagnostic Operation</i>.</p>

TABLE 6-2 OpenBoot Configuration Variables (Continued)

OpenBoot Configuration Variable	Description and Keywords
diag-trigger	<p>Specifies the class of reset event that causes diagnostic tests to run. This variable can accept single keywords as well as combinations of the first three keywords separated by spaces. For details, see “How to View and Set OpenBoot Configuration Variables” on page 180. Default is <code>power-on-reset</code> and <code>error-reset</code>.</p> <ul style="list-style-type: none"> <li>• <code>error-reset</code>—Reset that is caused by certain hardware error events such as RED State Exception Reset, Watchdog Reset, Software-Instruction Reset, or Hardware Fatal Reset.</li> <li>• <code>power-on-reset</code>—Reset that is caused by power cycling the system.</li> <li>• <code>user-reset</code>—Reset that is initiated by an operating system panic or by user-initiated commands from OpenBoot (<code>reset-all</code> or <code>boot</code>) or from Solaris (<code>reboot</code>, <code>shutdown</code>, or <code>init</code>).</li> <li>• <code>all-resets</code>—Any kind of system reset.</li> <li>• <code>none</code>—No power-on self-tests or OpenBoot Diagnostics tests run.</li> </ul>
input-device	<p>Selects where console input is taken from. Default is <code>keyboard</code>.</p> <ul style="list-style-type: none"> <li>• <code>ttya</code>—From built-in serial port.</li> <li>• <code>keyboard</code>—From attached keyboard that is part of a graphics terminal.</li> <li>• <code>rsc-console</code>—From the system controller.</li> </ul> <p><b>Note:</b> Should the specified input device be unavailable, the system automatically reverts to <code>ttya</code>.</p>
output-device	<p>Selects where diagnostic and other console output is displayed. Default is <code>screen</code>.</p> <ul style="list-style-type: none"> <li>• <code>ttya</code>—To built-in serial port.</li> <li>• <code>screen</code>—To attached screen that is part of a graphics terminal.</li> <li>• <code>rsc-console</code>—To the system controller.</li> </ul> <p><b>Note:</b> POST messages cannot be displayed on a graphics terminal. They are sent to <code>ttya</code> even when <code>output-device</code> is set to <code>screen</code>. Should the specified output device be unavailable, the system automatically reverts to <code>ttya</code>.</p>
service-mode?	<p>Controls whether the system is in service mode. Default is <code>false</code>.</p> <ul style="list-style-type: none"> <li>• <code>true</code>—Service mode. Diagnostics are executed at Sun-specified levels, overriding but preserving user settings.</li> <li>• <code>false</code>—Normal mode, unless overridden by the system control switch. Diagnostics execution depends entirely on the settings of <code>diag-switch?</code> and other user-defined OpenBoot configuration variables.</li> </ul> <p><b>Note:</b> If the system control switch is in Diagnostics position, the system will boot in service mode even if the <code>service-mode?</code> variable is <code>false</code>.</p>



## Stage Two: OpenBoot Diagnostics Tests

Once POST diagnostics have finished running, POST reports back to the OpenBoot firmware the status of each test it has run. Control then reverts back to the OpenBoot firmware code.

OpenBoot firmware code compiles a hierarchical “census” of all devices in the system. This census is called a *device tree*. Though different for every system configuration, the device tree generally includes both built-in system components and optional PCI bus devices.

Following the successful execution of POST diagnostics, the OpenBoot firmware proceeds to run OpenBoot Diagnostics tests. Like the POST diagnostics, OpenBoot Diagnostics code is firmware-based and resides in the Boot PROM.

### What Are OpenBoot Diagnostics Tests For?

OpenBoot Diagnostics tests focus on system I/O and peripheral devices. Any device in the device tree, regardless of manufacturer, that includes an IEEE 1275-compatible self-test is included in the suite of OpenBoot Diagnostics tests. On a Sun Fire V490 server, OpenBoot Diagnostics test the following system components:

- I/O interfaces; including USB and serial ports
- System controller
- Keyboard, mouse, and video (when present)
- On-board boot devices (Ethernet, disk controller)
- Any PCI option card with an IEEE 1275-compatible built-in self-test

By default, the OpenBoot Diagnostics tests run automatically via a script when you start up the system. However, you can also run OpenBoot Diagnostics tests manually, as explained in the next section.

### Controlling OpenBoot Diagnostics Tests

When you restart the system, you can run OpenBoot Diagnostics tests either interactively from a test menu, or by entering commands directly from the `ok` prompt.

Most of the same OpenBoot configuration variables you use to control POST (see TABLE 6-2) also affect OpenBoot Diagnostics tests. Notably, you can determine OpenBoot Diagnostics testing level—or suppress testing entirely—by appropriately setting the `diag-level` variable.

In addition, the OpenBoot Diagnostics tests use a special variable called `test-args` that enables you to customize how the tests operate. By default, `test-args` is set to contain an empty string. However, you can set `test-args` to one or more of the reserved keywords, each of which has a different effect on OpenBoot Diagnostics tests. TABLE 6-3 lists the available keywords.

**TABLE 6-3** Keywords for the `test-args` OpenBoot Configuration Variable

Keyword	What It Does
<code>bist</code>	Invokes built-in self-test (BIST) on external and peripheral devices
<code>debug</code>	Displays all debug messages
<code>iopath</code>	Verifies bus/interconnect integrity
<code>loopback</code>	Exercises external loopback path for the device
<code>media</code>	Verifies external and peripheral device media accessibility
<code>restore</code>	Attempts to restore original state of the device if the previous execution of the test failed
<code>silent</code>	Displays only errors rather than the status of each test
<code>subtests</code>	Displays main test and each subtest that is called
<code>verbose</code>	Displays detailed messages of status of all tests
<code>callers=N</code>	Displays backtrace of <i>N</i> callers when an error occurs <ul style="list-style-type: none"> <li>• <code>callers=0</code>—Displays backtrace of all callers before the error</li> </ul>
<code>errors=N</code>	Continues executing the test until <i>N</i> errors are encountered <ul style="list-style-type: none"> <li>• <code>errors=0</code>—Displays all error reports without terminating testing</li> </ul>

If you want to make multiple customizations to the OpenBoot Diagnostics testing, you can set `test-args` to a comma-separated list of keywords, as in this example:

```
ok setenv test-args debug,loopback,media
```

### *From the OpenBoot Diagnostics Test Menu*

It is easiest to run OpenBoot Diagnostics tests interactively from a menu. You access the menu by typing `obdiag` at the `ok` prompt. See “How to Isolate Faults Using Interactive OpenBoot Diagnostics Tests” on page 177 for full instructions.

The `obdiag>` prompt and the OpenBoot Diagnostics interactive menu (FIGURE 6-4) appear. For a brief explanation of each OpenBoot Diagnostics test, see TABLE 6-10 in “Reference for OpenBoot Diagnostics Test Descriptions” on page 109.

o b d i a g		
1 SUNW,qlc@2	2 bbc@1,0	3 ebus@1
4 flashprom@0,0	5 i2c@1,2e	6 i2c@1,30
7 ide@6	8 network@1	9 network@2
10 pmc@1,300700	11 rsc-control@1,3062f8	12 rtc@1,300070
13 serial@1,400000	14 usb@1,3	
Commands: test test-all except help what setenv set-default exit		
diag-passes=1 diag-level=off test-args=subtests		

**FIGURE 6-4** OpenBoot Diagnostics Interactive Test Menu

### *Interactive OpenBoot Diagnostics Commands*

You run individual OpenBoot Diagnostics tests from the `obdiag>` prompt by typing:

```
obdiag> test n
```

where *n* represents the number associated with a particular menu item.

There are several other commands available to you from the `obdiag>` prompt. For descriptions of these commands, see TABLE 6-11 in “Reference for OpenBoot Diagnostics Test Descriptions” on page 109.

You can obtain a summary of this same information by typing `help` at the `obdiag>` prompt.

### *From the ok Prompt: The test and test-all Commands*

You can also run OpenBoot Diagnostics tests directly from the `ok` prompt. To do this, type the `test` command, followed by the full hardware path of the device (or set of devices) to be tested. For example:

```
ok test /pci@x,y/SUNW,qlc@2
```

---

**Note** – Knowing how to construct an appropriate hardware device path requires precise knowledge of the hardware architecture of the Sun Fire V490 system.

---

To customize an individual test, you can use `test-args` as follows:

```
ok test /usb@1,3:test-args={verbose,debug}
```

This affects only the current test without changing the value of the `test-args` OpenBoot configuration variable.

You can test all the devices in the device tree with the `test-all` command:

```
ok test-all
```

If you specify a path argument to `test-all`, then only the specified device and its children are tested. The following example shows the command to test the USB bus and all connected devices with self-tests:

```
ok test-all /pci@9,700000/usb@1,3
```

## What OpenBoot Diagnostics Error Messages Tell You

OpenBoot Diagnostics error results are reported in a tabular format that contains a short summary of the problem, the hardware device affected, the subtest that failed, and other diagnostic information. CODE EXAMPLE 6-2 displays a sample OpenBoot Diagnostics error message.

```
Testing /pci@9,700000/ebus@1/rsc-control@1,3062f8
```

```
ERROR   : SC card is not present in system, or SC card is broken.  
DEVICE  : /pci@9,700000/ebus@1/rsc-control@1,3062f8  
SUBTEST : selftest  
CALLERS : main  
MACHINE : Sun Fire V490  
SERIAL#  : 705459  
DATE     : 11/28/2001 14:46:21 GMT  
CONTROLS: diag-level=min test-args=media,verbose,subtests
```

```
Error: /pci@9,700000/ebus@1/rsc-control@1,3062f8 selftest failed, return code = 1  
Selftest at /pci@9,700000/ebus@1/rsc-control@1,3062f8 (errors=1) ..... failed  
Pass:1 (of 1) Errors:1 (of 1) Tests Failed:1 Elapsed Time: 0:0:0:0
```

#### CODE EXAMPLE 6-2 OpenBoot Diagnostics Error Message

## I<sup>2</sup>C Bus Device Tests

The `i2c@1,2e` and `i2c@1,30` OpenBoot Diagnostics tests examine and report on environmental monitoring and control devices connected to the Sun Fire V490 server's Inter-IC (I<sup>2</sup>C) bus.

Error and status messages from the `i2c@1,2e` and `i2c@1,30` OpenBoot Diagnostics tests include the hardware addresses of I<sup>2</sup>C bus devices:

```
Testing /pci@9,700000/ebus@1/i2c@1,2e/fru@2,a8
```

The I<sup>2</sup>C device address is given at the very end of the hardware path. In this example, the address is `2,a8`, which indicates a device located at hexadecimal address A8 on segment 2 of the I<sup>2</sup>C bus.

To decode this device address, see “Reference for Decoding I2C Diagnostic Test Messages” on page 111. Using TABLE 6-12, you can see that `fru@2,a8` corresponds to an I<sup>2</sup>C device on DIMM 4 on processor 2. If the `i2c@1,2e` test were to report an error against `fru@2,a8`, you would need to replace this memory module.

## Other OpenBoot Commands

Beyond the formal firmware-based diagnostic tools, there are a few commands you can invoke from the `ok` prompt. These OpenBoot commands display information that can help you assess the condition of a Sun Fire V490 server. These include the following commands:

- `.env` command
- `printenv` command
- `probe-scsi` and `probe-scsi-all` commands
- `probe-ide` command
- `show-devs` command

This section describes the information these commands give you. For instructions on using these commands, turn to “How to Use OpenBoot Information Commands” on page 198, or look up the appropriate man page.

### `.env` *Command*

The `.env` command displays the current environmental status, including fan speeds; and voltages, currents, and temperatures measured at various system locations. For more information, see “About OpenBoot Environmental Monitoring” on page 52, and “How to Obtain OpenBoot Environmental Status Information” on page 155.

### `printenv` *Command*

The `printenv` command displays the OpenBoot configuration variables. The display includes the current values for these variables as well as the default values. For details, see “How to View and Set OpenBoot Configuration Variables” on page 180.

For more information about `printenv`, see the `printenv` man page. For a list of some important OpenBoot configuration variables, see TABLE 6-2.

### `probe-scsi` *and* `probe-scsi-all` *Commands*

The `probe-scsi` and `probe-scsi-all` commands check the presence of SCSI or FC-AL devices and verify that the bus itself is operating properly.



---

**Caution** – If you used the `halt` command or the Stop-A key sequence to reach the `ok` prompt, then issuing the `probe-scsi` or `probe-scsi-all` command can hang the system.

---

The `probe-scsi` command communicates with all SCSI and FC-AL devices connected to on-board SCSI and FC-AL controllers. The `probe-scsi-all` command additionally accesses devices connected to any host adapters installed in PCI slots.

For any SCSI or FC-AL device that is connected and active, the `probe-scsi` and `probe-scsi-all` commands display its loop ID, host adapter, logical unit number, unique World Wide Name (WWN), and a device description that includes type and manufacturer.

The following is sample output from the `probe-scsi` command.

```
ok probe-scsi
LiD HA LUN --- Port WWN --- ----- Disk description -----
 0  0  0  2100002037cdaaca SEAGATE ST336704FSUN36G 0726
 1  1  0  2100002037a9b64e SEAGATE ST336704FSUN36G 0726
```

**CODE EXAMPLE 6-3** `probe-scsi` Command Output

The following is sample output from the `probe-scsi-all` command.

```
ok probe-scsi-all
/pci@9,600000/SUNW,qlc@2
LiD HA LUN --- Port WWN --- ----- Disk description -----
 0  0  0  2100002037cdaaca SEAGATE ST336704FSUN36G 0726
 1  1  0  2100002037a9b64e SEAGATE ST336704FSUN36G 0726

/pci@8,600000/scsi@1,1
Target 4
  Unit 0   Disk      SEAGATE ST32550W SUN2.1G0418

/pci@8,600000/scsi@1

/pci@8,600000/pci@2/SUNW,qlc@5

/pci@8,600000/pci@2/SUNW,qlc@4
LiD HA LUN --- Port WWN --- ----- Disk description -----
 0  0  0  2200002037cdaaca SEAGATE ST336704FSUN36G 0726
 1  1  0  2200002037a9b64e SEAGATE ST336704FSUN36G 0726
```

**CODE EXAMPLE 6-4** `probe-scsi-all` Command Output

Note that the `probe-scsi-all` command lists dual-ported devices twice. This is because these FC-AL devices (see the `qlc@2` entry in CODE EXAMPLE 6-4) can be accessed through two separate controllers: the on-board Loop-A controller and the optional Loop-B controller provided through a PCI card.

## probe-ide *Command*

The `probe-ide` command communicates with all Integrated Drive Electronics (IDE) devices connected to the IDE bus. This is the internal system bus for media devices such as the DVD drive.



---

**Caution** – If you used the `halt` command or the Stop-A key sequence to reach the `ok` prompt, then issuing the `probe-ide` command can hang the system.

---

The following is sample output from the `probe-ide` command.

```
ok probe-ide
  Device 0 ( Primary Master )
      Removable ATAPI Model: TOSHIBA DVD-ROM SD-C2512

  Device 1 ( Primary Slave )
      Not Present
```

**CODE EXAMPLE 6-5** `probe-ide` Command Output

## show-devs *Command*

The `show-devs` command lists the hardware device paths for each device in the firmware device tree. CODE EXAMPLE 6-6 shows some sample output (edited for brevity).

```
/pci@9,600000
/pci@9,700000
/pci@8,600000
/pci@8,700000
/memory-controller@3,400000
/SUNW,UltraSPARC-IV@3,0
/memory-controller@1,400000
/SUNW,UltraSPARC-IV@1,0
/virtual-memory
/memory@m0,20
/pci@9,600000/SUNW,qlc@2
/pci@9,600000/network@1
/pci@9,600000/SUNW,qlc@2/fp@0,0
/pci@9,600000/SUNW,qlc@2/fp@0,0/disk
```

**CODE EXAMPLE 6-6** `show-devs` Command Output



# Stage Three: The Operating System

If a system passes OpenBoot Diagnostics tests, it normally attempts to boot its multiuser operating system. For most Sun systems, this means the Solaris OS. Once the server is running in multiuser mode, you have recourse to software-based diagnostic tools, like SunVTS and Sun Management Center. These tools can help you with more advanced monitoring, exercising, and fault isolating capabilities.

---

**Note** – If you set the `auto-boot` OpenBoot configuration variable to `false`, the operating system does *not* boot automatically following completion of the firmware-based tests.

---

In addition to the formal tools that run on top of Solaris OS software, there are other resources that you can use when assessing or monitoring the condition of a Sun Fire V490 server. These include:

- Error and system message log files
- Solaris system information commands

## Error and System Message Log Files

Error and other system messages are saved in the file `/var/adm/messages`. Messages are logged to this file from many sources, including the operating system, the environmental control subsystem, and various software applications.

For information about `/var/adm/messages` and other sources of system information, refer to your Solaris system administration documentation.

## Solaris System Information Commands

Some Solaris commands display data that you can use when assessing the condition of a Sun Fire V490 server. These include the following commands:

- `prtconf` command
- `prtdiag` command
- `prtf` command
- `psrinfo` command
- `showrev` command

This section describes the information these commands give you. For instructions on using these commands, turn to “How to Use Solaris System Information Commands” on page 197, or look up the appropriate man page.

## *prtconf Command*

The `prtconf` command displays the Solaris device tree. This tree includes all the devices probed by OpenBoot firmware, as well as additional devices, like individual disks, that only the operating system software “knows” about. The output of `prtconf` also includes the total amount of system memory. CODE EXAMPLE 6-7 shows an excerpt of `prtconf` output (edited to save space).

```
System Configuration: Sun Microsystems sun4u
Memory size: 1024 Megabytes
System Peripherals (Software Nodes):

SUNW,Sun-Fire-V490
  packages (driver not attached)
    SUNW,builtin-drivers (driver not attached)
  ...
  SUNW,UltraSPARC-IV (driver not attached)
  memory-controller, instance #3
  pci, instance #0
    SUNW,qlc, instance #5
      fp (driver not attached)
      disk (driver not attached)
  ...
  pci, instance #2
    ebus, instance #0
      flashprom (driver not attached)
      bbc (driver not attached)
      power (driver not attached)
      i2c, instance #1
        fru, instance #17
```

### **CODE EXAMPLE 6-7** `prtconf` Command Output

The `prtconf` command’s `-p` option produces output similar to the OpenBoot `show-devs` command (see “`show-devs` Command” on page 92). This output lists only those devices compiled by the system firmware.

## *prtdiag Command*

The `prtdiag` command displays a table of diagnostic information that summarizes the status of system components.

The display format used by the `prtdiag` command can vary depending on what version of the Solaris OS is running on your system. Following is an excerpt of some of the output produced by `prtdiag` on a healthy Sun Fire V490 system running Solaris 8, Update 7.

```

System Configuration: Sun Microsystems sun4u Sun Fire V490
System clock frequency: 150 MHz
Memory size: 4096 Megabytes

===== CPUs =====

Brd   CPU  Run  E$   CPU   CPU
----  ---  ---  ---  ----  ---
A     0   900  8.0  US-IV 2.1
A     2   900  8.0  US-IV 2.1

===== Memory Configuration =====

Brd   MC   Logical  Logical  Logical
----  --   Bank    Bank     Bank
      ID  num     size    Status
-----
A     0   0       512MB   no_status
A     0   1       512MB   no_status
A     0   2       512MB   no_status
A     0   3       512MB   no_status
A     2   0       512MB   no_status
A     2   1       512MB   no_status
A     2   2       512MB   no_status
A     2   3       512MB   no_status

DIMM   Interleave  Interleaved
Size   Factor     with
-----
256MB  8-way      0
256MB  8-way      0
256MB  8-way      0
256MB  8-way      0
256MB  8-way      0
256MB  8-way      0
256MB  8-way      0
256MB  8-way      0

===== IO Cards =====

IO   Bus   Bus   Max
Type Port Side Slot Freq Bus Dev,
-----
      ID  Side Slot MHz Freq Func State Name           Model
-----
PCI  8    B    3    33  33   3,0 ok  TECH-SOURCE,gfxp      GFXP
PCI  8    B    5    33  33   5,1 ok  SUNW,hme-pci108e,1001  SUNW,qsi
#

```

**CODE EXAMPLE 6-8** `prtdiag` Command Output

In addition to that information, `prtdiag` with the verbose option (`-v`) also reports on front panel status, disk status, fan status, power supplies, hardware revisions, and system temperatures.

```

System Temperatures (Celsius):
-----
Device           Temperature      Status
-----
CPU0              59              OK
CPU2              64              OK
DBP0              22              OK

```

**CODE EXAMPLE 6-9** `prtdiag` Verbose Output

In the event of an overtemperature condition, `prtdiag` reports an error in the Status column.

```

System Temperatures (Celsius):
-----
Device           Temperature      Status
-----
CPU0              62              OK
CPU1              102             ERROR

```

**CODE EXAMPLE 6-10** `prtdiag` Overtemperature Indication Output

Similarly, if there is a failure of a particular component, `prtdiag` reports a fault in the appropriate Status column.

```

Fan Status:
-----

Bank           RPM      Status
----          -
CPU0           4166    [NO_FAULT]
CPU1           0000    [FAULT]

```

**CODE EXAMPLE 6-11** `prtdiag` Fault Indication Output

### `prtfri` *Command*

The Sun Fire V490 system maintains a hierarchical list of all field-replaceable units (FRUs) in the system, as well as specific information about various FRUs.

The `prtfriu` command can display this hierarchical list, as well as data contained in the serial electrically-erasable programmable read-only memory (SEEPROM) devices located on many FRUs. CODE EXAMPLE 6-12 shows an excerpt of a hierarchical list of FRUs generated by the `prtfriu` command with the `-l` option.

```
/frutree
/frutree/chassis (fru)
/frutree/chassis/io-board (container)
/frutree/chassis/rsc-board (container)
/frutree/chassis/fcal-backplane-slot
```

**CODE EXAMPLE 6-12** `prtfriu -l` Command Output

CODE EXAMPLE 6-13 shows an excerpt of SEEPROM data generated by the `prtfriu` command with the `-c` option.

```
/frutree/chassis/rsc-board (container)
  SEGMENT: SD
    /ManR
    /ManR/UNIX_Stamp32: Fri Apr 27 00:12:36 EDT 2001
    /ManR/Fru_Description: SC PLAN B
    /ManR/Manufacture_Loc: BENCHMARK,HUNTSVILLE,ALABAMA,USA
    /ManR/Sun_Part_No: 5015856
    /ManR/Sun_Serial_No: 001927
    /ManR/Vendor_Name: AVEEX Electronics
    /ManR/Initial_HW_Dash_Level: 02
    /ManR/Initial_HW_Rev_Level: 50
    /ManR/Fru_Shortname: SC
```

**CODE EXAMPLE 6-13** `prtfriu -c` Command Output

Data displayed by the `prtfriu` command varies depending on the type of FRU. In general, this information includes:

- FRU description
- Manufacturer name and location
- Part number and serial number
- Hardware revision levels

Information about the following Sun Fire V490 FRUs is displayed by the `prtfriu` command:

- Centerplane
- CPU/Memory boards
- DIMMs
- FC-AL disk backplane
- FC-AL disk drive
- PCI riser

- Power distribution board
- Power supplies
- System controller card

### `psrinfo` *Command*

The `psrinfo` command displays the date and time each processor came online. With the verbose (`-v`) option, the command displays additional information about the processors, including their clock speed. The following is sample output from the `psrinfo` command with the `-v` option.

```
Status of processor 0 as of: 04/11/03 12:03:45
  Processor has been on-line since 04/11/03 10:53:03.
  The sparcv9 processor operates at 900 MHz,
    and has a sparcv9 floating point processor.
Status of processor 2 as of: 04/11/03 12:03:45
  Processor has been on-line since 04/11/03 10:53:05.
  The sparcv9 processor operates at 900 MHz,
    and has a sparcv9 floating point processor.
```

**CODE EXAMPLE 6-14** `psrinfo -v` Command Output

### `showrev` *Command*

The `showrev` command displays revision information for the current hardware and software. CODE EXAMPLE 6-15 shows sample output of the `showrev` command.

```
Hostname: abc-123
Hostid: cc0ac37f
Release: 5.8
Kernel architecture: sun4u
Application architecture: sparc
Hardware provider: Sun_Microsystems
Domain: Sun.COM
Kernel version: SunOS 5.8 cstone_14:08/01/01 2001
```

**CODE EXAMPLE 6-15** `showrev` Command Output

When used with the `-p` option, this command displays installed patches.  
 CODE EXAMPLE 6-16 shows a partial sample output from the `showrev` command with the `-p` option.

```
Patch: 109729-01 Obsoletes: Requires: Incompatibles: Packages: SUNWcsu
Patch: 109783-01 Obsoletes: Requires: Incompatibles: Packages: SUNWcsu
Patch: 109807-01 Obsoletes: Requires: Incompatibles: Packages: SUNWcsu
Patch: 109809-01 Obsoletes: Requires: Incompatibles: Packages: SUNWcsu
Patch: 110905-01 Obsoletes: Requires: Incompatibles: Packages: SUNWcsu
Patch: 110910-01 Obsoletes: Requires: Incompatibles: Packages: SUNWcsu
Patch: 110914-01 Obsoletes: Requires: Incompatibles: Packages: SUNWcsu
Patch: 108964-04 Obsoletes: Requires: Incompatibles: Packages: SUNWcsr
```

**CODE EXAMPLE 6-16** `showrev -p` Command Output

## Tools and the Boot Process: A Summary

Different diagnostic tools are available to you at different stages of the boot process. TABLE 6-4 summarizes what tools are available to you and when they are available.

**TABLE 6-4** Diagnostic Tool Availability

Stage	Available Diagnostic Tools		
	Fault Isolation	System Monitoring	System Exercising
Before the operating system starts	- LEDs - POST - OpenBoot Diagnostics	- RSC software - OpenBoot commands	-none-
After the operating system starts	- LEDs	- RSC software - Sun Management Center - Solaris info commands - OpenBoot commands	- SunVTS - Hardware Diagnostic Suite
When the system is down and power is not available	-none-	- RSC software	-none-

---

# About Isolating Faults in the System

Each of the tools available for fault isolation discloses faults in different field-replaceable units (FRUs). The row headings along the left of TABLE 6-5 list the FRUs in a Sun Fire V490 system. The available diagnostic tools are shown in column headings across the top. A check mark (✓) in this table indicates that a fault in a particular FRU can be isolated by a particular diagnostic.

**TABLE 6-5** FRU Coverage of Fault Isolating Tools

	LEDs	POST	OpenBoot Diags
CPU/Memory Boards		✓	
IDPROM			✓
DIMMs		✓	
DVD Drive			✓
FC-AL Disk Drive	✓		✓
Centerplane		✓	✓
SC Card			✓
PCI Riser		✓	✓
FC-AL Disk Backplane			✓
Power Supplies	✓		
Fan Tray 0 (CPU)	✓		
Fan Tray 1 (PCI)	✓		



In addition to the FRUs listed in TABLE 6-5, there are several minor replaceable system components—mostly cables—that cannot directly be isolated by any system diagnostic. For the most part, you determine when these components are faulty by eliminating other possibilities. These FRUs are listed in TABLE 6-6.

**TABLE 6-6** FRUs Not Directly Isolated by Diagnostic Tools

FRU	Notes
FC-AL power cable FC-AL signal cable	If OpenBoot Diagnostics tests indicate a disk problem, but replacing the disk does not fix the problem, you should suspect the FC-AL signal and power cables are either defective or improperly connected.
Fan Tray 0 power cable	If the system is powered on and the fan does not spin, or if the Power/OK LED does not come on, but the system is up and running, you should suspect this cable.
Power distribution board	Any power issue that cannot be traced to the power supplies should lead you to suspect the power distribution board. Particular scenarios include: <ul style="list-style-type: none"> <li>• The system will not power on, but the power supply LEDs indicate DC Present</li> <li>• System is running, but RSC indicates a missing power supply</li> </ul>
Removable media bay board and cable assembly	If OpenBoot Diagnostics tests indicate a problem with the CD/DVD drive, but replacing the drive does not fix the problem, you should suspect this assembly is either defective or improperly connected.
System control switch/power button cable	If the system control switch and Power button appear unresponsive, you should suspect this cable is loose or defective.

## About Monitoring the System

Sun provides two tools that can give you advance warning of difficulties and prevent future downtime. These are:

- Sun Remote System Controller (RSC)
- Sun Management Center

These monitoring tools let you specify system criteria that bear watching. For instance, you can set a threshold for system temperature and be notified if that threshold is exceeded.

# Monitoring the System Using Remote System Control Software

Sun Remote System Controller (RSC) software, working in conjunction with the system controller (SC) card, enables you to monitor and control your server over a serial port or a network. RSC software provides both graphical and command-line interfaces for remotely administering geographically distributed or physically inaccessible machines.

You can also redirect the server's system console to the system controller, which lets you remotely run diagnostics (like POST) that would otherwise require physical proximity to the machine's serial port.

The system controller card runs independently, and uses standby power from the server. Therefore, the SC and its RSC software continue to be effective when the server operating system goes offline.

RSC software lets you monitor the following on the Sun Fire V490 server.

**TABLE 6-7** What RSC Software Monitors

Item Monitored	What RSC Software Reveals
Disk drives	Whether each slot has a drive present, and whether it reports OK status
Fan trays	Fan speed and whether the fan trays report OK status
CPU/Memory boards	The presence of a CPU/Memory board, the temperature measured at each processor, and any thermal warning or failure conditions
Power supplies	Whether each bay has a power supply present, and whether it reports OK status
System temperature	System ambient temperature as measured at several locations in the system, as well as any thermal warning or failure conditions
Server front panel	System control switch position and status of LEDs

Before you can start using RSC software, you must install and configure it on the server and client systems. Instructions for doing this are given in the *Sun Remote System Controller (RSC) User's Guide*, which is included on the Sun Fire V490 Documentation CD.

You also have to make any needed physical connections and set OpenBoot configuration variables that redirect the console output to the system controller. The latter task is described in "How to Redirect the System Console to the System Controller" on page 159.

For instructions on using RSC software to monitor a Sun Fire V490 system, see “How to Monitor the System Using the System Controller and RSC Software” on page 190.

## Monitoring the System Using Sun Management Center

Sun Management Center software provides enterprise-wide monitoring of Sun servers and workstations, including their subsystems, components, and peripheral devices. The system being monitored must be up and running, and you need to install all the proper software components on various systems in your network.

Sun Management Center lets you monitor the following on the Sun Fire V490 server.

**TABLE 6-8** What Sun Management Center Software Monitors

Item Monitored	What Sun Management Center Reveals
Disk drives	Whether each slot has a drive present, and whether it reports OK status
Fan trays	Whether the fan trays report OK status
CPU/Memory boards	The presence of a CPU/Memory board, the temperature measured at each processor, and any thermal warning or failure conditions
Power supplies	Whether each bay has a power supply present, and whether it reports OK status
System temperature	System ambient temperature as measured at several locations in the system, as well as any thermal warning or failure conditions

### How Sun Management Center Works

The Sun Management Center product comprises three software entities:

- Agent components
- Server component
- Monitor components

You install *agents* on systems to be monitored. The agents collect system status information from log files, device trees, and platform-specific sources, and report that data to the server component.

The *server* component maintains a large database of status information for a wide range of Sun platforms. This database is updated frequently, and includes information about boards, tapes, power supplies, and disks as well as operating system parameters like load, resource usage, and disk space. You can create alarm thresholds and be notified when these are exceeded.

The *monitor* components present the collected data to you in a standard format. Sun Management Center software provides both a standalone Java application and a Web browser-based interface. The Java interface affords physical and logical views of the system for highly-intuitable monitoring.

## Other Sun Management Center Features

Sun Management Center software provides you with additional tools in the form of an informal tracking mechanism and an optional add-on diagnostics suite. In a heterogeneous computing environment, the product can interoperate with management utilities made by other companies.

### *Informal Tracking*

Sun Management Center agent software must be loaded on any system you want to monitor. However, the product lets you informally track a supported platform even when the agent software has not been installed on it. In this case, you do not have full monitoring capability, but you can add the system to your browser, have Sun Management Center periodically check whether it is up and running, and notify you if it goes out of commission.

### *Add-On Diagnostic Suite*

The *Hardware Diagnostic Suite* is available as a premium package you can purchase as an add-on to the Sun Management Center product. This suite lets you exercise a system while it is still up and running in a production environment. See “Exercising the System Using Hardware Diagnostic Suite” on page 108 for more information.

### *Interoperability With Third-Party Monitoring Tools*

If you administer a heterogeneous network and use a third-party network-based system monitoring or management tool, you may be able to take advantage of Sun Management Center software’s support for Tivoli Enterprise Console, BMC Patrol, and HP Openview.

## Who Should Use Sun Management Center?

Sun Management Center software is geared primarily toward system administrators who have large data centers to monitor or other installations that have many computer platforms to monitor. If you administer a more modest installation, you need to weigh Sun Management Center software's benefits against the requirement of maintaining a significant database (typically over 700 Mbytes) of system status information.

The servers being monitored must be up and running if you want to use Sun Management Center, since this tool relies on the Solaris OS. For instructions, see "How to Monitor the System Using Sun Management Center Software" on page 186. For detailed information about the product, see the *Sun Management Center User's Guide*.

## Obtaining the Latest Information

For the latest information about this product, go to the Sun Management Center Web site at: <http://www.sun.com/sunmanagementcenter>.

---

## About Exercising the System

It is relatively easy to detect when a system component fails outright. However, when a system has an intermittent problem or seems to be "behaving strangely," a software tool that stresses or exercises the computer's many subsystems can help disclose the source of the emerging problem and prevent long periods of reduced functionality or system downtime.

Sun provides two tools for exercising Sun Fire V490 systems:

- Sun Validation Test Suite (SunVTS™)
- Hardware Diagnostic Suite

TABLE 6-9 shows the FRUs that each system exercising tool is capable of isolating. Note that individual tools do not necessarily test *all* the components or paths of a particular FRU.

TABLE 6-9 FRU Coverage of System Exercising Tools

	SunVTS	Hardware Diagnostic Suite
CPU/Memory Boards	✓	✓
IDPROM	✓	
DIMMs	✓	✓
DVD Drive	✓	✓
FC-AL Disk Drive	✓	✓
Centerplane	✓	✓
SC Card	✓	
PCI Riser	✓	✓
FC-AL Disk Backplane	✓	

## Exercising the System Using SunVTS Software

SunVTS software validation test suite performs system and subsystem stress testing. You can view and control a SunVTS session over a network. Using a remote machine, you can view the progress of a testing session, change testing options, and control all testing features of another machine on the network.

You can run SunVTS software in five different test modes:

- **Connection mode** – SunVTS software verifies the presence of device controllers on all subsystems. This typically takes no more than a few minutes and is a good way to “sanity check” system connections.
- **Functional mode** – SunVTS software exercises only the specific subsystems you choose. This is the default mode. In Functional mode, selected tests are run in parallel. This mode uses system resources heavily, so you should not run any other applications at the same time.
- **Auto Config mode** – SunVTS software automatically detects all subsystems and exercises them in one of two ways:
  - **Confidence testing** – SunVTS software performs one pass of tests on all subsystems, and then stops. For typical system configurations, this requires one or two hours.
  - **Comprehensive testing** – SunVTS software exhaustively and repeatedly tests all subsystems for up to 24 hours.

- **Exclusive mode** – SunVTS software exercises only the specific subsystems you choose. Selected tests are run one at a time. A few tests are *only* available in this mode, including: `l1dcachetest`, `l2cachetest`, `l2sramtest`, `mpconstest`, `mptest`, `qlctest`, `ramtest`, `ssptest`, and `systest`.
- **Online mode** – SunVTS software exercises only the specific subsystems you choose. Selected tests are run one at a time until one complete system pass is achieved. This mode is useful for performing tests while other applications are running.

Since SunVTS software can run many tests in parallel and consume many system resources, you should take care when using it on a production system. If you are stress-testing a system using SunVTS software's Comprehensive test mode, you should not run anything else on that system at the same time.

The Sun Fire V490 server to be tested must be up and running if you want to use SunVTS software, since it relies on the Solaris operating system. Since SunVTS software packages are optional, they may not be installed on your system. Turn to "How to Check Whether SunVTS Software Is Installed" on page 206 for instructions.

It is important to use the most-up-to-date version of SunVTS available, to ensure you have the latest suite of tests. To download the most recent SunVTS software, point your Web browser to: <http://www.sun.com/oem/products/vts/>.

For instructions on running SunVTS software to exercise the Sun Fire V490 server, see "How to Exercise the System Using SunVTS Software" on page 202. For more information about the product, see:

- *SunVTS User's Guide* – Describes SunVTS features as well as how to start and control the various user interfaces.
- *SunVTS Test Reference Manual* – Describes each SunVTS test, option, and command-line argument.
- *SunVTS Quick Reference Card* – Gives an overview of the main features of the graphical user interface (GUI).
- *SunVTS Documentation Supplement* – Describes the latest product enhancements and documentation updates not included in the *SunVTS User's Guide* and *SunVTS Test Reference Manual*.

These documents are available on the Solaris Software Supplement CD and on the Web at: <http://docs.sun.com>. You should also consult the SunVTS README file located at `/opt/SUNWvts/`. This document provides late-breaking information about the installed version of the product.

## SunVTS Software and Security

During SunVTS software installation, you must choose between Basic or Sun Enterprise Authentication Mechanism (SEAM) security. Basic security uses a local security file in the SunVTS installation directory to limit the users, groups, and hosts permitted to use SunVTS software. SEAM security is based on Kerberos—the standard network authentication protocol—and provides secure user authentication, data integrity, and privacy for transactions over networks.

If your site uses SEAM security, you must have the SEAM client and server software installed in your networked environment and configured properly in both Solaris and SunVTS software. If your site does not use SEAM security, do not choose the SEAM option during SunVTS software installation.

If you enable the wrong security scheme during installation, or if you improperly configure the security scheme you choose, you may find yourself unable to run SunVTS tests. For more information, see the *SunVTS User's Guide* and the instructions accompanying the SEAM software.

## Exercising the System Using Hardware Diagnostic Suite

The Sun Management Center product features an optional Hardware Diagnostic Suite, which you can purchase as an add-on. The Hardware Diagnostic Suite is designed to exercise a production system by running tests sequentially.

Sequential testing means the Hardware Diagnostic Suite has a low impact on the system. Unlike SunVTS, which stresses a system by consuming its resources with many parallel tests (see “Exercising the System Using SunVTS Software” on page 106), the Hardware Diagnostic Suite lets the server run other applications while testing proceeds.

### When to Run Hardware Diagnostic Suite

The best use of the Hardware Diagnostic Suite is to disclose a suspected or intermittent problem with a noncritical part on an otherwise functioning machine. Examples might include questionable disk drives or memory modules on a machine that has ample or redundant disk and memory resources.

In cases like these, the Hardware Diagnostic Suite runs unobtrusively until it identifies the source of the problem. The machine under test can be kept in production mode until and unless it must be shut down for repair. If the faulty part is hot-pluggable or hot-swappable, the entire diagnose-and-repair cycle can be completed with minimal impact to system users.



## Requirements for Using Hardware Diagnostic Suite

Since it is a part of Sun Management Center, you can only run Hardware Diagnostic Suite if you have set up your data center to run Sun Management Center. This means you have to dedicate a master server to run the Sun Management Center server software that supports Sun Management Center software's database of platform status information. In addition, you must install and set up Sun Management Center agent software on the systems to be monitored. Finally, you need to install the console portion of Sun Management Center software, which serves as your interface to the Hardware Diagnostic Suite.

Instructions for setting up Sun Management Center, as well as for using the Hardware Diagnostic Suite, can be found in the *Sun Management Center User's Guide*.

---

## Reference for OpenBoot Diagnostics Test Descriptions

This section describes the OpenBoot Diagnostics tests and commands available to you. For background information about these tests, see “Stage Two: OpenBoot Diagnostics Tests” on page 85.

**TABLE 6-10** OpenBoot Diagnostics Menu Tests

Test Name	What It Does	FRU(s) Tested
SUNW,qlc@2	Tests the registers of the Fibre Channel-Arbitrated Loop (FC-AL) subsystem. With <code>diag-level</code> set to <code>max</code> , verifies each disk can be written to, and with <code>test-args</code> set to <code>media</code> , performs more extensive disk tests.	Centerplane, FC-AL disk backplane
bbc@1,0	Tests all writable registers in the Boot Bus Controller. Also verifies that at least one system processor has Boot Bus access	Centerplane
ebus@1	Tests the PCI configuration registers, DMA control registers, and EBus mode registers. Also tests DMA controller functions	Centerplane
flashprom@0,0	Performs a checksum test on the Boot PROM	Centerplane
i2c@1,2e	Tests segments 0–4 of the I <sup>2</sup> C environmental monitoring subsystem, which includes various temperature and other sensors located throughout the system	} Multiple. See “Reference for Diagnostic Test Messages” on page 111.
i2c@1,30	Same as above, for segment 5 of the I <sup>2</sup> C environmental monitoring subsystem	

**TABLE 6-10** OpenBoot Diagnostics Menu Tests (*Continued*)

Test Name	What It Does	FRU(s) Tested
ide@6	Tests the on-board IDE controller and IDE bus subsystem that controls the DVD drive	PCI riser board, DVD drive
network@1	Tests the on-board Ethernet logic, running internal loopback tests. Can also run external loopback tests, but only if you install a loopback connector (not provided)	Centerplane
network@2	Same as above, for the other on-board Ethernet controller	Centerplane
pmc@1,300700	Tests the registers of the power management controller	PCI riser board
rsc-control@1,3062f8	Tests SC hardware, including the SC serial and Ethernet ports	SC card
rtc@1,300070	Tests the registers of the real-time clock and then tests the interrupt rates	PCI riser board
serial@1,400000	Tests all possible baud rates supported by the ttya serial line. Performs an internal and external loopback test on each line at each speed	Centerplane, PCI riser board
usb@1,3	Tests the writable registers of the USB open host controller	Centerplane

TABLE 6-11 describes the commands you can type from the `obdiag>` prompt.

**TABLE 6-11** OpenBoot Diagnostics Test Menu Commands

Command	Description
<code>exit</code>	Exits OpenBoot Diagnostics tests and returns to the <code>ok</code> prompt
<code>help</code>	Displays a brief description of each OpenBoot Diagnostics command and OpenBoot configuration variable
<code>setenv variable value</code>	Sets the value for an OpenBoot configuration variable (also available from the <code>ok</code> prompt)
<code>test-all</code>	Tests all devices displayed in the OpenBoot Diagnostics test menu (also available from the <code>ok</code> prompt)
<code>test #</code>	Tests only the device identified by the given menu entry number. (A similar function is available from the <code>ok</code> prompt. See “From the <code>ok</code> Prompt: The <code>test</code> and <code>test-all</code> Commands” on page 87.)
<code>test #,#</code>	Tests only the devices identified by the given menu entry numbers

**TABLE 6-11** OpenBoot Diagnostics Test Menu Commands *(Continued)*

Command	Description
except #,#	Tests all devices in the OpenBoot Diagnostics test menu except those identified by the specified menu entry numbers
versions	Displays the version, last modified date, and manufacturer of each self-test in the OpenBoot Diagnostics test menu and library
what #,#	Displays selected properties of the devices identified by menu entry numbers. The information provided varies according to device type

## Reference for Decoding I<sup>2</sup>C Diagnostic Test Messages

TABLE 6-12 describes each I<sup>2</sup>C device in a Sun Fire V490 system, and helps you associate each I<sup>2</sup>C address with the proper FRU. For more information about I<sup>2</sup>C tests, see “I<sup>2</sup>C Bus Device Tests” on page 89.

**TABLE 6-12** Sun Fire V490 I<sup>2</sup>C Bus Devices

Address	Associated FRU	What the Device Does
fru@0,a0	processor 0, DIMM 0	Provides configuration information for processor 0 DIMMs
fru@0,a2	processor 0, DIMM 1	
fru@0,a4	processor 0, DIMM 2	
fru@0,a6	processor 0, DIMM 3	
fru@0,a8	processor 0, DIMM 4	
fru@0,aa	processor 0, DIMM 5	
fru@0,ac	processor 0, DIMM 6	
fru@0,ae	processor 0, DIMM 7	

**TABLE 6-12 Sun Fire V490 I<sup>2</sup>C Bus Devices (Continued)**

Address	Associated FRU	What the Device Does
fru@1,a0	processor 1, DIMM 0	Provides configuration information for processor 1 DIMMs
fru@1,a2	processor 1, DIMM 1	
fru@1,a4	processor 1, DIMM 2	
fru@1,a6	processor 1, DIMM 3	
fru@1,a8	processor 1, DIMM 4	
fru@1,aa	processor 1, DIMM 5	
fru@1,ac	processor 1, DIMM 6	
fru@1,ae	processor 1, DIMM 7	
fru@2,a0	processor 2, DIMM 0	Provides configuration information for processor 2 DIMMs
fru@2,a2	processor 2, DIMM 1	
fru@2,a4	processor 2, DIMM 2	
fru@2,a6	processor 2, DIMM 3	
fru@2,a8	processor 2, DIMM 4	
fru@2,aa	processor 2, DIMM 5	
fru@2,ac	processor 2, DIMM 6	
fru@2,ae	processor 2, DIMM 7	
fru@3,a0	processor 3, DIMM 0	Provides configuration information for processor 3 DIMMs
fru@3,a2	processor 3, DIMM 1	
fru@3,a4	processor 3, DIMM 2	
fru@3,a6	processor 3, DIMM 3	
fru@3,a8	processor 3, DIMM 4	
fru@3,aa	processor 3, DIMM 5	
fru@3,ac	processor 3, DIMM 6	
fru@3,ae	processor 3, DIMM 7	
fru@4,a0	CPU/Mem board, slot A	Provides configuration information for the CPU/Memory board in slot A
fru@4,a2	CPU/Mem Board, slot B	Provides configuration information for the CPU/Memory board in slot B
nvr@4,a4	PCI riser	Provides system configuration information (IDPROM)
fru@4,a8	Centerplane	Provides centerplane configuration information

**TABLE 6-12 Sun Fire V490 I<sup>2</sup>C Bus Devices (Continued)**

Address	Associated FRU	What the Device Does
fru@4,aa	PCI riser	Provides PCI riser board configuration information
fru@5,10	Centerplane	Provides communication and control for I <sup>2</sup> C subsystem
fru@5,14	RSC card	Provides communication and control for the RSC card
temperature@5,30	CPU/Mem board A	Monitors processor 0 temperature
temperature@5,32	CPU/Mem board B	Monitors processor 1 temperature
temperature@5,34	CPU/Mem board A	Monitors processor 2 temperature
temperature@5,52	CPU/Mem board B	Monitors processor 3 temperature
ioexp@5,44	FC-AL disk backplane	Monitors drive status/LED control
ioexp@5,46	FC-AL disk backplane	Monitors Loop B control
ioexp@5,4c	Power distribution board	Monitors power distribution board status
ioexp@5,70	Power Supply 0	Monitors Power Supply 0 status
ioexp@5,72	Power Supply 1	Monitors Power Supply 1 status
ioexp@5,80	Centerplane	Monitors I/O port expander
ioexp@5,82	PCI riser	Monitors I/O port expander
temperature@5,98	<i>Reserved</i>	<i>Reserved for thermal monitoring</i>
temperature-sensor@5,9c	FC-AL disk backplane	Monitors ambient temperature at disk backplane
fru@5,a0	Power Supply 0	Provides configuration information for Power Supply 0
fru@5,a2	Power Supply 1	Provides configuration information for Power Supply 1
fru@5,a6	SC card	Provides SC card configuration information
fru@5,a8	FC-AL disk backplane	Provides disk backplane configuration information
fru@5,ae	Power distribution board	Provides configuration information for the power distribution board and the enclosure
fru@5,d0	SC card	Monitors SC card's real-time clock

---

# Reference for Terms in Diagnostic Output

The status and error messages displayed by POST diagnostics and OpenBoot Diagnostics tests occasionally include acronyms or abbreviations for hardware sub-components. TABLE 6-13 is included to assist you in decoding this terminology and associating the terms with specific FRUs, where appropriate.

**TABLE 6-13** Abbreviations or Acronyms in Diagnostic Output

Term	Description	Associated FRU(s)
ADC	Analog-to-Digital Converter	PCI riser board
APC	Advanced Power Control – A function provided by the SuperIO integrated circuit	PCI riser board
BBC	Boot Bus Controller – Interface between the processors and components on many other buses	Centerplane
CDX	Data Crossbar – Part of the system bus	Centerplane
CRC	Cyclic Redundancy Check	N/A
DAR	Address Repeater – Part of the system bus	Centerplane
DCDS	Dual Data Switch – Part of the system bus	CPU/Memory board
DMA	Direct Memory Access – In diagnostic output, usually refers to a controller on a PCI card	PCI card
EBus	A byte-wide bus for low-speed devices	Centerplane, PCI riser board
HBA	Host Bus Adapter	Centerplane, various others
I <sup>2</sup> C	Inter-Integrated Circuit (also written as I2C) – A bidirectional, two-wire serial data bus. Used mainly for environmental monitoring and control	Various. See TABLE 6-12.
I/O Board	PCI Riser	PCI riser
JTAG	Joint Test Access Group – An IEEE subcommittee standard (1149.1) for scanning system components	N/A
MAC	Media Access Controller – Hardware address of a device connected to a network	Centerplane
MII	Media Independent Interface – Part of Ethernet controller	Centerplane
Motherboard	Centerplane	Centerplane

**TABLE 6-13** Abbreviations or Acronyms in Diagnostic Output *(Continued)*

<b>Term</b>	<b>Description</b>	<b>Associated FRU(s)</b>
NVRAM	IDPROM	IDPROM, located on PCI riser board
OBP	Refers to OpenBoot firmware	N/A
PDB	Power Distribution Board	Power distribution board
PMC	Power Management Controller	PCI riser board
POST	Power-On Self-Test	N/A
RIO	Multifunction integrated circuit bridging the PCI bus with EBus and USB	PCI riser board
RTC	Real-Time Clock	PCI riser board
RX	Receive – Communication protocol	Centerplane
Safari	The system interconnect architecture—that is, the data and address buses	CPU/Memory board, centerplane
Schizo	System bus to PCI bridge integrated circuit	Centerplane
Scan	A means for monitoring and altering the content of ASICs and system components, as provided for in the IEEE 1149.1 standard	N/A
SIO	SuperIO integrated circuit – Controls the SC UART port and more	PCI riser
TX	Transmit – Communication protocol	Centerplane
UART	Universal Asynchronous Receiver Transmitter – Serial port hardware	Centerplane, PCI riser board, SC card





## PART III Instructions

---

The six chapters within this part of the *Sun Fire V490 Server Administration Guide* use illustrated instructions on how to set up various components within your system, configure your system, and diagnose problems. Instructions within this guide are primarily to be used by experienced system administrators who are familiar with the Solaris OS and its commands.

For detailed background information relating to the various tasks presented in Part Three, see the chapters in Part Two – Background.

Chapters included in Part Three are:

- Chapter 7 – Configuring Console Access
- Chapter 8 – Configuring Network Interfaces and the Boot Device
- Chapter 9 – Configuring System Firmware
- Chapter 10 – Isolating Failed Parts
- Chapter 11 – Monitoring the System
- Chapter 12 – Exercising the System

Following Part Three are three appendixes of system reference information.



## Configuring Console Access

---

This chapter includes instructions on how to configure and access the system console from different physical devices.

Tasks covered in this chapter include:

- “How to Avoid Electrostatic Discharge” on page 120
- “How to Power On the System” on page 122
- “How to Power Off the System” on page 125
- “How to Get to the `ok` Prompt” on page 126
- “How to Attach a Twisted-Pair Ethernet Cable” on page 127
- “How to Access the System Console via `tip` Connection” on page 129
- “How to Modify the `/etc/remote` File” on page 131
- “How to Verify Serial Port Settings” on page 132
- “How to Set Up an Alphanumeric Terminal as the System Console” on page 133
- “How to Configure a Local Graphics Terminal as the System Console” on page 135
- “How to Initiate a Reconfiguration Boot” on page 138

---

**Note** – Many of the procedures in this chapter assume that you are familiar with the OpenBoot firmware and that you know how to enter the OpenBoot environment. For background information, see “About the `ok` Prompt” on page 49. For instructions, see “How to Get to the `ok` Prompt” on page 126.

---

---

# How to Avoid Electrostatic Discharge

Qualified service technicians should use the following procedure to prevent static damage whenever they access any of the internal components of the system.



---

**Caution** – Do not attempt to access any internal components unless you are a qualified service technician. Detailed service instructions can be found in the *Sun Fire V490 Server Parts Installation and Removal Guide*, which is included on the Sun Fire V490 Documentation CD.

---

## Before You Begin

Complete this task:

- “How to Power Off the System” on page 125

You must have the following items:

- Antistatic wrist or foot strap
- Antistatic mat

## What to Do



---

**Caution** – Printed circuit boards and hard disk drives contain electronic components that are extremely sensitive to static electricity. Ordinary amounts of static from your clothes or the work environment can destroy components. Do not touch the components or any metal parts without taking proper antistatic precautions.

---

### 1. Disconnect the AC power cords from the wall power outlet only when performing the following procedures:

- Removing and installing the power distribution board
- Removing and installing the centerplane
- Removing and installing the PCI riser board
- Removing and installing the system controller (SC) card
- Removing and installing the system control switch/power button cable

The AC power cord provides a discharge path for static electricity, so it should remain plugged in except when you are servicing the parts noted above.

## 2. Use an antistatic mat or similar surface.

When performing any installation or service procedure, place static-sensitive parts, such as boards, cards, and disk drives, on an antistatic surface. The following items can be used as an antistatic surface:

- The bag used to wrap a Sun replacement part
- The shipping container used to package a Sun replacement part
- Sun electrostatic discharge (ESD) mat, Sun part number 250-1088 (available through your Sun sales representatives)
- Disposable ESD mat, shipped with replacement parts or options

## 3. Use an antistatic wrist strap.

Attach the appropriate end to the system chassis sheet metal and attach the other end of the strap to your wrist. Refer to the instructions that come with the strap.

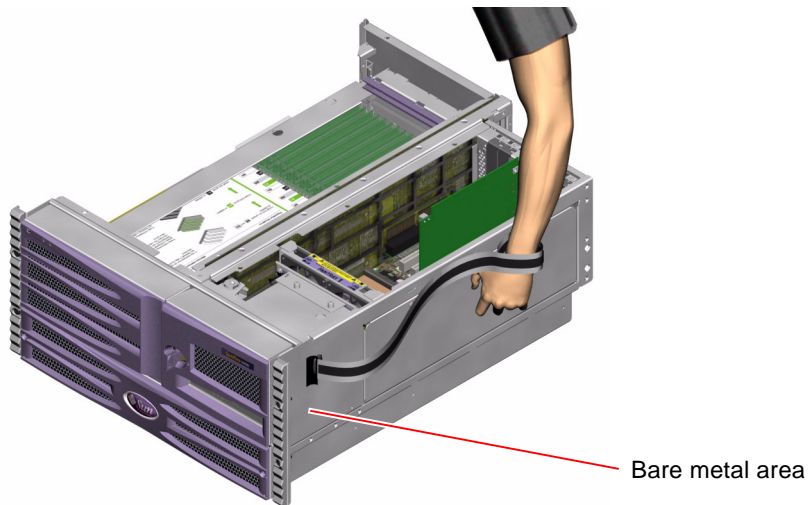

---

**Note** – Make sure that the wrist strap is in direct contact with the metal on the chassis.

---

## 4. Detach both ends of the strap after you have completed the installation or service procedure.

## What Next

To power on the system, complete this task:

- “How to Power On the System” on page 122

---

# How to Power On the System

## Before You Begin

Do not use this power-on procedure if you have just added any new internal option or external storage device, or if you have removed a storage device without replacing it. To power on the system under those circumstances, you must initiate a reconfiguration boot. For those instructions, see “How to Initiate a Reconfiguration Boot” on page 138.

You can also use RSC software to power on the system. For details, see:

- *Sun Remote System Control (RSC) 2.2 User's Guide*



---

**Caution** – Never move the system when the system power is on. Movement can cause catastrophic disk drive failure. Always power off the system before moving it.

---



---

**Caution** – Before you power on the system, make sure that all access panels are properly installed.

---

## What to Do

- 1. Turn on power to any peripherals and external storage devices.**  
Read the documentation supplied with the device for specific instructions.
- 2. Turn on power to the ASCII terminal or local graphics terminal, if present.**
- 3. Open the media door.**  
Use the system key to unlock the media door.



4. Insert the system key into the system control switch and turn the system control switch to the Normal position.

See “System Control Switch” on page 15 for information about each system control switch setting.

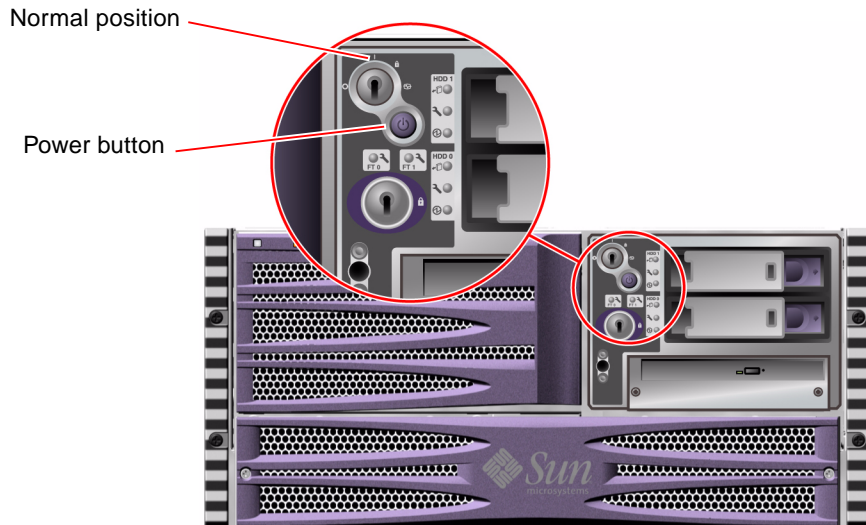

5. Press the Power button that is below the system control switch to power on the system.

---

**Note** – The system may take anywhere from 30 seconds (if firmware diagnostics do not run) to almost 30 minutes before video is displayed on the system monitor or the ok prompt appears on an attached terminal. This time depends on the system configuration (number of processors, memory modules, PCI cards) and the level of power-on self-test (POST) and OpenBoot Diagnostics tests being performed.

---

**6. Turn the system control switch to the Locked position.**

This prevents anyone from accidentally powering off the system.

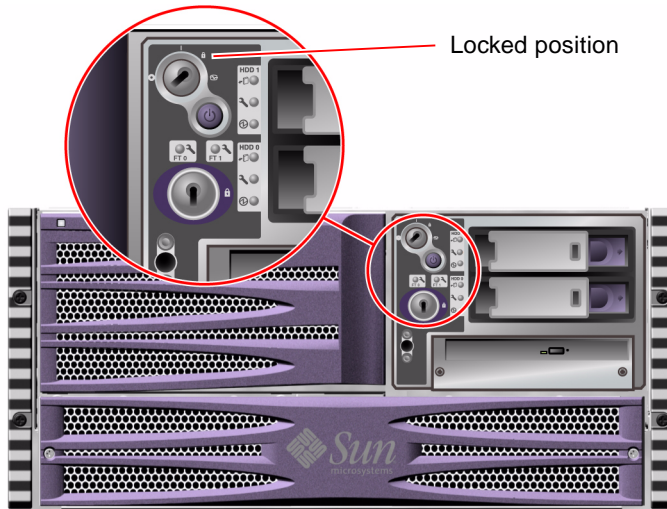

**7. Remove the system key from the system control switch and keep it in a secure place.**

## What Next

To power off the system, complete this task:

- “How to Power Off the System” on page 125



---

# How to Power Off the System

## Before You Begin

Applications running on the Solaris OS can be adversely affected by a poorly executed system shutdown. Make sure that you have gracefully shut down any applications before powering off the system.

You can also use Solaris commands, the OpenBoot firmware `power-off` command, or RSC software to power off the system. For details, see:

- “How to Get to the `ok` Prompt” on page 126
- *Sun Remote System Controller (RSC) User’s Guide*

## What to Do

1. **Notify users that the system will be powered down.**
2. **Back up the system files and data, if necessary.**
3. **Ensure that the system control switch is in the Normal position.**
4. **Press and release the Power button on the system front panel.**

The system begins a graceful software system shutdown.

---

**Note** – Pressing and releasing the Power button initiates a graceful software system shutdown. Pressing and holding in the Power button for five seconds causes an immediate hardware shutdown. Whenever possible, you should use the graceful shutdown method. Forcing an immediate hardware shutdown may cause disk drive corruption and loss of data. Use that method only as a last resort.

---

5. **Wait for the front panel Power/OK LED to turn off.**
6. **Turn the system control switch to the Forced Off position.**



---

**Caution** – Be sure to turn the system control switch to the Forced Off position before handling any internal components. Otherwise, it is possible for an operator at a system controller (SC) console to restart the system while you are working inside it. The Forced Off position is the only system control switch position that prevents an SC console from restarting the system.

---

7. **Remove the system key from the system control switch and keep it in a secure place.**

## What Next

Qualified service technicians can now continue with parts removal and installation, as needed.

---

**Note** – Do not attempt to access any internal components unless you are a qualified service technician. Detailed service instructions can be found in the *Sun Fire V490 Server Parts Installation and Removal Guide*, which is included on the Sun Fire V490 Documentation CD.

---

---

# How to Get to the ok Prompt

## Before You Begin

This procedure provides several ways of reaching the ok prompt. The methods are not equally desirable. For details about when to use each method, see:

- “About the ok Prompt” on page 49

---

**Note** – Dropping the Sun Fire V490 system to the ok prompt suspends all application and operating system software. After you issue firmware commands and run firmware-based tests from the ok prompt, the system may not be able simply to resume where it left off.

---

If at all possible, back up system data before starting this procedure. Also halt all applications and warn users of the impending loss of service. For information about the appropriate backup and shutdown procedures, see Solaris system administration documentation.

## What to Do

**1. Decide which method you need to use to reach the `ok` prompt.**

See “About the `ok` Prompt” on page 49 for details.

**2. Refer to TABLE 7-1 for instructions.**

**TABLE 7-1** Ways of Accessing the `ok` Prompt

Access Method	What to Do
Graceful halt	<ul style="list-style-type: none"><li>• From a console window (<code>dtterm</code>, for example), issue an appropriate command (for example, the <code>shutdown</code>, <code>init</code>, <code>halt</code>, or <code>uadmin</code> command) as described in Solaris system administration documentation.</li></ul>
Stop-A (L1-A) or Break key sequence	<ul style="list-style-type: none"><li>• From a Sun keyboard, hold down the <code>Stop</code> and <code>A</code> keys simultaneously.</li><li>–or–</li><li>• From a connected alphanumeric terminal, press the <code>Break</code> key.</li></ul>
Externally initiated reset (XIR)	<ul style="list-style-type: none"><li>• From the system controller, type the <code>xir</code> command.</li></ul>
Manual system reset	<ul style="list-style-type: none"><li>• Press the front panel <code>Power</code> button and hold it for five seconds.</li><li>–or–</li><li>• From the system controller, type the <code>reset</code> command.</li></ul>

---

# How to Attach a Twisted-Pair Ethernet Cable

## Before You Begin

- Complete the prerequisite installation steps in Chapter 1.

- Install the server in the rack, following instructions in the *Sun Fire V490 Server Setup and Rackmounting Guide*.

## What to Do

- 1. Locate the RJ-45 twisted-pair Ethernet (TPE) connector for the appropriate Ethernet interface—the top connector or the bottom connector.**

See “Locating Back Panel Features” on page 16. For a PCI Ethernet adapter card, see the documentation supplied with the card.

- 2. Connect a Category-5 unshielded twisted-pair (UTP) cable to the appropriate RJ-45 connector.**

You should hear the connector tab click into place. The UTP cable length must not exceed 100 meters (328 feet).

- 3. Connect the other end of the cable to the RJ-45 outlet to the appropriate network device.**

You should hear the connector tab click into place.

Consult your network documentation if you need more information about how to connect to your network.

## What Next

If you are installing your system, complete the installation procedure. Return to Chapter 1.

If you are adding an additional network interface to the system, you need to configure that interface. See:

- “How to Configure Additional Network Interfaces” on page 146

---

# How to Access the System Console via `tip` Connection

## Before You Begin

The following procedure assumes you are connecting to the serial port (`ttya`) of the Sun Fire V490 system using a `tip` connection from serial port B (`ttyb`) of another Sun server, and that the other Sun server has its own local graphics terminal.

## What to Do

### 1. Decide whether you need to reset OpenBoot configuration variables on the Sun Fire V490 system.

Certain OpenBoot configuration variables control from where system console input is taken and to where its output is directed.

- *If you are installing a new system* – The default OpenBoot configuration variable settings will work properly. You do not need to reset the variables. Skip to Step 3.
- *If you have previously altered OpenBoot configuration variable settings* – For example, to use the system controller as the system console, you need to change the OpenBoot configuration variables back to their default values. Continue with the next step from the existing system console.
- *If you are not sure whether OpenBoot configuration variable settings have been altered* – See “How to View and Set OpenBoot Configuration Variables” on page 178. Verify that the settings are as given in “Reference for System Console OpenBoot Variable Settings” on page 141. If not, reset them as described in the next step.

### 2. If necessary, reset OpenBoot configuration variables.

From the existing system console, type:

```
ok setenv diag-out-console false
ok setenv input-device ttya
ok setenv output-device ttya
```

---

**Note** – There are many other OpenBoot configuration variables, and although these do not affect which hardware device is used as the system console, some of them affect what diagnostic tests the system runs and what messages the system console displays. For details, see “Controlling POST Diagnostics” on page 82.

---

### 3. Connect the RJ-45 serial cable and adapter.

The cable and adapter connect the Sun server’s `ttyb` serial port to the Sun Fire V490 system’s built-in `ttya` serial port. Pinouts, part numbers, and other details about the serial cable and adapter are provided in the *Sun Fire V490 Server Parts Installation and Removal Guide*.

### 4. Ensure that the `/etc/remote` file on the Sun server contains an entry for `hardwire`.

Most releases of Solaris OS software shipped since 1992 contain an `/etc/remote` file with the appropriate `hardwire` entry. However, if the Sun server is running an older version of Solaris OS software, or if the `/etc/remote` file has been modified, you may need to edit it. See “How to Modify the `/etc/remote` File” on page 131 for details.

### 5. In a terminal tool window on the Sun server, type:

```
hostname% tip hardwire
```

The Sun server responds by displaying:

```
connected
```

The terminal tool is now a `tip` window directed to the Sun Fire V490 system via the Sun server’s `ttyb` port. This connection is established and maintained even if the Sun Fire V490 system is completely powered off or just starting up.

## What Next

Continue with your installation or diagnostic test session as appropriate. When you are finished using the `tip` window, end your `tip` session by typing `~.` (the tilde symbol followed by a period) and exit the window. For more information about `tip` commands, see the `tip` man page.

---

# How to Modify the `/etc/remote` File

You may need to perform this procedure to access the system console via a `tip` connection from a Sun server running an older version of the Solaris OS software.

You may also need to perform this procedure if the `/etc/remote` file on the Sun server has been altered and no longer contains an appropriate `hardware` entry.

## Before You Begin

This procedure assumes you are connecting via `tip` line from serial port B (`tttyb`) of a Sun server to the serial port (`tttya`) of the Sun Fire V490 machine.

## What to Do

### 1. Determine the release level of system software installed on the Sun server.

To do this, type:

```
# uname -r
```

The system responds with a release number.

### 2. Do one of the following, depending on the number displayed.

- If the number displayed by the `uname -r` command is 5.0 or higher:

The server software shipped with an appropriate entry for `hardware` in the `/etc/remote` file. If you have reason to suspect this file was altered and the `hardware` entry modified or deleted, check the entry against the example given in CODE EXAMPLE 7-1, and edit it as needed.

```
hardware:\
      :dv=/dev/term/b:br#9600:el=^C^S^Q^U^D:ie=%$:oe=^D:
```

**CODE EXAMPLE 7-1** Entry for `hardware` in `/etc/remote` (Recent System Software)

---

**Note** – If you intend to use the Sun server’s serial port A rather than serial port B, edit this entry by replacing `/dev/term/b` with `/dev/term/a`.

---

- If the number displayed by the `uname -r` command is less than 5.0:  
Check the `/etc/remote` file and add the entry shown in CODE EXAMPLE 7-2, if it does not already exist.

```
hardware:\  
:dv=/dev/ttyb:br#9600:e1=^C^S^Q^U^D:ie=%$:oe=^D:
```

**CODE EXAMPLE 7-2** Entry for `hardware` in `/etc/remote` (Older System Software)

---

**Note** – If you intend to use the Sun server’s serial port A rather than serial port B, edit this entry by replacing `/dev/ttyb` with `/dev/ttya`.

---

## What Next

The `/etc/remote` file is now properly configured. Continue establishing a `tip` connection to the Sun Fire V490 server’s system console. See

- “How to Access the System Console via `tip` Connection” on page 129

---

# How to Verify Serial Port Settings

This procedure lets you verify the baud rate and other serial port settings used by the Sun Fire V490 server to communicate with attached serial port devices.

## Before You Begin

You must be logged in to the Sun Fire V490 server, and the server must be running Solaris OS software.

## What to Do

1. Open a terminal tool window.



## 2. Type:

```
# eeprom ttya-mode
```

## 3. Look for the following output:

```
ttya-mode = 9600,8,n,1,-
```

This line indicates that the Sun Fire V490 server's serial port is configured for:

- 9600 baud
- 8 bits
- No parity
- 1 stop bit
- No handshake protocol

## What Next

For more information about serial port settings, see the `eeprom` man page. For instructions on setting the `ttya-mode` OpenBoot configuration variable, see

- “How to View and Set OpenBoot Configuration Variables” on page 180

---

# How to Set Up an Alphanumeric Terminal as the System Console

## Before You Begin

To perform initial installation of the system, you need to attach an alphanumeric (ASCII) terminal to the server. Alternatively, you can create a `tip` connection from another Sun system. For instructions, see “How to Access the System Console via `tip` Connection” on page 129.

After initial installation of Solaris OS software, if you have reconfigured the system console to take its input and output from different devices, you can follow this procedure to change back to using an alphanumeric terminal as the system console.

For detailed information about system console options, see “About Communicating With the System” on page 69.

## What to Do

### 1. Attach one end of the serial cable to the alphanumeric terminal’s serial port.

Use an RJ-45 null modem serial cable or an RJ-45 serial cable and null modem adapter. Plug this into the terminal’s serial port connector.

### 2. Attach the opposite end of the serial cable to the Sun Fire V490 system.

Plug the cable into the system’s built-in serial port (ttya) connector.

### 3. Connect the alphanumeric terminal’s power cord to an AC outlet.

### 4. Set the alphanumeric terminal to receive:

- At 9600 baud
- An 8-bit signal with no parity and 1 stop bit

See the documentation accompanying your terminal for information about how to configure it.

### 5. Decide whether you need to reset OpenBoot configuration variables.

Certain OpenBoot configuration variables control from where system console input is taken and to where its output is directed.

- *If you are installing a new system* – The default OpenBoot configuration variable settings will work properly. You are done with this procedure and can skip the remaining steps.
- *If you have previously altered OpenBoot configuration variable settings* – For example, to use the system controller as the system console, you need to change the OpenBoot configuration variables back to their default values. Continue with the next step from the existing system console.
- *If you are not sure whether OpenBoot configuration variable settings have been altered* – See “How to View and Set OpenBoot Configuration Variables” on page 180. Verify that the settings are as given in “Reference for System Console OpenBoot Variable Settings” on page 141. If not, reset them as described in the next step.

### 6. If necessary, reset OpenBoot configuration variables.

From the existing system console, type:

```
ok setenv diag-out-console false
ok setenv input-device ttya
ok setenv output-device ttya
```

---

**Note** – There are many other OpenBoot configuration variables, and although these do not affect which hardware device is used as the system console, some of them affect what diagnostic tests the system runs and what messages the system console displays. For details, see “Controlling POST Diagnostics” on page 82.

---

7. To cause the changes to take effect, type:

```
ok reset-all
```

The system permanently stores the parameter changes and boots automatically if the OpenBoot variable `auto-boot?` is set to `true` (its default value).

## What Next

You can issue system commands and view system messages on the ASCII terminal. Qualified service technicians can now continue with parts removal and installation, as needed.

---

**Note** – Do not attempt to access any internal components unless you are a qualified service technician. Detailed service instructions can be found in the *Sun Fire V490 Server Parts Installation and Removal Guide*, which is included on the Sun Fire V490 Documentation CD.

---

---

# How to Configure a Local Graphics Terminal as the System Console

## Before You Begin

After initial system installation, a qualified service technician can install a local graphics terminal and set it up as the system console. You *cannot* use a local graphics terminal to perform initial system installation, nor can you use a local graphics terminal to view power-on self-test (POST) messages. For detailed information about system console options, see “About Communicating With the System” on page 69.

To install a local graphics terminal, you must have:

- A supported PCI-based graphics frame buffer card and software driver
  - An 8-Bit Color Graphics PCI adapter frame buffer card (Sun part number X3660A is currently supported)
  - An 8/24-Bit Color Graphics PCI adapter frame buffer card (Sun part number X3768A is currently supported)
- A monitor with appropriate resolution
- A Sun-compatible USB keyboard (Sun USB Type-6 keyboard)
- A Sun-compatible USB mouse (Sun USB mouse) and mouse pad (if necessary)

## What to Do

### 1. Install the graphics card into an appropriate PCI slot.

Installation must be performed by a qualified service provider. For further information, see the *Sun Fire V490 Server Parts Installation and Removal Guide* or contact your qualified service provider.

### 2. Attach the monitor video cable to the graphics card's video port.

Tighten the thumbscrews to secure the connection.

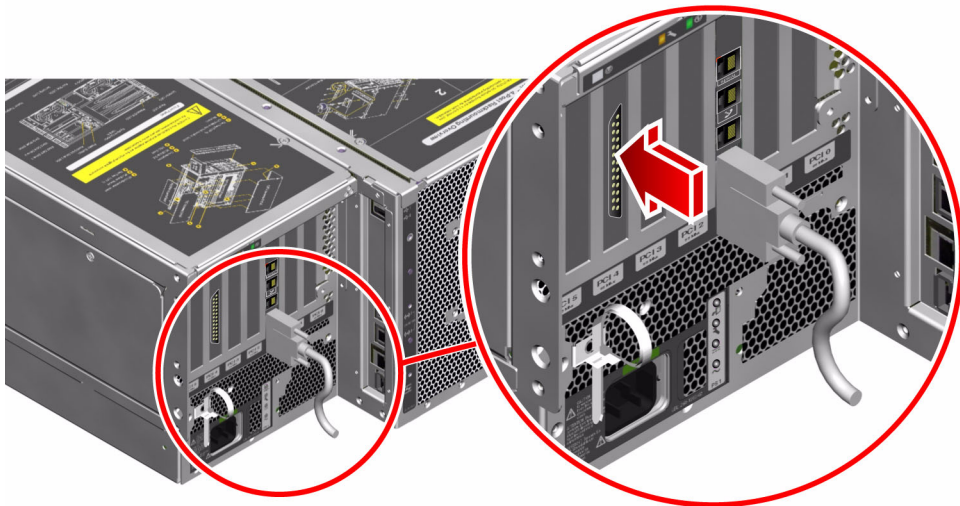

### 3. Connect the monitor's power cord to an AC outlet.

### 4. Connect the keyboard USB cable to any USB port on the back panel.

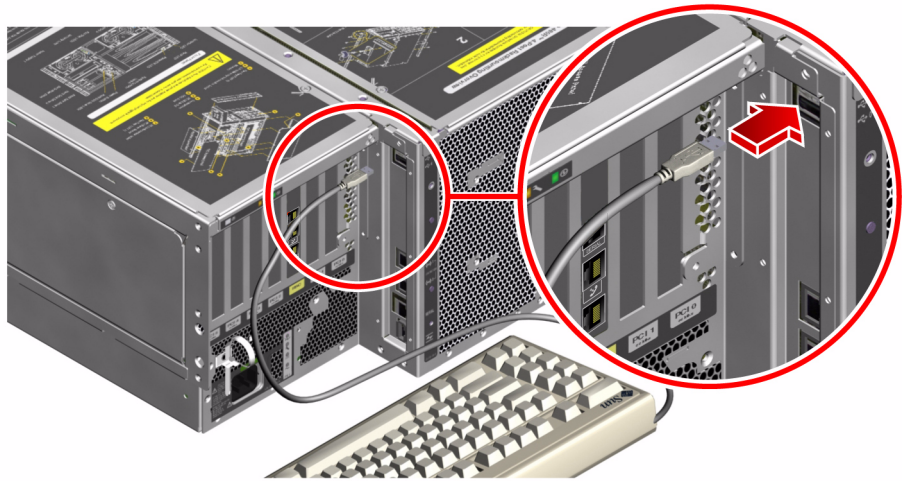

5. Connect the mouse USB cable to any USB port on the back panel.

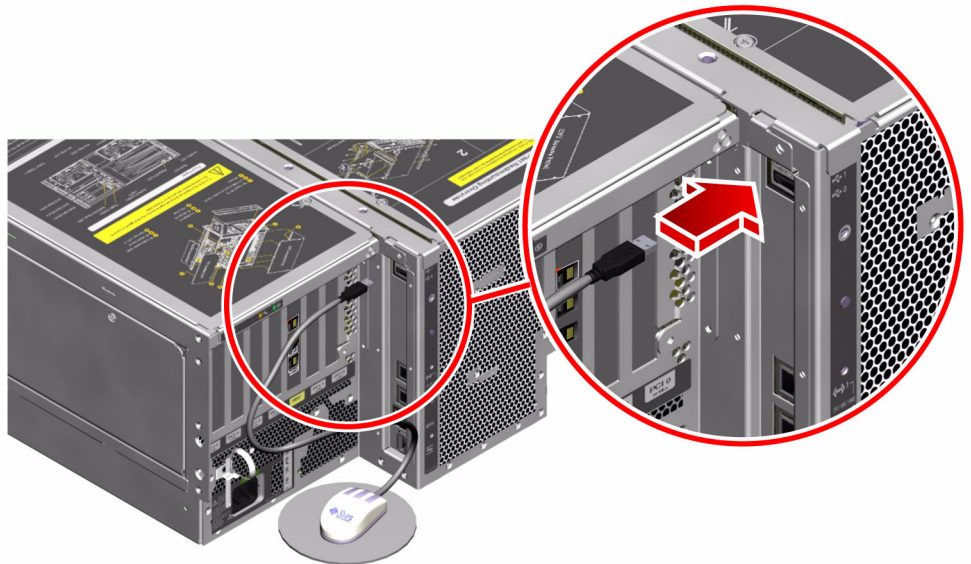

6. Set OpenBoot configuration variables appropriately.

From the existing system console, type:

```
ok setenv diag-out-console false
ok setenv input-device keyboard
ok setenv output-device screen
```

---

**Note** – There are many other OpenBoot configuration variables, and although these do not affect which hardware device is used as the system console, some of them affect what diagnostic tests the system runs and what messages the system console displays. For details, see “Controlling POST Diagnostics” on page 82.

---

7. To cause the changes to take effect, type:

```
ok reset-all
```

The system permanently stores the parameter changes and boots automatically if the OpenBoot variable `auto-boot?` is set to `true` (its default value).

## What Next

You can issue system commands and view system messages from your local graphics terminal. Continue with your diagnostic or other procedure as needed.

---

# How to Initiate a Reconfiguration Boot

After installing any new internal option or external storage device, you must perform a reconfiguration boot so that the operating system is able to recognize the newly installed device(s). In addition, if you remove any device and do not install a replacement device prior to rebooting the system, you must perform a reconfiguration boot in order for the operating system to recognize the configuration change. This requirement also applies to any component that is connected to the system’s I<sup>2</sup>C bus, including memory modules, CPU/Memory boards, and power supplies.

This requirement *does not* apply to any component that is:

- Installed or removed as part of a hot-plug or hot-swap operation
- Installed or removed before the operating system is installed
- Installed as an identical replacement for a component that is already recognized by the operating system

# Before You Begin



---

**Caution** – Before you power on the system, make sure that the system doors and all panels are properly installed.

---

To issue software commands, you need to set up a system ASCII terminal, a local graphics terminal, or a `tip` connection to the Sun Fire V490 system. See:

- “How to Set Up an Alphanumeric Terminal as the System Console” on page 133
- “How to Configure a Local Graphics Terminal as the System Console” on page 135
- “How to Access the System Console via `tip` Connection” on page 129

## What to Do

**1. Turn on power to any peripherals and external storage devices.**

Read the documentation supplied with the device for specific instructions.

**2. Turn on power to the ASCII terminal or local graphics terminal.**

**3. Insert the system key into the system control switch and turn the switch to the Diagnostics position.**

See “System Control Switch” on page 15 for information about control switch settings.

**4. Press the Power button below the control switch to power on the system.**

**5. Wait for the `ok` prompt to appear.**

The system may take anywhere from 15 to 30 minutes before the `ok` prompt appears. This time depends on the system configuration (number of processors, memory modules, PCI cards) being tested.

**6. Turn the system control switch to the Normal position.**

**7. At the `ok` prompt, type:**

```
ok reset-all
```

Depending on how the `auto-boot` OpenBoot configuration variable is set, the system may or may not start to reboot its operating system.

**8. If the operating system starts to reboot, do the following.**

**a. Wait until the system has completed initializing memory.**

During initialization, you see the message:

```
Initializing memory
```

**b. Watch carefully, as you will need to act quickly.**

Once the process is complete, the `Initializing memory` message is erased and the system displays a line similar to:

```
Boot device: disk2 File and args:
```

**c. At this point, abort the boot process as promptly as possible.**

To do this, use one of the following methods:

- Hold down the Stop (or L1) key and press A on your keyboard.
- Press the Break key on the terminal keyboard.
- Type `~#` in a `tip` window.

The system should return to the `ok` prompt.

---

**Note** – If the system does not return to the `ok` prompt, it means you did not abort quickly enough. If this occurs, wait for the system to reboot, force the system to return to the `ok` prompt, and repeat Step 7.

---

**9. At the `ok` prompt, type:**

```
ok boot -r
```

The `boot -r` command rebuilds the device tree for the system, incorporating any newly installed options so that the operating system will recognize them.

**10. Turn the control switch to the Locked position, remove the key, and keep it in a secure place.**

This prevents anyone from accidentally powering off the system.

## What Next

The system's front panel LED indicators provide power-on status information. For more information about the system LEDs, see:

- "LED Status Indicators" on page 13



---

# Reference for System Console OpenBoot Variable Settings

Certain OpenBoot configuration variables control from where system console input is taken and to where its output is directed. The table below shows how to set these variables in order to use `ttya`, the system controller, or a local graphics terminal as the system console.

**TABLE 7-2** OpenBoot Configuration Variables That Affect the System Console

OpenBoot Variable Name	Setting for Sending System Console Output to:		
	Serial Port ( <code>ttya</code> )	System Controller	Graphics Terminal <sup>1 2</sup>
<code>diag-out-console</code>	<code>false</code>	<code>true</code>	<code>false</code>
<code>output-device</code>	<code>ttya</code>	<code>rsc-console</code>	<code>screen</code>
<code>input-device</code>	<code>ttya</code>	<code>rsc-console</code>	<code>keyboard</code>

1 - POST output will still be directed to the serial port, as POST has no mechanism to direct its output to a graphics terminal.

2 - If the system detects no local graphics terminal, it directs all output to (and accepts input from) the serial port.

In addition to the above OpenBoot configuration variables, there are other variables that determine whether and what kinds of diagnostic tests run. These variables are discussed in “Controlling POST Diagnostics” on page 82.



# Configuring Network Interfaces and the Boot Device

---

This chapter provides information and instructions that are required to plan and to configure the supported network interfaces.

Tasks covered in this chapter include:

- “How to Configure the Primary Network Interface” on page 144
- “How to Configure Additional Network Interfaces” on page 146
- “How to Select the Boot Device” on page 149

---

**Note** – Many of the procedures in this chapter assume that you are familiar with the OpenBoot firmware and that you know how to enter the OpenBoot environment. For background information, see “About the ok Prompt” on page 49. For instructions, see “How to Get to the ok Prompt” on page 126.

---



---

**Caution** – Do not attempt to access any internal components unless you are a qualified service technician. Detailed service instructions can be found in the *Sun Fire V490 Server Parts Installation and Removal Guide*, which is included on the Sun Fire V490 Documentation CD.

---

---

# How to Configure the Primary Network Interface

## Before You Begin

You must perform this task:

- Complete the installation steps in Chapter 1.

For background information, see:

- “About the Network Interfaces” on page 47

If you are using a PCI network interface card, see the documentation supplied with the card.

## What to Do

1. **Choose a network port, using the following table as a guide.**

Ethernet Port	PCI Bus/Clock Rate	OpenBoot devalias	Device Path
1	PCI C/66 MHz	net1	/pci@9,600000/network@1
0	PCI D/33 MHz	net0	/pci@9,700000/network@2

2. **Attach an Ethernet cable to the port you selected.**

See “How to Attach a Twisted-Pair Ethernet Cable” on page 127.

3. **Choose a host name for the system and make a note of it.**

You need to furnish the name in a later step.

The host name must be unique within the network. It can consist only of alphanumeric characters and the dash (-). Do not use a dot in the host name. Do not begin the name with a number or a special character. The name must not be longer than 30 characters.

**4. Determine the unique Internet Protocol (IP) address of the network interface and make a note of it.**

You need to furnish the address in a later step.

An IP address must be assigned by the network administrator. Each network device or interface must have a unique IP address.

**5. Resume the installation of the system.**

Return to Chapter 1.

---

**Note** – During installation of the Solaris OS, the software automatically detects the system’s on-board network interfaces and any installed PCI network interface cards for which native Solaris device drivers exist. The operating system then asks you to select one of the interfaces as the primary network interface and prompts you for its host name and IP address. You can configure only one network interface during installation of the operating system. You must configure any additional interfaces separately, after the operating system is installed. For more information, see “How to Configure Additional Network Interfaces” on page 146.

---

## What Next

After completing this procedure, the primary network interface is ready for operation. However, in order for other network devices to communicate with the system, you must enter the system’s IP address and host name into the namespace on the network name server. For information about setting up a network name service, consult:

- *Solaris Naming Configuration Guide* for your specific Solaris release

The device driver for the system’s on-board Sun GigaSwift Ethernet interfaces is automatically installed with the Solaris release. For information about operating characteristics and configuration parameters for this driver, refer to the following document:

- *Platform Notes: The Sun GigaSwift Ethernet Device Driver*

This document is available on the Solaris Software Supplement CD for your specific Solaris release.

If you want to set up an additional network interface, you must configure it separately, after installing the operating system. See:

- “How to Configure Additional Network Interfaces” on page 146

---

**Note** – The Sun Fire V490 system conforms to the Ethernet 10/100BASE-T standard, which states that the Ethernet 10BASE-T link integrity test function should always be enabled on both the host system and the Ethernet hub. If you have problems establishing a connection between this system and your hub, verify that the Ethernet hub also has the link test function enabled. Consult the manual provided with your hub for more information about the link integrity test function.

---

---

# How to Configure Additional Network Interfaces

## Before You Begin

Perform the following tasks to prepare an additional network interface:

- Install the Sun Fire V490 server as described in Chapter 1.
- If you are setting up a redundant network interface, see “About Redundant Network Interfaces” on page 48.
- If you need to install a PCI network interface card, follow the installation instructions in the *Sun Fire V490 Server Parts Installation and Removal Guide*.
- Attach an Ethernet cable to the appropriate port on the system back panel. See “How to Attach a Twisted-Pair Ethernet Cable” on page 127. If you are using a PCI network interface card, see the documentation supplied with the card.

---

**Note** – All internal options (except disk drives and power supplies) must be installed by qualified service personnel. Installation procedures for these components are covered in the *Sun Fire V490 Server Parts Installation and Removal Guide*, which is included on the Sun Fire V490 Documentation CD.

---

# What to Do

## 1. Choose a network host name for each new interface.

The host name must be unique within the network. It can consist only of alphanumeric characters and the dash (-). Do not use a dot in the host name. Do not begin the name with a number or a special character. The name must not be longer than 30 characters.

Usually an interface host name is based on the machine host name. For example, if the machine is assigned the host name `sunrise`, the added network interface could be named `sunrise-1`. The machine's host name is assigned when Solaris software is installed. For more information, see the installation instructions accompanying the Solaris software.

## 2. Determine the Internet Protocol (IP) address for each new interface.

An IP address must be assigned by your network administrator. Each interface on a network must have a unique IP address.

## 3. Boot the operating system (if it is not already running) and log on to the system as superuser.

Be sure to perform a reconfiguration boot if you just added a new PCI network interface card. See “How to Initiate a Reconfiguration Boot” on page 138.

Type the `su` command at the system prompt, followed by the superuser password:

```
% su
Password:
```

## 4. Create an appropriate `/etc/hostname` file for each new network interface.

The name of the file you create should be of the form `/etc/hostname.ce $num$` , where `ce` is the network interface type identifier and `num` is the device instance number of the interface according to the order in which it was installed in the system.

For example, the file names for the system's on-board Sun GigaSwift Ethernet interfaces are `/etc/hostname.ce0` and `/etc/hostname.ce1`, respectively. If you add a PCI Ethernet adapter card as a third `ce` interface, its file name should be `/etc/hostname.ce2`. At least one of these files—the primary network interface—should exist already, having been created automatically during the Solaris installation process.

---

**Note** – The documentation accompanying the network interface card should identify its type. Alternatively, you can enter the `show-devs` command from the `ok` prompt to obtain a list of all installed devices.

---

**5. Edit the `/etc/hostname` file(s) created in Step 4 to add the host name(s) determined in Step 1.**

Following is an example of the `/etc/hostname` files required for a system called `sunrise`, which has two on-board Sun GigaSwift Ethernet interfaces (`ce0` and `ce1`) and a PCI Ethernet adapter card (`ce2`). A network connected to the on-board `ce0` and `ce1` interfaces will know the system as `sunrise` and `sunrise-1`, while networks connected to the PCI-based `ce2` interface will know the system as `sunrise-2`.

```
sunrise # cat /etc/hostname.ce0
sunrise
sunrise # cat /etc/hostname.ce1
sunrise-1
sunrise # cat /etc/hostname.ce2
sunrise-2
```

**6. Create an entry in the `/etc/hosts` file for each active network interface.**

An entry consists of the IP address and the host name for each interface.

The following example shows an `/etc/hosts` file with entries for the three network interfaces used as examples in this procedure.

```
sunrise # cat /etc/hosts
#
# Internet host table
#
127.0.0.1    localhost
129.144.10.57 sunrise loghost
129.144.14.26 sunrise-1
129.144.11.83 sunrise-2
```

**7. Manually plumb and enable each new interface using the `ifconfig` command.**

For example, for the interface `ce2`, type:

```
sunrise # ifconfig ce2 plumb up
```

For more information, see the `ifconfig(1M)` man page.



## What Next

After completing this procedure, any new network interfaces are ready for operation. However, in order for other network devices to communicate with the system through the new interface, the IP address and host name for each new interface must be entered into the namespace on the network name server. For information about setting up a network name service, consult:

- *Solaris Naming Configuration Guide* for your specific Solaris release

The `ce` device driver for the system's on-board Sun GigaSwift Ethernet interfaces is automatically configured during Solaris installation. For information about operating characteristics and configuration parameters for these drivers, refer to

- *Platform Notes: The Sun GigaSwift Ethernet Device Driver*

This document is available on the Solaris Software Supplement CD for your specific Solaris release.

---

**Note** – The Sun Fire V490 system conforms to the Ethernet 10/100BASE-T standard, which states that the Ethernet 10BASE-T link integrity test function should always be enabled on both the host system and the Ethernet hub. If you have problems establishing a connection between this system and your Ethernet hub, verify that the hub also has the link test function enabled. Consult the manual provided with your hub for more information about the link integrity test function.

---

---

## How to Select the Boot Device

The boot device is specified by the setting of an OpenBoot firmware configuration parameter called `boot-device`. The default setting of this parameter is `disk net`.

Because of this setting, the firmware first attempts to boot from the system hard drive, and if that fails, from the on-board Sun GigaSwift Ethernet

### interface. **Before You Begin**

Before you can select a boot device, you must complete system installation according to the instructions in Chapter 1.

Specifically, you must set up a system console and power on the system. See:

- “How to Set Up an Alphanumeric Terminal as the System Console” on page 133
- “How to Configure a Local Graphics Terminal as the System Console” on page 135
- “How to Power On the System” on page 122

If you want to boot from a network, you must also connect the network interface to the network and configure the network interfaces. See:

- “How to Attach a Twisted-Pair Ethernet Cable” on page 127
- “How to Configure the Primary Network Interface” on page 144
- “How to Configure Additional Network Interfaces” on page 146

## What to Do

This procedure assumes that you are familiar with the OpenBoot firmware and that you know how to enter the OpenBoot environment. For more information, see “About the `ok` Prompt” on page 49.

● **At the `ok` prompt, type:**

```
ok setenv boot-device device-specifier
```

where the *device-specifier* is one of the following:

- `cdrom` – Specifies the DVD-ROM drive
- `disk` – Specifies the system boot disk
- `disk0` – Specifies internal disk 0
- `disk1` – Specifies internal disk 1
- `net`, `net0`, `net1` – Specifies the network interfaces
- *full path name* – Specifies the device or network interface by its full path name

---

**Note** – You can also specify the name of the program to be booted as well as the way the boot program operates. For more information, see the *OpenBoot 4.x Command Reference Manual*, included with the Solaris Software Supplement CD that ships with Solaris software.

---

If you want to specify a network interface other than an on-board Ethernet interface as the default boot device, you can determine the full path name of each interface by typing:

```
ok show-devs
```

The `show-devs` command lists the system devices and displays the full path name of each PCI device.

## What Next

For more information about using the OpenBoot firmware, see:

- *OpenBoot 4.x Command Reference Manual*, included with the Solaris Software Supplement CD that ships with Solaris software. This manual is also available at the Web site <http://docs.sun.com> under Solaris on Sun Hardware.



# Configuring System Firmware

---

This chapter describes OpenBoot firmware commands and configuration variables available for configuring the following aspects of Sun Fire V490 system behavior:

- OpenBoot environmental monitoring
- Automatic system recovery (ASR)

In addition, this chapter provides information about keyboard commands and alternative methods for performing OpenBoot emergency procedures.

Tasks covered in this chapter include:

- “How to Enable OpenBoot Environmental Monitoring” on page 154
- “How to Disable OpenBoot Environmental Monitoring” on page 154
- “How to Obtain OpenBoot Environmental Status Information” on page 155
- “How to Enable the Watchdog Mechanism and Its Options” on page 156
- “How to Enable ASR” on page 157
- “How to Disable ASR” on page 158
- “How to Obtain ASR Status Information” on page 158
- “How to Redirect the System Console to the System Controller” on page 159
- “How to Restore the Local System Console” on page 161
- “How to Deconfigure a Device Manually” on page 162
- “How to Reconfigure a Device Manually” on page 163
- “How to Implement Stop-N Functionality” on page 164

---

**Note** – Many of the procedures in this chapter assume that you are familiar with the OpenBoot firmware and that you know how to enter the OpenBoot environment. For background information, see “About the `ok` Prompt” on page 49. For instructions, see “How to Get to the `ok` Prompt” on page 126.

---

---

# How to Enable OpenBoot Environmental Monitoring

## Before You Begin

For background information about the OpenBoot environmental monitor, see:

- “About OpenBoot Environmental Monitoring” on page 52

## What to Do

- **To enable OpenBoot environmental monitoring, type `env-on` at the `ok` prompt:**

```
ok env-on
Environmental monitor is ON
ok
```

## What Next

To disable OpenBoot environmental monitoring, complete this task:

- “How to Disable OpenBoot Environmental Monitoring” on page 154

---

# How to Disable OpenBoot Environmental Monitoring

## Before You Begin

For background information about the OpenBoot environmental monitor, see:

- “About OpenBoot Environmental Monitoring” on page 52

## What to Do

- To disable OpenBoot environmental monitoring, type `env-off` at the `ok` prompt:

```
ok env-off
Environmental monitor is OFF
ok
```

---

# How to Obtain OpenBoot Environmental Status Information

## Before You Begin

For background information about environmental status information, see:

- “OpenBoot Environmental Status Information” on page 53

## What to Do

- To obtain OpenBoot environmental status information, type `.env` at the `ok` prompt:

```
ok .env
```

---

# How to Enable the Watchdog Mechanism and Its Options

## Before You Begin

For background information about the hardware watchdog mechanism and related externally initiated reset (XIR) functionality, see:

- “Hardware Watchdog Mechanism and XIR” on page 23

## What to Do

1. **Edit the `/etc/system` file to include the following entry.**

```
set watchdog_enable = 1
```

2. **Choose the desired system recovery behavior.**

The hardware watchdog mechanism can automatically reboot the system in case the system hangs. This can be done with or without first generating an automated crash dump file. As superuser, do one of the following:

- To reboot *without* generating an automated crash dump file, type:

```
# eeprom error-reset-recovery=boot
```

- To reboot and generate an automated crash dump file, type:

```
# eeprom error-reset-recovery=sync
```

- To have the system *not* automatically reboot, but rather wait at the OpenBoot prompt for manual intervention and recovery, type:

```
# eeprom error-reset-recovery=none
```



3. Restart the system to effect the changes. Type:

```
# reboot
```

## What Next

If you choose to have the system generate an automated crash dump file, then, in the event the operating system hangs, that file appears in the `/var/crash/` directory, under a subdirectory named after your system. For more information, see the documentation accompanying your Solaris software release.

---

## How to Enable ASR

The automatic system recovery (ASR) feature is activated by default. However, if you have manually disabled it, use this procedure to restore it.

## What to Do

1. Set the system control switch to the Normal position.
2. At the system `ok` prompt, type:

```
ok setenv service-mode? false
ok setenv auto-boot? true
ok setenv auto-boot-on-error? true
```

3. Set the `diag-trigger` variable either to `power-on-reset`, `error-reset`, (the default) or to `all-resets`. For example, type:

```
ok setenv diag-trigger all-resets
```

4. To cause the parameter changes to take effect, type:

```
ok reset-all
```

The system permanently stores the parameter changes and boots automatically if the OpenBoot variable `auto-boot?` is set to `true` (its default value).

## What Next

To disable ASR, complete this task:

- “How to Disable ASR” on page 158

---

## How to Disable ASR

After you disable the automatic system recovery (ASR) feature, it is not activated again until you enable it at the system `ok` prompt.

### What to Do

1. At the system `ok` prompt, type:

```
ok setenv auto-boot-on-error? false
```

2. To cause the parameter change to take effect, type:

```
ok reset-all
```

The system permanently stores the parameter change.

---

## How to Obtain ASR Status Information

Use the following procedure to retrieve information about the status of the automatic system recovery (ASR) feature.

# What to Do

1. At the system `ok` prompt, type:

```
ok .asr
```

In the `.asr` command output, any devices marked `disabled` have been manually deconfigured using the `asr-disable` command. The `.asr` command also lists devices that have failed firmware diagnostics and have been automatically deconfigured by the OpenBoot ASR feature.

2. Display components that have failed POST diagnostics. Type:

```
ok show-post-results
```

3. Display components that have failed OpenBoot diagnostics tests. Type:

```
ok show-obdiag-results
```

## What Next

For more information, see:

- “About Automatic System Recovery” on page 55
- “How to Enable ASR” on page 157
- “How to Disable ASR” on page 158
- “How to Deconfigure a Device Manually” on page 162
- “How to Reconfigure a Device Manually” on page 163

---

## How to Redirect the System Console to the System Controller

Perform this procedure if, after installing the Solaris OS and the Sun Remote System Controller (RSC) software, you want to configure the system to use the system controller as the system console. For more information about RSC software, see:

- “About the System Controller (SC) Card” on page 33
- *Sun Remote System Controller (RSC) User’s Guide*

# What to Do

## 1. Establish a system controller session.

For instructions, see the *Sun Remote System Controller (RSC) User's Guide*, which is included on the Sun Fire V490 Documentation CD.

## 2. At the system `ok` prompt, type:

```
ok setenv diag-out-console true
ok setenv input-device rsc-console
ok setenv output-device rsc-console
```

## 3. To cause the changes to take effect, type:

```
ok reset-all
```

The system permanently stores the parameter changes and boots automatically if the OpenBoot variable `auto-boot?` is set to `true` (its default value).

## 4. To connect to the system console, at the system controller prompt, type:

```
rsc> console
```

---

**Note** – To reverse the system controller console redirection manually and *temporarily* by resetting OpenBoot configuration variables, follow the instructions in “About OpenBoot Emergency Procedures” on page 54. Otherwise follow the system controller console exit steps in the section, “How to Restore the Local System Console” on page 161.

---

# What Next

For instructions on how to use RSC software, see:

- *Sun Remote System Controller (RSC) User's Guide*, which is included on the Sun Fire V490 Documentation CD

---

# How to Restore the Local System Console

Perform this procedure if your system is configured to use the system controller (SC) as the system console and you need to redirect the system console to a local graphics terminal, alphanumeric terminal, or an established `tip` connection. For more information about RSC software, see:

- “About the System Controller (SC) Card” on page 33
- *Sun Remote System Controller (RSC) User’s Guide*

## What to Do

### 1. Set the input and output device. Do one of the following.

- To restore the local console to the `ttya` port, type:

```
ok setenv input-device ttya
ok setenv output-device ttya
ok setenv diag-out-console false
```

The above settings are appropriate for viewing system console output on either an alphanumeric terminal or a `tip` line connected to serial port `ttya`.

- To restore local console to a graphics terminal, type:

```
ok setenv input-device keyboard
ok setenv output-device screen
ok setenv diag-out-console false
```

The above settings are appropriate for viewing system console output on a graphics terminal connected to a frame buffer card.

### 2. To cause the changes to take effect, type:

```
ok reset-all
```

The system permanently stores the parameter changes and boots automatically if the OpenBoot variable `auto-boot?` is set to `true` (its default value).

## What Next

You can now issue commands and view system messages on the local console.

---

# How to Deconfigure a Device Manually

## Before You Begin

To support the ability to boot even when nonessential components fail, the OpenBoot firmware provides the `asr-disable` command, which lets you manually deconfigure system devices. This command “marks” a specified device as *disabled*, by creating an appropriate “status” property in the corresponding device tree node. By convention, UNIX will not activate a driver for any device so marked. For background information, see

- “About Manually Configuring Devices” on page 59

## What to Do

1. At the system `ok` prompt, type:

```
ok asr-disable device-identifier
```

where the *device-identifier* is one of the following:

- Any full physical device path as reported by the OpenBoot `show-devs` command
- Any valid device alias as reported by the OpenBoot `devalias` command
- An identifier for a device given in “Reference for Device Identifiers” on page 61

---

**Note** – Manually deconfiguring a single processor causes the entire CPU/Memory board to be deconfigured, including all processors and all memory residing on the board.

---

OpenBoot configuration variable changes take effect after the next system reset.

2. To effect the changes immediately, type:

```
ok reset-all
```

---

**Note** – To immediately effect the changes, you can also power cycle the system using the front panel Power button

---

# How to Reconfigure a Device Manually

## Before You Begin

You can use the OpenBoot `asr-enable` command to reconfigure any device that you previously deconfigured with `asr-disable`. For background information, see

- “About Manually Configuring Devices” on page 59

## What to Do

1. At the system `ok` prompt, type:

```
ok asr-enable device-identifier
```

where the *device-identifier* is one of the following:

- Any full physical device path as reported by the OpenBoot `show-devs` command
- Any valid device alias as reported by the OpenBoot `devalias` command
- An identifier for a device or a range of devices given in “Reference for Device Identifiers” on page 61

2. Do one of the following:

- If you are reconfiguring a processor, power cycle the system using the front panel Power button.
- If you are reconfiguring any other device, type:

```
ok reset-all
```

---

**Note** – To reconfigure a processor, you must power cycle the system. The `reset-all` command will not suffice to bring the processor back online.

---

# How to Implement Stop-N Functionality

## Before You Begin

This procedure implements Stop-N functionality on Sun Fire V490 systems, temporarily resetting OpenBoot configuration variables to their default settings. This procedure is most useful if you have not configured your Sun Fire V490 system to run diagnostic tests. You might find it more convenient to use the alternative method of placing the system control switch in the Diagnostics position. For more background, see:

- “About OpenBoot Emergency Procedures” on page 54

For information about the system control switch, see:

- “System Control Switch” on page 15

## What to Do

- 1. Turn on the power to the system.**

If POST diagnostics are configured to run, both the Fault and Locator LEDs on the front panel will blink slowly.

- 2. Wait until *only* the system Fault LED begins to blink *rapidly*.**

---

**Note** – If you have configured the Sun Fire V490 system to run diagnostic tests, this could take upwards of 30 minutes.

---



**3. Press the front panel Power button twice, with no more than a short, one-second delay in between presses.**

A screen similar to the following is displayed to indicate that you have temporarily reset OpenBoot configuration variables to their default values:

```
Setting NVRAM parameters to default values.

Probing I/O buses

Sun Fire V490, No Keyboard
Copyright 1998-2004 Sun Microsystems, Inc. All rights reserved.
OpenBoot x.x, xxxx MB memory installed, Serial #xxxxxxxx.
Ethernet address x:x:x:x:x:x, Host ID: xxxxxxxx.

System is operating in Safe Mode and initialized with factory
default configuration. No actual NVRAM configuration variables
have been changed; values may be displayed with 'printenv' and set
with 'setenv'. System will resume normal initialization and
configuration after the next hardware or software reset.

ok
```

---

**Note** – Once the front panel LEDs stop blinking and the Power/OK LED stays lit, pressing the Power button again will begin a graceful shutdown of the system.

---

## What Next

During the execution of OpenBoot firmware code, all OpenBoot configuration variables—including the ones that are likely to cause problems, such as input and output device settings—are temporarily set to “safe” factory default values. The only exception to this is auto-boot, which is set to false.

By the time the system displays the `ok` prompt, OpenBoot configuration variables have been returned to their original, and possibly misconfigured, values. These values do not take effect until the system is reset. You can display them with the `printenv` command and manually change them with the `setenv` command.

If you do nothing other than reset the system at this point, no values are permanently changed. All your customized OpenBoot configuration variable settings are retained, even ones that may have caused problems.

To correct such problems, you must either manually change individual OpenBoot configuration variables using the `setenv` command, or else type `set-defaults` to permanently restore the default settings for all OpenBoot configuration variables.

## Isolating Failed Parts

---

The most important use of diagnostic tools is to isolate a failed hardware component so that a qualified service technician can quickly remove and replace it. Because servers are complex machines with many failure modes, there is no single diagnostic tool that can isolate all hardware faults under all conditions. However, Sun provides a variety of tools that can help you discern what component needs replacing.

This chapter guides you in choosing the best tools and describes how to use these tools to reveal a failed part in your Sun Fire V490 server. It also explains how to use the Locator LED to isolate a failed system in a large equipment room.

Tasks covered in this chapter include:

- “How to Operate the Locator LED” on page 168
- “How to Put the Server in Service Mode” on page 170
- “How to Put the Server in Normal Mode” on page 171
- “How to Isolate Faults Using LEDs” on page 172
- “How to Isolate Faults Using POST Diagnostics” on page 175
- “How to Isolate Faults Using Interactive OpenBoot Diagnostics Tests” on page 177
- “How to View Diagnostic Test Results After the Fact” on page 179
- “How to View and Set OpenBoot Configuration Variables” on page 180

Other information in this chapter includes:

- “Reference for Choosing a Fault Isolation Tool” on page 181

If you want background information about the tools, turn to the section:

- “About Isolating Faults in the System” on page 100

---

**Note** – Many of the procedures in this chapter assume that you are familiar with the OpenBoot firmware and that you know how to enter the OpenBoot environment. For background information, see “About the `ok` Prompt” on page 49. For instructions, see “How to Get to the `ok` Prompt” on page 126.

---



---

**Caution** – Do not attempt to access any internal components unless you are a qualified service technician. Detailed service instructions can be found in the *Sun Fire V490 Server Parts Installation and Removal Guide*, which is included on the Sun Fire V490 Documentation CD.

---

---

## How to Operate the Locator LED

The Locator LED helps you quickly to find a specific system among dozens of systems in a room. For background information about system LEDs, see “LED Status Indicators” on page 13.

You can turn the Locator LED on and off either from the system console, the system controller (SC) command-line interface (CLI), or by using RSC software’s graphical user interface (GUI).

---

**Note** – It is also possible to use Sun Management Center software to turn the Locator LED on and off. Consult Sun Management Center documentation for details.

---

### Before You Begin

Either log in as root, or access the RSC software’s graphical user interface.

### What to Do

1. **Turn the Locator LED on.**

Do one of the following:

- **As root, type:**

```
# /usr/sbin/locator -n
```

- **At the SC command-line interface, type:**

```
rsc> setlocator on
```

- **From the RSC software's main GUI screen, click the representation of the Locator LED.**

See the illustration under Step 5 in “How to Monitor the System Using the System Controller and RSC Software. With each click, the LED will change state from *off* to *on*, or vice versa.

## 2. Turn the Locator LED *off*.

Do one of the following:

- **As root, type:**

```
# /usr/sbin/locator -f
```

- **At the system console as accessed through the system controller, type:**

```
rsc> setlocator off
```

- **From the RSC software's main GUI screen, click the representation of the Locator LED.**

See the illustration under Step 5 in “How to Monitor the System Using the System Controller and RSC Software. With each click, the LED will change state from *on* to *off*, or vice versa.

---

# How to Put the Server in Service Mode

## Before You Begin

In normal mode, firmware-based diagnostic tests can be configured (and even disabled) to expedite the server's startup process. If you have set OpenBoot configuration variables to bypass diagnostic tests, you can always reset those variables to their default values to run tests.

Alternatively, putting the server into service mode according to the following procedure ensures that POST and OpenBoot Diagnostics tests *do run* during startup.

For a full description of service mode, see:

- *OpenBoot PROM Enhancements for Diagnostic Operation*

This document is included on the Sun Fire V490 Documentation CD.

## What to Do

### 1. Set up a console for viewing diagnostic messages.

Access the system console using an ASCII terminal or `tip` line. For information on system console options, see "About Communicating With the System" on page 69.

### 2. Do one of the following, whichever is more convenient:

- Set the server's system control switch to the Diagnostics position.
- Set the `service-mode?` OpenBoot configuration variable to `true`. **Type:**

```
ok setenv service-mode? true
```

If either of these switches is set as described, the next reset will cause diagnostic tests to run at Sun-specified coverage, levels, and verbosity.

### 3. Type:

```
ok reset-all
```

## What Next

Should you want to restore the system to normal mode in order to control the depth of diagnostic coverage, the tests run, and the verbosity of the output, see:

- “How to Put the Server in Normal Mode” on page 171.

---

# How to Put the Server in Normal Mode

## Before You Begin

If you have set the server to run in service mode, you can follow this procedure to return the system to normal mode. Putting the system in normal mode allows you control over diagnostic testing. For more information, see:

- “Controlling POST Diagnostics” on page 82.

## What To Do

**1. Set up a console for viewing diagnostic messages.**

Access the system console using an ASCII terminal or `tip` line. For information on system console options, see “About Communicating With the System” on page 69.

**2. Turn the system control switch to the Normal position.**

**3. At the `ok` prompt, type:**

```
ok setenv service-mode? false
```

The system will not actually enter normal mode until the next reset.

**4. Type:**

```
ok reset-all
```

## What Next

For detailed descriptions of service and normal modes, see:

- *OpenBoot PROM Enhancements for Diagnostic Operation*

This document is included on the Sun Fire V490 Documentation CD.

---

## How to Isolate Faults Using LEDs

While not a deep, formal diagnostic tool, LEDs located on the chassis and on selected system components can serve as front-line indicators of a limited set of hardware failures.

### Before You Begin

You can view LED status by direct inspection of the system's front or back panels.

---

**Note** – Most LEDs available on the front panel are also duplicated on the back panel.

---

You can also view LED status remotely using RSC and Sun Management Center software, if you set up these tools ahead of time. For details on setting up RSC and Sun Management Center software, see:

- *Sun Remote System Controller (RSC) User's Guide*
- *Sun Management Center Software User's Guide*



# What to Do

## 1. Check the system LEDs.

There is a group of three LEDs located near the top left corner of the front panel and duplicated on the back panel. Their status can tell you the following.

LED	Indicates	Action
Locator (left)	A system administrator can turn this on to flag a system that needs attention.	Identify the system.
Fault (middle)	If lit, hardware or software has detected a problem with the system.	Check other LEDs or run diagnostics to determine the problem source.
Power/OK (right)	If off, power is not reaching the system from the power supplies.	Check AC power source and check the power supplies.

The Locator and Fault LEDs are powered by the system's 5-volt standby power source and remain lit for any fault condition that results in a system shutdown.

## 2. Check the power supply LEDs.

Each power supply has a set of four LEDs located on the front panel and duplicated on the back panel. Their status can tell you the following.

LED	Indicates	Action
OK-to-Remove (top)	If lit, power supply can safely be removed.	Remove power supply as needed.
Fault (2nd from top)	If lit, there is a problem with the power supply or one of its internal fans.	Replace the power supply.
DC Present (3rd from top)	If off, inadequate DC power is being produced by the supply.	Remove and reseal the power supply. If this does not help, replace the supply.
AC Present (bottom)	If off, AC power is not reaching the supply.	Check power cord and the outlet to which it connects.

## 3. Check the fan tray LEDs.

There are two LEDs located behind the media door, just under the system control switch. One LED on the left is for Fan Tray 0 (CPU) and one LED on the right is for Fan Tray 1 (PCI). If either is lit, it indicates that the corresponding fan tray needs reseating or replacement.

#### 4. Check the disk drive LEDs.

There are two sets of three LEDs, one for each disk drive. These are located behind the media door, just to the left of each disk drive. Their status can tell you the following.

LED	Indicates	Action
OK-to-Remove (top)	If lit, disk can safely be removed.	Remove disk as needed.
Fault (middle)	If lit, there is a problem with the disk.	Perform software commands to take the disk offline. See the <i>Sun Fire V490 Server Parts Installation and Removal Guide</i> .
Activity (bottom)	If lit or blinking, disk is operating normally.	Not applicable.

#### 5. (Optional) Check the Ethernet LEDs.

There are two LEDs for each Ethernet port—they are close to the right side of each Ethernet receptacle on the back panel. If the Sun Fire V490 system is connected to an Ethernet network, the status of the Ethernet LEDs can tell you the following.

LED	Indicates	Action
Activity (top, amber)	If lit or blinking, data is either being transmitted or received.	None. The condition of these LEDs can help you narrow down the source of a network problem.
Link Up (bottom, green)	If lit, a link is established with a link partner.	

## What Next

If LEDs do not disclose the source of a suspected problem, try running power-on self-tests (POST). See:

- “How to Isolate Faults Using POST Diagnostics” on page 175

---

# How to Isolate Faults Using POST Diagnostics

This section explains how to run power-on self-test (POST) diagnostics to isolate faults in a Sun Fire V490 server. For background information about POST diagnostics and the boot process, see Chapter 6.

## Before You Begin

You must ensure that the system is configured to run diagnostic tests. See:

- “Controlling POST Diagnostics” on page 82

You must additionally decide whether you want to view POST diagnostic output locally, via a terminal or `tip` connection to the machine’s serial port, or remotely after redirecting system console output to the system controller (SC).

---

**Note** – A server can have only one system console at a time, so if you redirect output to the system controller, no information appears at the serial port (`ttya`).

---

## What to Do

### 1. Set up a console for viewing POST messages.

Connect an alphanumeric terminal to the Sun Fire V490 server or establish a `tip` connection to another Sun system. See:

- “How to Set Up an Alphanumeric Terminal as the System Console” on page 133
- “How to Access the System Console via `tip` Connection” on page 129

### 2. (Optional) Redirect console output to the system controller, if desired.

For instructions, see “How to Redirect the System Console to the System Controller” on page 159.

### 3. Start POST diagnostics. Type:

```
ok post
```

The system runs the POST diagnostics and displays status and error messages via either the local serial terminal (ttya) or the redirected (system controller) system console.

### 4. Examine the POST output.

Each POST error message includes a “best guess” as to which field-replaceable unit (FRU) was the source of failure. In some cases, there may be more than one possible source, and these are listed in order of decreasing likelihood.

---

**Note** – Should the POST output contain code names and acronyms with which you are unfamiliar, see TABLE 6-13 in “Reference for Terms in Diagnostic Output” on page 114.

---

## What Next

Have a qualified service technician replace the FRU or FRUs indicated by POST error messages, if any. For replacement instructions, see:

- *Sun Fire V490 Server Parts Installation and Removal Guide*, which is included on the Sun Fire V490 Documentation CD

If the POST diagnostics did not disclose any problems, but your system does not start, try running the interactive OpenBoot Diagnostics tests.

---

# How to Isolate Faults Using Interactive OpenBoot Diagnostics Tests

## Before You Begin

Because OpenBoot Diagnostics tests require access to some of the same hardware resources used by the operating system, they cannot be operated reliably after an operating system halt or Stop-A key sequence. You need to reset the system before running OpenBoot Diagnostics tests, and then reset the system again after testing. Instructions for doing this follow.

This procedure assumes you have established a system console. See:

- “About Communicating With the System” on page 69

## What to Do

### 1. Halt the server to reach the `ok` prompt.

How you do this depends on the system’s condition. If possible, you should warn users and shut down the system gracefully. For information, see “About the `ok` Prompt” on page 49.

### 2. Set the `auto-boot?` diagnostic configuration variable to `false`. Type:

```
ok setenv auto-boot? false
```

### 3. Reset or power cycle the system.

### 4. Invoke the OpenBoot Diagnostics tests. Type:

```
ok obdiag
```

The `obdiag` prompt and test menu appear. The menu is shown in FIGURE 6-4.

**5. Type the appropriate command and numbers for the tests you want to run.**

For example, to run all available OpenBoot Diagnostics tests, type:

```
obdiag> test-all
```

To run a particular test, type:

```
obdiag> test #
```

where # represents the number of the desired test.

For a list of OpenBoot Diagnostics test commands, see “Interactive OpenBoot Diagnostics Commands” on page 87. The numbered menu of tests is shown in FIGURE 6-4.

**6. When you are done running OpenBoot Diagnostics tests, exit the test menu. Type:**

```
obdiag> exit
```

The ok prompt reappears.

**7. Set the auto-boot? diagnostic configuration variable back to true. Type:**

```
ok setenv auto-boot? true
```

This allows the operating system to resume starting up automatically after future system resets or power cycles.

## What Next

Have a qualified service technician replace the FRU or FRUs indicated by OpenBoot Diagnostics error messages, if any. For replacement instructions, see:

- *Sun Fire V490 Server Parts Installation and Removal Guide*

This document is included on the Sun Fire V490 Documentation CD.

---

# How to View Diagnostic Test Results After the Fact

Summaries of the results from the most recent power-on self-test (POST) and OpenBoot Diagnostics tests are saved across power cycles.

## Before You Begin

You must set up a system console. See:

- “About Communicating With the System” on page 69

Then halt the server to reach the `ok` prompt. See:

- “About the `ok` Prompt” on page 49

## What to Do

- To see a summary of the most recent POST results, type:

```
ok show-post-results
```

- To see a summary of the most recent OpenBoot Diagnostics test results, type:

```
ok show-obdiag-results
```

## What Next

You should see a system-dependent list of hardware components, along with an indication of which components passed and which failed POST or OpenBoot Diagnostics tests.

---

# How to View and Set OpenBoot Configuration Variables

Switches and diagnostic configuration variables stored by the system firmware determine how and when power-on self-test (POST) diagnostics and OpenBoot Diagnostics tests are performed. This section explains how to access and modify OpenBoot configuration variables. For a list of important OpenBoot configuration variables, see TABLE 6-2.

## Before You Begin

Halt the server to reach the `ok` prompt. See:

- “About the `ok` Prompt” on page 49

## What to Do

- **To display the current values of all OpenBoot configuration variables, use the `printenv` command.**

The following example shows a short excerpt of this command’s output.

```
ok printenv
Variable Name      Value              Default Value
diag-level         min                max
diag-switch?      false              false
```

- **To set or change the value of an OpenBoot configuration variable, use the `setenv` command:**

```
ok setenv diag-level max
diag-level = max
```



- To set OpenBoot configuration variables that accept multiple keywords, separate keywords with a space:

```
ok setenv post-trigger power-on-reset error-reset
post-trigger = power-on-reset error-reset
```

---

**Note** – The `test-args` variable operates differently from other OpenBoot configuration variables. It requires a single argument consisting of a comma-separated list of keywords. For details, see “Controlling OpenBoot Diagnostics Tests” on page 85.

---

## What Next

Changes to OpenBoot configuration variables usually take effect upon the next reboot.

---

# Reference for Choosing a Fault Isolation Tool

This section helps you choose the right tool to isolate a failed part in a Sun Fire V490 system. Consider the following questions when selecting a tool.

1. Have you checked the LEDs?  
Certain system components have built-in LEDs that can alert you when that component requires replacement. For detailed instructions, see “How to Isolate Faults Using LEDs” on page 172.
2. Does the system have main power?  
If there is no main power to the system, standby power from the SC card may enable you to check the status of some components. See “About Monitoring the System” on page 101.
3. Does the system boot?
  - If the system *cannot* boot, you have to run firmware-based diagnostics that do not depend on the operating system.
  - If the system *can* boot, you should use a more comprehensive tool. The typical fault isolation process is illustrated in FIGURE 10-1.

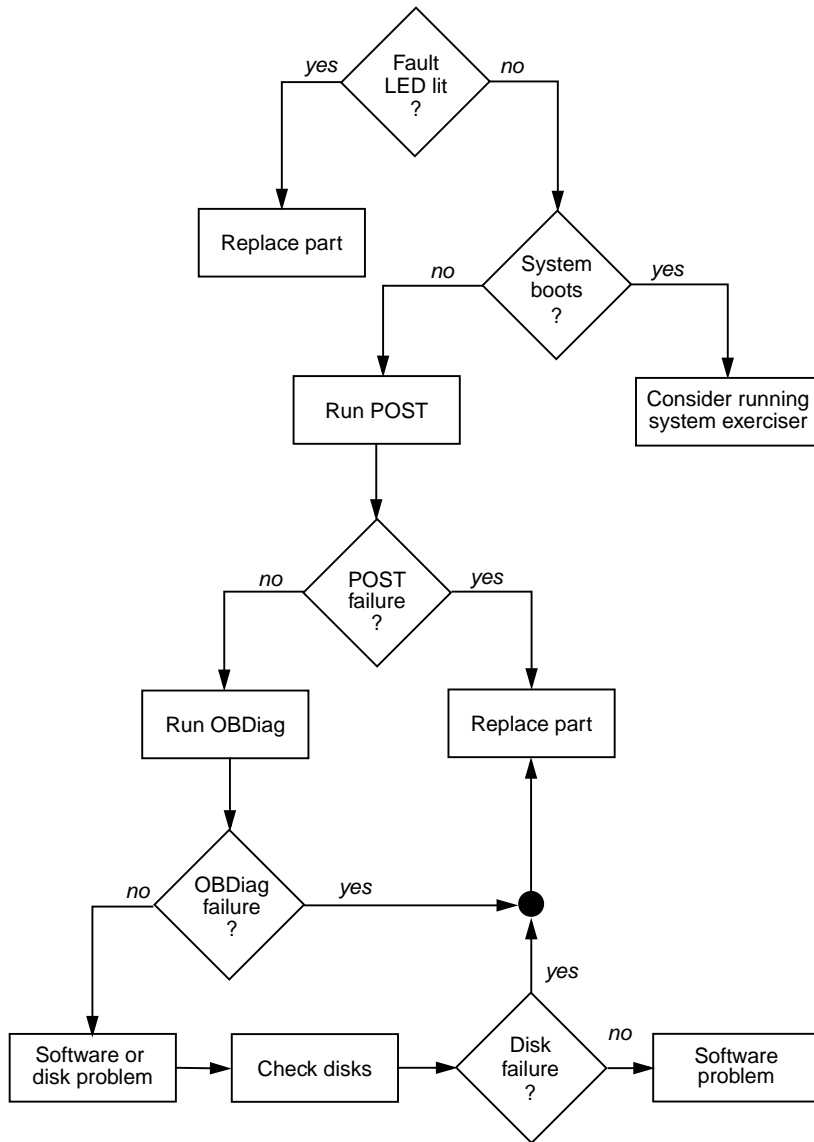

**FIGURE 10-1** Choosing a Tool to Isolate Hardware Faults

#### 4. Do you intend to run the tests remotely?

Both Sun Management Center and RSC software enable you to run tests from a remote computer. In addition, RSC software provides a means of redirecting system console output, allowing you remotely to view and run tests—like POST diagnostics—that usually require physical proximity to the serial port on the system’s back panel.

5. Will the tool test the suspected source(s) of the problem?

Perhaps you already have some idea of what the problem is. If so, you want to use a diagnostic tool capable of testing the suspected problem sources.

- TABLE 6-5 tells you which replaceable hardware parts can be isolated by each fault isolating tool.
- TABLE 6-9 tells you which replaceable hardware parts are covered by each system exercising tool.

6. Is the problem intermittent or software-related?

If a problem is not caused by a clearly defective hardware component, then you may want to use a system exerciser tool rather than a fault isolation tool. See Chapter 12 for instructions and “About Exercising the System” on page 105 for background information.



# Monitoring the System

---

When something goes wrong with the system, diagnostic tools can help you determine what caused the problem. Indeed, this is the principal use of most diagnostic tools. However, this approach is inherently reactive. It means waiting until a component fails outright.

Some diagnostic tools allow you to be more proactive by monitoring the system while it is still “healthy.” Monitoring tools give administrators early warning of imminent failure, thereby allowing planned maintenance and better system availability. Remote monitoring also allows administrators the convenience of checking on the status of many machines from one centralized location.

Sun provides two tools that you can use to monitor servers:

- Sun Management Center software
- Sun Remote System Controller (RSC) software

In addition to these tools, Sun provides software-based and firmware-based commands that display various kinds of system information. While not strictly a monitoring tool, these commands enable you to review at a glance the status of different system aspects and components.

This chapter describes the tasks necessary to use these tools to monitor your Sun Fire V490 server. These include:

- “How to Monitor the System Using Sun Management Center Software” on page 186
- “How to Monitor the System Using the System Controller and RSC Software” on page 190
- “How to Use Solaris System Information Commands” on page 197
- “How to Use OpenBoot Information Commands” on page 198

If you want background information about the tools, turn to Chapter 6.

---

**Note** – Many of the procedures in this chapter assume that you are familiar with the OpenBoot firmware and that you know how to enter the OpenBoot environment. For background information, see “About the ok Prompt” on page 49. For instructions, see “How to Get to the ok Prompt” on page 126.

---

## How to Monitor the System Using Sun Management Center Software

Sun Management Center software is a flexible product with many features and options. How you use it depends on the specifics of your network as well as your needs and preferences. You must decide what role or roles you want your Sun Fire V490 system to play within the Sun Management Center domain. See “How Sun Management Center Works” on page 103 for details.

### Before You Begin

This procedure assumes you intend to load Sun Management Center agent software on your Sun Fire V490 system so as to be able to monitor it, and gives you some guidance on how to accomplish this goal.

This procedure also assumes you have set up or will set up one or more computers to function as Sun Management Center servers and consoles. Servers and consoles are part of the infrastructure that enables you to monitor systems using Sun Management Center software. Typically, you would install the server and console software on machines other than the Sun Fire V490 systems you intend to monitor. For details, see the *Sun Management Center User's Guide*.

If you intend to set up your Sun Fire V490 system as a Sun Management Center server or console, see:

- *Sun Management Center Installation and Configuration Guide*
- *Sun Management Center User's Guide*

Also see the other documents accompanying your Sun Management Center software.

---

**Note** – Sun Management Center software provides both standalone and browser-based console interfaces. This procedure assumes you are using the standalone Java technology-based console. The web-browser console interface, which differs somewhat in design and capabilities, is covered in the *Sun Management Center User's Guide*.

---

## What to Do

- 1. On your Sun Fire V490 system, install Sun Management Center agent software.**  
For instructions, see the *Sun Management Center Supplement for Workgroup Servers*.
- 2. On your Sun Fire V490 system, run the setup utility to configure agent software.**  
The setup utility is part of the workgroup server supplement. For more information, see the *Sun Management Center Supplement for Workgroup Servers*.
- 3. On the Sun Management Center server, add the Sun Fire V490 system to an administrative domain.**  
You can do this automatically using the Discovery Manager tool, or manually by creating an object from the console's Edit menu. For specific instructions, see the *Sun Management Center User's Guide*.
- 4. On a Sun Management Center console, double-click the icon representing the Sun Fire V490 system.**  
The Details window appears.
- 5. Click the Hardware tab.**

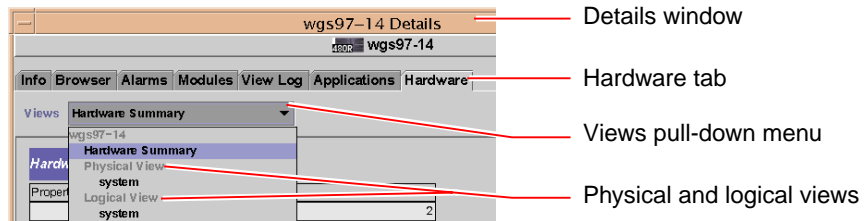

- 6. Monitor the Sun Fire V490 system using physical and logical views.**
  - a. Select “Physical View: system” from the Views pull-down menu.**

The physical view lets you interact with photo-realistic views of the Sun Fire V490 system as seen from the front, left, rear, and top. As you highlight individual hardware components and features, status and manufacturing information about each component appears to the right.

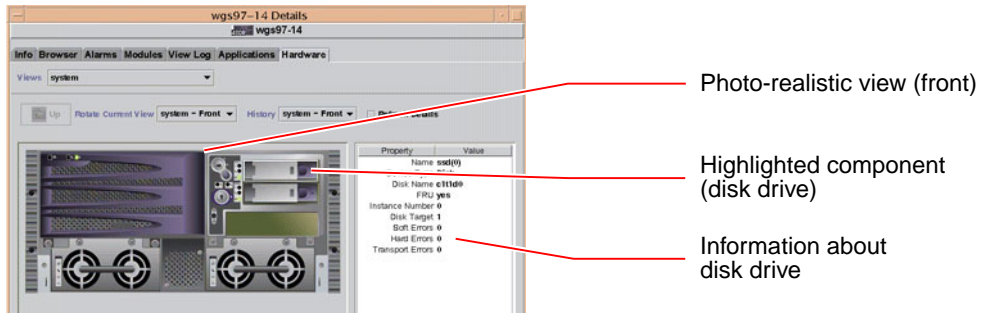

**b. Select “Logical View: system” from the Views pull-down menu.**

The logical view lets you browse a hierarchy of system components, arranged as a tree of nested folders.

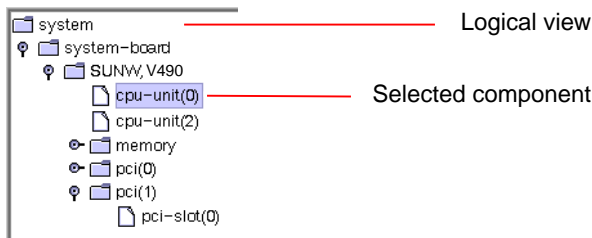

As you highlight a hardware component, status and manufacturing information about that component appears in a property table to the right.

Property	Value
Name	<b>cpu-unit(0)</b>
Clock Frequency	<b>450 MHz</b>
Cpu Type	<b>sparcv9</b>
Dcache Size	<b>16.0 KB</b>
Ecache Size	<b>4.0 MB</b>
FRU	<b>yes</b>
Lcache Size	<b>16.0 KB</b>
Model	<b>SUNW,UltraSPARC</b>
Processor Id	<b>0</b>
Status	<b>online</b>
Unit	<b>A</b>
Temperature	<b>--</b>

Status information about selected component

For more information about physical and logical views, see the *Sun Management Center User's Guide*.



**7. Monitor the Sun Fire V490 system using Config-Reader module data property tables.**

To access this information:

**a. Click the Browser tab.**

**b. Click the Hardware icon in the hierarchy view.**

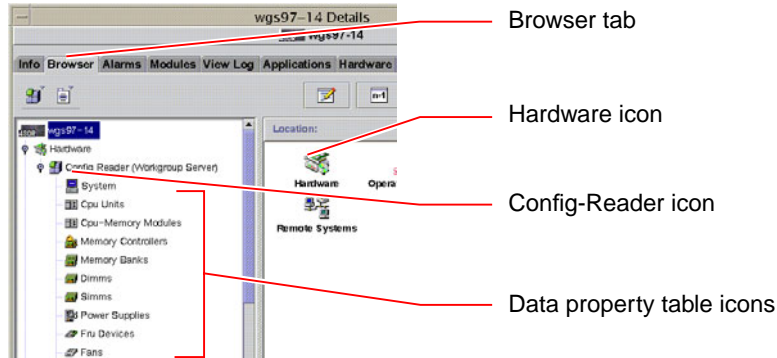

**c. Click the Config-Reader icon in the hierarchy view.**

Under the Config-Reader icon you can find data property table icons for many hardware components.

**d. Click a data property table icon to see status information for that hardware component.**

These tables give you many kinds of device-dependent status information, including:

- System temperatures
- Processor clock frequency
- Device model numbers
- Whether a device is field-replaceable
- Condition (pass or fail) of memory banks, fans, and other devices
- Power supply type

For more information about the Config-Reader module data property tables, see the *Sun Management Center User's Guide*.

## What Next

There is much more to Sun Management Center software than what is detailed in this manual. In particular, you may be interested in setting alarms and administering security. These topics and many others are covered in the *Sun Management Center User's Guide*, as well as the other documents accompanying the Sun Management Center software.

---

## How to Monitor the System Using the System Controller and RSC Software

This section explains how to configure the system controller (SC) card and set up Remote System Control (RSC) software. It also steps you through some of the tool's most important monitoring features.

### Before You Begin

The Sun Fire V490 server must be set up with RSC server software, which can be found on the Solaris Software Supplement CD. Typically, you monitor the Sun Fire V490 system from a different Sun computer or a PC. This procedure assumes you have installed RSC client software on the monitoring system.

There are many ways to configure and use the system controller and its RSC software, and only you can decide which is right for your organization. This procedure is designed to give you an idea of the capabilities of RSC software's graphical user interface (GUI). It assumes you have configured RSC software to use the system controller card's Ethernet port, and have made any necessary physical connections between the card and the network. It also assumes your network has not been set up to use dynamic host configuration protocol (DHCP) and illustrates the use of config IP mode instead. Note that after running SC and RSC through their paces, you can change configuration by running the configuration script again.

To configure the system controller card and RSC software, you need to know your network's subnet mask as well as the IP addresses of both the system controller card and the gateway system. Have this information available.

For detailed information about installing and configuring RSC server and client software, see:

- *Sun Remote System Controller (RSC) User's Guide*

# What to Do

1. As root on the Sun Fire V490 server, run the RSC configuration script. Type:

```
# /usr/platform/`uname -i`/rsc/rsc-config
```

The configuration script runs, prompting you to choose options and to provide information.

2. Follow the configuration script prompts.

For the purposes of this procedure, you can accept most of the default values. However, you need to pay attention to specific prompts as described below.

- a. Choose to enable the RSC Ethernet interface, using `config` IP mode:

```
Enable RSC Ethernet Interface (y|n|s|?) [n]: y
RSC IP Mode (config|dhcp|?) [dhcp]: config
```

- b. When configuring Ethernet, provide the IP address of the RSC device:

```
RSC IP Address []: 192.168.111.222
```

- c. Also provide your network's subnet mask:

```
RSC IP Netmask [255.255.255.0]: 255.255.255.0
```

- d. Provide the IP address of the gateway machine:

```
RSC IP Gateway []: 192.168.111.123
```

- e. Set up an RSC account, supplying a user name and permissions:

```
Setup RSC User Account (y|n|?) [y]: y
Username []: jefferson
User Permissions (c,u,a,r|none|?) [cuar]: cuar
```

**f. Near the end of the script, you need to provide an RSC password:**

```
Setting User Password Now ...  
  
Password:  
Re-enter Password:
```

The RSC firmware on the Sun Fire V490 system is configured. Perform the following steps on the monitoring system.

**3. From the monitoring Sun computer or PC, start the RSC GUI.**

Do one of the following.

■ **If you are accessing the RSC GUI from a Sun computer, type:**

```
# /opt/rsc/bin/rsc
```

■ **If you are accessing the RSC GUI from a PC, do *one* of the following:**

- Double-click the Sun Remote System Controller desktop icon (if installed).
- From the Start menu, choose Programs and then Sun Remote System Controller (if installed).
- Double-click the RSC icon in the folder where RSC was installed. The default path is:

C:\Program Files\Sun Microsystems\Remote System Control

A login screen appears prompting you to enter the IP address (or hostname) of the RSC card, as well as the RSC user name and password that you set up during the configuration process.

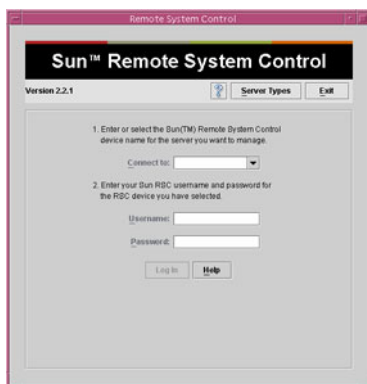

#### 4. Reply to the prompts given at the login screen.

The main screen of the GUI appears.

#### 5. Note the main screen's features.

The left side of the main screen provides help text and navigation controls. The right side shows a representation of the Sun Fire V490 server's front panel and system control switch.

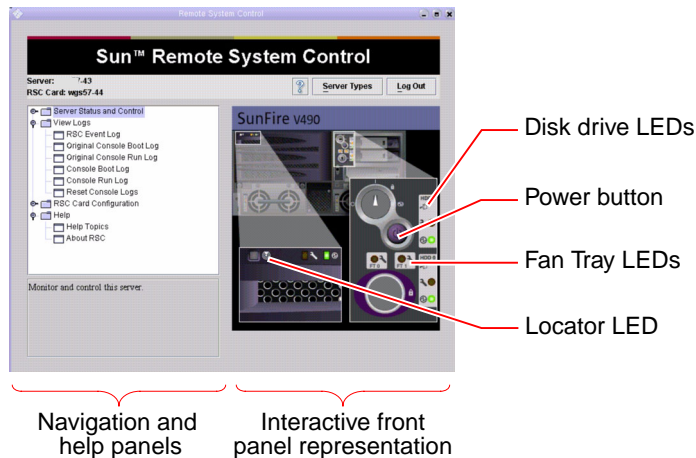

This front panel representation is dynamic—you can watch from a remote console and see when the Sun Fire V490 server's switch settings or LED status changes.

#### 6. Interact with the front panel representation to initiate actions.

The front panel representation is interactive. You click various parts of it to initiate actions. Try any or all of the following:

**a. Turn the Sun Fire V490 server's power off (or on).**

Click the Power button on the front panel representation. A dialog box appears asking you to confirm the action. Proceeding will actually turn system power off (or on).

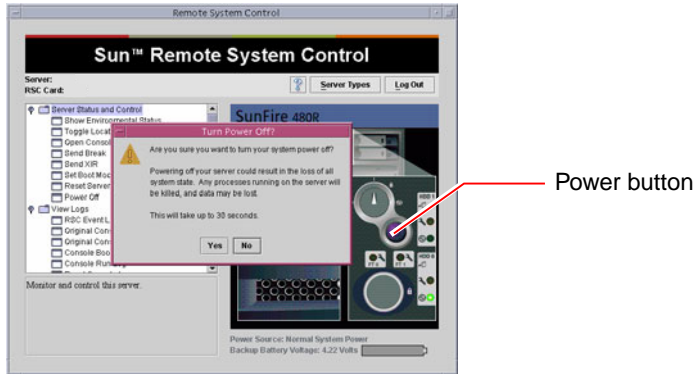

**b. Examine status tables for the Sun Fire V490 server's disks and fans.**

Click the appropriate LEDs. A table appears giving you the status of the components in question.

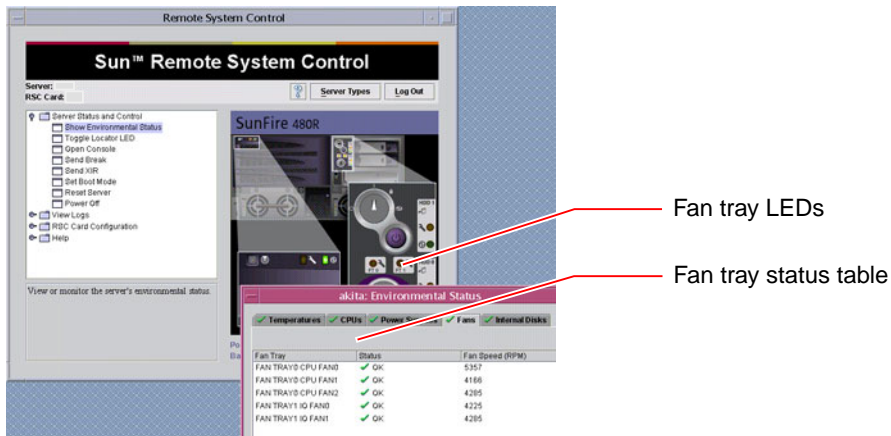

**c. Turn the Sun Fire V490 server's Locator LED on and off.**

Click the representation of the Locator LED (see the illustration under Step 5). Its state will toggle from off to on and back again each time you click, mimicking the condition of the physical Locator LED on the machine's front panel.

## 7. Check system temperatures and other environmental data.

To do this:

a. Find the navigation panel at the left side of the RSC GUI.

b. Click the Show Environmental Status item under Server Status and Control.

The Environmental Status window appears.

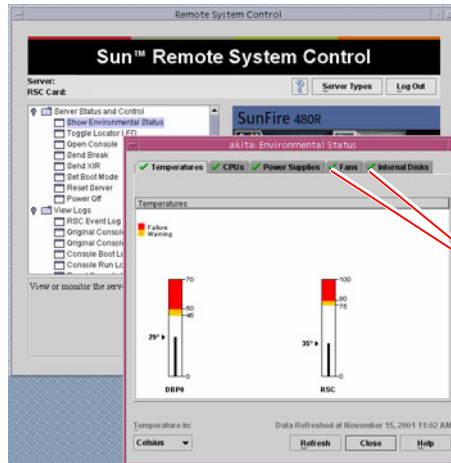

Check marks

By default, the Temperatures tab is selected and temperature data from specific chassis locations are graphed. The green check marks on each tab let you see at a glance that no problems are found with these subsystems.

If a problem does occur, RSC brings it to your attention by displaying a failure or warning symbol over each affected graph, and more prominently, in each affected tab.

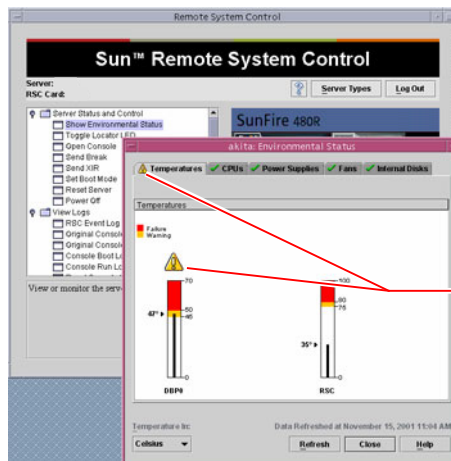

Warning symbols

- c. Click the other Environmental Status window tabs to see additional data.
- 8. Access the Sun Fire V490 server's system console from RSC software.**
- To do this:
- a. Find the navigation panel at the left side of the RSC GUI.
  - b. Click the Open Console item under Server Status and Control.  
A Console window appears.
  - c. From the Console window, press the Return key to reach the system console output.

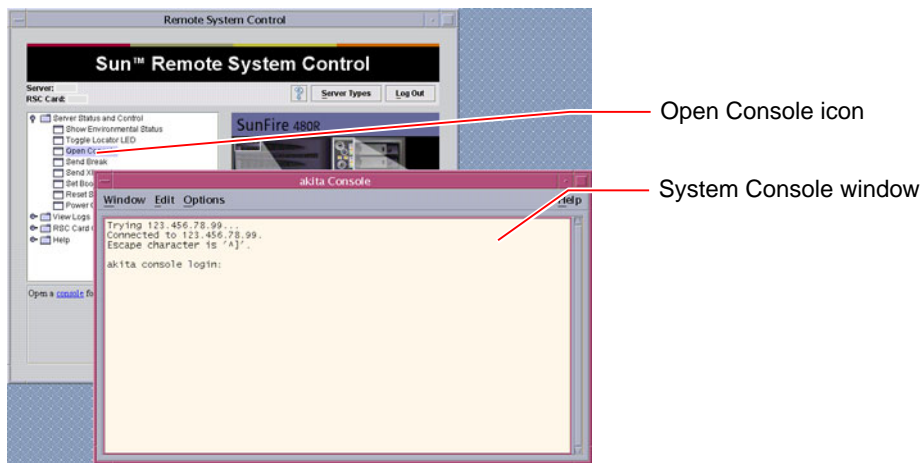

---

**Note** – If you have not set OpenBoot configuration variables properly, no console output will appear. For instructions, see “How to Redirect the System Console to the System Controller” on page 159.

---

## What Next

If you plan to use RSC software to control the Sun Fire V490 server, you may want to configure additional RSC user accounts.

If you want to try the system controller command-line interface, you can use the `telnet` command to connect directly to the RSC card using the device's name or IP address. When the `rsc>` prompt appears, type `help` to get a list of available commands.



If you want to change RSC configuration, run the configuration script again as shown in Step 1 of this procedure.

For information about RSC configuration, user accounts, and alerts, see:

- *Sun Remote System Controller (RSC) User's Guide*

This document is included on the Sun Fire V490 Documentation CD.

---

# How to Use Solaris System Information Commands

This section explains how to run Solaris system information commands on a Sun Fire V490 server. To find out what these commands tell you, see “Solaris System Information Commands” on page 93, or see the appropriate man pages.

## Before You Begin

The operating system must be up and running.

## What to Do

1. **Decide what kind of system information you want to display.**

For more information, see “Solaris System Information Commands” on page 93.

2. **Type the appropriate command at a console prompt. See TABLE 11-1.**

TABLE 11-1 Using Solaris Information Display Commands

Command	What It Displays	What to Type	Notes
<code>prtconf</code>	System configuration information	<code>/usr/sbin/prtconf</code>	—
<code>prtdiag</code>	Diagnostic and configuration information	<code>/usr/platform/sun4u/sbin/prtdiag</code>	Use the <code>-v</code> option for additional detail.

TABLE 11-1 Using Solaris Information Display Commands (Continued)

Command	What It Displays	What to Type	Notes
<code>prtfru</code>	FRU hierarchy and SEEPROM memory contents	<code>/usr/sbin/prtfru</code>	Use the <code>-l</code> option to display hierarchy. Use the <code>-c</code> option to display SEEPROM data.
<code>psrinfo</code>	Date and time each processor came online; processor clock speed	<code>/usr/sbin/psrinfo</code>	Use the <code>-v</code> option to obtain clock speed and other data.
<code>showrev</code>	Hardware and software revision information	<code>/usr/bin/showrev</code>	Use the <code>-p</code> option to show software patches.

## How to Use OpenBoot Information Commands

This section explains how to run OpenBoot commands that display different kinds of system information about a Sun Fire V490 server. To find out what these commands tell you, see “Other OpenBoot Commands” on page 90, or refer to the appropriate man pages.

### Before You Begin

As long as you can reach the `ok` prompt, you can use OpenBoot information commands. This means the commands are usually accessible even if your system cannot boot its operating system software.

### What to Do

1. **If necessary, halt the system to reach the `ok` prompt.**

How you do this depends on the system’s condition. If possible, you should warn users and shut down the system gracefully. For information, see “About the `ok` Prompt” on page 49.

2. **Decide what kind of system information you want to display.**

For more information, see “Other OpenBoot Commands” on page 90.

3. Type the appropriate command at a console prompt. See TABLE 11-2.

TABLE 11-2 Using OpenBoot Information Commands

Command to Type	What It Displays
<code>.env</code>	Fan speeds, currents, voltages, and temperatures
<code>printenv</code>	OpenBoot configuration variable defaults and settings
<code>probe-scsi</code> <code>probe-scsi-all</code> <code>probe-ide</code>	Target address, unit number, device type, and manufacturer name of active SCSI, IDE, and FC-AL devices <b>Note:</b> These probe commands can hang the system if executed while Solaris OS is running (that is, after issuing a Stop-A command)
<code>show-devs</code>	Hardware device paths of all devices in the system configuration



## Exercising the System

---

Sometimes a server exhibits a problem that cannot be isolated definitively to a particular hardware or software component. In such cases, it may be useful to run a diagnostic utility that stresses the system by continuously running a comprehensive battery of tests. Sun provides two such utilities that you can use with the Sun Fire V490 server:

- SunVTS (Sun Validation Test Suite)
- Hardware Diagnostic Suite

Hardware Diagnostic Suite is a product you can purchase as an enhancement to Sun Management Center software. Instructions for using Hardware Diagnostic Suite can be found in the *Sun Management Center Software User's Guide*.

This chapter describes the tasks necessary to use SunVTS software to exercise your Sun Fire V490 server. These include:

- “How to Exercise the System Using SunVTS Software” on page 202
- “How to Check Whether SunVTS Software Is Installed” on page 206

If you want background information about the tools and when to use them, turn to Chapter 6.

---

# How to Exercise the System Using SunVTS Software

## Before You Begin

The Solaris operating system must be running. You also need to make sure that SunVTS validation test software is installed on your system. See:

- “How to Check Whether SunVTS Software Is Installed” on page 206

SunVTS software requires that you use one of two security schemes, and these must be properly configured in order for you to perform this procedure. For details, see:

- *SunVTS User's Guide*
- “SunVTS Software and Security” on page 108

SunVTS software features both character-based and graphics-based interfaces. This procedure assumes that you are using the graphical user interface (GUI) on a system running the Common Desktop Environment (CDE). For more information about the character-based SunVTS TTY interface, and specifically for instructions on accessing it by `tip` or `telnet` commands, see the *SunVTS User's Guide*.

SunVTS software can be run in several modes. This procedure assumes that you are using the default Functional mode. For a synopsis of the modes, see:

- “Exercising the System Using SunVTS Software” on page 106

This procedure also assumes that the Sun Fire V490 server is “headless”—that is, it is not equipped with a monitor capable of displaying bitmapped graphics. In this case, you access the SunVTS GUI by logging in remotely from a machine that has a graphics display.

Finally, this procedure describes how to run SunVTS tests in general. Individual tests may presume the presence of specific hardware, or may require specific drivers, cables, or loopback connectors. For information about test options and prerequisites, see:

- *SunVTS Test Reference Manual*
- *SunVTS Documentation Supplement*

# What to Do

## 1. Log in as superuser to a system with a graphics display.

The display system should be one with a frame buffer and monitor capable of displaying bitmapped graphics such as those produced by the SunVTS GUI.

## 2. Enable remote display. On the display system, type:

```
# /usr/openwin/bin/xhost + test-system
```

where *test-system* is the name of the Sun Fire V490 server being tested.

## 3. Remotely log in to the Sun Fire V490 server as superuser.

Use a command such as `rlogin` or `telnet`.

## 4. Start SunVTS software. Type:

```
# /opt/SUNWvts/bin/sunvts -display display-system:0
```

where *display-system* is the name of the machine through which you are remotely logged in to the Sun Fire V490 server.

If you have installed SunVTS software in a location other than the default `/opt` directory, alter the path in the above command accordingly.

The SunVTS GUI appears on the display system's screen.

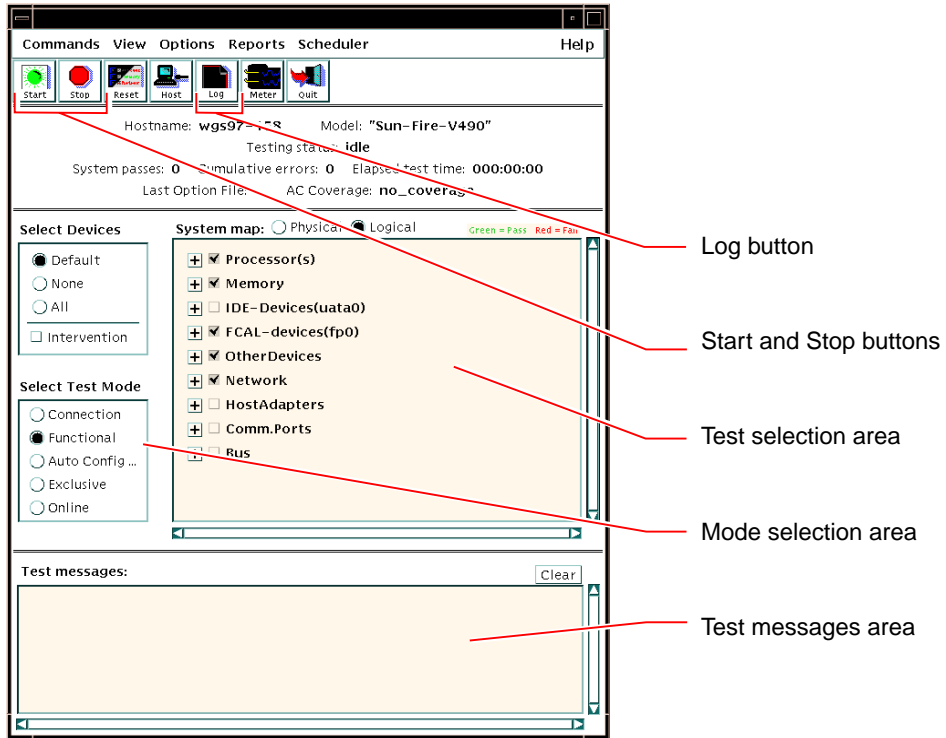

### 5. Expand the test lists to see the individual tests.

The interface's test selection area lists tests in categories, such as "Network," as shown below. To expand a category, click the  icon to the left of the category name.



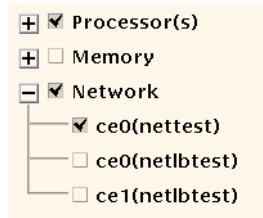

## 6. (Optional) Select the tests you want to run.

Certain tests are enabled by default, and you can choose to accept these.

Alternatively, you can enable and disable individual tests or blocks of tests by clicking the checkbox next to the test name or test category name. Tests are enabled when checked, and disabled when not checked.

TABLE 12-1 lists tests that are especially useful to run on a Sun Fire V490 server.

**TABLE 12-1** Useful SunVTS Tests to Run on a Sun Fire V490 Server

SunVTS Tests	FRUs Exercised by Tests
cmptest, cputest, fptest, iutest, l1dcachetest <i>indirectly:</i> l2cachetest, l2sramtest, mpconstest, mptest, systest	CPU/Memory board, centerplane
vmemtest, pmemtest, ramtest	Memory modules, CPU/Memory board, centerplane
disktest, qlctest	Disks, cables, FC-AL backplane
nettest, netlbttest	Network interface, network cable, centerplane
env5test, i2ctest	Power supplies, fan tray, LEDs, centerplane
sptest	Centerplane
ssptest	SC card
usbkbttest, disktest	USB devices, centerplane
dvdtest, cdtest	DVD device

**Note** – TABLE 12-1 lists FRUs in order of the likelihood they caused the test to fail.

## 7. (Optional) Customize individual tests.

You can customize individual tests by right-clicking on the name of the test. For instance, in the illustration under Step 5, right-clicking on the text string `ce0(nettest)` brings up a menu that lets you configure this Ethernet test.

## 8. Start testing.

Click the Start button, located at the top left of the SunVTS window, to begin running the tests you enabled. Status and error messages appear in the Test Messages area located across the bottom of the window. You can stop testing at any time by clicking the Stop button.

## What Next

During testing, SunVTS software logs all status and error messages. To view these, click the Log button or select Log Files from the Reports menu. This opens a log window from which you can choose to view the following logs:

- *Information* – Detailed versions of all the status and error messages that appear in the Test Messages area.
- *Test Error* – Detailed error messages from individual tests.
- *VTS Kernel Error* – Error messages pertaining to SunVTS software itself. You should look here if SunVTS software appears to be acting strangely, especially when it starts up.
- *UNIX Messages* (`/var/adm/messages`) – A file containing messages generated by the operating system and various applications.

For further information, see the documentation that accompanies SunVTS software.

---

# How to Check Whether SunVTS Software Is Installed

## Before You Begin

SunVTS software consists of optional packages that may or may not have been loaded when your system software was installed.

In addition to the SunVTS packages themselves, SunVTS software starting with version 5.1 requires certain XML and run-time library packages that may not be installed by default on Solaris 8 software.

This procedure assume that the Solaris operating system is running on the Sun Fire V490 server, and that you have access to the Solaris command line. For more information, see:

- “About Communicating With the System” on page 69

## What to Do

### 1. Check for the presence of SunVTS packages. Type:

```
% pkginfo -l SUNWvts SUNWvtsx SUNWvtsmn
```

- If SunVTS software is loaded, information about the packages is displayed.
- If SunVTS software is not loaded, you see an error message for each missing package.

```
ERROR: information for "SUNWvts" was not found  
ERROR: information for "SUNWvtsx" was not found  
...
```

The pertinent packages are as follows.

Package	Description
SUNWvts	SunVTS kernel, user interface, and 32-bit binary tests
SUNWvtsx	SunVTS 64-bit binary tests and kernel
SUNWvtsmn	SunVTS man pages

### 2. (*Solaris 8 only*) Check for additional needed software.

This applies only if you intend to install and run SunVTS 5.1 software (or later compatible versions) under the Solaris 8 operating system.

SunVTS 5.1 software requires additional packages that may not be installed with Solaris 8 software. To find out, type the following:

```
% pkginfo -l SUNWlxml SUNWlxmlx SUNWzlib SUNWzlibx
```

This tests for the presence of the following packages.

Package	Description	Notes
SUNXlxml	XML library (32-bit)	} Required by SunVTS 5.1
SUNWlxmlx	XML library (64-bit)	
SUNWzlib	Zip compression library (32-bit)	} Needed by XML libraries
SUNWzlibx	Zip compression library (64-bit)	

### 3. If necessary, load any missing packages.

Use the `pkgadd` utility to load onto your system any SunVTS and support packages that you determined you needed in Step 1 or Step 2.

For the Solaris 8 operating system, the SunVTS and XML packages are included on the Software Supplement CD. The `zlib` packages are included on the Solaris primary installation CD in the Entire Solaris Software Group.

Note that `/opt/SUNWvts` is the default directory for installing SunVTS software.

### 4. Load SunVTS patches, if appropriate.

Patches to SunVTS software are available periodically on the SunSolve<sup>SM</sup> Web site. These patches provide enhancements and bug fixes. In some cases, there are tests that will not run properly unless the patches are installed.

## What Next

For installation information, refer to the *SunVTS User's Guide*, the appropriate Solaris documentation, and the `pkgadd` man page.

## Connector Pinouts

---

This appendix gives you reference information about the system's back panel ports and pin assignments.

Topics covered in this appendix include:

- "Serial Port Connector" on page 210
- "USB Connector" on page 211
- "Twisted-Pair Ethernet Connector" on page 212
- "SC Ethernet Connector" on page 213
- "SC Serial Connector" on page 214
- "SC Serial Connector" on page 214
- "FC-AL Port HSSDC Connector" on page 215

---

# Serial Port Connector

The serial port connector is an RJ-45 connector that can be accessed from the back panel.

## Serial Port Connector Diagram

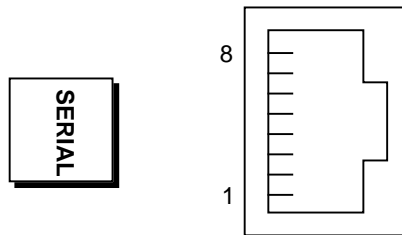

## Serial Port Connector Signals

Pin	Signal Description	Pin	Signal Description
1	Request To Send	5	Ground
2	Data Terminal Ready	6	Receive Data
3	Transmit Data	7	Data Set Ready
4	Ground	8	Clear To Send

---

# USB Connector

Two Universal Serial Bus (USB) connectors are located on the centerplane and can be accessed from the back panel.

## USB Connector Diagram

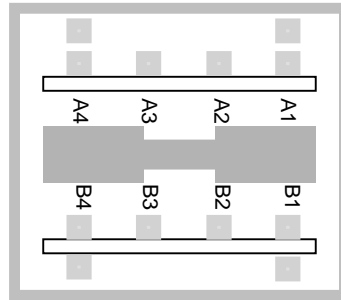

## USB Connector Signals

Pin	Signal Description	Pin	Signal Description
A1	+5 VDC	B1	+5 VDC
A2	Port Data0 -	B2	Port Data1 -
A3	Port Data0 +	B3	Port Data1 +
A4	Ground	B4	Ground

---

# Twisted-Pair Ethernet Connector

The twisted-pair Ethernet (TPE) connector is an RJ-45 connector located on the system centerplane and can be accessed from the back panel. The Ethernet interface operates at 10 Mbps, 100 Mbps, and 1000 Mbps.

## TPE Connector Diagram

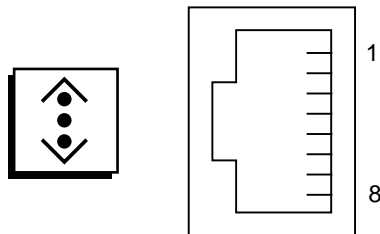

## TPE Connector Signals

Pin	Signal Description	Pin	Signal Description
1	Transmit/Receive Data0 +	5	Transmit/Receive Data2 -
2	Transmit/Receive Data0 -	6	Transmit/Receive Data1 -
3	Transmit/Receive Data1 +	7	Transmit/Receive Data3 +
4	Transmit/Receive Data2 +	8	Transmit/Receive Data3 -



---

# SC Ethernet Connector

The System Controller (SC) Ethernet connector is an RJ-45 connector located on the SC card and can be accessed from the back panel.

## SC Ethernet Connector Diagram

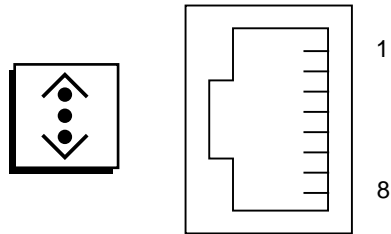

## SC Ethernet Connector Signals

Pin	Signal Description	Pin	Signal Description
1	Transmit/Receive Data0 +	5	Trandmit/Receive Data2 -
2	Transmit/Receive Data0 -	6	Trandmit/Receive Data1 -
3	Trandmit/Receive Data1 +	7	Trandmit/Receive Data3 +
4	Trandmit/Receive Data2 +	8	Trandmit/Receive Data3 -

---

# SC Serial Connector

The System Controller (SC) serial connector is an RJ-45 connector located on the SC card and can be accessed from the back panel.

## SC Serial Connector Diagram

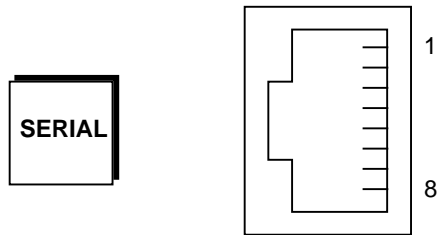

## SC Serial Connector Signals

Pin	Signal Description	Pin	Signal Description
1	Request To Send	5	Ground
2	Data Terminal Ready	6	Receive Data
3	Transmit Data	7	Data Set Ready
4	Ground	8	Clear To Send

---

## FC-AL Port HSSDC Connector

The Fibre Channel-Arbitrated Loop port high-speed serial data connector is located on the centerplane and can be accessed from the back panel.

### HSSDC Connector Diagram

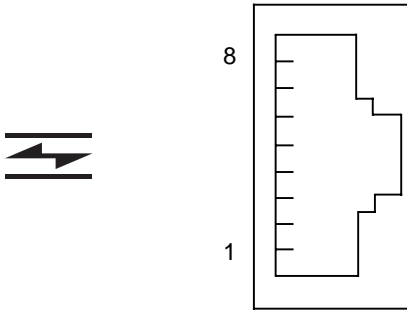

### HSSDC Connector Signal

Pin	Signal Description	Pin	Signal Description
1	Differential Data Output +	5	Optical Output Disable (optional)
2	Signal Ground (optional)	6	Differential Data Input -
3	Differential Data Output -	7	5V Power (+/-10%) (optional)
4	Mode Fault Detection (optional)	8	Differential Data Input +



# System Specifications

---

This appendix provides the following specifications for the Sun Fire V490 Server server:

- “Physical Specifications” on page 217
- “Electrical Specifications” on page 218
- “Environmental Specifications” on page 219
- “Agency Compliance Specifications” on page 220
- “Clearance and Service Access Specifications” on page 220

---

## Physical Specifications

The dimensions and weight of the system are as follows.

Measurement	U.S	Metric
Height	8.75 in	222 mm
Width	17.5 in	446 mm
Depth	24 in	610 mm
Weight		
Minimum	79 lbs	35.83 kg
Maximum	97 lbs	44 kg
Power Cord	8.2 ft	2.5 m

---

# Electrical Specifications

The following table provides the electrical specifications for the system.

---

**Note** – All electrical specifications apply to a fully configured system.

---

---

Parameter	Value
Input	
Nominal Frequencies	50 or 60 Hz
Nominal Voltage Range	Auto Ranging 200-240 VAC
Maximum Current AC RMS	8A @ 200-240 VAC
Maximum AC Power Consumption	1600 W
Maximum Heat Dissipation	5459 BTU/hr

---

---

# Environmental Specifications

The operating and non-operating environmental specifications for the system are as follows.

Parameter	Value
Operating	
Temperature	5° C to 35°C (41°F to 95°F)—IEC 60068-2-1&2
Humidity	20% to 80% RH noncondensing; 27°C (81°F) wet bulb—IEC 60068-2-3&56
Altitude	0 to 3000 meters (0 to 10,000 feet)—IEC 60068-2-13
Vibration	.0001 (z-axis only) G <sup>2</sup> /Hz, 5-150 Hz, -12db/octave slope, 150-500 Hz— IEC 60068-2-13
Shock	3g peak, 11 milliseconds half-sine pulse—IEC 60068-2-27
Declared Acoustics	72 DbA
Non-Operating	
Temperature	-20°C to 60°C (-4°F to 140°F)—IEC 60068-2-1&2
Humidity	95% RH noncondensing—IEC 60068-2-3&56
Altitude	0 to 12,000 meters (0 to 40,000 feet)—IEC 60068-2-13
Vibration	.001 (z-axis only) G <sup>2</sup> /Hz, 5-150 Hz, -12db/octave slope, 150-500 Hz— IEC 60068-2-13
Shock	10g peak, 11 milliseconds half-sine pulse—IEC 60068-2-27
Handling Drops	25 mm (10 in)
Threshold Impact	1 meter/second

---

# Agency Compliance Specifications

The system complies with the following specifications.

Category	Relevant Standards
Safety	UL 60950, CB Scheme IEC 60950, CSA C22.2 No. 60950-00 from UL, TUV EN 60950
RFI/EMI	47 CFR 15B Class A EN55022 Class A VCCI Class A ICES-003 AS/NZ 3548 CNS 13438
Immunity	EN55024 IEC 61000-4-2 IEC 61000-4-3 IEC 61000-4-4 IEC 61000-4-5 IEC 61000-4-6 IEC 61000-4-8 IEC 61000-4-11

---

---

# Clearance and Service Access Specifications

Minimum clearances needed for servicing the system are as follows.

Blockage	Required Clearance
Front blockage only	36 in (92 cm)
Rear blockage only	36 in (92 cm)
Front and rear blockage	36 in (92 cm)
Front clearance	36 in (92 cm)
Rear clearance	36 in (92 cm)

---



# Safety Precautions

---

Read this section before beginning any procedure. The following text provides safety precautions to follow when installing a Sun Microsystems product.

## Safety Precautions

For your protection, observe the following safety precautions when setting up your equipment:

- Follow all cautions and instructions marked on the equipment.
- Ensure that the voltage and frequency of your power source match the voltage and frequency inscribed on the equipment's electrical rating label.
- Never push objects of any kind through openings in the equipment. Dangerous voltages may be present. Conductive foreign objects could produce a short circuit that could cause fire, electric shock, or damage to your equipment.

## Symbols

The following symbols may appear in this book and/or on the product:



---

**Caution** – There is risk of personal injury and equipment damage. Follow the instructions.

---



---

**Caution** – Hot surface. Avoid contact. Surfaces are hot and may cause personal injury if touched.

---



---

**Caution** – Hazardous voltages are present. To reduce the risk of electric shock and danger to personal health, follow the instructions.

---

Depending on the type of power switch your device has, one of the following symbols may be used:



---

**On** – Applies AC power to the system.



---

---

**Off** - Removes AC power from the system.



---

---

**Standby** – The On/Standby switch is in the standby position.

---

## Modifications to Equipment

Do not make mechanical or electrical modifications to the equipment. Sun Microsystems is not responsible for regulatory compliance of a modified Sun product.

## Placement of a Sun Product



---

**Caution** – Do not block or cover the openings of your Sun product. Never place a Sun product near a radiator or heat register. Failure to follow these guidelines can cause overheating and affect the reliability of your Sun product.

---



---

**Caution** – The workplace-dependent noise level defined in DIN 45 635 Part 1000 must be 70Db(A) or less.

---

## SELV Compliance

Safety status of I/O connections comply to SELV requirements.

## Power Cord Connection



---

**Caution** – Sun products are designed to work with single-phase power systems having a grounded neutral conductor. To reduce the risk of electric shock, do not plug Sun products into any other type of power system. Contact your facilities manager or a qualified electrician if you are not sure what type of power is supplied to your building.

---



---

**Caution** – Not all power cords have the same current ratings. Household extension cords do not have overload protection and are not meant for use with computer systems. Do not use household extension cords with your Sun product.

---



---

**Caution** – Your Sun product is shipped with a grounding type (three-wire) power cord. To reduce the risk of electric shock, always plug the cord into a grounded power outlet.

---



---

**Caution** – In order to remove all power from the system, disconnect all power cords.

---

The following caution applies only to devices with a Standby power switch:



---

**Caution** – The power switch of this product functions as a standby type device only. The power cord serves as the primary disconnect device for the system. Be sure to plug the power cord into a grounded power outlet that is nearby the system and is readily accessible. Do not connect the power cord when the power supply has been removed from the system chassis.

---

## Lithium Battery



---

**Caution** – The Sun Fire V490 Server system PCI riser board and SC card contain lithium batteries. Batteries are not customer replaceable parts. They may explode if mishandled. Do not dispose of the battery in fire. Do not disassemble it or attempt to recharge it.

---

## System Unit Access Panels

You must remove the access panels of your Sun Fire V490 Server to add cards or memory. Be sure to replace and secure the access panels before powering on your system.



---

**Caution** – Do not operate your system while the access panels are removed. Failure to take this precaution may result in personal injury and system damage.

---

## Laser Compliance Notice

Sun products that use laser technology comply with Class 1 laser requirements.

Class 1 Laser Product  
Luokan 1 Laserlaite  
Klasse 1 Laser Apparat  
Laser Klasse 1

## CD-ROM



---

**Caution** - Use of controls, adjustments, or the performance of procedures other than those specified herein may result in hazardous radiation exposure.

---

# Einhaltung sicherheitsbehördlicher Vorschriften

Auf dieser Seite werden Sicherheitsrichtlinien beschrieben, die bei der Installation von Sun-Produkten zu beachten sind.

## Sicherheitsvorkehrungen

Treffen Sie zu Ihrem eigenen Schutz die folgenden Sicherheitsvorkehrungen, wenn Sie Ihr Gerät installieren:

- Beachten Sie alle auf den Geräten angebrachten Warnhinweise und Anweisungen.
- Vergewissern Sie sich, daß Spannung und Frequenz Ihrer Stromquelle mit der Spannung und Frequenz übereinstimmen, die auf dem Etikett mit den elektrischen Nennwerten des Geräts angegeben sind.
- Stecken Sie auf keinen Fall irgendwelche Gegenstände in Öffnungen in den Geräten. Leitfähige Gegenstände könnten aufgrund der möglicherweise vorliegenden gefährlichen Spannungen einen Kurzschluß verursachen, der einen Brand, Stromschlag oder Geräteschaden herbeiführen kann.

## Symbole

Die Symbole in diesem Handbuch haben folgende Bedeutung:



---

**Achtung** – Gefahr von Verletzung und Geräteschaden. Befolgen Sie die Anweisungen.

---



---

**Achtung** – Hohe Temperatur. Nicht berühren, da Verletzungsgefahr durch heiße Oberfläche besteht.

---



---

**Achtung** – Gefährliche Spannungen. Anweisungen befolgen, um Stromschläge und Verletzungen zu vermeiden.

---

Je nach Netzschaltertyp an Ihrem Gerät kann eines der folgenden Symbole benutzt werden:



---

**Ein** – Setzt das System unter Wechselstrom.

---



---

**Aus** – Unterbricht die Wechselstromzufuhr zum Gerät.

---



---

**Wartezustand** (Stand-by-Position) - Der Ein-/Wartezustand-Schalter steht auf Wartezustand. Änderungen an Sun-Geräten.

---

Nehmen Sie keine mechanischen oder elektrischen Änderungen an den Geräten vor. Sun Microsystems, übernimmt bei einem Sun-Produkt, das geändert wurde, keine Verantwortung für die Einhaltung behördlicher Vorschriften

## Aufstellung von Sun-Geräten



---

**Achtung** – Um den zuverlässigen Betrieb Ihres Sun-Geräts zu gewährleisten und es vor Überhitzung zu schützen, dürfen die Öffnungen im Gerät nicht blockiert oder verdeckt werden. Sun-Produkte sollten niemals in der Nähe von Heizkörpern oder Heizluftklappen aufgestellt werden.

---



---

**Achtung** – Der arbeitsplatzbezogene Schalldruckpegel nach DIN 45 635 Teil 1000 beträgt 70Db(A) oder weniger.

---

## Einhaltung der SELV-Richtlinien

Die Sicherung der I/O-Verbindungen entspricht den Anforderungen der SELV-Spezifikation.

## Anschluß des Netzkabels



---

**Achtung** – Sun-Produkte sind für den Betrieb an Einphasen-Stromnetzen mit geerdetem Nulleiter vorgesehen. Um die Stromschlaggefahr zu reduzieren, schließen Sie Sun-Produkte nicht an andere Stromquellen an. Ihr Betriebsleiter oder ein qualifizierter Elektriker kann Ihnen die Daten zur Stromversorgung in Ihrem Gebäude geben.

---



---

**Achtung** – Nicht alle Netzkabel haben die gleichen Nennwerte. Herkömmliche, im Haushalt verwendete Verlängerungskabel besitzen keinen Überlastungsschutz und sind daher für Computersysteme nicht geeignet.

---



---

**Achtung** – Ihr Sun-Gerät wird mit einem dreiadrigen Netzkabel für geerdete Netzsteckdosen geliefert. Um die Gefahr eines Stromschlags zu reduzieren, schließen Sie das Kabel nur an eine fachgerecht verlegte, geerdete Steckdose an.

---



---

**Achtung** – Bei Produkten mit mehreren Kabeln müssen zur vollständigen Unterbrechung der Stromversorgung alle Kabel abgezogen werden.

---

Die folgende Warnung gilt nur für Geräte mit Wartezustand-Netzschalter:



---

**Achtung** – Der Ein/Aus-Schalter dieses Geräts schaltet nur auf Wartezustand (Stand-By-Modus). Um die Stromzufuhr zum Gerät vollständig zu unterbrechen, müssen Sie das Netzkabel von der Steckdose abziehen. Schließen Sie den Stecker des Netzkabels an eine in der Nähe befindliche, frei zugängliche, geerdete Netzsteckdose an. Schließen Sie das Netzkabel nicht an, wenn das Netzteil aus der Systemeinheit entfernt wurde.

---

## Lithiumbatterie



---

**Achtung** – CPU-Karten von Sun verfügen über eine Echtzeituhr mit integrierter Lithiumbatterie (Teile-Nr. MK48T59Y, MK48TXXB-XX, MK48T18-XXXPCZ, M48T59W-XXXPCZ, oder MK48T08). Diese Batterie darf nur von einem qualifizierten Servicetechniker ausgewechselt werden, da sie bei falscher Handhabung explodieren kann. Werfen Sie die Batterie nicht ins Feuer. Versuchen Sie auf keinen Fall, die Batterie auszubauen oder wiederaufzuladen.

---

## Gehäuseabdeckung

Sie müssen die obere Abdeckung Ihres Sun-Systems entfernen, um interne Komponenten wie Karten, Speicherchips oder Massenspeicher hinzuzufügen. Bringen Sie die obere Gehäuseabdeckung wieder an, bevor Sie Ihr System einschalten.



---

**Achtung** – Bei Betrieb des Systems ohne obere Abdeckung besteht die Gefahr von Stromschlag und Systemschäden.

---



## Einhaltung der Richtlinien für Laser

Sun-Produkte, die mit Laser-Technologie arbeiten, entsprechen den Anforderungen der Laser Klasse 1.

Class 1 Laser Product  
Luokan 1 Laserlaite  
Klasse 1 Laser Apparat  
Laser Klasse 1

## CD-ROM



---

**Warnung** – Die Verwendung von anderen Steuerungen und Einstellungen oder die Durchführung von Prozeduren, die von den hier beschriebenen abweichen, können gefährliche Strahlungen zur Folge haben.

---

## Conformité aux normes de sécurité

Ce texte traite des mesures de sécurité qu'il convient de prendre pour l'installation d'un produit Sun Microsystems.

### Mesures de sécurité

Pour votre protection, veuillez prendre les précautions suivantes pendant l'installation du matériel :

- Suivre tous les avertissements et toutes les instructions inscrites sur le matériel.
- Vérifier que la tension et la fréquence de la source d'alimentation électrique correspondent à la tension et à la fréquence indiquées sur l'étiquette de classification de l'appareil.
- Ne jamais introduire d'objets quels qu'ils soient dans une des ouvertures de l'appareil. Vous pourriez vous trouver en présence de hautes tensions dangereuses. Tout objet conducteur introduit de la sorte pourrait produire un court-circuit qui entraînerait des flammes, des risques d'électrocution ou des dégâts matériels.

## Symboles

Vous trouverez ci-dessous la signification des différents symboles utilisés :



---

**Attention:** – risques de blessures corporelles et de dégâts matériels. Veuillez suivre les instructions.

---



---

**Attention:** – surface à température élevée. Évitez le contact. La température des surfaces est élevée et leur contact peut provoquer des blessures corporelles.

---



**Attention:** – présence de tensions dangereuses. Pour éviter les risques d'électrocution et de danger pour la santé physique, veuillez suivre les instructions.

---

---

Un des symboles suivants sera peut-être utilisé en fonction du type d'interrupteur de votre système:



**MARCHE** – Votre système est sous tension (courant alternatif).

---



**ARRET** - Votre système est hors tension (courant alternatif).

---



**VEILLEUSE** – L'interrupteur Marche/Veilleuse est en position « Veilleuse ».

---

## Modification du matériel

Ne pas apporter de modification mécanique ou électrique au matériel. Sun Microsystems n'est pas responsable de la conformité réglementaire d'un produit Sun qui a été modifié.

## Positionnement d'un produit Sun



**Attention:** – pour assurer le bon fonctionnement de votre produit Sun et pour l'empêcher de surchauffer, il convient de ne pas obstruer ni recouvrir les ouvertures prévues dans l'appareil. Un produit Sun ne doit jamais être placé à proximité d'un radiateur ou d'une source de chaleur.

---



**Attention:** – Le niveau de pression acoustique au poste de travail s'élève selon la norme DIN 45 635 section 1000, à 70 dB (A) ou moins.

---

## Conformité SELV

Sécurité : les raccordements E/S sont conformes aux normes SELV.

## Connexion du cordon d'alimentation



---

**Attention:** – les produits Sun sont conçus pour fonctionner avec des alimentations monophasées munies d'un conducteur neutre mis à la terre. Pour écarter les risques d'électrocution, ne pas brancher de produit Sun dans un autre type d'alimentation secteur. En cas de doute quant au type d'alimentation électrique du local, veuillez vous adresser au directeur de l'exploitation ou à un électricien qualifié.

---



---

**Attention:** – tous les cordons d'alimentation n'ont pas forcément la même puissance nominale en matière de courant. Les rallonges d'usage domestique n'offrent pas de protection contre les surcharges et ne sont pas prévues pour les systèmes d'ordinateurs. Ne pas utiliser de rallonge d'usage domestique avec votre produit Sun.

---



---

**Attention:** – votre produit Sun a été livré équipé d'un cordon d'alimentation à trois fils (avec prise de terre). Pour écarter tout risque d'électrocution, branchez toujours ce cordon dans une prise mise à la terre.

---



---

**Attention:** – débranchez tous les cordons pour couper l'alimentation du système.

---

L'avertissement suivant s'applique uniquement aux systèmes équipés d'un interrupteur VEILLEUSE:



---

**Attention:** – le commutateur d'alimentation de ce produit fonctionne comme un dispositif de mise en veille uniquement. C'est la prise d'alimentation qui sert à mettre le produit hors tension. Veillez donc à installer le produit à proximité d'une prise murale facilement accessible. Ne connectez pas la prise d'alimentation lorsque le châssis du système n'est plus alimenté.

---

## Batterie au lithium



---

**Attention:** – sur les cartes CPU Sun, une batterie au lithium (référence MK48T59Y, MK48TXXB-XX, MK48T18-XXXPCZ, M48T59W-XXXPCZ, ou MK48T08.) a été moulée dans l'horloge temps réel SGS. Les batteries ne sont pas des pièces remplaçables par le client. Elles risquent d'exploser en cas de mauvais traitement. Ne pas jeter la batterie au feu. Ne pas la démonter ni tenter de la recharger.

---

## Couvercle

Pour ajouter des cartes, de la mémoire, ou des unités de stockage internes, vous devrez démonter le couvercle de l'unité système Sun. Ne pas oublier de remettre ce couvercle en place avant de mettre le système sous tension.



---

**Attention:** – il est dangereux de faire fonctionner un produit Sun sans le couvercle en place. Si l'on néglige cette précaution, on encourt des risques de blessures corporelles et de dégâts matériels.

---

## Conformité aux certifications Laser

Les produits Sun qui font appel aux technologies lasers sont conformes aux normes de la classe 1 en la matière.

Class 1 Laser Product  
Luokan 1 Laserlaitte  
Klasse 1 Laser Apparat  
Laser KLASse 1

## CD-ROM



---

**Attention:** – L'utilisation de contrôles, de réglages ou de performances de procédures autre que celle spécifiée dans le présent document peut provoquer une exposition à des radiations dangereuses.

---

## Normativas de seguridad

El siguiente texto incluye las medidas de seguridad que se deben seguir cuando se instale algún producto de Sun Microsystems.

### Precauciones de seguridad

Para su protección observe las siguientes medidas de seguridad cuando manipule su equipo:

- Siga todas los avisos e instrucciones marcados en el equipo.
- Asegúrese de que el voltaje y la frecuencia de la red eléctrica concuerdan con las descritas en las etiquetas de especificaciones eléctricas del equipo.
- No introduzca nunca objetos de ningún tipo a través de los orificios del equipo. Pueden haber voltajes peligrosos. Los objetos extraños conductores de la electricidad pueden producir cortocircuitos que provoquen un incendio, descargas eléctricas o daños en el equipo.

### Símbolos

En este libro aparecen los siguientes símbolos:



---

**Precaución** – Existe el riesgo de lesiones personales y daños al equipo. Siga las instrucciones.

---



---

**Precaución** – Superficie caliente. Evite el contacto. Las superficies están calientes y pueden causar daños personales si se tocan.

---



---

**Precaución** – Voltaje peligroso presente. Para reducir el riesgo de descarga y daños para la salud siga las instrucciones.

---

Según el tipo de interruptor de encendido que su equipo tenga, es posible que se utilice uno de los siguientes símbolos:



---

**Encendido** – Aplica la alimentación de CA al sistema.

---



---

**Apagado** - Elimina la alimentación de CA del sistema.

---



---

**En espera** – El interruptor de Encendido/En espera se ha colocado en la posición de En espera.

---

## Modificaciones en el equipo

No realice modificaciones de tipo mecánico o eléctrico en el equipo. Sun Microsystems no se hace responsable del cumplimiento de las normativas de seguridad en los equipos Sun modificados.

## Ubicación de un producto Sun



---

**Precaución** – Para asegurar la fiabilidad de funcionamiento de su producto Sun y para protegerlo de sobrecalentamientos no deben obstruirse o taparse las rejillas del equipo. Los productos Sun nunca deben situarse cerca de radiadores o de fuentes de calor.

---



---

**Precaución** – De acuerdo con la norma DIN 45 635, Parte 1000, se admite un nivel de presión acústica para puestos de trabajo máximo de 70Db(A).

---

## Cumplimiento de la normativa SELV

El estado de la seguridad de las conexiones de entrada/salida cumple los requisitos de la normativa SELV.

## Conexión del cable de alimentación eléctrica



---

**Precaución** – Los productos Sun están diseñados para trabajar en una red eléctrica monofásica con toma de tierra. Para reducir el riesgo de descarga eléctrica, no conecte los productos Sun a otro tipo de sistema de alimentación eléctrica. Póngase en contacto con el responsable de mantenimiento o con un electricista cualificado si no está seguro del sistema de alimentación eléctrica del que se dispone en su edificio.

---



---

**Precaución** – No todos los cables de alimentación eléctrica tienen la misma capacidad. Los cables de tipo doméstico no están provistos de protecciones contra sobrecargas y por tanto no son apropiados para su uso con computadores. No utilice alargadores de tipo doméstico para conectar sus productos Sun.

---



---

**Precaución** – Con el producto Sun se proporciona un cable de alimentación con toma de tierra. Para reducir el riesgo de descargas eléctricas conéctelo siempre a un enchufe con toma de tierra.

---



**Precaución** – Para eliminar completamente la alimentación de esta unidad, desconecte todos los cables de alimentación.

---

La siguiente advertencia se aplica solamente a equipos con un interruptor de encendido que tenga una posición "En espera":



**Precaución** – El interruptor de encendido de este producto funciona exclusivamente como un dispositivo de puesta en espera. El enchufe de la fuente de alimentación está diseñado para ser el elemento primario de desconexión del equipo. El equipo debe instalarse cerca del enchufe de forma que este último pueda ser fácil y rápidamente accesible. No conecte el cable de alimentación cuando se ha retirado la fuente de alimentación del chasis del sistema.

---

## Batería de litio



**Precaución** – En las placas de CPU Sun hay una batería de litio insertada en el reloj de tiempo real, tipo SGS Núm. MK48T59Y, MK48TXXB-XX, MK48T18-XXXPCZ, M48T59W-XXXPCZ, o MK48T08. Las baterías no son elementos reemplazables por el propio cliente. Pueden explotar si se manipulan de forma errónea. No arroje las baterías al fuego. No las abra o intente recargarlas.

---

## Tapa de la unidad del sistema

Debe quitar la tapa del sistema cuando sea necesario añadir tarjetas, memoria o dispositivos de almacenamiento internos. Asegúrese de cerrar la tapa superior antes de volver a encender el equipo.



**Precaución** – Es peligroso hacer funcionar los productos Sun sin la tapa superior colocada. El hecho de no tener en cuenta esta precaución puede ocasionar daños personales o perjudicar el funcionamiento del equipo.

---

## Aviso de cumplimiento con requisitos de láser

Los productos Sun que utilizan la tecnología de láser cumplen con los requisitos de láser de Clase 1.

Class 1 Laser Product  
Luokan 1 Laserlaite  
Klasse 1 Laser Apparat  
Laser Klasse 1

## CD-ROM



---

**Precaución** – El manejo de los controles, los ajustes o la ejecución de procedimientos distintos a los aquí especificados pueden exponer al usuario a radiaciones peligrosas.

---



## GOST-R Certification Mark

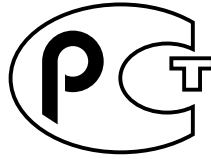

### Nordic Lithium Battery Cautions

#### Norge



---

**ADVARSEL** – Litiumbatteri —  
Ekspløsjonsfare. Ved utskifting benyttes kun  
batteri som anbefalt av apparatfabrikanten.  
Brukt batteri returneres apparatleverandøren.

---

#### Sverige



---

**VARNING** – Explosionsfara vid felaktigt  
batteribyte. Använd samma batterityp eller  
en ekvivalent typ som rekommenderas av  
apparatillverkaren. Kassera använt batteri  
enligt fabrikantens instruktion.

---

#### Danmark



---

**ADVARSEL!** – Litiumbatteri —  
Ekspløsjonsfare ved fejlagtig håndtering.  
Udskiftning må kun ske med batteri af samme  
fabrikat og type. Levér det brugte batteri  
tilbage til leverandøren.

---

#### Suomi



---

**VAROITUS** – Paristo voi räjähtää, jos se on  
virheellisesti asennettu. Vaihda paristo  
ainoastaan laitevalmistajan suosittelemaan  
tyyppiin. Hävitä käytetty paristo valmistajan  
ohjeiden mukaisesti.

---



# Index

---

## A

- AC Present LED (power supply), 173
- accounts
  - RSC, 191
- Activity LED
  - disk drive, 174
  - Ethernet, 174
- address
  - bitwalk (POST diagnostic), 80
  - of I<sup>2</sup>C devices (table), 111
- agency compliance specifications, 220
- agents, Sun Management Center, 103
- alphanumeric terminal
  - attaching, 133
  - baud verification, 132
  - setting up as system console, 133
  - settings for, 133
- .asr command, 60
- asr-disable command, 59, 162
- auto-boot? configuration variable, 49, 56, 82
- auto-boot-on-error? configuration variable, 56, 82
- automatic system recovery (ASR), 21
  - deconfiguring devices manually, 60, 162
  - overview, 55

## B

- back panel
  - illustration, 16
- baud rate, 133, 134

- baud rate, verifying, 132
- BIST, *See* built-in self-test
- BMC Patrol, *See* third-party monitoring tools
- boot device, how to select, 149
- Boot PROM
  - function of, 78
  - illustration of, 79
- boot-device configuration variable, 57, 149
- booting
  - after installing new hardware, 138
  - firmware, OpenBoot, 149
- boxes shipped to you, 1
- Break key (alphanumeric terminal), 51, 127
- built-in self-test, 82
  - IEEE 1275-compatible, 85
  - test-args variable and, 86

## C

- cables
  - keyboard/mouse, 137
- cautions and warnings, 221, 237
- central processing unit, *See* CPU
- checklist of parts, 1
- clearance specifications, 220
- clock speed (CPU), 98
- concatenation of disks, 67
- configuration script, RSC, 191
- console
  - enabling SC as, 161

- redirecting to SC, 161
- removing SC as default, 161

console, system, 3

CPU

- displaying information about, 98
- master, 78, 80

CPU/Memory board, 9, 27

currents, displaying system, 90

## D

data bitwalk (POST diagnostic), 80

data bus, Sun Fire V480, 75

data crossbar switch (CDX), 75

- illustration of, 76

- location of, 114

DC Present LED (power supply), 173

device paths, hardware, 87, 88, 92

device tree

- defined, 85, 103

- Solaris, displaying, 94

device trees, rebuilding, 140

diag-level configuration variable, 82

diag-level variable, 85

diagnostic mode

- how to put server in, 170

diagnostic tests

- availability of during boot process (table), 99

- bypassing, 84

- disabling, 78

- terms in output (table), 114

diagnostic tools

- informal, 73, 93, 172

- summary of (table), 74

- tasks performed with, 77

diag-out-console configuration variable, 83

diag-script configuration variable, 83

diag-switch? configuration variable, 58, 83, 165

diag-trigger configuration variable, 58

DIMMs (dual inline memory modules), 28

- groups, illustrated, 29

disk configuration

- concatenation, 67

- hot plug, 45

- hot spares, 68

- mirroring, 24, 66

- RAID 0, 24, 67

- RAID 1, 24, 67

- RAID 5, 24, 68

- striping, 24, 67

disk drive

- caution, 122

- hot plug, 45

- internal, about, 44

- LEDs, 14

  - Activity, described, 14

  - Fault, described, 14

  - OK-to-Remove, 14

- locating drive bays, 45

dual inline memory modules (DIMMs), 28

- groups, illustrated, 29

## E

electrical specifications, 218

electrostatic discharge (ESD) precautions, 120

.env command (OpenBoot), 90

environmental monitoring subsystem, 20

environmental specifications, 219

environmental status, displaying with .env, 90

error correcting code (ECC), 24

error messages

- correctable ECC error, 24

- log file, 20

- OpenBoot Diagnostics, interpreting, 88

- POST, interpreting, 80

- power-related, 21

/etc/remote file, how to modify, 131

Ethernet

- configuring interface, 4, 144

- LEDs, 17

- link integrity test, 146, 149

- using multiple interfaces, 145

Ethernet Activity LED

- described, 17

Ethernet cable, attaching, 127

Ethernet Link Up LED

- described, 17

exercising the system

- FRU coverage (table), 106

- with Hardware Diagnostic Suite, 108

- with SunVTS, 106, 202

externally initiated reset (XIR), 51, 127

- described, 23
- manual command, 23

## F

fan

- displaying speed of, 90

Fan Tray 0

- isolating faults in cable, 101

Fan Tray 0 LED

- described, 14

Fan Tray 1 LED

- described, 14

fan tray assembly, 39

- configuration rule, 41

- illustration, 40

- LEDs, 14

fan tray LED, 173

fans

- See also* fan tray assembly
- monitoring and control, 20

fault isolation, 100

- FRU coverage (table), 100

- procedures for, 167

- using system LEDs, 172

Fault LED

- described, 13, 14

- disk drive, 174

- power supply, 173

- system, 173

FC-AL, *see* Fibre Channel-Arbitrated Loop (FC-AL)

Fibre Channel-Arbitrated Loop (FC-AL)

- backplane, 42

- configuration rules, 43

- defined, 41

- diagnosing problems in devices, 90

- disk drives supported, 42

- dual loop access, 43

- features, 42

- high-speed serial data connector (HSSDC)

  - port, 43

- host adapters, 44

  - configuration rules, 44

- isolating faults in cables, 101

- protocols supported, 42

field-replaceable unit, *See* FRU

frame buffer card, 71

front panel

- illustration, 12

- LEDs, 13

- locks, 12

- Power button, 15

- system control switch, 15

FRU

- boundaries between, 82

- coverage of fault isolating tools (table), 100

- coverage of system exercising tools (table), 106

- hardware revision level, 97

- hierarchical list of, 97

- manufacturer, 97

- not isolated by diagnostic tools (table), 101

- part number, 97

- POST and, 81

FRU data

- contents of IDPROM, 97

`fsck` command (Solaris), 51

## G

`go` (OpenBoot command), 50

graceful halt, 50, 127

## H

H/W under test, *See* interpreting error messages

halt

- gracefully, advantages of, 50, 127

halt command (Solaris), 50, 127

hardware configuration, 25, 46

- hardware jumpers, 36

- serial port, 45

hardware device paths, 87, 88, 92

Hardware Diagnostic Suite, 104

- about exercising the system with, 108

hardware jumpers, 36

hardware revision, displaying with `showrev`, 98

hardware watchdog

- described, 23

host adapter (`probe-scsi`), 91  
hot spares, *See* disk configuration  
HP Openview, *See* third-party monitoring tools

## I

I<sup>2</sup>C bus, 20  
I<sup>2</sup>C device addresses (table), 111  
IDE bus, 92  
IDPROM  
    function of, 79  
IEEE 1275-compatible built-in self-test, 85  
informal diagnostic tools, 73, 93  
informal diagnostic tools, *See also* LEDs,  
    system, 172  
`init` command (Solaris), 50, 127  
`input-device` configuration variable, 84, 165  
installing a server, 2, 5  
Integrated Drive Electronics, *See* IDE bus  
intermittent problem, 79, 105, 108  
internal disk drive bays, locating, 45  
interpreting error messages  
    I<sup>2</sup>C tests, 89  
    OpenBoot Diagnostics tests, 88  
    POST, 80  
isolating faults, 100  
    FRU coverage (table), 100

## J

jumpers, 36  
    flash PROM, 36  
    PCI riser board functions, 37  
    PCI riser board identification, 36

## L

L1-A keyboard combination, 51, 127  
LEDs  
    AC Present (power supply), 173  
    Activity (disk drive), 174  
    Activity (Ethernet), 174  
    back panel, 17

    back panel, described, 18  
    DC Present (power supply), 173  
    disk drive, 14  
        Activity, described, 14  
        Fault, described, 14  
        OK-to-Remove, 14  
    Ethernet, 17  
    Ethernet Activity  
        described, 17  
    Ethernet Link Up  
        described, 17  
    Ethernet, described, 17  
    fan tray, 14, 173  
    Fan Tray 0  
        described, 14  
    Fan Tray 1  
        described, 14  
    Fault, 14  
    Fault (disk drive), 174  
    Fault (power supply), 173  
    Fault (system), 173  
    Fault, described, 13  
    front panel, 13  
    Link Up (Ethernet), 174  
    Locator, 14, 173  
    Locator, described, 13  
    Locator, operating, 168  
    OK-to-Remove (disk drive), 174  
    OK-to-Remove (power supply), 173  
    power supply, 17  
    power supply, described, 18  
    Power/OK, 14, 173  
    system, 14  
LEDs, system  
    isolating faults with, 172  
light-emitting diode, *See* LEDs  
link integrity test, 146, 149  
Link Up LED (Ethernet), 174  
Locator LED, 173  
    described, 13, 14  
    operating, 168  
log files, 93, 103  
logical unit number (`probe-scsi`), 91  
logical view (Sun Management Center), 104  
loop ID (`probe-scsi`), 91

## M

- manual hardware reset, 127
- manual system reset, 51
- master CPU, 78, 80
- memory interleaving, 30
- mirroring, disk, 24, 66
- monitor, attaching, 136
- monitoring the system
  - with RSC, 190
- moving the system, precautions, 122
- MPxIO (multiplexed I/O)
  - features, 21

## N

- network
  - name server, 149
  - primary interface, 145
  - types, 4

## O

- OBDIAG, *See* OpenBoot Diagnostics tests
- ok prompt
  - risks in using, 50
  - ways to access, 50, 126
- OK-to-Remove LED
  - disk drive, 174
  - power supply, 173
- OpenBoot commands
  - dangers of, 50
  - .env, 90
  - printenv, 90
  - probe-ide, 92
  - show-devs, 92
- OpenBoot configuration variables
  - auto-boot?, 56
  - auto-boot-on-error?, 56
  - boot-device, 57, 149
  - diag-switch?, 58, 165
  - diag-trigger, 58
  - displaying with printenv, 90
  - input-device, 165
  - output-device, 165
  - purpose of, 79, 82

- resetting to default values, 165
  - service-mode?, 58
  - table of, 82

## OpenBoot Diagnostics

- role in automatic system recovery, 21, 56

## OpenBoot Diagnostics tests, 85

- controlling, 85
- descriptions of (table), 109
- error messages, interpreting, 88
- hardware device paths in, 87
- interactive menu, 86
- purpose and coverage of, 85
- running from the ok prompt, 87
- test command, 87
- test-all command, 88

## OpenBoot emergency procedures, 54

- OpenBoot firmware, 54, 119, 143, 150, 153, 168, 186
  - defined, 78

## OpenBoot variable settings, 141

- operating system software
  - installing, 5
  - suspending, 50

- output-device configuration variable, 84, 165

## overtemperature condition

- determining with prtdiag, 96
- determining with RSC, 195

## P

- parity, 24, 68, 133, 134

## parts

- checklist of, 1

## patches, installed

- determining with showrev, 99

## PCI (peripheral component interconnect) card

- frame buffer card, 136

## PCI buses, 10

- parity protection, 24

## PCI card

- device name, 151
- device names, 60

## PCI riser board

- jumper functions, 37

## PCI riser board jumpers, 36, 38

## physical specifications, 217

- physical view (Sun Management Center), 104

- pkgadd utility, 208
- pkginfo command, 207, 208
- POST, 74
  - controlling, 82
  - criteria for passing, 79
  - defined, 78
  - error messages, interpreting, 80
  - how to run, 175
  - persistent problems and, 79
  - purpose of, 79
- post-trigger configuration variable, 84
- power
  - specifications, 218
  - turning off, 125
  - turning on, 122
- Power button, 15
- power distribution board
  - isolating faults in, 101
- power supplies
  - LEDs, 17
  - LEDs, described, 18
- power supply
  - fault monitoring, 21
  - output capacity, 218
  - redundancy, 20
- Power/OK LED, 173
  - described, 14
- power-on self-tests, *See* POST
- precautions, safety, 237
- pre-POST preparation, verifying baud rate, 132
- printenv command (OpenBoot), 90
- probe-ide command (OpenBoot), 92
- probe-scsi and probe-scsi-all commands (OpenBoot), 90
- processor speed, displaying, 98
- prtconf command (Solaris), 94
- prtdiag command (Solaris), 94
- prtfwu command (Solaris), 97
- psrinfo command (Solaris), 98

## R

- reconfiguration boot, initiating, 138
- reliability, availability, and serviceability (RAS), 19, 22

- remote system control, *see* RSC
- Removable media bay board and cable assembly
  - isolating faults in, 101
- reset
  - manual hardware, 127
  - manual system, 51
- reset command, 127, 135, 138, 157, 158, 160, 161
- reset events, kinds of, 84
- reset-all command, 163
- revision, hardware and software
  - displaying with showrev, 98
- RJ-45 serial communications, 45
- RSC (Remote System Control), 22
  - accounts, 191
  - configuration script, 191
  - features, 22
  - graphical interface, starting, 192
  - interactive GUI, 169, 193
  - invoking reset command from, 127
  - invoking xir command from, 23, 127
  - main screen, 193
  - monitoring with, 190
- run levels
  - explained, 49
  - ok prompt and, 49

## S

- safety agency compliance, 220
- safety precautions, 237
- schematic view of Sun Fire V480 system (illustration), 76
- SCSI
  - parity protection, 24
- SCSI devices
  - diagnosing problems in, 90
- SEAM (Sun Enterprise Authentication Mechanism), 108
- serial port
  - about, 45
  - connecting to, 134
- server installation, 2, 5
- server media kit, contents of, 5
- service access specifications, 220
- service-mode? configuration variable, 58, 84



- shipping (what you should receive), 1
- show-devs command, 60, 151
- show-devs command (OpenBoot), 92
- showrev command (Solaris), 98
- shutdown, 125
- shutdown command (Solaris), 50, 127
- software revision, displaying with showrev, 98
- Solaris commands
  - fsck, 51
  - halt, 50, 127
  - init, 50, 127
  - prtconf, 94
  - prtdiag, 94
  - prtfru, 97
  - psrinfo, 98
  - showrev, 98
  - shutdown, 50, 127
  - sync, 51
  - uadmin, 50, 127
- specifications, 217, 220
  - agency compliance, 220
  - clearance, 220
  - electrical, 218
  - environmental, 219
  - physical, 217
  - service access, 220
- standby power
  - RSC and, 102
- status LEDs
  - environmental fault indicators, 21
- Stop-A keyboard combination, 51, 54, 127
- Stop-D keyboard combination, 54
- Stop-F keyboard combination, 55
- Stop-N keyboard combination, 165
- stress testing, *See also* exercising the system, 106
- striping of disks, 24, 67
- Sun Enterprise Authentication Mechanism, *See* SEAM
- Sun Fire V480 server
  - described, 9, 12
- Sun Management Center
  - tracking systems informally with, 104
- Sun Remote System Control, *See* RSC
- Sun Validation and Test Suite, *See* SunVTS
- SunVTS
  - checking if installed, 206
  - exercising the system with, 106, 202
  - guided tour of, 202
  - suspending the operating system software, 50
  - sync command (Solaris), 51
  - system console, 3
    - accessing via tip connection, 129
    - messages, 77
    - setting up alphanumeric terminal as, 133
    - setting up local graphics terminal as, 135
  - system control switch, 15
    - Forced Off position, 125
    - illustration, 15
    - Locked position, 124
    - Normal position, 123
    - settings, 16
  - System control switch cable
    - isolating faults in, 101
  - system controller
    - See also* ALOM
    - introduced, 78
  - system exercising
    - FRU coverage (table), 106
  - system LEDs, 14
    - isolating faults with, 172
  - system memory
    - determining amount of, 94
  - system specifications, *See* specifications

## T

- temperature sensors, 20
- temperatures, displaying system, 90
- terminal, alphanumeric, 133
- terminal, baud verification, 132
- terms
  - in diagnostic output (table), 114
- test command (OpenBoot Diagnostics tests), 87
- test-all command (OpenBoot Diagnostics tests), 88
- test-args variable, 86
  - keywords for (table), 86
- thermistors, 20
- third-party monitoring tools, 104
- tip connection, 129

Tivoli Enterprise Console, *See* third-party monitoring tools

tree, device, 103  
defined, 85

## U

uadmin command (Solaris), 50, 127

Universal Serial Bus (USB) ports  
about, 46  
connecting to, 46

## V

/var/adm/messages file, 93  
/var/crash directory, 157  
verifying baud rate, 132  
voltages, displaying system, 90

## W

warnings and cautions, 221, 237  
watchdog, hardware  
described, 23  
World Wide Name (*probe-scsi*), 91

## X

XIR (externally initiated reset), 51, 127  
described, 23  
manual command, 23

## Free Manuals Download Website

<http://myh66.com>

<http://usermanuals.us>

<http://www.somanuals.com>

<http://www.4manuals.cc>

<http://www.manual-lib.com>

<http://www.404manual.com>

<http://www.luxmanual.com>

<http://aubethermostatmanual.com>

Golf course search by state

<http://golfingnear.com>

Email search by domain

<http://emailbydomain.com>

Auto manuals search

<http://auto.somanuals.com>

TV manuals search

<http://tv.somanuals.com>