



Sun Netra™ CP3250 Blade Server User's Guide

Sun Microsystems, Inc.
www.sun.com

Part No. 820-5195-11
April 2009, Revision 01

Submit comments about this document at: <http://www.sun.com/hwdocs/feedback>

Copyright © 2009 Sun Microsystems, Inc., 4150 Network Circle, Santa Clara, California 95054, U.S.A. All rights reserved.

This distribution may include materials developed by third parties.

Parts of the product may be derived from Berkeley BSD systems, licensed from the University of California. UNIX is a registered trademark in the U.S. and in other countries, exclusively licensed through X/Open Company, Ltd.

Sun, Sun Microsystems, the Sun logo, Netra, Sun Ray, the Netra logo and the Solaris logo are trademarks or registered trademarks of Sun Microsystems, Inc., or its subsidiaries, in the U.S. and other countries.

All SPARC trademarks are used under license and are trademarks or registered trademarks of SPARC International, Inc. in the U.S. and other countries. Products bearing SPARC trademarks are based upon architecture developed by Sun Microsystems, Inc.

Use of any spare or replacement CPUs is limited to repair or one-for-one replacement of CPUs in products exported in compliance with U.S. export laws. Use of CPUs as product upgrades unless authorized by the U.S. Government is strictly prohibited.

DOCUMENTATION IS PROVIDED "AS IS" AND ALL EXPRESS OR IMPLIED CONDITIONS, REPRESENTATIONS AND WARRANTIES, INCLUDING ANY IMPLIED WARRANTY OF MERCHANTABILITY, FITNESS FOR A PARTICULAR PURPOSE OR NON-INFRINGEMENT, ARE DISCLAIMED, EXCEPT TO THE EXTENT THAT SUCH DISCLAIMERS ARE HELD TO BE LEGALLY INVALID.

Copyright © 2009 Sun Microsystems, Inc., 4150 Network Circle, Santa Clara, California 95054, Etats-Unis. Tous droits réservés.

Cette distribution peut comprendre des composants développés par des tierces parties.

Des parties de ce produit pourront être dérivées des systèmes Berkeley BSD licenciés par l'Université de Californie. UNIX est une marque déposée aux Etats-Unis et dans d'autres pays et licenciée exclusivement par X/Open Company, Ltd.

Sun, Sun Microsystems, le logo Sun, Netra, Sun Ray, le logo Netra et le logo Solaris sont des marques de fabrique ou des marques déposées de Sun Microsystems, Inc., ou ses filiales, aux Etats-Unis et dans d'autres pays.

Toutes les marques SPARC sont utilisées sous licence et sont des marques de fabrique ou des marques déposées de SPARC International, Inc. aux Etats-Unis et dans d'autres pays. Les produits portant les marques SPARC sont basés sur une architecture développée par Sun Microsystems, Inc.

L'utilisation de pieces detachees ou d'unités centrales de remplacement est limitée aux reparations ou a l'échange standard d'unités centrales pour les produits exportés, conformément a la legislation americaine en matiere d'exportation. Sauf autorisation par les autorités des Etats-Unis, l'utilisation d'unités centrales pour proceder a des mises a jour de produits est rigoureusement interdite.

LA DOCUMENTATION EST FOURNIE "EN L'ETAT" ET TOUTES AUTRES CONDITIONS, DECLARATIONS ET GARANTIES EXPRESSES OU TACITES SONT FORMELLEMENT EXCLUES, DANS LA MESURE AUTORISEE PAR LA LOI APPLICABLE, Y COMPRIS NOTAMMENT TOUTE GARANTIE IMPLICITE RELATIVE A LA QUALITE MARCHANDE, A L'APTITUDE A UNE UTILISATION PARTICULIERE OU A L'ABSENCE DE CONTREFACON.



Please
Recycle



Adobe PostScript

Contents

Preface xiii

1. Overview 1-1

1.1 Overview 1-2

1.2 Features 1-2

1.3 Physical Description 1-4

1.3.1 Front Panel Components 1-4

1.3.2 Blade Server Diagram 1-6

1.4 System Configurations 1-7

1.4.1 AMC 1-8

1.4.2 Advanced Rear Transition Module 1-8

1.5 Hot-Swap Support 1-11

1.6 System Components 1-11

1.6.1 Required Hardware Components 1-11

1.6.2 Optional Hardware Components 1-12

1.6.3 Software Components 1-12

1.7 Technical Support and Warranty 1-13

1.7.1 Locating the Part Number and Serial Number Information 1-13

1.7.2 Viewing the Electronic Blade Server ID Information 1-14

- 2. Hardware Installation and Service 2-1**
 - 2.1 Safety and Tool Requirements 2-2
 - 2.1.1 Equipment and Operator Safety 2-2
 - 2.1.2 Materials and Tools Required 2-3
 - 2.2 Installing the Blade Server 2-4
 - 2.2.1 Preparing for the Installation 2-4
 - 2.2.1.1 Check Power, Thermal, Environmental, and Space Requirements 2-4
 - 2.2.1.2 Local Network IP Addresses and Host Names Worksheet 2-5
 - 2.2.1.3 Installation Procedure Summary 2-6
 - 2.2.2 Configuring the Hardware 2-6
 - 2.2.2.1 Verify Chassis Fan Tray Upgrade 2-6
 - 2.2.2.2 Installing Optional Components 2-7
 - 2.2.2.3 Configuring the Advanced Rear Transition Module (ARTM) 2-7
 - 2.2.3 Installing the Netra CP3250 Blade Server in an ATCA Shelf 2-8
 - 2.2.3.1 Installing an Advanced Rear Transition Module (ARTM) 2-8
 - 2.2.3.2 Installing the Blade Server Into the Shelf 2-11
 - 2.2.4 Connecting External I/O Cables 2-13
 - 2.2.4.1 Connecting Cables to a System Console Running the Solaris OS 2-13
 - 2.2.4.2 Connecting Cables to the System Console Not Running the Solaris OS 2-15
 - 2.2.4.3 Netinstall Boot Device Map 2-15
 - 2.3 Service Procedures 2-17
 - 2.3.1 Hot-Swapping the Netra CP3250 Blade Server 2-17
 - 2.3.2 Powering Off the Netra CP3250 Blade Server 2-17
 - 2.3.3 Removing the Netra CP3250 Blade Server 2-18
 - 2.3.4 Powering On the System 2-18

- 2.3.5 Automatic Power-Off Events 2-18
- 2.3.6 Servicing DIMMs 2-19
 - 2.3.6.1 DIMM Requirements 2-19
 - 2.3.6.2 Installing a DDR2 DIMM 2-21
 - 2.3.6.3 Removing a DDR2 DIMM 2-23
- 2.3.7 Installing the Optional Compact Flash Card 2-24
- 2.3.8 Installing Optional AMC 2-27
- 2.3.9 Adding or Replacing the Battery 2-30
- 2.3.10 Changing Jumper Settings 2-31
 - 2.3.10.1 Clearing the CMOS Setting Using Jumper 2 2-31
 - 2.3.10.2 Changing the OOS LED Color Using Jumper 13 2-32
- 2.3.11 Checking DIP Switch Settings 2-33
- 2.3.12 Resetting the Netra CP3250 Blade Server 2-34

3. Hardware Architecture 3-1

- 3.1 Block Diagram 3-2
- 3.2 Intel Processors 3-3
- 3.3 Intel San Clemente MCH 3-3
- 3.4 Memory 3-4
- 3.5 Networking and I/O 3-5
 - 3.5.1 ICH9 I/O Controller Hub 3-5
 - 3.5.2 PCI Express Bus 3-5
 - 3.5.3 LPC Bus Interface 3-6
 - 3.5.4 Redundant BIOS 3-6
 - 3.5.5 Trusted Platform Module (TPM) 3-7
 - 3.5.6 IPMC 3-7
 - 3.5.7 RS-232 Serial Ports 3-7
 - 3.5.8 Broadcom 5715C Gigabit Ethernet 3-8

3.5.9	Sun Dual 10-Gbit Ethernet/Quad 1-Gbit RGMII Network Interface Chip	3-8
3.6	I/O Components	3-8
3.6.1	AMC Slot	3-8
3.6.2	EIDE/ATA for Compact Flash	3-9
3.6.3	SAS/SATA	3-9
4.	Software Configuration	4-1
4.1	Operating Systems	4-2
4.2	Software Updates	4-2
4.3	SunVTS Software	4-3
4.4	Configuring Sun Netra CP3250 blade server For 1 GbE or 10 GbE Switches	4-4
5.	Configuring and Using BIOS Firmware	5-1
5.1	About BIOS Settings	5-2
5.1.1	Navigating BIOS Screens	5-2
5.1.2	BIOS Option ROMs	5-2
5.1.3	Description of the BIOS Screens	5-3
5.2	Changing the Configuration of a BIOS Menu Item	5-3
5.3	Setting the Boot Device Using BIOS Setup Screens	5-4
5.4	Setting Supervisor and User Passwords	5-5
5.5	Resetting the System Time and System Date	5-6
5.6	Updating the BIOS	5-6
5.7	Secondary BIOS Image	5-7
5.8	Perform a Live Firmware Upgrade	5-8
5.9	Power-On Self-Test	5-8
5.10	Changing POST Options	5-9
A.	BIOS Screens	A-1

B. Physical Characteristics B-1

- B.1 Form Factor B-2
- B.2 Power and Thermal Metrics B-2
- B.3 Connectors and Pinouts B-2
 - B.3.1 Front Panel Connectors B-2
 - B.3.1.1 Ethernet Port B-3
 - B.3.1.2 USB Ports B-4
 - B.3.1.3 Serial Port B-5
 - B.3.2 AMC Connector B-5
 - B.3.3 Power Connector (Zone 1) B-6
 - B.3.4 Data Transport Connector (Zone 2) B-8
 - B.3.5 Advanced Rear Transition Module (ARTM) Connector (Zone 3) B-9
 - B.3.5.1 Zone 3 (J30) Connector Pin Assignments B-10
 - B.3.5.2 Zone 3 (J31) Connector PIN Assignments B-11
 - B.3.5.3 Zone 3 (J32) Connector PIN Assignments B-12
 - B.3.5.4 Zone 3 (J33) Connector PIN Assignments B-13
 - B.3.5.5 Zone 3 Signal Descriptions B-14

C. ShMM CLI and Commands C-1

- C.1 Shelf Manager Command-Line Interface C-2
- C.2 Shelf Manager CLI Commands C-3

Index Index-1

Figures

- FIGURE 1-1 Netra CP3250 Blade Server (Front View) 1–4
- FIGURE 1-2 Netra CP3250 Blade Server (Component Side View) 1–6
- FIGURE 1-3 Netra CP3250 Blade Server in Shelf Enclosure 1–7
- FIGURE 1-4 Netra CP3250 Blade Server, Backplane, and Relationship to ARTM 1–9
- FIGURE 1-5 Netra CP3250 Blade Server Barcode Labeling 1–14
- FIGURE 2-1 Installing a Netra CP32x0 ARTM 2–9
- FIGURE 2-2 Injector/Ejector Latch and Locking Screw on the ARTM 2–10
- FIGURE 2-3 Engaging the Netra CP3250 Blade Server Latch 2–12
- FIGURE 2-4 Serial Port on the Netra CP3250 Blade Server 2–14
- FIGURE 2-5 Locating DIMM Slots 2–20
- FIGURE 2-6 Installing a DIMM 2–22
- FIGURE 2-7 Removing a DIMM 2–24
- FIGURE 2-8 Opening the Door to Access Compact Flash 2–25
- FIGURE 2-9 Compact Flash Location 2–26
- FIGURE 2-10 Removing an AMC Filler Panel 2–28
- FIGURE 2-11 Installing an AMC 2–29
- FIGURE 2-12 Jumper 2 in the Default Run Position 2–31
- FIGURE 2-13 SW1 Default DIP Switch Settings 2–33
- FIGURE 2-14 SW4 Default DIP Switch Settings 2–33
- FIGURE 2-15 SW5 Default DIP Switch Settings 2–34

FIGURE 2-16	Netra CP3250 Blade Server Front Panel	2-35
FIGURE A-1	BIOS Main Menu	A-2
FIGURE A-2	Advanced Configuration Menu	A-3
FIGURE A-3	CPU Configuration Menu	A-4
FIGURE A-4	IDE Configuration Menu	A-5
FIGURE A-5	USB Configuration Menu	A-6
FIGURE A-6	Event Log Control Menu	A-7
FIGURE A-7	IPMI 2.0 Configuration Menu	A-8
FIGURE A-8	Remote Access Configuration Menu	A-9
FIGURE A-9	PCI Option ROM Configuration Menu	A-10
FIGURE A-10	Trusted Computing Menu	A-11
FIGURE A-11	Boot Settings Menu	A-12
FIGURE A-12	Boot Device Priority Configuration Menu	A-13
FIGURE A-13	Security Settings Menu	A-14
FIGURE A-14	Exit Menu	A-15
FIGURE B-1	Ethernet RJ-45 Connector	B-3
FIGURE B-2	Front Panel USB Connector	B-4
FIGURE B-3	Front Panel Serial RJ-45 Connector	B-5
FIGURE B-4	Power Distribution Connector (Zone 1) P10	B-6
FIGURE B-5	Zone 2 Connector	B-8
FIGURE B-6	Zone 3 Connector	B-10

Tables

TABLE 1-1	I/O Configurations	1–10
TABLE 1-2	FRU ID Areas	1–15
TABLE 2-1	Local Area Network Information	2–5
TABLE 2-2	Netinstall Boot Device Table	2–15
TABLE 2-3	Extra MAC Addresses for Virtual LAN Configuration	2–16
TABLE 2-4	Pin Functions on Jumper 2	2–31
TABLE 5-1	BIOS Setup Screens Summary	5–3
TABLE 5-2	POST Options	5–9
TABLE B-1	Ethernet Port Connector Pin Assignments	B–3
TABLE B-2	USB Port Pin Assignments	B–4
TABLE B-3	Serial Port Mini DIN 8-pin Connector Pinouts	B–5
TABLE B-4	Power Distribution Connector Pin Assignments	B–6
TABLE B-5	Zone 2 Connector Pin Assignments	B–8
TABLE B-6	J30 Pin Connector Assignments	B–10
TABLE B-7	J31 Connector Pin Assignments	B–11
TABLE B-8	J32 Connector Pin Assignments	B–12
TABLE B-9	J33 Connector Pin Assignments	B–13
TABLE B-10	Zone 3 Signal Descriptions	B–14
TABLE C-1	Shelf Manager CLI Command Summary	C–3

Preface

The *Sun Netra CP3250 Blade Server User's Guide* describes the hardware specifications, function, and physical properties of the Sun Netra™ CP3250 blade server. It also provides detailed information on the system firmware.

The *Sun Netra CP3250 Blade Server User's Guide* is written for system integration engineers, field applications and service engineers, and others involved in the integration of this blade server into systems. This guide is written for personnel who are familiar with the Solaris™ Operating System, the Linux operating systems and Advanced Telecommunications Computing Architecture (ATCA) computing environment.

How This Document Is Organized

[Chapter 1](#) provides an overview of the Sun Netra CP3250 blade server.

[Chapter 2](#) provides instructions on hardware installation.

[Chapter 3](#) provides information on hardware architecture.

[Chapter 4](#) provides information on the supported operating systems and on the Sun Validation Test Suite (SunVTS™) software.

[Chapter 5](#) provides information on the BIOS (Basic Input Output System).

[Appendix A](#) provides first-level and second-level BIOS menu illustrations.

[Appendix B](#) provides information on the Sun Netra CP3250 blade server physical characteristics.

[Appendix C](#) provides a list of the most commonly used ShMM commands.

Using UNIX Commands

This document might not contain information about basic UNIX® commands and procedures such as shutting down the system, booting the system, and configuring devices. Refer to the following for this information:

- Software documentation that you received with your system
- Solaris™ Operating System documentation, which is at:

<http://docs.sun.com/app/docs/prod/solaris>

Shell Prompts

Shell	Prompt
C shell	<i>machine-name%</i>
C shell superuser	<i>machine-name#</i>
Bourne shell and Korn shell	\$
Bourne shell and Korn shell superuser	#

Typographic Conventions

Typeface*	Meaning	Examples
AaBbCc123	The names of commands, files, and directories; on-screen computer output	Edit your <code>.login</code> file. Use <code>ls -a</code> to list all files. % You have mail.
AaBbCc123	What you type, when contrasted with on-screen computer output	% su password:
<i>AaBbCc123</i>	Book titles, new words or terms, words to be emphasized. Replace command-line variables with real names or values.	Read Chapter 6 in the <i>User's Guide</i> . These are called <i>class</i> options. You <i>must</i> be superuser to do this. To delete a file, type <code>rm filename</code> .

* The settings on your browser might differ from these settings.

Related Documentation

For additional information about the Sun Netra CP3250 blade server or the Netra CP32x0 advanced rear transition module (ARTM), refer to the following documents

The following table lists the documentation for this product. The online documentation is available at:

<http://docs.sun.com/app/docs/prod/cp3250.brd#hic>

Application	Title	Part Number	Format	Location
Installation and Service	<i>Sun Netra CP3250 Blade Server User's Guide</i> (this manual)	820-5195	PDF, HTML	Online
Pointer Doclette	<i>Netra CP3250 Blade Server Getting Started Guide</i>	820-5197	Printed, PDF, HTML	Shipkit

Application	Title	Part Number	Format	Location
Late-breaking Information	<i>Netra CP3250 Blade Server Product Notes</i>	820-5194	PDF, HTML	Online
Safety Information	<i>Netra CP3250 Blade Server Safety and Compliance Guide</i>	820-5198	PDF, HTML	Online
Safety Information	<i>Important Safety Information for Sun Hardware Systems</i>	816-7190	Printed	Shipkit

The following table lists the documentation that is related to this product.

Application	Title	Part Number	Format	Location
Installation and Configuration	<i>Sun Netra CP32x0 SAS Storage Advanced Rear Transition Module, Dual HD User's Guide</i>	820-3147	PDF, HTML	Online
	http://docs.sun.com/app/docs/prod/cp32x0.sas#hic			
Installation and Configuration	<i>Sun Netra™ CP32x0 Quad GbE, Dual Fibre Channel, Advanced Rear Transition Module, User's Guide</i>	820-3148	PDF, HTML	Online
	http://docs.sun.com/app/docs/prod/cp32x0.4gbefc?l=en#hic			
Installation and Configuration	<i>Sun Netra™ CP32x0 10GbE Advanced Rear Transition Module, Dual Port User's Guide</i>	820-3150	PDF, HTML	Online
	http://docs.sun.com/app/docs/prod/cp32x0.10gbee?l=en#hic			

Documentation, Support, and Training

Sun Function	URL
Documentation	http://docs.sun.com/
Support	http://www.sun.com/support/
Training	http://www.sun.com/training/

Third-Party Web Sites

Sun is not responsible for the availability of third-party web sites mentioned in this document. Sun does not endorse and is not responsible or liable for any content, advertising, products, or other materials that are available on or through such sites or resources. Sun will not be responsible or liable for any actual or alleged damage or loss caused by or in connection with the use of or reliance on any such content, goods, or services that are available on or through such sites or resources.

Sun Welcomes Your Comments

Sun is interested in improving its documentation and welcomes your comments and suggestions. You can submit your comments by going to:

<http://www.sun.com/hwdocs/feedback>

Please include the title and part number of your document with your feedback:

Sun Netra CP3250 Blade Server User's Guide, part number 820-5195.

Overview

This chapter provides an overview of the features, configurations, and system requirements of the Sun Netra CP3250 blade server.

This chapter contains the following sections:

- Section 1.1, “Overview” on page 1-2
- Section 1.2, “Features” on page 1-2
- Section 1.3, “Physical Description” on page 1-4
- Section 1.4, “System Configurations” on page 1-7
- Section 1.5, “Hot-Swap Support” on page 1-11
- Section 1.6, “System Components” on page 1-11
- Section 1.7, “Technical Support and Warranty” on page 1-13

1.1 Overview

The Sun Netra CP3250 blade server is a dual-socket quad-core Intel-based ATCA blade for high performance ATCA x86 applications in wireless infrastructure and central office consolidation.

This blade server complies with the AdvancedTCA specification and is a new addition to SUN's ATCA product family.

The ATCA standard comprises the PICMG 3.0, 3.1, 3.2, and 3.3 versions of the standard. The Sun Netra CP3250 blade server complies with the following specifications:

- PICMG 3.0, the base specification that defines the mechanical, power distribution, system management, data transport, and regulatory guidelines.
- PICMG 3.1, which builds on the PICMG 3.0 base specification and on IEEE 802.3-2003.

1.2 Features

The blade server's primary features are as follows:

- ATCA card 322.25 mm x280 mm, 1.2 inch slot height
- Two Harpertown Processor Sockets, QuadCore version @2.135 GHz and up to 40W per CPU
- Intel San Clemente North Bridge and Intel ICH9R I/O controller hub
- DDR2 (registered, with ECC) at 667 MHz, up to six modules/cards, up to 4 GB per DIMM, in very-low-profile design (0.72 inch height)
- Two 1000MBASE-T Ethernet base fabric (PICMG 3.0) interface ports (using BCM5715C) from PCIe x4
- Two 10 Gb XAUI Ethernet extended fabric (PICMG 3.1) interface ports (using Sun Neptune) from PCIe x8
- One AMC.1 Type 8S2E2 expansion slot (PCIe x8) supporting I/O expansion with signaling to the advanced rear transition module (ARTM)
- One Asynchronous serial port routed to front panel and ARTM from SuperIO

- Dual USB 2.0/1.1 ports on front panel
- One 10/100/1000MHBASE-T management port on front panel, with second management LAN sent to ARTM (from BCM 5715C); these are not directly tied into IPM controller.
- SATA to EIDE master to support one Compact Flash Type II socket up to 16 GB of user Flash. Socket is only accessible when blade is removed from chassis
- Redundant BIOS, 8MB
- Management support using on-board IPM controller (Renesas H8) that provides dual IPMB bus. The IPMB bus is to be monitored by the shelf manager, providing redundant IPMI channels
- Rear I/O expansion/connectivity provided to an optional ARTM. Compatible with Sun's current ARTM architecture with upgrade capability to support PICMG working group ARTM.0 standard (Zone 3 Interface)
- SAS connectivity from ARTM to AMC slot
- Contains TPM (Trusted Platform module) chip
- 225W delivered max power for the complete card (including 25W ARTM) via dual, redundant -48 VDC nominal rails
- Certified NEBS compliant in Sun's Netra CT 900 system

1.3 Physical Description

1.3.1 Front Panel Components

FIGURE 1-1 Netra CP3250 Blade Server (Front View)

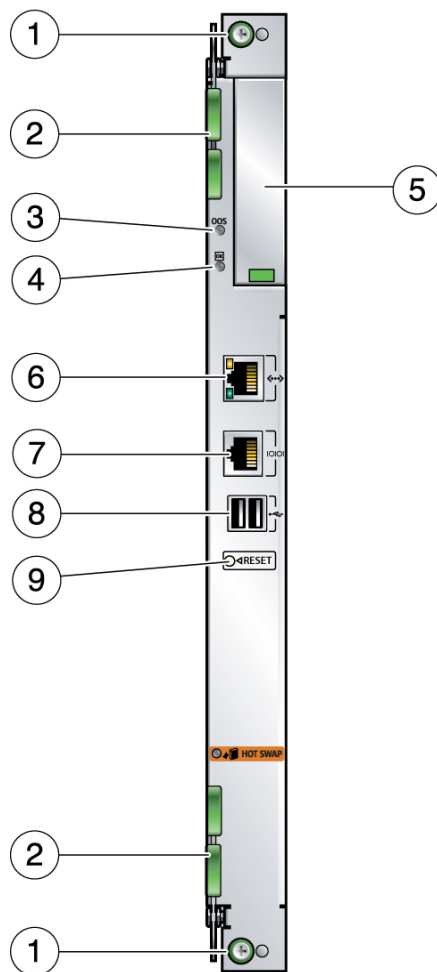

Figure Legend

- | | |
|---|--------------------------------------|
| 1 | Locking screws |
| 2 | Latches |
| 3 | Out-of-service (OOS) LED |
| 4 | OK LED |
| 5 | AMC slot |
| 6 | 10/100/1000 Ethernet management port |
| 7 | Serial port |
| 8 | USB port |
| 9 | Reset button |
-

1.3.2 Blade Server Diagram

FIGURE 1-2 Netra CP3250 Blade Server (Component Side View)

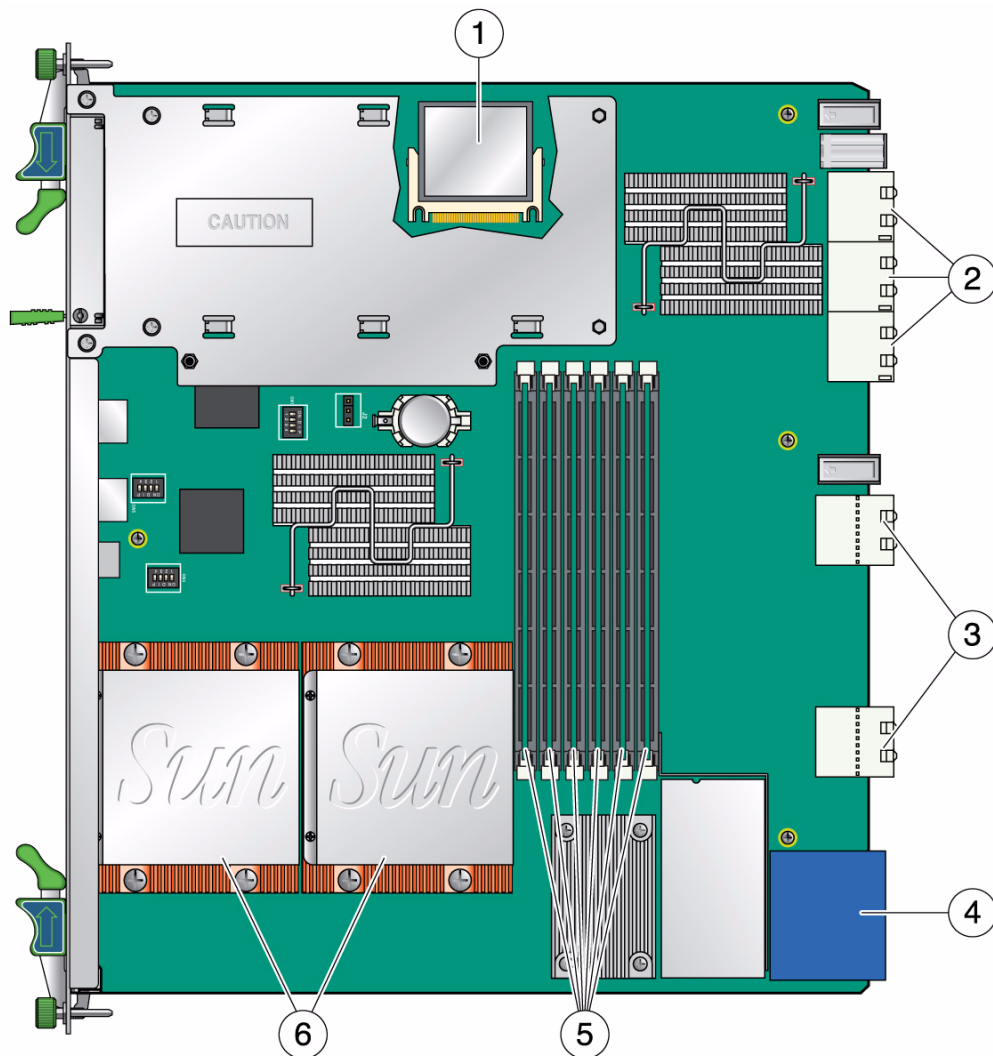

Figure Legend

1	CF card slot	4	Zone 1 power connector
2	Zone 3 connectors	5	DIMMs
3	Zone 2 connectors	6	CPU heatsinks

1.4 System Configurations

Sun Netra CP3250 blade servers can be installed into an ATCA shelf (chassis), as shown in [FIGURE 1-3](#). The blade servers can be deployed in various electrical configurations to suit user requirements. For example, the blade server can be configured to boot from a network as a diskless client with either a front panel or ARTM network connection. The Sun Netra CP3250 blade server has an optional Compact Flash card and connectors for additional memory.

FIGURE 1-3 Netra CP3250 Blade Server in Shelf Enclosure

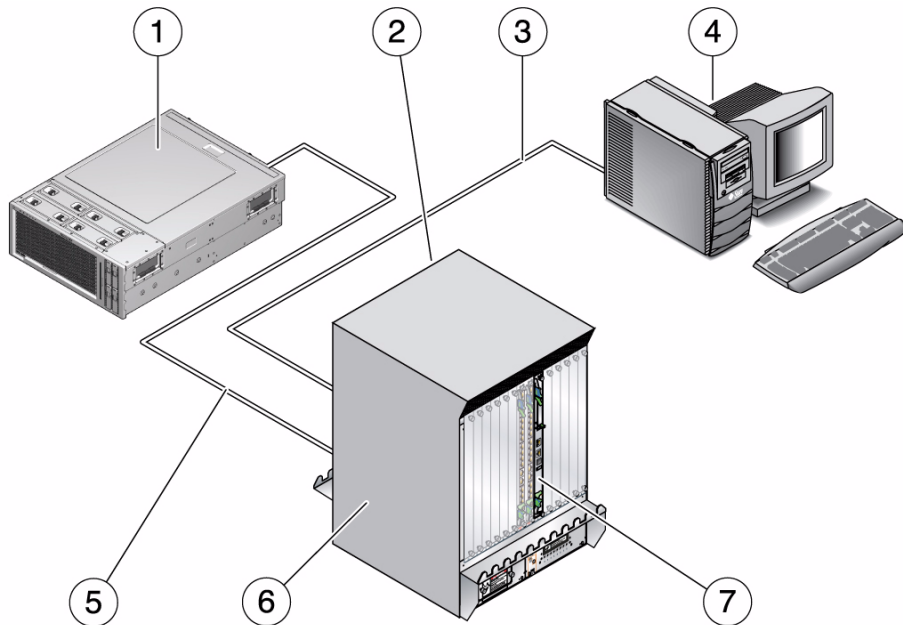

1.4.1 AMC

The Sun Netra CP3250 blade server has one AMC slot, with eight lanes of PCIe, to provide additional I/O to the front panels or to the rear of the enclosure when used with an ARTM.

The Sun Netra CP3250 blade server supports AMC mid-height, single wide cards, as defined by the AMC specification.

1.4.2 Advanced Rear Transition Module

You can install one of the optional Netra CP32x0 advanced rear transition modules (ARTMs) into the rear of the ATCA shelf, opposite the Sun Netra CP3250 blade server.

For more information, refer to the following documentation: *Sun Netra CP32x0 SAS Storage Advanced Rear Transition Module, Dual HD User's Guide* (820-3147) (ARTM-HD)

FIGURE 1-4 shows the physical relationship between the Sun Netra CP3250 blade server, the ARTM, and the backplane in a typical ATCA system.

FIGURE 1-4 Netra CP3250 Blade Server, Backplane, and Relationship to ARTM

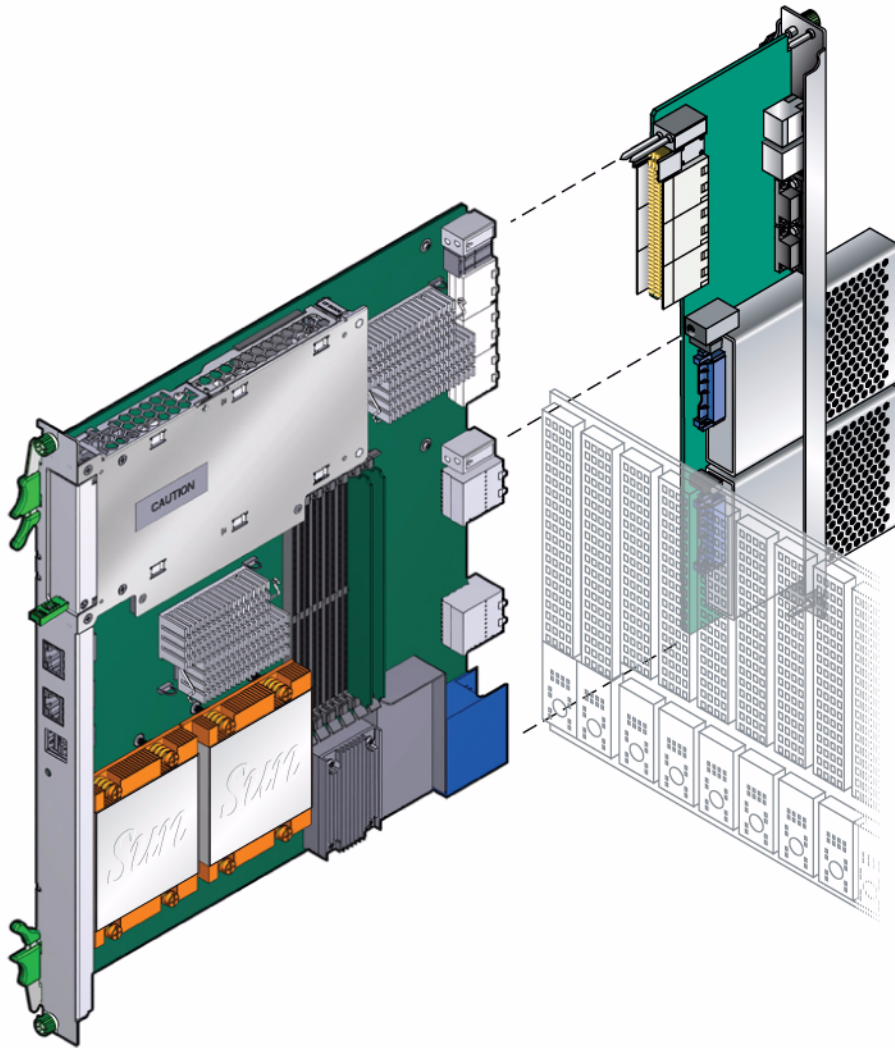

Note – When using the ARTM with the Sun Netra CP3250 blade server, use cables of less than 10 meters in length for serial I/O ports.

You can order a Netra CP32x0 ARTM, build a custom module, or buy one from an IHV. You must set up a minimal set of I/O for a boot path for the host blade server and for a path for console I/O to deliver commands and read blade server and system status.

Possible boot and console configurations are described in [TABLE 1-1](#). Sun Microsystems provides the Sun Netra CP3250 blade server and, optionally, a compatible Netra CP32x0 ARTM. The ARTM provides one 10/100/1000BASE-T per second Ethernet RJ-45 port from the host to the rear of the system. This port can be used to accomplish, optionally, a network boot as a diskless client. The other configurations require IHV hardware.

TABLE 1-1 I/O Configurations

I/O	Hardware Required	Description
Ethernet	Netra CP32x0 ARTM, as an option for rear access	The default boot path uses an Ethernet port; the blade server runs in a diskless client configuration
SAS	Netra 146-GB hard disk and the Netra CP32x0 ARTM-HD	Available with the optional Netra CP32x0 ARTM-HD or through an AMC with SAS capabilities. When the optional ARTM is installed, connect to the drive(s) via SAS ports on the ARTM.
Zone 3	ARTM	
Zone 3	ARTM	
Serial data	Sun Netra CP3250 blade server	Serial port A on the front panel provides the path of the default console I/O.
Serial data	Netra CP32x0 ARTM	When an optional Netra CP32x0 ARTM is installed, the module's serial port A will become the path of the default console I/O (FIGURE 1-4).
Compact Flash	IDE Compact Flash card	Sun Netra CP3250 blade server supports one, optional IDE Compact Flash drive, either 8-Gbyte or 16-Gbyte, installed in a Type II CF socket on the blade server.

1.5 Hot-Swap Support

Hot-swap support for inserting and extracting blade servers is provided in accordance with the ATCA PICMG 3.0 and 3.1 standards.

Hot-swap of the CP3250, ARTM, and AMC is supported in the Netra CT 900 server.

1.6 System Components

This section contains the system-level hardware and software components, required and optional, for the Sun Netra CP3250 blade server.

1.6.1 Required Hardware Components

The Sun Netra CP3250 blade server cannot be used as a stand-alone system. It is designed to be used in an ATCA chassis for 8U boards. The minimum hardware requirements needed to use the Sun Netra CP3250 blade server are:

- ATCA system enclosure for 8U boards (includes shelf, backplane, hub/switch board, shelf manager and power supply)
- Console output device or serial terminal
- Boot device (such as hard drive, network, or Compact Flash card)
- Peripheral device for network access
- IPMC (built in)
- Cables for terminal and network connections
- Netra CT 900 server fan tray upgrade kit (PN 594-4953-01). If you are installing the Sun Netra CP3250 blade server in a Netra CT 900 server that has lower-speed fan trays, you must upgrade the Netra CT 900 server fan trays to support the additional cooling needs of the Sun Netra CP3250 blade server. For more information on the Netra CT 900 server fan tray upgrade kit (PN 594-4953-01), see the *Netra CT 900 Server Upgrade Guide* (820-3255).



Caution – You can damage the Sun Netra CP3250 blade server components if you install the blade server in a chassis that does not provide sufficient cooling. For more information, see [Section 2.2.1.1, “Check Power, Thermal, Environmental, and Space Requirements”](#) on page 2-4.



Note – Use only serial cables that are less than 10 meters in length.

1.6.2 Optional Hardware Components

Sun Microsystems provides the following items for customer order:

- Compact Flash card
- AMCs
- Netra CP32x0 ARTM (optional)

The ARTM is optional and must be ordered separately from the Sun Netra CP3250 blade server.

The optional ARTM enables rear system I/O access to the following:

- Network
 - Boot device
 - Two hot-swappable SAS hard disk drives (optional)
 - Console terminal (FIGURE 1-3).
- Sun Netra CP3240 switch (optional)

The Sun Netra CP3240 switch is capable of operating at 10 GbE, but is set by default to operate at 1GbE. To use the switch at 10 GbE, perform a one-time configuration procedure, available in the *Sun Netra CP3x40 Switch Product Notes* (820-3260).

1.6.3 Software Components

The following OSs are certified for use on Sun Netra CP3250 blade server:

- Solaris™ 10 (05/08) Operating System (Solaris OS)
- WindRiver Linux 3.1
- RedHat Linux 5.2
- Windows 2003

Additional OSs are being tested and will be supported after they are certified.

Refer to the *Netra CP3250 Blade Server Product Notes* (820-5194) for more Solaris OS information, including a list of any required Netra software patches and support for subsequent versions of Solaris and other OSs. You can view and download the latest version of the product notes at the following web site:

<http://docs.sun.com>

Additionally, VMware is a software component certified to work with the Sun Netra CP3250 blade server. It is listed on VMware's HCL at:

http://www.vmware.com/resources/compatibility/search.php?action=search&deviceCategory=server&productId=1&keyBasic=netra&maxDisplayRows=50&key=netra&release%5B%5D=-1&datePosted=-1&stepping=&nsockets=&cores=&max_mem=

1.7 Technical Support and Warranty

Should you have any technical questions or support issues that are not addressed in the Sun Netra CP3250 blade server documentation set or on the technical support web site, contact your local Sun Services representative. This hardware carries a one-year return-to-depot warranty.

For customers in the U.S. or Canada, call 1-800-USA-4SUN (1-800-872-4786).

For customers in the rest of the world, please find the World Wide Solution Center nearest you at the following web site:

http://www.sun.com/contact/services_solutions.jsp

When you call Sun Services, be sure to indicate if the Sun Netra CP3250 blade server was purchased separately, and is not associated with a system. Please have the blade server identification information ready. For proper identification of the blade server, be prepared to give the representative the blade server part number, and serial number.

1.7.1 Locating the Part Number and Serial Number Information

The Sun Netra CP3250 blade server part number, serial number, revision number, and media access control (MAC) address are printed on stickers located on the Sun Netra CP3250 blade server (FIGURE 1-5).

The Sun barcode label provides the following information:

- Blade server serial number (for example, 1005LCB-07296R0912), which is on the barcode label

The part number/dash/revision/date code label provides the following information:

- Blade server part number (for example, 3753529), which is the first seven digits on the part number label
- Product dash number (for example, -01)
- Revision number (for example, REV: 01)

The MAC address label contains the base MAC address for the blade server in printed and barcode form. It is an orange label located on the Zone 1 connector.

FIGURE 1-5 Netra CP3250 Blade Server Barcode Labeling

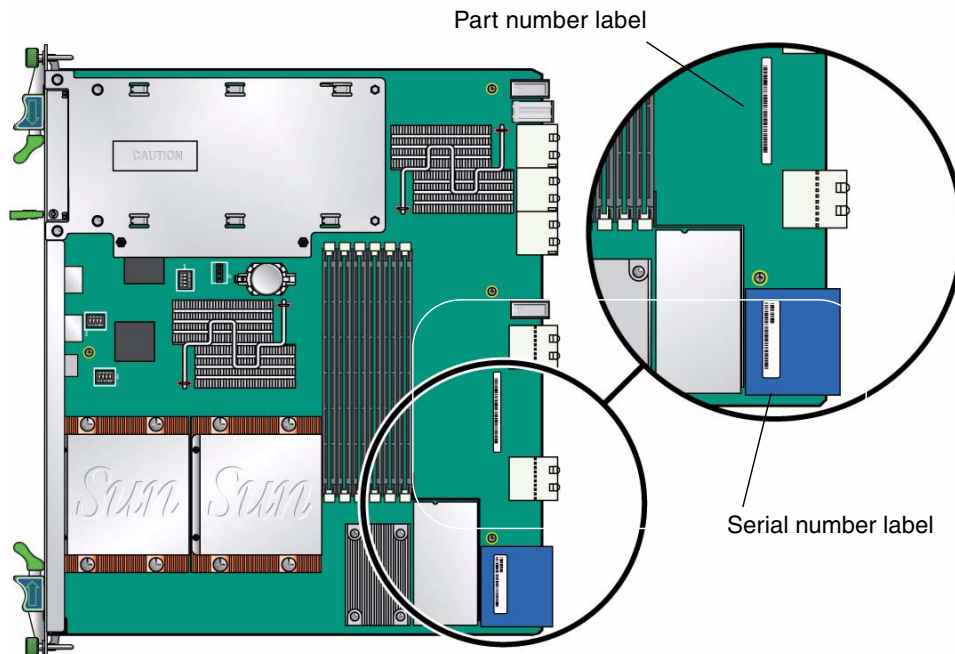

1.7.2 Viewing the Electronic Blade Server ID Information

The Sun Netra CP3250 blade server can be electronically identified through its IPMI FRU ID PROM, which is accessible through standard `fru` utilities.

The IPMI FRU ID PROM format follows the Intel Specification *IPMI Platform Management FRU Information Storage Definition*, v1.0 Document, Revision 1.1, September 27, 1999.

The IPMI FRU ID manufacturing records match Sun part number and serial number labels on the product. For more information about part number and serial number labels, see [Section 1.7.1, “Locating the Part Number and Serial Number Information” on page 1-13.](#)

The IPMI FRU ID contains six FRU ID areas, which are defined in [TABLE 1-2.](#)

TABLE 1-2 FRU ID Areas

FRU Area	Description
COMMON HEADER	Contains header and pointers to other FRUID sections and is used by fru utility software
INTERNAL USE AREA	Not present
CHASSIS INFO AREA	Not present
BOARD INFO AREA	<p>Contains the manufacturing record without memory (FRU part number) for the FRU level assembly of the blade server. This assembly level is equivalent to the FRU replacement that is received from Sun Service.</p> <ul style="list-style-type: none"> • Mfg Date/Time = (Date/Time of blade server assembly) • Manufacturer = {manufacturer name} • Product Name = CP3250 • Serial Number = XXXXXXXX-XXXXXXXXXX (Sun 18-digit format) • Part Number = 00000000PPPPPPDDRR (Sun Part Number) where 0 = Leading zeroes, P= Part Number, D=Dash, R=Rev
PRODUCT INFO AREA	<p>Contains manufacturing record for configured blade server with memory. This assembly level includes the base blade server (FRU) plus memory.</p> <ul style="list-style-type: none"> • Manufacturer = (manufacturer name) • Product Name = CP3250 • Part/Model Number = 00000000PPPPPPDDRR (Sun Part Number) where 0 = Leading zeroes, P= Part Number, D=Dash, R= Rev • Product Version = XXXX (dash/rev) • Serial Number = XXXXXXXX-XXXXXXXXXX (Sun 18-digit format)
MULTIRECORD INFO AREA	Sun Internal Use Only

Hardware Installation and Service

This chapter describes the Sun Netra CP3250 blade server hardware installation and service procedures.

This chapter contains the following sections:

- [Section 2.1, “Safety and Tool Requirements” on page 2-2](#)
- [Section 2.2, “Installing the Blade Server” on page 2-4](#)
- [Section 2.3, “Service Procedures” on page 2-17](#)

2.1 Safety and Tool Requirements

2.1.1 Equipment and Operator Safety

Refer to the *Important Safety Information for Sun Hardware Systems* (816-7190) for general safety information and to the *Netra CP3250 Blade Server Safety and Compliance Guide* (820-5198) for specific safety information.

Read the following safety statements that are specific to the Sun Netra CP3250 blade server carefully before you install or remove any part of the system.



Caution – Depending on the particular chassis design, operations with open equipment enclosures can expose the installer to hazardous voltages with a consequent danger of electric shock. Ensure that line power to the equipment is disconnected during operations that make high voltage conductors accessible.

The installer must be familiar with commonly accepted procedures for integrating electronic systems and the general practice of Sun systems integration and administration. Although parts of these systems are designed for hot-swap operation, other components must not be subjected to such stresses. Work with power connected to a shelf only when necessary, and follow these installation procedures to avoid equipment damage.

This equipment is sensitive to damage from electrostatic discharge (ESD) from clothing and other materials. Use the following antistatic measures during an installation:

- If possible, disconnect line power from the shelf when servicing a system or installing a hardware upgrade. If the shelf cannot be placed on a grounded antistatic mat, connect a grounding strap between the facility electrical input ground (usually connected to the shelf) and facility electrical service ground.
- Use an antistatic wrist strap when performing the following tasks:
 - Removing a blade server from its antistatic bag
 - Connecting or disconnecting blade servers or peripherals

The other end of the antistatic wrist strap lead should be connected to one of the following:

- A ground mat
- The chassis metal as a ground

The grounded mat or the chassis must be connected to a facility ground to prevent a floating ground.

- Keep blade servers in the antistatic bags until they are needed.
- Remove a blade server from its antistatic bag only when wearing a properly connected ground strap.
- Place circuit blade servers that are out of their antistatic bags on an antistatic mat if one is available and the mat is grounded to a facility electrical service ground. Do not place blade servers on top of an antistatic bag unless the outside of the bag also has antistatic protective properties.

2.1.2 Materials and Tools Required

The tools required for installation and service are as follows:

- Phillips screwdrivers: No. 1 (required), No. 2 (optional)
- Antistatic wrist strap
- Terminal console
- Serial cable of less than 10 meters in length to connect the Sun Netra CP3250 blade server with a system console

Refer to [Section 1.6, “System Components”](#) on page 1-11 for information on hardware requirements.

2.2 Installing the Blade Server

2.2.1 Preparing for the Installation

Prepare for installation by reading and performing the following steps.

1. Become familiar with the contents of the documentation referenced in the steps.
2. Verify that all listed hardware and software are available (see [Section 1.6, "System Components" on page 1-11](#)).
3. Check power, thermal, environmental, and space requirements (see [Section 2.2.1.1, "Check Power, Thermal, Environmental, and Space Requirements" on page 2-4](#)).
4. Verify that local area network (LAN) preparations are completed (see [Section 2.2.1.2, "Local Network IP Addresses and Host Names Worksheet" on page 2-5](#)).
5. Ensure that the host names and their network IP addresses are allocated and registered at the site. Record this information in [TABLE 2-1](#).

2.2.1.1 Check Power, Thermal, Environmental, and Space Requirements

Observe that your environment meets the following requirements:

- Your enclosure specifications can support the sum of the specified maximum blade server power loads. (See [Section B.2, "Power and Thermal Metrics" on page B-2](#)).
- Facility power loading specifications can support the rack or enclosure requirements.
- Your enclosure specifications can support the cooling airflow requirements.

The Sun Netra CP3250 blade server fits into a standard ATCA shelf. If your installation requirements are different, contact your field applications engineer.

2.2.1.2 Local Network IP Addresses and Host Names Worksheet

Collect the information listed in [TABLE 2-1](#) to connect hosts to the LAN. Ask your network administrator for help, if necessary. This information is not needed for a stand-alone installation.

TABLE 2-1 Local Area Network Information

Information Needed	Your Information
IP address* and host name for each Sun Netra CP3250 blade server client	_____
Domain name	_____
Type of name service and corresponding name server names and IP addresses—for example DNS and NIS (or NIS+)	_____
Subnet mask	_____
Gateway router IP address	_____
Network File System (NFS) server names and IP addresses	_____
Web server URL	_____

* Local IP addresses are not needed if they are assigned by a network Dynamic Host Configuration Protocol (DHCP) server.

You might need the MAC (Ethernet) addresses of the local hosts to make name server database entries. You can see the MAC address in the console output while booting the blade server. You can also find it on the barcode label on the node blade server (see [Section 1.7.1, “Locating the Part Number and Serial Number Information”](#) on page 1-13).

2.2.1.3 Installation Procedure Summary

This section summarizes the high-level procedures that are required to install the Sun Netra CP3250 blade server. Ensure that you are familiar with the information in [Section 2.2.2, “Configuring the Hardware” on page 2-6](#) through the end of Chapter 2 before installing the blade server.

The process to set up and configure a Sun Netra CP3250 blade server in a system includes the following procedures:

1. Configuring the blade server’s physical hardware.
For example, install the AMC and set switches, as necessary ([Section 2.2.2, “Configuring the Hardware” on page 2-6](#)).
2. Physically installing the advanced rear transition module (ARTM) as necessary ([Section 2.2.3.1, “Installing an Advanced Rear Transition Module \(ARTM\)” on page 2-8](#)).
3. Physically installing the Sun Netra CP3250 blade server, and any peripheral boards into the ATCA shelf [Section 2.2.3, “Installing the Netra CP3250 Blade Server in an ATCA Shelf” on page 2-8](#)).
4. Connecting the nodes to a local network. ([Section 2.2.4, “Connecting External I/O Cables” on page 2-13](#)).
5. Downloading and installing SunVTS ([Section 4.1, “Operating Systems” on page 4-2](#)), if you are running the Solaris Operating System on the Sun Netra CP3250 blade server and want to verify system integrity.

2.2.2 Configuring the Hardware

This section lists hardware installation and settings that might apply to your blade server configuration. Read and perform the procedures, as necessary, before installing the Sun Netra CP3250 blade server into the ATCA shelf.

2.2.2.1 Verify Chassis Fan Tray Upgrade



Caution – The Netra CT 900 server fan tray upgrade kit (594-4953) must be installed in the chassis before the Sun Netra CP3250 blade server is installed. This fan tray upgrade is required to provide adequate cooling and prevent the system from overheating or shutting down due to an over temperature condition that can occur with the older or mismatched fan trays.

- To verify if the fan tray upgrade is installed on a Netra CT 900 server, log into the Shelf Manager and issue the following command for fan trays 1,2, and 3:

```
# clia fruinfo fan_tray 1 | grep "Product Part"
```

If the “Product Part/Model Number” is 370-7764-xx, the fan trays must be replaced with high-speed fan trays. Refer to the *Netra CT 900 Server Upgrade Guide* (820-3255) for more information.

If the “Product Part/Model Number” is 371-3033-xx or newer, an upgraded fan tray is already installed.

2.2.2.2 Installing Optional Components

Use the following table to locate your options and installation instructions.

DIMMs	“DIMM Requirements” on page 2-19 “Installing a DDR2 DIMM” on page 2-21
Compact Flash card	“Installing the Optional Compact Flash Card” on page 2-24
AMC	“Compact Flash Location” on page 2-26

2.2.2.3 Configuring the Advanced Rear Transition Module (ARTM)

If you are using one of the Netra advanced rear transition modules (ARTMs), refer to the documentation: *Netra CP32x0 SAS Storage Advanced Rear Transition Module, Dual HD User’s Guide* (820-3147) (ARTM-HD)

See [Section B.3, “Connectors and Pinouts” on page B-2](#) for detailed connector pin assignments for the Sun Netra CP3250 blade server.

2.2.3 Installing the Netra CP3250 Blade Server in an ATCA Shelf

If you install the Sun Netra CP3250 blade server with an ARTM, the ARTM must be installed first.

Note – Slots 1 through 6 and 9 through 14 are available for Sun Netra CP3250 blade servers. Slots 7 and 8 are reserved for the switch card.

2.2.3.1 Installing an Advanced Rear Transition Module (ARTM)

A compatible ARTM must be used with the Sun Netra CP3250 blade server for rear I/O access. The ARTM enables access to the network, a boot device, and a console terminal. You can use one of the Netra CP32x0 ARTMs or you can design your own ARTM-compatible transition module. For more information, see [Section 1.4.2, “Advanced Rear Transition Module”](#) on page 1-8.

1. Verify that you have taken the necessary antistatic precautions.

See [Section 2.1.1, “Equipment and Operator Safety”](#) on page 2-2.

2. From the rear of the system, choose the corresponding slot for the ARTM.

The rear transition module must be installed, inline, behind a compatible Netra blade server.

For example, if the Sun Netra CP3250 blade server will be installed in slot 3, the corresponding rear transition module must be installed at the back of the system in slot 3 ([FIGURE 2-1](#)). If you do not install the rear transition module and the Sun Netra CP3250 blade server in corresponding slots, the system will recognize the Sun Netra CP3250 blade server and not the rear transition module.

Note – Slots 1 through 6 and 9 through 14 are available for Sun Netra CP3250 blade servers. Slots 7 and 8 are reserved for the switch card.

FIGURE 2-1 Installing a Netra CP32x0 ARTM

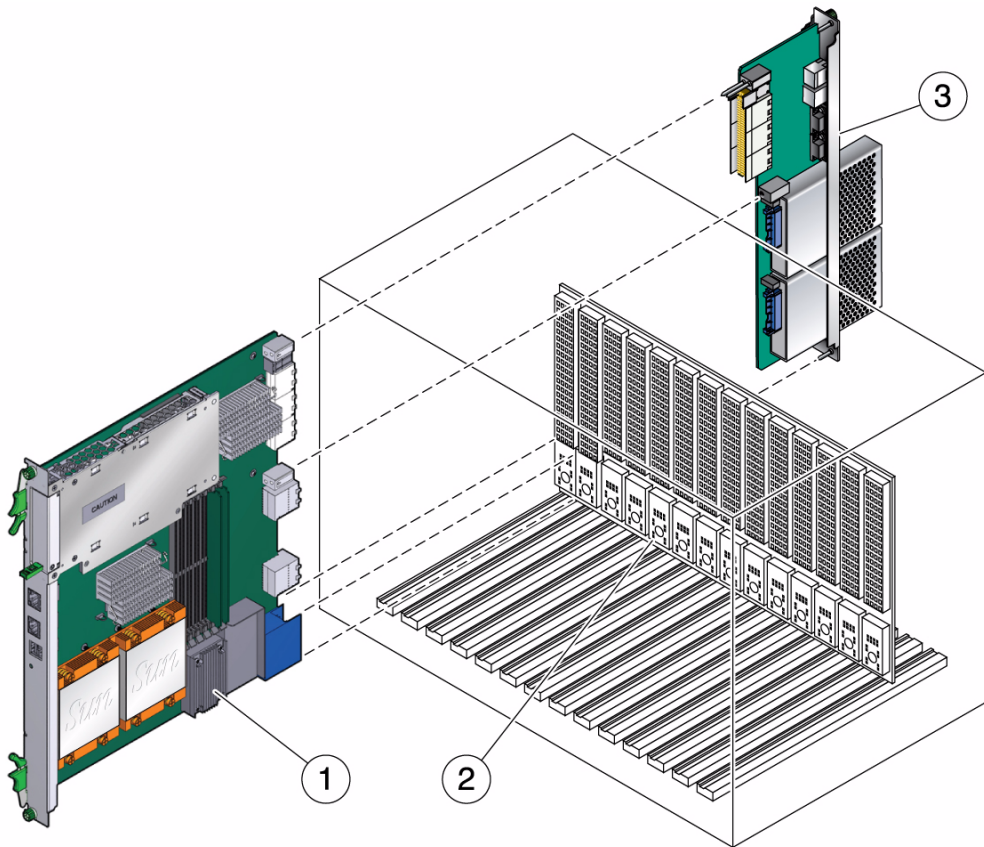

3. Remove the slot filler panel from the selected slot, if necessary.
4. Retrieve the advanced rear transition module (ARTM) from the ship kit.
5. Prepare the rear transition module by opening the injector/ejector latch at the top of the module (FIGURE 2-2).

FIGURE 2-2 Injector/Ejector Latch and Locking Screw on the ARTM

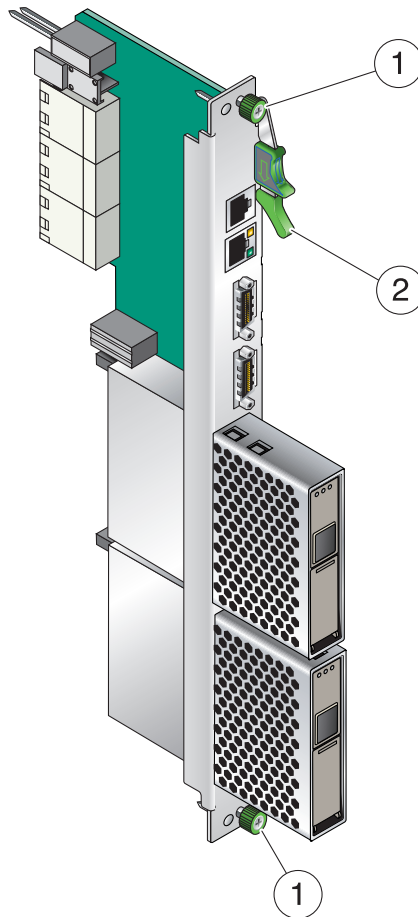

6. Carefully align the edges of the ARTM with the card guides in the appropriate slot.
Look into the enclosure to verify correct alignment of the rails in the guides.
7. Keep the ARTM aligned in the guides, and slide the module in until the injector/ejector latches engage the card cage.
8. Push the ARTM into the backplane connectors, and close the latch.
9. Tighten the locking screws to ensure that the module is secured into the ATCA shelf.

10. **Install the Sun Netra CP3250 blade server into the front of the ATCA shelf in the corresponding slot.**

See [Section 2.2.3.2, “Installing the Blade Server Into the Shelf”](#) on page 2-11 for instructions.

2.2.3.2 Installing the Blade Server Into the Shelf

Note – You can install the Sun Netra CP3250 blade server in any available slot in the ATCA shelf except for slots 7 and 8.

1. **If you have installed an advanced rear transition module (ARTM), go to the front of the system and locate the corresponding slot number of the ARTM.**
2. **Remove the filler panel from the blade server slot, if necessary.**

The filler panel is secured to the card cage using two screws, one at the top of the filler panel, the other at the bottom. Store the filler panel in a safe place; you might need to use it again if you remove a blade server for an extended time.
3. **Prepare the Sun Netra CP3250 blade server by opening the injector/ejector latches.**
4. **Carefully align the edges of the blade server with the guides in the appropriate slot.**

Look into the enclosure to verify correct alignment of the rails in the guides.
5. **Keep the blade server aligned in the guides and slide the blade server in until the injector/ejector latches engage the card cage.**
6. **Push the blade server slightly into the backplane connectors and close the latches to seat the blade server in the connectors (FIGURE 2-3).**

Push the upper latch lever to engage the blade server. When the upper and lower levers are engaged properly, the blue Hot-Swap LED blinks while the blade server is initializing. The blue LED turns off and the green OK LED lights when the blade server is ready for use.

Note – If the hot-swap LED does not light, then wiggle and push the latch so it engages the hot-swap switch.

FIGURE 2-3 Engaging the Netra CP3250 Blade Server Latch

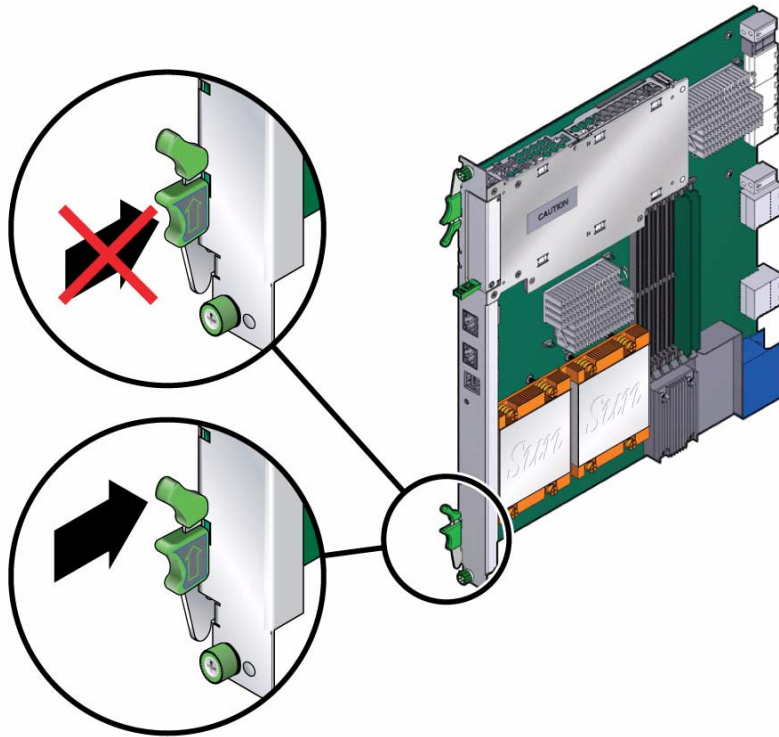

7. Tighten the locking screws and the top and the bottom of the Sun Netra CP3250 blade server to ensure that it is secured to the ATCA shelf (FIGURE 2-2).

The blade server is now completely installed and will power on automatically.

8. Configure the switches accordingly as described in Section 4.4, "Configuring Sun Netra CP3250 blade server For 1 GbE or 10 GbE Switches" on page 4-4.

2.2.4 Connecting External I/O Cables

Front panel ports are typically used for maintenance and troubleshooting purposes in installed and running systems. External I/O cables are connected to the Sun Netra CP3250 blade server or to the Netra CP32x0 rear transition module when a rear transition module is used.

To connect each of these following cables:

- For Ethernet connections, Category 5e or better, network cable is required. Connect one end of the Ethernet cable to a suitable 10/100/1000 MBASE-T Ethernet switch and the other end to one of the Ethernet ports on the Sun Netra CP3250 blade server or the Netra CP32x0 ARTM.
- Attach asynchronous serial I/O cables from serial communication devices to the RJ-45 serial ports on the Sun Netra CP3250 blade server or Netra CP32x0 ARTM.

2.2.4.1 Connecting Cables to a System Console Running the Solaris OS

1. **Connect a RJ-45 style serial cable to the serial console port on the front panel of the Sun Netra CP3250 blade server (FIGURE 2-4) or the Netra CP32x0 rear transition module.**

Serial access (both front and rear) is through the same serial interface controller. If both ports are connected at the same time, console input and output can be performed through both, however, this configuration is not recommended. If both access interfaces are not connected at the same time, console input/output can be performed through NetConsole session via the ShMM.

2. **Connect the other end of the serial cable to the serial port of the system serving as the serial console.**

- A telnet utility (Connect to the proper port on a Network Terminal Server to which the Sun Netra CP3250 blade server is connected.)
- Another suitable serial communications program on the system console
For example, if you are using a UNIX system as the system console, at the UNIX prompt in a command tool or shell tool, or serial port A, type:

```
# tip -9600 /dev/ttya
```

2.2.4.2 Connecting Cables to the System Console Not Running the Solaris OS

1. Connect a serial cable to the serial console port on the front panel of the Sun Netra CP3250 blade server (FIGURE 2-4) or the Netra CP32x0 rear transition module.
2. Connect the other end of the serial cable to the serial port of the system serving as the system console.
3. Set the serial communications settings to 9600 baud, 8 bit, 1 stop bit, no parity, and no handshake.

2.2.4.3 Netinstall Boot Device Map

TABLE 2-2 provides a map of netinstall boot devices. You may need this information to understand which MAC address is associated with the system IP address on the install server.

For example, the Base Fabric interface is connected to the switch model-number in slot 8 of the ATCA shelf. To install to this device, select the xxx Ethernet interface from the BIOS setup menus.

TABLE 2-2 Netinstall Boot Device Table

MAC Address	Solaris Device	Hardware Device	Connects to...	Switch Slot Connection
00:14:4f:xx.yy.zz+0	bge0	(BMC5715C)	Base Fabric 0	Slot 7
00:14:4f:xx.yy.zz+1	bge1	(BMC5715C)	Base Fabric 1	Slot 8
00:14:4f:xx.yy.zz+2	bge2	(MCP55) and (BCM5715C)	mgtA (front panel)	
00:14:4f:xx.yy.zz+3	bge3	(MCP55) and (BCM5715C)	mgtB (rear panel)	

TABLE 2-2 Netinstall Boot Device Table (Continued)

MAC Address	Solaris Device	Hardware Device	Connects to...	Switch Slot Connection
00:14:4f:xx.yy.zz+4	nxge0	(Sun 10 GbE Multithreaded Networking Technolgy 10 GB)	Extended Fabric 0	Slot 7
0:14:4f.xx.xn+5	nxge1	(Sun 10 GbE Multithreaded Networking Technolgy 10 GB)	Extended Fabric 1	Slot 8
0:14:4f.xx.xn+6	nxge2	(Sun 10 GbE Multithreaded Networking Technolgy 1 GB)	AMC and ARTM	
0:14:4f.xx.xn+7	nxge3	(Sun 10 GbE Multithreaded Networking Technolgy 1 GB)	AMC and ARTM	

The Sun Netra CP3250 blade server supports virtual LAN configuration for the Sun 10 GbE Multithreaded Networking Technolgy ports (MAC addresses 4, 5, 6, and 7). When configured, the virtual LAN feature enables the assignment of multiple MAC address to one port. [TABLE 2-3](#) lists the extra MAC addresses available for the Sun 10 GbE Multithreaded Networking Technolgy ports.

TABLE 2-3 Extra MAC Addresses for Virtual LAN Configuration

Primary MAC Address	Additional MAC Addresses
0:14:4f.xx.xn+4	0:14:4f.xx.xn+8 through 0:14:4f.xx.xn+14
0:14:4f.xx.xn+5	0:14:4f.xx.xn+15 through 0:14:4f.xx.xn+21
0:14:4f.xx.xn+6	0:14:4f.xx.xn+22 through 0:14:4f.xx.xn+28
0:14:4f.xx.xn+7	0:14:4f.xx.xn+29 through 0:14:4f.xx.xn+35

2.3 Service Procedures

2.3.1 Hot-Swapping the Netra CP3250 Blade Server

You can remove the Sun Netra CP3250 blade server without powering off the entire chassis by performing these steps.

1. Power off the blade server.

See [Section 2.3.2, “Powering Off the Netra CP3250 Blade Server”](#) on page 2-17.

2. Remove the blade server.

See [Section 2.3.3, “Removing the Netra CP3250 Blade Server”](#) on page 2-18.

2.3.2 Powering Off the Netra CP3250 Blade Server

1. Shut down the operating system.

Log in and shut down any OS operating on the blade server or its companion ARTM.

2. Deactivate the blade server.

Log in to the shelf manager and deactivate the blade server in the target slot.

For example, to shut down the blade server in slot 3, log in to the shelf manager and type:

```
# clia deactivate board 3
```

Wait for the blue Hot-Swap LED to light steadily before removing the blade server.

2.3.3 Removing the Netra CP3250 Blade Server

1. **Power off the Sun Netra CP3250 blade server.**

Use the instructions in [Section 2.3.2, “Powering Off the Netra CP3250 Blade Server”](#) on page 2-17.

2. **If installed, remove all cables from the front of the Sun Netra CP3250 blade server.**

3. **Loosen the locking screws to release the blade server from the ATCA shelf.**

4. **When the blue Hot-Swap LED lights steadily, release the upper latch and the lower latch at the same time to unseat the blade server from the connectors.**

5. **Remove the blade server from the ATCA shelf and place the blade server on an antistatic mat.**

2.3.4 Powering On the System

Sun Netra CP3250 blade servers are powered on automatically via the H8 BMC when you install the blade server into a slot in the ATCA shelf. Once installed, the blade server sequences through power-on states until it is fully powered on.

2.3.5 Automatic Power-Off Events

A power-off sequence is initiated either by a request from the shelf manager or a fault condition. The Sun Netra CP3250 blade server shuts down to standby power mode when the following upper critical threshold conditions are met:

- Detection of DC input (both -48V A and -48V B) drop for more than 5ms
- Processor thermal trip drops to standby mode

Thermal trip of DC brick turns off all local power (standby included)

2.3.6 Servicing DIMMs

2.3.6.1 DIMM Requirements

The Sun Netra CP3250 blade server supports a total of six DIMMs and the maximum memory capacity of 24 GB (using four 4 GB DIMMs). The Sun Netra CP3250 blade server accommodates the following DIMMs and configurations:

- Up to six standard DDR2 SDRAM registered/ECC DIMMs
- DIMMs must be installed in matching pairs
- 2 GB and 4 GB DDR2 modules are supported
- Maximum of 24 GB in six slots

The Sun Netra CP3250 blade server supports DIMMs that have the following characteristics:

- A 144-bit wide data bus DDR2 interface (2x64-bit data + 2x8-bit ECC)
- DDR2 DIMM: 4.4 - 7.0 watts (1.8 V)
- Very low profile (VLP) with a maximum height of 0.72 inch (18.3 mm)

FIGURE 2-5 Locating DIMM Slots

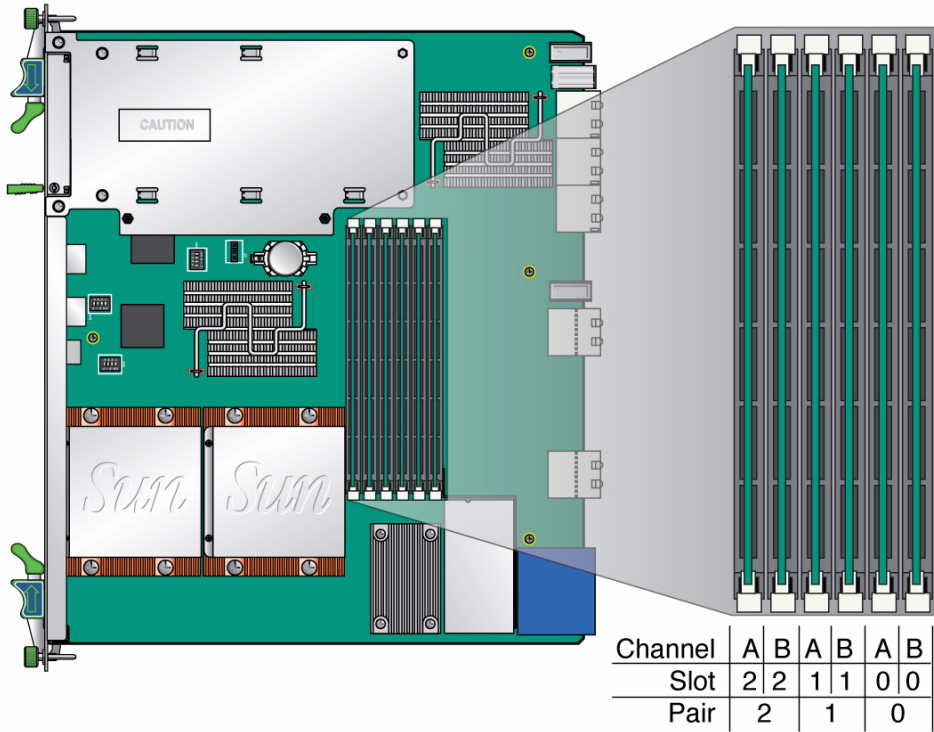

Populate DIMMs in matching pairs, starting with Pair 0, then adding Pair 1, then Pair 2.

There are two channels, Channel A and Channel B. DIMMs are identified as A0, B0, A1, B1, A2, and B2. Where Pair 0 would be A0 and B0, and so on.

2.3.6.2 Installing a DDR2 DIMM

The following procedure provides a general guide for installing additional memory. However, for specific directions on installing DIMMs on the Sun Netra CP3250 blade server, refer to the documentation that shipped with the DIMMs.

1. Access the blade server by performing one of the following procedures:

- If the Sun Netra CP3250 blade server is installed in an ATCA shelf, remove the blade server from the shelf as explained in [Section 2.3.3, “Removing the Netra CP3250 Blade Server”](#) on page 2-18.
- Remove the Sun Netra CP3250 blade server from its antistatic envelope and place it on an ESD mat near the ATCA shelf.

2. Take antistatic precautions: Attach and electrically ground the wrist strap.



Caution – Always wear a grounded antistatic wrist strap when handling DIMMs.

3. Locate the DIMM connectors on the Sun Netra CP3250 blade server.

Select the connectors where you will install the DIMM. See [FIGURE 2-5](#) for DIMM slot locations.



Caution – Do not remove the DIMM from its antistatic container until you are ready to install the DIMM on the Sun Netra CP3250 blade server. Handle the DIMM only by its edges. Do not touch DIMM components or metal parts. Always wear a grounded antistatic wrist strap when handling DIMM.

4. Remove the DIMM from its protective packaging, holding the module only by the edges.

Note – Before installing a replacement DIMM, verify that the new DIMM is the same size as its paired DIMM.

5. Holding the DIMM upright to the blade server, insert the bottom edge of the DIMM into the bottom of the slot’s hinge-style connector ([FIGURE 2-6](#)).



Caution – Evenly engage the DIMM in its hinge-style slot; uneven contact can cause shorts that will damage the Sun Netra CP3250 blade server. Do not rock the DIMM into place. Ensure that all contacts engage at the same time. You will feel or hear a click when the DIMM properly seats in the connector.

The socket and module are both keyed, which means that the DIMM can be installed only one way. With even pressure, push simultaneously on both upper corners of the DIMM until its bottom edge (the edge with the gold fingers) is firmly seated in the connector.

FIGURE 2-6 Installing a DIMM

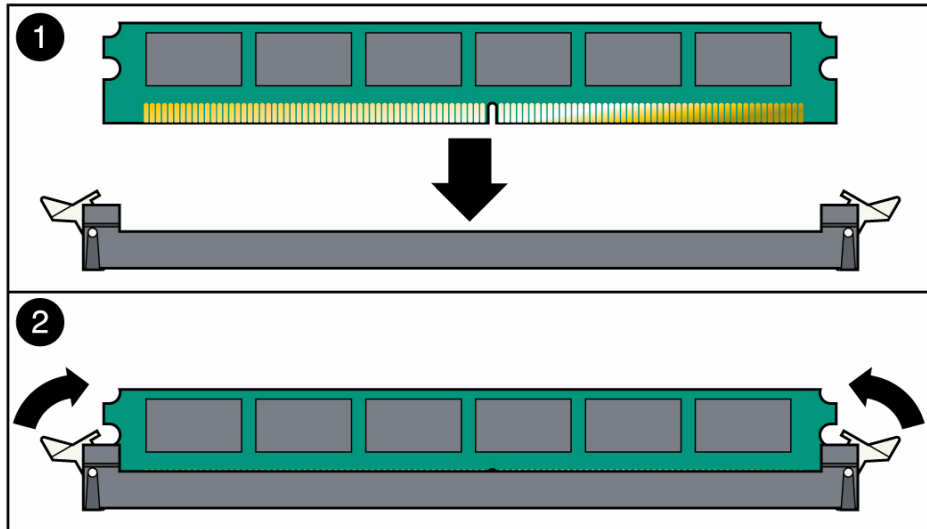

6. Press the top edge of the DIMM toward the blade server until the retainer clips click into place in the notches on the DIMM sides (FIGURE 2-6).

The small metal retainer clips on each side of the DIMM slot are spring-loaded, and they should click into place in the notches on the sides of the DIMM.

2.3.6.3 Removing a DDR2 DIMM

If you are returning the DIMM or the blade server for service, or if you are replacing a DIMM with another DIMM, remove the DIMM from the Sun Netra CP3250 blade server.

Note – Safely store the original factory-shipped DIMM and related DIMM packaging. Store any removed DIMM in the new DIMM packaging.

To remove a DIMM from the Sun Netra CP3250 blade server, perform the following steps:

1. Access the blade server by performing one of the following procedures:

- If the Sun Netra CP3250 blade server is installed in an ATCA shelf, remove the blade server from the shelf as explained in [Section 2.3.3, “Removing the Netra CP3250 Blade Server”](#) on page 2-18.
- Remove the Sun Netra CP3250 blade server from its antistatic envelope and place it on an ESD mat near the ATCA shelf.

If an ESD mat is not available, you can place the blade server on the antistatic envelope in which it was packaged.



Caution – Do not place blade servers on top of an antistatic bag unless the outside of the bag also has antistatic protective properties.

2. Take antistatic precautions: Attach and electrically ground the wrist strap.



Caution – Always wear a grounded antistatic wrist strap when handling DIMMs.

3. Simultaneously pull both spring retainer clips outward from the slot for the DIMM you want to remove.

4. Grasp the DIMM by the edges, and carefully pull it out of its connector.

Place it in an antistatic bag.

FIGURE 2-7 Removing a DIMM

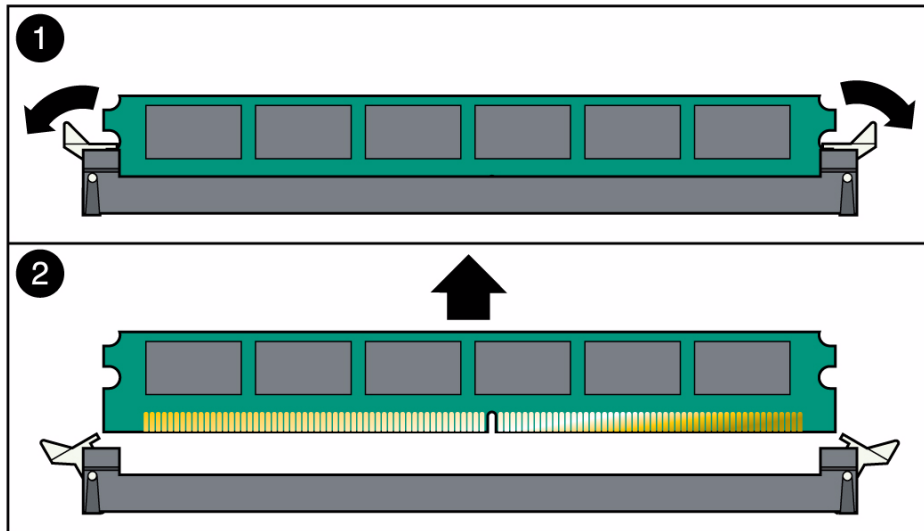

5. If you are replacing the DIMM you removed with a new DIMM, install it as described in [Section 2.3.6.2, “Installing a DDR2 DIMM”](#) on page 2-21.

2.3.7 Installing the Optional Compact Flash Card

An IDE Compact Flash card can be installed on the Sun Netra CP3250 blade server. The Compact Flash card is not hot-swappable, and there is no access to the Compact Flash card once the Sun Netra CP3250 blade server is installed in an ATCA shelf.

1. Access the blade server by performing one of the following procedures:

- If the Sun Netra CP3250 blade server is installed in an ATCA shelf, remove the blade server from the shelf as explained in [Section 2.3.3, “Removing the Netra CP3250 Blade Server”](#) on page 2-18.
- Remove the Sun Netra CP3250 blade server from its antistatic envelope and place it on an ESD mat near the ATCA shelf.

If an ESD mat is not available, you can place the blade server on the antistatic envelope in which it was packaged.



Caution – Do not place blade servers on top of an antistatic bag unless the outside of the bag also has antistatic protective properties.

2. Push where indicated on door that provides access to the Compact Flash, then open the door.

[FIGURE 2-8](#) shows the door.

FIGURE 2-8 Opening the Door to Access Compact Flash

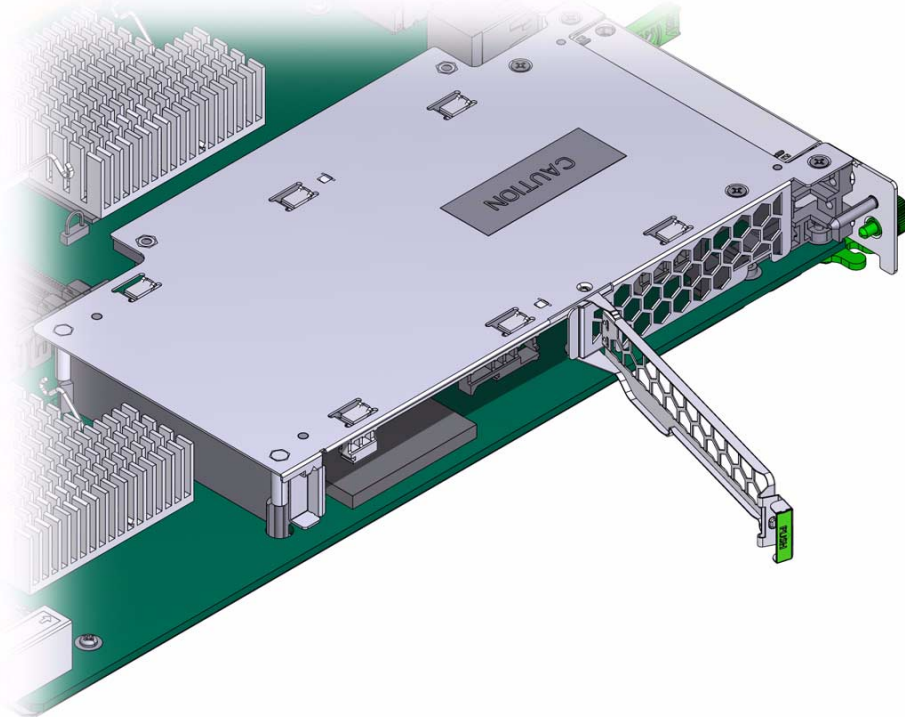

3. Locate the Compact Flash connector.

The connector is located on the blade server, behind the sheet metal door protecting the AMC slot B1 ([FIGURE 2-9](#)).

FIGURE 2-9 Compact Flash Location

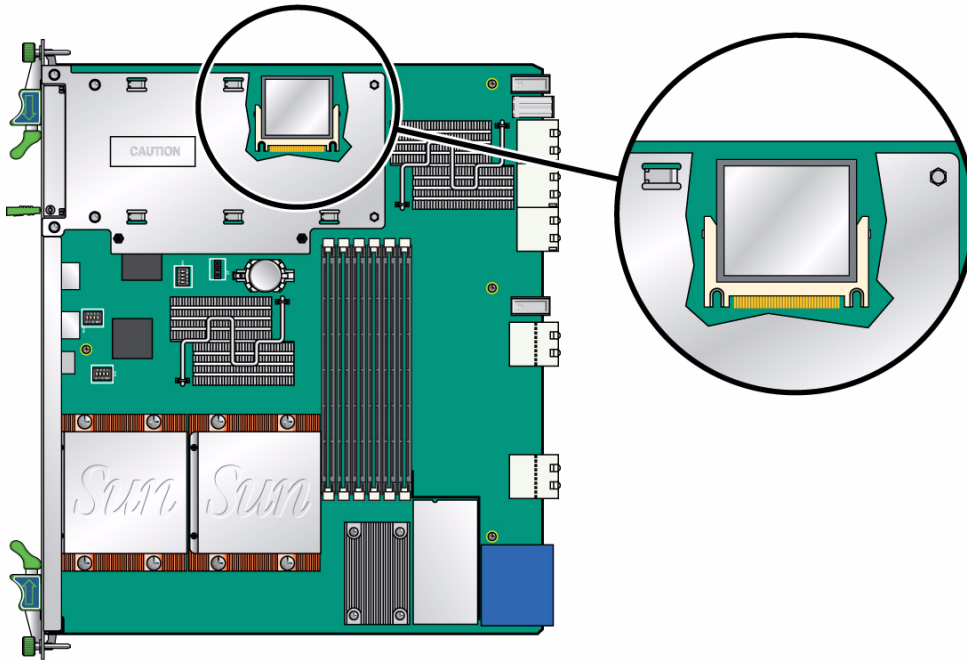

4. To install the Compact Flash card, use the arrow on the card as a guide to insert the card into the Compact Flash connector.

Note – Sun Compact Flash cards have a life time of 2,000,000 write/erase cycles. Users are responsible for ensuring that the operating system and applications do not exceed this limitation.

2.3.8 Installing Optional AMC

An Advanced Mezzanine card (AMC) is a card or module that provides additional functionality to the Sun Netra CP3250 blade server. The blade server contains one AMC slot in which you can install an optional AMC device. An AMC device can be installed and removed via a cutout in the front panel while the Sun Netra CP3250 blade server is installed in the chassis.

Note – The following procedure provides a general set of instructions for installing an AMC on the Sun Netra CP3250 blade server. Refer to the AMC manufacturer’s documentation for specific instructions on installing these devices.

1. Retrieve the wrist strap from the shipping kit.

2. Attach the adhesive copper strip of the antistatic wrist strap to the metal chassis.

Wrap the other end twice around your wrist, with the adhesive side against your skin.

3. Remove the AMC slot filler panel from the blade server’s front panel (FIGURE 2-10).

FIGURE 2-10 Removing an AMC Filler Panel

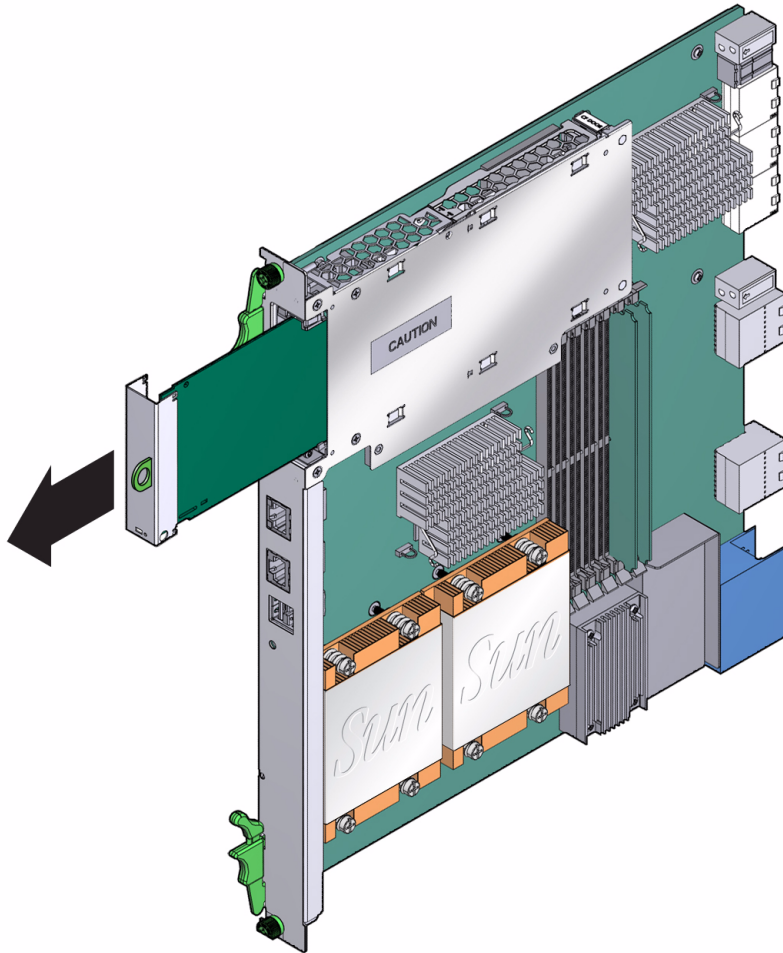

4. Retrieve the AMC from its shipping kit and place it on an antistatic surface.
5. Insert the AMC through the cutout and into the AMC slot ([FIGURE 2-11](#)).

FIGURE 2-11 Installing an AMC

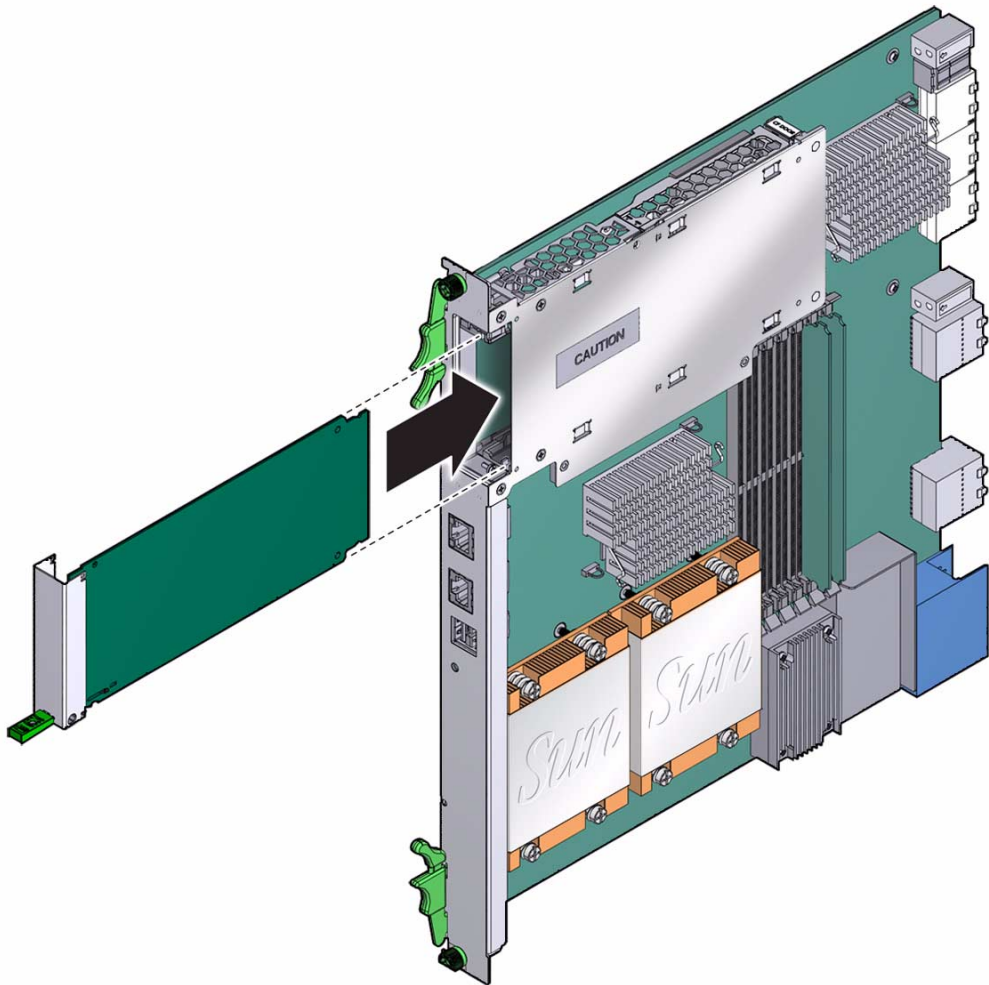

Caution – Do not use excessive force when installing the AMC into the slot. You might damage the AMC connector on the Sun Netra CP3250 blade server, causing permanent damage to the AMC or the blade server. If the AMC does not seat properly when you apply even pressure, remove the AMC and carefully reinstall it.

6. Carefully push the AMC into the AMC connector.
7. Refer to the AMC documentation for software and cabling installation instructions.

2.3.9 Adding or Replacing the Battery

The Sun Netra CP3250 blade server does not ship with the battery. If you want CMOS settings to be preserved in the event of power loss, obtain and install the battery.

The battery must be type CR1632, with a minimum of 4ma abnormal charging current rating (for example; a Renata CR1632).



Caution – Risk of explosion if the battery is replaced by an incorrect type. Dispose of used batteries properly in accordance with manufacturer’s instructions and local regulations.

To install the battery:

1. Remove the old battery, if necessary.
2. Slide the new battery into the holder with the side labeled “+” facing up.

2.3.10 Changing Jumper Settings

Jumpers and their switches are located near the heatsink on the blade server.

2.3.10.1 Clearing the CMOS Setting Using Jumper 2

Reset jumper 2 to clear the CMOS settings, which restores the default BIOS settings.

Jumper 2 is shown in [FIGURE 2-12](#). The jumper housing should be stored in the P2/P3 position, which is the run position.

FIGURE 2-12 Jumper 2 in the Default Run Position

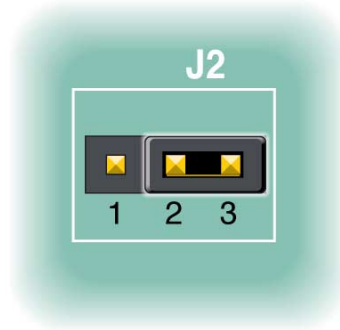

[TABLE 2-4](#) provides information on the pin functions on jumper 2.

TABLE 2-4 Pin Functions on Jumper 2

Pin Number	Purpose
Pin 1	Battery Feed
Pin 2	VCC_RTC (destination for battery power)
Pin 3	BATT_CLR (resistor to GND, used to drain capacitive charge and clear the CMOS memory)

To reset the jumper and return the CMOS settings to the default settings, perform the following steps:

1. **Remove the jumper housing from the run position (P2/32) and move it to the reset position (P1/P2).**
2. **Wait at least one second for the CMOS settings to reset and then move the jumper housing back to the run position (FIGURE 2-12).**
3. **Reinstall the blade server.**

Use the procedure in [Section 2.2.3.2, "Installing the Blade Server Into the Shelf"](#) on page 2-11.

Note – The blade server will operate normally only when the jumper housing is in the run position.

2.3.10.2 Changing the OOS LED Color Using Jumper 13

The color of the Out-of-service (OOS) LED can be set to red or amber by moving jumper 13 to the appropriate position. Amber is the default color for the OOS LED.

To change the Jumper 13 position to display a red OOS LED:

1. **Remove the jumper housing from the default (amber) position (P2/P3) and move it to the red position (P1/P2).**
2. **Reinstall the blade server.**

Use the procedure in [Section 2.2.3.2, "Installing the Blade Server Into the Shelf"](#) on page 2-11.

2.3.11 Checking DIP Switch Settings

DIP switch settings are set by default at the factory. The following settings are required for normal operation of the blade server.

FIGURE 2-13 SW1 Default DIP Switch Settings

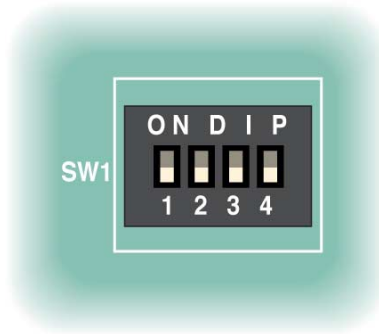

FIGURE 2-14 SW4 Default DIP Switch Settings

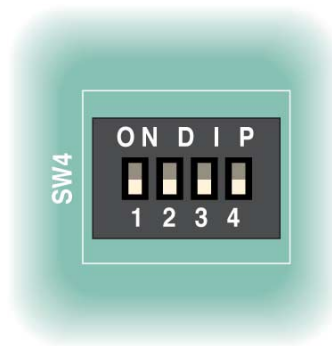
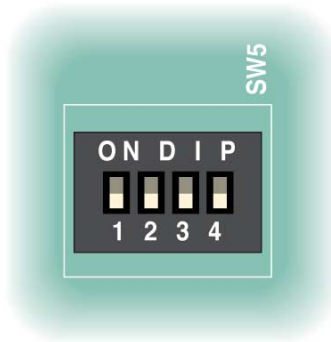

FIGURE 2-15 SW5 Default DIP Switch Settings



2.3.12 Resetting the Netra CP3250 Blade Server



Caution – Do not operate the ATCA shelf without all fans, component heatsinks, air baffles, and covers installed. Severe damage to components can occur if the ATCA shelf is operated without adequate cooling mechanisms.

1. Use a spudger tool or other stylus to press and release the recessed Reset button on the front of the Sun Netra CP3250 blade server ([FIGURE 2-16](#)).
2. Confirm the progress of the reset by monitoring the BIOS POST messages.

FIGURE 2-16 Netra CP3250 Blade Server Front Panel

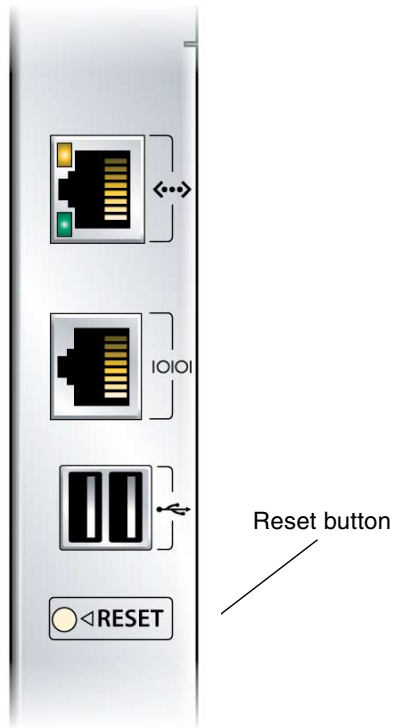

Hardware Architecture

This chapter describes the hardware components and architecture of the Sun Netra CP3250 blade server.

This chapter contains the following sections:

- Section 3.1, “Block Diagram” on page 3-2
- Section 3.2, “Intel Processors” on page 3-3
- Section 3.3, “Intel San Clemente MCH” on page 3-3
- Section 3.4, “Memory” on page 3-4
- Section 3.5, “Networking and I/O” on page 3-5
- Section 3.6, “I/O Components” on page 3-8

3.1 Block Diagram

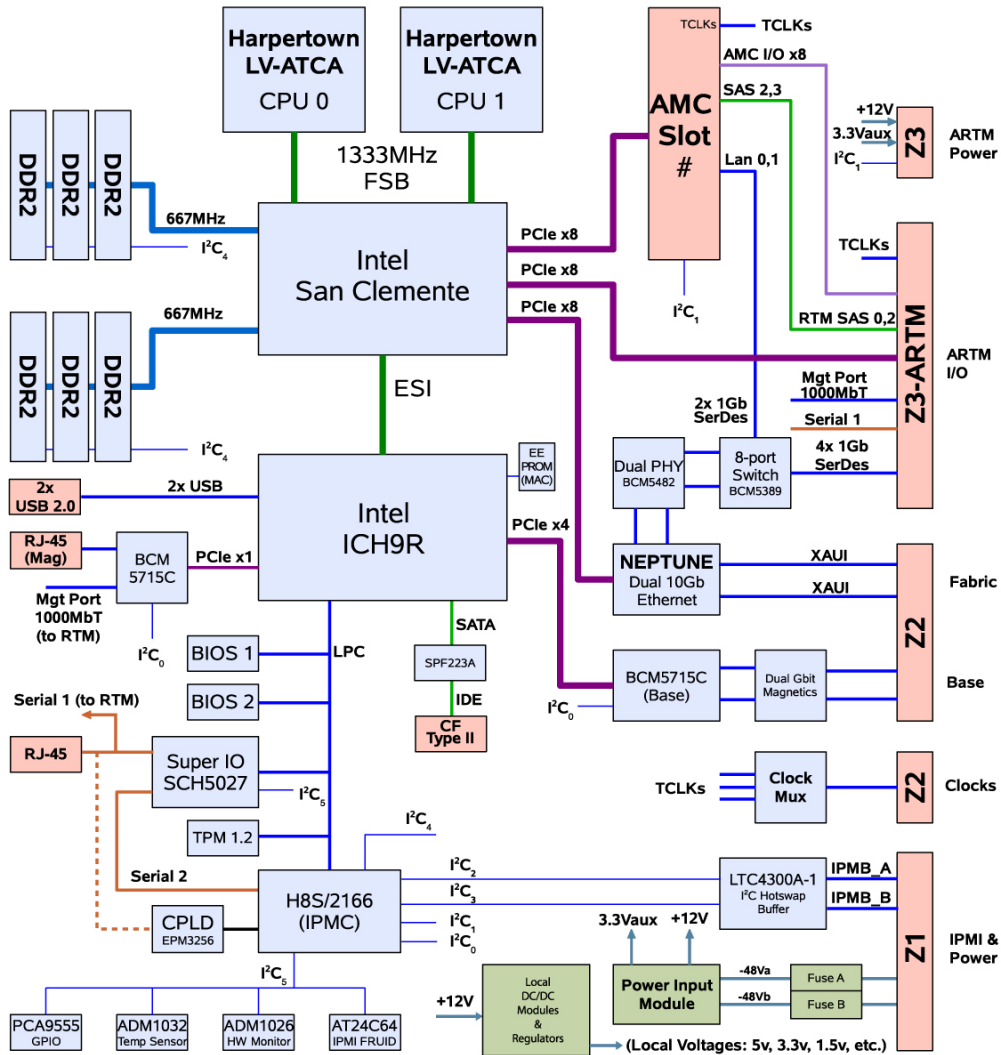

3.2 Intel Processors

The Sun Netra CP3250 blade server supports dual 64-bit low voltage Intel Xeon (Harpertown) processors at 2.13 GHz with 12 MB of L2 cache and a 1066 MHz system bus. This processor is designed for high-performance, low-power communication, storage, and embedded applications. It is built on Intel's new 65nm topology. The following are the key features of the Harpertown processor:

- Quad-Core processor optimized for high performance, low-power communication, storage, and embedded applications.
- Four complete execution cores in a single processor
- Dual processor support (eight high-performance cores per Sun Netra CP3250 blade server)
- FSB Parity Protection providing key reliability and data integrity features
- Intel Smart Cache Technology
- Enhanced 36-bit memory addressing
- FSB address, data, and response parity protection
- Enhanced Intel Speedstep Technology
- Intel Advanced Thermal Manager
- Streaming SIMD Extensions 3 (SSE3) Support
- Embedded life cycle support

3.3 Intel San Clemente MCH

The architecture of the Intel E7520 Memory Controller Hub (MCH) provides the performance and feature set required for performance servers, with configuration options that facilitate optimization of the platform for workloads characteristic of communication, presentation, storage, performance computation, or database applications. To accomplish this, the MCH has numerous Reliability, Availability, Serviceability, Usability and Manageability (RASUM) features on multiple interfaces. The following list provides key features on the MCH:

- Supports two processors on dual independent point-to-point system buses operating at 266MHz (1066MTS) or 333MHz (1333MTS)
- Six PCI Express x4 ports. Each of these ports can be configured as x4, x8, or x16 ports interfaces

- Enterprise South Bridge Interface (ESI) to ICH9 device
- Maximum memory bandwidth using DDR2-667 is 10.6GB per slot for two DDR2 channels

3.4 Memory

The Sun Netra CP3250 blade server supports 4-Gbyte registered DDR2-667 memory, for up to 24 Gbytes memory total. When four DIMM slots or less are populated, the DIMM clock rate will be set to the max clock rate of up to 333 Mhz. When six DIMMs slots are populated, the DIMM clock rate will be set to a max clock rate of up to 267 Mhz.

For optimal performance, memory DIMMs must be installed in like pairs. The controller supports 1 bit per byte ECC and supports DDR2 667 registered DRR SDRAM modules. For more information on supported DIMM configurations, see [Section 2.3.6.1, “DIMM Requirements” on page 2-19](#).

Additional features of the Sun Netra CP3250 blade server’s memory architecture include:

- Very low profile (0.72 inch) DIMM support
- Memory bandwidth up to 5.3 Gbyte/sec
- DDR2 power requirements 4.4W to 7.0W (1.8V)

Although single channel operation is defined by the Intel Memory Controller and will function, this configuration will not be qualified, tested, or supported on the Sun Netra CP3250 blade server.

The supported configuration is dual channel, which follows the DIMM loading order: Pair 0 (first) -> Pair 1 (second) -> Pair 2 (third).

DIMMs must be loaded by pairs in the order indicated. Install DIMMs in pairs of like memory types.

3.5 Networking and I/O

Networking and I/O are provided by the following chips and interconnects:

- ICH9 I/O controller hub
- PCI Express Bus
- LPC bus interface
- Redundant BIOS
- Trusted Platform Module
- Broadcom 5715C Gbit Ethernet chip
- Sun 10 GbE Multithreaded Networking Technology Dual 10-Gbit + Dual 1-Gbit Ethernet chip

3.5.1 ICH9 I/O Controller Hub

The ICH9 I/O provides legacy function support similar to that of previous ICH-family devices, but with extensions in Serial-ATA technology and 64-bit/66 MHz PCI-X support. The ICH9 I/O also includes integrated USB 2.0 and USB 1.0 support, an LPC interface, a system management interface, a power management interface, PECE interface, integrated Gigabit Ethernet controllers (not used on Sun Netra CP3250 blade server), and an integrated DMA controller.

3.5.2 PCI Express Bus

PCI Express 1.0 (PCIe) is a high-speed, point-to-point dual simplex chip interconnect. It is the latest extension of the PCI bus. PCIe operates at 2.5 GHz and supports lane widths of x1, x2, x4, x8, x16, and x32. Additional features include:

- Serial point-to-point interconnect between two devices
- Each lane supports two differential signal pairs, one pair for each data direction
- 2.5-Gbyte/sec transfer rate
- Scalable performance based on the number of lanes implemented per interconnect

3.5.3 LPC Bus Interface

The LPC bus is a multiplexed (command, address, and data) serialized 4-bit bus with optional side band signals. It replaces the ISA/X-bus and reduces pin count (approximately 40) over the ISA/X-bus.

LPC is designed to reduce the cost of traditional X-bus devices and meet the data transfer rate of X-bus, exceeding those data rates where appropriated. It performs the same cycle types as the X-bus: Memory, I/O, DMA and Bus Master. And, it increases the memory space from 16 Mbytes on the X-bus to 4 GB to allow BIOS sizes much greater than 1 Mbyte and other memory devices outside of the traditional 16 MByte range.

The LPC is software transparent and does not require special drivers or configuration for its interface. The motherboard BIOS configures all devices at boot up. It has the ability to support a variable number of wait states, to have I/O and memory cycles retried in SMM handler and to support wake-up and other power state transitions. The design meets LPC 1.0 design guidelines.

The LPC bus provides system connectivity to the following devices:

- Redundant BIOS
- TPM
- IPMC
- RS-232 Serial Ports

3.5.4 Redundant BIOS

The Sun Netra CP3250 blade server provides redundant 1-Mbyte BIOS chips that support redundant BIOS images for increased reliability.

The redundant Flash PROMs and SRAM devices are used by the BIOS. Each PROM is an 8 MB flash device. The primary flash device (FWH0) contains the primary BIOS image, factory default settings, and user configured settings. The primary BIOS chip is automatically selected for update during a firmware upgrade.

The secondary flash device (FWH1) contains a backup copy, normally of the last known good BIOS image, factory default settings, and last good user-configured settings. The secondary BIOS chip retains the original BIOS image, and can be used through manual configuration if the primary BIOS is corrupt.

In the event of a checksum or other failure during boot of the primary BIOS image, the H8 switches the system over to the secondary device to allow system boot recovery.

3.5.5 Trusted Platform Module (TPM)

The Sun Netra CP3250 blade server provides a Trusted Platform Module (TPM) chip, which enables various security features, including hardware and software authentication. This chip is reserved for future use on the Sun Netra CP3250 blade server.

3.5.6 IPMC

The H8S/2166 IPMC provides the IPM controller function on the Sun Netra CP3250 blade server. The IPMC provides PICMG 3.0 board management functionality, and interfaces to the payload through a serial interface.

The IPMC provides the following:

- Dual buffered IPMB interfaces to connect to IPMB-0
- Hot-swap latch input and LED control
- Payload power control
- Payload base and fabric interface e-keying control
- Payload power and temperature monitoring

3.5.7 RS-232 Serial Ports

A Serial port is available on the front panel using an RJ-45 connector. This same port is also wired through the Zone 3 connectors to provide a copy of this port on the ARTM. This connector shares the SuperIO chip Port A with the H8-IPMI controller, to allow console messages to be directed to the H8 when the external ports are not in use. The blade server detects a valid RS232 connection to either the front or rear port and will automatically disconnect the SuperIO port from the H8 and connect to the external ports.

Note – The front and rear ports cannot be used at the same time because they share the same wires.

3.5.8 Broadcom 5715C Gigabit Ethernet

The Broadcom 5715C Gigabit Ethernet chip used on the Sun Netra CP3250 blade server provides two 10/100/1000 MBASE-T interfaces to the Zone 2 connectors. It incorporates the media access control (MAC) and physical (PHY) layer functions for the two LANs used as the ATCA base fabric.

3.5.9 Sun Dual 10-Gbit Ethernet/Quad 1-Gbit RGMII Network Interface Chip

The Sun Netra CP3250 blade server is equipped with one Sun Dual 10-Gbit Ethernet/Quad 1-Gbit RGMII Network Interface chip (Sun 10 GbE Multithreaded Networking Technology) that is specifically designed to support multicore and multithreaded processor with minimum CPU load while maximizing network I/O throughput.

Sun 10 GbE Multithreaded Networking Technology provides two 10-Gbit XAUI Ethernet connections to the ATCA backplane extended fabric, where four lanes are driven at 3.125 Gbyte/sec (if the ATCA switch supports 10-Gbit Ethernet) or a single lane at 1.25 Gbyte/sec if the switch is a 1-Gbit Ethernet device.

Sun 10 GbE Multithreaded Networking Technology also provides two 1-Gb RGMII Ethernet connections to the Broadcom BCM5482H chip, which converts to SERDES and routes the SERDES signals through an 8 port switch and providing two 1 Gb LANS to Zone 3-RTM and to each AMC slot.

3.6 I/O Components

3.6.1 AMC Slot

The Sun Netra CP3250 blade server contains one AMC slot, which is available from the front panel. The slot is a single-width, mid-height slot. If needed, AMC I/O connectivity can be accessed from the front panel (depending on the AMC installed) and through the optional advanced rear transition module.

The Sun Netra CP3250 blade server conforms to the *PICMG Advanced Mezzanine Card AMC.0 specification R1.0 ECR_002 D0.9, June 29, 2006*, and supports AMC.1 Type 8S2E2 cards, as defined by the same specification.

3.6.2 EIDE/ATA for Compact Flash

An EIDE/ATA-133 bus is derived from a SATA port on the ICH9 IO Hub via an SPF223A SATA to IDE converter.

The Sun Netra CP3250 blade server contains one on-board 50-pin Type II Compact Flash connector for use with a Compact Flash Card. The connector is located so that access to the Compact Flash card is provided only when the card is removed from the ATCA chassis.

3.6.3 SAS/SATA

The Sun Netra CP3250 blade server supports AMC drives (SAS or SATA), that contain their own PCIe based controller chip connecting to the system via the PCIe Bus. The Sun Netra CP3250 blade server supports an AMC that contains drives using Port 2 or 3 SAS connections only when the Netra CP32x0 ARTM-HD is present. The SATA lines from the ICH9 chip are not connected.

If present, the Netra CP32x0 ARTM-HD drives the AMC Port-2 signals. This support speeds up to 3 Gb/sec.

There is no support for drives mounted directly to the blade server, and the Sun Netra CP3250 blade server itself does not contain any native support for SAS or SATA drives.

Software Configuration

This chapter contains the following sections:

- Section 4.1, “Operating Systems” on page 4-2
- Section 4.2, “Software Updates” on page 4-2
- Section 4.3, “SunVTS Software” on page 4-3
- Section 4.4, “Configuring Sun Netra CP3250 blade server For 1 GbE or 10 GbE Switches” on page 4-4

4.1 Operating Systems

The Sun Netra CP3250 blade server has been tested for compatibility with the following operating systems:

- Solaris™ 10 (05/08) Operating System (Solaris OS)
- WindRiver Linux 3.1
- RedHat Linux 5.2
- Windows 2003

Refer to the *Netra CP3250 Blade Server Product Notes* (820-5194) for information on Solaris OS and patches.

For information on versions of the Solaris OS, including installation, see the appropriate Solaris Documentation Collection at the Sun Documentation web site at:

<http://docs.sun.com>

For information on the WindRiver Linux, RedHat Linux, and Windows operating systems, see the documentation that came with the operating system.

4.2 Software Updates

Software updates and support information for the Sun Netra CP3250 blade server, ARTMs, and the Netra CT 900 system can be found at the Sun Download Center:

<http://www.sun.com/download>

See the *Netra CP3250 Blade Server Product Notes* (820-5194) for information.

For information on your specific configuration, contact your local Sun Services representative.

<http://www.sun.com/service/contacting/solution.html>

4.3 SunVTS Software

Note – The Sun Validation Test Suite (SunVTS software) runs on the Solaris OS only. There are similar test suites available for the Linux operating systems.

The SunVTS software is a comprehensive software suite that tests and validates the Sun Netra CP3250 blade server by verifying the configuration and function of most hardware controllers and devices on the blade server.

SunVTS software is used to validate a system during development, production, inspection, troubleshooting, periodic maintenance, and system or subsystem stressing. SunVTS software can be tailored to run on various types of machines, ranging from desktops to servers with modifiable test instances and processor affinity features.

You can perform high-level system testing by using the appropriate version of SunVTS software. For detailed information on SunVTS software support and downloads, refer to the following web site:

<http://www.sun.com/oem/products/vts/>

You will be prompted for your Sun Online Account name and password.

Ensure that the SunVTS software version is compatible with the Solaris OS being used. VTS 7.x is bundled with Solaris 10 OS (5/08) and newer.

You can find information about the SunVTS software version installed on your system by using the following command:

```
# pkginfo -l SUNWvts
```

To obtain SunVTS documentation, contact your local Customer Service representative, field applications engineer, or system support engineer.

Note – For security reasons, only a superuser is permitted to run SunVTS software. Installation and starting instructions are included with the software when it is downloaded.

4.4 Configuring Sun Netra CP3250 blade server For 1 GbE or 10 GbE Switches

The extended fabric on the Sun Netra CP3250 blade server is capable of operating at either 1 Gbps or 10 Gbps. The Sun Netra CP3250 blade server can be used in the Netra CT 900 server with either the Netra CP3240 10-GbE switch or the Netra CP3140 1-GbE switch. Therefore it is important that the driver configuration file be modified accordingly.

If you are using the Solaris OS, the network interface driver configuration file, `nxge.conf`, for the extended fabric ports of the Sun 10 GbE ASIC might need to be modified to employ the proper switch and ARTM configurations. The `nxge.conf` file is located in the `/platform/i86pc/kernel/drv` directory. The following examples show the proper entries for each switch configuration.

Example 1: When extended fabric ports are connected to Netra CP3240 switches in Slot 7 and Slot 8, the `nxge.conf` file should have the following entries:

```
name = "pciex108e,abcd" parent = "/pci@0,0/pci8086,65f8@4" unit-address = "0" phy-type = "xgsd";
name = "pciex108e,abcd" parent = "/pci@0,0/pci8086,65f8@4" unit-address = "0,1" phy-type =
"xgsd";
```

Example 2: When extended fabric ports are connected to Netra CP3140 switches in Slot 7 and Slot 8, the `nxge.conf` file should have the following entries:

```
name = "pciex108e,abcd" parent = "/pci@0,0/pci8086,65f8@4" unit-address = "0" phy-type = "gsd";
name = "pciex108e,abcd" parent = "/pci@0,0/pci8086,65f8@4" unit-address = "0,1" phy-type = "gsd";
```

If you are using another OS, refer to the documentation that came with your OS.

Configuring and Using BIOS Firmware

This chapter describes how to use the BIOS (Basic Input Output System) to configure the blade server.

This chapter contains the following procedures and information:

- [Section 5.1, “About BIOS Settings” on page 5-2](#)
- [Section 5.2, “Changing the Configuration of a BIOS Menu Item” on page 5-3](#)
- [Section 5.3, “Setting the Boot Device Using BIOS Setup Screens” on page 5-4](#)
- [Section 5.4, “Setting Supervisor and User Passwords” on page 5-5](#)
- [Section 5.5, “Resetting the System Time and System Date” on page 5-6](#)
- [Section 5.6, “Updating the BIOS” on page 5-6](#)
- [Section 5.7, “Secondary BIOS Image” on page 5-7](#)
- [Section 5.8, “Perform a Live Firmware Upgrade” on page 5-8](#)
- [Section 5.9, “Power-On Self-Test” on page 5-8](#)
- [Section 5.10, “Changing POST Options” on page 5-9](#)

5.1 About BIOS Settings

This section describes how to view and modify the BIOS settings.

The BIOS has a Setup utility stored in the BIOS flash memory. The Setup utility reports system information and can be used to configure the BIOS settings. The configured data is provided with context-sensitive help and is stored in the system's battery-backed CMOS RAM. If the configuration stored in the CMOS RAM is invalid, the *BIOS settings will default to the original state specified at the factory.*

5.1.1 Navigating BIOS Screens

The BIOS Setup utility contains menu screens; see [Appendix A](#) for illustrations of the screens.

Use the left and right arrow keys to move sequentially through the BIOS screens. Fields that can be reconfigured are displayed in color. All other fields are non-configurable. Use the up and down arrow keys to scroll through a screen's menu. Use the Tab key to move across columns.

5.1.2 BIOS Option ROMs

The Sun Netra CP3250 blade server has an option ROM for each of the following components:

- Broadcom BCM 5715C base interfaces
- Sun 10 GbE Multithreaded Networking Technology interfaces

Note – PXE boot from fabric interface (Sun 10GbE Multithreaded Networking Technology interfaces) is disabled by default. You must change the BIOS setting to boot from fabric interfaces.

5.1.3 Description of the BIOS Screens

TABLE 5-1 contains summary descriptions of the first-level BIOS Setup screens. For more information about the BIOS screens and screen illustrations, see [Appendix A](#).

TABLE 5-1 BIOS Setup Screens Summary

Screen	Description
Main	General system information.
Advanced	Configuration information for the CPUs, IDE, Super I/O, ACPI, Event Log, PCI Express, Smbios, MPS, Remote Access, and USB.
Boot	Configure the boot device priority (hard disk drives and the ATAPI DVD-ROM drive).
Security	Install or change the user and supervisor passwords.
Exit	Save or discard changes, or load optimal default BIOS settings.

5.2 Changing the Configuration of a BIOS Menu Item

You can change the BIOS configuration by using a terminal (or terminal emulator connected to a computer) through the serial console port on the front of the Sun Netra CP3250 blade server.

Note – Using the ANSI terminal emulation mode provides the best viewing of the BIOS screens.

- 1. To change the system's parameters, enter the BIOS Setup utility by pressing the F2 key while the system is performing the power-on self-test (POST).**

See [TABLE 5-1](#) for summary descriptions of the BIOS screens.

The first BIOS Setup menu screen is displayed.

- 2. Highlight the field to be modified using the arrow and Tab keys.**

- 3. Press Enter to select the field.**

A dialog box is displayed. The box displays the options that are available for the setup field that you have chosen.

- 4. Modify the setup field and close the screen.**

5. To modify other setup parameters, use the arrow and Tab keys to navigate to the appropriate screen and menu item; repeat [Step 2](#) through [Step 4](#).
6. Press and release the right arrow key until the Exit menu screen is displayed.
7. Follow the instructions on the Exit menu screen to save your changes and exit the Setup utility.

5.3 Setting the Boot Device Using BIOS Setup Screens

Before beginning this procedure, ensure that you have installed the serial cable as described in [Section 2.2.4](#), “[Connecting External I/O Cables](#)” on page 2-13.

Note – See [Section 5.1.3](#), “[Description of the BIOS Screens](#)” on page 5-3 for descriptions of the first-level BIOS menu screens. See [Appendix A](#) for illustrations of the BIOS screens.

1. **Use terminal emulation software to configure the serial COM1 settings.**
Use the ANSI terminal type setting.
2. **Set the serial communication settings to 9600 baud, 8 bit, 1 stop bit, no parity, and no handshake.**
3. **Reset the ATCA shelf.**
The BIOS starts running POST.
4. **Press the F2 key to interrupt the boot and access the BIOS Main menu.**
5. **Using the arrow keys, move across the top of the screen to the Boot menu and press the Enter key.**
The Boot Settings menu is displayed.
6. **Move down the list, select the Boot Device Priority option, and press Enter.**
The Boot Device Priority menu is displayed.
7. **Select the applicable device and priority.**
8. **Use the arrow keys to move to the Exit menu, and press Enter.**
The confirmation dialog box is displayed.

9. Press Enter to select Ok.

The BIOS boots the selected device. The operating system on the selected boot device loads.

10. Configure the operating system by providing a locale, system name, IP address, and other information.

Refer to the documentation for your operating system for information on configuring the operating system.

5.4 Setting Supervisor and User Passwords

You must set the Supervisor password before you can set the User password. The Supervisor password sets the desired access level for the User password.

1. To reset any BIOS passwords, clear the CMOS settings by resetting Jumper 2.

See [Section 2.3.10.1, “Clearing the CMOS Setting Using Jumper 2”](#) on page 2-31 for details.

2. Enter the BIOS Setup utility by pressing the F2 key on the keyboard while the system is performing the power-on self-test (POST).

3. Using the arrow keys, move across the top of the screen to the Security menu and press the Enter key.

The Security Settings Menu is displayed.

4. Move down the list, select the Change Supervisor Password or Change User Password option, and press Enter.

The Change Password menu is displayed.

5. Type a password, then press Enter.

6. Use the arrow keys to move to the Exit Menu.

7. Select OK to confirm the changes you made.

5.5 Resetting the System Time and System Date

1. Enter the BIOS Setup utility by pressing the F2 key while the system is performing the power-on self-test (POST).
2. Press and release the right arrow key until the Exit menu is selected. Press the Enter key.
3. Select the Load Optimal Defaults option and press the Enter key.
4. Use the arrow keys to return to the BIOS Main Menu.
5. Use the arrow keys to move down the main menu and reset the System Time and System Date fields.
6. Use the arrow keys to move to the Exit Menu.
7. Choose Save Changes and Exit.
8. Select OK to confirm the changes you made.

5.6 Updating the BIOS

When they are updated, BIOS images will be available as patches at the following web site:

<http://sunsolve.sun.com/>

Use the Solaris BIOS Update Utility or the Linux BIOS Update Utility to implement the updates. For more information, see the *Netra CT 900 Server Product Notes (819-1180)*.

5.7 Secondary BIOS Image

The Sun Netra CP3250 blade server provides dual 1-Mbyte BIOS chips that support redundant BIOS images for increased reliability. The default chip (page 0) acts as the primary BIOS chip and is automatically selected for update during a firmware upgrade. The secondary BIOS chip (page 1) retains the original BIOS image, and can be used through manual configuration in the unlikely case where the primary BIOS becomes corrupt.

If the primary BIOS becomes unbootable, use the secondary BIOS to manually boot the blade server:

1. **Log into the Shelf Manager.**
2. **To select the secondary BIOS image, type:**

```
# clia sendcmd 96 2e 81 00 00 2a 01
```

For example:

```
#clia sendcmd 96 2e 81 00 00 2a 01 <----- Setting the boot page to 1
Pigeon Point Shelf Manager Command Line Interpreter
Completion code: 0x0 (0) <----- successful completion code
Response data: 00 00 2A <----- no data returned
```

3. **To boot the blade server from the Shelf Manager, type:**

```
# clia activate board n
```

Note – Once the blade server is booted, reset the blade server to use the primary BIOS image (page 0).

5.8 Perform a Live Firmware Upgrade

To upgrade the BIOS firmware while retaining the current BIOS image, follow these steps:

1. **Switch the BIOS image from page 0 to page 1.**
See [Section 5.7, "Secondary BIOS Image" on page 5-7.](#)
2. **Use the Solaris BIOS Update Utility to upgrade the page 1 BIOS image.**
See [Section 5.6, "Updating the BIOS" on page 5-6.](#)
3. **Reboot the system into the updated page 1 BIOS.**
See [Section 2.3.12, "Resetting the Netra CP3250 Blade Server" on page 2-34.](#)

5.9 Power-On Self-Test

The system provides a rudimentary power-on self-test (POST) that runs each time the blade server boots to check the basic devices required for the system to operate.

The progress of the self-test is indicated by a series of POST codes. These codes appear at the bottom right corner of the system's VGA screen (once the self-test has progressed far enough to initialize the video monitor).

You can configure the level of POST testing and some POST display features through the BIOS menus. For more information, see [Section 5.10, "Changing POST Options" on page 5-9.](#)

5.10 Changing POST Options

These instructions are optional, but you can use them to change the operations that the server performs during POST testing.

1. **Initialize the BIOS Setup utility by pressing the F2 key while the system is performing the power-on self-test (POST).**

The BIOS Main Menu screen is displayed.

2. **From the BIOS Main Menu screen, select the Boot menu.**
3. **From the Boot Settings screen, select Boot Settings Configuration.**
4. **On the Boot Settings Configuration screen, you can enable or disable the options shown in [TABLE 5-2](#)**

TABLE 5-2 POST Options

Option	Description
Quick Boot	This option is disabled by default. If you enable Quick Boot, the BIOS skips certain tests while booting, such as the extensive memory test. This decreases the time it takes for the system to boot.
Quiet Boot	This option is disabled by default.

BIOS Screens

This appendix provides examples of the screens from the BIOS utility.

For information on how to access BIOS menus and configure settings, see [Chapter 5](#).

FIGURE A-1 BIOS Main Menu

```
Main      Advanced  Boot      Security  Exit
*****
* System Overview                               * Use [ENTER], [TAB] *
* AMBIOS                                         * or [SHIFT-TAB] to *
* Version   :1.01                               * select a Field.    *
* Build Date:08/29/08                           *                   *
*                                                  * Use [+] or [-] to  *
*                                                  * configure system time.*
* Product Name      : CP3250                    *                   *
* Board Serial Number : 0328MSL-082965000E      *                   *
* BMC Firmware Revision : 0.1.1                 *                   *
* CPLD Revision     : 07                        *                   *
* Processor                                                 *                   *
* Inte;(R) Xeon(R) CPU           L5408 @ 2.13GHz * *   Select Screen  *
* Speed       :2133MHz          * **  Select Item   *
* Count      :2                 * *-  Change Field  *
*                                                  * Tab  Select Field *
* System Memory * F1   General Help *
* Size         :24576MB        * F10  Save and Exit *
*                                                  * ESC  Exit         *
* System Time           [00:42:05] *                   *
*****
v02.61 (C)Copyright 1985-2006 American Megatrends, Inc.
```

FIGURE A-3 CPU Configuration Menu

SuperIO Chipset SCH5027

Advanced

Configure advanced CPU settings

Intel(R) Xeon(R) CPU 5138 @ 2.13GHz
Frequency : 2.13GHz
FSB Speed : 1066MHz
Cache L1 : 64 KB
Cache L2 : 4096 KB

Hardware Prefetcher [Enable]
Adjacent Cache Line Prefetch [Enable]
Core Multi-Processing [Enable]
Intel(R) SpeedStep(tm) Tech [Enable]

← → **Select Screen**
↑ ↓ **Select Item**
+ - **Change Option**
F1 **General Help**
F9 **Load Defaults**
F10 **Save and Exit**
ESC **Exit**

v02.61 ©Copyright 1985-2006, American Megatrends, Inc.

FIGURE A-4 IDE Configuration Menu

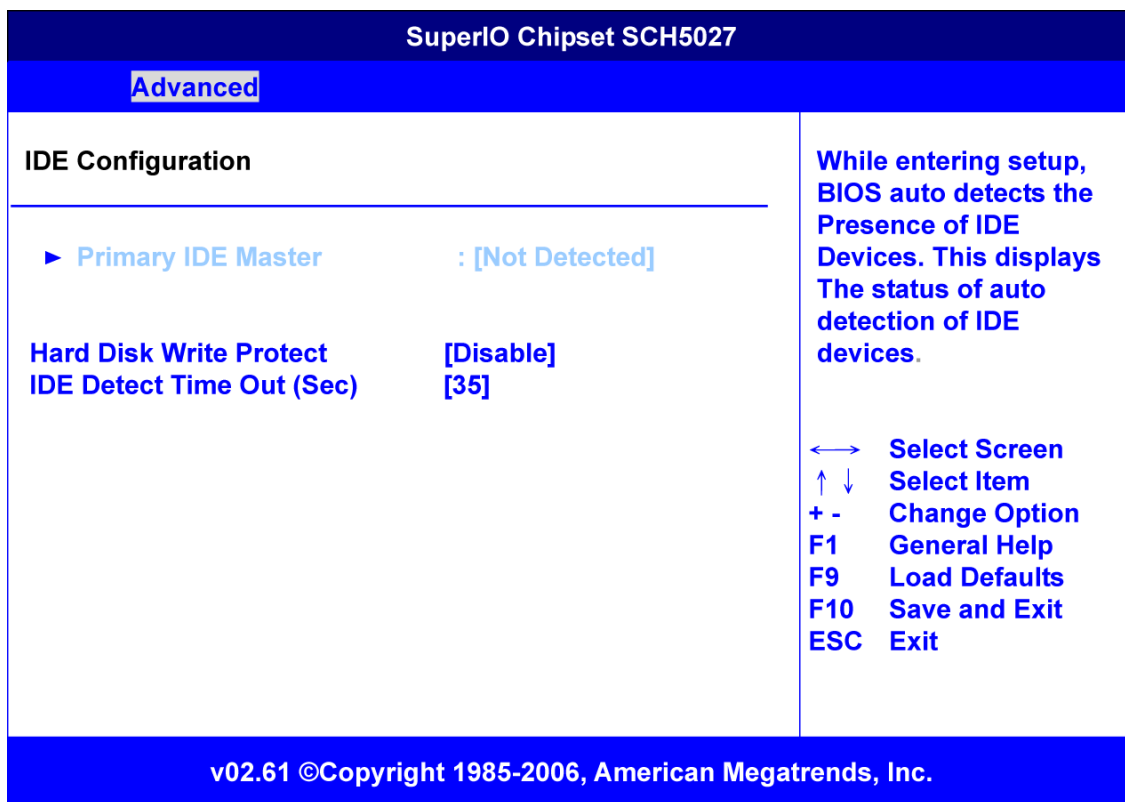

FIGURE A-5 USB Configuration Menu

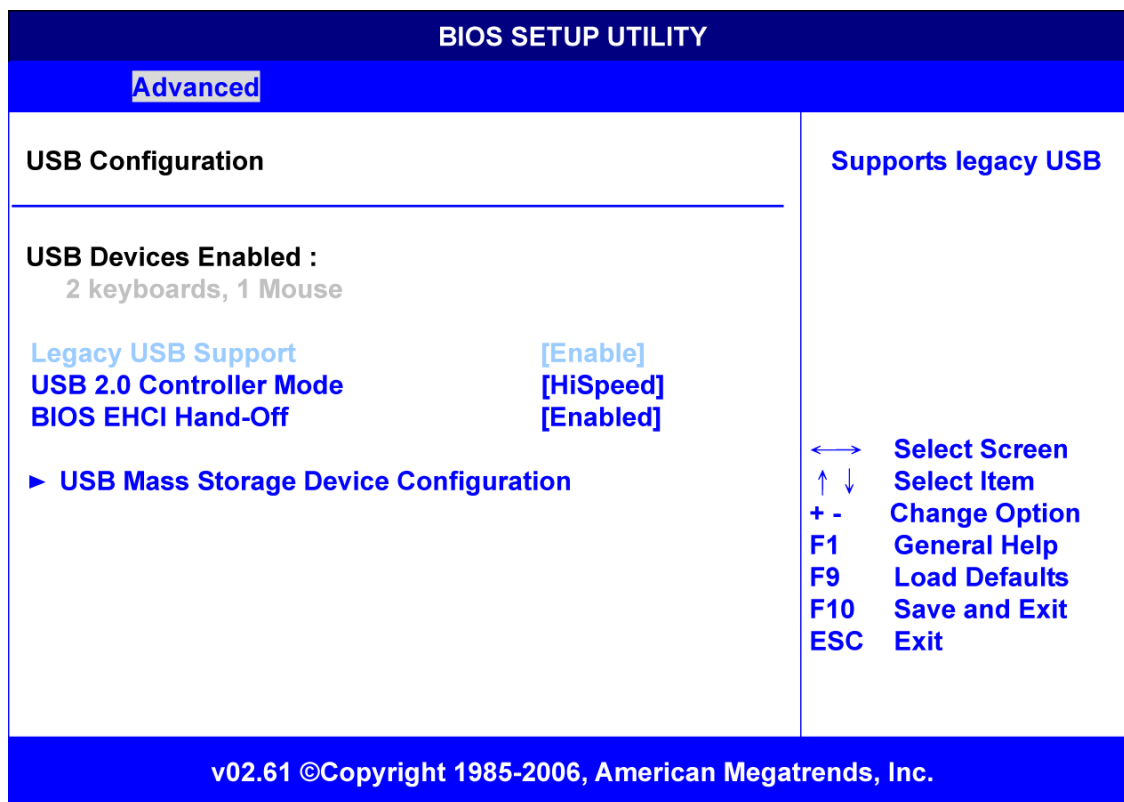

FIGURE A-6 Event Log Control Menu

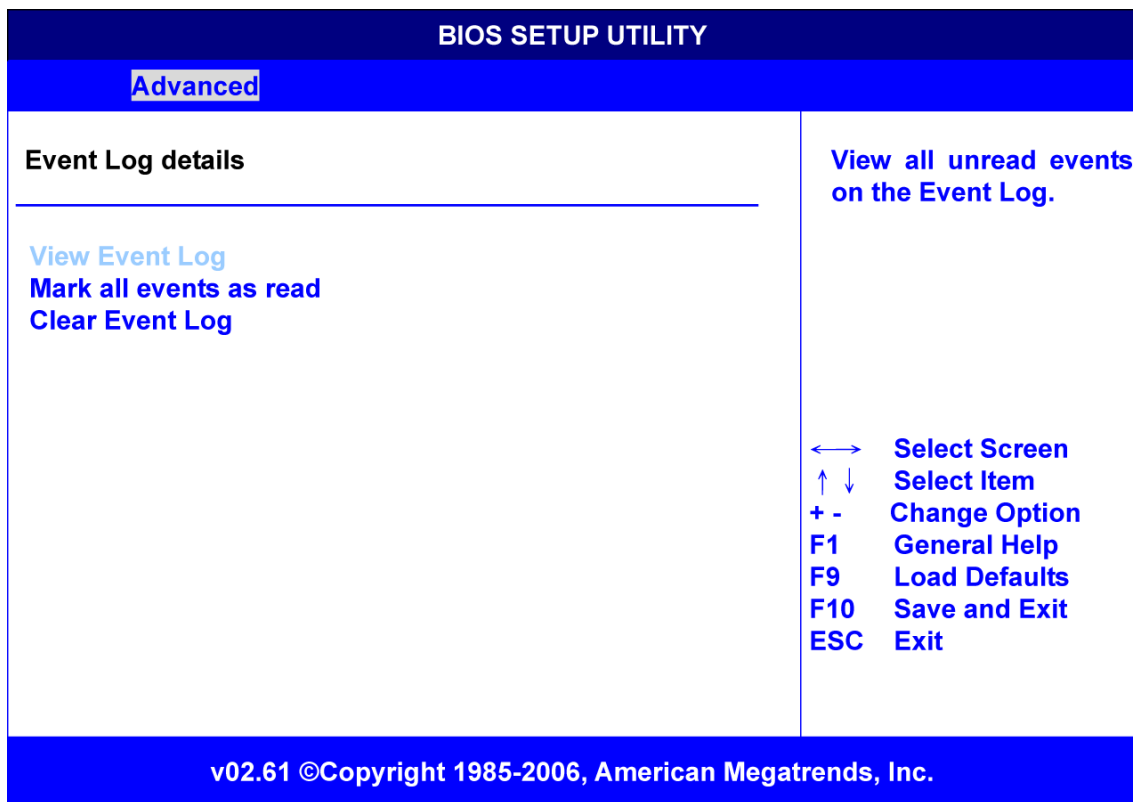
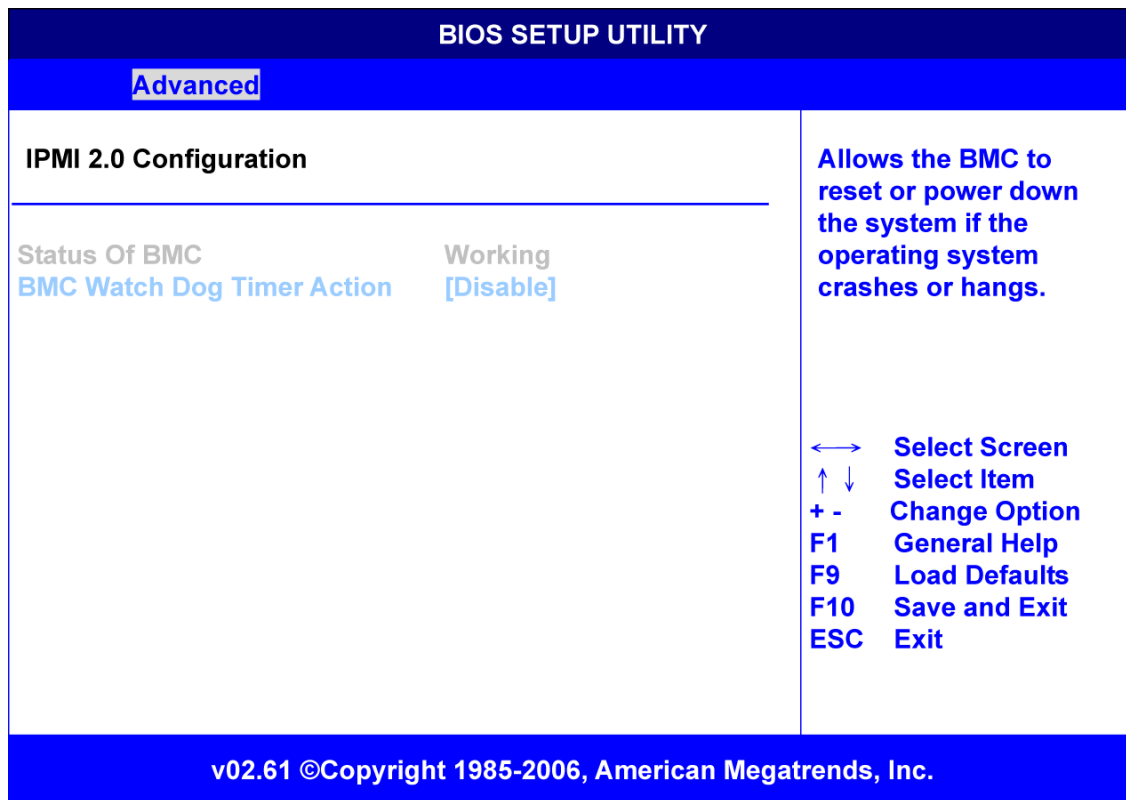

FIGURE A-7 IPMI 2.0 Configuration Menu



The screenshot shows the BIOS Setup Utility interface. At the top, a blue header bar contains the text "BIOS SETUP UTILITY". Below this, a sub-header bar is labeled "Advanced". The main content area is titled "IPMI 2.0 Configuration" and is divided into two columns. The left column contains the following text: "Status Of BMC" followed by "Working", and "BMC Watch Dog Timer Action" followed by "[Disable]". The right column contains a descriptive paragraph: "Allows the BMC to reset or power down the system if the operating system crashes or hangs." Below the paragraph is a legend of navigation keys: a left-right arrow for "Select Screen", up and down arrows for "Select Item", "+ -" for "Change Option", "F1" for "General Help", "F9" for "Load Defaults", "F10" for "Save and Exit", and "ESC" for "Exit". At the bottom of the screen, a blue footer bar contains the text "v02.61 ©Copyright 1985-2006, American Megatrends, Inc."

IPMI 2.0 Configuration	
Status Of BMC	Working
BMC Watch Dog Timer Action	[Disable]

Allows the BMC to reset or power down the system if the operating system crashes or hangs.

← → Select Screen
↑ ↓ Select Item
+ - Change Option
F1 General Help
F9 Load Defaults
F10 Save and Exit
ESC Exit

v02.61 ©Copyright 1985-2006, American Megatrends, Inc.

FIGURE A-8 Remote Access Configuration Menu

BIOS SETUP UTILITY	
Advanced	
Configure Remote Access type and parameters	
Remote Access	[Enable]
Serial Port Mode	[09600 8,n,1]
Flow Control	[None]
Redirection After BIOS POST	[Always]
Terminal Type	[ANSI]
Sredir Memory Display Delay	[No Delay]
	<p>← → Select Screen</p> <p>↑ ↓ Select Item</p> <p>+ - Change Option</p> <p>F1 General Help</p> <p>F9 Load Defaults</p> <p>F10 Save and Exit</p> <p>ESC Exit</p>
v02.61 ©Copyright 1985-2006, American Megatrends, Inc.	

FIGURE A-9 PCI Option ROM Configuration Menu

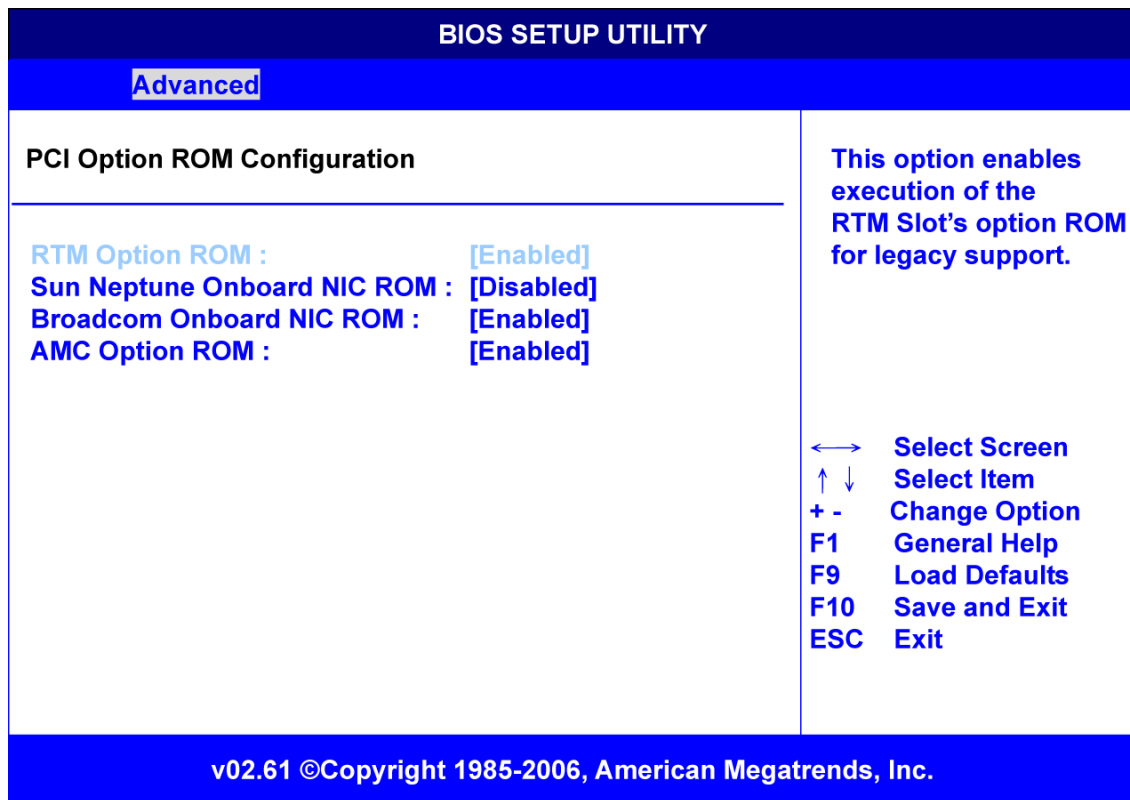

FIGURE A-10 Trusted Computing Menu

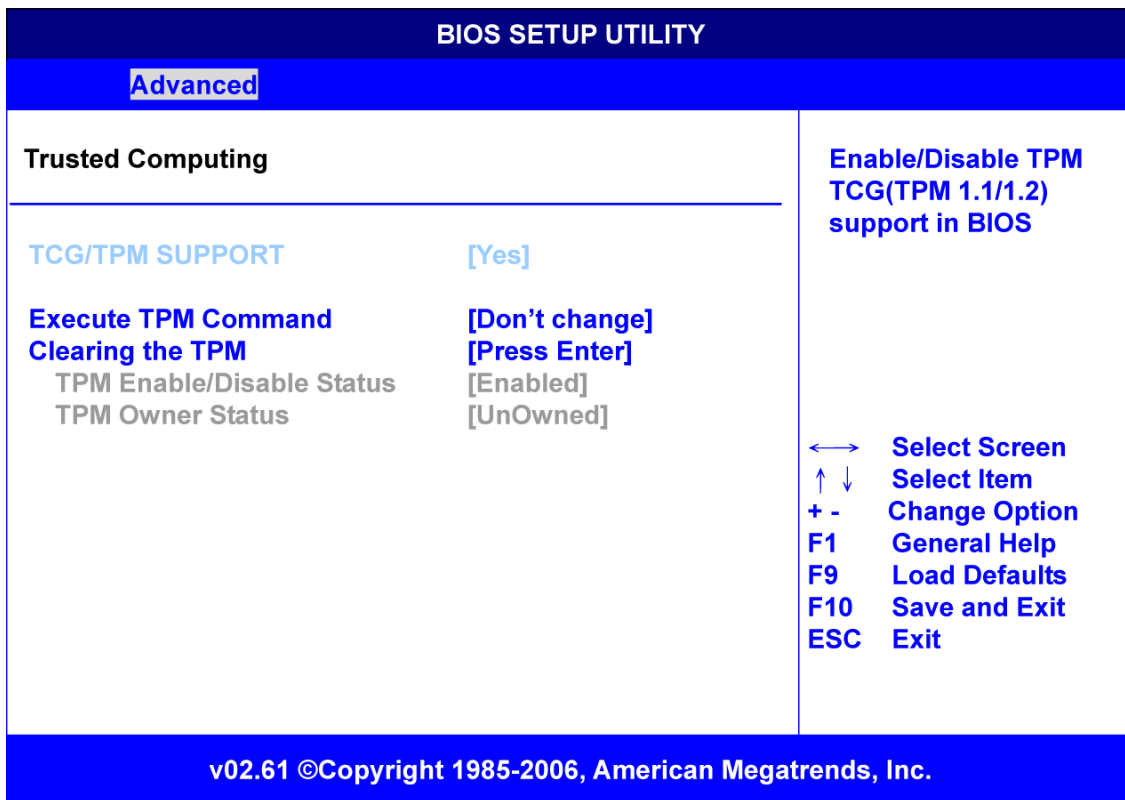

FIGURE A-11 Boot Settings Menu

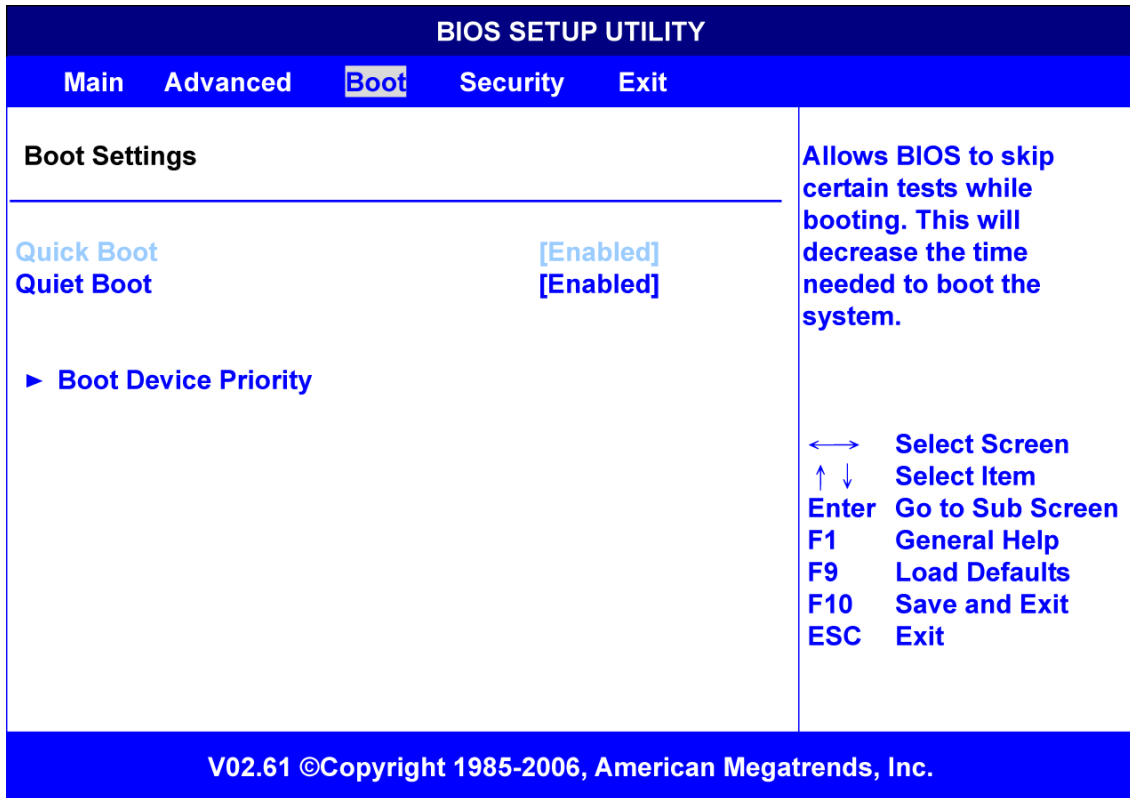

FIGURE A-12 Boot Device Priority Configuration Menu

BIOS SETUP UTILITY	
Boot	
Boot Devices Priority	
1 st Boot Device	[Removable Device]
2 nd Boot Device	[ATAPI CDROM]
3 rd Boot Device	[Hard Drive]
4th Boot Device	[IBA GE Slot 0310 v]
<p>Use ↑ or ↓ to select a device, then (1) press + to move it up the list, or – to move it down the list, or (2) press ENTER to pull down the list of devices, use ↑ or ↓ to select, then press ENTER to change it.</p> <p>←→ Select Screen ↑ ↓ Select Item + - Change Option F1 General Help F9 Load Defaults F10 Save and Exit ESC Exit</p>	
v02.61 ©Copyright 1985-2006, American Megatrends, Inc.	

FIGURE A-13 Security Settings Menu

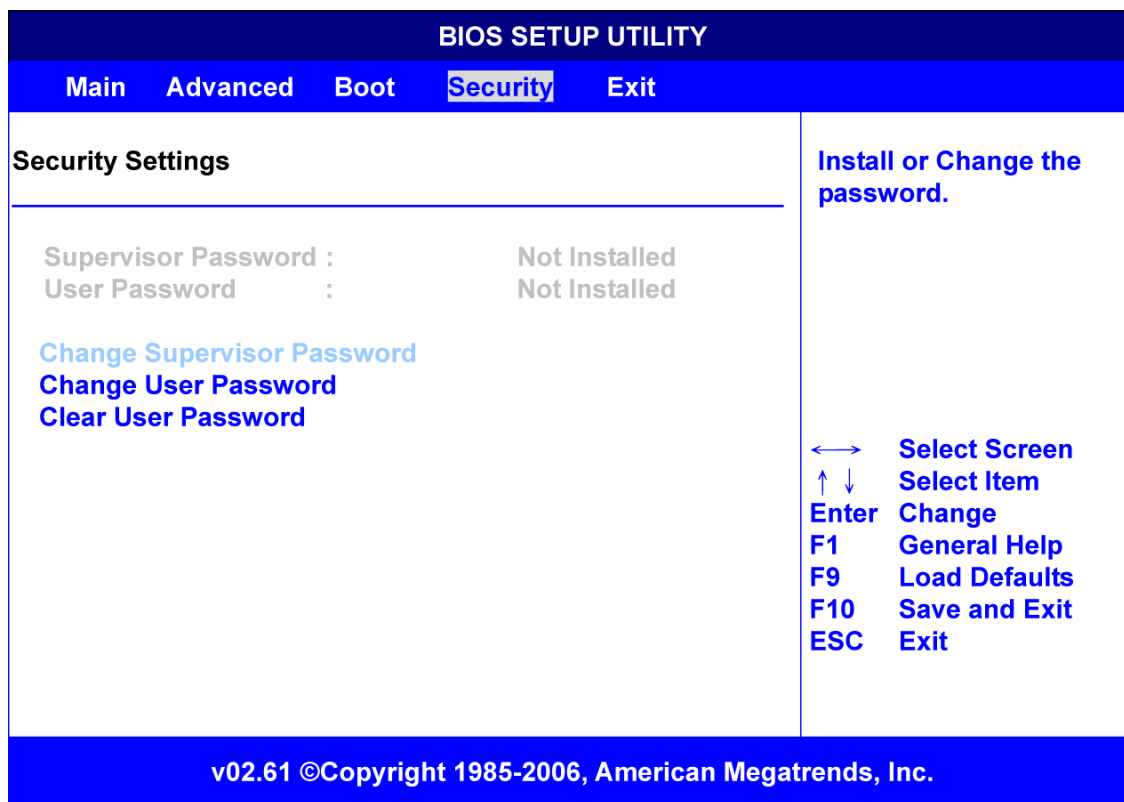
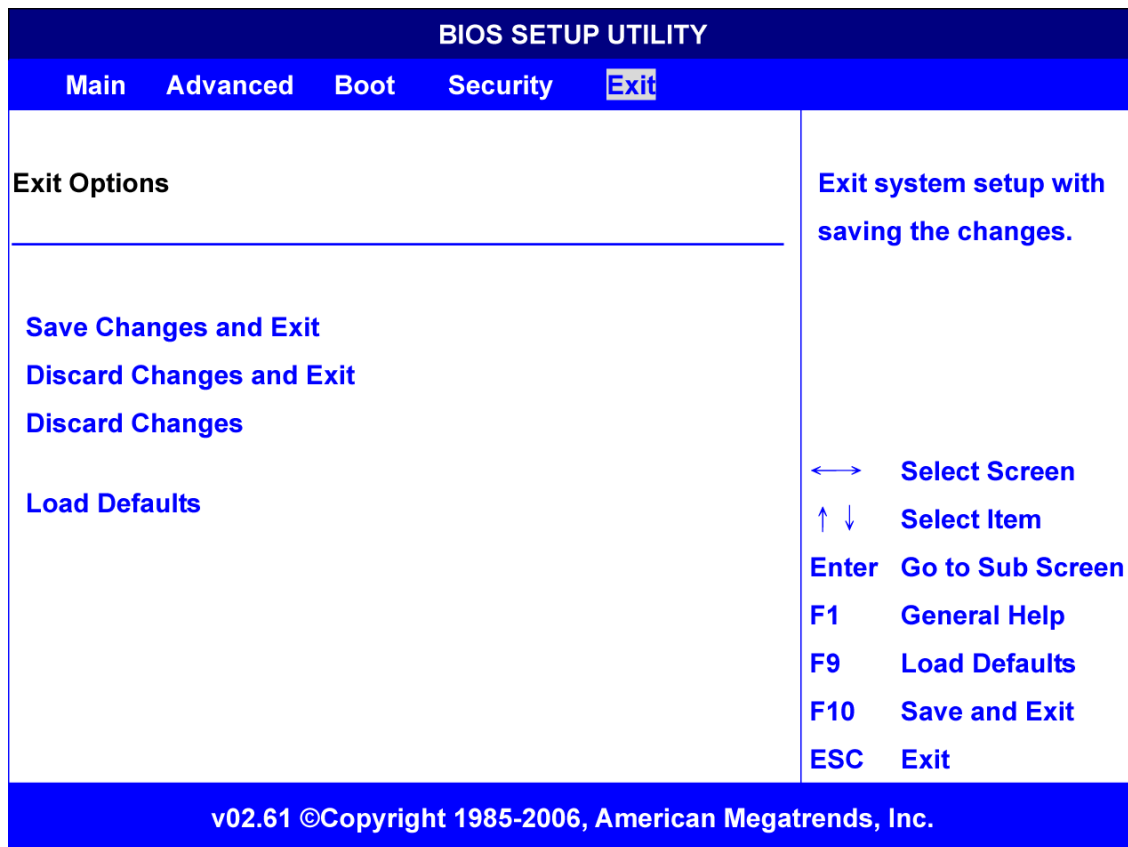

FIGURE A-14 Exit Menu



Physical Characteristics

Specifications for the Sun Netra CP3250 blade server are provided in the following sections:

- [Section B.1, "Form Factor" on page B-2](#)
- [Section B.2, "Power and Thermal Metrics" on page B-2](#)
- [Section B.3, "Connectors and Pinouts" on page B-2](#)

B.1 Form Factor

The Sun Netra CP3250 blade server is a standard 8-rack unit (8U) factor, single-slot wide. It complies with the board mechanical dimensions that are required by the PICMG 3.0 specification:

- 322.25 mm x 280 mm (12.7 inches x 11.0 inches)
- 30.48 mm (1.2 inch) front panel

B.2 Power and Thermal Metrics

Typical heat dissipation and power consumption metrics for a Sun Netra CP3250 blade server:

- 225W maximum power (includes 25W to ARTM, 20W to AMC, and two Intel Harpertown CPUs)
- -5C - 55C for NEBS compliance
- Power input: -36 VDC to -72 VDC (-48VDC nominal)
- CPU temperature thresholds are set relative to the Thermal Control Circuit (TCC) activation point of the Intel Harpertown CPUs. An offset of 95C is added to provide an approximate CPU die temperature.

Two heatsinks are mounted to the Sun Netra CP3250 blade server. The heatsinks and DIMMs are positioned on the blade server to provide adequate airflow (bottom to top).

B.3 Connectors and Pinouts

B.3.1 Front Panel Connectors

The front panel has the following connectors, see [FIGURE 1-1](#):

- One 10/100/1000BASE-T Ethernet port (RJ-45)
- One serial port (RJ-45)
- Two USB ports

B.3.1.1 Ethernet Port

The Ethernet connector is an RJ-45 connector. The controller autonegotiates to either 10 BASE-T, 100 BASE-T, or 1000 BASE-T.

FIGURE B-1 shows the Ethernet port connector.

FIGURE B-1 Ethernet RJ-45 Connector

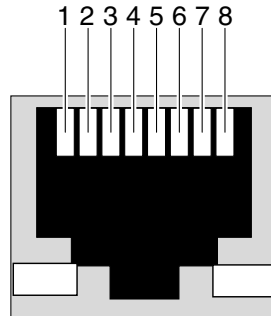

TABLE B-1 provides the eight pin assignments for the Ethernet port connector.

TABLE B-1 Ethernet Port Connector Pin Assignments

Pin	Signal Name	Pin	Signal Name
1	DA+	5	DC-
2	DA-	6	DB-
3	DB+	7	DD+
4	DC+	8	DD-

B.3.1.2 USB Ports

FIGURE B-2 shows the connector pin assignments for both of the front panel USB ports.

FIGURE B-2 Front Panel USB Connector

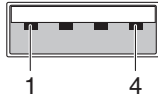

TABLE B-3 lists the USB port connector pin assignments.

TABLE B-2 USB Port Pin Assignments

Pin	Signal Name	Description
1	VCC	+5 VDA (500ma)
2	D-	Data-
3	D+	Data+
4	GND	Ground

B.3.1.3 Serial Port

FIGURE B-3 shows the connector pin assignments for the front panel serial port.

FIGURE B-3 Front Panel Serial RJ-45 Connector

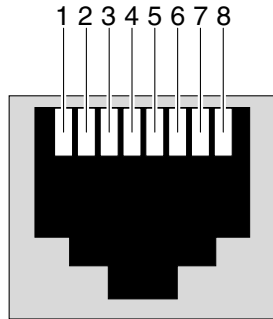

TABLE B-3 lists the serial port connector pin assignments.

TABLE B-3 Serial Port Mini DIN 8-pin Connector Pinouts

Pin	Signal Name	Pin	Signal Name
1	RTS	5	GND
2	DTR	6	RXD
3	TXD	7	DSR
4	GND	8	CTS

B.3.2 AMC Connector

One 170-pin connector provides the AMC connection. The connector and pinouts are defined by the industry-standard specification *PICMG Advanced Mezzanine Cards AMC.0 Specification R1.0 ECR-002 D0.9*, June 29, 2006.

The AMC slot is available at the front panel. The AMC can be accessed from the front panel, depending on the features of the AMC, or through an optional advanced rear transition module (ARTM).

B.3.3 Power Connector (Zone 1)

The Sun Netra CP3250 blade server uses a 34-pin Positronic connector as the Zone 1 power distribution connector. It provides the support for the following signals:

- Two -48 VDC power feeds (four signals each; eight signals total)
- Two IPMB ports (two signals each; four signals total)
- Geographic address (eight signals)

The analog test and ring voltage pins are left unconnected. [FIGURE B-4](#) shows the pin assignments.

FIGURE B-4 Power Distribution Connector (Zone 1) P10

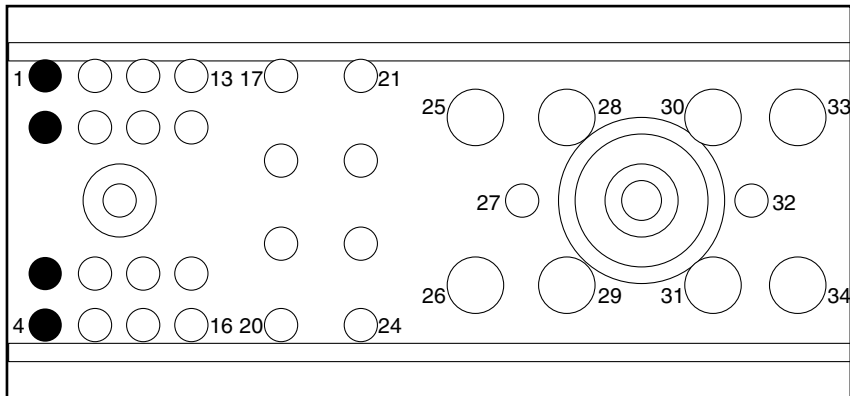

[TABLE B-4](#) lists the power distribution connector pin assignments.

TABLE B-4 Power Distribution Connector Pin Assignments

Pin Number	Name	Description
1	Reserved	Reserved
2	Reserved	Reserved
3	Reserved	Reserved
4	Reserved	Reserved
5	HA0	HA0 Hardware Address Bit 0
6	HA1	HA1 Hardware Address Bit 1
7	HA2	HA2 Hardware Address Bit 2
8	HA3	HA3 Hardware Address Bit 3
9	HA4	HA4 Hardware Address Bit 4

TABLE B-4 Power Distribution Connector Pin Assignments (*Continued*)

Pin Number	Name	Description
10	HA5	HA5 Hardware Address Bit 5
11	HA6	HA6 Hardware Address Bit 6
12	HA7/P	HA7/P Hardware Address Bit 7 (Odd Parity Bit)
13	SCL_A	IPMB Clock, Port A
14	SDA_A	IPMB Data, Port A
15	SCL_B	IPMB Clock, Port B
16	SDA_B	IPMB Data, Port B
17	MT1_TIP	Metallic Test #1 Tip
18	MT1_TIP	Metallic Test #2 Tip
19	-RING_A	Ring Generator A Negative Ringing
20	-RING_B	Ring Generator B Negative Ringing
21	MT1_RING	Metallic Test #1 Ringing
22	MT2_RING	Metallic Test #2 Ringing
23	-RING_A	Ring Generator A Return
24	-RING_B	Ring Generator B Return
25	SHELF_GND	Shelf Ground
26	LOGIC_GND	Logic Ground
27	ENABLE_B	Enable B
28	VRTN_A	Voltage Return A
29	VRTN_B	Voltage Return B
30	EARLY_A	-48V Early A
31	EARLY_B	-48V Early B
32	ENABLE_A	Enable A
33	-48V_A	-48V A
34	-48V_B	-48V B

B.3.4 Data Transport Connector (Zone 2)

The data transport connector consists of two 120-pin HM-Zd connectors, labeled P20 and P23, with 40 differential pairs each. These are called the Zone 2 connectors.

The Zone 2 connectors provides the following signals:

- Two 10/100/1000BASE-T/TX Ethernet base fabric channels (four differential signal pairs each; 16 signals total)
- Two 10-Gbit SERDES ports on the extended fabric (eight differential signal pairs each; 32 signals total)

The connector vendor part number is Tyco: 1469001-1.

FIGURE B-5 Zone 2 Connector

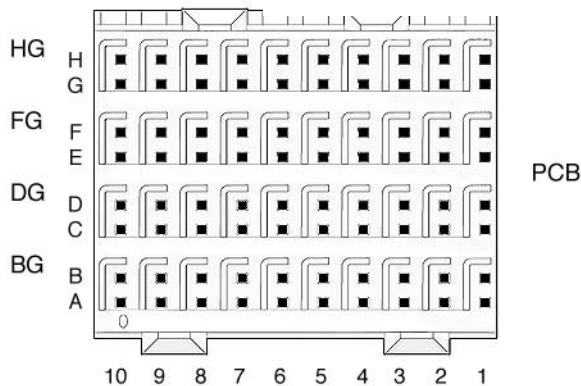

B.3.5 Advanced Rear Transition Module (ARTM) Connector (Zone 3)

The Sun Netra CP3250 blade server provides all the I/O connections for rear access through the Zone 3 advanced rear transition module (ARTM) connector. The connector view and the pinout for the Zone 3 connector are shown in [FIGURE B-6](#).

Zone 3 connector pinouts are presented from the point of view of the ATCA blade, meaning that TX means the ATCA blade is the signal source and the ARTM is the signal receiver. Similarly RX means the ATCA blade is the signal receiver and the ARTM is the signal source.

The “reserved” pins indicate connector pins that are currently reserved for compatibility to all ARTMs. Do not connect signals to reserved pins. The “no connect” indicates pins that should not be connected by the Sun Netra CP3250 blade server.

FIGURE B-6 Zone 3 Connector

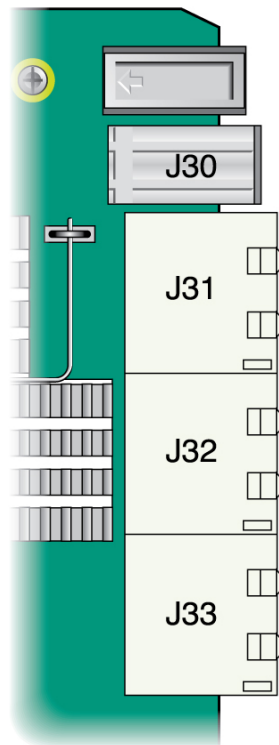

B.3.5.1 Zone 3 (J30) Connector Pin Assignments

TABLE B-6 shows the J30 connector pin assignments, used for power signals.

TABLE B-5 J30 Pin Connector Assignments

	1-3	4-6	Pin Length	Mating Sequence
E	PS1#	NC	short	last
D	+12V PP	+12V PP	long	first
C	IPMI_SCL_L	IPMI_SDA_L	medium	Second
B	Logic_GND	+3.3V_MP	long	First
A	Logic_GND	Shelf_GND	long	First

B.3.5.2 Zone 3 (J31) Connector PIN Assignments

TABLE B-7 shows the J31 connector pin assignments, used for ARTM signals.

TABLE B-6 J31 Connector Pin Assignments

Row	Interface	AB	BG	CD	DG	EF	FG			
1	AMC0 EO	RTM_TX13 + (AMC0 EO_Rx1+)	RTM_TX13 - (AMC0 EO_Rx1-)	GND	RTM_RX 12+ (AMC0 EO_Tx0+)	RTM_RX 12- (AMC0 EO_Tx0-)	GND	RTM_TX12 + (AMC0 EO_Rx0+)	RTM_TX12 - (AMC0 EO_Rx0-)	GND
2	AMC0 EO	RTM_RX14 + (AMC0 EO_Tx2+)	RTM_RX14 - (AMC0 EO_Tx2-)	GND	RTM_TX 14+ (AMC0 EO_Rx2+)	RTM_TX 14- (AMC0 EO_Rx2-)	GND	RTM_RX13 + (AMC0 EO_Tx1+)	RTM_RX13 - (AMC0 EO_Tx1-)	GND
3	AMC0 EO	RTM_TX17 + (AMC0 EO_Rx4+)	RTM_TX17 - (AMC0 EO_Rx4-)	GND	RTM_RX 15+ (AMC0 EO_Tx3+)	RTM_RX 15- (AMC0 EO_Tx3-)	GND	RTM_TX15 + (AMC0 EO_Rx3+)	RTM_TX15 - (AMC0 EO_Rx3-)	GND
4	AMC0 EO	RTM_RX18 + (AMC0 EO_Tx5+)	RTM_RX18 - (AMC0 EO_Tx5-)	GND	RTM_TX 18+ (AMC0 EO_Rx5+)	RTM_TX 18- (AMC0 EO_Rx5-)	GND	RTM_RX17 + (AMC0 EO_Tx4+)	RTM_RX17 - (AMC0 EO_Tx4-)	GND

TABLE B-6 J31 Connector Pin Assignments (*Continued*)

Row	Interface	AB		BG	CD		DG	EF		FG
5	AMC0 EO	RTM_TX20 + (AMC0 EO_Rx7+)	RTM_TX20 - (AMC0 EO_Rx7-)	GND	RTM_RX 19+ (AMC0 EO_Tx6+)	RTM_RX 19- (AMC0 EO_Tx6-)	GND	RTM_TX19 + (AMC0 EO_Rx6+)	RTM_TX19 - (AMC0 EO_Rx6-)	GND
6	AMC0 EO	Reserved	Reserved	GND	Reserved	Reserved	GND	RTM_RX20 + (AMC0 EO_Tx7+)	RTM_RX20 - (AMC0 EO_Tx7-)	GND
7	Reserved	Reserved	Reserved	GND	Reserved	Reserved	GND	Reserved	Reserved	GND
8	Reserved	Reserved	Reserved	GND	Reserved	Reserved	GND	Reserved	Reserved	GND
9	Reserved	Reserved	Reserved	GND	Reserved	Reserved	GND	Reserved	Reserved	GND
10	Reserved	Reserved	Reserved	GND	Reserved	Reserved	GND	Reserved	Reserved	GND

B.3.5.3 Zone 3 (J32) Connector PIN Assignments

TABLE B-8 shows the J32 connector pin assignments, used for ARTM signals.

TABLE B-7 J32 Connector Pin Assignments

Row	Interface	AB		BG	CD		DG	EF		FG
1	Reserved	Reserved	Reserved	GND	Reserved	Reserved	GND	Reserved	Reserved	GND
2	SAS AMC0	SAS TX0+ (AMC0 SAS0_Rx+)	SAS TX0- (AMC0 SAS0_Rx-)	GND	SAS RX0+ (AMC0 SAS0_Tx+)	SAS RX0- (AMC0 SAS0_Tx-)	GND	RTS (Serial 0)	DTR (Serial 0)	GND
3	Reserved	Reserved	Reserved	GND	Reserved	Reserved	GND	TXD (Serial 0)	RXD (Serial 0)	GND
4	SAS AMC0	SAS TX2+ (AMC0 SAS1_Rx+)	SAS TX2- (AMC0 SAS1_Rx+)	GND	SAS RX2+ (AMC0 SAS1_Rx+)	SAS RX2- (AMC0 SAS1_Rx+)	GND	DSR (Serial 0)	CTS (Serial 0)	GND
5	Reserved	Reserved	Reserved	GND	Reserved	Reserved	GND	No Connect	No Connect	GND
6	RTM LAN0 (Mgmt)	LAN0_A+	LAN0_A-	GND	LAN0_CT V	LAN0_CT V	GND	LAN0_B+	LAN0_B-	GND
7	RTM LAN0 (Mgmt)	LAN0_C+	LAN0_C-	GND	ACT_LED #	LINK_LE D#	GND	LAN0_D+	LAN0_D-	GND

TABLE B-7 J32 Connector Pin Assignments (*Continued*)

Row	Interface	AB	BG	CD	DG	EF	FG			
8	RTM LAN1 (SerDes)	SLAN_TX 1+	SLAN_TX 1-	GND	SLAN_RX 1+	SLAN_RX 1-	GND	No Connect	No Connect	GND
9	RTM LAN2/L AN4 (SerDes)	SLAN_TX 2+	SLAN_TX 2-	GND	SLAN_RX 2+	SLAN_RX 2-	GND	SLAN_TX 4+	SLAN_TX 4-	GND
10	RTM LAN3/L AN4 (SerDes)	SLAN_TX 3+	SLAN_TX 3-	GND	SLAN_RX 3+	SLAN_RX 3-	GND	SLAN_RX 4+	SLAN_RX 4-	GND

B.3.5.4 Zone 3 (J33) Connector PIN Assignments

[TABLE B-9](#) shows the J33 connector pin assignments, which are used ARTM signals.

TABLE B-8 J33 Connector Pin Assignments

Row	Interface	AB	BG	CD	DG	EF	FG			
1	PCIe x8 Lane	PETx0+	PETx0-	GND	PERx0+	PERx0-	GND	FCLKA+	FCLKA-	GND
2	PCIe x8 Lane	PETx1+	PETx1-	GND	PERx1+	PERx1-	GND	TCLKA+	TCLKA-	GND
3	PCIe x8 Lane	PETx2+	PETx2-	GND	PERx2+	PERx2-	GND	TCLKB+	TCLKB-	GND
4	PCIe x8 Lane	PETx3+	PETx3-	GND	PERx3+	PERx3-	GND	TCLKC+	TCLKC-	GND
5	PCIe x8 Lane	PETx4+	PETx4-	GND	PERx4+	PERx4-	GND	TCLKD+	TCLKD-	GND
6	PCIe x8 Lane	PETx5+	PETx5-	GND	PERx5+	PERx5-	GND	TCK	TMS	GND
7	PCIe x8 Lane	PETx6+	PETx6-	GND	PERx6+	PERx6-	GND	TRST#	TDO	GND
8	PCIe x8 Lane	PETx7+	PETx7-	GND	PERx7+	PERx7-	GND	TDI	PCI_RST #	GND
9	Reserved	No Connect	No Connect	GND	No Connect	No Connect	GND	ARTM#	PCI_CFG	GND
10	Reserved	No Connect	No Connect	GND	No Connect	No Connect	GND	PS0#	Enabled#	GND

B.3.5.5 Zone 3 Signal Descriptions

TABLE B-10 provides descriptions of the signals listed in the Zone 3 pin assignment tables (TABLE B-6 through TABLE B-9).

TABLE B-9 Zone 3 Signal Descriptions

Signal Name	Description
IPMI_SCL_L	IPMI bus clock signal, as defined in AMC.0 specification. RTM shall have a pull-up resistor for this signal as indicated in AMC.0 specification.
IPMI_SDA_L	IPMI bus data signal, as defined in AMC.0 specification. RTM shall have a pull-up resistor for this signal as indicated in AMC.0 specification.
PS0#, PS1#	Active low RTM present signal. PS0# shall be tied to logic GND on the ATCA blade, PS1# shall be pulled up to 3.3V Management Power on the ATCA blade, PS0# and PS1# shall be connected through diode on RTM, exactly as defined in AMC.0 specification. PS1# is last mate on Power connector and PS0# is on the opposite end of the set of connectors. Logic low on PS1# indicates that RTM is present and fully inserted.
Enable#	When low indicates to RTM that it is fully inserted and that MMC can start execution. Logic high shall keep MMC in reset state. This signal shall have a pull-up resistor as indicated in AMC.0 specification.
Shelf_GND	Frame/Chassis Safety Ground.
Logic_GND	(Logic 0vdc). Logic Ground- Common return for Management Power Payload Power, reference potential for single-ended logic signaling, and shielding for differential pair signals in the AMC Connector.
12VPP	12V Payload Power, enabled after successful E-keying, following AMC.0 specification. RTM shall meet requirements posted for payload power in AMC specification.
3.3V_MP	3.3V Management Power. RTM shall meet requirements posted for management power in AMC.0 specification.
RTM_RX	AMC Extended Options receive differential pair signals. Note that this specification takes ATCA Blade perspective, which means that RX signals are driven by RTM and received by ATCA Blade.
RTM_TX	AMC Extended Options transmit differential pair signals. Note that this specification takes ATCA Blade perspective, which means that TX signals are driven by ATCA Blade and received by RTM.
SAS_TX	SATA/SAS transmit differential pair signals.
SAS_RX	SATA/SAS receive differential pair signals.
Serial 0	RS-232 Serial Signals, Transmit, Receive, Clear to Send, Request to Send, Data Terminal Ready, and Data Set Ready.
LAN0	10/100/1000BASE-T signals.
LAN0_CTV	10/100/1000BASE-T transformer Center Tap signal, which could be used to terminate center tap of transformers, if they are placed on RTM. This signal is applicable if Ethernet PHY is located on ATCA blade, while transformers are located on RTM.

TABLE B-9 Zone 3 Signal Descriptions (*Continued*)

Signal Name	Description
ACT_LED#	LAN 0 (Management) activity indicator signal for LED (active low).
LINK_LED#	LAN 0 (Management) LINK indicator signal for LED (active low).
PCI_CFG	PCI Express bus configuration signal. It shall be grounded on RTMs that use a single x8 PCI Express bus and pulled up on the ATCA with 10Kohm resistor to management power. On RTMs that expect two x4 PCI-Express busses this pin will float (not be connected). Two x4 PCI-Express busses are intended for RTM implementations that desire to avoid PCI-Express switch in order to reduce latency.
ARTM#	ARTM# signal shall be grounded on ARTMs that implement MMC controller as defined by AMC.0 specification. This signal shall be pulled up with 10Kohm resistor to management power on the ATCA node blade server.
SLAN_TX	GBEthernet SerDes transmit differential pair signals.
SLAN_RX	GBEthernet SerDes receive differential pair signals.
PETx	PCI-Express transmit differential pair signals.
PERx	PCI-Express receive differential pair signals.
PCI_RST#	PCI-Express reset signal. Logic low shall reset downstream PCI-Express devices on ARTM.
TCLKA	PCI-Telecom clock A 19.44MHz, differential pair into RTM (ATCA CLK2) as defined in AMC.0 specification.
TCLKB	PCI-Telecom clock B 19.44MHz, differential pair out from RTM (ATCA CLK3) as defined in AMC.0 specification.
TCLKC	PCI-Telecom clock C 8kHz, differential pair into RTM (ATCA CLK1) as defined in AMC.0 specification.
TCLKD	PCI-Telecom clock D 8kHz, differential pair out from RTM as defined in AMC.0 specification.
FCLKA	Fabric clock, as defined in AMC.0 specification. Intended to be used for PCI-Express 100 MHz spread spectrum clock.
TCK, TMS, TRST#, TDO, TDI	JTAG signals. Signal direction shall follow AMC.0 specification.

ShMM CLI and Commands

This appendix provides information about using the ShMM CLI and most commonly used ShMM commands.

This appendix contains the following topics:

- [“Shelf Manager Command-Line Interface” on page 2](#)
- [“Shelf Manager CLI Commands” on page 3](#)

C.1 Shelf Manager Command-Line Interface

The Shelf Manager command-line interface (CLI) can be used to communicate with the intelligent management controllers of the shelf, with blade servers, and with the Shelf Manager itself, through text commands. The CLI is an IPMI-based set of commands that can be accessed directly or through a higher-level management application or a script. Administrators can access the CLI through a Telnet connection or the shelf management card serial port. Using the CLI, operators can access information about the current state of the shelf including current FRU population, current sensor values, threshold settings, recent events, and overall shelf health.

▼ To Start the Command-Line Interface

1. **To use the CLI, first log on to the Linux operation system on the shelf management card.**
2. **Once logged in, run the executable `clia` from the command line with specific parameters.**

The first parameter is the command verb. The `clia` executable is located on the virtual root file system maintained by Linux running on the shelf management card. The `clia` executable connects to the main Shelf Manager software process, passes the command information to it, and retrieves the results. The Shelf Manager must be running prior to starting the CLI. For example:

```
# clia ipmc 20

Pigeon Point Shelf Manager Command Line Interpreter

20: Entity: (d0, 0) Maximum FRU device ID: 20
    PICMG Version 2.0
    Hot Swap State: M4, Previous: M3, Last State Change Cause: Normal State Change
(0)
#
```

If started without parameters, `clia` enters an interactive mode. In that mode, the program repeatedly issues a prompt to the terminal, accepts user input as the next command with parameters, executes that command, and shows the results on the terminal, until the user types the command `exit` or `quit`. For example:

```
# clia

Pigeon Point Shelf Manager Command Line Interpreter

CLI> ipmc 20

20: Entity: (d0, 0) Maximum FRU device ID: 20
    PICMG Version 2.0
    Hot Swap State: M4, Previous: M3, Last State Change Cause: Normal State Change
    (0)

CLI> exit
#
```

C.2 Shelf Manager CLI Commands

The Shelf Manager CLI implements the following commands. They are described in detail in the *Netra CT 900 Server System Administration Manual (819-1177)*, with a subsection for each command, in alphabetical order of the command names. For the web site URL, see [“Related Documentation” on page xv](#).

TABLE C-1 Shelf Manager CLI Command Summary

Command	Parameters	Description
<code>activate</code>	IPMB address FRU device ID	Activates the specified FRU.
<code>alarm</code>	alarm type	Activates or clears Telco alarms.
<code>board -v</code>	slot number (optional)	Shows information about blade servers.
<code>boardreset</code>	slot number	Resets the specified ATCA blade server.
<code>console</code>	slot number	Opens a console session on the node blade server in the specified slot.
<code>deactivate</code>	IPMB address FRU device ID	Deactivates the specified FRU.
<code>exit quit</code>		Exits from the interpreter in interactive mode.

TABLE C-1 Shelf Manager CLI Command Summary (*Continued*)

Command	Parameters	Description
<code>fans</code>	IPMB address (optional) FRU device ID (optional)	Shows information about fans.
<code>fru</code>	IPMB address (optional) FRU device ID (optional) FRU type (optional)	Shows information about one or a group of FRUs in the shelf; FRUs are selected by type or by the parent IPM controller.
<code>frudata</code>	IPMB address (optional) FRU device ID (optional) block/byte offset (optional) data (optional)	Provides raw access to the FRU. Information on the specified FRU.
<code>frudatar</code>	IPMB address FRU device ID File name	Reads the FRU data area of the specified FRU and stores the data in the specified file.
<code>frudataw</code>	IPMB address FRU device ID File name	Writes the FRU data in the specified file into the FRU data area of the specified FRU.
<code>fruinfo -v</code>	IPMB address FRU device ID	Provides user-friendly FRU Information output.
<code>getthreshold threshold</code>	IPMB address (optional) sensor name (optional) sensor number (optional)	Shows threshold information about a specific sensor.
<code>help</code>		Shows the list of supported commands.
<code>ipmc</code>	IPMB address (optional)	Shows information about one or all IPM controllers in the shelf.
<code>minfanlevel</code>	fan level (optional)	Shows or sets the minimum fan level.
<code>ps -ef grep hp</code>		Checks the <code>openhpi</code> status.
<code>sensor</code>	IPMB address (optional) sensor name (optional) sensor number (optional)	Shows information about one or a group of sensors; sensors are selected by IPM controller address, number or name.
<code>sensordata</code>	IPMB address (optional) sensor name (optional) sensor number (optional)	Shows value information for a specific sensor.
<code>sensorread</code>	IPMB address sensor number	Shows raw value information for a specific sensor (ignoring any Sensor Data Record describing the sensor).

TABLE C-1 Shelf Manager CLI Command Summary (*Continued*)

Command	Parameters	Description
setfanlevel	IPMB address FRU device ID level	Sets a new level for the fan controlled by the specified FRU. Use <code>cli> setfanlevel 20 3 5</code> to get the fans to slow down.
setfanpolicy	IPMB address FRU device ID action to be taken: ENABLE or DISABLE timeout (optional) site type (optional) site number (optional)	Enables or disables fan trays for cooling management in addition to the Fan Geography record if this one is presented in the Shelf FRU.
setthreshold	IPMB address sensor name sensor number threshold type threshold value	Changes a specific threshold value (upper/lower, critical/non-critical/non-recoverable) for a specific sensor.
setuserlabel	shelf name slot number name	Configures user assigned names for the shelf and the blade servers. Blade server names are assigned to slot numbers.
shelf	subcommand, with its parameters	Shows general information about the shelf; several subcommands allow setting shelf attributes and getting additional information about specific areas.
shelfaddress	Shelf Address string (optional)	Gets or sets the Shelf Address field of the Address Table within Shelf FRU Information.
shelf address_table		Shows the address table record in the shelf FRU info with shelf address and list of address table entries. For each entry, shows hardware address, site type, and site number.
shelf cooling_state		Shows the current cooling state of the shelf with normal, minor, major, and critical alert information.
shelf fans_state		Shows the current state of the fan tachometers in the shelf with normal, minor, major and critical alert information.
shmstatus		Shows the Shelf Manager Active/Backup status.

TABLE C-1 Shelf Manager CLI Command Summary (*Continued*)

Command	Parameters	Description
showhost	slot-number	Displays version information about the firmware on certain Netra CP3x60 node blade servers.
showunhealthy		Shows the unhealthy components of the shelf.
switchover		Initiates a switchover to the backup Shelf Manager.
terminate		Terminates the Shelf Manager without rebooting the shelf management card.
version		Shows the Shelf Manager version information.

Most informational commands support brief and verbose modes of execution, differing in the amount of information provided. Brief mode is the default (standard); verbose mode is selected by using the option `-v` in the command line, directly after the command and before the positional arguments. Commands that are executed on the backup Shelf Manager can only access objects (such as sensors, FRUs, IPM controllers) that are local to the backup Shelf Manager.

To help the user to determine whether a specific command is being executed on the active or on the backup Shelf Manager, the following message is issued when a CLI command is executed on the backup Shelf Manager: `Running on the Backup Shelf Manager, with limited functionality.`

Index

A

- AMC cards supported, 1-8
- AMC connectors, B-5
- AMC devices
 - additional I/O, 1-8
 - installing, 2-27

B

- barcode labels, locating, 1-13
- BIOS
 - about settings, 5-2
 - changing boot device, 5-4
 - changing configuration, 5-3
 - changing passwords, 5-5
 - screen descriptions, 5-3
 - updating, 5-6
- BIOS menus
 - Advanced Settings, A-3
 - Boot Setting, A-12
 - Boot Settings Configuration, A-13
 - CPU Configuration, A-4
 - IDE Configuration, A-5
 - PCI Express Configuration, A-10
 - Remote Access Configuration, A-9
 - Security Settings, A-14
- Boot Setting menu, A-12
- Boot Settings Configuration menu, A-13
- booting, 1-7

C

- cabling, 2-14
 - installing, 2-13

- system console, 2-15
 - system console for Solaris, 2-13
- chassis. *See* shelf, 1-7
- CMOS settings
 - clearing, 2-31
- collecting network information, 2-5
- Compact Flash
 - installing, 2-24
- configurations, I/O, 1-10
- connectors, B-2
- contacting support, 1-13
- CPU Configuration menu, A-4

D

- data transport connector, B-8
- DDR-2 DIMM. *See* DIMMs, 2-19
- DIMMs
 - described, 2-19
 - installing, 2-21
 - matching pairs, 2-19
 - removing, 2-23

E

- electric shock caution, 2-2
- Ethernet, RJ-45, B-3

F

- front panel, B-5

H

- hardware installation, 2-1 to 2-30

- AMC device, 2-27
- checking environmental requirements, 2-4
- collecting network information, 2-5
- Compact Flash, 2-24
- DIMM modules, 2-19
- preparation, 2-4
- rear transition modules, 2-8
- summary, 2-6
- tools needed, 2-3

hardware requirements, 1-12

hot-swap support, 1-11

I

- I/O configurations, 1-10
- I/O connections, internal to backplane, 1-4
- IDE Configuration menu, A-5
- installation
 - AMC device, 2-27
 - DIMMs, 2-21
 - overall procedure, 2-6
 - preparation, 2-4
 - rear transition modules, 2-8

J

- Jumper 1
 - resetting, 2-31

M

- MAC address, 2-5
 - label, 1-14
- memory, 3-4
 - DIMM requirements, 2-19
- menu, *See* BIOS menus

N

- netinstall boot device, 2-15
- networking and I/O, 3-5

O

- operating system compatibility, 4-2

P

- part number, locating, 1-14
- password changing BIOS, 5-5
- PCI Express Configuration menu, A-10
- pinouts, B-2

- pinouts, serial port, B-5
- POST
 - changing options, 5-9
- power connector, B-6
- power off, 2-17
 - events, 2-18
- preparation, installation, 2-4

R

- rear transition module
 - connector, B-9
 - features, 1-8
 - installation, 2-8
- Remote Access Configuration menu, A-9
- removing DIMMs, 2-23
- removing the board, 2-18
- requirements
 - hardware, 1-12
 - safety, 2-2
- revision number, locating, 1-14
- RJ-45 Ethernet, B-3

S

- Security Settings menu, A-14
- serial
 - number, locating, 1-13
 - port, B-5
- shelf manager
 - CLI command summary, C-3
 - command-line interface, C-2
 - starting CLI, C-2
- software
 - OS support, 4-2
 - SunVTS, 4-3
- Sun Services, 1-13, 4-2
- SunVTS software, -xiii, 4-3
- support, contacting, 1-13
- switches, configuring for 1GbE or 10GbE, 4-4

W

- warranty, 1-13

Free Manuals Download Website

<http://myh66.com>

<http://usermanuals.us>

<http://www.somanuals.com>

<http://www.4manuals.cc>

<http://www.manual-lib.com>

<http://www.404manual.com>

<http://www.luxmanual.com>

<http://aubethermostatmanual.com>

Golf course search by state

<http://golfingnear.com>

Email search by domain

<http://emailbydomain.com>

Auto manuals search

<http://auto.somanuals.com>

TV manuals search

<http://tv.somanuals.com>