

 **STANDARD HORIZON**

# CPV350

GPS Chart Plotter  
with VHF FM Marine Transceiver

---

## OWNER'S MANUAL



---

### **WARNING!!!**

Electronic charts displayed by the CPV350 are believed to be accurate and reliable, but that are not intended to be a substitute for the official charts, which should remain your main reference for all matters related to the execution of safe navigation. For this reason we would like to remind you that you should carry on board and use the official published and approved nautical charts.

---

---

### **FCC NOTICE**

This equipment has been tested and found to comply with the limits for a Class A digital device, pursuant to part 15 of the FCC Rules. These limits are designed to provide reasonable protection against harmful interference when the equipment is operated in a commercial environment. This equipment generates, uses, and can radiate radio frequency energy and, if not installed and used in accordance with the instruction manual, may cause harmful interference to radio communications. Operation of this equipment in a residential area is likely to cause harmful interference in which case the user will be required to correct the interference at his own expense.

### **NOTICE**

Unauthorized changes or modifications to this equipment may void compliance with FCC Rules. Any change or modification must be approved in writing by Marine Division of Vertex Standard.

---

Congratulations on your purchase of the CPV350C GPS Chart Plotter with VHF FM Marine Transceiver!

Whether this is your first GPS chartplotter, or if you have other STANDARD HORIZON equipment, the STANDARD HORIZON organization is committed to ensuring your enjoyment of this GPS chartplotter. STANDARD HORIZON technical support personnel stand behind every product we sell, and our Product Support team invites you to contact us should you require technical advice or assistance, at 800/767-2450.

---

#### **CAUTION**

- The GPS chartplotter is designed for maritime use. Please give attention to avoid water intrusion into the C-MAP NT\*/MAX C-CARD cartridge holder.
- Extensive exposure to heat may result in damage to the GPS chartplotter.
- The GPS chartplotter contains dangerous high voltage circuits which only experienced technicians can handle.
- STANDARD HORIZON will not be liable for errors contained herein, or for incidental or consequential damages in connection with the performance or use of this material.

---

#### **CLEANING PROCEDURE FOR THE CHARTPLOTTER SCREEN**

Cleaning of the chartplotter screen is a very important and must be done carefully. Since the surface is covered by an antireflective coating, the procedure for cleaning all the surfaces can be performed using the following procedure: You need a soft tissue or towel and a cleaning spray (Windex) containing Isopropanol (a normal spray cleaner sold for a PC screen, for example PolaClear by Polaroid). Fold the tissue or lens tissue into a triangular shape, moisten the tip and use the index finger behind a corner to move the tissue across the surface, in overlapping side to side strokes. If the tissue is too wet, a noticeable wet film will be left in its path and you will need to repeat the process. If too dry, the tissue won't glide easily, and may damage the surface.

# TABLE OF CONTENTS

<b>1. INTRODUCTION</b>	<b>8</b>
1.0 GENERAL INFORMATION	8
1.1 PACKING LIST	9
1.1.0 Packing List	9
1.2 OPTIONAL ACCESSORIES	9
1.3 SAFETY / WARNING INFORMATION	10
1.3.0 VHF Marine Antenna Installation	10
1.3.1 ON-LINE Warranty Registration	10
1.3.2 Product Support Inquires	10
1.4 FCC RADIO LICENSE INFORMATION	11
1.4.0 Station License	11
1.4.1 Radio Call Sign	11
1.4.2 Canadian Ship Station Licensing	11
1.4.3 FCC / Industry Canada Information	11
<b>2. GETTING STARTED</b>	<b>12</b>
2.0 MOUNTING THE GPS CHARTPLOTTER	12
2.1 BRACKET MOUNTING	12
2.2 FLUSH MOUNTING	13
2.3 CONNECTIONS	14
2.3.0 Rear Panel Connections	14
2.3.1 VHF Antenna	15
2.3.2 Selecting a Marine VHF Antenna	15
2.3.3 Coaxial Cable	16
2.3.4 Optional Enhanced Second VHF/PA Station	17
2.3.5 NMEA Connections	19
2.3.6 Outputting NMEA to a Personal Computer	19
2.3.7 Serial PC Connection	19
2.3.8 Outputting GPS Coordinates	20
2.3.9 NMEA Data Page	20
2.4 GPS ANTENNA	21
2.4.0 Mounting the GPS WAAS Smart Antenna	21
2.4.1 Mounting on a Pole	21
2.4.2 Flush Mounting	21
2.4.3 PA Horn Connections	22
2.5 SMART GPS CONNECTOR TABLE	22
2.6 BATTERY CONNECTIONS	22
2.7 OPTIONAL BLACK BOX FISH FINDER	23
2.8 OPTIONAL VHF EXTERNAL SPEAKER	23
<b>3. C-MAP MAX OVERVIEW</b>	<b>24</b>
3.0 INTRODUCTION	24
3.1 INSERTING THE C-CARD	25
<b>4. MAP FUNCTIONS</b>	<b>26</b>
4.0 NEW MAX FUNCTIONS MENU	26
4.0.0 Zoom Type	26
4.0.1 Fonts & Symbols	26
4.0.2 Perspective View	27
4.0.3 Dynamic Nav-Aids	27
4.0.4 Safety Status Bar (DSI - Data Safety Indicator)	28
4.0.5 Currents Prediction	29
<b>5. DATA FUNCTION</b>	<b>30</b>
5.0 PICTURES & DIAGRAMS	30
5.0.0 How to show the pictures or diagrams of a Multimedia Object	31
5.1 ENHANCED PORT INFO	31
<b>6. CONTROLS AND INDICATORS</b>	<b>32</b>
6.0 CONTROLS AND CONNECTIONS	32
6.1 GETTING STARTED	33
6.1.0 Power On, Off and ShuttlePoint knob operation	33
6.1.1 Cursor Vs. Home Mode	34
6.1.2 Cursor and Menu selection speed	35
6.1.3 Changing the Ships Icon	35
6.1.4 Changing the backlight and contrast	36
6.1.5 Selecting North Up or Course Up	36
6.2 ADJUSTING THE TIME	37

6.3	SELECTING LORAN TD OR OTHER COORDINATE SYSTEM .....	38
6.4	CHANGING THE CHART COLOR .....	39
6.5	SELECTING PAGES USING SOFT KEYS .....	39
6.6	CUSTOMIZING THE SOFT KEYS .....	40
6.7	OTHER SETTINGS IN GENERAL SETUP MENU .....	40
6.8	INFORMATION PAGE .....	41
<b>7.</b>	<b>USING FIND SERVICES &amp; MORE FUNCTION .....</b>	<b>42</b>
7.0	PORT SERVICES .....	42
7.1	OTHER AVAILABLE SEARCHES .....	42
7.2	INFO ON LAKES .....	43
7.2.0	Quick Info On Lakes .....	43
7.2.1	Full Info On Lakes .....	43
<b>8.</b>	<b>CREATING MARKS .....</b>	<b>45</b>
8.0	CREATING A NEW MARK USING THE CHART PAGE .....	45
8.1	EDITING a MARK .....	45
8.1.0	Deleting a Mark or Waypoint .....	46
8.1.1	Moving a Mark or Waypoint .....	46
8.2	MARKS/WAYPOINTS LIST .....	47
8.3	Creating a NEW MARK with the MARKS/WAYPOINTS LIST .....	47
8.4	GOTO CURSOR .....	48
8.5	GOTO MARK .....	49
<b>9.</b>	<b>MAN OVER BOARD (MOB) FUNCTION .....</b>	<b>50</b>
9.0	DELETING A MOB POINT .....	50
<b>10.</b>	<b>ROUTES .....</b>	<b>51</b>
10.0	CREATING A ROUTE USING WAYPOINTS .....	51
10.1	MAKING ADDITIONAL ROUTES .....	52
10.2	CREATING A ROUTE USING MARKS ON THE CHART PAGE .....	52
10.3	INSERTING A WAYPOINT INTO A ROUTE .....	53
10.4	GOTO A ROUTE .....	53
10.4.0	By select Route .....	53
10.4.1	By Cursor key .....	53
10.5	OTHER SETTINGS IN ROUTE MENU .....	54
<b>11.</b>	<b>TRACKS .....</b>	<b>55</b>
11.0	TRACKING .....	55
11.0.0	Saving and starting a new Track .....	56
11.0.1	Other Settings in Track Menu .....	56
11.1	USING THE TRIP LOG .....	57
11.1.0	Resetting the Trip Log .....	57
<b>12.</b>	<b>USER C-CARD .....</b>	<b>58</b>
12.0	USER C-CARD MENU .....	58
12.0.0	Formatting the User C-CARD .....	58
12.0.1	Transferring files to the optional User C-CARD .....	59
12.0.2	Loading a file .....	59
12.0.3	Deleting a file from the User C-CARD .....	59
<b>13.</b>	<b>PAGES .....</b>	<b>60</b>
13.0	CHART PAGE .....	61
13.0.0	Window Selections .....	61
13.0.1	Additional Functions on Chart page .....	62
13.0.2	Turning Off Information on Icon Points .....	62
13.0.3	Display Mode .....	62
13.0.4	Marine Settings .....	63
13.0.5	Depth Settings .....	63
13.0.6	Land Settings .....	64
13.0.7	Chart Settings .....	64
13.0.8	Underwater Objects Settings .....	64
13.0.9	Customizing the Data Windows .....	65
13.1	CUSTOMIZING CHART SETTINGS .....	65
13.2	NAVIGATION PAGE .....	66
13.3	HIGHWAY PAGE .....	67
13.4	CELESTIAL PAGE .....	67
13.5	GPS STATUS PAGE .....	68
13.6	NMEA DISPLAY PAGE .....	68
13.7	NMEA DATA PAGE .....	69
13.8	NMEA DEPTH, WIND SPEED, TEMP AND SOG TREND PAGES .....	69
13.9	VHF DIGITAL SELECTIVE CALLING .....	70
13.9.0	Position Request .....	70

<b>14. ADVANCED SETTINGS</b> .....	<b>71</b>
14.0 NAVIGATE .....	71
14.1 COMPASS .....	72
14.2 INPUT/OUTPUT (NMEA) .....	72
14.3 ALARMS .....	72
<b>15. AIS</b> .....	<b>74</b>
15.0 AIS SYSTEM DEFINITIONS .....	74
15.1 AIS MENU .....	75
15.2 TO SET THE CHARTPLOTTER FOR RECEIVING AIS .....	75
15.3 QUICK INFO ON AIS TARGET .....	76
<b>16. C-MAP WEATHER SERVICE</b> .....	<b>77</b>
16.0 C-WEATHER SERVICE MENU .....	77
16.0.0 Download .....	77
16.0.1 Copy From User C-CARD .....	78
16.0.2 Weather Forecast .....	88
16.0.3 Real Time View .....	88
<b>17. RADIO CONTROLS AND INDICATORS</b> .....	<b>79</b>
17.0 CONTROLS AND KEYS .....	79
17.1 RECEIVER AUDIO TONE CONTROL .....	81
<b>18. BASIC RADIO OPERATION</b> .....	<b>82</b>
18.0 RECEPTION .....	82
18.1 TRANSMISSION .....	82
18.2 TRANSMIT TIME-OUT TIMER (TOT) .....	82
18.3 SIMPLEX/DUPLEX CHANNEL USE .....	82
18.4 INTERNATIONAL, USA, AND CANADA MODE .....	83
18.5 NOAA WEATHER CHANNELS .....	83
18.5.1 NOAA Weather Alert .....	83
18.5.2 NOAA Weather Alert Test .....	84
18.5.3 Customizing NOAA Weather Alert .....	84
18.6 EMERGENCY CHANNEL (CHANNEL 16 USE) .....	84
18.7 CALLING ANOTHER VESSEL (CHANNEL 16 OR 9) .....	85
18.8 MAKING TELEPHONE CALLS .....	85
18.9 OPERATING ON CHANNELS 13 AND 67 .....	86
18.10 DUAL WATCH (TO PRIORITY CHANNEL) .....	86
18.11 SCANNING .....	86
18.11.0 Selecting the Scan Type .....	86
18.11.1 Memory Scanning (M-SCAN) .....	87
18.11.2 Priority Scanning (P-SCAN) .....	87
18.11.3 Priority Channel Set .....	88
18.12 PA/FOG OPERATION .....	89
18.12.0 Operating the PA HAIL mode .....	89
18.12.1 Operating the FOG HORN mode .....	89
18.12.2 FOG ALERT TONE Frequency .....	91
18.13 INTERCOM OPERATION .....	91
18.14 VOICE SCRAMBLER .....	92
18.14.0 Setting Up the Voice Scrambler .....	92
18.14.1 Voice Scramble Operation .....	93
<b>19 DIGITAL SELECTIVE CALLING</b> .....	<b>94</b>
19.0 GENERAL .....	94
19.1 MARITIME MOBILE SERVICE IDENTITY (MMSI) .....	94
19.1.0 What is an MMSI? .....	94
19.1.1 Programming the MMSI .....	95
19.2 DSC Distress Call .....	95
19.2.0 Transmitting a DSC Distress Call .....	95
19.2.1 Receiving a DSC Distress Call .....	97
19.3 ALL SHIPS CALL .....	97
19.3.0 Transmitting an All Ships Call .....	97
19.3.1 Receiving an All Ships Call .....	98
19.4 INDIVIDUAL CALL .....	98
19.4.0 Setting up the Individual / Position Call Directory .....	98
19.4.1 Setting up Individual Reply .....	99
19.4.2 Setting up the Individual/Group Call Ringer .....	100
19.4.3 Transmitting an Individual Call .....	101
19.4.4 Receiving an Individual Call .....	102
19.5 CALL WAITING DIRECTORY .....	103

19.5.0	Enabling the Call Waiting Feature .....	103
19.5.1	Reviewing Received Calls Logged into the Call Waiting Directory .....	103
19.5.2	To Delete the Received Log from the "DSC Log" Directory .....	104
19.6	<b>GROUP CALL</b> .....	105
19.6.0	Setting up a Group Call .....	105
19.6.1	Transmitting a Group Call .....	106
19.6.2	Receiving a Group Call .....	107
19.7	<b>POSITION REQUEST</b> .....	107
19.7.0	Setting up Position Reply .....	107
19.7.1	Transmitting a Position Request to Another Vessel .....	108
19.7.2	Receiving a Position Request .....	110
19.8	<b>POSITION SEND</b> .....	110
19.8.0	Setting up a Position Send Ringer .....	110
19.8.1	Transmitting a DSC Position Send Call .....	111
19.8.2	Receiving a DSC Position Send Call .....	112
20.	<b>RADIO SETUP</b> .....	113
20.0	CHANNEL NAME CHANGE .....	113
20.1	UNIT NAME .....	114
21.	<b>ENHANCED RAM+ MIC OPERATION</b> .....	115
21.0	RAM+ MIC CONTROLS .....	115
21.1	PA/FOG OPERATION .....	116
21.1.0	Operating the PA / Hailer .....	116
21.1.1	Operating the FOG Horn .....	117
21.2	INTERCOM OPERATION .....	117
21.2.0	Communication .....	117
21.2.1	Calling .....	117
21.3	DSC/RADIO SETUP MODE .....	118
22.	<b>VH-310 HANDSET OPERATION</b> .....	119
22.0	VH-310 HANDSET CONTROLS .....	119
22.1	PA/FOG OPERATION .....	122
22.1.0	Operating the PA / Hailer .....	122
22.1.1	Operating the FOG Horn .....	122
22.2	INTERCOM OPERATION .....	111
22.2.0	Communication .....	122
22.2.1	Calling .....	123
22.3	MANUAL INPUTTING OF THE GPS LOCATION (LAT/LON) .....	123
22.4	DSC/RADIO SETUP MODE .....	124
22.4.1	Changing GPS Information to Vessel position or COG .....	125
22.4.2	External Speaker AF Selection .....	125
23.	<b>MAINTENANCE</b> .....	126
23.0	REPLACEMENT PARTS .....	126
23.1	FACTORY SERVICE .....	127
23.2	TROUBLESHOOTING .....	127
24.	<b>CHANNEL ASSIGNMENTS</b> .....	128
25.	<b>TECHNICAL TESTS</b> .....	134
25.0	SYSTEM TEST .....	134
25.0.0	RAM Menu (reset) .....	134
25.0.1	DIM Menu .....	134
25.0.2	Cartridges .....	135
25.0.3	Serial Ports .....	135
25.0.4	Modem test .....	135
26.	<b>WARRANTY</b> .....	136
26.0	MARINE PRODUCTS LIMITED WARRANTY .....	136
26.1	ON-LINE WARRANTY REGISTRATION .....	138
27.	<b>SPECIFICATIONS</b> .....	140
27.0	CPV350 SPECIFICATIONS .....	140
27.0.0	GENERAL .....	140
27.0.1	TRANSMITTER .....	140
27.0.2	RECEIVER .....	140
27.0.3	GPS CHART PLOTTER .....	140
27.1	GPS WAAS SMERT RECEIVER SPECIFICATIONS .....	141
27.1.0	PHYSICAL CHARACTERSTICS .....	141
27.1.1	ELECTRICAL CHARACTERSTICS .....	141
27.1.2	GPS PERFORMANCE .....	141
28	<b>APENDIX: TERMS</b> .....	142

---

# 1. INTRODUCTION

---

## 1.0 GENERAL INFORMATION

---

The CPV350 is a WAAS GPS chart plotter, Class D DSC 25 W VHF with a powerful 30 W loud hailer capable of listen-back, fog signaling, bells, whistles integrated one box. The CPV350 has 2 connections for CMP25 RAM+ or VH-310 telephone style handset second stations. Connect the optional FF520, and the CPV350 becomes a full function 50/200 kHz fish finder shown on the high-resolution sunlight viewable 16:9 aspect ratio Wide Screen display in a full page or a split Chart/fish screen. Rotary knobs make features easy to access along with the unique ergonomically designed handgrip for sure control. Featuring Class D Additional features include, dual watch, programmable scan, priority scan dedicated 16/9 and WX key, noise-canceling microphone with channel selection, back lit front panel keys and LCD and a optional voice scrambler.

### GPS chart plotter features include:

- 7-inch 256-Color TFT sunlight viewable LCD display (Screen Resolution: 800x480)
- 12 Channel GPS WAAS smart antenna
- Cartography: C-Map NT+, C-Map MAX capable
- Customizable display windows
- Dual frequency fish finder capable (FF520 required)
- Split screen capability
- Worldwide background map showing detail up to 2.0 NM included
- Stores 1000 user waypoints
- NMEA data pages

### Marine VHF features include:

- Commercial grade ITU Class D VHF transceiver
- Complete Digital Selective Calling (DSC).
- Full position request and send functions
- CLEAR VOICE noise reduction microphone with 16/9 key and channel selection
- Tri-station capability (RAM+ and/or VH-310 required)
- 30W loud hailer with listen back, 4 foghorns, bells, and whistles
- Oversized rotary channel selector
- Channel name capability
- Display repeats GPS information (when attached to GPS)
- User Programmable Scan, Priority Scan, and Dual Watch
- Fully adjustable backlighting and LCD contrast
- Voice scrambler (optional)



## 1.1 PACKING LIST

---

When the package containing the GPS chartplotter is first opened, please check for the following contents.

If any parts are missing contact the dealer this GPS chartplotter was purchased from. Accessories and replacement parts may be ordered from STANDARD HORIZON's Parts Department at 562/404-2700 Ext. 351 or via the web at [www.standardhorizon.com](http://www.standardhorizon.com).

### 1.1.0 Packing List

- CPV350 GPS Chart Plotter with VHF FM Marine Transceiver
- GPS WAAS Smart antenna
- Microphone
- Dust Cover
- DC Power Cable
- Accessory Cable
- Flush Mount hardware, Mounting Bracket, and mounting hardware
- Owner's Manual

## 1.2 OPTIONAL ACCESSORIES

---

### Black Box Fish Finder

FF520 - Dual Frequency Black Box Fish Finder

(500W or 1000W depending on transducer connected)

500W Transducers

DST520 - Nylon depth temp

DST521 - Transom mount depth, temp speed

DST523 - Bronze depth temp

DST525 - In-hull depth only

DST526 - Thruhull Depth, speed, temp with fairing block

1000W Transducers

DST527 - In-hull depth only

DST528 - Bronze thru-hull depth temp

### Hailing horns

220SW - 5 inch round horn (small)

240SW - 5x7 horn

### External Speakers

MLS-300 - VHF Extension speaker

MLS-310 - VHF Extension 10W amplified speaker

### Second Station Remote Microphones

CMP25 - RAM+ Microphone

VH-310 - Telephone Style Handset

CT-100 - 23-foot Extension Cable for Second Station Remote Microphone

### Scrambler

CVS2500

## **1.3 SAFETY / WARNING INFORMATION**

---

This radio is restricted to occupational use, work related operations only where the radio operator must have the knowledge to control the exposure conditions of its passengers and bystanders by maintaining the minimum separation distance of 0.6 m (2 feet). Failure to observe these restrictions will result in exceeding the FCC RF exposure limits.

### **1.3.0 VHF Marine Antenna Installation**

The antenna must be located at least 0.6 m (2 feet) away from passengers in order to comply with the FCC RF exposure requirements.

### **1.3.1 On-Line Warranty Registration**

Please visit [www.standardhorizon.com](http://www.standardhorizon.com) to register the CPV350 Marine VHF. It should be noted that visiting the Web site from time to time may be beneficial to you, as new products are released they will appear on the Marine Division of Vertex Standard Web site.

### **1.3.2 Product Support Inquiries**

If you have any questions or comments regarding the use of the CPV350, you can visit the Marine Division of Vertex Standard Web site to send an E-Mail or contact the Product Support team at 800-767-2450 M-F 7:00- 5:00PST.

## **1.4 FCC RADIO LICENSE INFORMATION**

---

Vertex Standard radios comply with the Federal Communication Commission (FCC) requirements that regulate the Maritime Radio Service.

### **1.4.0 Station License**

An FCC ship station license is no longer required for any vessel traveling in U.S. waters (except Hawaii) which is under 20 meters in length. However, any vessel required carrying a marine radio on an international voyage, carrying a HF single side band radiotelephone or marine satellite terminal is required to have a ship station license. FCC license forms, including applications for ship (506) and land station licenses can be downloaded via the Internet at [www.fcc.gov/forms](http://www.fcc.gov/forms). To obtain a form from the FCC, call (888) 225-5322.

### **1.4.1 Radio Call Sign**

Currently the FCC does not require recreational boaters to have a Ship Radio Station License. The USCG recommends the boats registration number and the state to be used.

### **1.4.2 Canadian Ship Station Licensing**

You may need a license when traveling in Canada. If you do need a license contact the nearest field office or regional office or write:

**Industry Canada  
Radio Regulatory Branch  
Attn: DOSP  
300 Slater Street  
Ottawa, Ontario  
Canada, KIA 0C8**

### **1.4.3 FCC / Industry Canada Information**

The following data pertaining to the transceiver is necessary to fill out the license application.

Type Acceptance ..... FCC Part 80  
Output Power ..... 1 Watt (low) and 25 Watts (high)  
Emission ..... 16K0G3E, 16K0G2B  
Frequency Range ..... 156.025 to 163.275 MHz  
FCC Type Number ..... K6630163X3S  
Industry Canada Type Approval ..... 511B-30163X3S

---

## 2. GETTING STARTED

---

### 2.0 MOUNTING THE GPS CHARTPLOTTER

---

The CPV350 is supplied with hardware for bracket or flush mounting. Below are pictures showing actual examples of the two types of installation.

#### 2.1 BRACKET MOUNTING

---

The CPV350 can be mounted using the supplied bracket. Before installing ensure the area the CPV350's bracket is mounted to is strong enough to support the weight of the CPV350 especially while under way.

After the location is found, attach the mounting base to the area using the supplied hardware.

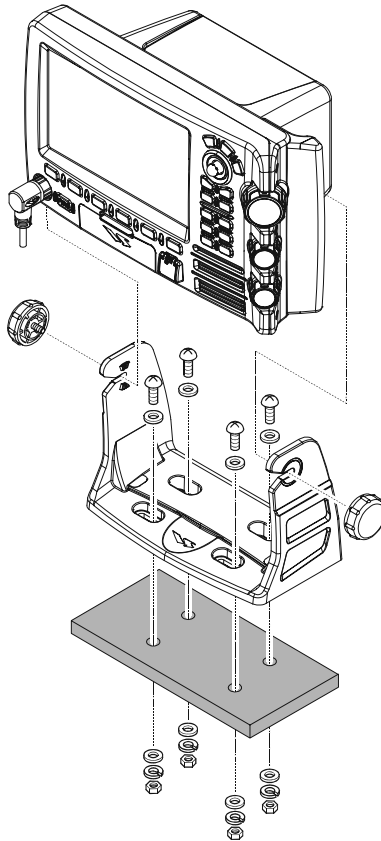

Figure 2.1 - Installing CPV350 (Bracket)

## 2.2 FLUSH MOUNTING

The CPV350 is supplied with a flush mount template for the cutout hole and screw holes required to install the CPV350.

### NOTE

Before drilling holes ensure there are no obstructions behind the location that could interfere with the mounting and there is physically enough room to mount the CPV350.

1. After a location is found, peel the template label from the backing and apply the label to the mounting area.
2. Drill a hole in one area of the cut area that will allow the blade of a jig saw to be inserted. Insert and cut out the area on the panel using the jig saw.
3. Remove the three screws affix the grip and remove the grip from the CPV350.
4. Next drill the four holes required to insert the CPV350 with the mounting studs.
5. Install the mounting studs on the CPV350 and insert into the mounting hole.
6. Attach the CPV350 to the mounting location by attaching the supplied hardware to the mounting studs.

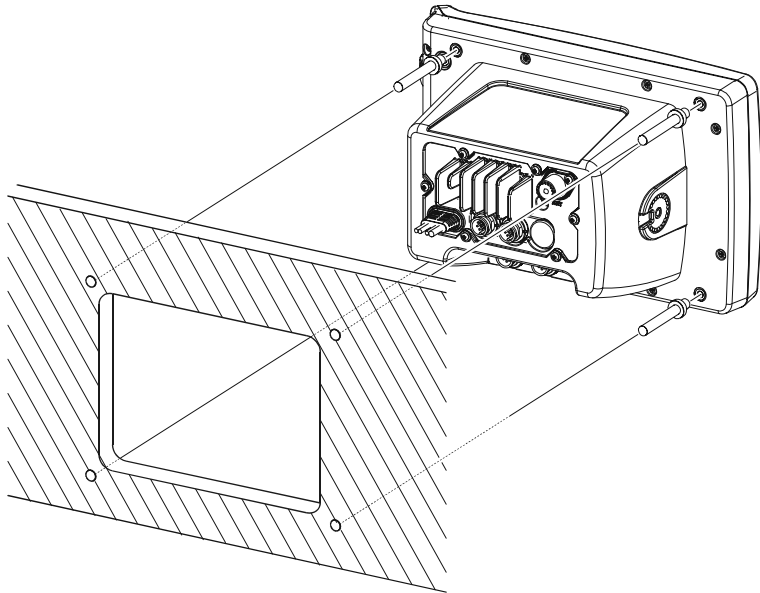

Figure 2.2 - Installing CPV350 (Flush)

## 2.3 CONNECTIONS

The CPV350 has a cable or connectors that are used to connect the CPV350 to Power Supply, to the GPS WAAS Smart antenna, optional FF520 50/200kHz BLACK BOX FISH FINDER and to NMEA devices such as VHF's, digital instruments and autopilots as shown in the image below:

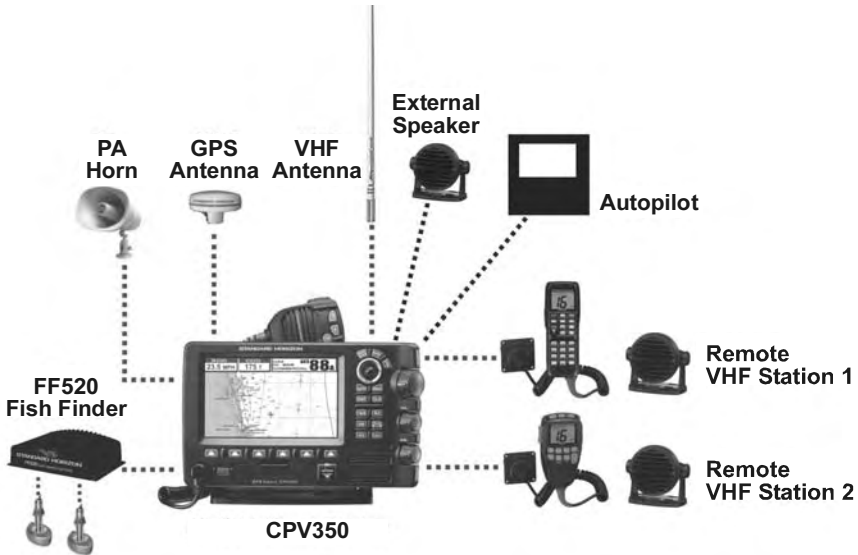

Figure 2.4 Installing the GPS WAAS Smart antenna

### 2.3.0 Rear Panel Connections

#### 1. VHF ANTENNA JACK

Connects an antenna to the transceiver. Use a marine VHF antenna with impedance of 50 ohms.

#### 2. REMOTE MIC CONNECTORS

Connects to the enhanced RAM+ MIC (Remote Access Microphone) or the VH-310 Handset.

#### 3. ACCESSORY CONNECTION

Allows connection of optional FF520 fish finder module and connections for AIS receiver and other NMEA devices.

#### 4. GPS Antenna

Connects the GPS antenna to the CPV350. Only use the GPS Smart antenna supplied with the CPV350

#### 5. External speaker

Connects to the MLS-300, MLS-310 or any 8 Ohm 6Watt external speaker

#### 6. PA Horn

Connects to 220SW, 240SW or any 4 Ohm 30W PA Speaker

#### 7. DC INPUT CABLE

Connects the radio to a DC power supply capable of delivering 12V DC.

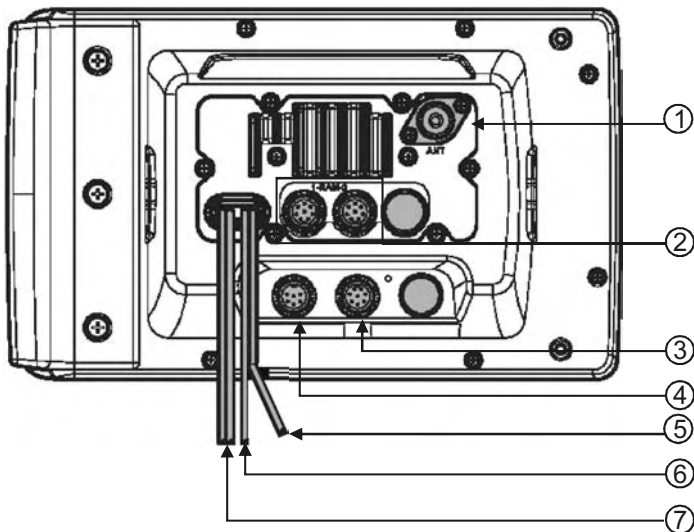

Figure 2.5 CPV350 Rear Panel

## 2.3.1 VHF Antenna

### ABOUT VHF RADIO

The radio frequencies used in the VHF marine band lie between 156 and 158 MHz with some shore stations available between 161 and 163 MHz. The marine VHF band provides communications over distances that are essentially "line of sight" (VHF signals do not travel well through objects such as buildings, hills or trees). Actual transmission range depends much more on antenna type, gain and height than on the power output of the transmitter. On a fixed mount 25W radio transmission expected distances could be greater than 15 miles.

## 2.3.2 Selecting a Marine VHF Antenna

Marine antennas are made to radiate signals equally in all horizontal directions, but not straight up. The objective of a marine antenna is to enhance the signal toward the horizon. The degree to which this is accomplished is called the antenna's gain. It is measured in decibels (dB) and is one of the major factors in choosing an antenna. In terms of effective radiated power (ERP), antennas are rated on the basis of how much gain they have over a theoretical antenna with zero gain. A 3-foot, 3dB gain antenna represents twice as much gain over the imaginary antenna. Typically a 3-foot 3dB gain stainless steel whip is used on a sailboat mast. The longer 8-foot 6dB fiberglass whip is primarily used on powerboats that require the additional gain.

### 2.3.3 Coaxial Cable

VHF antennas are connected to the transceiver by means of a coaxial cable - a shielded transmission line. Coaxial cable is specified by its diameter and construction. For runs less than 20 feet, RG-58/U, about 1/4 inch in diameter is a good choice. For runs over 20 feet but less than 50 feet, the larger RG-8X should be used for cable runs over 50 feet RG213 should be used. For installation of the connector onto the coaxial cable refer to the figure below. Figure 2.4.0 Installing the VHF antenna To get your coax cable through a fitting and into your boat's interior, you may have to cut off the end plug and reattach it later. You can do this if you follow the directions that come with the connector. Be sure to make good soldered connections.

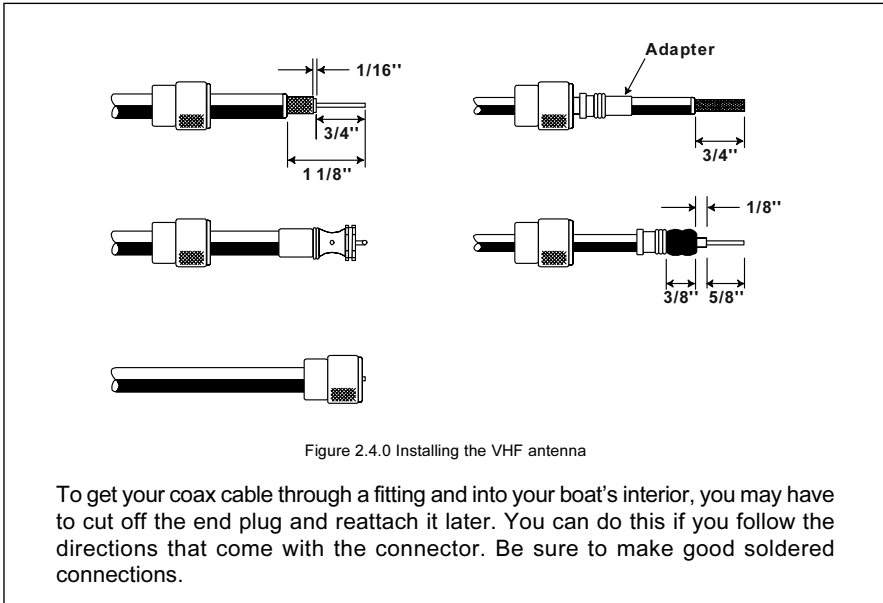

Figure 2.4.0 Installing the VHF antenna

To get your coax cable through a fitting and into your boat's interior, you may have to cut off the end plug and reattach it later. You can do this if you follow the directions that come with the connector. Be sure to make good soldered connections.



### 2.3.4 Optional Enhanced Second VHF/PA Station

#### INSTALLATION

The CPV350 is capable of using up to 2 Enhanced RAM+ mics or VH-310 Handset to remotely control the Radio, DSC, and Distress functions. In addition the CPV350 can operate as a full function intercom system.

1. Connect the Routing Cable to the one of the Remote Mic eight pin connector on the rear panel, then tighten the Cable Nut.
2. Referring to Figure 3, make a 1.2" (30 mm) hole in the wall, then insert the Routing Cable into this hole. Connect the Gasket and Mount Base to the Routing Cable Connector using the Nut.
3. Drill the four Screw holes (approx. 2 mm) on the wall then install the Mounting Base to the wall using four screws.
4. Put the Rubber Cap on to the Nut. The installation is now complete.
5. Wires for an external speaker are provided on the Routing Cable. Connect any 8 Ohm external speaker.

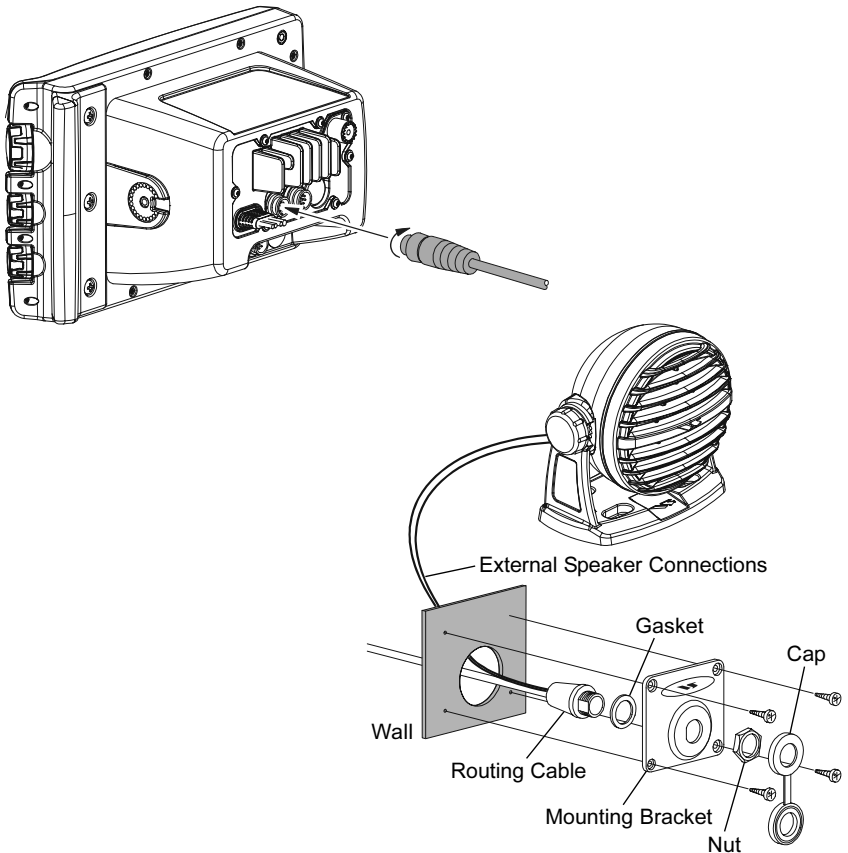

## Remote Mic or External Speaker Selection

By default the RAM+ or VH-310 Handset internal speaker is turned on, however using the RAM+ mic (or VH-310 Handset) this speaker can be turned off so the external speaker can be used.

RAM+ mic procedure

1. Press and hold the **[CALL/SET]** key.
2. Press the **[▲]** or **[▼]** key to select **RADIO SETUP**.
3. Press the **[CALL/SET]** key.
4. Press the **[▲]** key to until **EXT SPK** is shown and press the **[CALL/SET]** key.
5. Press the **[▲]** or **[▼]** key to select **oF** (External speaker off) or **on** (External speaker on).
6. Press the **[CALL/SET]** key to save the selection.
7. Press the **[16/9]** key to exit this mode.

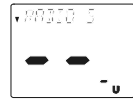

VH-310 Procedure

1. Press and hold the **[CALL(MENU)]** key.
2. Press the **[▲]** or **[▼]** key to select **RADIO SETUP**.
3. Press the **[ENT]** key
4. Press the **[▲]** key to until **EXT SPK** is shown and press the **[ENT]** key.
5. Press the **[▲]** or **[▼]** key to select **oF** (External speaker off) or **on** (External speaker on).
6. Press the **[ENT]** key to save the selection.
7. Press the **[16/9]** key to exit this mode.

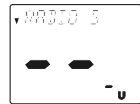

## 2.3.5 NMEA Connections

### NOTE

The CPV350 can send many sentences to external NMEA devices. The NMEA output wires are Brown and White and the NMEA Common is Green. If you have connected devices as shown in the below table and need to feed NMEA to other devices (Autopilot, Radar ....) you can parallel wires from the Brown or White wires.

Pin	Wire Color	Description	Connection Example	Additional Information
1	Black	---	No Connection	
2	Red	---	No Connection	
3	Green	NMEA Common	Common for NMEA devices	
4	Blue	NMEA Input Port 1	Connect to output of NMEA device	Default is NMEA0183
5	Brown	NMEA Output Port 1	Connect to input of NMEA device	Default is NMEA0183 with GLL, RMB, RMC, and XTE sentences
6	Gray	NMEA Input Port 2	Connect to output of NMEA device	Default is NMEA0183*
7	White	NMEA Output Port 2	Connect to input of NMEA device	Default is NMEA0183 with GLL, RMB, RMC, and XTE sentences
8	Yellow	NMEA Output Port 4	Connect autopilot	Default is NMEA0183 with APA, APB, XTE, COG, and BOD sentences

\*: When the FF520 is connected, port 2 input must be changed to "FF520." To do this, press **[MENU]** two times, move the ShuttlePoint knob to highlight **ADVANCED SETUP, IN/OUT CONNECTIONS, PORT2 INPUT, FF520.**

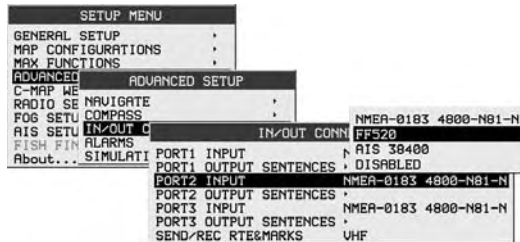

Figure 2.3.5 IN/OUT CONNECTION menu

## 2.3.6 Outputting NMEA to a Personal Computer

The CPV350 can be connected to output Marks, Routes, and tracks to many PC programs available in the aftermarket. To send or receive User Points the PC Program must be able to receive NMEA WPL and RTE sentences.

## 2.3.7 Serial PC Connection

### Outputting Waypoints and Routes

The CPV350 can be connected to output Marks, Routes and tracks to many PC programs available in the aftermarket. To send or receive User Points the PC Program must be able to receive NMEA WPL and RTE sentences.

PC DB9 Connection	CPV350 Connection
Pin 2	Brown wire
Pin 3	Blue
Pin 4	Green

### 2.3.8 Outputting GPS Coordinates

Some PC programs use NMEA sentences from a GPS to show position. The CPV350 outputs GLL, RMB and RMC.

PC DB9 Connection	CPV350 Connection
Pin 2	Brown wire
Pin 4	Green

### 2.3.9 NMEA Data Page

The NMEA Data Page is very useful to see if an External device (example: Depth Sounder) is transmitting NMEA sentences to the GPS chart plotter. This page can also be used to see if the GPS chart plotter NMEA output is being loaded down by an external NMEA device

Example:

Autopilot connected but the CPV350 but is not receiving NMEA data.  
Usually the Autopilot will be connected to the yellow wire.

To check to see if the GPS chart plotter is transmitting the Autopilot sentences:

1. Press **[MENU]**. Move the ShuttlePoint knob to highlight **NMEA DISPLAY** and press **[ENT]**.
2. Move the ShuttlePoint knob to highlight **DATA** and press **[ENT]**.
3. The **NMEA DATA** page is shown.
4. Connect the Blue Wire on the GPS chartplotter to the junction of the yellow wire and the autopilot. The display should look similar to the picture below.
5. If no data is shown press the **[ZOOM]** and move the knob on right side up to change port.

```
NMEA DATA
$LCUTG,134,T,134,M,028.0,N,051.0,K#58
$GPRGB,075438,4343.869,N,01020.692,E,1,12,99.00,-15
.0,M,49.50,M,1012#66A
$LCGLL,4343.88,N,01020.68,E#7E.0,K#58
$GPRMC,075436,A,4343.880,N,01020.677,E,028.0,134,08
0900,00,1#5F
$LCUTG,134,T,134,M,028.0,N,051.0,K#58e 4
$GPRGB,075436,4343.880,N,01020.677,E,1,12,99.00,-15
.0,M,49.50,M,1012#64
$LCGLL,4343.87,N,01020.69,E#700 ,R@RUV 0
$GPRMC,075438,A,4343.869,N,01020.692,E,028.0,134,08
0900,00,1#5D
```

## 2.4 GPS ANTENNA

### 2.4.0 Mounting the GPS WAAS Smart Antenna

The CPV350 is supplied with a 12 Channel GPS WAAS Smart antenna. This antenna is designed to be mounted on a base, installed on an extension or even flush mounted. Choose a location for the antenna that has a clear view of the sky and is not located within 3 FT of Radar or other transmitting antenna. Ensure there are no major obstructions or fixtures in the immediate proximity to the antenna. The antenna relies on direct "line of sight" satellite reception. If you are unsure of the chosen location, temporarily mount the antenna in the desired location to verify correct operation. If mounted close to Radar, and after the GPS chartplotter has a fix, turn on the Caps on RADAR to ensure the GPS chartplotter holds the fix (use the GPS Status Page).

#### 2.4.1 Mounting on a Pole

The thread used on the antenna is an industry standard (1 inch 14TPI) used on a wide range of mounting brackets. Due to the manufacturing process of these mounting brackets you may see some slop when tightening down the antenna to the bracket. This is no concern however as the antenna must be tightened until the antenna stops rotating.

#### NOTE

The antenna cable can be cut and spliced to ease installation. Care must be taken when reconnecting the antenna cable to protect from water and corrosion.

#### 2.4.2 Flush Mounting

#### NOTE

Before drilling holes, it is recommended the antenna be positioned where the location is planned to be drilled, cable connected to the CPV350 and the CPV350 turned on to ensure a GPS fix is received.

1. Remove the threaded base from the antenna dome.
2. To ease installation a flush mounting template for the antenna has been included.
3. Apply the mounting template sticker to the area that was verified for GPS reception.
4. Then, drill out the 0.63" (16 mm) and 0.16" (4 mm) holes, and remove the template.
5. Insert the cable into the 0.63" (16 mm) hole and route to the CPV350.
6. Apply a small amount of RTV to the under side of the antenna.
7. Place the antenna and then screw it into place using the screws. In some cases the screw may not be long enough, if this happens simply apply more RTV to the underside of the antenna to glue it into place.

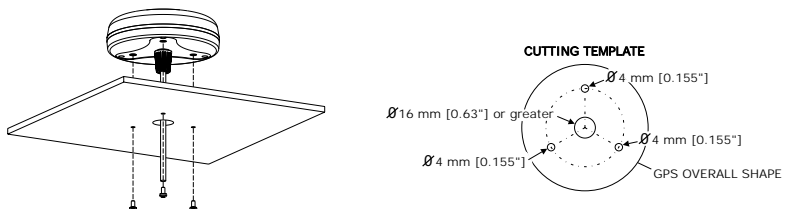

Figure 2.4.2 Installing the GPS WAAS Smart antenna

### 2.4.3 PA Horn Connections

The CPV350 can be connected to the 220SW or 240SW PA horn to hail other vessels or send FOG, bells or whistles.

### 2.5 SMART GPS CONNECTOR TABLE

Pin	Wire Color	Description	Connection Example
1	Red	Battery Positive	Connect to Battery Positive and Red wire of GPS Antenna
2	Green	Smart GPS NMEA Input	Connect to Smart GPS Input
3	Brown	Smart GPS NMEA Output	Connect to Smart GPS Output
4	NC	—	—
5	NC	—	—
6	Black/Yellow	Battery Ground	Connect to battery ground and Black wire of GPS Antenna

### 2.6 BATTERY CONNECTIONS

#### CAUTION

Reverse polarity connections will damage the radio!

1. Connect the red power wire to a 13.8 VDC  $\pm 20\%$  power source. Connect the black power wire to a negative ground.
2. If an optional remote extension speaker is to be used, refer to next section for connections.
3. It is advisable to have a Certified Marine Technician check the power output and the standing wave ratio of the antenna after installation.

## 2.7 OPTIONAL BLACK BOX FISH FINDER

STANDARD HORIZON offers an optional BLACK BOX FISH FINDER called FF520. Please refer to the Owner's Manual supplied with the Fish Finder for connections and operation.

When the FF520 is connected, port 2 input must be changed to "FF520." To do this, press **[MENU]** two times, move the ShuttlePoint knob to highlight **ADVANCED SETUP, IN/OUT CONNECTIONS, PORT2 INPUT, FF520.**

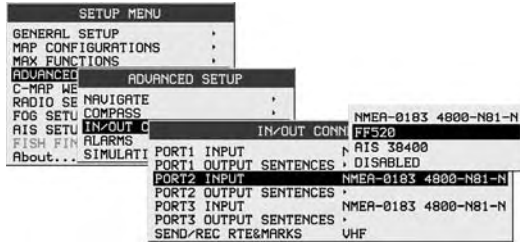
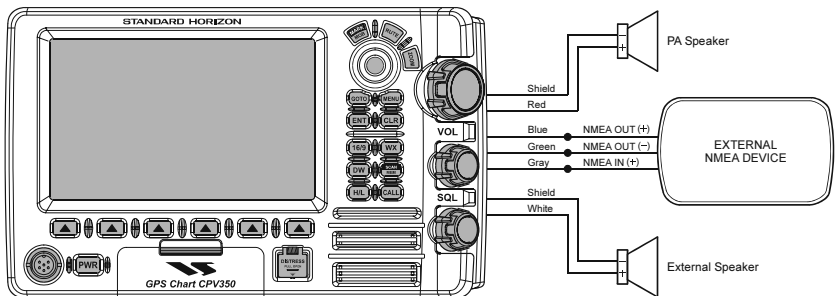

Figure 2.7 IN/OUT CONNECTION menu



## 2.8 OPTIONAL VHF EXTERNAL SPEAKER

THE CPV350 has connections for an external VHF speaker for louder audio. Use Standard Horizon MLS-300 or MLS-310 for best performance.



---

## 3. C-MAP MAX OVERVIEW

---

### 3.0 INTRODUCTION

---

C-MAP MAX is a major evolution of the NT/NT<sup>+</sup> product technology. Key points are:

#### New Data Features

- Tides and Currents (intuitive arrows show direction and strength)
- World Background Charts with terrestrial data
- Value Added Data (Pictures and Diagrams, Land Data)
- Enhanced Port Info

#### New Presentation Features

- Clear Info (sophisticated “Human Dictionary” to translate Nav-Aid abbreviations found on paper charts)
- Dynamic Nav-Aids (an innovative and dynamic presentation mode)
- Flexi-Zoom (increased Under and Over Zoom between chart levels, resulting in optimal scale display for any situation)
- Dynamic Elevation Data (optimized palettes for GPS chartplotters; includes new NOAA palette)
- Perspective View (“Real World” perspective view of the chart, updated real-time during navigation)

#### MAX and NT/NT<sup>+</sup> C-CARD coexistence

- When NT<sup>+</sup> data and MAX data cover different areas, the GPS chartplotter gets data from both charts (depending on the current position).
- When NT<sup>+</sup> data and MAX data cover the same area, the GPS chartplotter gets data only from MAX chart.

### 3.1 INSERTING THE C-CARD

---

Hold the C-CARD by the long inclined side so that you can see the C-MAP label.

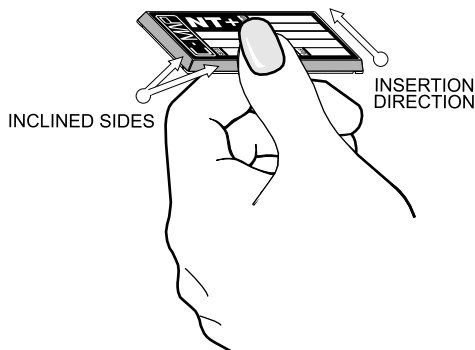

Figure 3.1 - Inserting C-CARD



Open the door, gently push the C-CARD into the slot: push the C-CARD in as far as it will go, then close the door.

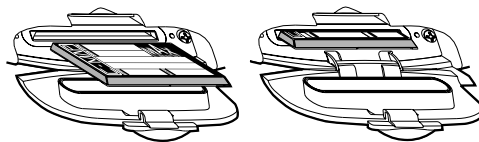

Figure 3.1a - Inserting C-CARD (Details)

---

## 4. MAP FUNCTIONS

---

### 4.0 NEW MAX FUNCTIONS MENU

---

1. Press **[MENU]** two times. Move the ShuttlePoint knob to highlight **MAX FUNCTIONS** and press **[ENT]** or move the ShuttlePoint knob to the right. The MAX Functions menu appears on the screen:

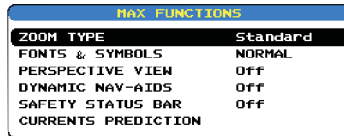

Figure 4.0 - Map Functions Menu

The available Functions are described in the following.

#### 4.0.0 Zoom Type

Allows more expansions or compression of the chart scale while zooming in or out. Zoom Mode has two options; STANDARD (default) or FLEXI-ZOOM. When in FLEXI-ZOOM mode, a short zoom push causes a change of chart, while a long zoom push causes a pop-up window to be displayed on a corner of the screen. The window shows the current Zoom factor. By pressing **[ZOOM]** and moving the knob up/down the map is expanded or compressed according to the zoom factor selected. The window is automatically closed if **[ZOOM]** is not pressed for 2 seconds and the selected zoom factor will be used at the next zoom in/out.

To activate this function follow the procedure:

1. Press **[MENU]** for two times. Move the ShuttlePoint knob to highlight **MAX FUNCTIONS** and press **[ENT]** or move the ShuttlePoint knob to the right.
2. Move the ShuttlePoint knob to highlight **ZOOM TYPE** and press **[ENT]** or move the ShuttlePoint knob to the right.
3. The menu now shows two selections, **STANDARD** or **FLEXI-ZOOM**.
4. Move the ShuttlePoint knob to select the selection and press **[ENT]**.
5. Press **[CLR]** until the menu disappears or an easier method is to move the ShuttlePoint knob to the left a few times.

#### 4.0.1 Fonts & Symbols

On MAX charts it is possible to set the size of all names and symbols drawn on the charts, selecting between Normal size (the regular characters size) and Large size.

To activate this function follow the procedure:

1. Press **[MENU]** two times. Move the ShuttlePoint knob to highlight **MAX FUNCTIONS** and press **[ENT]** or move the ShuttlePoint knob to the right.
2. Move the ShuttlePoint knob to highlight **FONTS & SYMBOLS** and press **[ENT]** or move the ShuttlePoint knob to the right.

3. The menu now shows two selections, **NORMAL** or **LARGE**.
4. Move the ShuttlePoint knob to select the selection and press **[ENT]**.
5. Press **[CLR]** until the menu disappears or an easier method is to move the ShuttlePoint knob to the left a few times.

NORMAL size

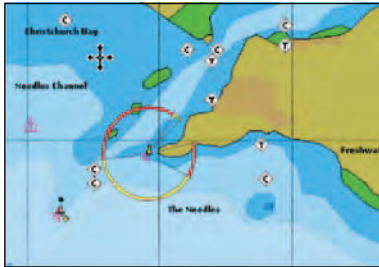

LARGE size



Figure 4.0.1 - Example of Normal size (on the left side) and Large size (on the right side) settings

## 4.0.2 Perspective View

Chart data may be projected in perspective mode during navigation. This function allows setting the panoramic View of the chart. As the upper side of the map is more compressed than the lower side, a wider map area is visible. The perspective view allows showing more chart information immediately ahead and around the cursor.



Figure 4.0.2 - Perspective View

To activate this function follow the procedure:

1. Press **[MENU]** for two times. Move the ShuttlePoint knob to highlight **MAX FUNCTIONS**

- and press **[ENT]** or move the ShuttlePoint knob to the right.
2. Move the ShuttlePoint knob to highlight **PERSPECTIVE VIEW** and press **[ENT]** or move the ShuttlePoint knob to the right.
  3. The menu now shows two selections, **ON** or **OFF**.
  4. Move the ShuttlePoint knob to select the selection and press **[ENT]**.
  5. Press **[CLR]** until the menu disappears or an easier method is to move the ShuttlePoint knob to the left until the chart page is shown.

### 4.0.3 Dynamic Nav-Aids

This function enables the blinking of lights of the Nav-Aids. The blink period and color of each Nav-Aid is read from the Nav-Aid attributes available on the data cartridge. When the ship is inside the Nav-Aid nominal range, the light of the Nav-Aid will start blinking. When Dynamic Nav-Aids option is set to On, when the flashing light is Off, or when fix position is out of the sector, the light color is displayed by using a faint light color.

To activate this function follow the procedure:

1. Press **[MENU]** two times. Move the ShuttlePoint knob to highlight **MAX FUNCTIONS** and press **[ENT]** or move the ShuttlePoint knob to the right.
2. Move the ShuttlePoint knob to highlight **DYNAMIC NAV-AIDS** and press **[ENT]** or move the ShuttlePoint knob to the right.
3. The menu now shows two selections, **ON** or **OFF**.
4. Move the ShuttlePoint knob to select the selection and press **[ENT]**.
5. Press **[CLR]** until the menu disappears or an easier method is to move the ShuttlePoint knob to the left until the chart page is shown.

### 4.0.4 Safety Status Bar (DSI - Data Safety Indicator)

When Safety Status Bar is On, a status bar with six boxes showing the status of certain functions is displayed. Any warning or alarm condition is identified by the red color to indicate possible risk.

To activate this function follow the procedure:

1. Press **[MENU]** two times. Move the ShuttlePoint knob to highlight **MAX FUNCTIONS** and press **[ENT]** or move the ShuttlePoint knob to the right.
2. Move the ShuttlePoint knob to highlight **SAFETY STATUS BAR** and press **[ENT]** or move the ShuttlePoint knob to the right.
3. The menu now shows the following selections: **ON** (Safety Status Bar is shown), **OFF** (Safety Status Bar is not shown), **ICON** (Safety Status Bar is not shown, but a Warning alarm Icon is shown on the corner of the map screen as soon as any item controlled by the DSI function returns an alarm condition. The Warning Icon remains displayed until the alarm condition persists. Placing the cursor over this Icon, a quick help message is shown next to the Icon, allowing to show the Safety Status Bar. In this case - when the Safety Status Bar is opened via Warning alarm Icon - it is allowed to obtain information about each "active" Safety Status box (the red ones): it is possible to select them by ShuttlePoint knob movement left/right, and a list of active alarms is shown underneath the selected box. By pressing **[CLR]**, the Safety Status Bar is removed from the screen)
4. Move the ShuttlePoint knob to select the selection and press **[ENT]**.
5. Press **[CLR]** until the menu disappears or an easier method is to press the ShuttlePoint knob to the left a few times.



Figure 4.0.4 - Safety Status Bar

The boxes are defined as follows:

**1 Zoom**

- ♦ Normal: when the chart is displayed at normal scale.
- ♦ U. Zoom: red when the chart is under-zoomed out more than twice normal scale, gray otherwise.
- ♦ O. Zoom: red when the chart is over-zoomed in more than twice normal scale, gray otherwise.
- ♦ Chart Lock: red when the chart is zoomed in more than twice normal scale, gray otherwise.

**NOTE**

---

U. Zoom, O. Zoom and chart lock are used with Flexi-zoom selected.

---

**2 Best Scale**

Red when a more detailed chart is available under the cursor position.

**3 Data Off**

Red when at least one of the following objects or layers is turned off (by the user): Depths/soundings; Wrecks/obstructions; Tracks/routes; Attention Areas; Nav-Aids.

**4 Declutter**

Displays red when clearing overlapping objects.

**5 Dangers**

Red when “Guardian Technology” detects one of the following objects: Land, Intertidal, Depth Area, Rocks, Obstructions, Shoreline Constructions, Fishing Facility, Wrecks, Dragged area, Diffusion area, Mooring facilities, Pingos and Production installations.

**6 Caution**

Red when “Guardian Technology” detects cautionary or restricted area.

### 4.0.5 Currents Prediction

When enabled shows the variation of the tidal arrows on the selected area at any given time.

To activate this function follow the procedure:

1. Press **[MENU]** two times. Move the ShuttlePoint knob to highlight **MAX FUNCTIONS** and press **[ENT]** or move the ShuttlePoint knob to the right.
2. Move the ShuttlePoint knob to highlight **CURRENTS PREDICTION** and press **[ENT]** or move the ShuttlePoint knob to the right.
3. A window is shown on the low-left side of the chart. Press **[SET TIME]** to set the date and time manually, and **[INCR. TIME]/[DECR. TIME]** to decrease/increase time; press **[EXIT]** to exit.

---

## 5. DATA FEATURES

---

This chapter contains the new features related to the MAX map data files (i.e.: cartography and related data).

### 5.0 PICTURES & DIAGRAMS

---

Using C-Map MAX data cards allows you to show pictures or diagrams on the chart plotter display. These *Pictures* are typically used to facilitate the identification of cartographic objects or places around the map: they can be the landscape layout nearby a harbor, the shape of a bridge or of a buoy etc.

On some objects, such as bridges, the image associated can represent the *Diagram* representing the shape of the objects and the various characteristics (length, height, type of bridge etc.).

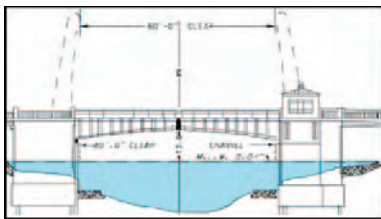



Figure 5.0 - Pictures and Diagrams

The pictures or diagrams can be a MULTIMEDIA OBJECT or they can be associated to a generic cartographic object, like a port marina.

## 5.0.0 How to show the pictures or diagrams of a Multimedia Object

They are shown on the chart page with the camera icon 

Move the cursor over the camera icon. You will get the quick info on the object and there will be the camera icon on the top bar of the window:

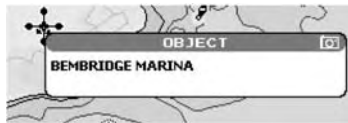

Figure 5.0.0a - Example of Quick Info on MULTIMEDIA object

Press **[IMAGE]** for 1 second to display the image on the screen or press **[EXPAND]** to open the Full info on the object:

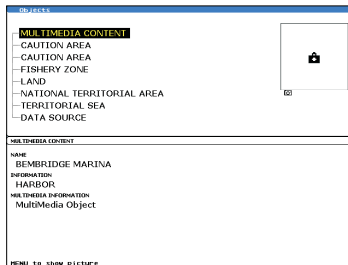

Figure 5.0.0b - Example of Full Info on MULTIMEDIA object

On the Full Info, there will be the small camera icon on a corner of the square containing the object icon.

To see the picture press **[MENU]** when the object with a picture is highlighted.

When the picture is shown, it is possible to fit it to screen by pressing **[ENT]**.

When the picture is shown, it is possible to change the contrast by pressing **[ZOOM]** and moving the knob.

When the picture is shown, it is possible to display the next picture associated, if any, by pressing the ShuttlePoint knob left or right.

## 5.1 ENHANCED PORT INFO

MAX charts include additional port services that were not present before. Additional attributes of Port Areas and Port Marinas have been included (Location, Country, Region, State, Harbor master telephone number etc.).

---

## 6. CONTROLS AND INDICATORS

---

### LEGEND

**[MENU]** If you see brackets around a bold and capital letter word this refers to a key press.

**[CHART]** If you see brackets around a bold and small capital letter word this refers to a Soft Key press. When a word(s) is bold capital letters and underlined, this refers to a menu selection item.

---

### 6.0 CONTROLS AND CONNECTIONS

---

The GPS Chart plotter, VHF radio, PA and optional FF520 fish finder are controlled using the keys located on the front panel. These labeled keys are dedicated to specific functions. As you press a key, a single audio beep confirms the key action; every time a key press is not valid, three rapid beeps sound to indicate that the key action is not valid. There is also a ShuttlePoint knob to move the cursor across the screen.

#### The ZOOM key

Pressing this key enables or disables the chart plotter zoom function or VHF channel selection.

Press the **[ZOOM]** key and a zoom icon will appear on the top left of the display as shown below. When this icon is shown the zoom function is enabled and the channel selector knob is used to change the zoom levels. When the icon is not shown turning the knob changes the VHF channels.

To zoom in rotate the channel selector knob Clockwise (up) or to zoom out rotate the channel knob counter clockwise (down). When finished zooming press the **[ZOOM]** key. Rotating the channel knob.

### NOTE

The GPS chartplotter contains a Worldwide background that allows you to zoom into 2 NM. For more detail, a C-MAP NT\*/MAX C-CARD must be purchased and installed.

---

#### The ShuttlePoint knob

The ShuttlePoint knob moves the cursor about on the display screen, quickly and accurately. It also scrolls the desired option in the menu page(s). It allows to exit from Home mode to Cursor mode. when the setup menu is selected, moving the knob to the right selects the desired option, as **[ENT]**, moving it to the left exits from menu, as **[CLR]**. For a detailed explanation of Cursor VS Home mode refer to section 6.1.1.

#### The ENT key

Press **[ENT]** to select the desired option or to confirm selection.

#### The CLR key

Press **[CLR]** to set Home mode. Also press **[CLR]** to exit from menu or data windows or to leave a menu without making changes, to abort selected function or to step backward from a selection made in the menu.

#### The MENU key

Pressing **[MENU]** one time selects the Main Menu. While the Main Menu is shown, move the ShuttlePoint knob up or down or left or right to highlight a selection. Press the **[ENTER]** to choose the selection.

Pressing **[MENU]** two times selects the Setup Menu.



Press and hold the **[MENU]** key for about 3 seconds allows the fields in the data windows to be customized on the Chart, Navigation, Highway, GPS Status or NMEA display pages.

### The GOTO key

This key is very useful when you desire to start navigating (goto) to a destination point. When pressed shows a popup window that allows you to select to start navigating to the position of the cursor, Mark or Route.

### The MARK/MOB key

Pressing **[MARK/MOB]** and immediately releasing places Mark under the ship's position when in Home Mode (in Cursor Mode under the cursor).

Press and holding **[MARK/MOB]** for about 3 seconds automatically places a MOB on the Chart page and all navigation is towards the position of the MOB Mark.

### The RTE key

When pressed places a Waypoint. Succeeding presses place more Waypoints to form a Route.

### The PWR key and Lamp/Contrast

Press and hold **[PWR]** to turn the GPS chartplotter On or Off. When the CPV350 is on, press the **[PWR]** key to shown the contrast and Lamp popup window. Move the ShuttlePoint knob left/right to adjust the backlight and up/down to adjust contrast.

### The Soft Keys

The 6 keys in the bottom part of the front panel (hereinafter named Soft Keys) have different functions associated depending on the page selected: their labels are shown on the screen immediately above the keys (the user can customize the function associated).

These keys allow quick selection to the many pages the GPS chartplotter has. These keys can be customized to your preference, however from the factory the keys are preprogrammed with the following pages. From left to right CHART, NAV, HIGHWAY, CELESTIAL, NMEA DISPLAY, LIST. Press any of the keys and you will see popup windows above the keys. To goto a specific page press the key with the desired popup window. The popup windows will automatically disappear if a key is not pressed or can be removed by pressing **[CLR]**.

## 6.1 GETTING STARTED

---

The Getting Started section will take you through the frequently used operations and assist you to customize the look of the GPS chartplotter.

Legend:

**[MENU]** If you see brackets around a bold and capital letter word this refers to a key press.

**[CHART]** If you see brackets around a bold and small capital letter word this refers to a Soft Key press.

**GENERAL SETUP** When a word(s) is bold capital letters and underlined, this refers to a menu selection item.

### 6.1.0 Power On, Off and ShuttlePoint knob operation

1. Press and hold **[PWR]** until the display shows the start-up page. To turn off, press and hold **[PWR]** until the display turns off.
2. When the power is first turned on two pages (the start-up page, see the following picture, and the Caution page) are briefly shown before the GPS Status page.



Figure 6.1.0 - Start-Up page

- When the GPS chartplotter is first turned on it will take some time for the GPS to acquire a fix of your position. Look closely at the GPS Status page and you will see satellites and relative signal strengths. After a fix is received the GPS chartplotter will automatically switch to the Chart page with a ships icon centered on the screen.

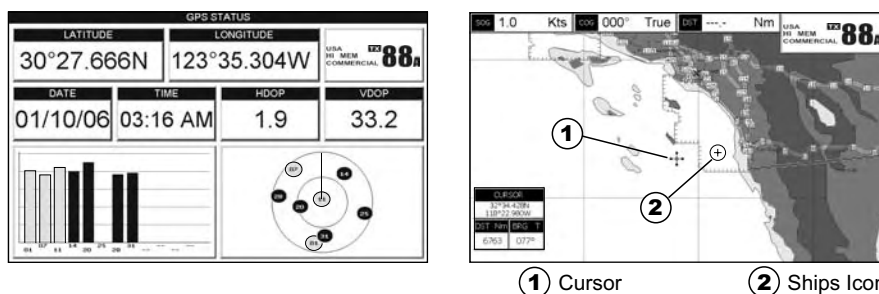

Figure 6.1.0a - GPS Status and Chart pages

- On the Chart page the ShuttlePoint knob is used to pan around the chart. Move the ShuttlePoint knob to the left and you will notice a cross hair  $\oplus$  appears, this is called the cursor.
- When you move the ShuttlePoint knob you will notice DST and BRG values in the Data window change. This shows the Distance and Bearing from the GPS Fix of your vessel to the position of the Cursor.
- If the cursor is moved to the edge of the screen the GPS chartplotter will automatically pan in the desired direction.

## 6.1.1 Cursor Vs. Home Mode

### Cursor Mode

When the  $\oplus$  cursor is shown on the Chart page, this is called Cursor mode.

In Cursor mode the position of the vessel will not stay in the center of the page and will move right off the edge of the screen (as your boat moves) Cursor mode allows you to pan around and look at areas on the map. In this mode you can also measure distance and bearings from your current position.

#### NOTE

To change from Cursor mode to Home mode press [CLR].

### Home mode

When the  $\oplus$  ships icon is only shown on the Chart page (cursor is not shown) you are in

Home mode. Now as the ship moves through the water the vessels position will be kept in the center of the display.

### 6.1.2 Cursor and Menu selection speed

The GPS chartplotter allows you to control the speed the Cursor moves when the ShuttlePoint knob is pressed. To change the speed:

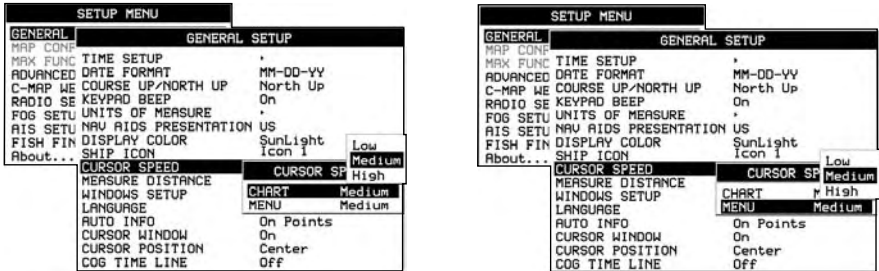

Figure 6.1.2 - Cursor Speed menu

1. Press **[MENU]** two times. Move the ShuttlePoint knob to highlight **GENERAL SETUP** and press **[ENT]** or move the ShuttlePoint knob to the right.
2. Move the ShuttlePoint knob to highlight **CURSOR SPEED** and press **[ENT]** or move the ShuttlePoint knob to the right.
3. The menu now shows two selections, CHART and MENU which allows the Cursor Speed to be selected to High, Medium or Low on Chart page or within the menus.
4. With **CHART** or **MENU** selected, press **[ENT]** or move the ShuttlePoint knob to the right. Move the ShuttlePoint knob to the desired setting and press **[ENT]** or move the ShuttlePoint knob to the right.
5. Press **[CLR]** until the menu disappears or an easier method is to press the ShuttlePoint knob to the left a few times.
6. Move the cursor on the Chart page and see if the speed is to your liking.

### 6.1.3 Changing the Ships Icon

The cursor may be changed to any of the following:

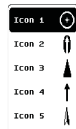

Figure 6.1.3 - Ship icons

1. Press **[MENU]** two times. Move the ShuttlePoint knob to highlight **GENERAL SETUP** and press **[ENT]** or move the ShuttlePoint knob to the right.
2. Move the ShuttlePoint knob to highlight **SHIP ICON** and press **[ENT]** or move the ShuttlePoint knob to the right to show the popup window with ship icons.
3. Move the ShuttlePoint knob to select the desired icon and press **[ENT]** or move the ShuttlePoint knob to the right to select a new icon.
4. Press **[CLR]** or move the ShuttlePoint knob to the left to exit the menu and show the Chart page.

## 6.1.4 Changing the backlight and contrast

With the GPS chartplotter turned On, briefly press [PWR] to show the light and contrast popup window. Move the ShuttlePoint knob to the left or right to adjust the LCD backlight intensity or up or down to change the LCD contrast. Press [ENT] to set.

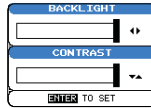

Figure 6.1.4 - Backlight and Contrast adjustment

## 6.1.5 Selecting North Up or Course Up

You may select the Chart page between **NORTH UP** and **COURSE UP** which the top of the Chart page oriented so it will always show the area ahead of the direction your vessel is traveling.

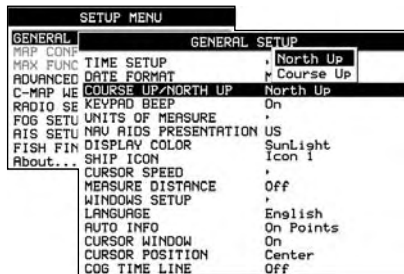

Figure 6.1.5 - Course Up/North Up menu

1. Press [MENU] two times. Move the ShuttlePoint knob to highlight **GENERAL SETUP** and press [ENT] or move the ShuttlePoint knob to the right.
2. Move the ShuttlePoint knob to highlight **COURSE UP/NORTH UP** and press [ENT] or move the ShuttlePoint knob to the right.
3. Another popup window will be shown with **NORTH UP** and **COURSE UP**, move the ShuttlePoint knob to the desired selection and press [ENT] or move the ShuttlePoint knob to the right.
4. Press [CLR] or move the ShuttlePoint knob to the left to exit the menu and show the Chart page.

### NOTE

When the GPS chartplotter is in COURSE UP mode a small arrow icon (↖) will be shown on the Chart page indicating the direction of North.

## 6.2 ADJUSTING THE TIME

The time information supplied by the GPS satellites is in Universal Time Coordinates (UTC or Greenwich England Mean Time). To change the GPS chartplotter to read the correct time, first you must figure out the offset and if it is daylight savings time. For example on the West coast of the United States or Pacific Standard Time the offset needed would be  $-08:00$  or  $-07:00$  for daylight savings time, Eastern Standard Time  $-05:00$  or  $-04:00$  for daylight savings time.

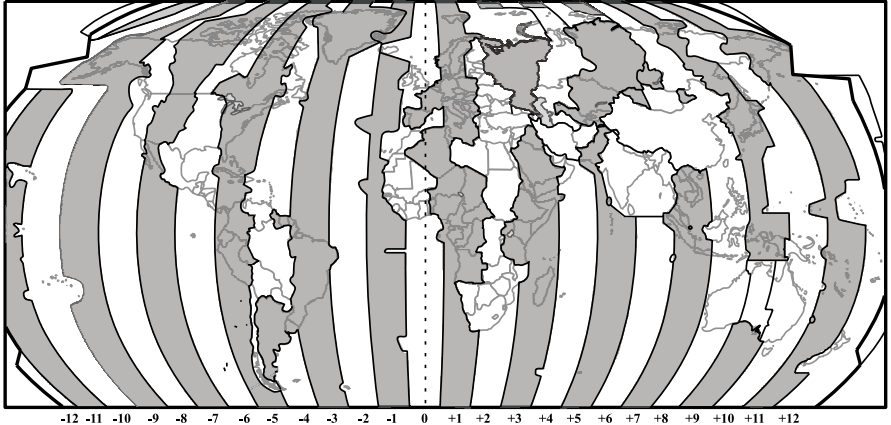

Figure 6.2 - Adjusting Time

### NOTE

This map shows offset for standard time. For daylight saving time, subtract one hour from the offset time.



Figure 6.2a - Time Setup menu

1. Press **[MENU]** two times. Move the ShuttlePoint knob to highlight **GENERAL SETUP** and press **[ENT]** or move the ShuttlePoint knob to the right.
2. Move the ShuttlePoint knob to highlight **TIME SETUP** and press **[ENT]** or move the ShuttlePoint knob to the right.
3. Move the ShuttlePoint knob to highlight **GPS TIME OFFSET** and press **[ENT]** or move the ShuttlePoint knob to the right.
4. Move the ShuttlePoint knob down to select **+00:00**, press **[ENT]** and move the ShuttlePoint knob to the right to edit the number.
5. Look at the table and find the offset for your area. You will need to enter this offset to make the GPS chartplotter shows the correct time.

6. Move the ShuttlePoint knob to the "+". Move the ShuttlePoint knob up or down to change to the desired offset.
7. Next move the ShuttlePoint knob to the right to select Hours and move the ShuttlePoint knob up or down to change the hour.
8. Repeat this method to change the minutes, if necessary.
9. Once you have the correct GPS time offset, press [ENT] to set.

### 6.3 SELECTING LORAN TD OR OTHER COORDINATE SYSTEM

The GPS Fix coordinates can be changed to show Latitude/Longitude, Loran TD's or UTM. Below is the window that will appear when customizing the Coordinate System.

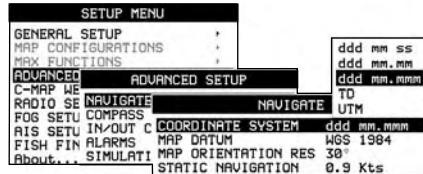

Figure 6.3 - Coordinate System menu

1. Press [MENU] two times. Move the ShuttlePoint knob to highlight **ADVANCED SETUP** and press [ENT] or move the ShuttlePoint knob to the right.
2. Move the ShuttlePoint knob to highlight **NAVIGATE** and press [ENT] or move the ShuttlePoint knob to the right.
3. Move the ShuttlePoint knob to highlight **COORDINATE SYSTEM** and press [ENT] or move the ShuttlePoint knob to the right.
4. Move the ShuttlePoint knob to highlight the desired coordinate type and press [ENT] or move the ShuttlePoint knob to the right.
5. Press [CLR] or move the ShuttlePoint knob to the left until the Chart page is shown.

#### NOTE

If the TD is selected, you should set the Chain, Pair, ASF1, ASF2 and Alter. If the TD numbers are not correct the Pair letters may be backwards. Reversing the two letters usually solves this issue. Example Y/Z change to Z/Y.

## 6.4 CHANGING THE CHART COLOR

The GPS chartplotter has preprogrammed settings allowing you to customize the look of the Chart page. The default is "Sunlight" however there are other settings: Normal, Classic, NOAA and Night. Night is very useful during evening hours so not to impair night vision.

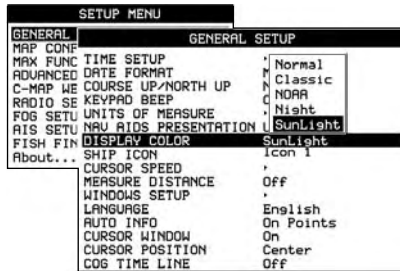

Figure 6.4 - Display Color menu

1. Press **[MENU]** two times. Move the ShuttlePoint knob to highlight **GENERAL SETUP** and press **[ENT]** or move the ShuttlePoint knob to the right.
2. Move the ShuttlePoint knob to highlight **DISPLAY COLOR** and press **[ENT]** or move the ShuttlePoint knob to the right.
3. A popup window will be shown with Normal, Classic, NOAA, Night and Sunlight. Move the ShuttlePoint knob to the desired selection and press **[ENT]** or move the ShuttlePoint knob to the right.
4. Press **[CLR]** or move the ShuttlePoint knob to the left to exit the menu and show the Chart page.

## 6.5 SELECTING PAGES USING SOFT KEYS

The Soft Keys located under the LCD are used to select the pages quickly without the need to go into the menu. The default pages are CHART, NAV, HIGHWAY, CELESTIAL, NMEA DISPLAY and LIST.

When one of the Soft Keys is pressed popup windows above each Soft Key are shown with the key description. Press the Soft Key with the desired page description and the GPS chartplotter will change to that page.

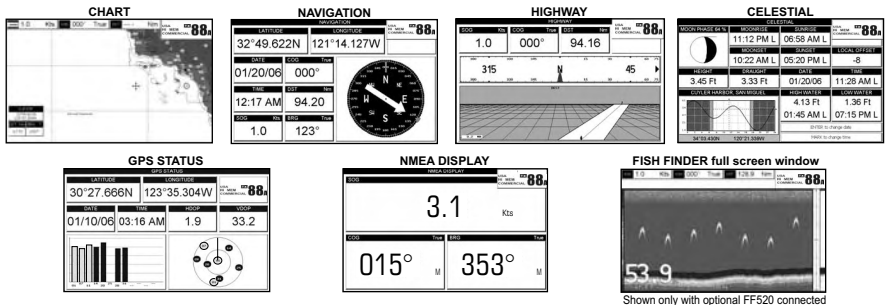

Figure 6.5 - Screen display pages

## 6.6 CUSTOMIZING THE SOFT KEYS

The Soft Keys can be individually customized from the default pages (discussed above) to the following: CHART, CHART/COMPASS, CHART/HIGHWAY, NAVIGATION, HIGHWAY, CELESTIAL, GPS STATUS, DSC LOG\*, DSC DIRECTORY\*, NMEA DISPLAY, NMEA DATA, DEPTH TREND, WIND SPEED TREND, TEMP TREND, SOG TREND, MARKS/WAYPOINTS and USER C-CARD.

When the Optional FF520 50/200kHz BLACK BOX FISH FINDER is connected, any Soft Key can be customized to show 50 or 200kHz full page, 50 or 200kHz Chart/Fish split screen and zoom screens.

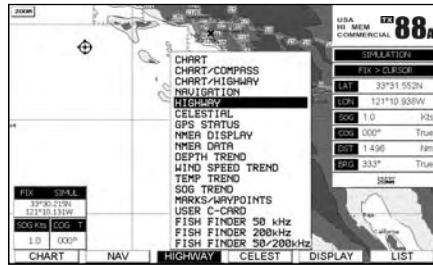

Figure 6.6 - Window options of the selected Soft Key

1. To change, momentarily press any of the Soft Keys, then press and hold the Soft Key you want to customize.
2. A popup window will be shown with the above settings.
3. Move the ShuttlePoint knob up or down to select the desired page.
4. Press [ENT] or move the ShuttlePoint knob to the right to save the page to the selected Soft Key.

## 6.7 OTHER SETTINGS IN GENERAL SETUP MENU

You will notice the **GENERAL SETUP** menu has other selections that allow you to customize:

<b>TIME SETUP</b>	Selects a submenu to allow the time setup. It is possible to set the GPS Time Offset, choosing the UTC or Local Time display, and the Time Format, switching 12 or 24 hours time format.
<b>DATE FORMAT</b>	Allows choosing date format MM-DD-YY or DD-MM-YY.
<b>COURSE UP/NORTH UP</b>	Selections are: North Up : The Top of the page is fixed to North Course Up : The top of the page is orientated to the direction the vessel is heading.
<b>KEYPAD BEEP</b>	Allows the beep produced when a key is pressed to be turned on or off.
<b>UNITS OF MEASURE</b>	Units of Measure can be selected for Distance, Speed, Depth, Altitude and Temperature.
<b>NAV AIDS PRESENTATION</b>	Allows the Nav Aids presentation to drawn using NOAA symbology when US is selected or International symbols will be used when International is selected. When selected these functions affects how the icons for Lights, Signals, Buoys and beacons are displayed.
<b>DISPLAY COLOR</b>	Changes the background colors of the chart page to enhance the visibility of the screen depending on the surrounding light conditions. <b>Normal</b> is recommended when the GPS chartplotter is not exposed to the direct sunlight. When this mode is set the maps are displayed in order to use colors as similar as possible to ones used in the original paper charts. <b>Classic</b> uses vivid chart colors presentation. <b>NOAA</b> allows setting NOAA paper chart colors presentation. <b>Night</b> is recommended when the environment is dark in order to reduce the glare of the display. The GPS chartplotter displays maps and screen in darker colors. <b>Sunlight</b> (default) is designed to enhance the visibility of the screen when the GPS chartplotter is exposed to sunlight. The maps are much brighter than in the other



modes and the depth areas are filled with the white color so different depth areas not easily distinguishable.

<b>SHIP ICON</b>	Allows selection of one of 5 choices of ship icons that represent your vessels position shown on the chart page.
<b>CURSOR SPEED</b>	Selects the preferred speed among Low, Medium and High for the cursor in the Chart page and within the menu.
<b>MEASURE DISTANCE</b>	When this function is turned on allows a distance to be measured between two points using the ShuttlePoint knob and <b>[ENTER]</b> key
<b>WINDOWS SETUP</b>	This menu selection allows the data windows to be customized on the Chart and Navigation pages.
<b>LANGUAGE</b>	Allows changing the language for menus and data screens.
<b>AUTO INFO</b>	By default when the cursor is moved over a buoy, Mark or other item a popup window will show information of the item. This menu item allows the window to be turned on or off.
<b>CURSOR WINDOW</b>	By default when the cursor is moved a window is shown with the Lat/Lon Distance and bearing from the vessels location to the cursor. This selection allows the window to be turned off.
<b>CURSOR POSITION</b>	The position of the cursor (vessels location) can be customized so it centered in the middle or centered on the bottom of the chart page. The default is "Bottom".
<b>COG TIME LINE</b>	Is a line projected from the vessel icon which indicates the distance your vessel will travel at the current speed. Selections are 2, 10, 30 minutes, 1, 2 hours and infinite.

## 6.8 INFORMATION PAGE

From Setup Menu page it is possible to select an Information page containing Software, Chart and Optional devices information.

- ① Software System Information
- ② Cartography Information
- ③ Storage Capacity

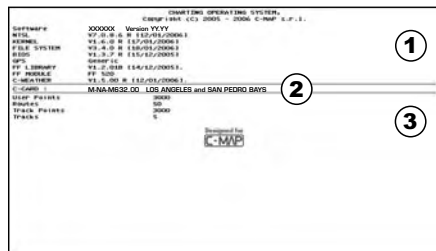

Figure 6.8 - Information page

1. Press **[MENU]** two times. Move the ShuttlePoint knob to highlight **About...** and press **[ENT]** or move the ShuttlePoint knob to the right.
2. The Information page appears on the screen (see the previous Figure).
3. Press **[CLR]** or move the ShuttlePoint knob to the left to exit and show the Chart page.

# 7. USING FIND SERVICES & MORE FUNCTION

With a C-MAP NT+/MAX C-CARD installed the GPS chartplotter allows you to search for a Port Service, Port, Tide Stations, Wrecks, Obstructions, POIs, Lakes, User Points, or GPS Coordinates.

## 7.0 PORT SERVICES

1. Press **[MENU]**. Move the ShuttlePoint knob to highlight **FIND SERVICES** and press **[ENT]**.
2. Move the ShuttlePoint knob to highlight **PORT SERVICE** and press **[ENT]** or move the ShuttlePoint knob to the right.
3. A popup window will be shown with the Port Services.
4. Move the ShuttlePoint knob to highlight the desired Service and press **[ENT]**.
5. Another popup window will show the name, distance and position of the Services closest to your location.
6. Using the ShuttlePoint knob, highlight the desired Service and press **[ENT]** which will show the name and phone number of the Service.
7. Press **[CLR]** which will show the available Services at the location.
8. Press **[CLR]** to show the actual position of the Services.

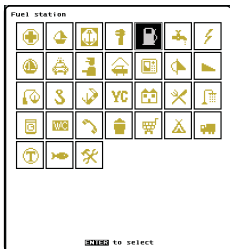

A screenshot of a list of port services. The table has three columns: NAME, DIST, and BRG. The 'DIST' column is highlighted. The services listed include 'NORTHERN LAKE WORTH COVEY', 'SMITHSON G LANDING MARINA', 'PORTER SERVICE', 'STANFORD POINT YACHT CLUB', 'TITUSVILLE YACHT CLUB', 'TITUSVILLE MUNICIPAL MARINA', 'TITUSVILLE YACHT BOATIN', 'MULTI-USE MARINE', 'PINEIDA', 'SUN MARINE MARINA', 'PALM SANDS', 'DUNEDUN 99 MARINA', 'CONVENTAL MARINE CANAL', 'HARDENPORT MARINA', 'MARINE CANAL', 'HARBOR SQUARE MARINA', and 'MARINE CANAL'. The 'DIST' values range from 120.69 to 121.74.

NAME	DIST	BRG
NORTHERN LAKE WORTH COVEY	120.69	117
SMITHSON G LANDING MARINA	120.69	117
PORTER SERVICE	120.69	117
STANFORD POINT YACHT CLUB	121.00	67
TITUSVILLE YACHT CLUB	121.30	67
TITUSVILLE MUNICIPAL MARINA	121.30	67
TITUSVILLE YACHT BOATIN	121.30	67
MULTI-USE MARINE	121.64	79
PINEIDA	121.64	79
SUN MARINE MARINA	121.64	79
PALM SANDS	121.64	79
DUNEDUN 99 MARINA	121.64	79
CONVENTAL MARINE CANAL	121.99	74
HARDENPORT MARINA	122.00	74
MARINE CANAL	122.00	74
HARBOR SQUARE MARINA	122.00	74
MARINE CANAL	122.00	74
TIMBLEY'S MARINA & RV PARK	122.00	74

Figure 7.0 - Port Services

## 7.1 OTHER AVAILABLE SEARCHES

<b>PORT BY NAME</b>	Searches and shows on the Chart page the list of all ports stored on the C-CARD in alphabetic order
<b>PORT BY DISTANCE</b>	Searches and shows the list of all ports stored on the C-CARD in distance order
<b>TIDE STATIONS</b>	Searches for the closest Tide Station and shows the information of the tide station
<b>WRECKS</b>	Searches and shows on the Chart page for the closest Wrecks
<b>OBSTRUCTIONS</b>	Searches and shows on the Chart page for the closest Obstructions
<b>USER POINTS</b>	Searches and shows on the Chart page for the closest User Points (Marks or Waypoints)
<b>COORDINATES</b>	Searches and shows on the Chart page for GPS Coordinates
<b>POIs</b>	Searches and shows information on the selected Point Of Interest
<b>LAKES</b>	Searches and shows information on the selected Lake
<b>INFORMATION</b>	Searches and shows information on the selected point

## 7.2 INFO ON LAKES (WITH OPTIONAL C-MAP LAKES CARTOGRAPHY)

### 7.2.0 Quick Info On Lakes

Upon viewing the chart of a lake, you will click on to query the available information immediately displayed with many details. For example, see the following picture:

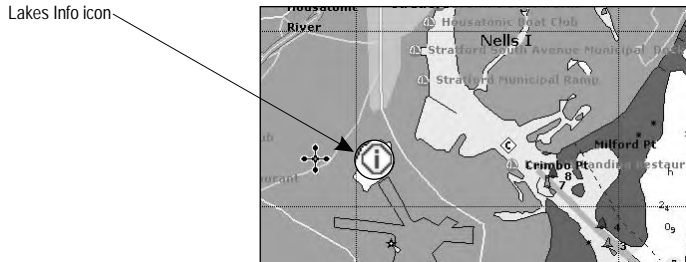

Figure 7.2.0 - Example of Lakes info

When the cursor is placed over the icon, the icons of the available services are shown:

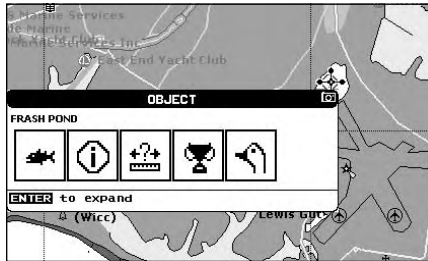

Figure 7.2.0a - Quick Info: available services

If you press [ENT] all available information about the cartographic point under the cursor will be shown. See the next paragraph.

### 7.2.1 Full Info On Lakes

The following is an example of Full Info on Lakes:

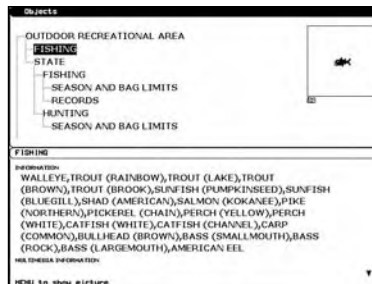

Figure 7.2.1 - Example of Full Info page

To see the "Fishing" object press **[MENU]** (when the "Fishing" object is highlighted). On the screen appears:

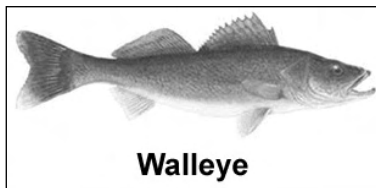

Figure 7.2.1a - Example of picture associated to the Fishing object

## 8. CREATING MARKS

### MARK

Can be a stand alone position or be linked to a Route. A Mark is placed on the Chart page using **[MARK/MOB]** or by entering in information in the **Mark/Wpt List NEW MARK** selection.

### WAYPOINTS

Always linked to a Route. Are placed on the Chart page using **[RTE]**.

#### NOTE

The difference between a Mark and a Waypoint is

- When a Route is created using WAYPOINTS and the ROUTE is deleted the WAYPOINTS are also deleted.
- If a Route is created using MARKS and the ROUTE is deleted the MARKS remain.

### 8.0 CREATING A NEW MARK USING THE CHART PAGE

- Move the ShuttlePoint knob to the desired or approx. Lat/Lon and press **[MARK/MOB]**.
- You will notice a Mark is placed under the location of the Cursor and a popup window is shown with the exact Lat/Lon of the Mark.
- If the position is incorrect press **[EDIT]** that will allow you to change the position, Mark name, icon type and color of the icon.

① Mark placed under Cursor

② Lat/Lon of Mark, DST/BRG from vessel location

③ Press Soft Key to show the Marks/Waypoint List, to edit, to move or to delete Mark

④ Vessel location

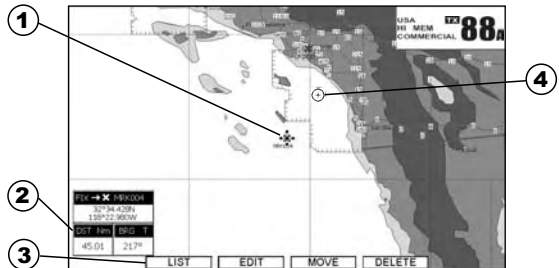

Figure 8.0 - Mark creation

### 8.1 EDITING A MARK

If a Mark has previously been created and you wish to Edit it, move Cursor over the top of the Mark.



Figure 8.1 - Mark editing

- After a Mark is created, press **[EDIT]** to show the edit popup window.
- Use the ShuttlePoint knob to change to the desired Mark Icon, when finished press **[ENT]**.
- Move the ShuttlePoint knob to the right to select the Mark Name. Press **[ENT]** on the

first digit in the name will be highlighted.

4. Move the ShuttlePoint knob up or down to select the first character.
5. Move the ShuttlePoint knob to the right to select the next character.
6. Repeat steps 4 and 5 until the Mark name is shown. Press **[ENT]**.
7. Move the ShuttlePoint knob to the right and press **[ENT]** to change the Mark Icon's Color.
8. Move the ShuttlePoint knob to up/down, left/right to select the Mark Icon's Color. When finished press **[ENT]**.
9. Move the ShuttlePoint knob to the right to select the Lat/Lon and press **[ENT]**.
10. Move the ShuttlePoint knob up or down to select the first character.
11. Move the ShuttlePoint knob to the right to select the next character.
12. Repeat steps 10 and 11 until the desired position is shown. Press **[ENT]** and **[CLR]** to store the Mark.

## 8.1.0 Deleting a Mark or Waypoint

Move the cursor over the Mark or Waypoint to delete. Press **[DELETE]**. A Warning popup window will be shown. Select **YES** and press **[ENT]**.

### 8.1.1 Moving a Mark or Waypoint

Place the cursor over the Mark or Waypoint which you want to move. Press **[Move]**. Use the ShuttlePoint knob to move the cursor. A dotted line, connecting the previous Waypoint position to the new position, is shown:

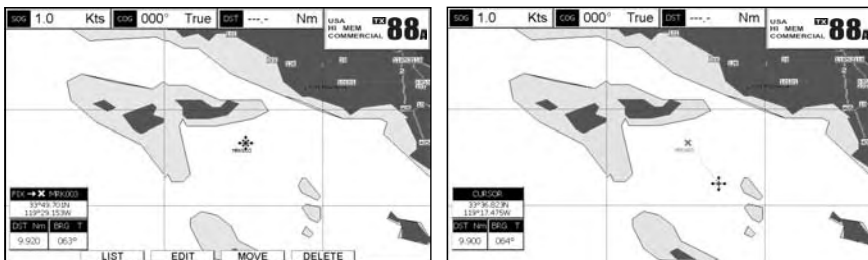

Figure 8.1.1 - Moving Mark or Waypoint (I)

Press **[ENT]** (**[CLR]** to abort the move), the Waypoint appears in the new position.

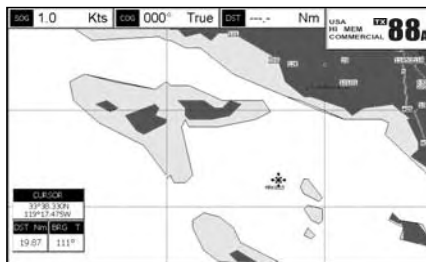

Figure 8.1.1a - Moving Mark or Waypoint (II)

## 8.2 MARKS/WAYPOINTS LIST

The **Marks/Wpt** List shows all the Marks and Waypoints that have been stored into the GPS chartplotter. This page also allows you to:

<b>ICON</b>	Allows sorting by icon type
<b>FIND</b>	Searches through the Marks or Waypoints to find a point by name using the ShuttlePoint knob
<b>LOCATE</b>	Shows the position of a Mark or Waypoint on the Chart page
<b>EDIT</b>	Allows you to edit a previous stored Mark or Waypoint
<b>SORT</b>	Sort the name of the Mark or Waypoint in ascending or descending order
<b>NEW MARK</b>	Allows entering in Marks, editing icon type and position
<b>MODE</b>	This selection controls how the Marks or Waypoints are shown on the Chart page. Selections are: a. SHOW - icon and name are shown b. ICON - only icon (no name) is shown c. HIDE - Mark or Waypoint is hidden d. SHOW ALL - All Marks or Waypoints are shown e. ICON ALL - All Icons are shown without name f. HIDE ALL - All Marks or Waypoints are hidden
<b>DELETE</b>	Delete the selected point
<b>DEL ALL</b>	Delete all stored points
<b>SEND</b>	Sends the stored points to a external device (PC) capable of listening to NMEA WPL sentence.
<b>RECEIVE</b>	Receive the points from an external device (PC) that is capable of sending NMEA WPL sentence.

### NOTE

The SEND and RECEIVE functions are usually used by navigation programs running on a Personal Computer example Nobeltech.

TYPE	NAME	TYPE	LONGITUDE	LATITUDE	MODE
X	MARK1234	MARK	0.0000 00.0000	0.0000 00.0000	SHOW
X	MARK1235	MARK	0.0001 00.0001	0.0001 00.0001	SHOW
X	MARK1236	MARK	0.0002 00.0002	0.0002 00.0002	SHOW
X	MARK1237	MARK	0.0003 00.0003	0.0003 00.0003	SHOW
X	MARK1238	MARK	0.0004 00.0004	0.0004 00.0004	SHOW
X	MARK1239	MARK	0.0005 00.0005	0.0005 00.0005	SHOW
X	MARK1240	MARK	0.0006 00.0006	0.0006 00.0006	SHOW
X	MARK1241	MARK	0.0007 00.0007	0.0007 00.0007	SHOW
X	MARK1242	MARK	0.0008 00.0008	0.0008 00.0008	SHOW
X	MARK1243	MARK	0.0009 00.0009	0.0009 00.0009	SHOW
X	MARK1244	MARK	0.0010 00.0010	0.0010 00.0010	SHOW

Figure 8.2 - Marks/Waypoints List

## 8.3 CREATING A NEW MARK WITH THE MARKS/WAYPOINTS LIST

### NOTE

This function is very useful if you have a list of Marks that you want to enter into the GPS chartplotter.

1. Press **[MENU]**. Move the ShuttlePoint knob to highlight **USER POINTS** and press **[ENT]**.
2. Move the ShuttlePoint knob to highlight **Marks/Wpt** and press **[ENT]**.
3. The Marks/Wpt List page will be shown (see previous picture).
4. To create a New Mark, move the ShuttlePoint knob to the right to highlight **NEW MARK** and press **[ENT]**.
5. Press **[ENT]** to change to show the Icon popup window.
6. Move the ShuttlePoint knob to highlight the desired Icon and press **[ENT]**.
7. Move the ShuttlePoint knob to the right to select the Mark name. Press **[ENT]** and the

first digit in the name will be highlighted.

8. Move the ShuttlePoint knob up or down to select the first character.
9. Move the ShuttlePoint knob to the right to select the next character.
10. Repeat steps 8 and 9 until the Mark name is shown. Press **[ENT]**.
11. Move the ShuttlePoint knob to the right to select the Lat/Lon and press **[ENT]**.
12. Move the ShuttlePoint knob up or down to select the first character.
13. Move the ShuttlePoint knob to the right to select the next character.
14. Repeat steps 12 and 13 until the desired position is shown. Press **[ENT]** and **[CLR]**, a WARNING "Save the new Mark?" popup window will be shown, move the ShuttlePoint knob to the right or left to select **YES** or **NO** and press **[ENT]**.

## 8.4 GOTO CURSOR

The GPS chartplotter allows you to quickly start navigating to the Cursor, Mark or Route.

### GOTO CURSOR

1. Move the ShuttlePoint knob to the exact position you want to navigate to.
2. Press **[GOTO]** and a GOTO popup window will be shown



Figure 8.4 - GO TO menu

3. Move the ShuttlePoint knob to highlight **CURSOR** and press **[ENT]**.
4. The GPS chartplotter is now navigating from your current position to the location selected at step 1.

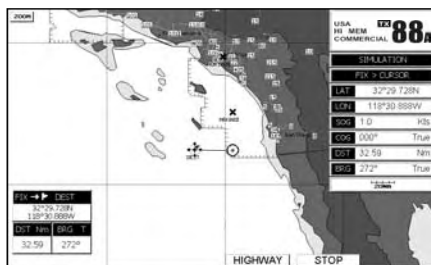

Figure 8.4a - Navigating to Cursor Example

5. Now the GPS chartplotter shows a navigation line between the vessels location and the destination point. A popup window shows the Distance (DST) and Bearing (BRG) from the vessels location to the destination point.
6. The GPS chartplotter is in Cursor mode, to switch to Home mode press **[CLR]** so the vessel stay in the center of the page.
7. Two Soft Keys are also shown that allow you to quickly switch to the HIGHWAY page or to stop navigation.
8. To STOP Navigation, press **[GOTO]** and the WARNING page is shown. Select **STOP** and press **[ENT]**.



## 8.5 GOTO MARK

---

1. Move the ShuttlePoint knob to an open position (no buoy, warning etc. under the cursor) on the Chart page.
2. Press **[GOTO]** to show the GOTO popup window.
3. Move the ShuttlePoint knob to highlight **MARK** and press **[ENT]** to show the Marks/Wpt List.
4. Move the ShuttlePoint to the highlight the desired Mark or Waypoint and press **[GOTO]**.
5. You will notice a circle is drawn around the Icon Symbol. This means the GPS chartplotter is now navigating to the point.
6. Press **[CLR]** to switch to the Chart page or Highway page to start navigating to the point.

---

## 9. MAN OVER BOARD (MOB) FUNCTION

---

During navigation, the “MOB” feature provides a one-touch method of storing a location (such as a point where a crew member fell overboard). In this mode, the GPS chartplotter places a MOB point on the Chart page and all the navigation data shown is related to navigating back to this point, allowing you to retrace your path to the MOB point efficiently.

1. On the Chart page, press **[MARK/MOB]** to start navigating back to the point.
2. You will notice a MOB Mark will be laid on the Chart page and all navigation is referring back to this point.
3. If the cursor is moved over the MOB Icon, popup windows over Soft Keys will be shown allowing quick access to the Navigation or Highway pages.

### 9.0 DELETING A MOB POINT

---

1. Move the ShuttlePoint knob until the cursor is over the top of the MOB icon.
2. Press **[DELETE]**, a popup window will be shown to confirm deleting the MOB point.
3. Move the ShuttlePoint knob to highlight **YES** and press **[ENTER]**.

---

## 10. ROUTES



---

The GPS chartplotter has the capability to store 20 Routes with a maximum of 50 Waypoints each.

A Route can consist of Waypoints or Marks. The difference is when a Route is made using Waypoints and the Route is deleted the Waypoints are also deleted. However if a Route is made of Marks and the Route is deleted the Marks stay in memory.

### 10.0 CREATING A ROUTE USING WAYPOINTS

---

1. On the Chart page move the ShuttlePoint knob to the Lat/Lon of the starting Waypoint in the Route.
2. Press **[RTE]**, you will notice the Starting Waypoint  will be placed under the cursor.
3. Move the ShuttlePoint knob to the second Lat/Lon of the next leg  in the Route.
4. Press **[RTE]**. You will notice another Waypoint is shown under the cursor and a line joins the starting Waypoint to the Second Waypoint.

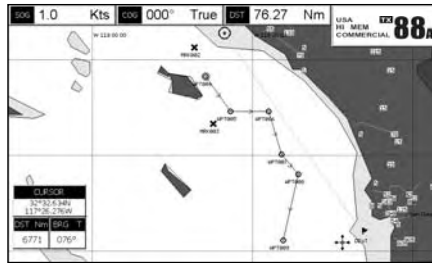

Figure 10.0 - Creating a Route using Waypoints

5. Repeat steps 3 and 4 until all Waypoints are entered into the Route.

#### NOTE

At this point the Route is saved as ROUTE01. If you would like to save the Route under a specific name follow the remaining steps.

6. To name the Route press **[MENU]**. Move the ShuttlePoint knob to highlight **USER POINTS** and press **[ENT]**.
7. Move the ShuttlePoint knob to highlight **ROUTE** and press **[ENT]**.
8. Move the ShuttlePoint knob to highlight **REPORT** and press **[ENT]** or move the ShuttlePoint knob to the right.
9. Move the ShuttlePoint knob to highlight **NAME** and press **[ENT]**. A popup window will be shown.
10. Move the ShuttlePoint knob up/down to change the characters and left/right to select a different character in the Routes Name.

ROUTE REPORT							
ROUTE	SPEED	DATE/TIME	LATITUDE	LONGITUDE	DIR	DIR1	DIR2
NO. OF STOPS	NO. OF STOPS	NO. OF STOPS	NO. OF STOPS	NO. OF STOPS	NO. OF STOPS	NO. OF STOPS	NO. OF STOPS
MP0004	0000.0	0000.0	0000.0	0000.0	0000.0	0000.0	0000.0
MP0005	0000.0	0000.0	0000.0	0000.0	0000.0	0000.0	0000.0
MP0006	0000.0	0000.0	0000.0	0000.0	0000.0	0000.0	0000.0
MP0007	0000.0	0000.0	0000.0	0000.0	0000.0	0000.0	0000.0
MP0008	0000.0	0000.0	0000.0	0000.0	0000.0	0000.0	0000.0
MP0009	0000.0	0000.0	0000.0	0000.0	0000.0	0000.0	0000.0

Figure 10.0 - Route Report

- When finished press **[ENT]** to save.
- Press **[CLR]** to show the Chart page.

## 10.1 MAKING ADDITIONAL ROUTES

To create another Route the GPS chartplotter must be told that you want to create a second Route.

- Press **[MENU]**. Move the ShuttlePoint knob to highlight **USER POINTS** and press **[ENT]**.
- Move the ShuttlePoint knob to highlight **ROUTE** and press **[ENT]**.
- Move the ShuttlePoint knob to highlight **SELECT** and press **[ENT]** or move the ShuttlePoint knob to the right.
- Move the ShuttlePoint knob to an open Route number example Route 2.
- Press **[ENT]** or move the ShuttlePoint knob to the right.
- Press **[CLR]** or move the ShuttlePoint knob to the left until the Chart page is shown.
- To create the new Route, follow the steps in Creating a Route using Waypoints or Marks sections.

## 10.2 CREATING A ROUTE USING MARKS ON THE CHART PAGE

To create a Route containing Marks you first must create the Marks and show them on the Chart page.

- Move the ShuttlePoint knob over the top of a Mark that you wish to be the starting point in the Route and press **[RTE]**.
- Next move the ShuttlePoint knob until the cursor is over the Mark that you want to be the next leg in the Route.
- Press **[RTE]**. You will notice a bearing line joins the first and second Mark which means these Marks are selected into the Route.
- Repeat steps 3 and 4 until all Marks are entered into the Route.

### NOTE

At this point the Route is saved as ROUTE01. If you would like to save the Route under a specific name follow the remaining steps.

- To name the Route press **[MENU]**. Move the ShuttlePoint knob to highlight **USER POINTS** and press **[ENT]**.
- Move the ShuttlePoint knob to highlight **ROUTE** and press **[ENT]**.

7. Move the ShuttlePoint to highlight **REPORT** and press [ENT] or move the ShuttlePoint knob to the right.
8. Move the ShuttlePoint knob to highlight **NAME** and press [ENT] or move the ShuttlePoint knob to the right. A popup window will be shown.
9. Move the ShuttlePoint knob up/down to change the characters and left/right to select a different character in the Routes Name.
10. When finished press [ENT] to save.
11. Press [CLR] to show the Chart page is shown.

### 10.3 INSERTING A WAYPOINT INTO A ROUTE

---

Place the cursor on the navigation line between two points and press [RTE]. Move the ShuttlePoint knob to the desired location of the Waypoint and press [ENT].

### 10.4 GOTO A ROUTE

---

#### 10.4.0 By select Route

1. Move the ShuttlePoint knob to an open position (no buoy, warning etc. under the cursor) on the Chart page.
2. Press [GOTO] to show the GOTO popup window.
3. Move the ShuttlePoint knob to highlight **ROUTE** and press [ENT].
4. The SELECT ROUTE popup window will be shown.
5. Move the ShuttlePoint knob to the highlight the desired Route and press [ENT].
6. On the Chart page a circle with a Flag is shown on the first leg of the Route and a navigation line is shown, indicating the GPS chartplotter is navigating to the first Waypoint in the Route.

SELECT ROUTE	
ROUTE	NAME
1	ROUTE04
2	ROUTE02
3	-----
4	-----
5	-----
6	-----
7	-----
8	-----
9	-----
10	-----

Figure 10.4.0 - Select a Route

#### 10.4.1 By Cursor key

1. On the Chart page move the ShuttlePoint knob until the cursor reaches the starting point of the Route.
2. Press [GOTO] to start following the Route.
3. Press [CLR] twice to revert to Home mode.

## 10.5 OTHER SETTINGS IN ROUTE MENU

---

You will notice the **ROUTE** menu has other selections.

---

<b>SELECT</b>	Choose an available Route to create or choose a stored Route to show and follow on the Chart page.
<b>DELETE</b>	Deletes the Route when shown in the above SELECT menu.
<b>REVERSE</b>	Reverses the Route, when chosen Starting point is at the end of the Route.
<b>COLOR</b>	Allows changing the color of the navigation lines between in leg in the Route.
<b>REPORT</b>	The Route Report menu is useful to show details of the Waypoints contained within the Route. This menu also allows you to enter in your average speed and fuel consumption and calculate the approximate fuel used when following the Route.
<b>SEND</b>	Sends the stored points to a external device (PC) capable of listening to NMEA RTE sentence.
<b>RECEIVE</b>	Receive the points from an external device (PC) capable of sending NMEA RTE sentence.

---

---

# 11. TRACKS

---

The GPS chartplotter has the capability to store 5 individual and record up to 3000 Track Points.

Before using the Track function you will need to setup the Track function that suits your boat. The Track function tracks your vessels location as it moves through the water. The Track function can be setup to lay down a Track for a predetermined time or distance interval. If you have a fast moving boat you may want to setup the GPS chartplotter to record a Track point every 0.5 NM or if you have a sail boat you may want to setup to lay down a Track point once ever 1 minute.

## NOTE

Pls note the Track point memory is 3000 points. This means for a long journey you may have to adjust the time or distance to be able to track your journey. It should be noted when the 3000 Track points are used up the first Track point layed down will be deleted when a new point is placed on the chart.

1. Press **[MENU]**. Move the ShuttlePoint knob to highlight **USER POINTS** and press **[ENT]**.
2. Move the ShuttlePoint knob to highlight **TRACK** and press **[ENT]**.
3. Move the ShuttlePoint knob to highlight **STEP UNIT** and press **[ENT]** or move the ShuttlePoint knob to the right.
4. Move the ShuttlePoint knob to highlight **Dist** or **Time** and press **[ENT]** or move the ShuttlePoint knob to the right.

TRACK	
TRACKING	On
ACTIVE TRACK	1
VISIBLE	0
LINE COLOR	Dist
DELETE	Time
<b>STEP UNIT</b>	<b>Dist</b>
DISTANCE	0.1Nm
TIME	5 min

Figure 11 - Distance Units and Time Units

5. Move the ShuttlePoint knob to highlight **DISTANCE** or **TIME** step interval and press **[ENT]** or move the ShuttlePoint knob to the right.
6. Move the ShuttlePoint knob up/down to the desired step value and press **[ENT]** or move the ShuttlePoint knob to the right.
7. Press **[CLR]** or move the ShuttlePoint knob to the left until the Chart page is shown.

---

## 11.0 TRACKING

---

You may have to take a few trips to see how you like the Distance or Time Interval setup on the previous step. However when using the tracking feature you will notice every time a Track Point is layed down on the Chart page a small filled in circle is shown on the Track line. If you move the cursor over the top of the circle a popup window will be shown with the Time, Water Temperature, Speed and Course Over Ground (COG) this is very useful if you are fishing and want to review the conditions where the fish were being caught.

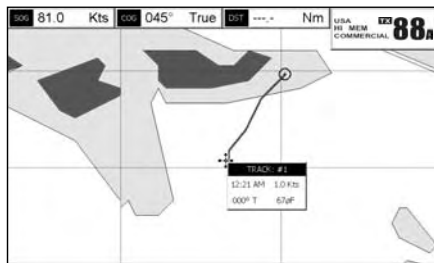

Figure 11.0 - Tracking

## 11.0.0 Saving and starting a new Track

A Track is automatically saved to memory. To start a new Track:

1. Press **[MENU]**. Move the ShuttlePoint knob to highlight **USER POINTS** and press **[ENT]**.
2. Move the ShuttlePoint knob to highlight **TRACK** and press **[ENT]**.
3. Move the ShuttlePoint knob to highlight **ACTIVE TRACK** and press **[ENT]** or move the ShuttlePoint knob to the right.
4. Move the ShuttlePoint knob up/down to select the next available open Track and press **[ENT]** or move the ShuttlePoint knob to the right.
5. Move the ShuttlePoint knob to highlight **TRACKING** and press **[ENT]** or move the ShuttlePoint knob to the right to set On.
6. Press **[CLR]** or move the ShuttlePoint knob to the left until the Chart page is shown.
7. A new Track now will be laid down.

### 11.0.1 Other Settings in Track Menu

You will notice the Track menu has other selections

<b>TRACKING</b>	Allows turning on or off the tracking function
<b>ACTIVE TRACK</b>	This selection allows you to save a Track to one of the 5 Tracks available
<b>VISIBLE</b>	Shows or hides a Track shown in ACTIVE TRACK menu
<b>LINE COLOR</b>	Selects the color of the Track line
<b>DELETE</b>	Deletes a Track selected in the ACTIVE TRACK menu
<b>STEP UNIT</b>	Allowable selection are Distance or Time
<b>DISTANCE</b>	Setup the Distance interval the Track point is placed on the Chart page
<b>TIME</b>	Setup the TIME interval the Track point is placed on the Chart page



## 11.1 USING THE TRIP LOG

On the Chart, Navigation, Highway and NMEA Data pages the windows may be customized to show TRIP LOG information.

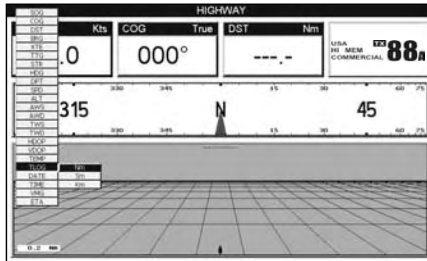

Figure 11.1 - Using the Trip Log

1. Select one of the pages listed above, press and hold **[MENU]**. You will notice one of the data boxes will be highlighted.
2. Press **[ENT]** and move the ShuttlePoint knob to highlight **TRIP LOG**, press **[ENT]** or move the ShuttlePoint knob to the right.
3. A popup window will be shown with **Nm** (Nautical Mile), **Sm** (Statute Mile), **Km** (Kilometer) and **RESET**. Move the ShuttlePoint knob to select the desired units of measure and press **[ENT]** or move the ShuttlePoint knob to the right.
4. Press **[CLR]** or move the ShuttlePoint knob to the right until the selected page (Chart, Navigation, Highway or NMEA Data Page) is shown.

### 11.1.0 Resetting the Trip Log

Select the page with TRIP LOG in one of the data windows as setup in the "Using the TRIP LOG" section.

1. Press and hold **[MENU]**, move the ShuttlePoint knob to highlight **TRIP LOG**.
2. Press **[ENT]** or move the ShuttlePoint knob to the right to show a popup window, select **RESET** and press **[ENT]** or move the ShuttlePoint knob to the right.
3. A Warning popup window will be shown to confirm if you want to reset the Trip Log. Using the ShuttlePoint knob select **YES** and press **[ENT]**. The Trip Log is now reset.

## 12. USER C-CARD

The Optional C-MAP User C-CARD is used to back up Marks, Routes, and Tracks stored in your GPS chartplotter's memory. The User C-CARD is similar to a back up disk used with a PC, in case you have to clear your GPS chartplotter's memory, or if you would like to transfer Waypoint, Track and Route information from one STANDARD HORIZON GPS chartplotter to another.

### 12.0 USER C-CARD MENU

C-MAP offers a special card that may be used to backup the User Points and Tracks the you have created in the GPS chartplotter. This optional card is similar to using a floppy disk on a PC to backup your files or to transfer the information that you have stored to a friends GPS chartplotter. The information shown below will assist you to transfer the User Points, Routes and Track history to the optional User C-CARD.

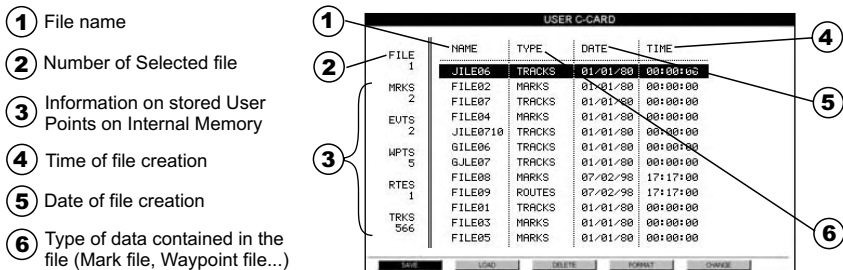

Figure 12.0 - User C-CARD Menu

#### 12.0.0 Formatting the User C-CARD

1. Press **[MENU]**. Move the ShuttlePoint knob to highlight **USER POINTS** and press **[ENT]**.
2. Move the ShuttlePoint knob to highlight **USER C-CARD** and press **[ENT]**.
3. Move the ShuttlePoint knob to highlight **FORMAT** and press **[ENT]**.
4. A popup Warning window will to confirm you want to format the User C-CARD.
5. Select **YES** and press **[ENT]** to confirm (select **NO** otherwise). The format of User C-CARD must be done before using a new User C-CARD: this operation prepares the User C-CARD to receive and store information.

#### NOTE

Formatting permanently erases all files previously saved on the User C-CARD.

### 12.0.1 Transferring files to the optional User C-CARD

1. Remove the C-MAP NT\*/MAX C-CARD if present and insert the optional User C-CARD into the slot.
2. Press **[MENU]**. Move the ShuttlePoint knob to highlight **USER POINTS** and press **[ENT]**.
3. Move the ShuttlePoint knob to highlight **USER C-CARD** and press **[ENT]** or move the ShuttlePoint knob to the right.
4. A screen will appear. Move the ShuttlePoint knob to the left to highlight **SAVE** and press **[ENT]**.
5. A popup **SAVE FILE** window will appear. In this window you can change the name and the file type by using the ShuttlePoint knob and pressing **[ENT]**, when finished press **[CLR]** once.
6. To save the file to the User C-CARD.

### 12.0.2 Loading a file

If you have a problem and accidentally loose the User Points in the GPS chartplotter with the optional User C-CARD it is possible to load the data back into the GPS chartplotter using the following procedure:

1. Press **[MENU]**. Move the ShuttlePoint knob to highlight **USER POINTS** and press **[ENT]**.
2. Move the ShuttlePoint knob to highlight **USER C-CARD** and press **[ENT]**.
3. Select the saved file from the User C-CARD list by using the ShuttlePoint knob and press **[ENT]**.
4. Move the ShuttlePoint knob to the left to highlight **LOAD** and press **[ENT]**.
5. A popup information window will appear when loading is complete.
6. Press **[ENT]** to confirm.

### 12.0.3 Deleting a file from the User C-CARD

You may want to delete a saved file on the User C-CARD.

1. Press **[MENU]**. Move the ShuttlePoint knob to highlight **USER POINTS** and press **[ENT]**.
2. Move the ShuttlePoint knob to highlight **USER C-CARD** and press **[ENT]**.
3. Select the saved file from the User C-CARD list by using the ShuttlePoint knob and press **[ENT]**.
4. Move the ShuttlePoint knob to the left to highlight **DELETE** and press **[ENT]**.
5. A popup Warning window will to confirm you want to delete the file.
6. Press **[ENT]** to confirm.

# 13. PAGES

The GPS chartplotter has many pages that are designed to ease your navigation.

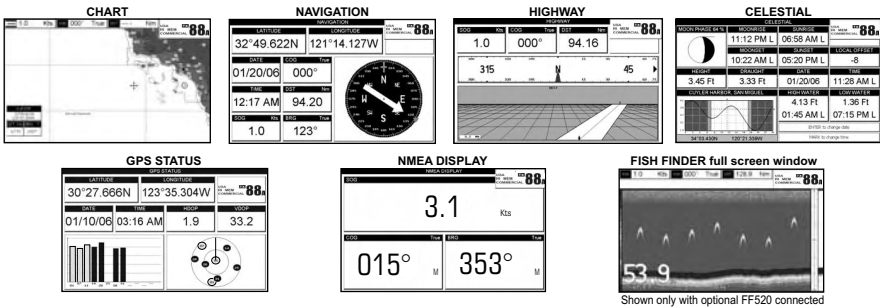

Figure 13 - Screen display pages

The pages can be selected in one of two ways:

## Selection by MENU

Press **[MENU]**, move the ShuttlePoint knob to highlight the desired Page in the Main Menu page and press **[ENT]**.

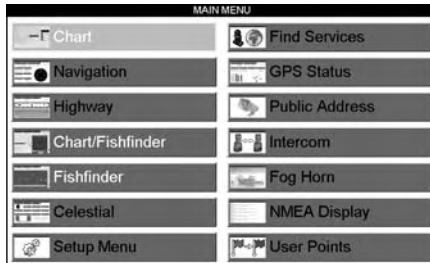

Figure 13a - Screen display pages (by [MENU])

## Selection by SOFT KEY

Pressing any Soft Key under the display, then press the Soft Key to show the desired page.

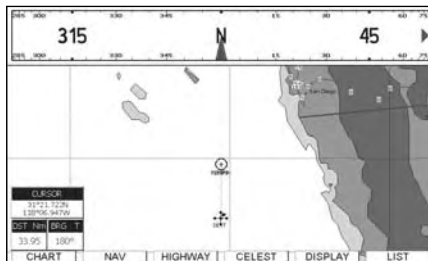

Figure 13b - Screen display pages (by Soft Keys)

## 13.0 CHART PAGE

The Chart page is the main page of the GPS chartplotter. From this page the user can zoom in/out, pan around the chart, show information about cartographic objects, see the exact vessel position with the COG and SOG, place points, GOTO a destination point, show Track history etc. The GPS chartplotter is provided with a Worldwide background showing C-MAP NT<sup>+</sup>/MAX detail up to 2.0 NM. For more detail, optional C-MAP NT<sup>+</sup>/MAX C-CARDS are used.

- ① Fix Status
- ② Cursor coordinates
- ③ Speed Over Ground and Course Over Ground
- ④ Distance and Bearings from Fix to Cursor (if the Fix is NOT received, DST and BRG are empty)
- ⑤ Chart Scale

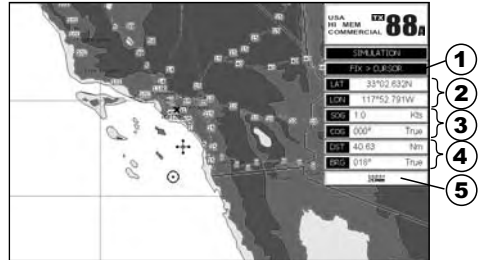

Figure 13.0 - Charts and general text area

### 13.0.0 Window Selections

The window on the right side of the Chart page is called the General Window and it may be edited, customized or even changed to show a highway or compass tape.

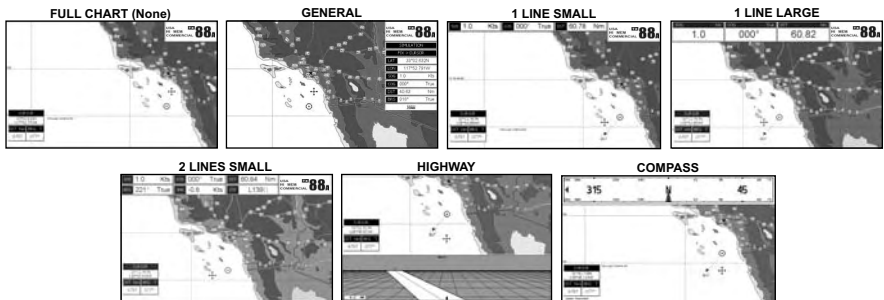

Figure 13.0.0 - Data window layout

1. To change, press **[MENU]** two times. Move the ShuttlePoint knob to highlight **GENERAL SETUP** and press **[ENT]** or move the ShuttlePoint knob to the right.
2. Move the ShuttlePoint knob to highlight **WINDOW SETUP** and press **[ENT]** or move the ShuttlePoint knob to the right.
3. Move the ShuttlePoint knob to highlight **CHART PAGE** and press **[ENT]** or move the ShuttlePoint knob to the right.
4. Select the desired window, **HIGHWAY** or **COMPASS**, and press **[ENT]** or move the ShuttlePoint knob to the right.
5. Press **[CLR]** or move the ShuttlePoint knob to exit the menu and show the Chart page.

### 13.0.1 Additional Functions on Chart page

When on the Chart page you will notice icons of Buoys, Towers, Lights, Wrecks, Tide Stations and Port Icons. If the cursor is moved over the top of these icons a popup window will be shown with information about the icon.

### 13.0.2 Turning Off Information on Icon Points

The GPS chartplotter allows you to select to see information on points, all items or to turn this function off.

1. Press **[MENU]** two times. Move the ShuttlePoint knob to highlight **GENERAL SETUP** and press **[ENT]** or move the ShuttlePoint knob to the right.
2. Move the ShuttlePoint knob to highlight **AUTO INFO** and press **[ENT]** or move the ShuttlePoint knob to the right.
3. Select the **Off**, **On Points**, or **On ALL** and press **[ENT]** or move the ShuttlePoint knob to the right.
4. Press **[CLR]** or move the ShuttlePoint knob to the left until the Chart page appears.

### 13.0.3 Display Mode

Selects from a predefined table what cartographic objects are displayed and which display options are set. Preprogrammed settings are user selectable from Full, Medium, Low, capitalize RADAR in all places that are mentioned. Please note this function is not actually showing RADAR information it is only showing what typically would be shown by a separate dedicated RADAR display), Tides, Custom (default mode). The table below shows the selections for each mode.

1. To change to one of the preprogrammed settings, press **[MENU]** two times. Move the ShuttlePoint knob to highlight **MAP CONFIGURATIONS** and press **[ENT]** or move the ShuttlePoint knob to the right.
2. Move the ShuttlePoint knob to highlight **DISPLAY MODE** and press **[ENT]** or move the ShuttlePoint knob to the right.
3. Move the ShuttlePoint knob up or down to select the preset and press **[ENT]**.
4. Press **[CLR]** or move the ShuttlePoint knob to the right until the Chart page is shown.

Setting	Full	Medium	Low	RADAR	Tides	Custom (Default values)
Names	On	On	On	On	On	On
Name Tags	On	Off	Off	Off	Off	On
Nav-Aids & Light Sectors	On	No Sector	No Sector	No Sector	Off	Off
Attention Areas	On	On	Off	Off	Off	On
Tides & Currents	On	Off	Off	Off	On	On
Seabed Type	On	Off	Off	Off	Off	On
Ports & Services	On	On	Off	On	Off	On
Tracks & Routes	On	Off	Off	Off	Off	On
Depth Range	On	On	On	On	On	On
Depth Range Min	0 Ft	0 Ft	0 Ft	0 Ft	0 Ft	0 Ft
Depth Range Max	32805 Ft	32805 Ft	32805 Ft	32805 Ft	32805 Ft	1000 Ft
Land Elevation Values	On	On	Off	Off	Off	Off
Roads	On	Off	Off	Off	Off	On
Points Of Interest	On	Off	Off	Off	Off	On
Lat/Lon Grid	On	Off	Off	Off	Off	Off
Chart Boundaries	On	Auto	Off	Off	Off	Off
Value-Added Data	On	Off	Off	Off	Off	On
Mixing Levels	On	On	On	On	On	On
Chart Lock	On	On	On	On	On	On
Underwater Ob. Limit	1000 Ft	1000 Ft	32 Ft	32 Ft	32 Ft	10 Ft

Rocks	Icon + Depth	Icon	Icon	Icon	Icon	Icon
Obstructions	Icon + Depth	Icon	Icon	Icon	Icon	Icon
Diffusers	Icon + Depth	Icon	Icon	Icon	Icon	Icon
Wrecks	Icon + Depth	Icon	Icon	Icon	Icon	Icon

### 13.0.4 Marine Settings

To control the display on the map of the marine features.

<b>Names</b>	: Turns the Local area names On or Off.
<b>Names Tags</b>	: Turns On or Off a tag for particular chart objects that either includes the Name of the chart object or the Depth of an Underwater chart object.
<b>Nav Aids &amp; Light Sectors:</b>	Turns the presentation of Lights, Signals, Buoys and Beacons On (Nav-Aids & Light Sectors are shown), Off (Nav-Aids & Light Sectors are not shown) or Icon (Nav-Aids are shown, Light Sectors are hidden).
<b>Attention Areas</b>	: Turns the displaying of Attention Areas (areas in which special attention by the mariner is required because of natural or man-made hazards sailing regulations and restrictions) On or Off.
<b>Tides &amp; Currents</b>	: Turns the displaying of Tides and Currents On or Off.

When data/time is available, Tidal stream arrows are shown on the charts, indicating the direction and strength of the Tide. If no data/time is available from the GPS or the GPS chartplotter is not in Simulation mode, the icon on the map is generic one. The color of the arrow denotes the strength of the current as follows:

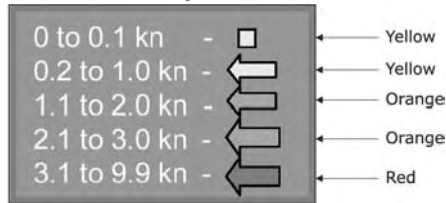

When the GPS chartplotter receives a valid position fix, the Tide icons are shown on the charts on the basis of the current date and time: the screen displays and changes arrows as date/time changes.

<b>Seabed Type</b>	: Turns the displaying of the Seabed type On or Off.
<b>Ports &amp; Services</b>	: Turns the displaying of Ports and Service icons On of Off. Areas along the shore with facilities for mooring, downloading and uploading of ships, generally sheltered from waves and winds. Port installations are piers, wharves, pontoons, dry docks, cranes....
<b>Tracks &amp; Routes</b>	: Turns displaying of underwater objects On or Off. Objects are obstructions, wrecks, cable etc.

### 13.0.5 Depth Settings

To control the display on the map of the depth informations.

<b>Depth Range</b>	: Sets On/Off the displaying of the Depth Areas (the sea areas included in the user selectable range of minimum and maximum depth limits). The sea area that is <b>beyond</b> the selected range is filled by a uniform white color, the sea area that is <b>inside</b> the selected range is filled by ordinary multicolor shading. The Spot Soundings and Depth Contours are displayed on the range only.
<b>Depth Range Min</b>	: Sets the minimum depth limit to show Depth Sounding, Bathymetric Lines and Depth Area. The default setting is 0 Mt.
<b>Depth Range Max</b>	: Sets the max depth limit to show Depth Sounding, Bathymetric Lines and Depth Area. The default setting is 9.999 Mt.

## 13.0.6 Land Settings

To control the display on the map of the terrestrial features.

---

<b>Land Elevation Values</b>	: The Land Elevation areas are always shown, but it is possible to turn the displaying of Land Elevation On or Off.
<b>Roads</b>	: Turns the displaying of roads On or Off.
<b>Points of interest</b>	: Turns the displaying of Points of Information On or Off.

---

## 13.0.7 Chart Settings

Settings that control how the chart features will be shown on the Chart page of the GPS chartplotter.

---

<b>Lat/Lon Grid</b>	: Turns the displaying of the Latitude and Longitude grid lines on or off on the chart page.
<b>Chart Boundaries</b>	: Turns the displaying of Chart Boundaries on, off or auto mode which shows the chart boundaries of the two charts below the current scale. The chart boundaries are only show when a C-Map NT, NT+ or MAX card is inserted into the GPS chartplotter.
<b>Value Added Data</b>	: Turns the displaying of Value added data On or Off. The Value Added Data (VAD) is a collection of additional cartographic objects which are not present on the original paper chart (from which the electronic chart derives). These objects have been obtained from other sources (that C-MAP believes to be reliable) and then merged to the electronic charts in order to provide more information useful for the navigation. VAD object can be any cartographic objects and it can be distinguished from the official-chart-objects from the Quick Info. A dedicated icon is shown on the Quick Info window to indicate that the object queried is a VAD. The same icon is also shown on the Full Info page and in addition the extended text Value Added Data is shown on the details of the VAD object.
<b>Mixing Levels</b>	: When the map coverage at the current chart scale does not fill the entire display, the GPS chartplotter draws the rest of the map using charts from above and below the current scale. When this function is turned on you will notice the display may redraw 2 to 3 times to show all the details.
<b>Chart Lock (*)</b>	: Sets On/Off the Chart Lock option. When Chart Lock is On, the available zoom scales are only the ones containing cartographic data. Instead when Chart Lock is Off, it is possible to zoom down into zoom scales not covered by cartographic data after the last available zoom scale covered by cartographic data. The DSI window, if present, will show "NO CHART", when an empty level is entered in the location of map expansion mode.

---

### NOTE(\*)

When an empty level is entered, the message "No cartographic coverage" is shown on a window in a corner of the map display. The warning message is always displayed as long as the current zoom has no data coverage.

---

## 13.0.8 Underwater Objects Settings

To control the display on the map of the Underwater Objects features.

---

<b>Underwater Objects Limit</b>	: Selects the max depth value to display Underwater Objects. If value is set to 0 Mt, the Underwater Objects are not shown on the charts. Menu options are grayed out. If value is more than 0 Mt (i.e. 10 Mt), in the Range from 0 Mt to the selected value the Underwater Objects are displayed according to their setting below. The default setting is 10 Mt.
<b>Rocks</b>	: Sets Off/Icon/Icon+Depth* the displaying of the Rocks. The default setting is Icon.
<b>Obstructions</b>	: Sets Off/Icon/Icon+Depth* the displaying of the Obstructions. The default setting is Icon.
<b>Diffusers</b>	: Sets Off/Icon/Icon+Depth* the displaying of Diffusers. The default setting is Icon.
<b>Wrecks</b>	: Sets Off/Icon/Icon+Depth* the displaying of Wrecks. The default setting is Icon..

---

### NOTE(\*)

Choose the options: OFF (the object is not visible independently of the selected "Underwater Object Depth Value"); ICON (the object icon is visible without tags, in the range selected from "Underwater Object Depth Value" option); ICON+DEPTH (the object icon and tag is visible, in the range selected from "Underwater Object Depth Value" option).

---



### 13.0.9 Customizing the Data Windows

The data fields contained on the General, 1 Line Small/Large and 2 Line Small data windows can be changed. The picture below shows the Chart page with 1 Line Large selected and a popup window with many selections.

1. To change a data window field, press and hold **[MENU]** until the field is highlighted.
2. Move the ShuttlePoint knob to the desired data field and press **[ENT]**. The popup window will be shown.
3. Move the ShuttlePoint knob up or down to choose the desired setting and press **[ENT]** to select and press **[CLR]** to store and exit the editing mode.

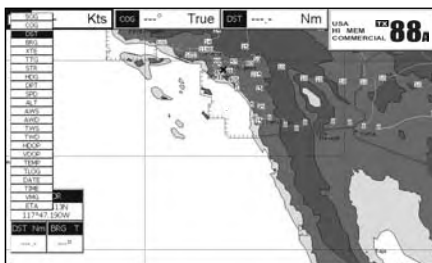

Figure 13.0.9 - Customize the Data Windows

#### NOTE

Data window field on the NAVIGATION, HIGHWAY, GPS STATUS, and NMEA pages may be customized in the above manner.

### 13.1 CUSTOMIZING CHART SETTINGS

1. Press **[MENU]** two times. Move the ShuttlePoint knob to highlight **MAP CONFIGURATIONS** and press **[ENT]** or move the ShuttlePoint knob to the right.
2. Move the ShuttlePoint knob up or down to select the desired item within the groups Marine Settings, Depth Settings, Land Settings, Chart Settings or Underwater Objects Settings and press **[ENT]**. See the above sections for details on selections.

## 13.2 NAVIGATION PAGE

This page is useful to show information when heading to a destination. The default page is shown with a Compass Rose, however this can be customized to show a Compass Tape.

1. To change to show the COMPASS TAPE, select the Chart page, press **[MENU]** two times. Move the ShuttlePoint knob to highlight **GENERAL SETUP** and press **[ENT]** or move the ShuttlePoint knob to the right.
2. Move the ShuttlePoint knob to highlight **WINDOW SETUP** and press **[ENT]** or move the ShuttlePoint knob to the right.
3. Move the ShuttlePoint knob to highlight **NAVIGATION PAGE** and press **[ENT]** or move the ShuttlePoint knob to the right.
4. Move the ShuttlePoint up or down to select **COMPASS TAPE** and press **[ENT]**.
5. Press **[CLR]** or move the Shuttlepoint knob to the right until the Chart page is shown.

- 1 Fix position
- 2 Date
- 3 Course Over Ground
- 4 Time
- 5 Distance
- 6 Speed Over Ground
- 7 Bearing to Destination
- 8 VHF information
- 9 Compass Rose

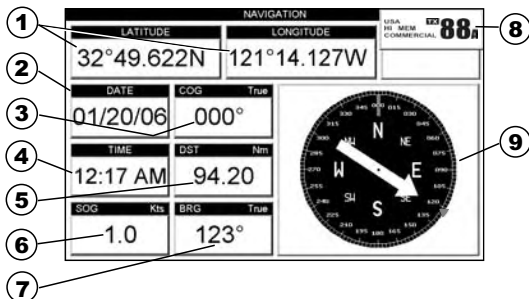

Figure 13.2 - Navigation Data page with Compass Rose

- 1 Fix position
- 2 Compass Tape
- 3 Time
- 4 Time To Go
- 5 Distance to Destination
- 6 VHF Information
- 7 Speed Over Ground
- 8 Course Over Ground
- 9 Bearing to Destination

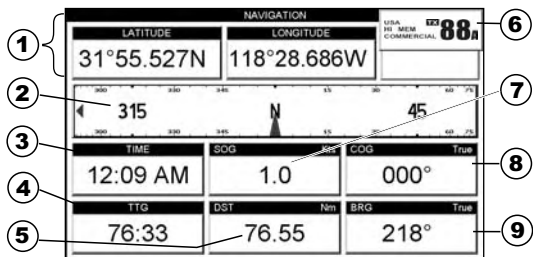

Figure 13.2a - Navigation Data page with Compass Tape

### 13.3 HIGHWAY PAGE

Shows a 3D view of the vessel traveling through the water when Navigating to a destination point, Mark or following a Route. Moving the ShuttlePoint knob up or down changes the highway scale.

- ① Speed Over Ground
- ② Course Over Ground
- ③ Compass Tape
- ④ Highway Scale
- ⑤ VHF Information
- ⑥ Distance
- ⑦ Highway Display

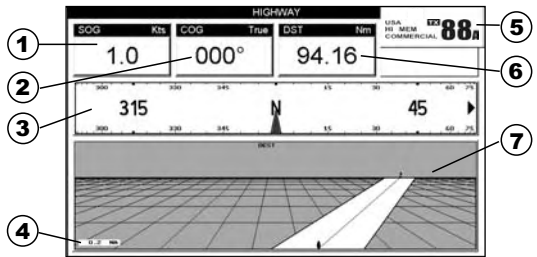

Figure 13.3 - Highway page

### 13.4 CELESTIAL PAGE

This page is useful for boaters that are concerned about the height of the water under a bridge or by fisherman that wish to know the tide and moon phase of a specific date.

#### Changing date

1. Press [ENT] and a popup window will be shown.
2. Moving the ShuttlePoint knob up or down changes the digits and left and right selects the month, day and year.
3. Press [CLR] to exit and view the information.

#### Changing to and from Daylight Savings time

1. Press [MARK/MOB] to toggle between Standard and Daylight Savings time.

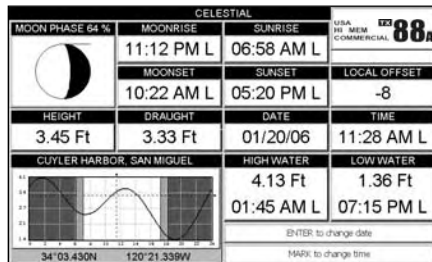

Figure 13.4 - Celestial page

## 13.5 GPS STATUS PAGE

This page is used as a reference to see how well the GPS is receiving satellites.

- ① Ship's Coordinates
- ② Date and Time
- ③ Tracked, but not used, Satellite
- ④ Used Satellite
- ⑤ VHF information
- ⑥ Vertical Dilution of Precision
- ⑦ Horizontal Dilution of Precision
- ⑧ COG (Course Over Ground)

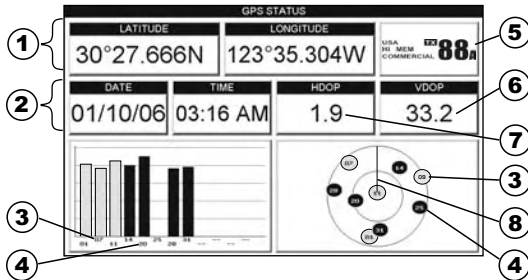

Figure 13.5 - GPS Status page

The WAAS/GPS Icon area may change due to the satellite reception:

**ACQUIRING** : the GPS is trying to receive a valid position fix.

**GPS2D** : The GPS is receiving at least 2 valid Satellites

**GPS3D** : the GPS is receiving at least 3 Satellites.

**WAAS 2D/3D** : the GPS is receiving a 2D or 3D position and the correction from the WAAS Satellite.

**HDOP** : Horizontal Dilution of Precision

**VDOP** : Vertical Dilution of Precision

## 13.6 NMEA DISPLAY PAGE

The GPS chartplotter is capable of displaying information in the customizable data windows from external NMEA devices. Depth sounder, Speed Log with temp, Wind speed and direction, Flux gate compass, and GPS information can be shown in any of the boxes. The default NMEA Display shows 3 windows. When going to a destination, this screen is useful to navigate as to get to the destination keep the Course Over Ground (COG) and Bearing (BRG) figures the same.

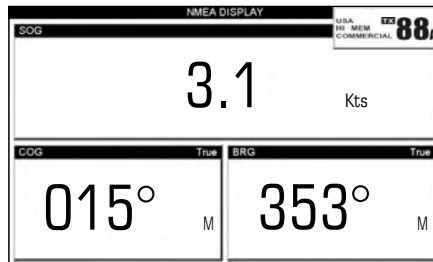

Figure 13.6 - NMEA Display page

The NMEA sentences read from external devices are: BWC, DSC, DSE, GGA, GLL, GSA, GSV, HDG, HDM, HDT, RMC, VHW, VTG, DPT, DBT, MTW, VWR, VWT, TLL, WPL, RTE.

### CHANGING the NMEA PAGE Windows

1. Press **[MENU]**. Move the ShuttlePoint knob to highlight **NMEA DISPLAY** and press **[ENT]**.
2. Move the ShuttlePoint knob to highlight **DISPLAY** and press **[ENT]**.
3. To change the 5 different pages move the ShuttlePoint knob to the left or right.

## 13.7 NMEA DATA PAGE

The NMEA Data Page is very useful to see if a External device (example: Depth Sounder) is transmitting NMEA sentences to the GPS chartplotter. This page can also be used to see if the GPS chartplotter NMEA output is being loaded down by a external NMEA device the GPS chartplotter is connected to.

Scenario: CPV connected to Autopilot but not receiving.

Usually the VHF Radio will be connected to the Green and Brown wires. To check to see if the GPS chartplotter is transmitting the sentences:

1. Press **[MENU]**. Move the ShuttlePoint knob to highlight **NMEA DISPLAY** and press **[ENT]**.
2. Move the ShuttlePoint knob to highlight **DATA** and press **[ENT]**.
3. Connect the BLUE Wire on the GPS chartplotter to the junction of the Brown wire and the VHF wire. The display should look similar to the picture below.

```
NMEA DATA
$LCUTG,134,T,134,M,028.0,N,051.0,K#58
$GPRMC,075438,A,4343.869,N,01020.692,E,1,12,99.00,-15.0,M,49.50,M,1.012#664
$LCGLL,4343.88,N,01020.68,E#7E.0,K#58
$GPRMC,075436,A,4343.880,N,01020.677,E,028.0,134,080900.00,N#5F
$LCUTG,134,T,134,M,028.0,N,051.0,K#58= #
$GPRMC,075436,4343.880,N,01020.677,E,1,12,99.00,-15.0,M,49.50,M,1.012#64
$LCGLL,4343.87,N,01020.69,E#700 ,R@RUV      0
$GPRMC,075438,A,4343.869,N,01020.692,E,028.0,134,080900.00,N#5D
```

Figure 13.7 - NMEA Data page

## 13.8 NMEA DEPTH, WIND SPEED, TEMP AND SOG TREND PAGES

When the GPS chartplotter is connected to the Optional FF520 50/200kHz BLACK BOX FISH FINDER or a Digital Depth Sounder, Wind Speed/Direction, Speed Log with Temp with NMEA output the GPS chartplotter is capable of show Trends in the data from the device.

To select a NMEA Trend Page:

1. Press **[MENU]**. Move the ShuttlePoint knob to highlight **NMEA DISPLAY** and press **[ENT]**.
2. Move the ShuttlePoint knob to select **DEPTH TREND**, **WIND SPEED TREND**, **TEMP TREND** or **SOG TREND** and press **[ENT]**.

## **13.9 VHF DIGITAL SELECTIVE CALLING \***

---

Digital Selective Calling is a semi-automated method of establishing a VHF radio call. DSC had also been designated as part of the Global Maritime Distress and Safety System (GMDSS). It is planned that DSC will eventually replace aural watches on distress frequencies and will be used to announce routine and urgent maritime safety information broadcasts.

This new system allow mariners to instantly send a distress call with GPS position (when connected to the transceiver) to the US Coast Guard and other vessels within range of the transmission. DSC will also allow mariners to initiate POSITION Request, POSITION Send calls to or from another vessel equipped with a DSC transceiver.

The CPV350 is capable of VHF Marine Radios with Digital Selective Calling are able to be interfaced with the GPS chartplotter which feeds GPS data to the VHF and listens for DSC calls from the VHF. By connecting a few wires between the STANDARD HORIZON VHF and the GPS chartplotter it will receive:

1. a vessel that has transmitted a DSC Distress call
2. a vessel that has transmitted a DSC Position Send Call
3. The position of a vessel that transmitted a DSC Position Request Call

### **13.9.0 Position Request**

The CPV350 can transmit a DSC position request call to other equipped vessels with DSC. The position of the polled vessel is show on the chart pages after the call was received. This is a great feature for anyone wanting to know the position of another vessel for example you buddy that is catching fish, or finding the location of a person you are cruising with.

---

# 14. ADVANCED SETTINGS

---

The Advanced Setup menu allows customization of many GPS functions, Alarms and NMEA interfacing.

1. To access this menu press **[MENU]** two times. Move the ShuttlePoint knob to highlight **ADVANCED SETUP** and press **[ENT]** or move the ShuttlePoint knob to the right.



Figure 14 - Advanced Settings Menu

While in this menu you will see many selections which are described in the next sections.

## 14.0 NAVIGATE

The Navigate Menu allows customization of the Coordinate System (Loran TD's), Map Datum, Map Orientation Resolution (angle the vessel has to change before the chart is redrawn) and Static Navigation.

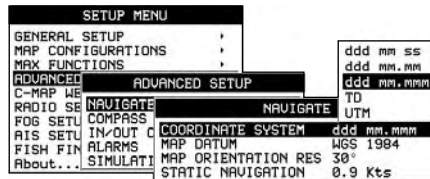

Figure 14.0 - Navigate Menu

- 
- Coordinate System** : Selections are:
- a. TD: Loran TD
  - b. UTM: Universal Transverse Mercator Grid
  - c. ddd mm.mmm: Degrees Minutes and Thousands of Minutes
  - d. ddd mm.mm: Degrees Minutes and Hundredths of Minutes
  - e. ddd mm.ss: Degrees Minutes and Seconds (default)
- 
- Map Datum** : Allows selection of Map Datums. The default Datum is WGS84 as C-MAP cartography has been compiled using the WGS84 Datum.
- 
- Map Orientation Resolution:** Sets the angle the vessel has to change before the chart is redrawn. The default setting is 30 degrees. Example: if the vessel is heading 000T at a speed of 25 Knots, the display will redraw:
- a. In Home mode the GPS chartplotter centers the location of the vessel in the center of the display. To keep the vessel in the center of the display the GPS chartplotter will occasionally redraw.
  - b. If the vessel changes course greater than 330T or more than 30T the chart will be redrawn.
- 
- Static Navigation** : Sets up a threshold for the speed. When the speed received from the positioning device is under that threshold, the GPS chartplotter displays zero. The default setting is 0.9 Kts.
-

The Loran TD selection allows the GPS chartplotter to be set up so the user can enter in LORAN TD's directly into the GPS chartplotter. After the TD's have been entered, and the user changes to ddd mm.sss (Degrees Minutes and Seconds) the TD's will be converted to Lat / Lon coordinates.

To use the TD Coordinate System the user must setup the Chain and Pair information of the TD's. If you do not know this information, refer to paper charts that show the Chain and Pair information.

---

<b>ASF1/2</b>	: <b>Additional Secondary phase Factor (TD Coordinate System)</b> Correction to TD1/2 values which can be inserted by the user.
---------------	--

---

<b>Alter</b>	: <b>Alternate Solution (TD Coordinate System)</b> Parameter selected by the user that is applied in the conversion of TD values to geographical coordinates Lat/Lon. It defines which of the two possible solutions can be used.
--------------	--

---

## 14.1 COMPASS

---

The GPS chartplotter computes compass direction from the constellation of GPS Satellites. For the GPS chartplotter to compute COG (Course Over Ground) direction the vessel must be moving through the water. This menu allows the GPS chartplotter to customize the following selections:

---

<b>Bearings</b>	: Selects between True and Magnetic. When Magnetic bearings is enabled, the GPS chartplotter applies the selected Magnetic Variation (Auto or Manual, see next paragraph) to compute True bearing.
-----------------	--

---

<b>Variation</b>	: Allows the user to select Auto or Manual. When Auto mode is selected the GPS chartplotter computes the offset by the current GPS fixed location. Manual mode allows the user to enter in a magnetic variation that is applied in the True conversion.
------------------	---

---

<b>Calibration</b>	: This function allows a user to enter in the offset for areas that the vessel may cruise instead of entering in a manual offset for one location. This offset is useful for cruising vessels or vessels that travel internationally often.
--------------------	---

---

N	N/E	E	S/E	S	S/W	W	N/W
+01°	+02°	+00°	-01°	-01°	+01°	+03°	+02°

Figure 14.1 - Compass Table

## 14.2 INPUT/OUTPUT (NMEA)

---

The GPS chartplotter has 2 NMEA inputs and 3 NMEA outputs.

## 14.3 ALARMS

---

This menu is used to select and setup audible and visual Alarms. Available alarms are Arrival, XTE, Depth, Anchor and Grounding Alarm.

---

<b>Arrival Alarm</b>	: Alerts when the vessel is approaching a single destination point or when arriving at a leg in a Route. Available selections: 0.00 to 9.99NM.
----------------------	--

---

<b>XTE Alarm</b>	: Alerts when the vessel is deviating from a defined course. Available selections: 0.00 to 9.99NM.
------------------	--

---

<b>Depth Alarm</b>	: Alerts when the received depth Value from the optional FF520 50/200kHz BLACK BOX FISH FINDER or Depth Finder inputting NMEA data into the GPS chartplotter is lower than the selected value. Available selections: 0000 to 3000 FT.
--------------------	---

---

<b>Anchor Alarm</b>	: Alerts when the ships moves off a selected locations by a selected distance. Available selections: 0.00 to 9.99NM.
---------------------	--

---



**Audible Alarm** : Enables or disables the alarm beep.

**Grounding Alarm** : This function looks ahead of the vessels heading to see if a potential danger exists. When the Grounding Alarm is enabled the GPS chartplotter will draw a triangle in front of the vessel on the Chart page showing the area that is being searched as shown below. The depth and range (distance) of the area the GPS chartplotter looks ahead for a shallow area can be set using this function.

---

The following warning appears when the Grounding Alarm is enabled:

### **NOTES**

The Grounding Alarm function only operates with the new NT\*/MAX C-CARDS. It also affects the speed of the redraw of the screen. If this function is not used it may be disabled.

---

When any of the objects checked are found for the first time, the GPS chartplotter shows a pop up window to alert the user of the possible danger. The name of each new dangerous object found is reported in the warning window. In the Grounding Alarm Report page the relative item has a tick marker next to it, to identify the dangerous object currently detected. If in the next search cycle the same objects are found again, the alarm window will not be shown. Instead, if in the next searches the objects found before are no longer detected, their relevant item in the Grounding Alarm Report page is cleared (note that in this case, if the same object type is found again later, the Alarm will be shown). The GPS chartplotter shows an icon on the charts that identifies when a Grounding Alarm is detected.

---

- a. **Ground Alarm Range** : Allows setting the distance of the grounding alarm zone. Available selections are 0.25, 0.5 and 1.0NM. The default selection is 0.25NM. When a depth or a object is found in the scanned zone area a marker is printed in the Grounding Alarm Report Page to identify which dangerous objects have been currently detected.
- b. **Grounding Alarm Report** : Displays a report of dangerous objects found.

---

## 15. AIS

---

AIS is an Automatic Identification System. It has been introduced to improve the safety of navigation by assisting in the efficient operation of ship-to ship, ship reporting and VTS applications. The system should enable operators to obtain information from the ship automatically, requiring a minimum of involvement of ship's personnel, and should have a high level of availability. AIS transponders installed on IMO vessels use VHF frequencies to:

- Transmit details of their own vessel
- Receive details from other vessels or navigation aids within VHF range.

Information being transmitted from vessels over 300 tons that, due to recent worldwide legislation, are required to fit Class "A" AIS transponders.

Connecting to the GPS chartplotter an AIS receiver (please contact your local dealer), vessels with AIS transponder within VHF range are displayed on screen giving the skipper or navigator a visual interpretation of the data of nearby vessels. This improves safety, and specifically for collision avoidance reasons.

---

### 15.0 AIS SYSTEM DEFINITIONS

---

- **Target:** It is a vessel equipped with AIS. Information about the targets is being received by AIS Receiver and displayed on the screen.
- **CPA :** Closest Point of Approach is the closest distance that will be achieved between your vessel and the tracked target, based on your vessel's speed and direction and the target's speed and direction.
- **CPA Limit:** This is the distance from your vessel that a target may reach before a target is deemed a threat.
- **CPA Alarm:** Occurs if CPA is less or equal to CPA Limit. This test is done for active targets only.
- **TCPA:** Time to closest Point of Approach is the time remaining until the CPA will occur.
- **TCPA Limit:** This is the time remaining before the CPA is reached.
- **TCPA Alarm:** Occurs if TCPA is less or equal to TCPA Limit. This test is done for active targets only and if CPA value is less or equal to CPA Limit.
- **Radio Call Sign:** International call sign assigned to vessel, often used on voice radio.
- **Name:** Name of ship, 20 characters.
- **MMSI:** Maritime Mobile Service Identity.
- **MMSI number:** A unique 9 digit number that is assigned to a DSC radio station. It primarily registers the boat information in the U.S. Coast Guard's national distress database for use in emergency situations.
- **Active Target:** Target located within the Activation Range. Active target is represented by oriented triangle with COG and Heading vectors. Rate of turn may also be displayed.

- ♦ **Dangerous Target:** Target detected by CPA or TCPA Alarm. Dangerous target is Active Target by definition. For better visibility Dangerous Target symbol is flashing.
- ♦ **Sleeping Target:** Target located outside the Activation Range. Sleeping target is represented by a small oriented triangle.
- ♦ **Lost Target:** When the AIS info is not received from that vessel for 3.5 minutes. The presentation will be a flashing black triangle with a cross through.
- ♦ **Activation Range:** Range around your boat where targets become active. AIS target become active within this range. Activation Range should be greater than CPA Limit by definition.

#### **NOTE**

---

A target is removed from the screen if data is not received for 10 minutes.  
The maximum number of tracked targets is 100.

Depending on the scale the presentation of the targets change to remove clutter on the screen. This information is updated every 3 seconds to 6 minutes depending on speed and rate of turn, enabling the track of the vessels in range to be plotted.

---

## **15.1 AIS MENU**

To configure the GPS chartplotter to receive AIS data, follow the procedure:

1. Press **[MENU]** two times. Move the ShuttlePoint knob to highlight **AIS MENU** and press **[ENT]** or move the ShuttlePoint knob to the right. The new AIS menu appears on the screen. The available functions are described in the following table.

<b>Display</b>	: Turns the display of AIS Targets overlay on the cartography On or Off. The default setting is On.
<b>Activation Range</b>	: Defines the range from the fix within which the AIS Target becomes active. The values allowed are from 0.1 to 20 Nm. The default setting is 5 Nm.
<b>CPA Alarm</b>	: Turns On or Off the alarm. The default setting is On.
<b>CPA Limit</b>	: The values allowed are from 0.1 to 10 Nm. The default setting is 0.5 Nm.
<b>TCPA Alarm</b>	: Turns On or Off the alarm. The default setting is On.
<b>TCPA Limit</b>	: The values allowed are from 1 to 30 Min. The default setting is 10 Min.

## **15.2 TO SET THE CHARTPLOTTER FOR RECEIVING AIS**

Make sure the AIS receiver is properly connected to the GPS chartplotter. The GPS chartplotter reads the AIS NMEA message VMD, type 1, 2, 3 and 5. Select the used serial port and transmission speed by following the procedure:

1. To access this menu press **[MENU]** two times. Move the ShuttlePoint knob to highlight **ADVANCED SETUP** and press **[ENT]** or move the ShuttlePoint knob to the right.
2. Move the ShuttlePoint knob to highlight **IN/OUT CONNECTIONS** and press **[ENT]** or move the ShuttlePoint knob to the right.
3. Move the ShuttlePoint knob to highlight **PORT n INPUT** and press **[ENT]** or move the ShuttlePoint knob to the right.
4. Move the ShuttlePoint knob to highlight **m** and press **[ENT]** or move the ShuttlePoint knob to the right.

Where:

n = Port 1/Port 2/Port 3/Port 4/Port 5

m = NMEA-0183 4800-N81-N, NMEA-0183 38400-N82-N according to the transmission speed of your AIS receiver.

## 15.3 QUICK INFO ON AIS TARGET

---

By placing the cursor over a AIS Target icon, the following information is displayed:

- **Vessel Name**
- **MMSI number**
- **Radio Call Sign**
- **SOG**
- **COG**
- **CPA and TCPA values**

### **NOTE**

---

The selected AIS Target icon is surrounded by a square frame when user places the cursor over the icon.

---

---

## 16. C-MAP WEATHER SERVICE

---

### NOTE

Check with C-Map USA for the operation of C-Map Weather service by calling 508.477.8010

---

C-MAP Weather Service is an innovative meteorological forecasting system with the ability to visualize the weather forecast, overlaying it on cartography. The weather data is held on C-MAP's weather server, which can be accessed via a C-COM modem connected to the chartplotter or by using the C-MAP personal Suite (or the DPS - Dealer Programming System) saving the weather data on a User C-CARD. The weather data are overlaid on a map page as layers. The Weather format data available are:









Data Type	Display
WIND (Speed & Dir)	- 0 
WAVE Height & Dir	- 1 
TEMPERATURE (C°)	18°
HUMIDITY (%)	30
VISIBILITY (m)	20
WEATHER TYPE: Sun	
WEATHER TYPE: Rain	
WEATHER TYPE: Fog	
WEATHER TYPE: Snow	
WEATHER TYPE: Clouds	
WEATHER TYPE: Partly Cloudy	
WEATHER TYPE: Thunderstorm	

Figure 16 - Weather data package

---

### 16.0 C-WEATHER SERVICE MENU

---

To select the menu:

1. Press **[MENU]** two times. Move the ShuttlePoint knob to highlight **C-MAP WEATHER SERVICE** and press **[ENT]** or move the ShuttlePoint knob to the right.

The C-Weather menu is shown on the screen, the items are described in the following paragraphs.

#### 16.0.0 Download

Allows to connect the software to the C-MAP weather server and to download C-MAP weather data directly via C-COM.

---

**Select Country To Call** : Allows the selection of the country to call. The whole telephone number set is automatically updated after every download.

---

**SIM Pin** : Allows inserting of the Pin of the SIM.

---

**Download Area** : Allows the weather download: a squared grey area, where the weather data will be downloaded, is centered on cursor position. See the following picture.

---

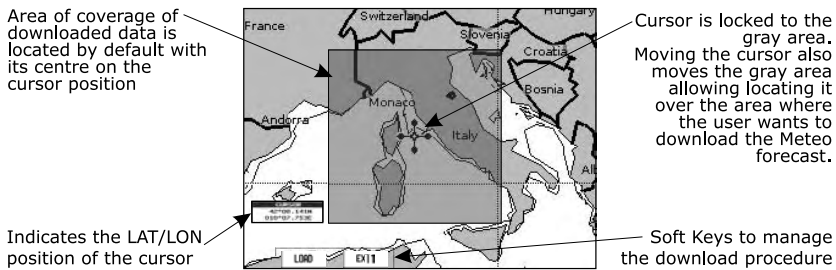

Figure 16.0.0 - Download Area

Press **[LOAD]** to activate the C-Weather Download: the whole data package (see the previous "Weather data package" table) are downloaded. **[STOP]** allows to interrupt the data download. At the end of the operation press **[EXIT]** to close the window.

### 16.0.1 Copy From User C-CARD

Allows the whole data package C-Weather loading from the User C-CARD.

### 16.0.2 Weather Forecast

Allows selecting the Layer of specific weather data to be displayed on the screen and to change date and time of the forecast preview. The following functions are available:

- **Panning:** default usage of the cursor key is the normal panning function.
- **Zoom in/out:** zoom in/out functions are allowed as usual by using **[ZOOM]**.
- **Set of date and time:** **[DATE]** to modify date and time values.
- **Layer selection:** **[LAYER]** to cycle of the weather layers.
- **Exit:** **[EXIT]** to close the weather prediction page.

### 16.0.3 Real Time View

The following selections are available:

- **Real Time View On:** the data is shown (the area of the download) at the current date and time (received from the GPS).
- **Real Time View Off:** the Weather data is not displayed.

The layer displayed is the one selected into the previous menu item.

---

## 17. RADIO CONTROLS AND INDICATORS

---

### NOTE

This section defines each control for the transceiver section of the CPV350. For detailed operating instructions refer to section "18. BASIC OPERATION."

---

### 17.0 CONTROLS AND KEYS

---



#### The ShuttlePoint knob

The ShuttlePoint Knob controls the Up/Down and Left/Right movement of the cursor, and is also used to select options for Menu operation.

#### The MENU key

Pressing **[MENU]** one time selects the Main Menu. When in menu mode, move the ShuttlePoint up or down to highlight a selection and press the **[ENT]** key to select the function.

Pressing **[MENU]** two times selects the Setup Menu.

#### The ENT key

Press **[ENT]** to select the desired menu function or to confirm selection.

#### The CLR key

Press **[CLR]** to exit from menu or data windows or to leave a menu without making changes, to abort selected function or to step backward from a selection made in the menu.

#### The Channel knob

The rotary knob is used to select operating channels and to choose menu items.

#### Secondary use

When the **[ZOOM]** key is pressed a zoom icon will be shown on the left corner of the display. Turning the rotary knob clockwise zooms the chart plotter into a lower scale and counter clockwise to a higher scale.

### **The VOL (Volume) knob**

Adjusting [VOL] knob controls the VHF audio volume level.

### **The SQL (Squelch) knob**

Adjusting [SQL] clockwise, sets the point at which random noise on the channel does not activate the audio circuits but a received signal does. This point is called the squelch threshold. Further adjustment of the squelch control will degrade reception of wanted transmissions.

### **The 16/9 key**

Immediately recalls channel 16 from any channel location. Holding down this key recalls channel 9. Pressing [16/9] again reverts to the previous selected working channel.

#### **Secondary use**

Press and hold [16/9] then press [WX] to changes from USA, International, and Canadian channel groups.

### **The WX key**

Immediately recalls the previously selected NOAA weather channel from any channel.

#### **Secondary use**

Holding down [16/9] while pressing [WX] changes from USA, International and Canadian channel groups.

### **The DW key**

Pressing this key enables dual watch between a priority channel (Ch16 is the default) and a selected channel until a signal is received. When a signal is received on the selected channel the radio will momentarily switch to the Priority channel and listen for communications. Refer to section "18.10 DUAL WATCH (TO PRIORITY CHANNEL)" for details.

### **The SCAN/MEM key**

Press [SCAN/MEM] to start and stop the scanning of programmed channels. Refer to section "18.11 SCANNING" for details.

#### **Secondary use**

To memorized a channel into scan memory, select the channel and press and hold [SCAN/MEM] until "MEM" is shown in the "VHF Radio" window on the display.

To delete a memorized channel from scan memory, select the channel and press and hold [SCAN/MEM] until "MEM" is removed from the display.

### **The H/L key**

Press [H/L] to toggle the transmit output power between 25 W (High) and 1 W (Low) power. When [H/L] is pressed while the transceiver is on channel 13 or 67, the power will temporarily switch from LO to HI power until [PTT] is released.

[H/L] does not function on transmit inhibited and low power only channels.

---

#### **NOTE**

1W low power is indicated by "LO" on the display, when 25W high power is selected the display shows "HI" on the display.

---

### **The CALL key**

Press [CALL] to access the DSC OPERATION menu. "INDIVIDUAL CALL," "GROUP CALL," "ALL SHIPS CALL," "POSITION REQUEST," "POSITION SEND," "DSC STANDBY," and "DSC LOG" functions can be accessed from the Soft keys located underneath the display

---

#### **NOTE**

To use DSC functions a MMSI must be entered. Refer to section "19.1 MARITIME MOBILE SERVICE IDENTITY (MMSI)."

---



### The DISTRESS key

Used to send a DSC Distress Call. To send the distress call refer to section “19.2.0 Transmitting A DSC Distress Call.”

### The Soft keys (located underneath the display)

These keys are used for selection of a variety of function.

The actual selection available is shown on the display, just above the function key.

### The PWR key and Lamp/Contrast

Press and hold [PWR] to turn the CPV350 On or Off.

### Secondary use

Once on press [PWR] to show the Contrast and Lamp popup window. To adjust, move the ShuttlePoint knob left/right to adjust the backlight and up and down to adjust the displays contrast. To store the settings press the [ENT] key.

### The Microphone jack

Connects the CPV350 to the supplied Hand Microphone.

## 17.1 RECEIVER AUDIO TONE CONTROL

Allows the treble and bass of the speaker audio to be adjusted for best listening in noisy environments. The effect is similar to adjusting a the treble and bass controls on a stereo.

1. Press [MENU] two times. Move the ShuttlePoint knob to highlight **RADIO SETUP** and press [ENT] or move the ShuttlePoint knob to the right.
2. Move the ShuttlePoint knob to highlight **VHF SETTING** and press [ENT] or move the ShuttlePoint knob to the right.
3. Move the ShuttlePoint knob to highlight **AF SETUP** and press [ENT] or move the ShuttlePoint knob to the right.
4. Move the ShuttlePoint knob to highlight **TREBLE** and press [ENT] or move the ShuttlePoint knob to the right.
5. Move the ShuttlePoint knob up or down to select desired audio response in the higher frequency range. Available selections are **-6** through **+6**.
6. Press [ENT] to store the selected setting.
7. Move the ShuttlePoint knob to highlight **BASS** and press [ENT] or move the ShuttlePoint knob to the right.
8. Move the ShuttlePoint knob up or down to select desired audio response in the lower frequency range. Available selections are **-6** through **+6**.
9. Press [ENT] to store the selected setting.
10. Press [CLR] until the menu disappears or an easier method is to move the ShuttlePoint knob to the left a few times.



Figure 17.1 - AF Setup menu

---

# 18. BASIC RADIO OPERATION

---

## 18.0 RECEPTION

---

1. After the transceiver has been installed, ensure that the power supply and antenna are properly connected.
2. Press and hold **[PWR]** until the display shows the start-up page.
3. Turn **[SQL]** counterclockwise until the “**BUSY**” appears in the “VHF Radio” window on the display.
4. Turn up **[VOL]** until noise or audio from the speaker is at a comfortable level.
5. Turn **[SQL]** clockwise until the random noise disappears. This state is known as the “Squelch threshold.”
6. Turn the Channel knob to select the desired channel. Refer to the channel chart on page 129 for available channels.
7. When a message is received, adjust the volume to the desired listening level. “**BUSY**” is displayed indicating that the channel is being used.

## 18.1 TRANSMISSION

---

1. Perform steps 1 through 6 of section “18.0 RECEPTION.”
2. Before transmitting, monitor the channel to ensure it is clear.  
**THIS IS AN FCC REQUIREMENT!**
3. Press **[PTT]** on the microphone. “TX” indicator will appear in the “VHF Radio” window on the display.
4. Speak slowly and clearly into the microphone.
5. When the transmission is finished, release **[PTT]**.

### NOTE

The CPV350 is supplied with a noise-canceling microphone. The oval slot labeled “MIC” should be positioned within 1/2 inch (1.3 cm) from the mouth for optimum performance.

---

## 18.2 TRANSMIT TIME-OUT TIMER (TOT)

---

When **[PTT]** on the microphone is held down, transmit time is limited to 5 minutes. This limits unintentional transmissions due to a stuck microphone. About 10 seconds before automatic transmitter shutdown, a warning beep will be heard from the speaker(s). The transceiver will automatically go to receive mode, even if **[PTT]** is continually held down. Before transmitting again, **[PTT]** must first be released and then pressed again.

## 18.3 SIMPLEX/DUPLEX CHANNEL USE

---

Refer to the VHF MARINE CHANNEL CHART (page 129) for instructions on use of simplex and duplex channels.

### NOTE

All channels are factory-programmed in accordance with International, Industry Canada (Canada), and FCC (USA) regulations. Mode of operation cannot be altered from simplex to duplex or vice-versa.

---

## 18.4 INTERNATIONAL, USA, AND CANADA MODE

---

1. To change the modes, hold [16/9] and press [WX]. The mode changes from International to Canadian to USA with each press of [WX].
2. "INTL" will be displayed in the "VHF Radio" window on the display for International mode, "CAN" will be displayed for Canadian mode, and "USA" will be displayed on the LCD for USA mode.
3. Refer to the VHF MARINE CHANNEL CHART (page 129) for allocated channels in each mode.

## 18.5 NOAA WEATHER CHANNELS

---

### NOTE

NOAA Weather channels are available in the waters of USA and Canada only.

---

1. To receive a NOAA weather channel, press [WX] from any channel. The CPV350 will go to the last selected weather channel.
2. Turn the Channel knob on the radio or [UP(▲)] / [DOWN(▼)] on the microphone to select a different NOAA weather channel.
3. To exit from the NOAA weather channels, press [WX]. The transceiver returns to the channel it was on prior to a weather channel.

### 18.5.1 NOAA Weather Alert

In the event of extreme weather disturbances, such as storms and hurricanes, the NOAA (National Oceanic and Atmospheric Administration) sends a weather alert accompanied by a 1050 Hz tone and subsequent weather report on one of the NOAA weather channels. When the Weather Alert feature is enabled (see section "18.5.3 Customizing Weather Alert," the transceiver is capable of receiving this alert if the following is performed:

1. Program NOAA weather channels into the transceiver's memory for scanning. Follow the same procedure as for regular channels under section "18.11 SCANNING."
2. Press [SCAN/MEM] once to start memory scanning or priority scanning (determined from the "18.11.0 Selecting the Scan Type" section, see page 96 for details).
3. The programmed NOAA weather channels will be scanned along with the regular-programmed channels. However, scanning will not stop on a normal weather broadcast unless a NOAA alert is received.
4. When an alert is received on a NOAA weather channel, scanning will stop and the transceiver will emit a loud beep to alert the user of a NOAA broadcast.
5. Press [WX] to stop the alert tone and receive the weather report.

### NOTE

If [WX] is not pressed the alert tone will be emitted for 5 minutes and then the weather report will be received.

---

### NOTE

The Weather Alert feature is also engaged while the transceiver is receiving on one of the NOAA weather channels.

---

## 18.5.2 NOAA Weather Alert Test

NOAA tests the alert system every Wednesday between 11AM and 1PM. To test the CPV350's NOAA Weather alert feature, on Wednesday between 11AM and 1PM, setup as in previous section and confirm the alert is heard.

## 18.5.3 Customizing NOAA Weather Alert

This menu selection allows you to customize the NOAA Weather alert function. Default setting is On.

1. Press **[MENU]** two times. Move the ShuttlePoint knob to highlight **RADIO SETUP** and press **[ENT]** or move the ShuttlePoint knob to the right.
2. Move the ShuttlePoint knob to highlight **VHF SETTINGS** and press **[ENT]** or move the ShuttlePoint knob to the right.
3. Move the ShuttlePoint knob to highlight **WX ALERT** and press **[ENT]** or move the ShuttlePoint knob to the right.
4. Move the ShuttlePoint knob to select the desired WX alert mode. The WX alert mode can be set to:
  - On SCAN** – the CPV350 will only alert when in scan mode
  - On WX** – the alert will only sound if the radio is on a receiving weather channel
  - On SCAN/WX** – the CPV350 will only alert when a receiving channel is programmed and scanned.
  - Off** – disables the Weather alert function
5. Press **[ENT]** or move the ShuttlePoint to the right to store the selected setting.
6. Press **[CLR]** until the menu disappears or an easier method is to move the ShuttlePoint knob to the left a few times.

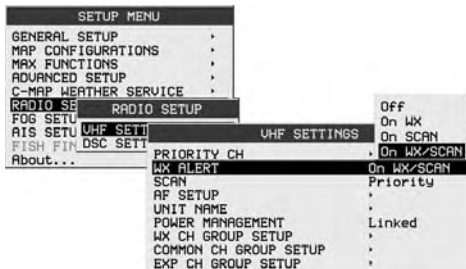

Figure 18.5.3 - WX ALERT menu

## 18.6 EMERGENCY CHANNEL (CHANNEL 16 USE)

Channel 16 is known as the Hail and Distress Channel. An emergency is defined as a threat to life or property. In such instances, be sure the transceiver is on and set to CHANNEL 16. Then use the following procedure:

1. Press the microphone push-to-talk switch and say "Mayday, Mayday, Mayday. This is \_\_\_\_\_, \_\_\_\_\_, \_\_\_\_\_" (your vessel's name).
2. Then repeat once: "Mayday, \_\_\_\_\_" (your vessel's name).
3. Now report your position in latitude/longitude, or by giving a true or magnetic bearing

- (state which) to a well-known landmark such as a navigation aid or geographic feature such as an island or harbor entry.
4. Explain the nature of your distress (sinking, collision, aground, fire, heart attack, life-threatening injury, etc.).
  5. State the kind of assistance your desire (pumps, medical aid, etc.).
  6. Report the number of persons aboard and condition of any injured.
  7. Estimate the present seaworthiness and condition of your vessel.
  8. Give your vessel's description: length, design (power or sail), color and other distinguishing marks. The total transmission should not exceed 1 minute.
  9. End the message by saying "OVER." Release the microphone button and listen.
  10. If there is no answer, repeat the above procedure. If there is still no response, try another channel.

## **18.7 CALLING ANOTHER VESSEL (CHANNEL 16 OR 9)**

---

Channel 16 may be used for initial contact (hailing) with another vessel.

However, its most important use is for emergency and distress messages. This channel must be monitored at all times except when actually using another channel.

It is monitored by the U.S. and Canadian Coast Guards and by other vessels. Use of channel 16 for hailing must be limited to initial contact only. Calling should not exceed 30 seconds, but may be repeated 3 times at 2-minute intervals. In areas of heavy radio traffic, congestion on channel 16 resulting from its use as a hailing channel can be reduced significantly in U.S. waters by using channel 9 as the initial contact (hailing) channel for non-emergency communications. Here, also, calling time should not exceed 30 seconds but may be repeated 3 times at 2-minute intervals.

Prior to making contact with another vessel, refer to the channel charts in this manual, and select an appropriate channel for communications after initial contact. For example, Channels 68 and 69 are some of the channels available to non-commercial (recreational) boaters. Monitor your desired channel in advance to make sure you will not be interrupting other traffic, and then go back to either channel 16 or 9 for your initial contact.

When the hailing channel (16 or 9) is clear, state the name of the other vessel you wish to call and then "This is" followed by the name of your vessel and your Station License (Call Sign). When the other vessel returns your call, immediately request another channel by saying "Go to," the number of the other channel, and "Over." Then switch to the new channel. When the new channel is not busy, call the other vessel.

After a transmission, say "Over," and release the microphone's push-to-talk (PTT) switch. When all communication with the other vessel is completed, end the last transmission by stating your Call Sign and the word "Out." Note that it is not necessary to state your Call Sign with each transmission, only at the beginning and end of the contact.

Remember to return to Channel 16 when not using another channel. Some radios automatically monitor Channel 16 even when set to other channels or when scanning.

## **18.8 MAKING TELEPHONE CALLS**

---

To make a radiotelephone call, use a channel designated for this purpose. The fastest way to learn which channels are used for radiotelephone traffic is to ask at a local marina. Channels available for such traffic are designated Public Correspondence channels on the channel charts in this manual. Some examples for USA use are Channels 24, 25, 26, 27,

28, 84, 85, 86, and 87. Call the marine operator and identify yourself by your vessel's name, The marine operator will then ask you how you will pay for the call (telephone credit card, collect, etc.) and then link your radio transmission to the telephone lines. The marine telephone company managing the VHF channel you are using may charge a link-up fee in addition to the cost of the call.

## 18.9 OPERATING ON CHANNELS 13 AND 67

---

Channel 13 is used at docks and bridges and by vessels maneuvering in port. Messages on this channel must concern navigation only, such as meeting and passing in restricted waters.

Channel 67 is used for navigational traffic between vessels.

By regulation, power is normally limited to 1 Watt on these channels. Your radio is programmed to automatically reduce power to this limit on these channels. However, in certain situations it may be necessary to temporarily use a higher power. See page 89 ([H/L] key) for means to temporarily override the low-power limit on these two channels.

## 18.10 DUAL WATCH (TO PRIORITY CHANNEL)

---

Dual watch allows the radio to monitor one channel and the assigned Priority channel. By default the priority channel is set to 16, however the priority channel may be changed by referring to section "18.11.3 Priority Channel Set."

1. Adjust [SQL] until the background noise disappears.
2. Select the channel you wish to dual watch to "Priority channel" by rotating the channel knob.
3. Press [DW].
4. The CPV350 will scan between Priority channel and the channel that was selected in step 2.
5. If a transmission is received on the channel selected in step 2, the CPV350 will dual watch between the working channel and the Priority channel.
6. To stop Dual Watch, press [DW] again.



## 18.11 SCANNING

---

Allows the user to select the scan type from Memory scan or Priority scan. "Memory scan" scans the channels that were programmed into memory. "Priority scan" scans the channels programmed in memory with the priority channel.

### 18.11.0 Selecting the Scan Type

1. Press [MENU] two times. Move the ShuttlePoint knob to highlight **RADIO SETUP** and press [ENT] or move the ShuttlePoint knob to the right.
2. Move the ShuttlePoint knob to highlight **VHF SETTINGS** and press [ENT] or move the ShuttlePoint knob to the right.
3. Move the ShuttlePoint knob to highlight **SCAN** and press [ENT] or move the ShuttlePoint knob to the right.
4. Another popup window will be shown with **Priority** and **Memory**, move the ShuttlePoint

- knob to the desired selection and press **[ENT]** or move the ShuttlePoint knob to the right.
- Press **[CLR]** until the menu disappears or an easier method is to move the ShuttlePoint knob to the left a few times.

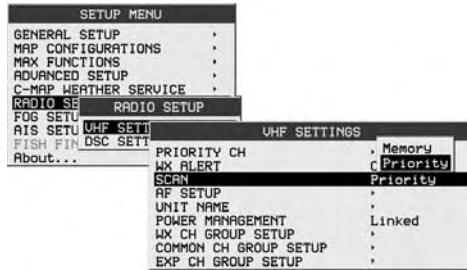

Figure 18.11.0 - SCAN menu

### 18.11.1 Memory Scanning (M-SCAN)

By default the CPV350 is set to P-Scan. To change to MEM scan follow steps in “18.11.0 Selecting the Scan Type.”

- Adjust **[SQL]** until background noise disappears.
- Select a desired channel to be scanned by rotating the channel knob. Press and hold **[SCAN/MEM]** for one second, “**MEM**” will appear in the “VHF Radio” window on the display which indicates the channel has been programmed into the CPV350’s memory.
- Repeat step 2 for all the desired channels to be scanned.
- To DELETE a channel from the CPV350’s memory, select the channel then press and hold **[SCAN/MEM]** for one second, “**MEM**” will disappear in the display.
- To start scanning, just press **[SCAN/MEM]** momentarily. “**M-SCAN**” appears in the “VHF Radio” window on the display. Scanning will proceed from the lowest to the highest programmed channel number and will stop on a channel when a transmission is received.
- The channel number will blink during reception.
- To stop scanning, press **[16/9]** or **[WX]**.



### 18.11.2 Priority Scanning (P-SCAN)

In the default setting, Channel 16 is set as the priority channel. You may change the priority channel to the desired channel from the Channel 16 by the Radio Setup Mode, refer to the next section “18.11.3 Priority Channel Set.”

- Adjust **[SQL]** until background noise disappears.
- Select a desired channel to be scanned by rotating the channel knob. Press and hold **[SCAN/MEM]** for one second, “**MEM**” will appear in the “VHF Radio” window on the display which indicates the channel has been programmed into the CPV350’s memory.
- Repeat step 2 for all the desired channels to be scanned.
- To DELETE a channel from the CPV350’s memory, select the channel then press and hold **[SCAN/MEM]** until “**MEM**” is removed from the display.



- To start priority scanning, press **[SCAN/MEM]** momentarily. “**P-SCAN**” appears in the “VHF Radio” window on the display. Scanning will proceed between the memorized channels and the priority channel. The priority channel will be scanned after each programmed channel.
- To stop scanning, press **[16/9]** or **[WX]**.



### 18.11.3 Priority Channel Set

- Press **[MENU]** two times. Move the ShuttlePoint knob to highlight **RADIO SETUP** and press **[ENT]** or move the ShuttlePoint knob to the right.
- Move the ShuttlePoint knob to highlight **VHF SETTINGS** and press **[ENT]** or move the ShuttlePoint knob to the right.
- Move the ShuttlePoint knob to highlight **PRIORITY CHANNEL SET** and press **[ENT]** or move the ShuttlePoint knob to the right.
- Move the ShuttlePoint knob to select **USA**, **INTL**, or **CAN**, and press **[ENT]** or move the ShuttlePoint knob to the right.
- Move the ShuttlePoint knob to select the channel to be a priority.
- Press **[ENT]** to store the selected setting.
- Press **[CLR]** until the menu disappears or an easier method is to move the ShuttlePoint knob to the left a few times.

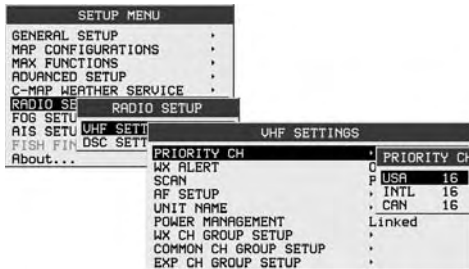

Figure 18.11.3 - PRIORITY CH menu



## 18.12 PA/FOG OPERATION

PA/FOG mode allows the CPV350 to be used as a 30W hailer when an optional STANDARD HORIZON 220SW or 240SW PA horn speaker is installed. When in Hail or FOG mode the PA speaker Listen's Back (acts as a microphone and amplifies sound to the front panel speaker) through the PA horn speaker providing two-way communications through the PA horn speaker.

### NOTE

When in PA or FOG mode the CPV350 will receive on the last selected VHF channel before entering into the PA or FOG mode and receive DSC calls.

**PA HAIL mode:** PA HAIL mode allows the transceiver to be used as a power hailer when an optional STANDARD HORIZON 220SW or 240 SW HAIL/PA speaker is installed. The Hail mode has a listen-back feature providing two way communication through the HAIL/PA speaker.

**FOG HORN mode:** Automatic signaling is transmitted through the HAIL/PA horn.

### 18.12.0 Operating the PA HAIL mode

1. Press **[MENU]**. Move the ShuttlePoint knob to highlight **Public Address** and press **[ENT]**.
2. Press **[PTT]** on the microphone to speak through the HAIL/PA speaker.
3. With the **[PTT]** pressed, rotate the Channel knob to control the PA Volume level. The AF output level can be set from 0 to 30 watts.
4. To exit the PA HAIL mode, press **[MENU]** and move the ShuttlePoint knob to highlight **Exit Public Address**, then press **[ENT]**.
5. To adjust the listen back volume, rotate the Channel knob when the **[PTT]** is not pressed.



### 18.12.1 Operating the FOG HORN mode

Operator can select from "Underway," "Stop," "Sail," "Tow," "Aground," "Anchor," "Horn," or "Siren." Please refer to next page for FOG Horn Timing Chart.

1. Press **[MENU]**. Move the ShuttlePoint knob to highlight **Fog Horn** and press **[ENT]**.
2. A "Fog Horn" popup window will be displayed, move the ShuttlePoint knob up or down, or turn the Channel knob to select the one of the eight functions from the window.
3. Press **[ENT]**.
4. On the **Horn** and **Siren** modes, press **[PTT]** on the microphone to activate the fog signal through the HAIL/PA horn and turn the Channel knob while the **[PTT]** is pressed to control the volume of the horn or siren.
5. Rotate the Channel knob to control the AF output level. The AF output level can be set from 0 to 30 watts.
6. To exit the FOG HORN mode, press **[MENU]** and move the ShuttlePoint knob to highlight **Exit Fog Horn**, then press **[ENT]**.
7. To adjust the listen back volume, rotate the Channel knob when the **[PTT]** is not pressed.



## FOG HORN TIMING CHART

The fog horn function sounds a horn repeatedly until the function is turned off.

TYPE	PATTERN	USAGE
UNDERWAY	<p>One 5-second blasts every 120 seconds.</p>	Motor vessel underway and making way.
STOP	<p>Two 5-second blasts (separated by 2 seconds) every 120 seconds.</p>	Motor vessel underway but stopped (not making way).
SAIL	<p>One 5-second blasts followed by two 1-second blasts (separated by 2 seconds) every 120 seconds.</p>	Sailing vessel underway, fishing vessel (underway or anchored), vessel not under command, a vessel restricted in her ability to maneuver (underway or at anchor), or a vessel towing or pushing another ahead.
TOW	<p>One 5-second blasts followed by three 1-second blasts (separated by 2 seconds) every 120 seconds.</p>	Vessel under tow (manned).
AGROUND	<p>One 11-second rings every 60 seconds.</p>	Vessel is aground.
ANCHOR	<p>One 5-second rings every 60 seconds.</p>	Vessel is at anchor.

## 18.12.2 FOG ALERT TONE Frequency

Allows selection of the Frequency for the FOG horn signal. Available selections are “200 Hz” through “850 Hz” in 50 Hz steps. The default Alert Tone Frequency is 400 Hz.

1. Press **[MENU]** two times. Move the ShuttlePoint knob to highlight **FOG SETUP** and press **[ENT]** or move the ShuttlePoint knob to the right.
2. Press **[ENT]** or move the ShuttlePoint knob to the right again, move the ShuttlePoint knob up or down to select the “100 Hz” digits of the desired tone frequency (“2” through “8”).
3. Move the ShuttlePoint knob to the right, then move the ShuttlePoint knob up or down to select the “10 Hz” digits of the desired tone frequency (“0” or “5”).
4. Press **[ENT]** to store the selected setting.
5. Press **[CLR]** until the menu disappears or an easier method is to move the ShuttlePoint knob to the left a few times.

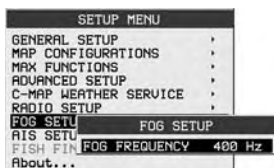
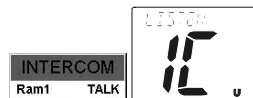
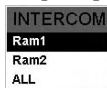

Figure 18.11.3 - PRIORITY CH menu

## 18.13 INTERCOM OPERATION

Connecting a CMP25 RAM+ or VH-310 handset to the CPV350 allows intercom communications. Refer to section “21.2 INTERCOM OPERATION” for CMP25 RAM+ Microphone or section “22.2 INTERCOM OPERATION” for VH-310 Handset.

1. Press **[MENU]**. Move the ShuttlePoint knob to highlight **Intercom** then press **[ENT]**.
2. If your CPV350 is equipped with two CMP25 RAM+ Mic's (or VH-310 Handset), “INTERCOM” popup window appears on the display, select the station you wish to communicate (Ram1, Ram2, or ALL) with the ShuttlePoint knob, then press **[ENT]**.
3. When the “INTERCOM” is activated, a “INTERCOM” popup window is displayed on the CPV350, and “IC” is displayed on the CMP25 RAM+ Mic or VH-310 Handset.
4. Press **[PTT]**. “Talk” will be shown on the display.  
**NOTE:** A warning beep will be emitted when the CPV350 microphone's **[PTT]** is pressed while the RAM+ Mic's or VH-310 Handset's **[PTT]** is pressed.
5. Speak slowly and clearly into the microphone, hold the microphone about 1/2 inch (1.3 cm) away from your mouth.
6. When finished, release **[PTT]**.
7. To exit the “INTERCOM” mode and return to radio operation mode, press **[MENU]** and move the ShuttlePoint knob to highlight **Exit Intercom**, then press **[ENT]**.



(CPV350's PTT switch is pressed)

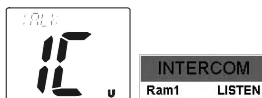

(Second Station Mic's PTT switch is pressed)

## 18.14 VOICE SCRAMBLER

If privacy of communications is desired, a CVS2500 voice scrambler (VS) can be installed in the transceiver. Contact your Dealer to have a CVS2500 installed.

### 18.14.0 Setting Up the Voice Scrambler

1. Press **[MENU]** two times. Move the ShuttlePoint knob to highlight **RADIO SETUP** and press **[ENT]** or move the ShuttlePoint knob to the right.
2. Move the ShuttlePoint knob to highlight **VHF SETTING** and press **[ENT]** or move the ShuttlePoint knob to the right.
3. Move the ShuttlePoint knob to highlight **COMMON CHANNEL SETUP** and press **[ENT]** or move the ShuttlePoint knob to the right.
4. Move the ShuttlePoint knob to select the channel group (**USA**, **INTL**, or **CAN**) you wish to setup the Voice Scrambler and press **[ENT]** or move the ShuttlePoint knob to the right.
5. Move the ShuttlePoint knob to highlight **CH NO.** and press **[ENT]** or move the ShuttlePoint knob to the right.
6. Move the ShuttlePoint knob to select the operating channel you wish to setup the Voice Scrambler and press **[ENT]**.
7. Move the ShuttlePoint knob to highlight **SCRAMBLER** and press **[ENT]** or move the ShuttlePoint knob to the right.
8. Another popup window will be shown with **On** and **Off**, move the ShuttlePoint knob to select **On** and press **[ENT]** or move the ShuttlePoint knob to the right.
9. Move the ShuttlePoint knob to highlight **SCRAMBLER CODE** and press **[ENT]** or move the ShuttlePoint knob to the right.
10. Move the ShuttlePoint knob to select the desired Scramble Code. The Scramble Code can be select to **0**, **1**, **2**, or **3**.
11. To setup the Voice Scramble to another operating channel, repeat steps 5 through 10.
12. Press **[CLR]** until the menu disappears or an easier method is to move the ShuttlePoint knob to the left a few times.

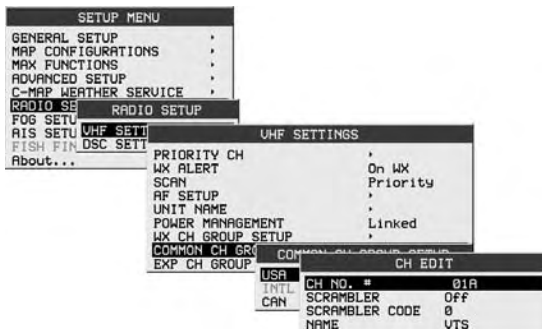

Figure 18.14.0 - CH EDIT menu

### 18.14.1 Voice Scramble Operation

1. Turn on the transceiver.
2. Select a channel that was programmed for scrambler mode (“**VS**” will appear in the “VHF Radio” window on the display).
3. If a channel is not set for the voice scrambler, the display will be as shown in the illustration at the right (“**VS**” will disappear from the display).
4. If a voice scrambler is canceled temporarily in the “SETUP” menu, the display will be as shown in the illustration at the right.
5. Monitor the channel before transmitting.
6. Transmit the voice message. The signal sent will be scrambled.

---

# 19. DIGITAL SELECTIVE CALLING

---

## 19.0 GENERAL

---

### WARNING

This radio is designed to generate a digital maritime distress and safety call to facilitate search and rescue. To be effective as a safety device, this equipment must be used only within communication range of a shore-based VHF marine channel 70 distress and safety watch system. The range of signal may vary but under normal conditions should be approximately 20 nautical miles.

### NOTE

A DSC Warning sticker is included with the CPV350. To comply with FCC regulations this sticker must be mounted in a location that can be easily viewed from the location of the CPV350. Make sure the chosen location is clean and dry before applying the sticker.

Digital Selective Calling is a semi-automated method of establishing a radio call, it has been designated by the International Maritime Organization (IMO) as an international standard for establishing VHF, MF, and HF radio calls. It has also been designated as part of the Global Maritime Distress and Safety System (GMDSS). It is planned that DSC will eventually replace aural watches on distress frequencies and will be used to announce routine and urgent maritime safety information broadcasts.

This system allows mariners to instantly send a distress call with GPS position (when connected to the transceiver) to the Coast Guard and other vessels within range of the transmission. DSC will also allow mariners to initiate or receive Distress, Urgency, Safety, Routine, POSITION REQUEST, POSITION SEND, and Group calls to or from another vessel equipped with a DSC transceiver.

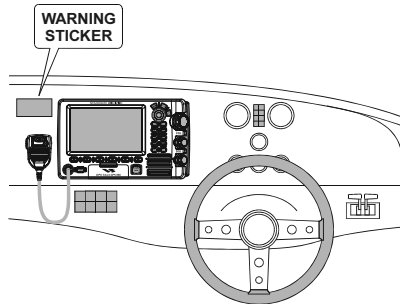

---

## 19.1 MARITIME MOBILE SERVICE IDENTITY (MMSI)

---

### 19.1.0 What is an MMSI?

An MMSI (Maritime Mobile Service Identity) is a nine digit number used on Marine Transceivers capable of using Digital Selective Calling (DSC). This number is used like a telephone number to selectively call other vessels.

**THIS NUMBER MUST BE PROGRAMMED INTO THE CPV350 TO OPERATE THE DSC FUNCTIONS.**

#### *How can I obtain an MMSI assignment?*

Boat US offers online registration of a MMSI. Visit [www.boatus.com/mmsi](http://www.boatus.com/mmsi)

## 19.1.1 Programming the MMSI

### WARNING

User MMSI can be input only twice. If the user tries to input an MMSI more than twice, the radio will show the display on the right. If the user needs to change the MMSI more than twice, the transceiver will have to be sent to Factory Service. Refer to the section "23.1 FACTORY SERVICE."

1. Press **[MENU]** two times. Move the ShuttlePoint knob to highlight **RADIO SETUP** and press **[ENT]** or move the ShuttlePoint knob to the right.
2. Move the ShuttlePoint knob to highlight **DSC SETTINGS** and press **[ENT]** or move the ShuttlePoint knob to the right.
3. Move the ShuttlePoint knob to highlight **USER MMSI** and press **[ENT]** or move the ShuttlePoint knob to the right.
4. Move the ShuttlePoint knob to the up or down to select the first number of your MMSI, then move the ShuttlePoint knob to the right to step to the next number.
5. Repeat step 6 to set your MMSI (up to nine digits).
6. When finished programming the number, press the **[ENT]** to store the number in memory.
7. Press **[CLR]** until the menu disappears or an easier method is to move the ShuttlePoint knob to the left a few times.

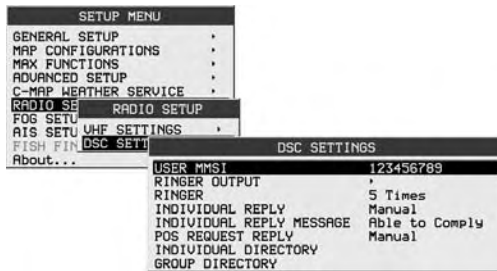

Figure 19.1 - DSC SETTINGS menu

## 19.2 DSC DISTRESS CALL

The CPV350 is capable of transmitting and receiving DSC Distress messages from all DSC radios. The CPV350 will transmit the Latitude, Longitude of the vessel if the GPS has a fix.

### 19.2.0 Transmitting a DSC Distress Call

#### NOTE

To be able to transmit a DSC distress call an MMSI number must be programmed, refer to section "19.1.1 Programming the MMSI." In order for your ships location to be transmitted a GPS antenna must be connected to the CPV350, refer to section "2.3 MOUNTING THE GPS WASS SMART ANTENNA."

1. Lift the red spring loaded DISTRESS cover and press **[DISTRESS]**. "DISTRESS ALERT" popup window will appear on the display.

- Press and hold **[DISTRESS]**. The radios display will count down (3-2-1) and then transmit the Distress call.
- When the distress signal is sent, CH70 and “**TX**” icon will briefly appear on the VHF Radio” window in the display. After the message has been sent, the radio will sound a Distress Alarm.
- The transceiver will watch for a DSC acknowledgment transmission on CH70 and also receive calls on CH16.
- If an acknowledgement is received, select channel 16 and advise your distress situation.
- If no acknowledgment is received, the distress call is repeated in 4 minute intervals until a DSC acknowledgment is received.
- When a DSC Distress acknowledgment is received, a distress alarm sounds. The radio automatically switched to channel 16, and display shows the MMSI of the ship responding to your distress.  
RECEIVED ACK: acknowledgment signal is received.  
RECEIVED RLY: relay signal is received from another vessel or coast station.
- To cancel the DSC distress alarm signal from the speaker, press any key.

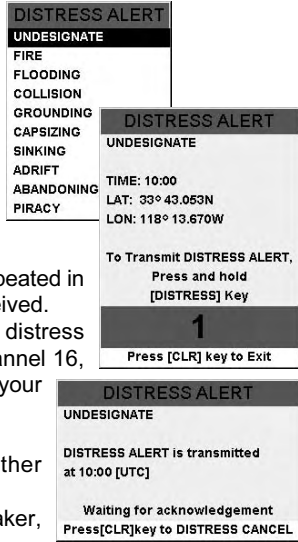

### Transmitting a DSC Distress Call with Nature of Distress

The CPV350 is capable of transmitting a DSC Distress Call with the following “Nature of Distress” categories: Undesignated, Fire, Flooding, Collision, Grounding, Capsizing, Sinking, Adrift, Abandoning, Piracy, MOB.

- Lift the red spring loaded DISTRESS cover and press **[DISTRESS]**. The “DISTRESS ALERT” popup window will appear on the display.
- Move the ShuttlePoint knob to the up or down or turn the Channel knob to select the desired nature of distress category.
- Press and hold **[DISTRESS]**. The radios display will count down (3-2-1) and then transmit the Distress call.
- When the distress signal is sent, CH70 and “**TX**” icon will appear on the “VHF Radio” window in the display. After the message has been sent, the radio will sound a Distress Alarm.
- The transceiver will watch for a DSC acknowledgment transmission on CH70 and also receive calls on CH16.
- If an acknowledgement is received, select channel 16 and advise your distress situation.
- If no acknowledgment is received, the distress call is repeated in 4-minute intervals until a DSC acknowledgment is received.
- When a DSC Distress acknowledgment is received, a distress alarm sounds. The radio automatically switches to channel 16, and display shows the MMSI of the ship responding to your distress.  
RECEIVED ACK: acknowledgment signal is received.  
RECEIVED RLY: relay signal is received from another vessel or coast station.
- To cancel the DSC distress alarm signal from the speaker, press any key.





### Cancel a DSC Distress Call

If a DSC Distress call was sent by error the CPV350 allows you to send a message to other vessels to cancel the Distress Call that was made in error. Press [CLR], then press [ENT].

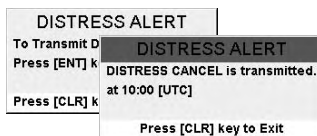

### 19.2.1 Receiving a DSC Distress Call

1. When a DSC Distress call is received, an emergency alarm sounds.
2. The CPV350 automatically switches to channel 16, and "RECEIVED DISTRESS ALERT" popup window is shown on the display.
3. Press any key to stop the alarm.

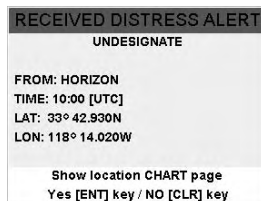

#### NOTE

You must continue monitoring channel 16 as a coast station may require assistance in the rescue attempt.

### 19.3 ALL SHIPS CALL

The All Ships Call function allows contact to be established with other vessel stations without having their ID in the individual calling directory. Also, priority for the call can be designated as Urgency or Safety.

**URGENCY Call:** This type of call is used when a vessel may not truly be in distress, but have a potential problem that may lead to a distress situation. This call is the same as saying PAN PAN PAN on channel 16.

**SAFETY Call:** Used to transmit boating safety information to other vessels. This message usually contains information about an overdue boat, debris in the water, loss of a navigation aid or an important meteorological message. This call is the same as saying Securite, Securite, Securite.

#### 19.3.0 Transmitting an All Ships Call

1. Press [CALL]. The "DSC Operation" menu soft keys appear below the display.



2. Press [ALL SHIPS] and a "ALL SHIPS CALL" popup window will be shown on the display.
3. Move the ShuttlePoint knob up or down or turn the Channel knob to select the call (**Urgency** or **Safety**), then press [ENT].
4. Press [ENT] again to transmit the selected type of all ships DSC call.
5. After the ALL SHIPS CALL is transmitted, the transceiver will switch to CH16.
6. Listen to the channel to make sure it is not busy, then key the microphone and say PAN PAN PAN or "Securite, Securite, Securite" depending on the priority of the call. Say your call sign and announce the channel you wish to switch to for communications.

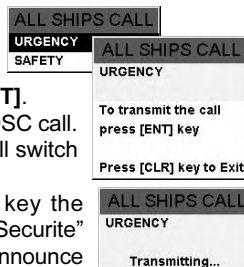

### 19.3.1 Receiving an All Ships Call

1. When an all ships call is received, an emergency alarm sounds.
2. The radio will automatically change to channel 16, and a "RECEIVED DSC CALL" popup window will be shown on the display to see the MMSI of the vessel transmitting the All Ships Call.
3. Press any key to stop the alarm.
4. Monitor channel 16 or traffic channel until the URGENCY voice communication is completed.



## 19.4 INDIVIDUAL CALL

This feature allows the CPV350 to contact another vessel with a DSC VHF radio and automatically switch the receiving radio to a desired communications channel. This feature is similar to calling a vessel on CH16 and requesting to go to another channel (switching to the channel is private between the two stations).

### 19.4.0 Setting up the Individual / Position Call Directory

The CPV350 has a DSC directory that allows you to store a vessel or person's name and the MMSI number associated with vessels you wish to transmit Individual calls, Position Requests and Position Send transmissions. The CPV350 can store up to 56 MMSI into the Individual directory.

To transmit an Individual call you must program this directory with information of the persons you wish to call, similar to a cellular phones telephone directory.

1. Press **[MENU]** two times. Move the ShuttlePoint knob to highlight **RADIO SETUP** and press **[ENT]** or move the ShuttlePoint knob to the right.
2. Move the ShuttlePoint knob to highlight **DSC SETTINGS** and press **[ENT]** or move the ShuttlePoint knob to the right.
3. Move the ShuttlePoint knob to highlight **INDIVIDUAL DIRECTORY** and press **[ENT]** or move the ShuttlePoint knob to the right.
4. Move the ShuttlePoint knob to highlight **NEW** then press **[ENT]**.
5. Move the ShuttlePoint knob to up or down to scroll through the first letter of the name of the vessel or person you want to reference in the directory.
6. Move the ShuttlePoint knob to the right to store the first letter in the name and step to the next letter to the right.
7. Repeat step 5 and 6 until the name is complete. The name can consist of up to eleven characters.
8. After the eleventh letter or space has been entered, press **[ENT]** to advance to the MMSI number entry.
9. Move the ShuttlePoint knob to up or down to scroll through numbers, 0-9 to enter the desired number and move the ShuttlePoint knob to the right to move one space to the right. Repeat this procedure until all nine space of the MMSI number are entered.
10. If a mistake was made entering in the MMSI number move the ShuttlePoint knob to the left until the wrong number is selected, then move the ShuttlePoint knob to up or down to correct the entry.
11. To store the data entered, press **[ENT]** two times.

12. To enter another individual address, repeat steps 4 through 11.
13. Press **[CLR]** until the menu disappears.



Figure 19.4.0 - INDIVIDUAL DIRECTORY menu

### 19.4.1 Setting up Individual Reply

Allows setting up the radio to automatically (default setting) or manually respond to a DSC Individual call requesting you to switch to a working channel for voice communications. When Manual is selected the MMSI of the calling vessel is shown allowing you to see who is calling. This function is similar to caller id on a cellular phone.

1. Press **[MENU]** two times. Move the ShuttlePoint knob to highlight **RADIO SETUP** and press **[ENT]** or move the ShuttlePoint knob to the right.
2. Move the ShuttlePoint knob to highlight **DSC SETTINGS** and press **[ENT]** or move the ShuttlePoint knob to the right.
3. Move the ShuttlePoint knob to highlight **INDIVIDUAL REPLY** and press **[ENT]** or move the ShuttlePoint knob to the right.
4. A popup window will be shown with **Manual** and **Automatic**, move the ShuttlePoint knob to the desired selection and press **[ENT]** or move the ShuttlePoint knob to the right.
5. Press **[CLR]** until the menu disappears or an easier method is to move the ShuttlePoint knob to the left a few times.

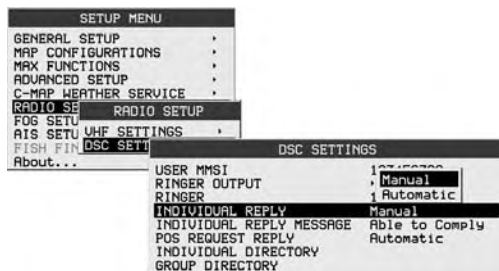

Figure 19.4.0 - INDIVIDUAL REPLY menu

## 19.4.2 Setting up the Individual/Group Call Ringer

When an Individual Call or Group Call is received the radio will produce a ringing tone for 3 minutes. This selection allows ringer time to be changed.

1. Press **[MENU]** two times. Move the ShuttlePoint knob to highlight **RADIO SETUP** and press **[ENT]** or move the ShuttlePoint knob to the right.
2. Move the ShuttlePoint knob to highlight **DSC SETTINGS** and press **[ENT]** or move the ShuttlePoint knob to the right.
3. Move the ShuttlePoint knob to highlight **RINGER** and press **[ENT]** or move the ShuttlePoint knob to the right.
4. Another popup window will be shown, move the ShuttlePoint knob to the desired ringing time of a Individual Call and press **[ENT]** or move the ShuttlePoint knob to the right.
5. Press **[CLR]** until the menu disappears or an easier method is to move the ShuttlePoint knob to the left a few times.

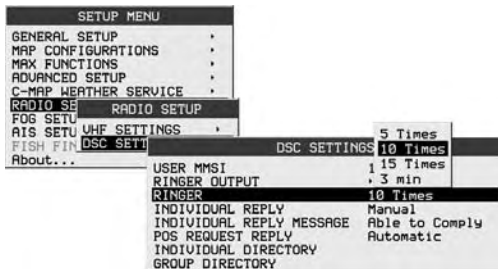

Figure 19.4.2 - RINGER menu

The CPV350 has the capability to turn off the ringer for Individual, Group and DSC polling calls.

1. Press **[MENU]** two times. Move the ShuttlePoint knob to highlight **RADIO SETUP** and press **[ENT]** or move the ShuttlePoint knob to the right.
2. Move the ShuttlePoint knob to highlight **DSC SETTINGS** and press **[ENT]** or move the ShuttlePoint knob to the right.
3. Move the ShuttlePoint knob to highlight **RINGER OUTPUT** and press **[ENT]** or move the ShuttlePoint knob to the right.
4. Move the ShuttlePoint knob to select **INDIVIDUAL** if you wish to disable the Individual Call ringer, move the ShuttlePoint knob to **GROUP** or Polling ringer and press **[ENT]** or move the ShuttlePoint knob to the right.
5. Another popup window will be shown with **On** and **Off**, move the ShuttlePoint knob to select **Off** and press **[ENT]** or move the ShuttlePoint knob to the right
6. Press **[CLR]** until the menu disappears or an easier method is to move the ShuttlePoint knob to the left a few time.

If you wish to return to enabling the ringer tone, just repeat the above procedure, moving the ShuttlePoint knob to select **On** in step "5" above.

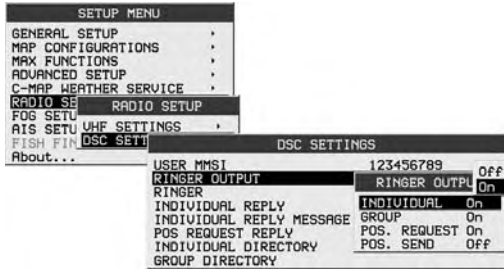

Figure 19.4.2 - RINGER OUTPUT menu

### 19.4.3 Transmitting an Individual Call

This feature allows the user to contact another vessel with a DSC radio. This feature is similar to calling a vessel on CH16 and requesting to go to another channel.

#### Using the Individual Calling directory

To use this method the CPV350 must be pre-programmed with MMSI numbers of vessels you wish to call (similar to programming in telephone numbers into a cell phone. Refer to section “19.5.1 Setting up the Individual / Position Call Directory.”

1. Press **[CALL]**. The “DSC Operation” menu soft keys appear at the bottom edge of the display.



2. Press **[INDIVIDUAL]** and the “DIRECTORY” popup window on the display.
3. Move the ShuttlePoint knob to the up or down or turn the Channel knob to select the “Individual” you want to contact.
4. Press **[ENT]**, then turn the Channel knob to select the operating channel you want to communicate on and press **[ENT]**.
5. Press **[ENT]** again to transmit the individual DSC Call or press the **[CLR]** key to cancel the call. After INDIVIDUAL CALL is transmitted, the transceiver will wait 8 seconds for the acknowledgment. If the reply signal is not received, the transceiver will transmit again.
6. After the second INDIVIDUAL CALL is transmitted, if the reply signal is not received, the display will be as shown in the illustration on the right. To send the call again, press **[ENT]**.
7. When an individual call acknowledgment is received, the established channel is automatically changed to the channel which is selected on step 3 above and a ringing tone sounds.
8. Press any key to listen to the channel to make sure it is not busy, then key the microphone and call the other vessel you desire to communicate with.



## Manual Calling a Individual MMSI

You may enter an MMSI number manually to contact without Setting up the Individual Directory.

1. Press **[CALL]**. The “DSC Operation” menu soft keys will appear at underneath the display.



2. Press **[INDIVIDUAL]** to show the “DIRECTORY” popup window on the display.
3. Move the ShuttlePoint knob to the up or down or turn the Channel knob to select “MANUAL,” then press the **[ENT]** key show the “MMSI INPUT” window on the display.
4. Move the ShuttlePoint knob to up or down to scroll through numbers, 0-9 to enter the desired number and move the ShuttlePoint knob to the right to move one space to the right. Repeat this procedure until all nine space of the MMSI number are entered.
5. If a mistake was made entering in the MMSI number move the ShuttlePoint knob to the left until the wrong number is selected, then move the ShuttlePoint knob to up or down to correct the entry.
6. When finished entering the MMSI number, press the **[ENT]**.
7. Turn channel knob to select the operating channel you want to communicate on and press **[ENT]**.
8. Press **[ENT]** again to transmit the individual DSC Call or press the **[CLR]** key to cancel the call.
9. After INDIVIDUAL CALL is transmitted, the transceiver will wait 8 seconds for the acknowledgment. If the reply signal is not received, the transceiver will transmit again.
10. After the second INDIVIDUAL CALL is transmitted, if the reply signal is not received, the display will be as shown in the illustration on the right. To send the call again, press **[ENT]** or to exit the mode, press **[CLR]**.
11. When an individual call acknowledgment is received, the established channel is automatically changed to the channel which is selected on step 7 above and a ringing tone sounds.
12. Press any key to listen to the channel to make sure it is not busy, then key the microphone and call the other vessel you desire to communicate with.



## 19.4.4 Receiving an Individual Call

When the CPV350 receives an individual call, by default the CPV350 automatically transmits an acknowledgement before switching to the requested channel. The CPV350 can be set so the CPV350 prompts you to manually send a reply, refer to section “19.4.1 Setting up Individual Reply.”

1. When an individual call is received, an individual call ringing alarm sounds.
2. The radio automatically switches to the requested channel, and appear “RCEIVED DSC CALL” popup window on the display to see the MMSI of the vessel transmitting the Individual Call.
3. Press any key to stop the alarm.
4. Press **[PTT]** on the microphone and talk to the calling ship.



## 19.5 CALL WAITING DIRECTORY

The CPV350 logs received distress calls and individual calls. The DSC Call Waiting feature is similar to an answer machine where calls are this recorded logs for review. When a call is logged while the radio is set on the DSC Standby function, a message will appear on the LCD. The CPV350 can be memorized up to the latest 23 Distress and up to the latest 56 Individual Calls.

### 19.5.0 Enabling the Call Waiting Feature

Follow the steps below to enable or disable the Call Waiting feature.

1. Press **[MENU]** two times. Move the ShuttlePoint knob to highlight **RADIO SETUP** and press **[ENT]** or move the ShuttlePoint knob to the right.
2. Move the ShuttlePoint knob to highlight **DSC SETTINGS** and press **[ENT]** or move the ShuttlePoint knob to the right.
3. Move the ShuttlePoint knob to highlight **INDIVIDUAL REPLY MESSAGE** and press **[ENT]** or move the ShuttlePoint knob to the right.
4. A popup window will be shown with **Able to Comply** or **Unable to Comply**, move the ShuttlePoint knob to the desired selection and press **[ENT]** or move the ShuttlePoint knob to the right.
5. Press **[CLR]** until the menu disappears or an easier method is to move the ShuttlePoint knob to the left a few times.

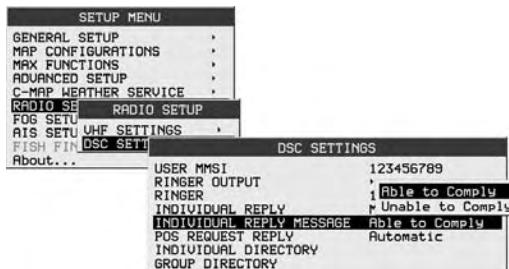

Figure 19.5.0 - INDIVIDUAL REPLY MESSAGE menu

### 19.5.1 Reviewing Received Calls Logged into the Call Waiting Directory

1. Press **[CALL]**. The "DSC Operation" menu soft keys will appear at the bottom edge of the display.



2. Press **[NEXT]** to show additional soft keys.



3. Press **[DSC LOG]** to appear "DSC LOG" popup window on the display.
4. Move the ShuttlePoint knob to the up or down or turn the Channel Knob to select the category (**DISTRESS** or **DSC CALL**) you want to review and call back.

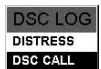





## 19.6 GROUP CALL

This feature allows the user to contact a group of specific vessels (example members of a yacht club) using DSC radios with Group call function to automatically switch to a desired channel for voice communications.

### 19.6.0 Setting up a Group Call

For this function to operate the same Group MMSI must be programmed into all the DSC VHF radios within the group of vessels that will be using this feature. The group MMSI is a 9 digit (first digit permanently set to "0") number that will allow other radios to call your vessel along with others to automatically switch to a working channel for voice communications. This function is very useful for yacht clubs and vessels traveling together that want to collectively make announcements on a predetermined channel.

1. Press **[MENU]** two times. Move the ShuttlePoint knob to highlight **RADIO SETUP** and press **[ENT]** or move the ShuttlePoint knob to the right.
2. Move the ShuttlePoint knob to highlight **DSC SETTINGS** and press **[ENT]** or move the ShuttlePoint knob to the right.
3. Move the ShuttlePoint knob to highlight **GROUP DIRECTORY** then press **[ENT]**.
4. Move the ShuttlePoint knob to highlight **NEW** then press **[ENT]**.
5. Move the ShuttlePoint knob to up or down to scroll through the first letter of the name of the vessel or person you want to reference in the group MMSI number.
6. Move the ShuttlePoint knob to the right to store the first letter in the name and step to the next letter to the right.
7. Repeat step 7 and 8 until the name is complete. The name can consist of up to eleven characters.
8. After the eleventh letter or space has been entered, press **[ENT]** to advance to the group MMSI number entry.
9. Move the ShuttlePoint knob to up or down to scroll through numbers, 0-9 to enter the desired number and move the ShuttlePoint knob to the right to move one space to the right (first digit permanently set to "0"). Repeat this procedure until all nine space of the MMSI number are entered.
10. If a mistake was made entering in the MMSI number move the ShuttlePoint knob to the left until the wrong number is selected, then move the ShuttlePoint knob to up or down to correct the entry.
11. To store the data entered, press **[ENT]** two times.
12. To enter another group MMSI, repeat steps 6 through 11.
13. Press **[CLR]** until the menu disappears.



Figure 19.6.0 - GROUP DIRECTORY menu

## 19.6.1 Transmitting a Group Call

### Using the Group calling directory

1. Press **[CALL]**. The “DSC Operation” menu Tabs will appear at the bottom edge of the display.



2. Press **[GROUP]** to show “DIRECTORY” popup window on the display.
3. Move the ShuttlePoint knob to the up or down or turn the Channel knob to select the “Group” you want to contact.
4. Press **[ENT]**, then turn the Channel knob to select the operating channel you want to communicate on and press **[ENT]**.
5. Press **[ENT]** again to transmit the Group Call signal.
6. After the GROUP CALL is transmitted, all the radios in the group will switch to the designated channel.
7. Listen to the channel to make sure it is not busy, then key the microphone and call the other vessels you desire to communicate with.

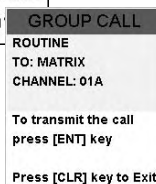

### Manual Calling a Group MMSI number

You may enter a Group MMSI number manually to contact without Setting up the Group call number.

1. Press **[CALL]**. The “DSC Operation” menu Tabs will appear at the bottom edge of the display.



2. Press **[GROUP]** to show “DIRECTORY” popup window on the display.
3. Move the ShuttlePoint knob to the up or down or turn the Channel knob to select “MANUAL,” then press **[ENT]** to show the “MMSI INPUT” window on the display.
4. Move the ShuttlePoint knob to up or down to scroll through numbers, 0-9 to enter the desired number and move the ShuttlePoint knob to the right to move one space to the right (first digit permanently set to “0”). Repeat this procedure until all nine space of the MMSI number are entered.
5. If a mistake was made entering in the MMSI number move the ShuttlePoint knob to the left until the wrong number is selected, then move the ShuttlePoint knob to up or down to correct the entry.
6. When finished entering the MMSI number, press the **[ENT]** key.
7. Turn the Channel knob to select the operating channel you want to communicate on and press **[ENT]**.
8. Press **[ENT]** again to transmit the Group Call signal.
9. After the GROUP CALL is transmitted, all the radios in the group will switch to the designated channel.
10. Listen to the channel to make sure it is not busy, then key the microphone and call the other vessels you desire to communicate with.



## 19.6.2 Receiving a Group Call

1. When a group call is received, the CPV350 will produce a ringing alarm sound.
2. The radio automatically switches to the requested channel, and appear "RECEIVED DSC CALL" popup window on the display to see the MMSI of the vessel transmitting the Group Call.
3. Press any key to stop the alarm.
4. Monitor the channel for the person calling the Group for a message.
5. If you want to respond, monitor the channel to make sure it is clear, then press [PTT] on the microphone and talk to the calling ship(s).



## 19.7 POSITION REQUEST

Advancements in DSC have made it possible to poll the location of another vessel and show the position of that vessel on the display of the CPV350 making it easy to navigate to the location of the polled vessel. This is a great feature for anyone wanting to know the position of another vessel. For example your buddy that is catching fish, or finding the location of a person you are cruising with.

### NOTE

The other vessel must have an operating GPS receiver connected to its DSC transceiver and must not have its transceiver set to deny position requests. (Refer the section "19.4.0 Setting up the Individual / Position Call Directory" to enter information into the individual directory).

### 19.7.0 Setting up Position Reply

The CPV350 can be set up to automatically or manually send your position to another vessel. This selection is important if you are concerned about someone polling the position of your vessel that you may not want to. In the manual mode you will see the MMSI or persons name shown on the display allowing you to choose to send your position to the requesting vessel.

1. Press [MENU] two times. Move the ShuttlePoint knob to highlight **RADIO SETUP** and press [ENT] or move the ShuttlePoint knob to the right.
2. Move the ShuttlePoint knob to highlight **DSC SETTINGS** and press [ENT] or move the ShuttlePoint knob to the right.
3. Move the ShuttlePoint knob to highlight **POS REQUEST REPLY** and press [ENT] or move the ShuttlePoint knob to the right.
4. Another popup window will be shown with **Manual** or **Automatic**, move the ShuttlePoint knob to the desired selection and press [ENT] or move the ShuttlePoint knob to the right. In **Manual** mode, the display of the CPV350 will show who is requesting the position. In **Automatic** mode, after a DSC POS Request is received, the radio will automatically transmit your vessels position.
5. Press [CLR] until the menu disappears or an easier method is to move the ShuttlePoint knob to the left a few times.

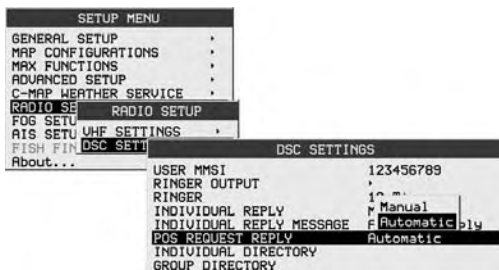

Figure 19.7.0 - POS REQUEST REPLY menu

The CPV350 has the capability to turn off the Position Request ringer.

1. Press **[MENU]** two times. Move the ShuttlePoint knob to highlight **RADIO SETUP** and press **[ENT]** or move the ShuttlePoint knob to the right.
2. Move the ShuttlePoint knob to highlight **DSC SETTINGS** and press **[ENT]** or move the ShuttlePoint knob to the right.
3. Move the ShuttlePoint knob to highlight **RINGER OUTPUT** and press **[ENT]** or move the ShuttlePoint knob to the right.
4. Move the ShuttlePoint knob to select **POLLING** and press **[ENT]** or move the ShuttlePoint knob to the right.
5. A popup window will be shown with **On** or **Off**, move the ShuttlePoint knob to select **Off** and press **[ENT]** or move the ShuttlePoint knob to the right.
6. Press **[CLR]** until the menu disappears or an easier method is to move the ShuttlePoint knob to the left a few times.

If you wish to return to enabling the ringer tone, just repeat the above procedure, moving the ShuttlePoint knob to select **On** in step "5" above.

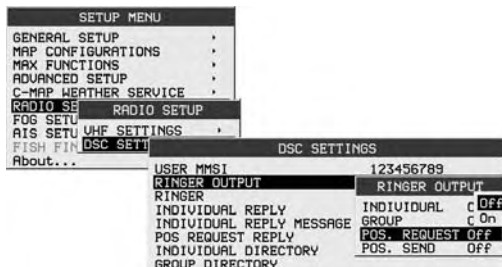

Figure 19.7.0 - RINGER OUTPUT menu

## 19.7.1 Transmitting a Position Request to Another Vessel

*Using the Individual directory to make a Position request*

1. Press the **[CALL]** key. The "DSC Operation" menu soft keys will appear below the display.



- Press **[POSITION REQUEST]** to show the “DIRECTORY” popup window on the display.
- Move the ShuttlePoint knob up or down or turn the Channel knob to select the “Individual” you want to poll the location of the vessel and show the position of that vessel, then press **[ENT]**.
- Press **[ENT]** again to transmit the position request DSC call.
- When the CPV350 receives the position from the polled vessel it is shown on the GPS Chart of the page.
- If the CPV350 does not receive a reply, the display will be as shown in the illustration on the right. To send again, press **[ENT]**.

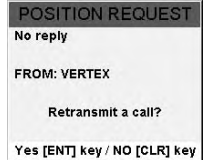

### Manual sending a position request call

You may enter an MMSI number manually to contact without Setting up the Individual / Position Call Directory.

- Press **[CALL]**. The “DSC Operation” menu Tabs will appear at the bottom edge of the display.



- Press **[POSITION REQUEST]** to show “DIRECTORY” popup window on the display.
- Move the ShuttlePoint knob to the up or down or turn the Channel knob to select “MANUAL,” then press **[ENT]** to appear “MMSI INPUT” window on the display.
- Move the ShuttlePoint knob to up or down to scroll through numbers, 0-9 to enter the desired number and move the ShuttlePoint knob to the right to move one space to the right. Repeat this procedure until all nine space of the MMSI number are entered.
- If a mistake was made entering in the MMSI number move the ShuttlePoint knob to the left until the wrong number is selected, then move the ShuttlePoint knob to up or down to correct the entry.
- When finished entering the MMSI number, press **[ENT]**.
- Press **[ENT]** to transmit the position request DSC call.
- When the CPV350 receives the position from the polled vessel it is shown on the the GPS Chart of the radio display.
- If the CPV350 does not receive a reply, the display will be as shown in the illustration on the right. To send again, press **[ENT]**.

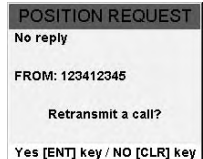
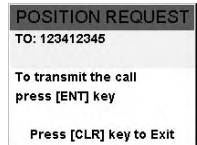

## 19.7.2 Receiving a Position Request

When a position request call is received from another vessel, a ringing alarm will sound and POS REQUEST will be shown in the LCD. Operation and transceiver function differs depending on "POS REQUEST REPLY" in the "DSC Setup" menu setting.



### **Automatically reply:**

1. When a position request call is received, a calling alarm sounds 4 times. Then requested position coordinates are transmitted automatically to the vessel requesting your vessels position.
2. To exit from position request display, press any key.

### **Manually reply:**

1. When a position request call is received from another vessel, the "RECEIVED DSC CALL" window will open.
2. Press **[ENT]** to transmit your position to the requesting vessel and exit from position request display. Press **[CLR]** to exit from position request display without the transmitting your position (No Reply).

## 19.8 POSITION SEND

---

The feature is similar to Position Request, however instead of requesting a position of another vessel this function allows you to send your position to another vessel.

### 19.8.0 Setting up a Position Send Ringer

The CPV350 has the capability to turn off the Position Send ringer.

1. Press **[MENU]** two times. Move the ShuttlePoint knob to highlight **RADIO SETUP** and press **[ENT]** or move the ShuttlePoint knob to the right.
2. Move the ShuttlePoint knob to highlight **DSC SETTINGS** and press **[ENT]** or move the ShuttlePoint knob to the right.
3. Move the ShuttlePoint knob to highlight **RINGER OUTPUT** and press **[ENT]** or move the ShuttlePoint knob to the right.
4. Move the ShuttlePoint knob to select **POS SEND** and press **[ENT]** or move the ShuttlePoint knob to the right.
5. A popup window will be shown with **On** or **Off**, move the ShuttlePoint knob to select **Off** and press **[ENT]** or move the ShuttlePoint knob to the right.
6. Press **[CLR]** until the menu disappears or an easier method is to move the ShuttlePoint knob to the left a few times.

To enable the ringer, repeat the above procedure, moving the ShuttlePoint knob to select **On** in step "5" above.

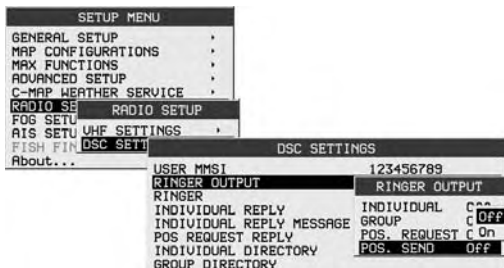

Figure 19.8.0 - RINGER OUTPUT menu

## 19.8.1 Transmitting a DSC Position Send Call

### Pre-Programmable Calling

Using the Individual directory to transmit a position send call.

1. Press **[CALL]**. The "DSC Operation" menu Tabs will appear at the bottom edge of the display.



2. Press **[POSITION SEND]** to show "DIRECTORY" popup window on the display.
3. Move the ShuttlePoint knob to the up or down or turn the Channel knob to select the "Individual" you want to contact, then press **[ENT]**.



4. Press **[ENT]** again to send your position to the selected vessel.



### Manual Calling

1. Press **[CALL]**. The "DSC Operation" menu soft keys appear below the display.



2. Press **[POSITION REQUEST]** to show "DIRECTORY" popup window on the display.
3. Move the ShuttlePoint knob to the up or down or turn the Channel knob to select **MANUAL**, then press **[ENT]** to appear "MMSI INPUT" popup window on the display.



4. Move the ShuttlePoint knob to up or down to scroll through numbers, 0-9 to enter the desired number and move the ShuttlePoint knob to the right to move one space to the right. Repeat this procedure until all nine space of the MMSI number are entered.



5. If a mistake was made entering in the MMSI number move the ShuttlePoint knob to the left until the wrong number is selected, then move the ShuttlePoint knob to up or down to correct the entry.



6. When finished entering the MMSI number, press **[ENT]**.
7. Press **[ENT]** again to send your position to the selected vessel.

## 19.8.2 Receiving a DSC Position Send Call

When another vessel transmits their location to the CPV350, the following will happen:

1. When the call is received, a ringing sound will be produced and the "RECEIVED DSC CALL" popup window will open.
2. Press the any key to stop the alarm.
3. Press **[ENT]** to shows the position of the calling vessel on the GPS Chart of the radio display.





---

## 20. RADIO SETUP

---

### 20.0 CHANNEL NAME CHANGE

---

This selection allows you to customize the name of a channel from the default name.

1. Press **[MENU]** two times. Move the ShuttlePoint knob to highlight **RADIO SETUP** and press **[ENT]** or move the ShuttlePoint knob to the right.
2. Move the ShuttlePoint knob to highlight **VHF SETTING** and press **[ENT]** or move the ShuttlePoint knob to the right.
3. Move the ShuttlePoint knob to highlight **COMMON CHANNEL SETUP** and press **[ENT]** or move the ShuttlePoint knob to the right.
4. Move the ShuttlePoint knob to select the channel group (**USA**, **INTL**, or **CAN**) you wish to change the channel name and press **[ENT]** or move the ShuttlePoint knob to the right.
5. Move the ShuttlePoint knob to highlight **CH NO.** and press **[ENT]** or move the ShuttlePoint knob to the right.
6. Move the ShuttlePoint knob to select the operating channel you wish change the channel name and press **[ENT]**.
7. Move the ShuttlePoint knob to highlight **NAME** and press **[ENT]** or move the ShuttlePoint knob to the right.
8. Move the ShuttlePoint knob to up or down to scroll through the first character (letter, number, or symbol) of the channel name.
9. Move the ShuttlePoint knob to the right to enter the first character and step to the next character to the right.
10. 7. Repeat step 8 and 9 until the name is complete. The name can consist of up to twelve characters.
11. Press **[CLR]** until the menu disappears or an easier method is to move the ShuttlePoint knob to the left a few times.



Figure 20.0 - CH EDIT menu

## 20.1 UNIT NAME

This selection allows you to provide the name to the radio and optional RAM+ or VH-310 Handset when connected.

1. Press **[MENU]** two times. Move the ShuttlePoint knob to highlight **RADIO SETUP** and press **[ENT]** or move the ShuttlePoint knob to the right.
2. Move the ShuttlePoint knob to highlight **VHF SETTING** and press **[ENT]** or move the ShuttlePoint knob to the right.
3. Move the ShuttlePoint knob to highlight **UNIT NAME** and press **[ENT]** or move the ShuttlePoint knob to the right.
4. Move the ShuttlePoint knob to select the Unit (**MAIN**, **RAM1**, or **RAM2**) to be named and press **[ENT]** or move the ShuttlePoint knob to the right.
5. Move the ShuttlePoint knob to up or down to scroll through the first letter of the unit name.
6. Move the ShuttlePoint knob to the right to enter the first character and step to the next letter to the right.
7. Repeat step 5 and 6 until the name is complete. The name can consist of up to twelve characters.
8. Press **[CLR]** until the menu disappears or an easier method is to move the ShuttlePoint knob to the left a few times.

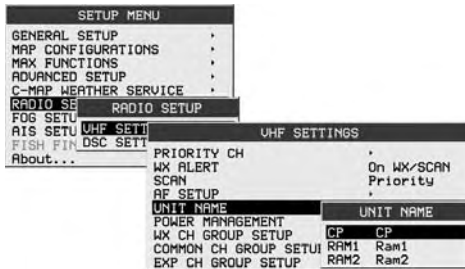

Figure 20.1 - UNIT NAME menu

---

## 21. ENHANCED RAM+ MIC OPERATION

---

When the RAM+ microphone is connected to the CPV350, most VHF, DSC, and setup menus can be remotely operated. The RAM+ Mic is supplied with 23 feet (7 m) of routing cable and can be extended up to 70 feet (21 m) using three 23 feet extension cables model CT-100. The intercom operation can be used between the RAM+ Mic and the transceiver.

### 21.0 RAM+ MIC CONTROLS

---

#### SQUELCH CONTROL (SQL)

Activates the squelch adjusting mode.

Press this key to activate the squelch adjusting mode. Press the microphone's **[▲]** or **[▼]** key to adjust the squelch.

When this key is pressed and held down for 1 second or more, the squelch is turned off.

#### VOLUME KEY (VOL)

Activates the volume adjusting mode.

Press this key to activate the volume adjusting mode. Press the microphone's **[▲]** or **[▼]** to adjust the volume.

#### POWER SWITCH (PWR)

Press and hold down this key to turn to the transceiver and RAM+ Mic on and off.

#### PTT (Push-To-Talk) SWITCH

Activates transmission.

#### [H/L] KEY

Toggles between high and low power. When the [H/L] key is pressed while the transceiver is on channel 13 or 67, the power will temporarily switch from LO to HI power until the PTT is released. The [H/L] key does not function on transmit inhibited and low power only channels.

#### [▲](UP)/[▼](DOWN) KEY

These keys are used to select channels, adjust the volume and squelch level, and to choose the item selection of different functions (such as the DSC operation). In many ways, these keys emulate the function of the transceiver's Channel knob.

#### [16/9] KEY

Immediately recalls channel 16 from any channel location. Holding down this key recalls channel 9. Pressing the [16/9] key reverts to the previous selected working channel.

#### Secondary use

Please see secondary use for the [WX] and [MEM] key.

#### [SCAN] Key

1. Starts and stops scanning of programmed channels.
2. If held while the [UP(▲)] or [DOWN(▼)] key on the microphone are pressed, the radio will show the channels programmed in scan memory. This function will not work if the unit is scanning.

#### NOTE

---

The priority channel by default is Channel 16, however the priority channel can be changed. To select a different priority channel refer to section "18.11.3 Priority Channel Set."

---

### [CALL/SET] Key

The [CALL/SET] key functions as the enter key.

#### Secondary use

Press the [CALL/SET] key to access the DSC OPERATION menu.

Press and hold the [CALL/SET] key to access the SETUP menu.

### [DW] Key

Watches for a transmission on CH16 and another selected channel until either signal is received. (Dual watch)

#### Secondary use

Press and hold [DW] key, intercom operation will operate between radio and RAM+ Mic.

### [NAV] Key

Press this key, when connected to the GPS receiver, the LCD displays Position Data and Time from the GPS.

### [WX] Key

Immediately recalls the previously selected US NOAA weather channel from any channel location.

#### Secondary use

Holding down the [16/9] key while pressing the [WX] key switch the Channel Group.

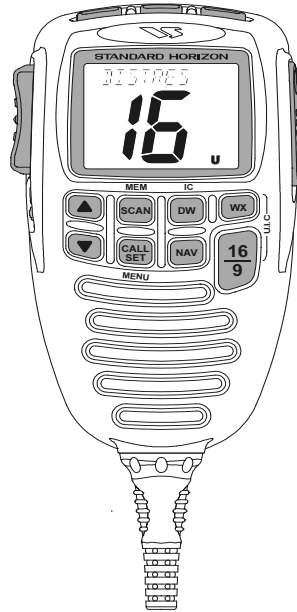

### NOTE

If position is displayed, this icon will be hidden.

### [DISTRESS] KEY

Used to send a DSC Distress Call. To send the distress call refer to section "19.2.0 Transmitting a DSC Distress Call."

## 21.1 PA/FOG OPERATION

The RAM+ is capable of controlling the 30W Public address, 4 fog horns, bells and whistles.

### 21.1.0 Operating the PA / Hailer

1. Press and hold the [NAV] key then select "PUBLIC ADDRESS" with the [UP(▲)] or [DOWN(▼)] key.
2. Press the [CALL/SET] key.
3. Press the PTT switch and speak into the microphone.
4. To turn up the PA Volume, press the PTT switch and press the [UP(▲)] or [DOWN(▼)] keys to adjust the Audio output level. The level can be set from 0 to 30W.
5. To adjust the listen back volume, (while in listenback mode) press the [VOL] key, then press the [UP(▲)] or [DOWN(▼)] key to the desired listen back volume.



To exit from the PA / Hailer mode, press and hold down the [NAV] key again.

### 21.1.1 Operating the FOG Horn

The CPV350 is capable of sending Underway, Stop, Sail, Tow, Horn, Siren, Aground and Anchor signals.

1. Press and hold the **[NAV]** key then select "FOG" with the **[UP(▲)]** or **[DOWN(▼)]** key.
2. Press the **[CALL/SET]** key.
3. Select the one of the eight functions described above with the **[UP(▲)]** or **[DOWN(▼)]** key and press the **[CALL/SET]** key.
4. On the "Horn" and "Siren" modes, press the **PTT** switch to activate the tone through the HAIL/PA speaker.  
Press the **[UP(▲)]** or **[DOWN(▼)]** keys to adjust the Audio output level.  
The level can be set from 0 to 30W.
5. To adjust the listen back volume, (while in listenback mode) press the **[VOL]** Key, then press the **[UP(▲)]** or **[DOWN(▼)]** key to the desired listen back volume.

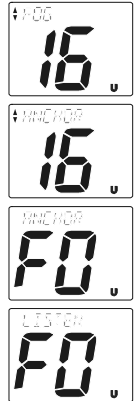

To exit from the FOG HORN mode, press and hold down the **[NAV]** key again.

## 21.2 INTERCOM OPERATION

### 21.2.0 Communication

1. Press and hold the **[DW]** key while in the "RADIO" mode, the mode is changed to "INTERCOM" mode. When the "INTERCOM" operation is activated, "IC" is displayed on the RAM+ Mic (and VH-310 Handset) and "INTERCOM" is displayed on the CPV350.
2. Press the **PTT** switch, "TALK" is displayed.  
**NOTE:** A warning beep is emitted when the RAM+ Mic **PTT** switch is pressed while the transceiver microphone's **PTT** switch is pressed.
3. Speak slowly and clearly into the microphone, hold the microphone about 1/2 inch away from your mouth.
4. When finished, release the **PTT** switch.
5. Press the **[DW]** key momentarily the mode will revert to "RADIO" mode.

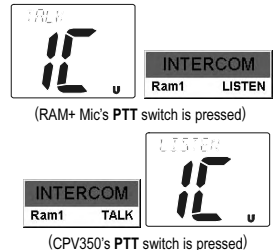

### 21.2.1 Calling

Hold down the **[DW]** key for 1 second or more, when the "INTERCOM" operation is activated. A calling beep is emitted twice from the transceiver speaker.

## 21.3 DSC/RADIO SETUP MODE

The RAM+ can access the DSC / RADIO setup menu (refer to section “19. DIGITAL SELECTIVE CALLING” and section “20. RADIO SETUP MODE” for details). The LAMP, CONTRAST, and KEY BEEP menu item accessed from the RAM+ only controls the RAM+'s display and speaker.

DSC/RADIO Setup mode from the RAM+:

1. Press and hold down the [CALL/SET] key until “RADIO SETUP” menu appears.
2. Press the [UP(▲)] / [DOWN(▼)] key to select “RADIO SETUP” or “DSC SETUP” menu.
3. Press the [CALL/SET] key, then select the menu item you wish to work on by pressing the [UP(▲)] / [DOWN(▼)] key.
4. Press the [CALL/SET] key.
5. Press the [UP(▲)] / [DOWN(▼)] key to change the value or condition for the menu item, then press the [CALL/SET] key to save the new setting.
6. Press the [UP(▲)] / [DOWN(▼)] key to select “EXIT,” then press the [CALL/SET] key to return to the normal operation.

**RADIO SETUP-menu**

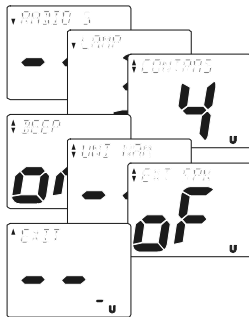

**DSC SETUP-menu**

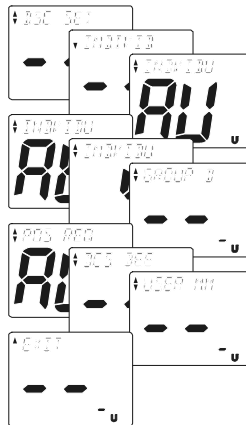

### NOTE

When setup menu is selected, the CPV350 will be temporarily disabled until the RAM+ mic, exits from the setup mode.

---

## 22 VH-310 HANDSET OPERATION

---

When the VH-310 HANDSET is connected to the CPV350, most VHF, DSC, and setup menus can be remotely operated. The VH-310 HANDSET is supplied with 23 feet (7 m) of routing cable and can be extended up to 70 feet (21 m) using three 23 feet extension cables model CT-100. The intercom operation can be used between the VH-310 HANDSET or the CPV350.

---

### 22.0 VH-310 HANDSET CONTROLS

---

#### **PWR key**

Press and hold down this key to turn to the transceiver and VH-310 HANDSET on and off.

#### **PTT (Push-To-Talk) Switch**

Activates transmission.

#### **[H/L] key**

Toggles between high and low power. When the [H/L] key is pressed while the transceiver is on channel 13 or 67, the power will temporarily switch from "LO" to "HI" power until the PTT is released.

The [H/L] key does not function on transmit inhibited and low power only channels.

#### **[DISTRESS] key**

Used to send a DSC Distress Call. To send the distress call refer to section "19.2.0 Transmitting a DSC Distress Call."

#### **[VOL] key**

Activates the volume adjusting mode.

Press this key to activate the volume adjusting mode.

Press the [▲] or [▼] to adjust the volume.

#### **NOTE**

---

When the VH-310 handset is removed from the cradle the speaker audio will be automatically reduced so not to damage your hearing. When the VH-310 is in the cradle the speaker audio will increase so communications can be heard.

---

#### **[SQL] key**

Activates the squelch adjusting mode.

Press this key to activate the squelch adjusting mode. Press the [▲] or [▼] key to adjust the squelch.

#### **[CALL(MENU)] key**

The [CALL(MENU)] key functions as the enter key.

#### **Secondary use**

Press the [CALL(MENU)] key to access the DSC OPERATION menu. The "INDIVIDUAL CALL," "GROUP CALL," "ALL SHIP CALL," "POSITION REQUEST," "POSITION SEND," "STANDBY MODE," and "CALL WAITING" functions can be accessed from the DSC OPERATION menu.

Press and hold the [CALL(MENU)] key to access the RADIO SETUP (refer to section 20) or DSC SETUP menu (refer to section 19).

### [F] key

Activates the "Alternate" key function.

Press this key to activates the "Alternate" key function of the ten keypad.

### [16/9] key

Immediately recalls channel 16 from any channel location.

Holding down this key recalls channel 9. Pressing the [16/9] key reverts to the previous selected working channel.

#### Secondary use

Press and hold the [16/9] key then press the [WX] key to switch the USA, International or Canadian channels.

### [WX] key

Immediately recalls the previously selected US NOAA weather channel from any channel location.

#### Secondary use

Holding down the [16/9] key while pressing the [WX] key switches the Channel Group.

### [▲]/[▼] KEY

These keys are used to select channels, adjust the volume and squelch level, and to choose the item selection of different functions (such as DSC operation).

### KEYPAD

#### [1(DIM)] key

When in radio mode, this key is used to directly select channel digit "1" in a channel number.

#### Secondary use

Press the [F] key first then press the [1(DIM)] key to access the LCD Dimmer menu.

#### [2(MEM)] Key

When in radio mode, this key is used to directly select channel digit "2" in a channel number.

#### Secondary use

Press the [F] key first then press the [2(MEM)] key, memorize the selected channel into the transceiver scan memory for scanning. When repeat the same procedures ([F] → [2(MEM)]), will delete the channel from the scan memory. Refer to section "18.11 SCANNING" for details.

#### [3(SCAN)] Key

When in radio mode, this key is used to directly select channel digit "3" in a channel number.

#### Secondary use

Press the [F] key first then press the [3(SCAN)] key to start and stop the scanning of programmed channels. Refer to section "18.11 SCANNING" for details.

#### [4(DW)] Key

When in radio mode, this key is used to directly select channel digit "4" in a channel number.

#### Secondary use

Press the [F] key first then press the [4(DW)] key to scan for voice communications on the priority channel and another selected channel until a signal is received on either channel (Dual Watch). Refer to section "18.10 DUAL WATCH (TO PRIORITY CHANNEL)" for details.

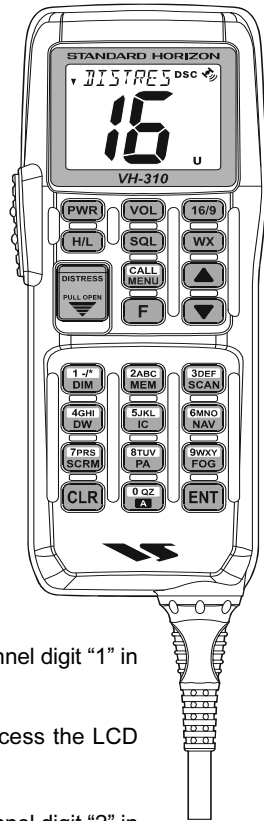



**[5(IC)] Key**

When in radio mode, this key is used to directly select channel digit "5" in a channel number.

**Secondary use**

Press the **[F]** key then press the **[5(IC)]** key to activate intercom function between RAM+(s) or VH-310 handset(s). Refer to section "18.13 INTERCOM OPERATION" for details.

**[6(NAV)] Key**

When in radio mode, this key is used to directly select channel digit "6" in a channel number.

**Secondary use**

Press the **[F]** key first then press the **[6(NAV)]** key, the LCD will display NAV GPS Data, Time, SOG (Speed Over Ground), and COG (Course Over Ground).

**[7(SCRM)] Key**

When in radio mode, this key is used to directly select channel digit "7" in a channel number.

**Secondary use**

Press the **[F]** key first then press the **[7(SCRM)]** key, available to cancel the voice scrambler temporarily. Refer to section "22.1 PA/FOG OPERATION" for details.

**[8(PA)] Key**

When in radio mode, this key is used to directly select channel digit "8" in a channel number.

**Secondary use**

Press the **[F]** key first then press the **[8(PA)]** key, available to operate the 30 Watt PA function. Refer to section "22.1 PA/FOG OPERATION" for details.

**[9(FOG)] Key**

When in radio mode, this key is used to directly select channel digit "9" in a channel number.

**Secondary use**

Press the **[F]** key first then press the **[9(FOG)]** key, available to operate the Fog Horn function. Refer to section "22.1 PA/FOG OPERATION" for details.

**[0] Key**

When in radio mode, this key is used to directly select channel digit "0" in a channel number.

**Secondary use**

Used to select A (alpha channels). Press the desired channel keys then press and hold **[0]** key until "A" appears next to the channel number and press **[ENT]** to select the channel.

**[CLR] Key**

Press the **[CLR]** key to cancel the menu selection and/or keypad entry.

**[ENT] Key**

Press the **[ENT]** key to enter the menu selection and/or keypad entry.

## 22.1 PA/FOG OPERATION

The VH-310 Handset is capable of controlling the 30W Public address, 4 fog horns, bells and whistles.

### 22.1.0 Operating the PA / Hailer

1. Press the **[F]** key followed by the **[8(PA)]** key, activate the “PA / HAIL” mode.
2. Press the **[PTT]** switch and speak into the microphone.
3. To turn up the PA Volume, press the **[PTT]** switch and press the **[▲]** or **[▼]** keys to adjust the Audio output level. The level can be set from 0 to 30W.
4. To adjust the listen back volume, (while in listenback mode) press the **[VOL]** Key, then press the **[▲]** or **[▼]** key to the desired listen back volume.



To exit from the PA / Hailer mode, press the **[F]** key followed by the **[8(PA)]** key again.

### 22.1.1 Operating the FOG Horn

The CPV350 is capable of sending Underway, Stop, Sail, Tow, Horn, Siren, Aground and Anchor signals.

1. Press the **[F]** key followed by the **[9(FOG)]** key, activate the “FOG HORN” menu.
2. Select the one of the eight functions described above with the **[▲]** or **[▼]** key and press the **[ENT]** key.
3. On the “Horn” and “Siren” modes, press the **[PTT]** switch to activate the tone through the HAIL/PA speaker. Press the **[▲]** or **[▼]** keys to adjust the Audio output level. The level can be set from 0 to 30W.
4. To adjust the listen back volume, (while in listenback mode) press the **[VOL]** Key, then press the **[▲]** or **[▼]** key to the desired listen back volume.



To exit from the FOG HORN mode, press the **[F]** key followed by the **[9(FOG)]** key again.

## 22.2 INTERCOM OPERATION

### 22.2.0 Communication

1. Press the **[F]** key followed by the **[5(IC)]** key, the mode is changed to “INTERCOM” mode.
2. When the “INTERCOM” operation is activated, “IC” is displayed on the VH-310 Handset (and RAM+ Mic, if used) and “INTERCOM” is displayed on the CPV350.
3. Press the **[PTT]** switch, “TALK” is displayed.

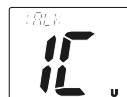

(VH-310 Mic's PTT switch is pressed)



(CPV350's PTT switch is pressed)

#### NOTE

A warning beep is emitted when the RAM+ Mic PTT switch is pressed while the transceiver microphone's PTT switch is pressed.

4. Speak slowly and clearly into the microphone, hold the microphone about 1/2 inch away from your mouth.
5. When finished, release the **[PTT]** switch.
6. To exit the "INTERCOM" mode and return to radio operation mode, press the **[F]** key followed by the **[5(IC)]** key again.

### 22.2.1 Calling

Press and hold the **[5(IC)]** key for 1 second when the "INTERCOM" operation is activated, a calling beep is emitted from the CPV350 speaker.

## 22.3 MANUAL INPUTTING OF THE GPS LOCATION (LAT/LON)

You may send the Latitude/Longitude of your vessel manually from the VH-310 Handset even if the CPV350 is not connected the GPS receiver unit.

After the position is entered, transmitting a DSC Distress, Position Request, or Position Send will contain the manually entered position.

1. Press and hold down the **[CALL(MENU)]** key until "Radio Setup" menu appears.
2. Press the **[▼]** key to select "DSC SETUP" menu.
3. Press the **[ENT]** key, then select "POS INPUT" with the **[▼]/[▲]** key.
4. Press the **[ENT]** key then, enter the your local time from the keypad by the 24-hour system on the UTC time.
5. Enter the Latitude of your vessel location (xx.xx.xx) by the keypad, then press the **[6(NAV)]** key to select North (N), or **[7(SCRM)]** key to select South (S).
6. Enter the Longitude of your vessel location (xxx.xx.xx) by the keypad, then press the **[3(SCAN)]** to select East (E), or **[9(FOG)]** key to select West (W).
7. If a number was entered by mistake, press the **[H/L]** key repeatedly to select the number. Press the **[▼]/[▲]** key to select the desired number.
8. Press and hold in the **[ENT]** key to store the data entered, then press the **[16/9]** key to exit this menu and return to radio operation mode.

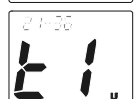
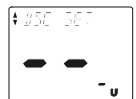



### 22.4.1 Changing GPS Information to Vessel position or COG

Allows customizing the NAV data showing GPS Information. Factory default is “Your Vessel’s Current Position,” however, following the steps below the GPS Information can be changed to “Course Over Ground (COG).”

1. Press and hold down the **[CALL(MENU)]** key until “RADIO SETUP” menu appears.
2. Press the **[ENT]** key, then select “NAV DISPLAY” with the **[▼]/[▲]** key.
3. Press the **[CALL(SET)MENU]** key.
4. Press the **[▼]** or **[▲]** key to select “Pos (Your Vessel’s Current Position)” or “Cru (Course Over Ground).”
5. Press the **[ENT]** key to store the data entered, then press the **[16/9]** key to exit this menu and return to radio operation mode.



### 22.4.2 External Speaker AF Selection

The AF SELECT menu allows you to set the audio output level of the VH-310’s External Speaker to “fixed” regardless the VOL level setting of the VH-310, which is useful to the case when use with the amplified speaker, such as the Standard Horizon MLS-310.

1. Press and hold down the **[CALL(MENU)]** key until “Radio Setup” menu appears.
2. Press the **[ENT]** key, then select “AF SELECT” with the **[▼]/[▲]** key.
3. Press the **[ENT]** key.
4. Press the **[▼]** or **[▲]** key to select “Pr” (External Speaker Level is “Fixed”) or “Po” (External Speaker Level is “Adjustable”).
5. Press the **[ENT]** key to store the data entered, then press the **[16/9]** key to exit this menu and return to radio operation mode.



---

## 23. MAINTENANCE

---

The inherent quality of the solid-state components used in this transceiver will provide many years of continuous use. Taking the following precautions will prevent damage to the transceiver.

- Keep the microphone connected or the jack covered at all times to prevent corrosion of electrical contacts;
- Never key the microphone unless an antenna or suitable dummy load is connected to the transceiver.
- Ensure that the supply voltage to the transceiver does not exceed 16 VDC or fall below 11 VDC.
- Use only STANDARD HORIZON-approved accessories and replacement parts.

In the unlikely event of serious problems, please contact your Dealer or our repair facility. Address and phone numbers for this facility, as well as warranty information, are contained in section "25 WARRANTY."

---

### 23.0 REPLACEMENT PARTS

---

Occasionally an owner needs a replacement mounting bracket or knob. These can be ordered from our Parts Department by writing or calling:

**Marine Division of Vertex Standard**  
US Headquarters  
10900 Walker Street, Cypress, CA 90630, U.S.A.  
Telephone (714) 827-7600

Commonly requested parts, and their part numbers are listed below.

- Dust Cover: RA0751100
- Power Cord: T9023306
- ACC Cable: T9101553
- Channel Knob: RA0750700
- VOL/SQL Knob: RA0750800
- Mounting Bracket: RA0752200
- Mounting Bracket Knob: RA045910A
- Microphone Hanger: RA0458800
- CMP25 RAM+ Mic or VH-310 Routing Cable Assembly: S8101512

## 23.1 FACTORY SERVICE

---

In the unlikely event that the radio fails to perform or needs servicing, please contact the following:

**Standard Horizon**  
**Attention Marine Repair Department**  
10900 Walker Street, Cypress, CA 90630  
Telephone (800) 366-4566

An “RA” Return Authorization number is not necessary to send a product in for service. Include a brief note describing the problem along with your name, return address, phone number, and proof of purchase.

## 23.2 TROUBLESHOOTING

---

**The GPS chartplotter does not turn On.** The voltage or the polarity may not be correct. Make sure that the correct voltage (10-35 volt dc) is present. Check also that the polarity is correct.

**The GPS chartplotter does not get a valid fix.** The GPS WAAS Smart Antenna may not be in an open sky position or the antenna cable may not be properly connected. Make sure that no metal obstacle is placed around the antenna acting as a shield for the antenna and disconnect and connect again the antenna cable to the GPS chartplotter. If, after 15 minutes, the GPS chartplotter does not get the fix, turn it Off and On again.

**The GPS chartplotter does not turn Off.** The GPS chartplotter may be in an unpredictable status. If, after pressing [PWR] (for at least 3 seconds) the GPS chartplotter does not turn Off, turn Off the voltage.

**The GPS chartplotter screen becomes very dark after a long exposure to direct sunlight.** The internal temperature is very high. Control the contrast. Protect the GPS chartplotter from direct sunlight.

**The GPS chartplotter does not respond to any command.** The GPS chartplotter may be in an unpredictable status. Try to turn Off, and then turn On. If the problem persists, erase the memory) or remove power from the battery.

**External devices are not receiving data from the GPS chartplotter.** The connections or the Software settings may not be right. Check the connections or the settings.

**The location of my fix is not shown correctly on the Chart page.** This is usually caused when C-MAP Geo-References a nautical chart. Contact C-MAP with the Latitude & Longitude of your vessels position, the position where you think your vessels should be and with details of the cartography areas, which can be seen by selecting the Chart page, press [MENU], move the ShuttlePoint knob to highlight **FIND SERVICES** and press [ENT], move the ShuttlePoint knob to highlight **INFORMATION** and press [ENT], move the ShuttlePoint knob to **Data Source** and press [ENT]. Write down the “Compilation scale”, “Notice to mariners” and “Horizontal datum”. Next contact C-MAP USA at 508/477-8010 and advise the problem.

---

## 24. CHANNEL ASSIGNMENTS

---

Tables on the following columns list the VHF Marine Channel assignments for U.S.A. and International use. Below are listed some data about the charts.

1. VTS. Where indicated, these channels are part of the U.S. Coast Guard's Vessel Traffic System.
2. Alpha channel numbers, that is, channel numbers followed by the letter A (such as Channel 07A) are simplex channels on the U.S.A. or Canadian channel assignments whose counterparts in the International assignments are duplex channels. International channels do not use "alpha" numbers. If you call the Coast Guard on Channel 16, they will sometimes ask you to "go to channel 22 Alpha." This is a channel assigned to U.S.A. and Canadian Coast Guards for handling distress and other calls. If your radio is set for International operation you will go to Channel 22 instead of 22A, and will not be able to communicate with the Coast Guard. To use Channel 22A, your radio must be set for USA or Canada operation, usually by a U/I/C (USA/International/Canada) control or combination of controls. Channel 22 (without an "A") is an International duplex channel for port operations. Some radios indicate an "A" adjacent to the alpha channels on the display; on others "alpha" is not indicated but the proper channel is selected based on the U/I/C setting.
3. Bridge-to-Bridge channels (for example, Channel 13) are for use by bridge operators on intercoastal waterways and rivers. It is also used by marine vessels in the vicinity of these bridges for navigation and for communicating with the bridge operators. Note that a limit of 1 Watt is specified for these channels. See page 28 for additional information.
4. The S/D column on the chart indicates either S (simplex) or D (duplex). Simplex means transmitting and receiving on the same frequency. Only one party at a time can talk, unlike a telephone. Be sure to say "over" and release your microphone push-to-talk switch at the end of each transmission. Duplex operation involves the use of one frequency for transmitting and a separate frequency for receiving. On channels specified as duplex on the charts, correct mode of operation is established automatically by your radio when you select a channel; you cannot change the mode. And you still must release the push-to-talk switch after each transmission in order to listen to the radio.
5. Channels normally used by recreational boaters are those that include the term "non-commercial" in the Channel Use column of the chart. Some of these are shared with other users and some are used only in certain geographic regions.
6. Marine vessels equipped with VHF radios are required to monitor Channel 16.



VHF MARINE CHANNEL CHART							
CH	U	C	I	S/D	TX	RX	CHANNEL USE
01		X	X	D	156.050	160.650	Public Correspondence (Marine Operator)
01A	X			S	156.050		Port Operation and Commercial. VTS in selected areas
02		X	X	D	156.100	160.700	Public Correspondence (Marine Operator)
03		X	X	D	156.150	160.750	Public Correspondence (Marine Operator)
<b>03A</b>	<b>X</b>			<b>S</b>	<b>156.150</b>		<b>US Government only, Coast Guard</b>
04			X	D	156.200	160.800	Public Correspondence (Marine Operator), Port operation, ship movement
04A		X		S	156.200		Pacific Coast: Coast Guard, East Coast: Commercial fishing
05			X	D	156.250	160.850	Public Correspondence (Marine Operator), Port operation, ship movement
05A	X	X		S	156.250		Port operation. VTS in Seattle
06	X	X	X	S	156.300		Inter-ship Safety
07			X	D	156.350	160.950	Public Correspondence (Marine Operator), Port operation, ship movement
07A	X	X		S	156.350		Commercial
08	X	X	X	S	156.400		Commercial (Inter-ship only)
09	X	X	X	S	156.450		Boater Calling channel, Commercial & Non-commercial (Recreational)
10	X	X	X	S	156.500		Commercial
11	X	X	X	S	156.550		Commercial. VTS in selected areas.
12	X	X	X	S	156.600		Port operation. VTS in selected areas.
13	X	X	X	S	156.650		Inter-ship Navigation Safety (Bridge-to-bridge)
14	X	X	X	S	156.700		Port operation. VTS in selected areas.
15	X			S	---	156.750	Environmental (Receive only)
15		X	X	S	156.750		Commercial, non-commercial, ship movement (1 W)
16	X	X	X	S	156.800		International Distress, Safety and Calling
17	X	X	X	S	156.850		State Controlled (1 W)
18			X	D	156.900	161.500	Port operation, ship movement
18A	X	X		S	156.900		Commercial
19			X	D	156.950	161.550	Port operation, ship movement
19A	X			S	156.950		US: Commercial
19A		X		S	156.950		Coast Guard
20	X	X	X	D	157.000	161.600	Canadian Coast Guard Only, International: port operations and shipment
20A	X			S	157.000		Port operation
21			X	D	157.050	161.650	Port operation, ship movement
<b>21A</b>	<b>X</b>	<b>X</b>		<b>S</b>	<b>157.050</b>		<b>U.S. Government Only, Canadian Coast Guard</b>
22			X	D	157.100	161.700	Port operation, ship movement
22A	X	X		S	157.100		US and Canadian Coast Guard Liaison and Maritime Safety Information Broadcasts announced on channel 16
23		X	X	D	157.150	161.750	Public Correspondence (Marine Operator)
<b>23A</b>	<b>X</b>			<b>S</b>	<b>157.150</b>		<b>U.S. Government Only</b>
24	X	X	X	D	157.200	161.800	Public Correspondence (Marine Operator)
25	X	X	X	D	157.250	161.850	Public Correspondence (Marine Operator)
26	X	X	X	D	157.300	161.900	Public Correspondence (Marine Operator)
27	X	X	X	D	157.350	161.950	Public Correspondence (Marine Operator)
28	X	X	X	D	157.400	162.000	Public Correspondence (Marine Operator)

### VHF MARINE CHANNEL CHART

CH	U	C	I	S/D	TX	RX	CHANNEL USE
60		X	X	D	156.025	160.625	Public Correspondence (Marine Operator)
61			X	D	156.075	160.675	Public Correspondence (Marine Operator), Port operation, ship movement
<b>61A</b>	<b>X</b>	<b>X</b>		<b>S</b>	<b>156.075</b>		<b>U.S. Government Only, Canadian Coast Guard, Pacific Coast: Commercial Fishing-East Coast</b>
62			X	D	156.125	160.725	Public Correspondence (Marine Operator), Port operation, ship movement
62A		X		S	156.125		Public Coast: Coast Guard; East Coast: commercial fishing only
63			X	D	156.175	160.775	Public Correspondence (Marine Operator), Port operation, ship movement
63A	X			S	156.175		Port Operation and Commercial. VTS in selected areas.
64		X	X	D	156.225	160.825	Public Correspondence (Marine Operator), Port operation, ship movement
<b>64A</b>	<b>X</b>	<b>X</b>		<b>S</b>	<b>156.225</b>		<b>U.S. Government Only, Canadian Commercial Fishing</b>
65			X	D	156.275	160.875	Public Correspondence (Marine Operator), Port operation, ship movement
65A	X	X		S	156.275		Port Operations
66			X	D	156.325	160.925	Public Correspondence (Marine Operator), Port operation, ship movement
66A	X	X		S	156.325		Port Operations
67	X	X	X	S	156.375		US: Commercial. Used for Bridge-to-bridge communications in lower Mississippi River. Inter-ship only, Canada: Commercial fishing, S&R
68	X	X	X	S	156.425		Non-commercial (Recreational)
69	X	X	X	S	156.475		US: Non-commercial (Recreational), Canada: Commercial fishing only, International: Inter-ship, Port operations and Ship movement
70	X	X	X	S	156.525		Digital selective calling (voice communications not allowed)
71	X	X	X	S	156.575		US, Canada: Non-commercial (Recreational), International: Port operations and Ship movement
72	X	X	X	S	156.625		Non-commercial (Inter-ship only)
73	X	X	X	S	156.675		US: Port Operations, Canada: Commercial fishing only, International: Inter-ship, Port operations and Ship movement
74	X	X	X	S	156.725		US: Port Operations, Canada: Commercial fishing only, International: Inter-ship, Port operations and Ship movement
75	X			S	156.775		Port Operations (Inter-ship only) (1W)
76	X			S	156.825		Port Operations (Inter-ship only) (1W)
77	X	X		S	156.875		Port Operations (Inter-ship only) (1W)
77			X	S	156.875		Port Operations (Inter-ship only)
78			X	D	156.925	161.525	Public Correspondence (Marine Operator), Port operation, ship-movement
78A	X	X		S	156.925		Non-commercial (Recreational)
79			X	D	156.975	161.575	Port operation and Ship movement
79A	X	X		S	156.975		Commercial
80			X	D	157.025	161.625	Port operation, ship movement
80A	X	X		S	157.025		Commercial

VHF MARINE CHANNEL CHART							
CH	U	C	I	S/D	TX	RX	CHANNEL USE
81			X	D	157.075	161.675	Port operation, ship movement
<b>81A</b>	<b>X</b>	<b>X</b>		<b>S</b>	<b>157.075</b>		<b>U.S. Government Only - Environmental protection operations.</b>
82			X	D	157.125	161.725	Public Correspondence (Marine Operator), Port operation, ship movement
<b>82A</b>	<b>X</b>	<b>X</b>		<b>S</b>	<b>157.125</b>		<b>U.S. Government Only, Canadian Coast Guard Only</b>
83		X	X	D	157.175	161.775	Canadian Coast Guard Only
<b>83A</b>	<b>X</b>	<b>X</b>		<b>S</b>	<b>157.175</b>		<b>U.S. Government Only, Canadian Coast Guard Only</b>
83		X	X	D	157.175	161.775	Public Correspondence (Marine Operator)
84	X	X	X	D	157.225	161.825	Public Correspondence (Marine Operator)
85	X	X	X	D	157.275	161.875	Public Correspondence (Marine Operator)
86	X	X	X	D	157.325	161.925	Public Correspondence (Marine Operator)
87	X	X	X	D	157.375	161.975	Public Correspondence (Marine Operator)
88	X	X	X	D	157.425	162.025	Public Correspondence (ship-to-coast)
88A	X			S	157.425		Commercial, Inter-ship Only
WX01	X	X	X	D	---	162.550	Weather (receive only)
WX02	X	X	X	D	---	162.400	Weather (receive only)
WX03	X	X	X	D	---	162.475	Weather (receive only)
WX04	X	X	X	D	---	162.425	Weather (receive only)
WX05	X	X	X	D	---	162.450	Weather (receive only)
WX06	X	X	X	D	---	162.500	Weather (receive only)
WX07	X	X	X	D	---	162.525	Weather (receive only)
WX08	X	X	X	D	---	161.650	Weather (receive only)
WX09	X	X	X	D	---	161.775	Weather (receive only)
WX10	X	X	X	D	---	163.275	Weather (receive only)

The above **BOLD** channels are not for use of the general public in U.S. waters, unless proper authorization is given.

Channel designator	Carrier frequency (MHz)		Points of communication (Intership and between coast and ship unless otherwise indicated)	
	Ship transmit	Coast transmit		
<b>Port Operations</b>				
01A <sup>1</sup>	156.050	156.050	Intership only. Intership only.	
63A <sup>1</sup>	156.175	156.175		
05 <sup>2</sup>	156.250	156.250		
65A	156.275	156.275		
66A	156.325	156.325		
12 <sup>3</sup>	156.600	156.600		
73	156.675	156.675		
14 <sup>3</sup>	156.700	156.700		
74	156.725	156.725		
77 <sup>4</sup>	156.875			
20A <sup>12</sup>	157.000			
<b>Navigational (Bridge-to-Bridge)<sup>5</sup></b>				
13 <sup>6</sup>	156.650	156.650		
67 <sup>7</sup>	156.375	156.375		
<b>Commercial</b>				
01A <sup>1</sup>	156.050	156.050	Intership only. Do.	
63A <sup>1</sup>	156.175	156.175		
07A	156.350	156.350		
67 <sup>7</sup>	156.375			
08	156.400	.....		
09	156.450	156.450		
10	156.500	156.500		
11 <sup>3</sup>	156.550	156.550		
18A	156.900	156.900		
19A	156.950	156.950		
79A	156.975	156.975		
80A	157.025	157.025		
88A <sup>8</sup>	157.425	.....		
72 <sup>14</sup>	156.625	.....		
<b>Digital Selective Calling</b>				
70 <sup>15</sup>	156.525	156.525		

Channel designator	Carrier frequency (MHz)		Points of communication (Intership and between coast and ship unless otherwise indicated)	
	Ship transmit	Coast transmit		
<b>Noncommercial</b>				
68 <sup>17</sup>	156.425	156.425	Intership only. Great Lakes only. Do. Intership only.	
09 <sup>16</sup>	156.450	156.450		
69	156.475	156.475		
71	156.575	156.575		
72	156.625	.....		
78A	156.925	156.925		
79A	156.975	156.975		
80A	157.025	157.025		
67 <sup>14</sup>	156.375	.....		
<b>Distress, Safety and Calling</b>				
16	156.800	156.800		EPRIB
<b>Intership Safety</b>				
06	156.300	.....		a. Intership, or b. For SAR: Ship and aircraft for the U.S. Coast Guard.
<b>Environmental</b>				
15 <sup>13</sup>	.....	156.750	Coast to ship only.	
<b>Maritime Control</b>				
17 <sup>9,10</sup>	156.850	156.850		
<b>Liaison, U.S. Coast Guard</b>				
22A <sup>11</sup>	157.100	157.100	Ship, aircraft, and coast stations of the U.S. Coast Guard and at Lake Mead, Nev., ship and coast stations of the National Park Service, U.S. Department of the Interior.	

- 1: 156.050 MHz and 156.175 MHz are available for port operations and commercial communications purposes when used only within the U.S. Coast Guard designated Vessel Traffic Services (VTS) area of New Orleans, on the lower Mississippi River from the various pass entrances in the Gulf of Mexico to Devil's Swamp Light at River Mile 242.4 above head of passes near Baton Rouge.
- 2: 156.250 MHz is available for port operations communications use only within the U.S. Coast Guard designated VTS radio protection areas of New Orleans and Houston described in Sec. 80.383. 156.250 MHz is available for intership port operations communications used only within the area of Los Angeles and Long Beach harbors, within a 25- nautical mile radius of Point Fermin, California.
- 3: 156.550 MHz, 156.600 MHz and 156.700 MHz are available in the U.S. Coast Guard designated port areas only for VTS communications and in the Great Lakes available primarily for communications relating to the movement of ships in sectors designated by the St. Lawrence Seaway Development Corporation or the U.S. Coast Guard. The use of these frequencies outside VTS and ship movement sector protected areas is permitted provided they cause no interference to VTS and ship movement communications in their respective designated sectors.

- 4: Use of 156.875 MHz is limited to communications with pilots regarding the movement and docking of ships. Normal output power must not exceed 1 watt.
- 5: 156.375 MHz and 156.650 MHz are available primarily for intership navigational communications. These frequencies are available between coast and ship on a secondary basis when used on or in the vicinity of locks or drawbridges. Normal output power must not exceed 1 watt. Maximum output power must not exceed 10 watts for coast stations or 25 watts for ship stations.
- 6: On the Great Lakes, in addition to bridge-to-bridge communications, 156.650 MHz is available for vessel control purposes in established vessel traffic systems. 156.650 MHz is not available for use in the Mississippi River from South Pass Lighted Whistle Buoy "2" and Southwest Pass entrance Midchannel Lighted Whistle Buoy to mile 242.4 above Head of Passes near Baton Rouge. Additionally it is not available for use in the Mississippi River-Gulf Outlet, the Mississippi River-Gulf Outlet Canal, and the Inner Harbor Navigational Canal, except to aid the transition from these areas.
- 7: Use of 156.375 MHz is available for navigational communications only in the Mississippi River from South Pass Lighted Whistle Buoy "2" and Southwest Pass entrance Mid-channel Lighted Whistle Buoy to mile 242.4 above head of Passes near Baton Rouge, and in addition over the full length of the Mississippi River-Gulf Outlet Canal from entrance to its junction with the Inner Harbor Navigation Canal, and over the ull length of the Inner Harbor Navigation Canal from its junction with the Mississippi River to its entry to Lake Pontchartrain at the New Seabrook vehicular bridge.
- 8: Within 120 km (75 miles) of the United States/Canada border, in the area of the Puget Sound and the Strait of Juan de Fuca and its approaches, 157.425 MHz is half of the duplex pair designated as Channel 88. In this area, Channel 88 is available to ship stations for communications with public coast stations only. More than 120 km (75 miles) from the United States/Canada border in the area of the Puget Sound and the Strait of Juan de Fuca, its approaches, the Great Lakes, and the St. Lawrence Seaway, 157.425 MHz is available for intership and commercial communications. Outside Puget Sound area and its approaches and the Great Lakes, 157.425 MHz is also available for communications between commercial fishing vessels and associated aircraft while engaged in commercial fishing activities.
- 9: When the frequency 156.850 MHz is authorized, it may be used additionally for search and rescue training exercises conducted by state or local governments.
- 10: The frequency 156.850 MHz is additionally available to coast stations on the Great Lakes for transmission of scheduled Coded Marine Weather Forecasts (MAFOR), Great Lakes Weather Broadcast (LAWEB) and nscheduled Notices to Mariners or Bulletins. F3C and J3C emissions are permitted. Coast Stations on the Great Lakes must cease weather broadcasts which cause interference to stations operating on 156.800 MHz until the interference problem is resolved.
- 11: The frequency 157.100 MHz is authorized for search and rescue training exercises by state or local government in conjunction with U.S. Coast Guard stations. Prior U.S. Coast Guard approval is required. Use must cease immediately on U.S. Coast Guard request.
- 12: The duplex pair for channel 20 (157.000/161.600 MHz) may be used for ship to coast station communications.
- 13: Available for assignment to coast stations, the use of which is in accord with an agreed program, for the broadcast of information to ship stations concerning the environmental conditions in which vessels operate, i.e., weather; sea conditions; time signals; notices to mariners; and hazards to navigation.
- 14: Available only in the Puget Sound and the Strait of Juan de Fuca.
- 15: The frequency 156.525 MHz is to be used exclusively for distress, safety and calling using digital selective calling techniques. No other uses are permitted.
- 16: The frequency 156.450 MHz is available for intership, ship and coast general purpose calling by noncommercial vessels, such as recreational boats and private coast stations.
- 17: The frequency 156.425 MHz is assigned by rule to private coast stations in Alaska for facsimile transmissions as well as voice communications.

---

# 25. TECHNICAL TESTS

---

## 25.0 SYSTEM TEST

---

If you have connected your GPS chartplotter according to the instructions, and chosen the proper menu selection for your device, and are still having problems with your GPS chartplotter, the extended auto-test should help determine the problem. Make sure the GPS chartplotter is turned Off. While pressing and holding any other key, turn the GPS chartplotter On. SYSTEM TEST menu will appear on the display:

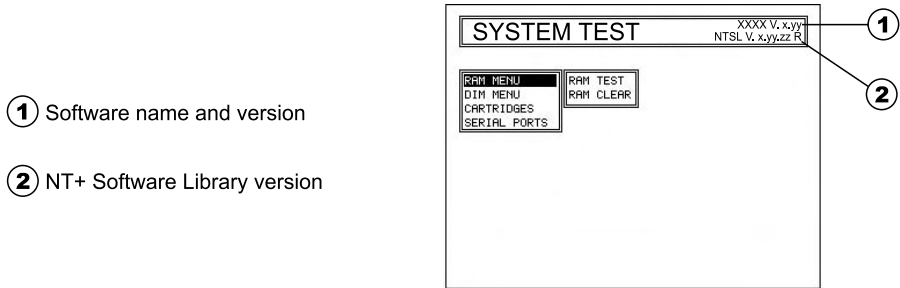

Figure 20.0 - System Test

Use the ShuttlePoint knob to select the desired test. Choose the test, press **[ENT]**. To exit from any submenu press **[CLR]**. To exit from the System Test turn Off the GPS chartplotter.

### 25.0.0 RAM Menu (reset)

This test verifies the integrity of the memories and if desired during this test all the internal memory can be erased and the default setting restored.

#### RAM Test

To verify the integrity of the RAM. If on the screen the message **ERROR** appears, the RAM is physically damaged. Contact your Dealer or STANDARD HORIZON.

#### RAM Clear

To clear internal memory. If the GPS chartplotter exhibits unusual operations, or appears to be malfunctioning, it may be possible to correct the problem by clearing RAM.

This operation will erase all Marks, Routes, stored Track plots and Destinations. It will also return all selections (Input Data Format, Autopilot selection, etc.) to original default values. To confirm clear RAM press **[ENT]** again (but if at this time you do not wish to clear RAM press **[CLR]**).

### 25.0.1 DIM Menu

To select the desired value for brightness and keypad light.

#### Contrast

Each time you move the ShuttlePoint knob to right, the screen will decrease brightness, move it to the left to increase brightness.

#### Backlight

The second option allows to set the backlight. Operates in similar mode as Contrast.

## 25.0.2 Cartridges

To check the C-CARD and its connector.

### Background ROM

To test the WorldWideBackground. If there is not a malfunction, the code of the Background and the message "OK" are shown, but if the Background is defective the message "Faulty" is shown.

### C-CARD Test

To test the C-CARD. There are the possible situations:

1. if there is a C-CARD inserted in the slot and there is not a malfunction, the name of the C-CARD zone and the message "OK" are shown.
2. if there is a C-CARD inserted in the slot, but it is a defective C-CARD, the name of the C-CARD zone and the message "Faulty" are shown.
3. if there is not any C-CARD inserted in the slot, the message "not present" is shown.
4. if there is a User C-CARD inserted in the slot, the message **USER C-CARD** is shown.

### C-CARD Connector

Indicates if there is a malfunction in the connector.

## 25.0.3 Serial Ports

If you are having problems receiving data from the position-finding instrument, this test should help determine the problem.

### Change Parameters

To change the parameters of the serial interface. This menu allows to select the **Port** (Signal Source), the **Baud Rate**, the **Data Bits** (Word Length), the **Parity**, the **Stop Bits**.

### Input Data Display

To allow the GPS chartplotter to act as a computer terminal and display the incoming data exactly as it is received. If the data displayed on the screen is unrecognizable, you may have selected the wrong input parameters for your particular receiver, for example, Baud Rate 9600 instead of Baud Rate 4800. Check your receiver manual to be sure that you have selected the proper parameter. If the screen is blank, you may have a broken connection, and no data is being received or you may have connected the device to the other input port. Use **[ZOOM]** to stop (or continue after pause) data displaying, **[ENT]** to show data in hex or ASCII mode (normal or small) and **[CLR]** to exit.

## 25.0.4 Modem test

Checks the Modem connections (to be used only if the C-COM Modem is connected). Press **[ENT]** to select the desired Modem Port to the Port to which the Modem C-COM is connected.

---

## 26. WARRANTY

---

### 26.0 MARINE PRODUCTS LIMITED WARRANTY

---

STANDARD HORIZON (a division of Vertex Standard) warrants, to the original purchaser only, each new Marine Communications Product ("Product") manufactured and/or supplied by STANDARD HORIZON against defects in materials and workmanship under normal use and service for a period of time from the date of purchase as follows:

#### Fixed Mount and Portable Transceivers

- 1 year - if purchased before 01/01/91
- 3 years - if purchased between 01/01/91 and 01/01/94
- 3 years Waterproof - if purchased after 01/01/94

#### Loud hailers

- 1 year - if purchased before 01/01/91
- 3 years - if purchased after 01/01/91

#### Associated Chargers

- 1 year - if purchased before 01/01/91
- 3 years - if purchased after 01/01/91

**Associated Batteries** - 1 year. Note: Batteries will be deemed defective only if storage capacity drops below 80% of rated capacity or if leakage develops.

**Associated Accessories** - 1 year. Includes: Microphones/Handsets, External Speakers, Antennas, Carrying Accessories, Power Supplies, and Signaling Boards.

To receive warranty service, the purchaser must deliver the Product, transportation and insurance prepaid, to STANDARD HORIZON (a division of Vertex Standard), Attention Marine repairs 10900 Walker Street, Cypress, CA 90630. Include proof of purchase indicating model, serial number, and date of purchase. STANDARD HORIZON will return the Product to the purchaser freight prepaid. Products purchased prior to January 1, 1991 will bear the STANDARD HORIZON warranty terms in effect prior to that date.

In the event of a defect, malfunction or failure of the Product during the warranty period, STANDARD HORIZON's liability for any breach of contract or any breach of express or implied warranties in connection with the sale of Products shall be limited solely to repair or replacement, at its option, of the Product or part(s) therein which, upon examination by STANDARD HORIZON, appear to be defective or not up to factory specifications. STANDARD HORIZON may, at its option, repair or replace parts or subassemblies with new or reconditioned parts and subassemblies. Parts thus repaired or replaced are warranted for the balance of the original applicable warranty.

STANDARD HORIZON will not warrant installation, maintenance or service of the Products. In all instances, STANDARD HORIZON's liability for damages shall not exceed the purchase price of the defective Product.

This warranty only extends to Products sold within the 50 States of the United States of America and the District of Columbia.



STANDARD HORIZON will pay all labor to repair the product and replacement parts charges incurred in providing the warranty service except where purchaser abuse or other qualifying exceptions exist. The purchaser must pay any transportation expenses incurred in returning the Product to STANDARD HORIZON for service.

This limited warranty does not extend to any Product which has been subjected to misuse, neglect, accident, incorrect wiring by anyone other than STANDARD HORIZON, improper installation, or subjected to use in violation of instructions furnished by STANDARD HORIZON, nor does this warranty extend to Products on which the serial number has been removed, defaced, or changed. STANDARD HORIZON cannot be responsible in any way for ancillary equipment not furnished by STANDARD HORIZON which is attached to or used in connection with STANDARD HORIZON's Products, or for the operation of the Product with any ancillary equipment, and all such equipment is expressly excluded from this warranty. STANDARD HORIZON disclaims liability for range, coverage, or operation of the Product and ancillary equipment as a whole under this warranty. STANDARD HORIZON reserves the right to make changes or improvements in Products, during subsequent production, without incurring the obligation to install such changes or improvements on previously manufactured Products.

The implied warranties which the law imposes on the sale of this Product are expressly LIMITED, in duration, to the time period specified above. STANDARD HORIZON shall not be liable under any circumstances for consequential damages resulting from the use and operation of this Product, or from the breach of this LIMITED WARRANTY, any implied warranties, or any contract with STANDARD HORIZON. IN CONNECTION WITH THE SALE OF ITS PRODUCTS, STANDARD HORIZON MAKES NO WARRANTIES, EXPRESS OR IMPLIED AS TO THE MERCHANTABILITY OR FITNESS FOR A PARTICULAR PURPOSE OR OTHERWISE, EXCEPT AS EXPRESSLY SET FORTH HEREIN.

Some states do not allow the exclusion or limitation of incidental or consequential damages, or limitation on how long an implied warranty lasts, so the above limitations or exclusions may not apply. This warranty gives specific legal rights, and there may be other rights which may vary from state to state.

**ONLY PRODUCTS SOLD ON OR AFTER JANUARY 1, 1991 ARE COVERED UNDER THE TERMS OF THIS LIMITED WARRANTY.**

## 26.1 ON-LINE WARRANTY REGISTRATION

---

THANK YOU for buying Marine Division of Vertex Standard products! We are confident your new radio will serve your needs for many years!

Please visit [www.standardhorizon.com](http://www.standardhorizon.com) to register the **GX3000S** Marine VHF. It should be noted that visiting the Web site from time to time may be beneficial to you, as new products are released they will appear on the STANDARD HORIZON Web site. Also a statement regarding product support should be added to the manual.

Product Support Inquiries

If you have any questions or comments regarding the use of the **GX3000S**, you can visit the STANDARD HORIZON Web site to send an E-Mail or contact the Product Support team at (714) 827-7600 ext 6300 M-F 7:00-5:00PST.

In addition to the warranty, STANDARD HORIZON includes a lifetime “flat rate” and “customer loyalty” programs to provide service after the warranty period has expired. If you wish to obtain the flat rate price for out-of-warranty repair, you must include the information on the Owner’s Record with the unit when you return it to your Dealer or to STANDARD HORIZON.

Lifetime Flat Rate Service Program: For the original Owner only, for the lifetime of the unit, STANDARD HORIZON will repair the unit to original specifications.

Note: The flat rate amount is payable by the Owner only if STANDARD HORIZON or the STANDARD HORIZON Dealer determines that a repair is needed. After the repair, a 90-day warranty will be in effect from the date of return of the unit to the Owner.

This service program is not available for equipment which has failed as a result of neglect, accident, breakage, misuse, improper installation or modification, or water damage (depending on the product).



---

## 27. SPECIFICATIONS

---

### 27.0 CPV350 SPECIFICATIONS

---

#### 27.0.0 GENERAL

Input Voltage:	13.8 VDC $\pm$ 20 %
Current drain:	1.2 A (Standby) 1.7 A (Receive) 6.5 A (Transmit)
Dimensions:	6.7" x 10.9" x 5.4" (170 x 276 x 138 mm) (H x W x D)
Flush-Mount Dimensions:	5.4" x 7.2" x 4.9" (136 x 183 x 124 mm) (H x W x D)
Weight:	4.8 lbs (2.2 kg)
Display:	7 inch TFT 256 Color LCD (800 x 480 resolution)

#### 27.0.1 TRANSMITTER

RF Output:	25 / 1W
Conducted Spurious Emissions:	80 dB(Hi); 60 dB(Lo)
Modulation:	16K0F3E, for DSC 16K0G2B
Frequency Stability:	$\pm$ 0.0005 %
FM Hum and Noise:	50dB

#### 27.0.2 RECEIVER

Sensitivity:	0.25 $\mu$ V (12 dB SINAD) 0.28 $\mu$ V (12 dB SINAD, 70CH Receiver)
Squelch Sensitivity:	0.15 $\mu$ V
Selectivity (TYP.):	-80 dB (Spurious and Image Rejection) -80 dB (Intermodulation and Rejection at 12dB SINAD)
Audio output:	4.5 W
Frequency Stability:	$\pm$ 0.0005%
DSC format:	Class D EN301 025 V1.2
NMEA input/Output:	Output - DSC, DSC Input - GLL, GGA, RMC, GNS
Hailer power:	30 W

#### 27.0.3 GPS CHART PLOTTER

User Points (Marks/Waypoints):	1000
Routes:	20 (Max. 50 Waypoints each)
Track Points:	1000
NMEA Input Output:	3 Input/Output Interface NMEA-0183
Cartography:	C-MAP NT*/MAX C-CARD
NMEA sentences:	GLL, VTG, BWC, WCV, APA, APB, HDG, BOD, XTE, RMA, RMB, RMC, GGA, HSC, DBT, DPT, MTW, AND VHW

## 27.1 GPS WAAS SMART RECEIVER SPECIFICATIONS

---

This GPS WAAS Smart Receiver is based on a 12 channel GPS engine that delivers accuracy better than three meters by decoding the GPS correction signals from the satellite-based WAAS (*Wide Area Augmentation System*). The GPS engine, interface electronics and the passive antenna are enclosed inside the waterproof plastic housing. This provides advanced state of the art GPS performance in an easy to use package.

### 27.1.0 PHYSICAL CHARACTERISTICS

<b>Color:</b>	Ivory white
<b>Dimensions:</b>	97 mm in diameter x 32 mm in height (flush mounted) or 61,5 mm on flagpole mount
<b>Weight (without cable):</b>	5.6 oz (160 g)
<b>Cable GPH 10:</b>	white 15 meter 8x28AWG cable with 6 pins female connector

### 27.1.1 ELECTRICAL CHARACTERISTICS

<b>Input Voltage:</b>	10 VDC to 35 VDC unregulated
<b>Input Current:</b>	112 mA @ 12 VDC 60 mA @ 24 VDC 45 mA @ 35 VDC
<b>GPS Receiver Sensitivity:</b>	-145 dBW minimum

### 27.1.2 GPS PERFORMANCE

<b>Receiver:</b>	WAAS (North America), EGNOS (Europe), MSAS (Asia)
<b>Geodetic Datum:</b>	WGS84
<b>Channels:</b>	12
<b>Frequency:</b>	1575.42 MHz (L1, C/A code)

#### ACQUISITION TIME (Approximate)

<b>Reacquisition:</b>	less than 1 second
<b>Hot Start:</b>	8 seconds (typical)
<b>Warm Start:</b>	< 40 seconds (typical)
<b>Cold Start:</b>	< 45 seconds (typical)

#### ACCURACY

<b>Position:</b>	less than 10' (3 m), 95 % of the time
<b>Speed:</b>	0.3 Knots RMS

#### NMEA OUTPUT MESSAGES/UPDATE RATE

<b>GGA:</b>	1 second
<b>GLL:</b>	1 second
<b>VTG:</b>	1 second
<b>RMC:</b>	1 second
<b>GSA:</b>	3 seconds
<b>GSV:</b>	3 seconds
<b>PCMPD:</b>	1 second

---

## 28. APPENDIX: TERMS

---

**ALT** (Altitude) – Shows the Altitude of the vessel.

**APP Wind DIR SPD** (Apparent Wind Direction) – Shows the Apparent Wind Direction when an external wind instrument with NMEA is connected.

**APP Wind SPD** (Apparent Wind Speed) – Shows the Apparent Wind Speed when an external wind instrument with NMEA is connected.

**BRG** (Bearing) – The direction from your current position to a Destination point.

**COG** (Course Over Ground) – The course your vessel is heading.

**DATE** – Shows the current date received by the GPS.

**DEPTH** – Shows the water depth when the optional FF520 50/200kHz BLACK BOX FISH FINDER or Digital Depth Sounder is connected.

**DRAUGHT** – Tide height value referred to Horizontal cursor.

**DSC** (Digital Selective Calling) – Digital Selective Calling is a semi-automated method of establishing a VHF Radio call. DSC had also been designated as part of the Global Maritime Distress and Safety System (GMDSS). It is planned that DSC will eventually replace aural watches on distress frequencies and will be used to announce routine and urgent maritime safety information broadcasts.

**DST** (Distance) – The distance from your current position to a Destination point.

**ETA** – Estimated Time of Arrival

**GPS Constellation** – The Global Positioning System (GPS) is a space-based radio-navigation system consisting of a constellation of satellites and a network of ground stations used for monitoring and control. A minimum of 24 GPS satellites orbit the Earth at an altitude of approximately 11,000 miles providing users with accurate information on position, velocity and time anywhere in the world and in all weather conditions.

**GPS2D** – The GPS is receiving at least 2 valid satellites.

**GPS3D** – The GPS is receiving at least 3 Satellites.

**HDG** (Heading) – Shows heading from an External Flux Gate Compass when connected.

**HDOP/VDOP** – Horizontal/Vertical Dilution of Precision. It is a parameter indicating the precision of the positioning system (GPS). The smaller the HDOP/VDOP value, the more accurately the position fix is provided.

**HEIGHT** – The current tide height referred to the vertical cursor.

**HIGH WATER** – The maximum level of the tide height in 24 hours.

**LOW WATER** – The minimum level of the tide height in 24 hours.

**Position Request** – Marine DSC VHF Function of transmitting a GPS position to another Marine DSC VHF. When GPS chartplotter is connected to STANDARD HORIZON GPS the position of another vessel is shown on the Chart page.

**SPEED** – Shows the Speed Thru the Water when a Digital Speed Log is connected.

**SOG** (Speed Over Ground) – The speed you vessel is traveling at.

**STEER** – Heading to steer to destination Waypoint.

**TIME** – Shows the current time received by the GPS.

**TRIP LOG** – Shows the distance the vessel has traveled since the trip log was reset.

**TRU Wind DIR SPD** (Apparent Wind Direction) – Shows the True Wind Direction when a external wind instrument with NMEA is connected.

**TRU Wind SPD** (Apparent Wind Speed) – Shows the True Wind Speed when a external wind instrument with NMEA is connected.

**TTG** (Time To Go) – Shows time to go to reach a Destination point.

## **UNITS**

**Nm** Nautical Mile (1 NM = 1.15 Sm or 1.85Km)

**Sm** Statue Mile (1Sm = 0.87Nm or 1.61Km)

**Km** Kilometer (1 Kilometer = 0062 Sm or 0.54Nm)

**FT** Feet. (1 Foot = 0.167 Fathoms or 0.305 Meters)

**FA** Fathom (1 Fathom = 6 Feet or 1.83 Meters)

**Mt** Meter (1 Meter = 3.28 Feet or 0.55 Fathoms)

**Kts** Knot (1 Knot = 1.15 MPH or 1.85 KPH)

**MPH** Miles Per Hour (1 MPH = 0.87 Knots or 1.61 KPH)

**Kmh** Kilometer Per Hour (1 KPH = 0.54 Knots or 0.62 MPH)

**VMG** – It is the destination closing Velocity. The VMG is calculated using the current speed of the vessel (SOG) and the difference between the current vessel course and the bearing to the Destination.

**WAAS 2D/3D** – The GPS is receiving a 2D or 3D position and the correction from the WAAS Satellite. WAAS consists of approximately 25 ground reference stations positioned across the United States that monitor GPS satellite data. Two master stations, located on either coast, collect data from the reference stations and create a GPS correction message. This correction accounts for GPS satellite orbit and clock drift plus signal delays caused by the atmosphere and ionosphere. The corrected differential message is then broadcast through one of two geostationary satellites, or satellites with a fixed position over the equator. The information is compatible with the basic GPS signal structure, which means any WAAS-enabled GPS receiver can read the signal.

**WATER TEMP** – Shows the sea water temperature when the FF520 50/200kHz BLACK BOX FISH FINDER or a Digital Speed Log/Temp instrument with NMEA is connected.

**XTE** (Cross Track Error) – The distance your vessel is off course (left or right) to a Destination point.



**Marine Division of VERTEX STANDARD  
US Headquarters**

10900 Walker Street, Cypress, CA 90630, U.S.A.

**[www.standardhorizon.com](http://www.standardhorizon.com)**



Copyright 2006  
VERTEX STANDARD CO., LTD.  
All rights reserved.

No portion of this manual  
may be reproduced  
without the permission of  
VERTEX STANDARD CO., LTD.

0603b-0E



## Free Manuals Download Website

<http://myh66.com>

<http://usermanuals.us>

<http://www.somanuals.com>

<http://www.4manuals.cc>

<http://www.manual-lib.com>

<http://www.404manual.com>

<http://www.luxmanual.com>

<http://aubethermostatmanual.com>

Golf course search by state

<http://golfingnear.com>

Email search by domain

<http://emailbydomain.com>

Auto manuals search

<http://auto.somanuals.com>

TV manuals search

<http://tv.somanuals.com>