

SHARP®

MODEL: MX-5500N
MX-6200N
MX-7000N

Scanner Guide

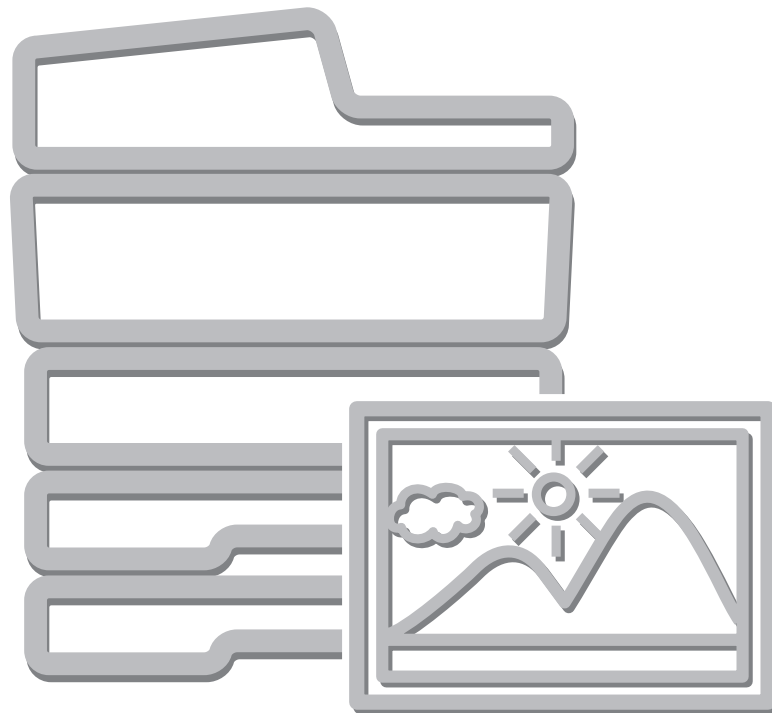

TABLE OF CONTENTS

| | |
|---|---|
| ABOUT THIS MANUAL | 4 |
| • MANUALS PROVIDED WITH THE MACHINE ... | 5 |

1 BEFORE USING THE MACHINE AS A NETWORK SCANNER

| | |
|--|----|
| NETWORK SCANNER FUNCTION | 6 |
| PREPARATIONS FOR USE AS A NETWORK SCANNER | 8 |
| • MAKE SURE THE MAIN POWER SWITCH IS IN THE "ON" POSITION. | 8 |
| • CHECKING THE DATE AND TIME | 8 |
| • STORING SENDER INFORMATION | 9 |
| • SETTINGS REQUIRED IN THE WEB PAGES ... | 9 |
| • STORING DESTINATION ADDRESSES FOR EACH SCAN MODE IN THE ADDRESS BOOK. | 9 |
| • STORING A DESTINATION FOR SCAN TO DESKTOP | 10 |
| BASE SCREEN | 11 |
| • ADDRESS BOOK SCREEN. | 14 |
| • CHANGING THE DISPLAY OF ONE-TOUCH KEYS IN THE ADDRESS BOOK SCREEN | 15 |
| SCAN SEND SEQUENCE | 17 |
| ORIGINAL SIZES | 19 |
| • TRANSMITTABLE ORIGINAL SIZES | 19 |
| • THE SIZE OF THE PLACED ORIGINAL | 19 |

2 ENTERING DESTINATIONS

| | |
|---|----|
| RETRIEVING A DESTINATION FROM THE ADDRESS BOOK | 20 |
| • RETRIEVING A DESTINATION | 21 |
| • CHECKING AND DELETING THE SELECTED DESTINATIONS | 22 |
| USING A SEARCH NUMBER TO RETRIEVE A DESTINATION | 23 |
| ENTERING AN ADDRESS MANUALLY | 24 |
| RETRIEVING A DESTINATION FROM A GLOBAL ADDRESS BOOK | 25 |
| USING THE RESEND FUNCTION | 27 |

3 TRANSMITTING AN IMAGE

| | |
|--|----|
| SENDING AN IMAGE IN SCAN MODE | 28 |
| • CHANGING THE SUBJECT, FILE NAME, REPLY-TO, AND BODY TEXT | 33 |
| SENDING AN IMAGE IN USB MEMORY MODE | 37 |
| • ENTERING A FILE NAME | 41 |
| SENDING A FAX IN INTERNET FAX MODE | 42 |
| • CHANGING THE SUBJECT, FILE NAME, AND BODY TEXT | 45 |
| SENDING THE SAME IMAGE TO MULTIPLE DESTINATIONS (Broadcast Transmission) | 48 |
| • BROADCAST TRANSMISSIONS THAT INCLUDE INTERNET FAX DESTINATIONS | 51 |
| SENDING AN INTERNET FAX FROM A COMPUTER (PC-I-Fax) | 53 |
| IMAGE SETTINGS | 54 |
| • AUTOMATICALLY SCANNING BOTH SIDES OF AN ORIGINAL (2-Sided Original) | 55 |
| • SPECIFYING THE ORIGINAL SCAN SIZE AND SEND SIZE (Enlarge/Reduce) | 56 |
| • CHANGING THE EXPOSURE AND EXPOSURE MODE (ORIGINAL IMAGE TYPE) .. | 62 |
| • CHANGING THE RESOLUTION | 64 |
| • CHANGING THE FILE FORMAT | 65 |
| • CHANGING THE COLOUR MODE | 69 |

4 SPECIAL MODES

| | |
|---|----|
| SPECIAL MODES | 70 |
| STORING SCAN OPERATIONS (Programs) | 72 |
| ERASING PERIPHERAL SHADOWS ON THE IMAGE (Erase) | 74 |
| SCANNING AN ORIGINAL AS TWO SEPARATE PAGES (Dual Page Scan) | 77 |
| SENDING AN IMAGE AT A SPECIFIED TIME (Timer Transmission) | 79 |
| WHITENING FAINT COLOURS IN THE IMAGE (Suppress Background) | 82 |
| SCANNING BOTH SIDES OF A CARD ONTO A SINGLE PAGE (Card Shot) | 84 |
| SCANNING MANY ORIGINALS AT ONCE (Job Build) | 87 |
| SCANNING ORIGINALS OF DIFFERENT SIZES (Mixed Size Original) | 90 |
| SCANNING THIN ORIGINALS (Slow Scan Mode) .. | 92 |
| SENDING TWO PAGES AS A SINGLE PAGE (2in1) | 94 |
| CHANGING THE PRINT SETTINGS FOR THE TRANSACTION REPORT (Transaction Report) ... | 97 |

5 CHECKING THE STATUS OF TRANSMISSION/RECEPTION JOBS

| | |
|--|-----|
| JOB STATUS SCREEN | 99 |
| • JOB QUEUE SCREEN AND COMPLETED JOB SCREEN | 100 |
| • OPERATION WHEN A JOB IN THE JOB QUEUE IS COMPLETED | 103 |
| • CHECKING COMPLETED JOBS | 104 |
| STOPPING A SCAN JOB BEING TRANSMITTED OR WAITING TO BE TRANSMITTED | 105 |
| GIVING PRIORITY TO A SCAN TRANSMISSION JOB | 106 |
| CHECKING THE INTERNET FAX ACTIVITY LOG (Image Sending Activity Report) | 107 |
| • INFORMATION APPEARING IN THE RESULT COLUMN | 107 |

6 INTERNET FAX RECEPTION FUNCTIONS

| | |
|--|-----|
| RECEIVING AN INTERNET FAX | 108 |
| • MANUALLY RECEIVING INTERNET FAXES .. | 109 |
| PRINTING A PASSWORD-PROTECTED FAX (Hold Setting For Received Data Print) | 110 |
| FORWARDING RECEIVED INTERNET FAXES TO AN E-MAIL ADDRESS (Inbound Routing Settings) | 111 |

7 SCANNING FROM A COMPUTER (PC Scan Mode)

| | |
|--------------------------------|-----|
| BASIC SCANNING PROCEDURE | 112 |
|--------------------------------|-----|

8 METADATA DELIVERY

| | |
|---|-----|
| METADATA DELIVERY (Data Entry) | 117 |
| PREPARATIONS FOR METADATA TRANSMISSION | 118 |
| • SETTINGS REQUIRED IN THE WEB PAGES .. | 118 |
| • METADATA TRANSMISSION FOR SCAN TO DESKTOP | 118 |
| TRANSMITTING METADATA | 119 |
| • METADATA FIELDS | 121 |

ABOUT THIS MANUAL

This manual explains the procedures for using scan mode, USB memory mode, Internet fax mode, PC scan mode, and data entry mode on the machine.

Please note

- To use the Internet fax function, the Internet fax expansion kit must be installed.
- The application integration module is required to use the metadata transmission function.
- For information on installing the drivers and software cited in this manual, please refer to the Software Setup Guide and the manuals that are provided with the expansion kits.
- To use the network scanner function, basic network scanner settings, server settings including SMTP and DNS server settings, and destinations must be configured in the Web pages. Configure and store the settings as explained in this manual. These settings require a knowledge of your network environment and therefore must be configured by your network administrator.
- For information on your operating system, please refer to your operating system manual or the online Help function.
- The explanations of screens and procedures in this manual are primarily for Windows® XP. The screens may vary in other versions of Windows.
- Wherever "MX-xxxx" appears in this manual, please substitute your model name for "xxxx".
- Considerable care has been taken in preparing this manual. If you have any comments or concerns about the manual, please contact your dealer or nearest authorised service representative.
- This product has undergone strict quality control and inspection procedures. In the unlikely event that a defect or other problem is discovered, please contact your dealer or nearest authorised service representative.
- Aside from instances provided for by law, SHARP is not responsible for failures occurring during the use of the product or its options, or failures due to incorrect operation of the product and its options, or other failures, or for any damage that occurs due to use of the product.

Warning

- Reproduction, adaptation or translation of the contents of the manual without prior written permission is prohibited, except as allowed under copyright laws.
- All information in this manual is subject to change without notice.

Illustrations and the operation panel and touch panel shown in this manual

The peripheral devices are generally optional, however, some models include certain peripheral devices as standard equipment. The explanations in this manual assume that a saddle stitch finisher, punch module, and inserter are installed on the machine. For some functions and procedures, the explanations assume that devices other than the above are installed.

The display screens, messages, and key names shown in the manual may differ from those on the actual machine due to product improvements and modifications.

MANUALS PROVIDED WITH THE MACHINE

Printed manuals and manuals stored in PDF format on the machine's hard drive are provided with the machine. When using the machine, read the appropriate manual for the feature you are using.

Printed manuals

| Manual name | Contents |
|-----------------------------|--|
| Safety Guide | This manual contains instructions for using the machine safely and lists the specifications of the machine and its peripheral devices. |
| Software Setup Guide | This manual explains how to install the software and configure settings to use the machine as a printer or scanner. |
| Quick Start Guide | This manual provides easy-to-understand explanations of all the functions of the machine in a single volume. Detailed explanations of each of the functions can be found in the manuals in PDF format. |
| Troubleshooting | This manual explains how to remove paper misfeeds and provides answers to frequently asked questions regarding the operation of the machine in each mode. Refer to this manual when you have difficulty using the machine. |





Operation manuals in PDF format

The manuals in PDF format provide detailed explanations of the procedures for using the machine in each mode. To view the PDF manuals, download them from the hard drive in the machine. The procedure for downloading the manuals is explained in "How to download the manuals in PDF format" in the Quick Start Guide.

| Manual name | Contents |
|------------------------------------|--|
| User's Guide | This manual provides information, such as basic operation procedures, how to load paper, and machine maintenance. |
| Copier Guide | This manual provides detailed explanations of the procedures for using the copy function. |
| Printer Guide | This manual provides detailed explanations of the procedures for using the printer function. |
| Facsimile Guide | This manual provides detailed explanations of the procedures for using the fax function. |
| Scanner Guide (This manual) | This manual provides detailed explanations of the procedures for using the scanner function and the Internet fax function. |
| Document Filing Guide | This manual provides detailed explanations of the procedures for using the document filing function. The document filing function allows you to save the document data of a copy or fax job, or the data of a print job, as a file on the machine's hard drive. The file can be called up as needed. |
| System Settings Guide | This manual explains the "System Settings", which are used to configure a variety of parameters to suit the aims and the needs of your workplace. Current settings can be displayed or printed out from the "System Settings". |

Icons used in the manuals

The icons in the manuals indicate the following types of information:

| | | | |
|---|--|---|--|
|  | This alerts you to a situation where there is a risk of machine damage or failure. |  | This indicates the name of a system setting and a provides a brief explanation of the setting. For detailed information on each system setting, see the System Settings Guide. When "System Settings:" appears: A general setting is explained. When "System Settings (Administrator):" appears: A setting that can only be configured by an administrator is explained. |
|  | This provides a supplemental explanation of a function or procedure. | | |
|  | This explains how to cancel or correct an operation. | | |

1

BEFORE USING THE MACHINE AS A NETWORK SCANNER

This chapter provides information that you should know before using the machine as a network scanner.

NETWORK SCANNER FUNCTION

The network scanner function of the machine can be used to scan an original, create an image file, and send the file over a network to a computer, FTP server, or other destination. Scanning is also possible from your computer using a TWAIN-compliant application.

The network scanner function provides the following scanning modes.

Scan modes

 [SENDING AN IMAGE IN SCAN MODE](#) (page 28)

Scan to E-mail

The scanned file is sent to an e-mail address.



Scan to FTP

The scanned file is sent to a specified directory of an FTP server. When the file is sent, it is also possible to send an e-mail to a previously stored e-mail address to inform the recipient of the location of the file. (This is called "Scan to FTP (Hyperlink)".)



Scan to Desktop

The scanned file is sent to a specified folder on your computer. To use Scan to Desktop, software must be installed from the "Sharpdesk/Network Scanner Utilities" CD-ROM that accompanies the machine. For the system requirements of the software, see the manual (PDF format) or the Readme file on the CD-ROM. For the procedures for installing the software, see the "Sharpdesk Installation Guide".

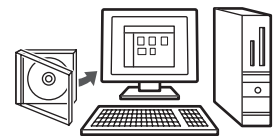

Scan to Network Folder

The scanned file is sent to a shared folder on a Windows computer on the same network as the machine.

Transmission is possible to computers running the following operating systems: Windows 98/Me/NT 4.0/2000/XP/Server 2003



USB memory mode

 [SENDING AN IMAGE IN USB MEMORY MODE](#) (page 37)

USB Memory Scan

The scanned file is sent to and stored in a USB memory device connected to the machine.



Internet fax mode

 [SENDING A FAX IN INTERNET FAX MODE](#) (page 42)

Internet fax transmission

The scanned file is sent as an Internet fax. Reception of Internet faxes is also possible.

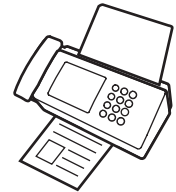

PC scan mode

 [7. SCANNING FROM A COMPUTER \(PC Scan Mode\)](#) (page 112)

PC Scan

A TWAIN-compliant application on a computer connected to the same network as the machine is used to scan a document or image.

To use PC Scan, the scanner driver must be installed from the "Software CD-ROM" that accompanies the machine.

Operating systems that can be used are Windows 98/Me/2000/XP/Server 2003.



Data entry mode

 [8. METADATA DELIVERY](#) (page 117)

Metadata delivery

The application integration module can be combined with the network scanner function to append a metadata* file to a scanned image file. (This is called metadata delivery.)

Information entered using the touch panel or automatically generated by the machine can be sent to a directory on an FTP server or an application on a computer as a metadata file in XML format.

* Metadata is information about a file, how it is to be processed, and its relation to other objects.

PREPARATIONS FOR USE AS A NETWORK SCANNER

MAKE SURE THE MAIN POWER SWITCH IS IN THE "ON" POSITION

The main power is "on" when the main power indicator on the right side of the operation panel is lit.

If the main power indicator is not lit, the main power is "off". Switch the main power switch to the "on" position and press the [POWER] key (⏻) on the operation panel.

If the Internet fax function will be used, and in particular if reception or timer transmission will take place at night, always keep the main power switch in the "on" position.

 When the [POWER SAVE] key (Ⓜ) indicator light is blinking, the machine is in auto power shut-off mode. If the [POWER SAVE] key (Ⓜ) is pressed when the indicator is blinking, the indicator will turn off and the machine will return to the ready state after a brief interval.

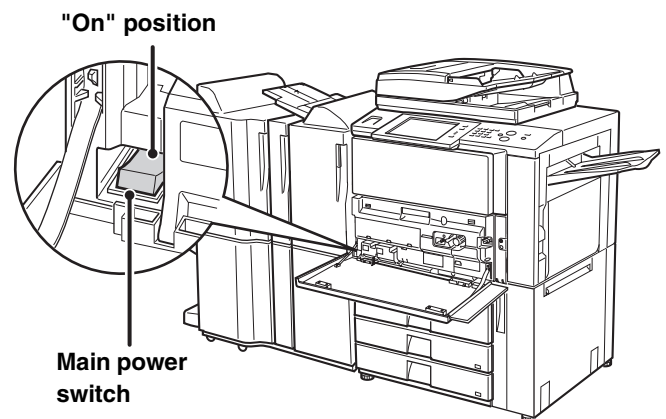
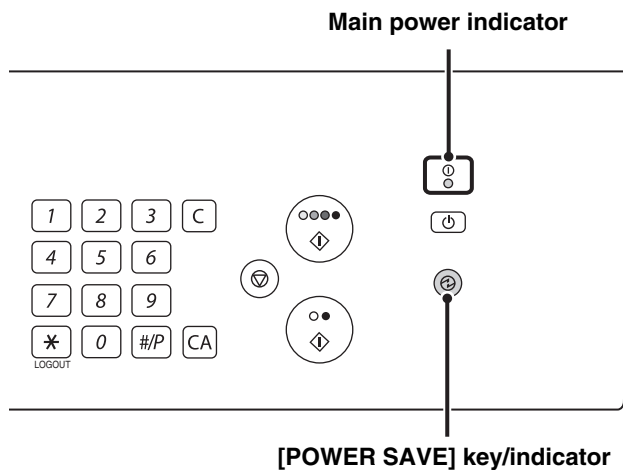

CHECKING THE DATE AND TIME

Verify that the correct date and time are set in the machine.

The date and time are set in the system settings of the machine. When the [SYSTEM SETTINGS] key is pressed, the system settings menu screen appears on the touch panel. Select [Default Settings], [Clock], and [Clock Adjust], and set the year, month, day, hour, and minute.

STORING SENDER INFORMATION

Before using Scan to E-mail

Store a default sender name in "Sender Name" and a reply e-mail address in "Reply E-mail Address". These will be used when a sender is not selected.



System Settings (Administrator): Default Sender Set

This is used to store the sender name and e-mail address that is used when a sender is not selected.

Before using Internet fax

Store a sender name in "Sender Name" and a sender Internet fax address in "Own Address".



System Settings (Administrator): I-Fax Own Name and Address Set

Use this setting to program the sender name and sender address.

SETTINGS REQUIRED IN THE WEB PAGES

In order to use the network scanner function, basic network scanner settings, server settings including SMTP and DNS server settings, and the sender address must be configured in the Web pages.

- **Basic network scanner settings**

To configure network scanner settings, click [Application Settings] and then [Network Scanner Settings] in the Web page menu. (Administrator rights are required.)

- **Server settings**

To configure server settings, click [Network Settings] and then [Services Settings] in the Web page menu. (Administrator rights are required.)

STORING DESTINATION ADDRESSES FOR EACH SCAN MODE IN THE ADDRESS BOOK

To use Scan to FTP, Scan to Desktop, and Scan to Network Folder, destinations must be stored in the address book. Although destinations for Scan to E-mail and Internet fax do not need to be stored in the address book (they can be entered directly or looked up in a global address book at the time of transmission), storing these types of destinations in the address book makes it easy to select them. Store each type of destination as explained below.

Scan mode destinations

- Scan to FTP: Click [Address Book] in the Web page menu and then click the [Add] button. Select [FTP] in [Address Type] and store an address.
- Scan to Network Folder: Click [Address Book] in the Web page menu and then click the [Add] button. Select [Network Folder] in [Address Type] and store an address.
- Scan to E-mail: Click [Address Book] in the Web page menu and then click the [Add] button. Select [E-mail] in [Address Type] and store an address. Addresses can also be stored in the system settings.
- Scan to Desktop: See "[STORING A DESTINATION FOR SCAN TO DESKTOP](#)" (page 10). Scan to Desktop destinations can also be stored in the Web pages. Click [Address Book] in the Web page menu and then click the [Add] button. Select [Desktop] in [Address Type] and store an address.

Internet fax mode: Click [Address Book] in the Web page menu and then click the [Add] button. Select [Internet Fax] in [Address Type] and store an address. Addresses can also be stored in the system settings.



System Settings: Address Book

This is used to store destination addresses for Scan to E-mail and Internet fax.

STORING A DESTINATION FOR SCAN TO DESKTOP

To store your computer in the machine as a destination for Scan to Desktop, Network Scanner Tool must be installed from the "Sharpdesk/Network Scanner Utilities" CD-ROM that accompanies the machine. To scan an image to your computer, Network Scanner Tool must be running on your computer.

INSTALLING NETWORK SCANNER TOOL

To install Network Scanner Tool, see the "Sharpdesk Installation Guide" that accompanies the machine. When a standard installation is performed, Network Scanner Tool is installed with Sharpdesk.

When you restart your computer after installing Network Scanner Tool, the Setup Wizard will start automatically. Follow this wizard to set up Network Scanner Tool. This will store your computer in the machine as a destination for Scan to Desktop. The stored destination will be displayed as a one-touch key in the address book screen.

The following window appears while Network Scanner Tool is being set up. The item selected in "My Profiles" (C) will be the name of the one-touch key.

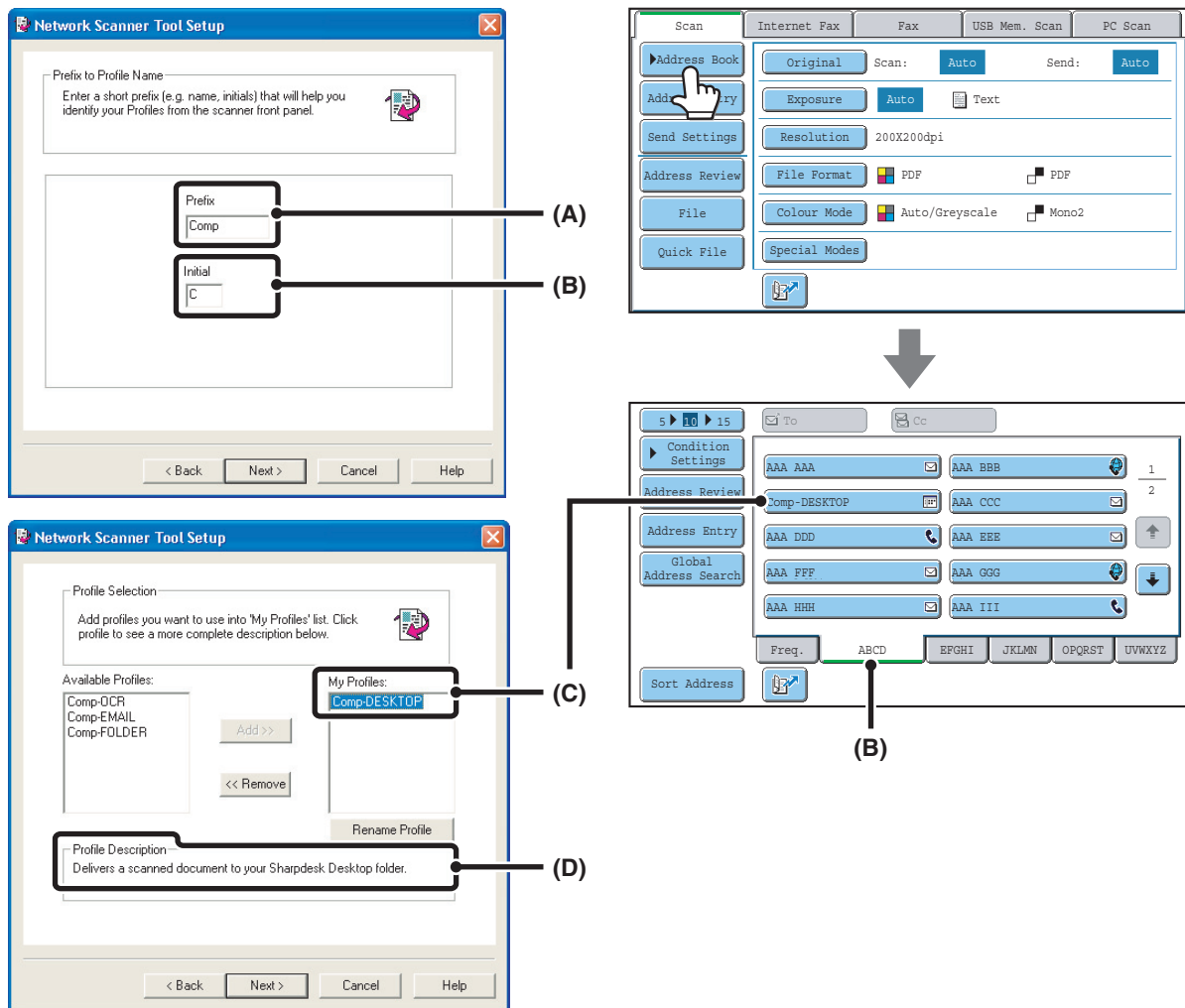

The profile name is determined by the combination of the text entered in "Prefix" (A) and the profile*.

The one-touch key is assigned to an index tab in the address book screen based on the text entered in "Initial" (B).

* This defines how an image sent to your computer is processed. For more information, see profile explanation (D).

ADDING DESTINATIONS

For the number of computers that can be stored in the machine as destinations of Scan to Desktop, see the number of licenses indicated in the "Sharpdesk Installation Guide". To store more destinations, a license kit is required. Store Scan to Desktop destinations by installing Network Scanner Tool on each computer.

BASE SCREEN

Scan mode, USB memory mode, Internet fax mode, and PC scan mode are used by selecting operations and settings in the base screens of those modes. To display the base screen of a mode, touch the [IMAGE SEND] key in the touch panel and then touch the tab of the mode that you wish to use.

Base screen of scan mode

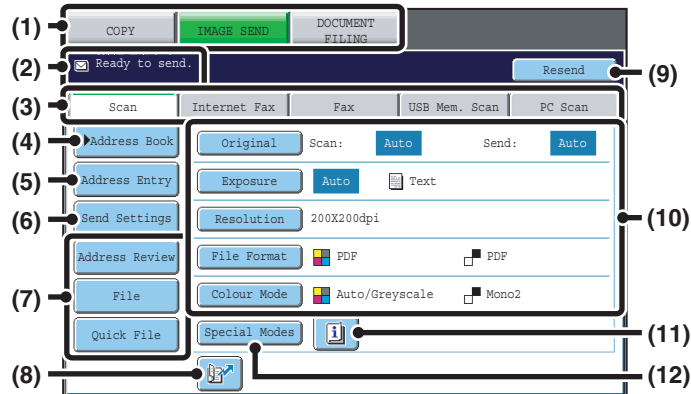

Base screen of USB memory mode

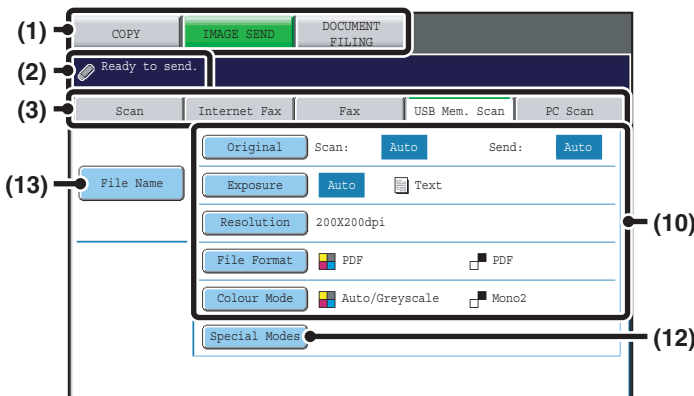

Base screen of Internet fax mode

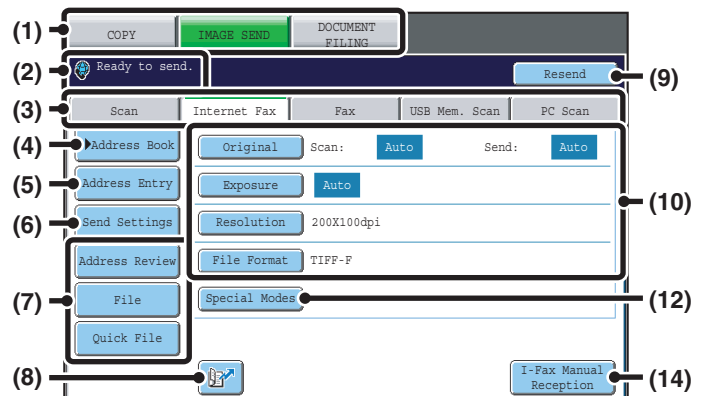

(1) Mode select keys

Use these keys to switch between copy, image send, and document filing modes. To use scan mode, USB memory mode, Internet fax mode, or PC scan mode, touch the [IMAGE SEND] key.

(2) Various messages are displayed here.

The icon of the selected mode appears on the left.

(3) Send mode tabs

Touch one of these tabs to change the image send mode. Tabs of modes that cannot be used because the corresponding options (Facsimile expansion kit, Internet fax expansion kit, or application integration module) are not installed do not appear. If the [USB Mem. Scan] and [PC Scan] tabs do not appear, touch the [Image Send] tab to move the screen. If the [Scan], [Internet Fax], [Fax], and [Data Entry] tabs do not appear, touch the [Image Send] tab to move the screen. The [Data Entry] tab appears when the application integration module is installed. For information on

metadata delivery using the [Data Entry] tab, see "8. METADATA DELIVERY" (page 117).

(4) [Address Book] key

Touch this key to use a one-touch key or a group key. When the key is touched, the address book screen appears. [RETRIEVING A DESTINATION FROM THE ADDRESS BOOK](#) (page 20)

(5) [Address Entry] key

Touch this key to manually enter a destination address instead of using a one-touch key. [ENTERING AN ADDRESS MANUALLY](#) (page 24)

(6) [Send Settings] key

Touch this key to select or enter the subject, file name, sender name, or body text, which has been previously stored in the Web page. Scan modes: [CHANGING THE SUBJECT, FILE NAME, REPLY-TO, AND BODY TEXT](#) (page 33) Internet fax mode: [CHANGING THE SUBJECT, FILE NAME, AND BODY TEXT](#) (page 45)

(7) Customized keys

The keys that appear here can be changed to show settings or functions that you prefer.

➤ [Customizing displayed keys](#) (page 13)

(8)  key

Touch this key to specify a destination using a search number*.

* 3-digit number assigned to a destination when it is stored.

➤ [USING A SEARCH NUMBER TO RETRIEVE A DESTINATION](#) (page 23)

(9) [Resend] key/[Next Address] key

The destinations of the most recent 8 transmissions by Scan to E-mail, fax and/or Internet fax are stored. Touch this key to select one of these destinations. After a destination is selected, this key changes to the [Next Address] key.

➤ [USING THE RESEND FUNCTION](#) (page 27)
➤ [RETRIEVING A DESTINATION](#) (page 21)

(10) Image settings

Image settings (original size, exposure, resolution, file format, and colour mode) can be selected.

➤ [IMAGE SETTINGS](#) (page 54)

(11)  key

This key appears when a special mode or 2-sided scanning is selected. Touch the key to display the selected special modes.

➤ [Checking what special modes are selected](#) (page 13)

(12) [Special Modes] key

Touch this key to use a special mode.

➤ [4. SPECIAL MODES](#) (page 70)

(13) [File Name] key

Touch this key to enter a file name when storing a file to USB memory.

➤ [ENTERING A FILE NAME](#) (page 41)

(14) [I-Fax Manual Reception] key

Touch this key to receive an Internet fax manually.

➤ [MANUALLY RECEIVING INTERNET FAXES](#) (page 109)

When sending an image, you can retrieve and use a stored transmission destination from the address book screen. The address book screen is shared by scan mode, Internet fax mode, and fax mode.

Touch the [Address Book] key in the base screen to switch to the address book screen. Touch the [Condition Settings] key in the address book screen to switch to the base screen.

Base screen of scan mode

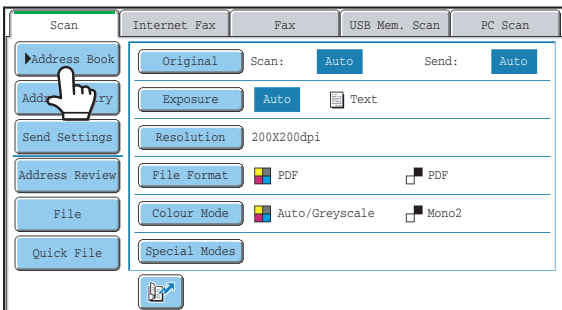

Address book screen

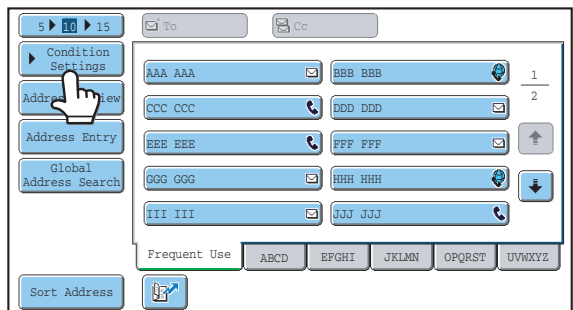

-  This manual uses the base screen of scan mode as an example when operations common to all modes are explained.
- The procedures in this manual assume that the base screen of scan mode appears when the [IMAGE SEND] key is touched.

 System Settings (Administrator): Default Display Settings

One of the following screens can be selected for the initial screen that appears when the [IMAGE SEND] key is touched.

- Base screen of each mode (scan, Internet fax, fax, or data entry mode)
- Address book screen (alphabetical/custom index)

Customizing displayed keys

Special mode keys and other keys can be displayed in the base screen. Set these keys to functions that you frequently use to access the functions with a single touch. The customized keys are configured using "Customize Key Setting" in the Web pages. The following keys appear by factory default:

- **[Address Review] key**

Touch this key to display a list of the destinations that have been selected in the address book. This is the same key as the [Address Review] key in the address book screen.

- **[File] key, [Quick File] key**

Touch either of these keys to use the File function or Quick File function of document filing mode. For more information on the document filing function, see the Document Filing Guide.

In USB memory mode...

Customized keys do not initially appear, however, up to three keys can be added.

Example: When "Dual Page Scan", "Job Build", and "Mixed Size Original" are assigned to the customized keys

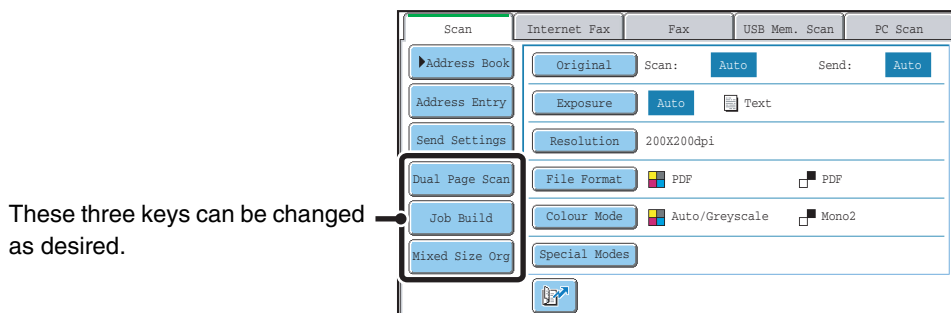

- Displaying a program key in the base screen will enable you to retrieve the program by simply touching the key.
 - ➔ [STORING SCAN OPERATIONS \(Programs\)](#) (page 72)
- The functions that can be selected for the customized keys vary depending on the mode.



System Settings (Administrator): Customize Key Setting

Registration is performed in [System Settings] - [Operation Settings] - "Customize Key Setting" in the Web page menu.

Checking what special modes are selected

The key appears in the base screen when a special mode or 2-sided scanning is selected.

The key can be touched to display the selected special modes. To close the screen, touch the [OK] key.

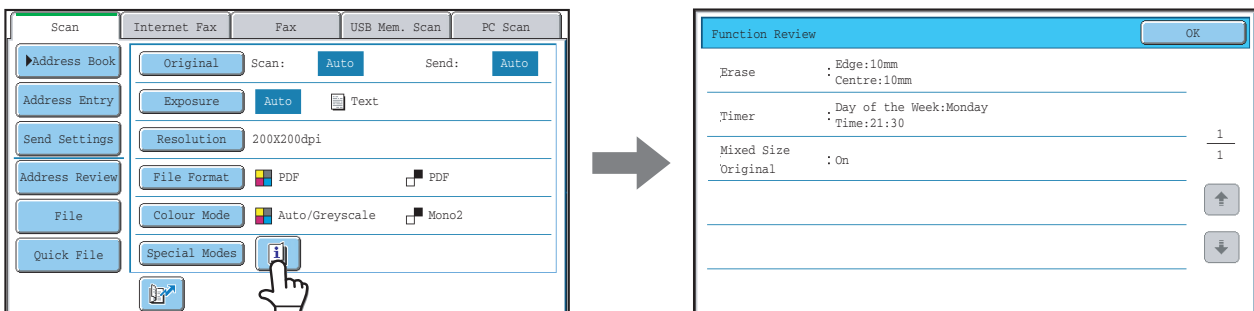

The special mode settings cannot be changed from the review screen. To change a setting, touch the [OK] key to close the review screen and then touch the [Special Modes] key and select the setting that you wish to change.

ADDRESS BOOK SCREEN

This screen is used to select transmission destinations.

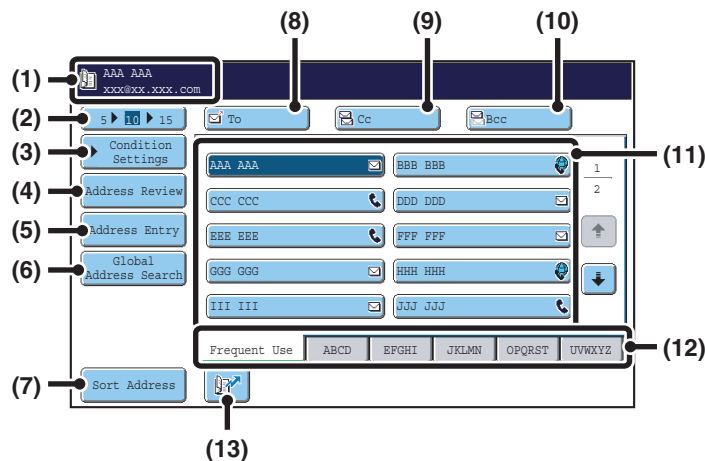

(1) This shows the selected destination.

(2) **Number of displayed items selector key**

Touch this key to change the number of destinations (one-touch keys) displayed in the address book screen. Select 5, 10, or 15 keys.

(3) **[Condition Settings] key**

Touch this key to select transmission settings. When the key is touched, the base screen appears.
[BASE SCREEN](#) (page 11)

(4) **[Address Review] key**

Touch this key to view a list of the selected destinations. Destination selections can be changed.
[CHECKING AND DELETING THE SELECTED DESTINATIONS](#) (page 22)

(5) **[Address Entry] key**

Touch this key to manually enter a destination address instead of using a one-touch key.
[ENTERING AN ADDRESS MANUALLY](#) (page 24)

(6) **[Global Address Search] key**

When the use of an LDAP server has been enabled in the machine's Web pages, a transmission address can be obtained from a global address book.
[RETRIEVING A DESTINATION FROM A GLOBAL ADDRESS BOOK](#) (page 25)

(7) **[Sort Address] key**

Touch to change the index tabs to custom indexes or to display one-touch keys by send mode.
[CHANGING THE DISPLAY OF ONE-TOUCH KEYS IN THE ADDRESS BOOK SCREEN](#) (page 15)

(8) **[To] key**

Touch this key to enter the selected destination (one-touch key).
[RETRIEVING A DESTINATION](#) (page 21)

(9) **[Cc] key**

When using Scan to E-mail, touch the [Cc] key when you wish to send a "Carbon copy" of the e-mail to an additional destination.

(10) **[Bcc] key**

When using Scan to E-mail, touch the [Bcc] key when you wish to send a "Blind carbon copy" of the e-mail to an additional destination. When an address is specified as a Bcc recipient, other recipients will not know that the address is a recipient. This key only appears when Bcc has been enabled using "Bcc Setting" in the system settings (administrator).

(11) **One-touch key display**

The destinations (one-touch keys) stored in each index are displayed. This manual refers to keys in which destinations and groups are stored as one-touch keys.
[RETRIEVING A DESTINATION](#) (page 21)

(12) **Index tabs**

Touch this to change the displayed index tab.
[Index display](#) (page 16)

(13) **key**

Touch this key to specify a destination using a search number*.
 * A 3-digit number assigned to a one-touch key or group key when it is stored.
[USING A SEARCH NUMBER TO RETRIEVE A DESTINATION](#) (page 23)

- Icons appear in the one-touch keys in the address book to indicate which mode is used for transmission.
 - ➔ [RETRIEVING A DESTINATION FROM THE ADDRESS BOOK](#) (page 20)
- For information on storing addresses in the address book, see "[STORING DESTINATION ADDRESSES FOR EACH SCAN MODE IN THE ADDRESS BOOK](#)" (page 9).
- To store destinations for Scan to Desktop, Network Scanner Tool must be installed from the CD-ROM that accompanies the machine. For more information on storing destinations for Scan to Desktop, see "[STORING A DESTINATION FOR SCAN TO DESKTOP](#)" (page 10).

- **System Settings: Address Book**
This is used to store Scan to E-mail and Internet fax addresses in one-touch keys.
- **System Settings (Administrator): The Number of Direct Address Keys Displayed Setting**
This is used to change the default setting for the number of one-touch keys displayed in the address book screen.
- **System Settings (Administrator): Bcc Setting**
This setting enables or disables Bcc delivery. When enabled, the [Bcc] key appears in the address book screen.
- **System Settings (Administrator): Default Display Settings**
One of the following screens can be selected for the initial screen that appears when the [IMAGE SEND] key is touched.
 - Base screen of each mode (scan, Internet fax, fax, or data entry mode)
 - Address book screen (alphabetical/custom index)

CHANGING THE DISPLAY OF ONE-TOUCH KEYS IN THE ADDRESS BOOK SCREEN

You can show destinations of only a specific transmission mode in the address book screen, or change the displayed index tabs from the alphabetical tabs to the custom tabs. The procedure for selecting destinations does not change.

1

Touch the [Sort Address] key.

2

Change the display mode.

(1) Touch the key of the mode or tab that you wish to display.

- To show only the one-touch keys of a particular send mode, touch the desired mode key under "Address Type".
- To change the index tabs to the custom indexes, touch the [User] key under "Tab Switch".

(2) Touch the [OK] key.

Index display

Indexes make it easy to search for a destination (one-touch key). Destinations are grouped on alphabetical index tabs. To display a stored destination, touch the appropriate index tab. It is convenient to store frequently used destinations in the [Frequent Use] index. Specify that a destination be displayed in the [Frequent Use] index when you store the destination.

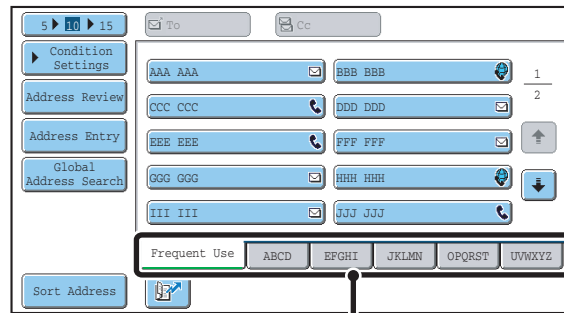

Index tabs

The destinations can also be displayed in alphabetical order by initial.

Each time the displayed index tab is touched, the display order changes in the following order: search numbers (page 23), ascending names, descending names. When the display order is changed, the display order of the other index tabs also changes.

Ordered by search number (default)

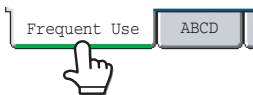

Ascending names



Descending names



Index names can be changed using "Custom Index" in the system settings, allowing you to create groups of one-touch keys that can be easily recognized. For more information on "Custom Index", see the System Settings Guide.



System Settings: Custom Index

This setting is used to store custom index names. The custom index where a one-touch key appears is specified when the transmission destination is stored in the key.

SCAN SEND SEQUENCE

This section explains the basic procedure for scanning and transmission. Select settings in the order shown below to ensure smooth transmission.

For the detailed procedures for selecting the settings, see the explanation of each setting in this manual.

Place the original.

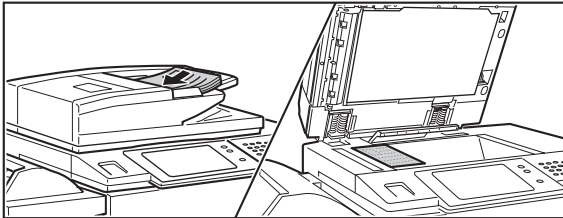

Place the original in the document feeder tray of the automatic document feeder, or on the document glass.

- [SENDING AN IMAGE IN SCAN MODE](#) (page 28)
- [SENDING AN IMAGE IN USB MEMORY MODE](#) (page 37)
- [SENDING A FAX IN INTERNET FAX MODE](#) (page 42)



Change the mode.

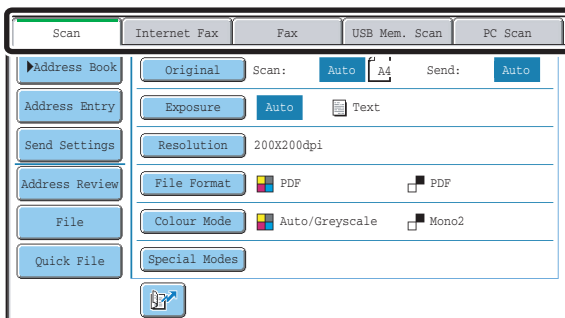

Select the mode that you wish to use for scanning and transmission.

- [BASE SCREEN](#) (page 11)
- Scan mode:
 - [SENDING AN IMAGE IN SCAN MODE](#) (page 28)
- USB memory mode:
 - [SENDING AN IMAGE IN USB MEMORY MODE](#) (page 37)
- Internet fax mode:
 - [SENDING A FAX IN INTERNET FAX MODE](#) (page 42)
- PC scan mode:
 - [7. SCANNING FROM A COMPUTER \(PC Scan Mode\)](#) (page 112)
- Data entry mode:
 - [TRANSMITTING METADATA](#) (page 119)



Select settings

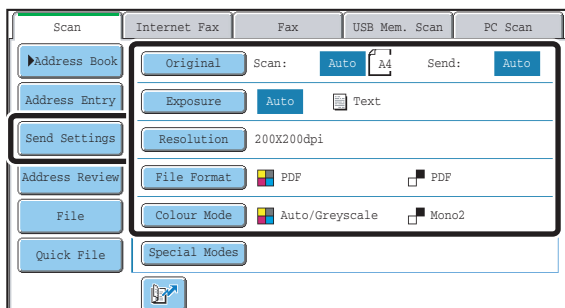

Settings can be selected for scanning the original.

- Original (2-sided original, scan size, send size)
- Exposure • Resolution • File Format • Colour Mode
 - [IMAGE SETTINGS](#) (page 54)
- Send Settings (File Name)
Scan mode, Data entry mode:
 - [CHANGING THE SUBJECT, FILE NAME, REPLY-TO, AND BODY TEXT](#) (page 33)
- USB memory mode:
 - [ENTERING A FILE NAME](#) (page 41)
- Internet fax mode:
 - [CHANGING THE SUBJECT, FILE NAME, AND BODY TEXT](#) (page 45)



Special mode settings

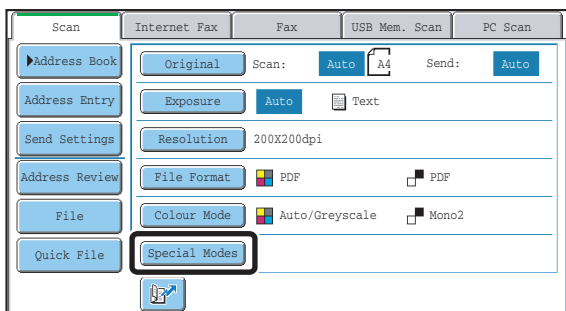

Special modes can be selected.

➤ [4. SPECIAL MODES](#) (page 70)



Enter the destination

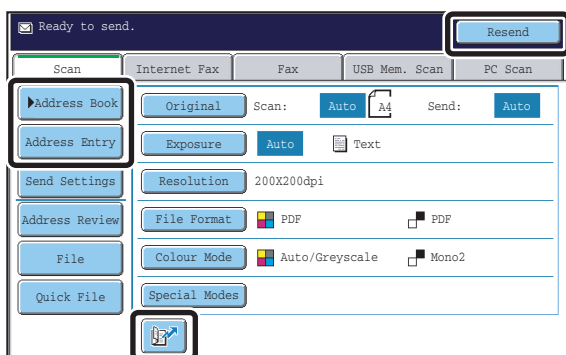

Specify the destination of the scan transmission.

- [Address Book] key:
 - [RETRIEVING A DESTINATION FROM THE ADDRESS BOOK](#) (page 20)
 - [RETRIEVING A DESTINATION FROM A GLOBAL ADDRESS BOOK](#) (page 25)
- [Address Entry] key:
 - [ENTERING AN ADDRESS MANUALLY](#) (page 24)
-  key:
 - [USING A SEARCH NUMBER TO RETRIEVE A DESTINATION](#) (page 23)
- [Resend] key:
 - [USING THE RESEND FUNCTION](#) (page 27)



Start scanning and transmission

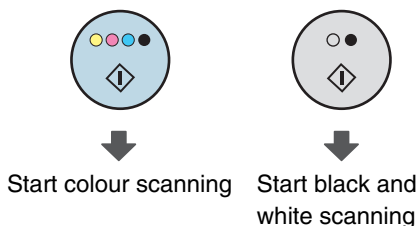

Start scanning and transmission.

If the original is placed on the document glass, follow these steps to start scanning and transmission:

- (1) Press the [COLOUR START] key (●●●●) or the [BLACK & WHITE START] key (○●).
- (2) When scanning is finished, replace the original with the next original.
- (3) Press the [COLOUR START] key (●●●●) or the [BLACK & WHITE START] key (○●).
- (4) Repeat (2) and (3) until all originals have been scanned.
- (5) Touch the [Read-End] key.



- The [COLOUR START] key (●●●●) cannot be used in Internet fax mode.
- After the original is scanned, the settings revert to the default settings.



To cancel scanning...

Press the [STOP] key (⊘) to cancel the operation.



System Settings (Administrator): Default Display Settings

The settings can be kept in effect a fixed period of time after scanning is completed.

ORIGINAL SIZES

TRANSMITTABLE ORIGINAL SIZES

The following original sizes can be transmitted

| | Minimum original size | Maximum original size |
|-------------------------------------|--|--|
| Using the automatic document feeder | 131 mm (height) x 140 mm (width) (5-1/8" (height) x 5-1/2" (width)) | 297 mm (height) x 800 mm* (width) (11-5/8" (height) x 31-1/2"* (width)) |
| Using the document glass | – | 297 mm (height) x 432 mm (width) (11-5/8" (height) x 17" (width)) |

* A long original can be transmitted. (When only scan destinations are selected for scan transmission or metadata transmission, scanning will take place in Mono2 at a resolution of 300X300dpi or less.)

THE SIZE OF THE PLACED ORIGINAL

When a standard size original is placed, the original size is automatically detected and displayed in "Scan" in the base screen.

When the automatic original detection function is operating and the original is a non-standard size, the closest standard size may be displayed or the original size may not appear. In this event, manually set the correct original size.

- ☞ [Specifying the original scan size \(by paper size\)](#) (page 57)
- ☞ [Specifying the original scan size \(by numerical values\)](#) (page 58)

STANDARD SIZES

Standard sizes are sizes that the machine can automatically detect. The standard sizes are set in "Original Size Detector Setting" in the system settings (administrator).

List of original size detector settings

| Selections | Standard sizes (detected original sizes) | |
|------------|--|--|
| | Document glass | Document feeder tray (automatic document feeder) |
| AB-1 | A3, A4, A4R, A5, B4, B5, B5R | A3, A4, A4R, A5, B4, B5, B5R, 8-1/2" x 11", 8-1/2" x 14", 11" x 17" |
| AB-2 | A3, A4, A4R, A5, B5, B5R, 216 mm x 330 mm (8-1/2" x 13") | A3, A4, A4R, A5, B4, B5, B5R, 8-1/2" x 11", 11" x 17", 216 mm x 330 mm (8-1/2" x 13") |
| AB-3 | A4, A4R, A5, B4, 8K, 16K, 16KR | A3, A4, A4R, A5, B4, 8K, 16K, 16KR, 8-1/2" x 11", 11" x 17", 216 mm x 330 mm (8-1/2" x 13") |
| Inch-1 | 11" x 17", 8-1/2" x 14", 8-1/2" x 11", 8-1/2" x 11"R, 5-1/2" x 8-1/2" | 11" x 17", 8-1/2" x 14", 8-1/2" x 11", 8-1/2" x 11"R, 5-1/2" x 8-1/2", A4, A3 |
| Inch-2 | 11" x 17", 8-1/2" x 13" (216mm x 330mm) 8-1/2" x 11", 8-1/2" x 11"R, 5-1/2" x 8-1/2" | 11" x 17", 8-1/2" x 13" (216mm x 330mm) 8-1/2" x 11", 8-1/2" x 11"R, 5-1/2" x 8-1/2", A4, A3 |

2

ENTERING DESTINATIONS

This chapter explains how to specify destination addresses, including selecting an address from the address book and retrieving an address by entering a search number.

RETRIEVING A DESTINATION FROM THE ADDRESS BOOK

The address book screen shows stored destinations as one-touch keys. The destinations are displayed in order by search number. To make it easy to find a destination, the destinations are grouped by name on alphabetical index tabs.

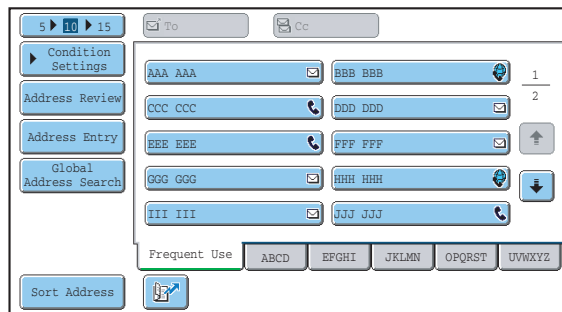

The address book screen shows the destinations of all modes of the image send function. Each one-touch key shows the name of the destination and an icon indicating the mode to be used.

| Icon | Mode used |
|------|--|
| | Fax |
| | Scan to E-mail |
| | Internet fax |
| | Group key with multiple destinations, such as Scan to E-mail and Internet fax destinations |

| Icon | Mode used |
|------|------------------------|
| | Scan to FTP |
| | Scan to Network Folder |
| | Scan to Desktop |

- For information on storing addresses in the address book, see "[STORING DESTINATION ADDRESSES FOR EACH SCAN MODE IN THE ADDRESS BOOK](#)" (page 9).
- To store destinations for Scan to Desktop, Network Scanner Tool must be installed from the CD-ROM that accompanies the machine. For more information on storing destinations for Scan to Desktop, see "[STORING A DESTINATION FOR SCAN TO DESKTOP](#)" (page 10).

System Settings: Address Book
This is used to store Scan to E-mail and Internet fax addresses in one-touch keys.

RETRIEVING A DESTINATION

A destination is retrieved by selecting its one-touch key.

1

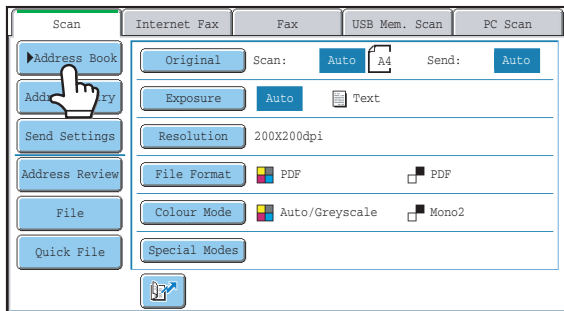

Touch the [Address Book] key.

2

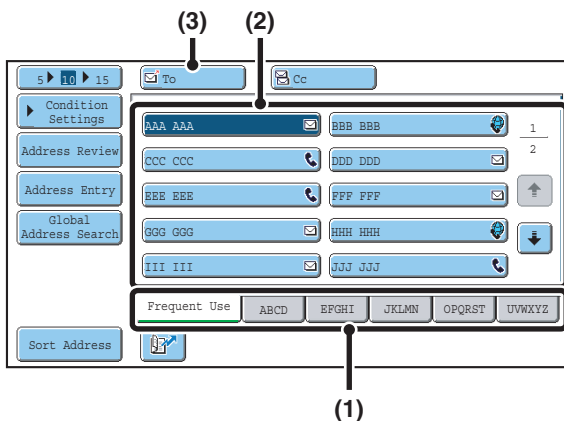

Specify the destination.

(1) Touch the index tab where the destination is stored.

(2) Touch the one-touch key of the desired destination.

If you select an incorrect destination, touch the key again to cancel the selection.

(3) Touch the [To] key.

This enters the selected destination.



- It is convenient to store frequently used destinations in the [Frequent Use] index. Specify that a destination be displayed in the [Frequent Use] index when you store the destination.
- **To continue specifying other destinations...**
It is possible to specify multiple scan mode (Scan to E-mail, Scan to FTP, Scan to Desktop), Internet fax, and fax mode destinations when performing a broadcast transmission (maximum of 500 destinations). To specify multiple destinations, repeat (1) through (3) of this step.
When performing Scan to E-mail, you can select a one-touch key and then touch the [Cc] key or the [Bcc] key to send Cc or Bcc copies of the e-mail.



System Settings (Administrator): Bcc Setting

This setting enables or disables Bcc delivery. When enabled, the [Bcc] key appears in the address book screen.

System Settings (Administrator): Must Input Next Address Key at Broadcast Setting

This setting determines whether or not the [Next Address] key can be omitted before specifying the next destination. Factory default setting: the [Next Address] key can be omitted.

System Settings (Administrator): Disable Switching of Display Order

This is used to disable switching of the order of display of the one-touch keys in the address book screen. The currently selected display order will be the order that is used after this setting is enabled.

CHECKING AND DELETING THE SELECTED DESTINATIONS

When multiple destinations have been selected, you can display and check the destinations. You can also delete a destination from the list (cancel selection of the destination).

1

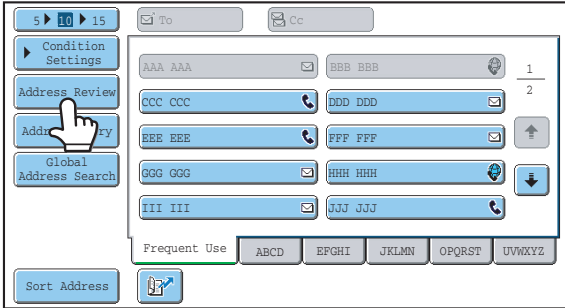

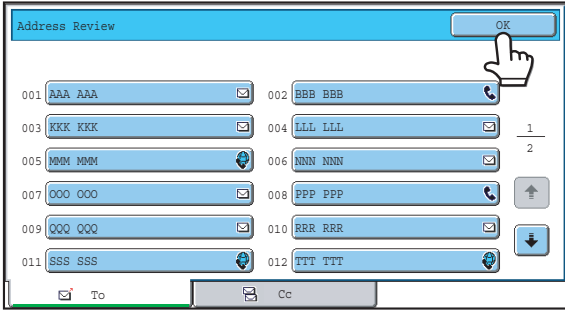

Touch the [Address Review] key.

2



Check the destinations and then touch the [OK] key.

2  To check Cc or Bcc destinations, touch the corresponding tab.

 **To cancel selection of a destination...**
Touch the one-touch key of the destination that you wish to cancel. A message will appear to confirm the deletion. Touch the [Yes] key.

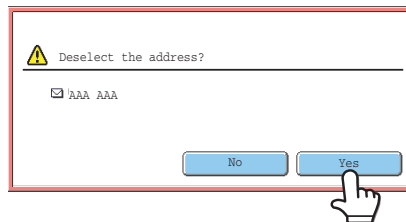

USING A SEARCH NUMBER TO RETRIEVE A DESTINATION

A destination stored in the address book can be retrieved using the  key. This can be done in the base screen of any of the modes or in the address book screen.

1

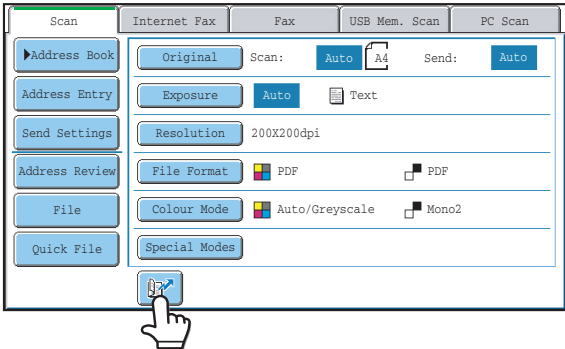

The screenshot shows the base screen of the device with several tabs at the top: Scan, Internet Fax, Fax, USB Mem. Scan, and PC Scan. On the left side, there is a vertical menu with buttons for Address Book, Address Entry, Send Settings, Address Review, File, and Quick File. The main area contains various settings: Original, Scan: Auto, A4, Send: Auto, Exposure, Auto, Text, Resolution, 200X200dpi, File Format, PDF, PDF, Colour Mode, Auto/Greyscale, Mono2, and Special Modes. At the bottom center, there is a search key icon (a blue square with a magnifying glass and a document) which is being touched by a hand cursor.

Touch the  key.

2

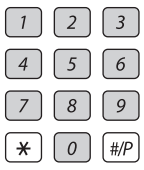



Enter the 3-digit search number of the address with the numeric keys.

When the 3-digit search number is entered, the stored address is retrieved and specified as a destination.

2  • The search number is programmed when the destination is stored in the address book.

• If you do not know the search number, print the one-touch address list using "Sending Address List" in the system settings.

• When entering search numbers such as "001" and "011", "0" can be omitted. For example to enter "001", enter "1" and touch the  key or the [Next Address] key.

 If an incorrect search number is entered...

Press the [CLEAR] key () to clear the number and enter the correct number.

ENTERING AN ADDRESS MANUALLY

Destination addresses for Scan to E-mail and Internet fax can be entered manually.

1

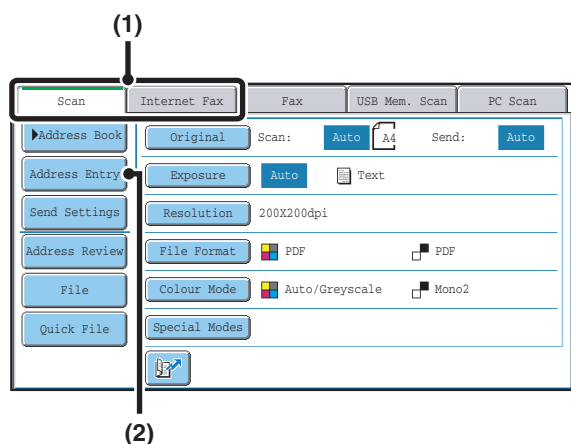

Display the address input screen.

- (1) Touch the tab of the mode that you wish to use.
- (2) Touch the [Address Entry] key.

2

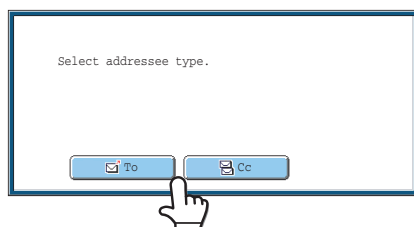

Enter the destination address.

- (1) If you are in scan mode, touch the key of the desired delivery method.
Normally the [To] key is touched. This specifies that the entered e-mail address will be a recipient.
- (2) Enter the destination address in the text entry screen that appears.
Enter the destination address and touch the [OK] key. For the procedure for entering text, see "6. ENTERING TEXT" in the User's Guide.



- If you wish the destination to be a Cc destination, touch the [Cc] key.
- The [Bcc] key only appears when Bcc has been enabled using "Bcc Setting" in the system settings (administrator). If you wish the destination to be a Bcc destination, touch the [Bcc] key.
- When Internet fax mode is selected, the base screen appears after the destination address is entered. However, if "I-Fax Reception Report On/Off Setting" is enabled in the system settings (administrator), the reception report request screen will appear. If you wish to receive a report, touch the [Yes] key. If not, touch the [No] key.



- **System Settings (Administrator): I-Fax Reception Report On/Off Setting**
This setting is used to request a reception report when an Internet fax is sent. When the destination is specified by directly entering the address, a message will appear asking you if you wish to receive a report.
- **System Settings (Administrator): Bcc Setting**
This setting enables or disables Bcc delivery. When enabled, the [Bcc] key appears in the address book screen and the delivery type selection screen.

RETRIEVING A DESTINATION FROM A GLOBAL ADDRESS BOOK

When an LDAP server is configured in the Web pages, you can look up an address in a global address book and retrieve the address for Scan to E-mail or Internet fax transmission.

1

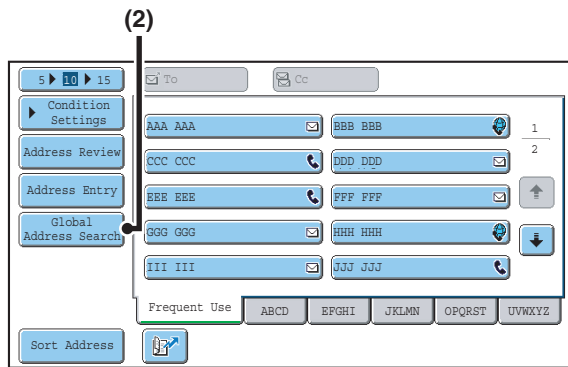

Open the global address search screen.

- (1) Touch the [Address Book] key in the base screen.
- (2) Touch the [Global Address Search] key.

2

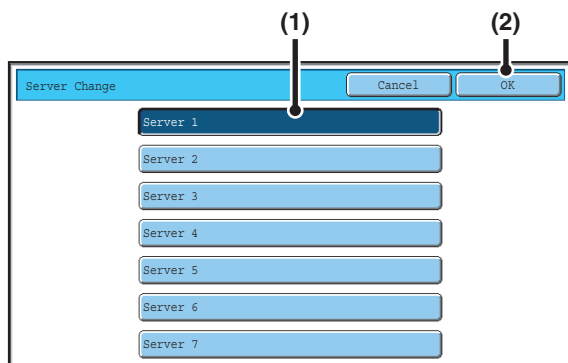

Search for the destination.

If only one LDAP server has been stored, (1) and (2) are not necessary. Go directly to (3).

- (1) Touch the key of the LDAP server that you wish to use.
- (2) Touch the [OK] key.
- (3) Search for the destination in the search screen.

Enter search characters for the destination and touch the [Search] key. The search results will appear after a brief interval.

For the procedure for entering text, see "6. ENTERING TEXT" in the User's Guide.



How to search

Enter the search characters (maximum of 64 characters). The system will look for names starting with the entered letters.

An asterisk * can be used as follows:

XXX*: Names beginning with "XXX".

*XXX: Names that end with "XXX".

XXX: Names that include "XXX".

AA*XX: Names that start with "AA" and end with "XX".

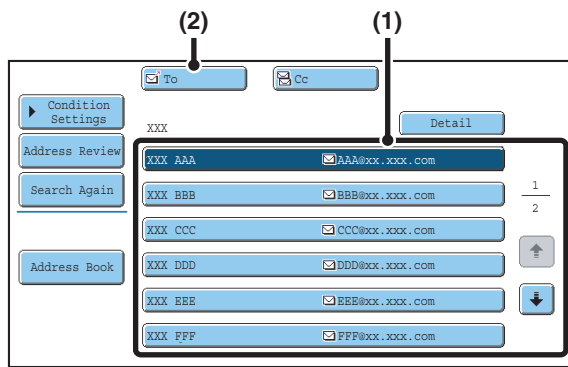

Select the destination.

(1) Touch the key of the desired destination.

If no names are found that match the search characters, a message will appear. Touch the [OK] key to close the message and touch the [Search Again] key to search again.

(2) Touch the [To] key.

This enters the selected destination.

If you wish to enter another destination, repeat (1) and (2) of this step.



- If more than 30 matches are found, a message will appear in the screen. Touch the [OK] key to close the message. Up to 300 matches can appear. If no names are found that match the search letters, touch the [Search Again] key to search again using more search letters.
- **To check the information stored in a destination...**
Touch the key of the destination and then touch the [Detail] key. The information stored for the selected destination will appear. Check the information and then touch the [OK] key to return to the search results screen.
- **If a screen for selecting the item to be used appears...**
If the selected destination includes a fax number, telephone number, or other contact information in addition to the e-mail address or Internet fax address, you will need to select which item you wish to use. Touch the [E-mail] key or the [Internet Fax] key to retrieve the address for Scan to E-mail or Internet fax transmission.

Storing a destination from a global address book in the machine's address book

A destination address obtained from a global address book can be stored as a destination (one-touch key) in the address book of the machine.

Touch the [Detail] key in the search results screen of the global address book (the screen of step 3 above) to display information on the selected destination. Touch the [Register] key in the detailed information screen and then touch the item to be used (the [E-mail] key or the [Internet Fax] key). The following screens will appear.

E-mail address registration screen

Internet fax address registration screen

The information stored in the global address book is automatically entered. (The settings can be changed if needed. For detailed information on each item, see "Address Control" in the System Settings Guide.) However, configure the items below manually. To complete the storing procedure, touch the [Exit] key.

- [Initial] key: Enter the initials that determine where the destination will appear in the alphabetical index and the order of one-touch key display. Enter up to 5 characters for the initials.
- [Index] key: Select the custom index in which the address will appear. You can also select whether or not the destination will be included on the [Frequent Use] tab of the address book.
- [File Format] key: Set the format for Scan to E-mail. Default format settings have already been configured; however, selecting format settings when you store a destination saves you the trouble of selecting the settings each time you transmit to that destination.
- [Compression] key: Touch this key to set the compression mode when sending an Internet fax.
- [I-Fax Report] key: Touch this key to request a reception report when sending an Internet fax.

USING THE RESEND FUNCTION

The destinations of the most recent 8 transmissions by Scan to E-mail, Internet fax and/or fax are stored. One of these can be selected to resend to that destination.

1

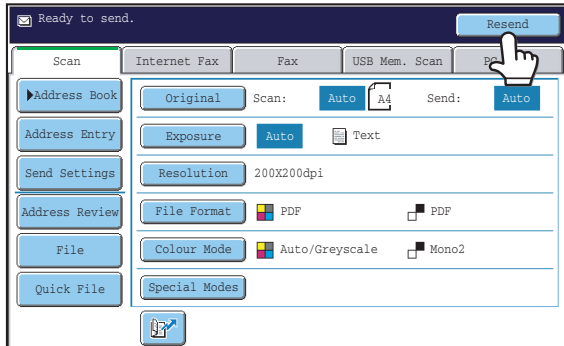

Touch the [Resend] key.

2

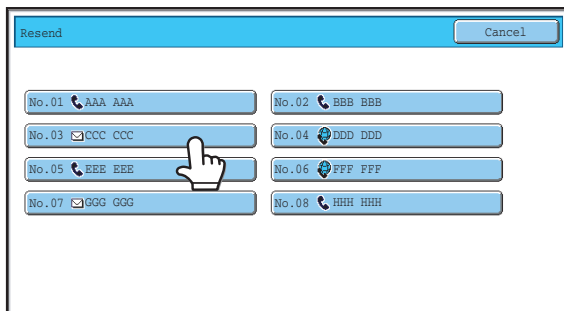

Touch the key of the desired address.

The last 8 addresses used for transmission are displayed.



- When the [Resend] key is touched and a destination selected, the mode of the selected destination is automatically selected.
- The following types of addresses are not stored for resending.
 - A one-touch key in which multiple destinations are stored (group key).
 - Scan to FTP, Scan to Desktop, and Scan to Network Folder addresses.
 - Broadcasting destinations
 - Addresses used only for BCC delivery
 - Destinations transmitted to using a program

3

TRANSMITTING AN IMAGE

SENDING AN IMAGE IN SCAN MODE

This section explains the basic procedure for transmission in scan mode (Scan to E-mail, Scan to FTP, Scan to Desktop, and Scan to Network Folder).

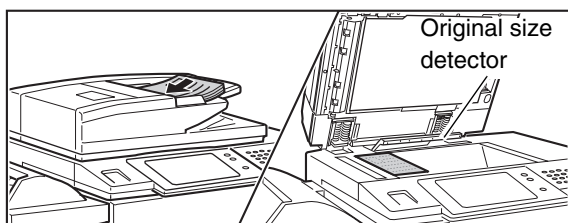

 When a default address is configured in "Default Address Setting" in the system settings (administrator), the mode cannot be changed, the destination cannot be changed, and destinations cannot be added. If you wish to change the mode or destination, touch the [Cancel] key in the touch panel and then follow the procedure below.





Place the original.

Do not place any objects under the original size detector. Closing the automatic document feeder with an object underneath may damage the original size detector plate and prevent correct detection of the document size.

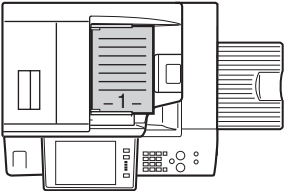
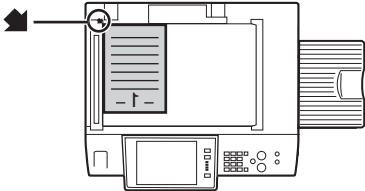
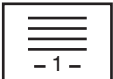
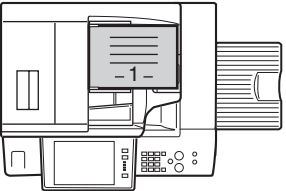
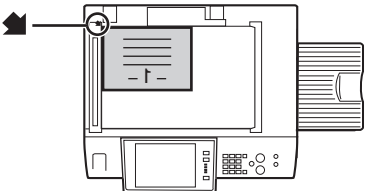
 • When placing the originals, orient them as shown below.

| Originals | Document feeder tray Place the original face up. | Document glass Place the original face down and align the corner with the tip of the arrow mark  in the top left corner of the document glass scale. |
|--|---|--|
| Portrait orientation*  |  |  |
| Landscape orientation  |  |  |

- * To place a large portrait-oriented original, place it as shown above in "Landscape orientation" and specify the placement orientation in step 3.
- Place A5 (5-1/2" x 8-1/2") size originals in portrait (vertical) orientation (). If placed in landscape (horizontal) orientation (), an incorrect size will be detected. For an A5R (5-1/2" x 8-1/2"R) size original, enter the original size manually.
- Originals cannot be scanned in succession from both the automatic document feeder and the document glass and sent in a single transmission.

2

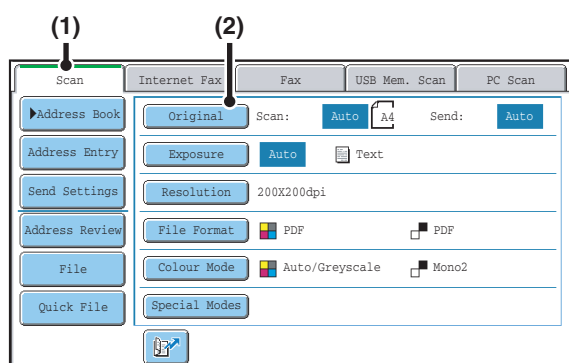

Switch to scan mode and display the image settings screen.

- (1) Touch the [Scan] tab.
- (2) Touch the [Original] key.



The current settings for [Original], [Exposure], [Resolution], [File Format], and [Colour Mode] are indicated at the right of each key. To change a setting, touch the appropriate key.

[AUTOMATICALLY SCANNING BOTH SIDES OF AN ORIGINAL \(2-Sided Original\)](#) (page 55), [SPECIFYING THE ORIGINAL SCAN SIZE AND SEND SIZE \(Enlarge/Reduce\)](#) (page 56), [CHANGING THE EXPOSURE AND EXPOSURE MODE \(ORIGINAL IMAGE TYPE\)](#) (page 62), [CHANGING THE RESOLUTION](#) (page 64), [CHANGING THE FILE FORMAT](#) (page 65), [CHANGING THE COLOUR MODE](#) (page 69), [4. SPECIAL MODES](#) (page 70)

3

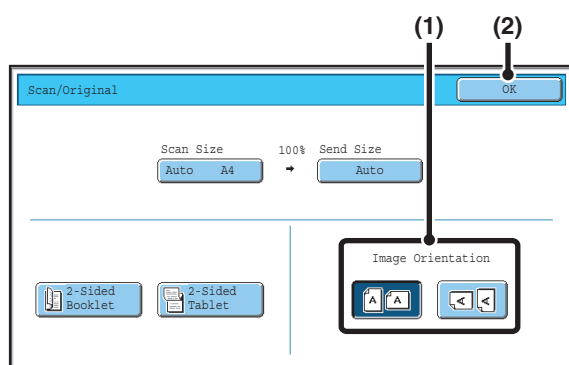

Specify the orientation in which the original is placed.

To enable the original to be scanned in the correct orientation (the orientation of the top edge of the original that is shown at the top of the display), specify the orientation in which the original was placed in step 1.

- (1) Touch the appropriate orientation key.

If the top edge of the original is up, touch the key. If the top edge of the original is to the left, touch the .

- (2) Touch the [OK] key.

You will return to the screen of step 2.



The original orientation is initially set to . If the original was placed with the top edge up, this step is not necessary.

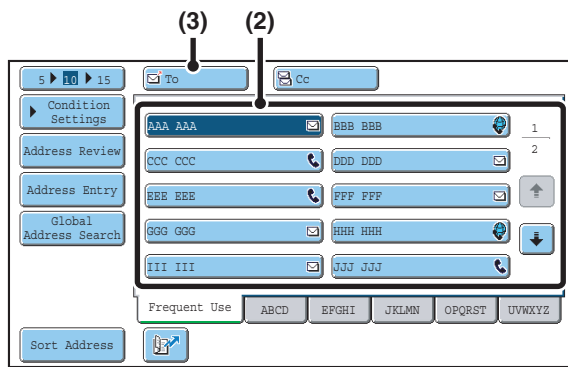

Specify the destination.

(1) Touch the [Address Book] key in the base screen.

(2) Touch the one-touch key of the desired destination.

The icon on the key indicates the type of destination stored in the key.

: Scan to E-mail

: Scan to FTP

: Scan to Network Folder

: Scan to Desktop

(3) Touch the [To] key.

The destination is specified.



- After a one-touch key is touched, if the screen is changed without touching the [To] key, the destination is automatically specified.
- When performing Scan to E-mail, you can also send Cc or Bcc copies to other destinations. Touch the desired destination and then touch the [Cc] key or the [Bcc] key.
- Multiple destinations can be specified. To specify multiple destinations, repeat steps (2) and (3). Note that multiple destinations cannot be specified when a Scan to Network Folder destination is specified.
- You can also select multiple one-touch keys and then touch the [To] key (or the [Cc] or [Bcc] key) to specify all selected keys at once.
- In addition to specification by a one-touch key, a destination can also be specified by a search number. For a Scan to E-mail destination, you can enter an address manually or retrieve an address from a global address book. For more information, see "2. ENTERING DESTINATIONS" (page 20).



System Settings (Administrator): Bcc Setting

This setting enables or disables Bcc delivery. When enabled, the [Bcc] key appears in the address book screen.

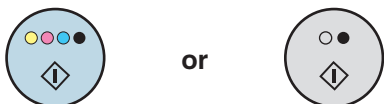

Press the **[COLOUR START]** key (●●●●) or the **[BLACK & WHITE START]** key (●●).

Scanning begins.

- If the original is placed on the document glass, the [Read-End] key appears in the touch panel. If the original is only one page, go to step 7. To scan more pages, go to the next step.
- If the original was inserted in the document feeder tray, a beep will sound when scanning is completed and transmission will take place.

5



- To scan in full colour, press the [COLOUR START] key (●●●●). To scan in black and white, press the [BLACK & WHITE START] key (●●). If the colour mode of the [COLOUR START] key (●●●●) is set to [Auto], the colour of the original will be detected automatically and scanning in full colour, greyscale or Mono2 will take place.
- If the file type is [Encrypt PDF], a password entry screen will appear when the [START] key is pressed.

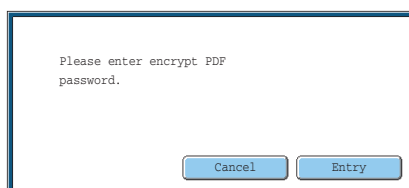

Touch the [Entry] key to open the keyboard screen, enter a password (maximum of 32 characters), and touch the [OK] key. The recipient must use the password entered here to open the encrypted PDF file.

To cancel encrypted PDF, touch the [Cancel] key. The format settings screen will appear to let you change the file type. Select a new file type and press the [START] key to begin transmission.

6

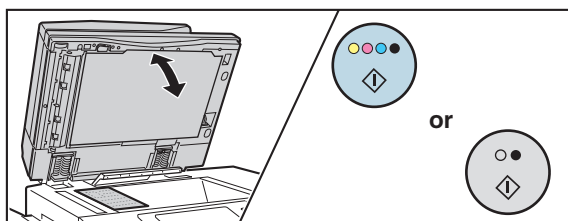

If the original was placed on the document glass, replace it with the next original and press the **[COLOUR START]** key (●●●●) or the **[BLACK & WHITE START]** key (●●).

Repeat until all originals have been scanned.

7

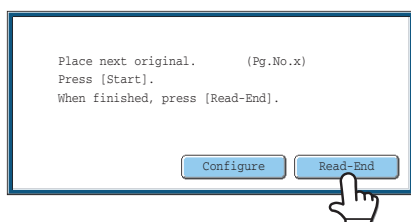

Touch the **[Read-End]** key.

A beep will sound to indicate that the operation is completed. Open the automatic document feeder and remove the original.



- If no action is taken for one minute after the confirmation screen appears, scanning automatically ends and the transmission is reserved.
- The [Configure] key can be touched to change the exposure, resolution, scan size, and send size for each original page scanned. However, when "Card Shot" is selected in the special modes, only the exposure can be changed when scanning an even-numbered original page.



- When all originals have been scanned, "Job stored." will be displayed together with a job control number. This number can be used to locate the job in the Transaction Report or in the Image Sending Activity Report. If the job is a broadcast transmission, this number will also appear in the key of the job in the job status screen. For this reason, making a note of the number is useful for checking the result.
- If the memory becomes full while the originals are being scanned, a message will appear and scanning will stop.
- When performing Scan to E-mail, take care not to send a file that is too large. In particular, multi-page files tend to be large. When sending a multi-page file or other large file, it may be necessary to reduce the number of scanned pages or reduce the send size.

- **Storing a mail signature**

You can have preset text automatically added at the end of e-mail messages as a mail signature. This is convenient when you wish to have a corporate policy or other preset text appear at the bottom of e-mail messages. To store the text for the mail signature, click [Application Settings] and then [Network Scanner Settings] in the Web page menu. (Administrator rights are required.) Up to 900 characters can be entered. (The mail signature is not included in the maximum number of characters that can be entered in the e-mail message.)

Use "Pre-Setting Mail Signature" in the system settings (administrator) to specify whether or not a mail signature is added.



- **To cancel scanning...**

Press the [STOP] key (⏹) to cancel the operation.



- **System Settings (Administrator): Image Send Settings**

Use this to configure scanner transmission settings, including the default resolution and exposure settings, the default colour mode and file format, the file compression method for broadcasting, the file size limit for Scan to E-mail, and the default sender and destination.

- **System Settings (Administrator): Pre-Setting Mail Signature**

Use this setting to specify whether or not a mail signature is added at the end of e-mail messages. By factory default, a mail signature is not added.

CHANGING THE SUBJECT, FILE NAME, REPLY-TO, AND BODY TEXT

The subject, file name, reply-to, and body text can be changed when performing a scan transmission. Preset items can be selected or text can be directly entered.

- When performing Scan to FTP, Scan to Desktop, or Scan to Network Folder, only the file name is used.
- If the subject and file name are not changed, the settings in the Web page are used.
- If the sender name is not changed, the name set in "Default Sender Set" in the system settings is used. If this is not configured, the reply address in [Network Settings] - [Services Settings] - [SMTP Settings] in the Web pages is used. (Administrator rights are required.)
- Selections for the subject, file name, and body text are configured by clicking [Application Settings] and then [Network Scanner Settings] in the Web page menu. (Administrator rights are required.)
- For the procedure for entering text, see "6. ENTERING TEXT" in the User's Guide.

1

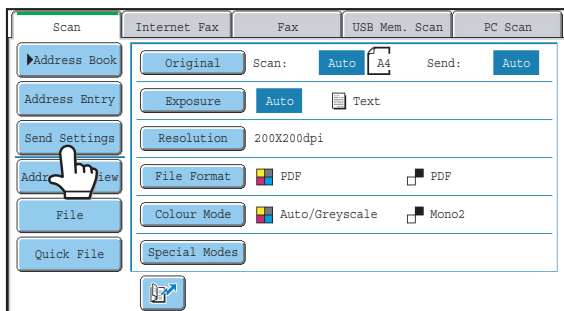

Touch the [Send Settings] key.

If you are sending to a Scan to FTP, Scan to Desktop, or Scan to Network Folder destination, go to step 4.

2

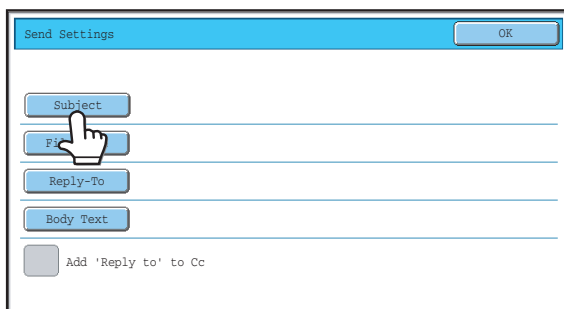

To change the subject, touch the [Subject] key.

3

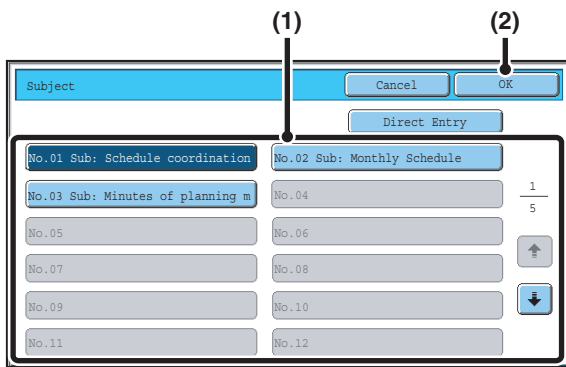

Enter the subject.

(1) Touch a Pre-Set text key.

(2) Touch the [OK] key.



- If you wish to directly enter the text, touch the [Direct Entry] key to open the text entry screen. Enter the text and touch the [OK] key.
- The text in a pre-set text key can be edited by touching the pre-set text key and then the [Direct Entry] key. The text entry screen will appear with the selected pre-set text entered. (When a destination is stored using the Web pages, up to 80 characters can be entered. However, only 54 characters* can be edited in the touch panel.)
* When the number of preset keys displayed is 6

4

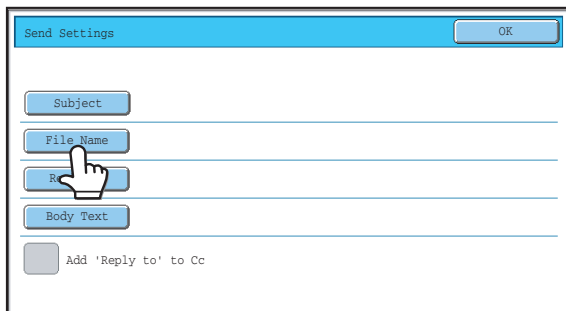

To change the file name, touch the [File Name] key.

- The file name is entered in the same way as the subject.
- If you are sending to a Scan to FTP, Scan to Desktop, or Scan to Network Folder destination, go to step 9.

5

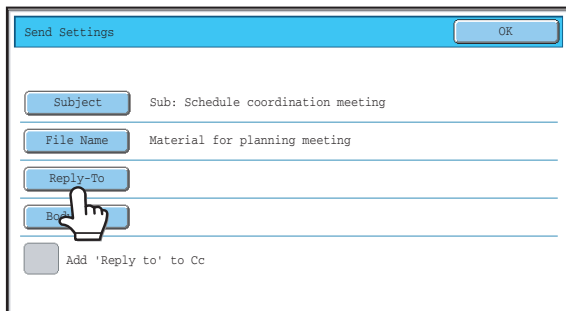

To change "Reply-To", touch the [Reply-To] key.



- If user authentication is being used, the information of the user that logged in will be applied, and thus "Reply-To" cannot be changed.

6

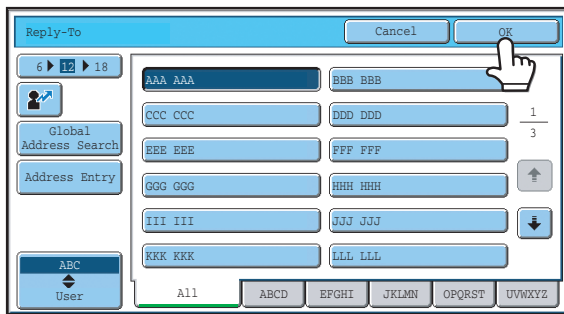

Specify a user for "Reply-To" and touch the [OK] key.

- Touch the key that you wish to use for "Reply-To".
- You can touch the [Global Address Search] key to specify a user stored in a global address book for "Reply-To". You can also touch the [Address Entry] key to directly enter an e-mail address.



- To specify the return address, you can touch the  key and enter a user number that has been previously stored using "User List" in the system settings (administrator).
- A key can only be selected for the return address if an e-mail address has been stored for that user in "User List" in the system settings (administrator).

7

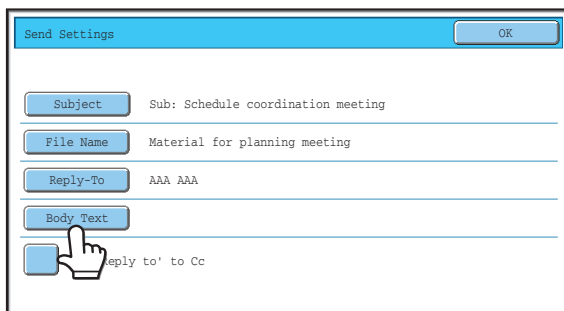

To change the body text, touch the [Body Text] key.

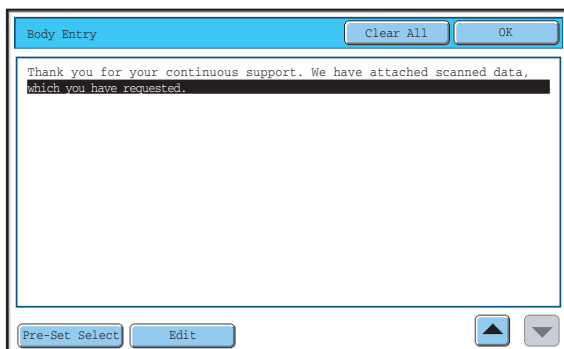

8



Enter the body text and touch the [OK] key.

- To select a pre-set text previously stored in the Web page, touch the [Pre-Set Select] key.
- To directly enter the body text, touch the [Edit] key.



- 1800 characters can be entered. (A line break counts as one character.)
- To clear all entered text, touch the [Clear All] key. This key clears not only the selected line but also the entire message.
- Each line of the entered text can be selected with the   keys. To edit the selected line, touch the [Edit] key. The text entry screen will appear with the selected text entered.

Touch the [OK] key.



The [Add 'Reply to' to Cc] checkbox can be selected to send a Cc copy to the sender.



When storing pre-set text for the subject and file name in the Web pages, up to 80 characters can be entered.



- **System Settings (Administrator): The Number of File Name/Subject/Body Keys Displayed Setting**
The setting for the number of subject keys and file name keys displayed in one screen can be changed to 6, 12, or 18.
- **System Settings: Default Sender Set**
This is used to store the sender name and e-mail address that is used when a sender is not selected.

SENDING AN IMAGE IN USB MEMORY MODE

Follow the steps below to send a scanned image to a commercially available USB memory device that has been connected to the machine. This stores the file in the USB device.

- Consult your dealer or retailer for USB memory devices that can be used.
- When a default address is configured in "Default Address Setting" in the system settings (administrator), the mode cannot be changed. To switch to USB memory mode, touch the [Cancel] key in the touch panel and then follow the steps below.

1

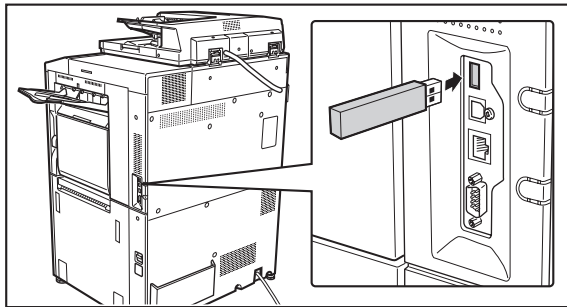

Connect the USB memory to the USB connector (Type A) on the machine.

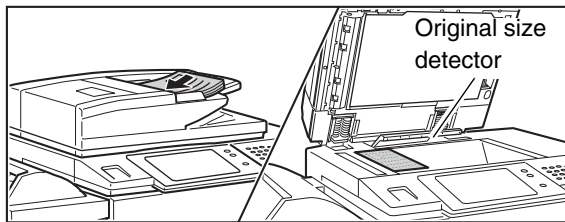

2





Place the original.

Do not place any objects under the original size detector. Closing the automatic document feeder with an object underneath may damage the original size detector plate and prevent correct detection of the document size.

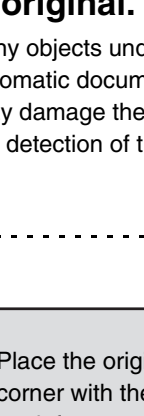
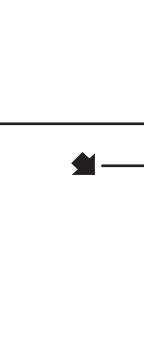
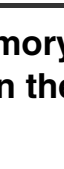
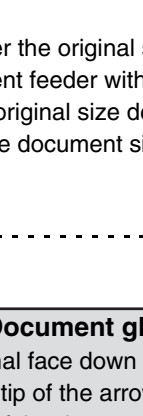
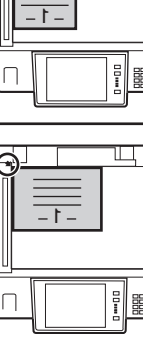
- When placing the originals, orient them as shown below.

| Originals | Document feeder tray Place the original face up. | Document glass Place the original face down and align the corner with the tip of the arrow mark  in the top left corner of the document glass scale. |
|--|--|--|
| Portrait orientation*  |  |  |
| Landscape orientation  |  |  |

- * To place a large portrait-oriented original, place it as shown above in "Landscape orientation" and specify the placement orientation in step 4.
- Place A5 (5-1/2" x 8-1/2") size originals in portrait (vertical) orientation (). If placed in landscape (horizontal) orientation () , an incorrect size will be detected. For an A5R (5-1/2" x 8-1/2"R) size original, enter the original size manually.
- Originals cannot be scanned in succession from both the automatic document feeder and the document glass and sent in a single transmission.

3

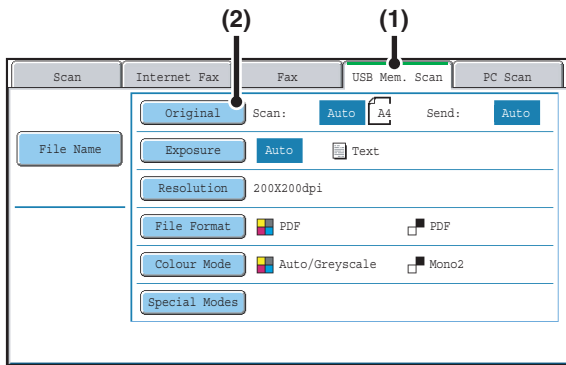

Switch to USB memory mode and display the image settings screen.

(1) Touch the [USB Mem. Scan] tab

If the [USB Mem. Scan] tab does not appear, touch the  tab to move the screen.

(2) Touch the [Original] key.



- When scanning to USB memory, there is no need to specify the destination.
- If a destination of another mode has been previously specified, a message will appear when you change to USB memory mode indicating that the destination setting will be cleared. Touch the [OK] key in the message screen and go to the next step.
- The current settings for [Original], [Exposure], [Resolution], [File Format], and [Colour Mode] are indicated at the right of each key. To change a setting, touch the appropriate key.
 - ✎ [AUTOMATICALLY SCANNING BOTH SIDES OF AN ORIGINAL \(2-Sided Original\)](#) (page 55), [SPECIFYING THE ORIGINAL SCAN SIZE AND SEND SIZE \(Enlarge/Reduce\)](#) (page 56), [CHANGING THE EXPOSURE AND EXPOSURE MODE \(ORIGINAL IMAGE TYPE\)](#) (page 62), [CHANGING THE RESOLUTION](#) (page 64), [CHANGING THE FILE FORMAT](#) (page 65), [CHANGING THE COLOUR MODE](#) (page 69), [4. SPECIAL MODES](#) (page 70)

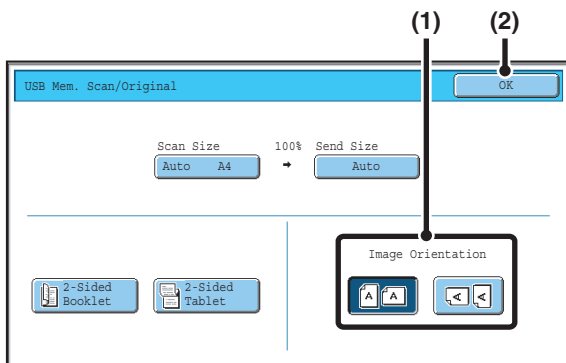

4



Specify the orientation in which the original is placed.

To enable the original to be scanned in the correct orientation (the orientation in which the top edge of the original appears at the top of the display), specify the orientation in which the original was placed in step 2.

(1) Touch the appropriate orientation key.

If the top edge of the original is up, touch the  key. If the top edge of the original is to the left, touch the  key.

(2) Touch the [OK] key.

You will return to the screen of step 3.



- The original orientation is initially set to . If the original was placed with the top edge up, this step is not necessary.



or



Press the [COLOUR START] key (●●●●) or the [BLACK & WHITE START] key (●●).

Scanning begins.

- If the original is placed on the document glass, the [Read-End] key appears in the touch panel. If the original is only one page, go to step 7. To scan more pages, go to the next step.
- If the original was inserted in the document feeder tray, a beep will sound when scanning is completed and transmission will begin. Go to step 8.

5



Do not disconnect the USB memory until "Sending data has been completed." appears in the touch panel.



- To scan in full colour, press the [COLOUR START] key (●●●●). To scan in black and white, press the [BLACK & WHITE START] key (●●). If the colour mode of the [COLOUR START] key (●●●●) is set to [Auto], the colour of the original will be detected automatically and scanning in full colour, greyscale or Mono2 will take place.
- If the file type is [Encrypt PDF], a password entry screen will appear when the [START] key is pressed.

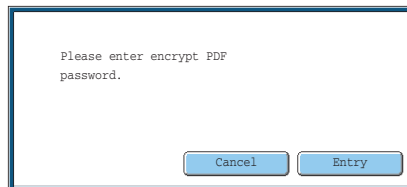

Touch the [Entry] key to open the keyboard screen, enter a password (maximum of 32 characters), and touch the [OK] key. The recipient must use the password entered here to open the encrypted PDF file.

To cancel encrypted PDF, touch the [Cancel] key. The format settings screen will appear to let you change the file type. Select a new file type and press the [START] key to begin transmission.

6

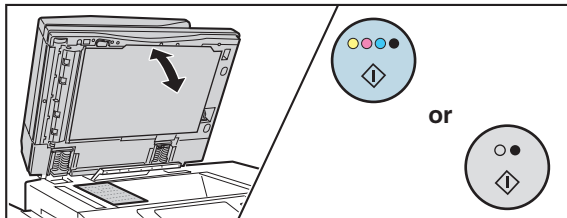

If the original was placed on the document glass, replace it with the next original and press the [COLOUR START] key (●●●●) or the [BLACK & WHITE START] key (●●).

Repeat until all originals have been scanned.

7

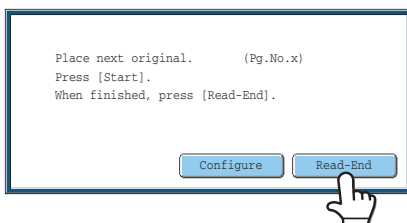

Touch the [Read-End] key.

A beep will sound to indicate that the operation is completed. Open the automatic document feeder and remove the original.



- If no action is taken for one minute after the confirmation screen appears, scanning automatically ends and the transmission is reserved.
- The [Configure] key can be touched to change the exposure, resolution, scan size, and send size for each original page scanned. However, when "Card Shot" is selected in the special modes, only the exposure can be changed when scanning an even-numbered original page.

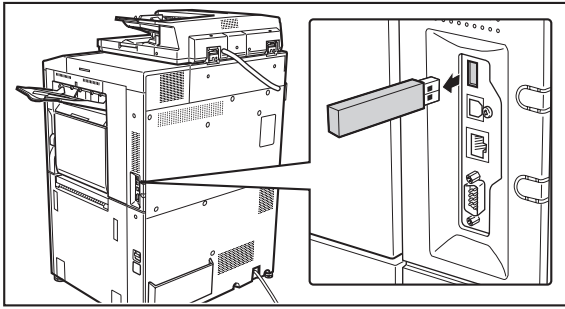

When "Sending data has been completed." appears in the touch panel, disconnect the USB memory.



Do not disconnect the USB memory while "Processing data." or "Sending data." appears in the touch panel.



- When transmission to USB memory is completed, "Sending data has been completed." is displayed. After a brief interval the message is cleared and the base screen of image send mode reappears. (The base screen of image send mode is the screen that appears when the [IMAGE SEND] key is touched.)
- **If the USB memory becomes full during scanning...**
A message will appear and scanning will stop. The scanned data will not be stored. However, if the file format is set to JPEG and the [Specified Pages per File] checkbox is selected, files for which scanning is completed will be stored in USB memory.



- **To cancel scanning...**
Press the [STOP] key (Ⓢ) to cancel the operation.
- **To cancel scanning to USB memory...**
While scanned data is being stored in the USB memory, the message "Sending data." and the [Cancel] key appear in the touch panel. To cancel the storing operation, touch the [Cancel] key.



- **System Settings: USB-Device Check**
This is used to check the connection of a USB device to the machine.
- **System Settings (Administrator): Scan Settings**
This is used to set the default colour mode and file format.
- **System Settings (Administrator): Disable Scan Function**
The use of PC scan mode and USB memory mode can be prohibited.

ENTERING A FILE NAME

The file name can be directly entered when performing a scan transmission.



- If the file name is not entered, the settings in the Web page are used.
- For the procedure for entering text, see "6. ENTERING TEXT" in the User's Guide.

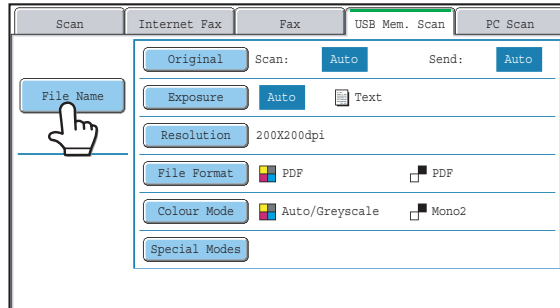

Touch the [File Name] key. A text entry screen will appear. Enter the file name and touch the [OK] key.



To check the entered file name, touch the [File Name] key in the base screen once again.

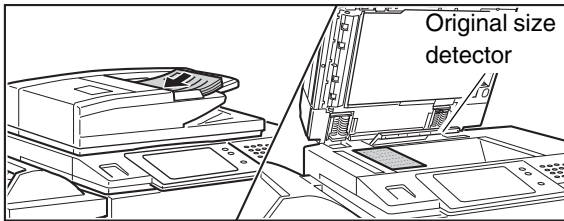

SENDING A FAX IN INTERNET FAX MODE

-  When a default address is configured in "Default Address Setting" in the system settings (administrator), the mode cannot be changed, the destination cannot be changed, and destinations cannot be added. To switch to Internet fax mode, touch the [Cancel] key in the touch panel and follow the steps below.



Place the original.

- Place the original face up in the document feeder tray, or face down on the document glass.
- Do not place any objects under the original size detector. Closing the automatic document feeder with an object underneath may damage the original size detector plate and prevent correct detection of the document size.

- 1**
-  • Place A5 (5-1/2" x 8-1/2") size originals in portrait (vertical) orientation (). If placed in landscape (horizontal) orientation (), an incorrect size will be detected. For an A5R (5-1/2" x 8-1/2"R) size original, enter the original size manually.
- **Image rotation**
A4, B5R, and A5R (8-1/2" x 11" and 5-1/2" x 8-1/2"R) originals are rotated 90 degrees and transmitted in A4R, B5, or A5 (8-1/2" x 11"R or 5-1/2" x 8-1/2") orientation. (A4R, B5, and A5 (8-1/2" x 11"R and 5-1/2" x 8-1/2") originals cannot be rotated for transmission.)

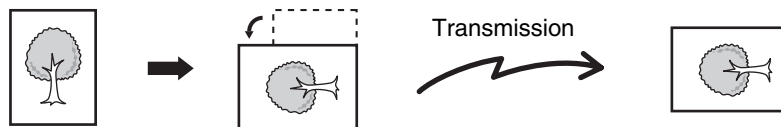

- Originals cannot be scanned in succession from both the automatic document feeder and the document glass and sent in a single transmission.

 **System Settings (Administrator): Rotation Sending Setting**

This is used to select whether or not a scanned original image is rotated before transmission.

The default setting is: rotate A4 to A4R, B5R to B5, and A5R to A5 (8-1/2" x 11" to 8-1/2" x 11"R, and 5-1/2" x 8-1/2"R to 5-1/2" x 8-1/2").

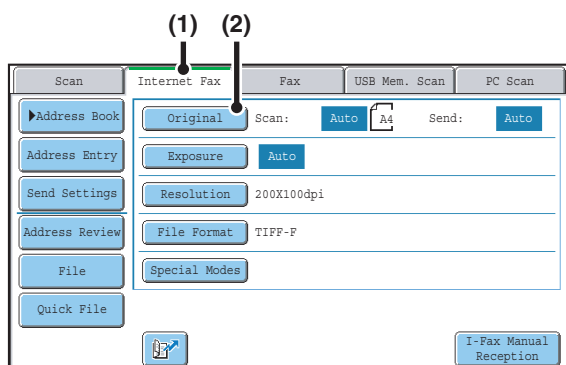

Switch to Internet fax mode and display the image settings screen.

- 2**
- (1) Touch the [Internet Fax] tab.
 - (2) Touch the [Original] key.

-  The current settings for [Original], [Exposure], [Resolution], and [File Format] are indicated at the right of each key. To change a setting, touch the appropriate key.

 [AUTOMATICALLY SCANNING BOTH SIDES OF AN ORIGINAL \(2-Sided Original\)](#) (page 55), [SPECIFYING THE ORIGINAL SCAN SIZE AND SEND SIZE \(Enlarge/Reduce\)](#) (page 56), [CHANGING THE EXPOSURE AND EXPOSURE MODE \(ORIGINAL IMAGE TYPE\)](#) (page 62), [CHANGING THE RESOLUTION](#) (page 64), [CHANGING THE FILE FORMAT](#) (page 65), [4. SPECIAL MODES](#) (page 70)

3

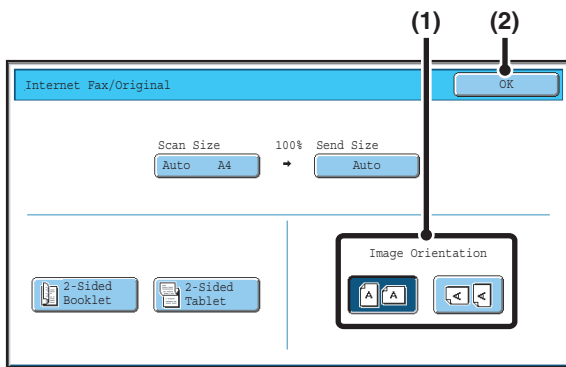

Specify the orientation in which the original is placed.

When specifying the orientation of the image to be transmitted, specify the orientation of the original placed in step 1.

(1) Touch the appropriate orientation key.

If the top edge of the original is up, touch the key. If the top edge of the original is to the left, touch the key.

(2) Touch the [OK] key.

You will return to the screen of step 2.



The original orientation is initially set to . If the original was placed with the top edge up, this step is not necessary.

4

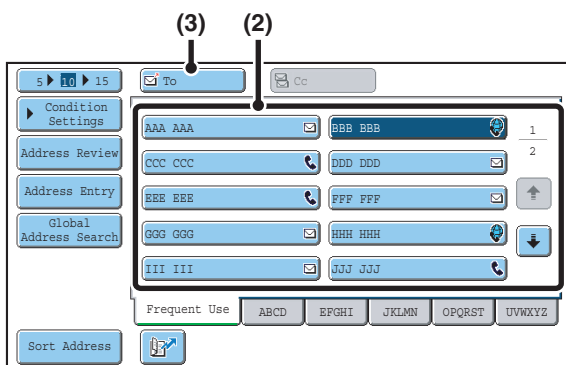

Specify the destination.

(1) Touch the [Address Book] key in the base screen.

(2) Touch the key of the desired destination.

The icon appears in one-touch keys in which Internet fax addresses are stored.

(3) Touch the [To] key.

The destination is specified.



- After a one-touch key is touched, if the screen is changed without touching the [To] key, the destination is automatically specified.
- In addition to specification by a one-touch key, a destination can also be specified by a search number. You can also manually enter a destination or look up a destination in a global address book. For more information, see "2. ENTERING DESTINATIONS" (page 20).

5



Press the [BLACK & WHITE START] key (○●).

Scanning begins.

- If the original is placed on the document glass, the [Read-End] key appears in the touch panel. If the original is only one page, go to step 7. To scan more pages, go to the next step.
- If the original was inserted in the document feeder tray, a beep will sound when scanning is completed and transmission will take place.

6

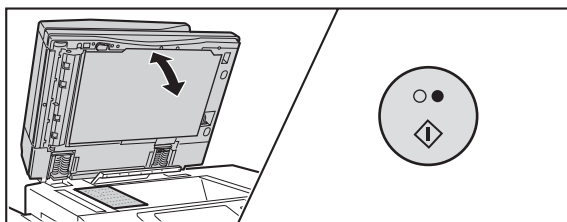

If the original was placed on the document glass, replace it with the next original and press the [BLACK & WHITE START] key (○●).

Repeat until all originals have been scanned.

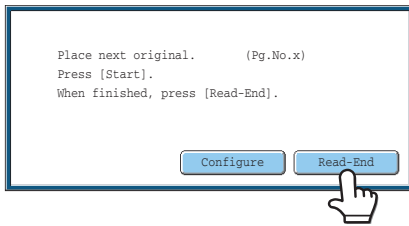

Touch the [Read-End] key.

A beep will sound to indicate that the operation is completed. Open the automatic document feeder and remove the original.



- If no action is taken for one minute after the confirmation screen appears, scanning automatically ends and the transmission is reserved.
- The [Configure] key can be touched to change the exposure, resolution, scan size, and send size for each original page scanned. However, when "2in1" or "Card Shot" is selected in the special modes, only the exposure can be changed when scanning an even-numbered original page.



- When all originals have been scanned, "Job stored." will be displayed together with a job control number. This number can be used to locate the job in the Transaction Report or in the Image Sending Activity Report. If the job is a broadcast transmission, this number will also appear in the key of the job in the job status screen. For this reason, making a note of the number is useful for checking the result.
- If the memory becomes full while the originals are being scanned, a message will appear and scanning will stop.
- **Storing a mail signature**
You can have preset text automatically added at the end of e-mail messages as a mail signature. This is convenient when you wish to have a corporate policy or other preset text appear at the bottom of e-mail messages. To store the text for the mail signature, click [Application Settings] and then [Network Scanner Settings] in the Web page menu. (Administrator rights are required.) Up to 900 characters can be entered. (The mail signature is not included in the maximum number of characters that can be entered in the e-mail message.)
Use "Pre-Setting Mail Signature" in the system settings (administrator) to specify whether or not a mail signature is added.



To cancel scanning...

Press the [STOP] key (⏹) to cancel the operation.



- **System Settings (Administrator): I-Fax Send Settings**

This is used to select Internet fax transmission settings such as the receive report setting, rotation setting, size restriction setting, and sender information attachment setting.

- **System Settings (Administrator): Pre-Setting Mail Signature**

Use this setting to specify whether or not a mail signature is added at the end of e-mail messages. By factory default, a mail signature is not added.

CHANGING THE SUBJECT, FILE NAME, AND BODY TEXT

The subject, file name, and body text can be changed when performing an Internet fax transmission. Preset items can be selected or text can be directly entered.

- If the subject and file name are not changed, the settings in the Web page are used.
- Selections for the subject, file name, and body text are configured by clicking [Application Settings] and then [Network Scanner Settings] in the Web page menu. (Administrator rights are required.)
- For the procedure for entering text, see "6. ENTERING TEXT" in the User's Guide.

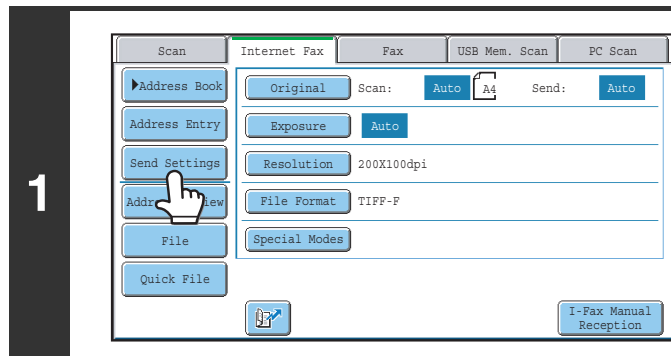

Touch the [Send Settings] key.

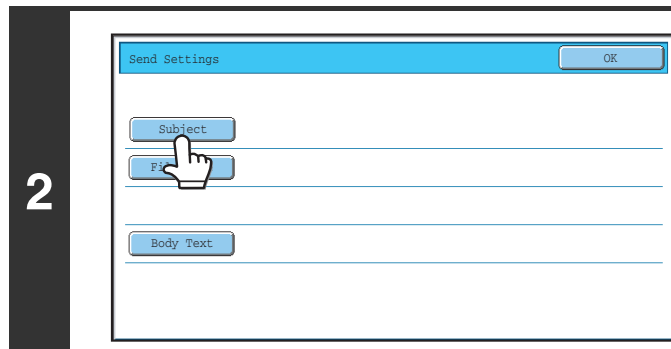

To change the subject, touch the [Subject] key.

3

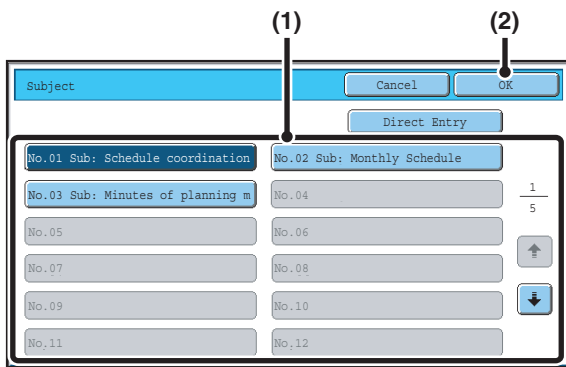

Enter the subject.

(1) Touch a pre-set text key.

(2) Touch the [OK] key.



- If you wish to directly enter the text, touch the [Direct Entry] key to open the text entry screen. Enter the text and touch the [OK] key.
- The text in a pre-set text key can be edited by touching the pre-set text key and then the [Direct Entry] key. The text entry screen will appear with the selected pre-set text entered. (When a destination is stored using the Web page, up to 80 characters can be entered. However, only 54 characters* can be edited in the touch panel.)
* When the number of preset keys displayed is 6

4

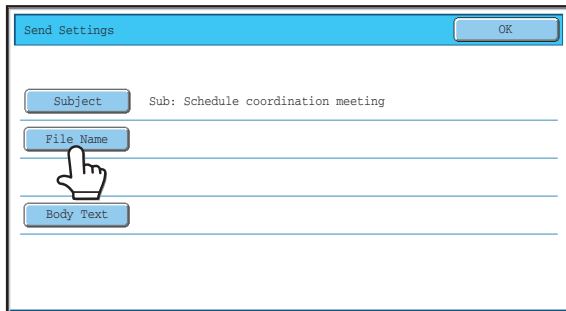

To change the file name, touch the [File Name] key.

The file name is entered in the same way as the subject.

5

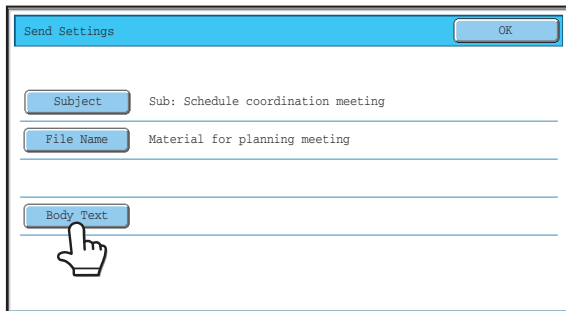

To change the body text, touch the [Body Text] key.

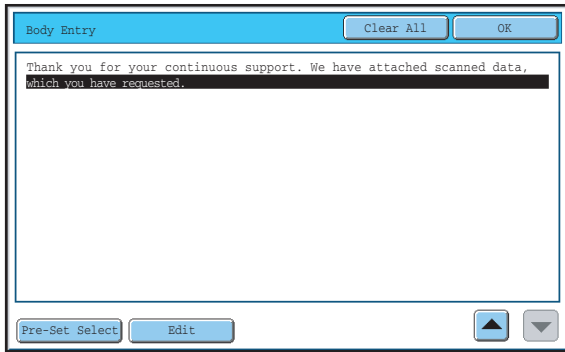

6



Enter the body text and touch the [OK] key.

- To select a pre-set message previously stored in the Web page, touch the [Pre-Set Select] key.
- To directly enter the message, touch the [Edit] key.



- 1800 characters can be entered. (A line break counts as one character.)
- To clear all entered text, touch the [Clear All] key. This key clears not only the selected line but also the entire message.
- Each line of the entered text can be selected with the   keys. To edit the selected line, touch the [Edit] key. The text entry screen will appear with the selected text entered.

7

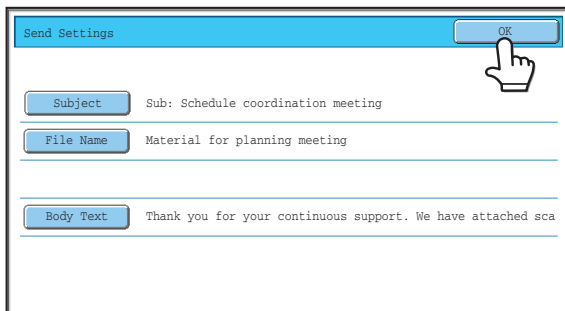

Touch the [OK] key.



When storing pre-set text for the subject and file name in the Web pages, up to 80 characters can be entered.



System Settings (Administrator): The Number of File Name/Subject/Body Keys Displayed Setting

The setting for the number of subject keys and file name keys displayed in one screen can be changed to 6, 12, or 18.

SENDING THE SAME IMAGE TO MULTIPLE DESTINATIONS (Broadcast Transmission)

The same scanned image can be sent to multiple scan modes (Scan to E-mail, Scan to FTP, and Scan to Desktop), Internet fax mode, and fax mode destinations in a single operation. Up to 500 destinations (including a combined maximum of 200 Scan to FTP and Scan to Desktop destinations) can be selected in one broadcast operation.

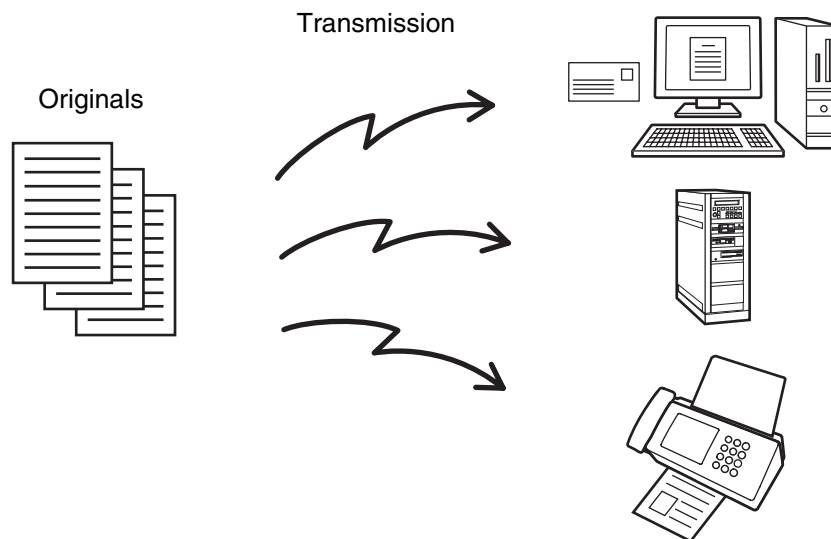

If you frequently use broadcasting to send images to the same group of destinations, it is convenient to store those destinations in a group key.

1

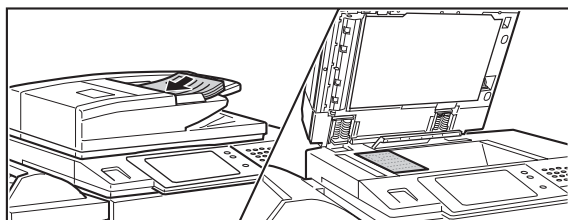

Place the original.

Place the original face up in the document feeder tray, or face down on the document glass.

2

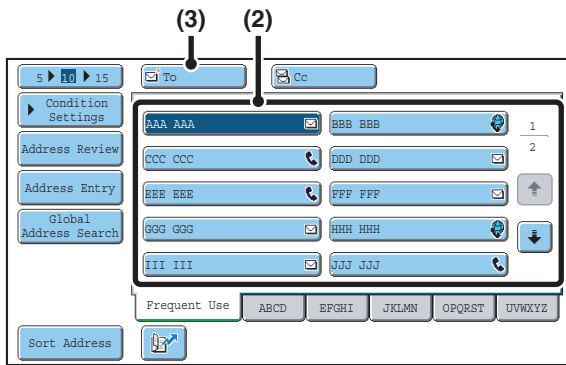

Specify the destination.

- (1) Touch the [Address Book] key in the base screen.
- (2) Touch the one-touch key of the desired destination.
- (3) Touch the [To] key.
The destination is specified.
- (4) Repeat steps (2) and (3) until all destinations are selected.



- To add Cc or Bcc recipients, select a recipient and touch the [Cc] key or the [Bcc] key.
- If "Must Input Next Address Key at Broadcast Setting" is enabled in the system settings (administrator), touch the [Next Address] key before specifying the next destination.
- One-touch keys that cannot be used for broadcast transmission are greyed out to prevent selection.
- If a Scan to FTP (Hyperlink) address is specified in a broadcast transmission, hyperlink e-mail transmission will not take place.
- If you frequently use broadcasting to send images to the same group of destinations, it is convenient to store those destinations in a group key.

3

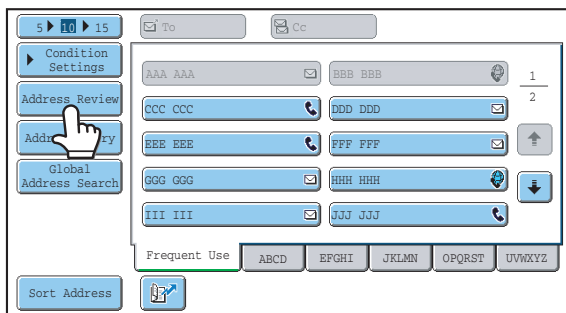

Touch the [Address Review] key.

4

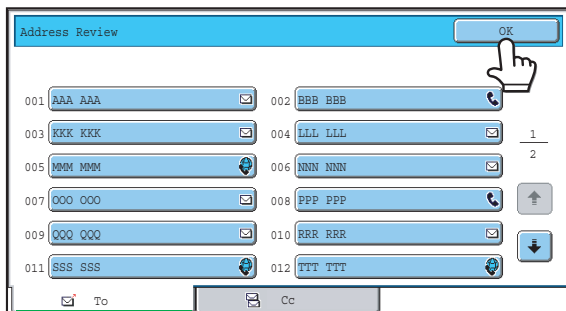

Check the destinations and then touch the [OK] key.



If the transmission includes Cc or Bcc destinations, touch the [Cc] tab or the [Bcc] tab to check those destinations.



To cancel a specified destination...

Touch the one-touch key of the destination that you wish to cancel. A message will appear to confirm the deletion. Touch the [Yes] key.

[CHECKING AND DELETING THE SELECTED DESTINATIONS](#) (page 22)



or



Press the [COLOUR START] key (●●●●) or the [BLACK & WHITE START] key (○●).

Scanning begins.

- If you inserted the original pages in the document feeder tray, all pages are scanned. A beep will sound to indicate that scanning is finished.
- If you are scanning the original on the document glass, scan each page one page at a time. When scanning of one page finishes, replace it with the next page and press the [COLOUR START] key (●●●●) or the [BLACK & WHITE START] key (○●). Repeat until all pages have been scanned and then touch the [Read-End] key. A beep will sound to indicate that scanning is finished.



If Internet fax or fax destinations are included in the broadcast transmission, the [COLOUR START] key (●●●●) cannot be pressed. Scanning will take place in Mono2.



To cancel scanning...

Press the [STOP] key (⊞) to cancel the operation.

BROADCAST TRANSMISSIONS THAT INCLUDE INTERNET FAX DESTINATIONS

When a broadcast transmission includes both scan mode and Internet Fax mode destinations, the Internet Fax mode settings (original orientation and other various settings) are given priority. When performing this type of broadcast transmission, note the information below.

| | |
|---------------------------------------|--|
| Original placement orientation | The orientation of Internet fax mode is given priority. When "Rotation Sending Setting" is enabled in the system settings (administrator), the image is rotated 90 degrees. For this reason, in some cases the image may not be displayed in the correct orientation. |
| Send size | When the file format is set to [TIFF-S] in Internet fax mode, transmission is only possible in A4R (8-1/2" x 11"R) size. |
| Exposure | The Internet fax settings are given priority. |
| Resolution | When the file format is set to [TIFF-S] in Internet fax mode and a high resolution setting is selected in scan mode, the resolution will be changed to [200X200dpi]. |
| File compression mode | The compression mode will be changed to the compression mode set in "Compression Mode at Broadcasting" in the system settings (administrator). |
| Colour scanning | Scanning will take place in Mono2 regardless of the colour mode setting. |
| Special modes | 2in1 |
| | This cannot be selected in scan mode, however, if selected in Internet fax mode, it will also be applied to scan destinations. |
| Scan file size | If a broadcast transmission is performed that includes destinations for which an attachment size limit has been set using "Maximum Size of E-mail Attachments (E-mail)" or "Maximum Size of Data Attachments (FTP/Desktop/Network Folder)" in the system settings (administrator), the limit will also apply to destinations for which a limit is not set. (The limitation setting of Scan to E-mail or Internet fax is given priority.) |

Resending to unsuccessful broadcast transmission destinations

The results of a completed broadcast transmission can be checked in the job status screen. If transmission to any of the addresses failed, resend the image to those addresses.

1

JOB STATUS



Press the [JOB STATUS] key.

2

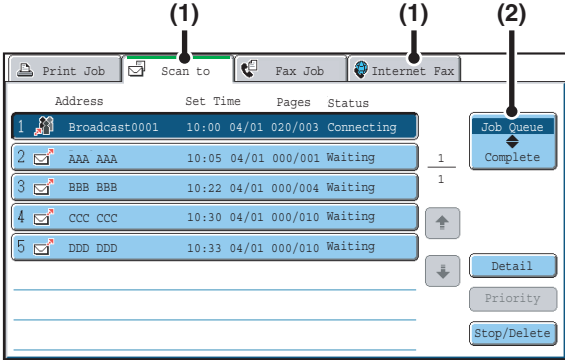

Display the jobs completed screen.

(1) Touch the tab of the mode that you wish to display.

(2) Touch the [Complete] key.

 If the broadcast transmission included destinations of different modes, the same broadcast transmission key will appear in each of those modes.

3

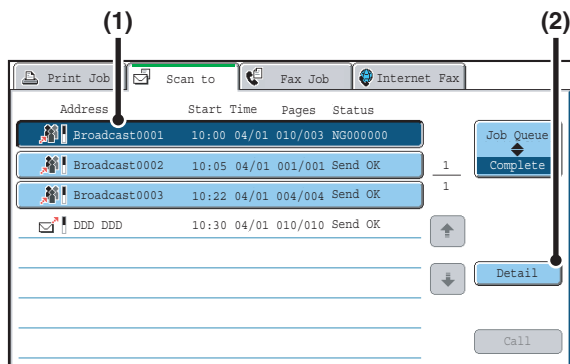

Display details on the broadcast transmission.

- (1) Touch the key of the completed broadcast transmission.
- (2) Touch the [Detail] key.



"Broadcastxxxx" will appear as the address of the broadcast job key. The job control number that appeared in the touch panel when scanning ended appears in "xxxx".

4

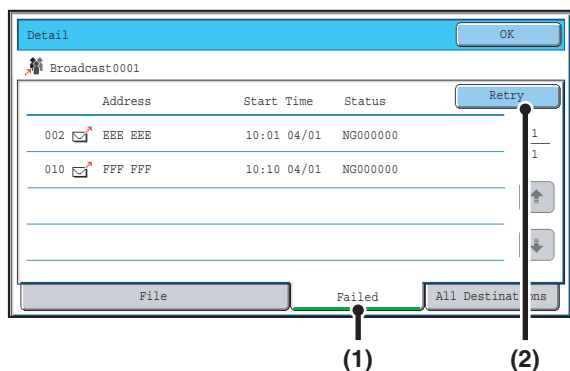

Resend the image to the unsuccessful destinations.

- (1) Touch the [Failed] tab.
- (2) Touch the [Retry] key.



- The steps to follow after the [Retry] key is touched differ depending on whether or not the document filing function is used.

Not using document filing

You will return to the base screen with the unsuccessful destinations entered. Place the original and perform the steps of the broadcast transmission.

Using document filing

You will return to the document filing resend screen with the unsuccessful destinations entered. Perform the document filing resend procedure. (There is no need to rescan the original.)

- If the [All Destinations] tab is touched in (1), all destinations will be displayed. The [Retry] key that appears in the screen can be touched to resend to all the destinations.

SENDING AN INTERNET FAX FROM A COMPUTER (PC-I-Fax)

A file on a computer can be sent via the machine as an Internet fax (PC-I-Fax function). Internet faxes are sent using the PC-I-Fax function in the same way as documents are printed. Select the PC-Fax driver as the printer driver for your computer and then select the Print command in the software application. Image data for transmission will be created and sent as an Internet fax.

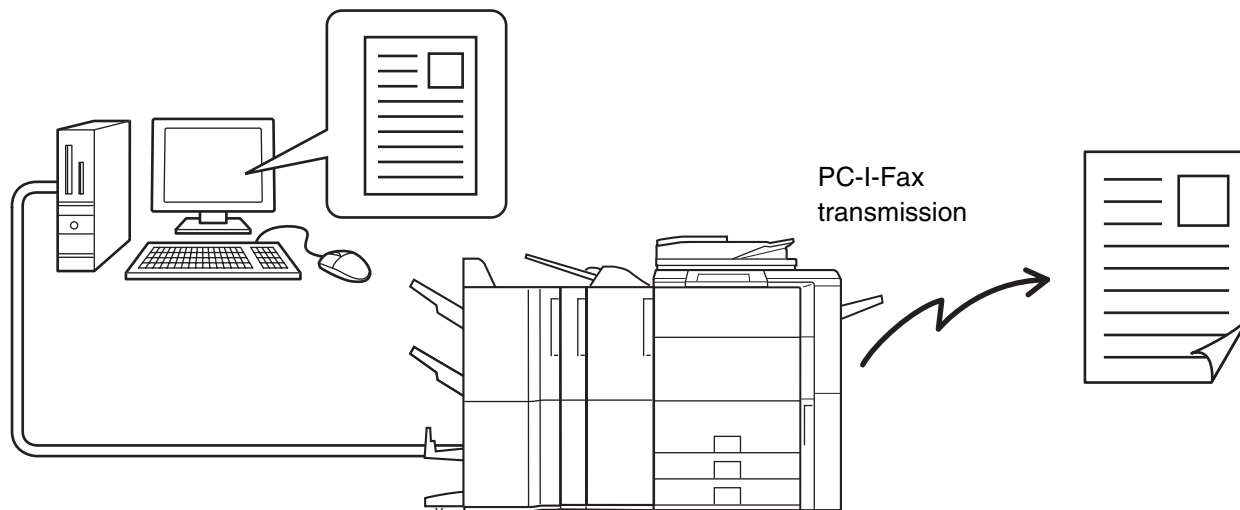

For the procedures for using this function, see the PC-Fax driver Help.

- To send an Internet fax using the PC-I-Fax function, the PC-Fax driver must be installed and then updated using the CD-ROM that accompanies the Internet fax expansion kit. For more information, see the Software Setup Guide.
- This function can only be used on a Windows computer.
- This function can only be used for transmission. Internet faxes received on the machine cannot be received to a computer that is connected to the machine.

IMAGE SETTINGS

Settings for scanning the original are selected in the base screen of each mode. The current state of each setting appears to the right of the key used to select the setting.

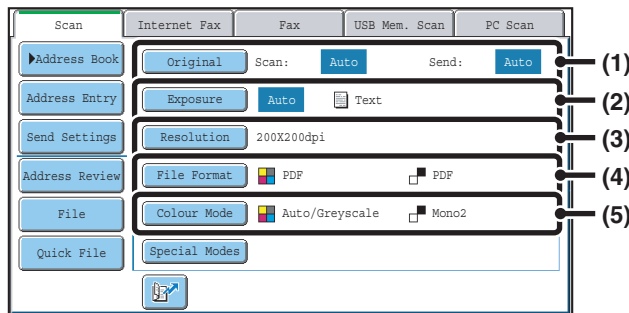

(1) [Original] key

Touch this key to set the scan size, send size, and orientation of the original, and select 2-sided scanning settings.

➤ [AUTOMATICALLY SCANNING BOTH SIDES OF AN ORIGINAL \(2-Sided Original\)](#) (page 55),
[SPECIFYING THE ORIGINAL SCAN SIZE AND SEND SIZE \(Enlarge/Reduce\)](#) (page 56)

(2) [Exposure] key

Touch this key to select the exposure for scanning.

➤ [CHANGING THE EXPOSURE AND EXPOSURE MODE \(ORIGINAL IMAGE TYPE\)](#) (page 62)

(3) [Resolution] key

Touch this key to select the resolution for scanning.

➤ [CHANGING THE RESOLUTION](#) (page 64)

(4) [File Format] key

Touch this key to change the format (file type) of the scanned image file.

➤ [CHANGING THE FILE FORMAT](#) (page 65)

(5) [Colour Mode] key

Touch this key to select the colour mode for scanning. This key does not appear in Internet fax mode.

➤ [CHANGING THE COLOUR MODE](#) (page 69)

AUTOMATICALLY SCANNING BOTH SIDES OF AN ORIGINAL (2-Sided Original)

The automatic document feeder can be used to automatically scan both sides of an original.

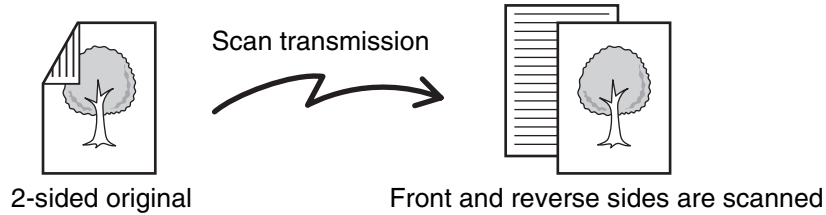

1

(1)

(2)

Select the mode and display the image settings screen.

(1) Touch the tab of the mode that you wish to use.

(2) Touch the [Original] key.

2

(1)

(2)

(3)

Specify the binding style of the 2-sided original (book or tablet) and the orientation in which the original is placed.

(1) Touch the [2-Sided Booklet] key or the [2-Sided Tablet] key.

A book and a tablet are bound as shown below.

Book

Tablet

(2) Touch the appropriate [Image Orientation] key.

If this setting is not correct, a suitable image may not be transmitted.

(3) Touch the [OK] key.

To cancel 2-sided scanning, touch the highlighted key so that it is no longer highlighted.

2-sided scanning automatically turns off after the transmission operation is completed.

SPECIFYING THE ORIGINAL SCAN SIZE AND SEND SIZE (Enlarge/Reduce)

When the original is placed, its size is automatically detected and displayed in the base screen.

The size of the placed original is indicated as the scan size, and the size to be transmitted is indicated as the send size.

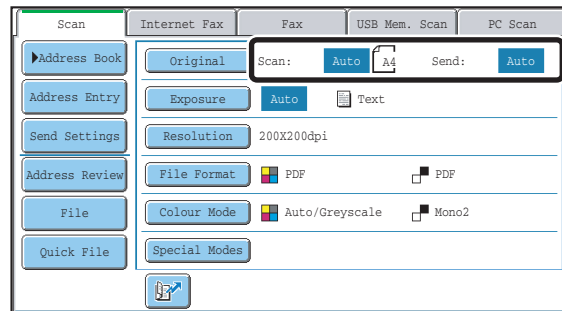

In the above screen, the scan size (the placed original) is A4 (8-1/2" x 11") and the send size is auto. For example, if the scan size is A4 (8-1/2" x 11") and the send size is B5 (5-1/2" x 8-1/2"), the image will be reduced before transmission.

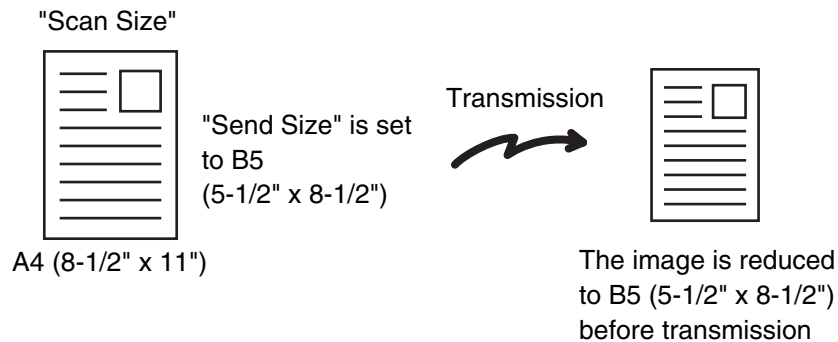

- Only standard original sizes can be automatically detected.
 - [STANDARD SIZES](#) (page 19)
- If the original is a non-standard size, you must set the scan size manually.
 - [Specifying the original scan size \(by paper size\)](#) (page 57)
 - [Specifying the original scan size \(by numerical values\)](#) (page 58)

Specifying the original scan size (by paper size)

If the original is a non-standard size or you wish to change the scan size, touch the [Original] key to specify the original size manually. Place the original in the document feeder tray or on the document glass and follow the steps below.

1

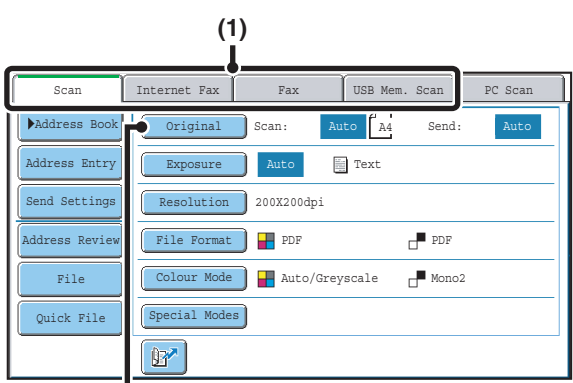

Select the mode and display the image settings screen.

- (1) Touch the tab of the mode that you wish to use.
- (2) Touch the [Original] key.
The automatically detected original size appears to the right of the [Original] key.

2

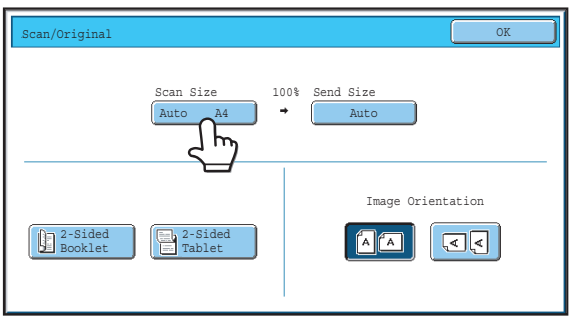

Touch the [Scan Size] key.

3

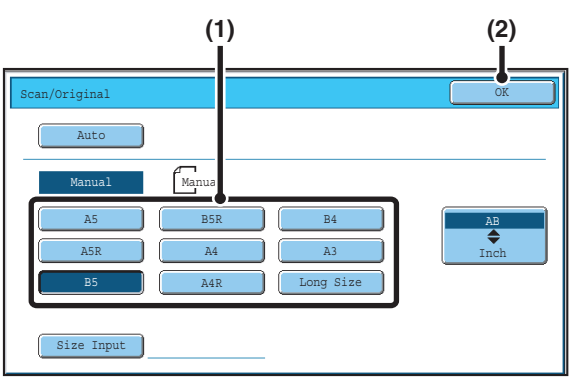

Specify the scan size.

- (1) Touch the appropriate original size key.
- (2) Touch the [OK] key.



- If you are sending a long original, touch the [Long Size] key. Use the automatic document feeder to scan a long original. The maximum width that can be scanned is 800 mm (31-1/2") (the maximum height is 297 mm (11-5/8")).
- To specify an inch size for the scan size, touch the [AB \blacklozenge Inch] key to highlight the [Inch] side and then specify the scan size.

4

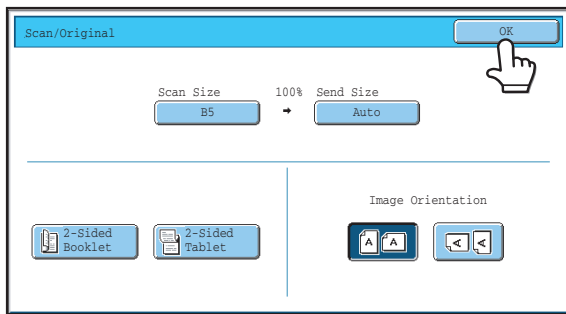

Touch the [OK] key.



When [Long Size] is selected, the 2-sided scanning setting and send size cannot be changed. In addition, when only scan destinations are selected for scan transmission or metadata transmission, scanning will take place in Mono2.

Specifying the original scan size (by numerical values)

When scanning a non-standard size original such as a card, follow these steps to specify the original size. The width can be from 64 mm to 432 mm (2-1/2" to 17"), and the height can be from 64 mm to 297 mm (2-1/2" to 11-5/8").

1

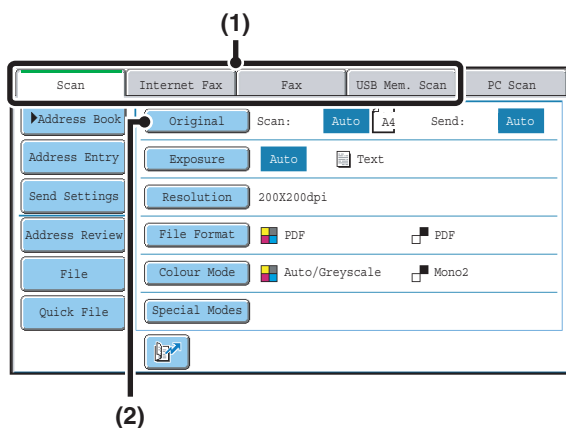

Select the mode and display the image settings screen.

(1) Touch the tab of the mode that you wish to use.

(2) Touch the [Original] key.

The automatically detected original size appears to the right of the [Original] key.

2

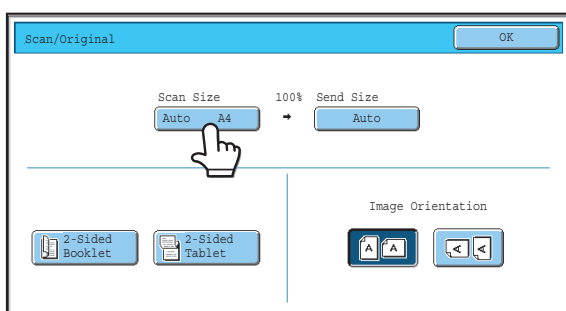

Touch the [Scan Size] key.

3

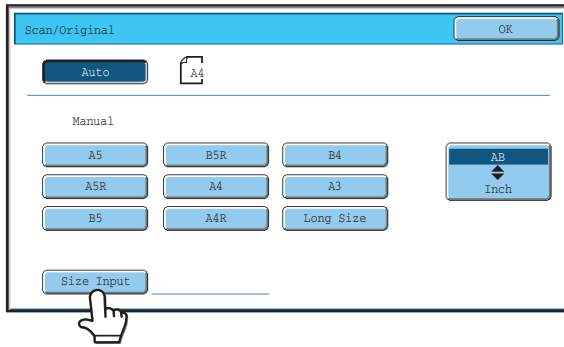

Touch the [Size Input] key.

4

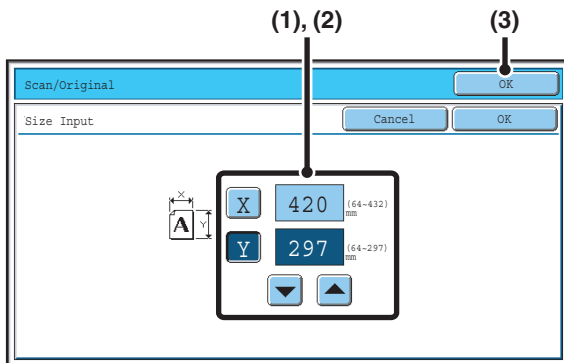

Enter the scan size (original size).

- (1) Touch the [X] key and enter the X (horizontal) dimension with the keys.
- (2) Touch the [Y] key and enter the Y (vertical) dimension with the keys.
- (3) Touch the [OK] key.

Touch the [OK] key next to the [Cancel] key to complete the setting and return to the screen of step 3.



System Settings (Administrator): Original Size Detector Setting

This is used to set the size entry screen to "mm units" or "inch units".

5

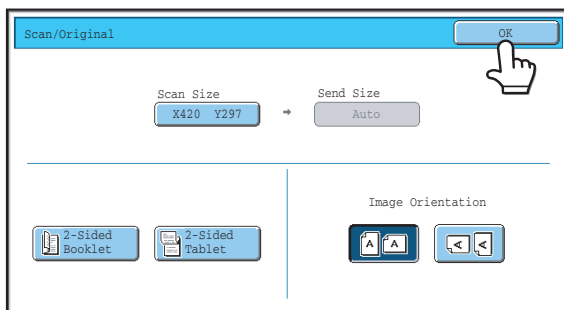

Touch the [OK] key.

The specified size appears in the [Scan Size] key.



- When the scan size is specified by numerical values, the send size cannot be specified.
 - When the automatic document feeder is used, an original longer than 432 mm (17") can be scanned (maximum width 800 mm (31-1/2")). In this case, touch the [Long Size] key in the screen of step 3.
- [Specifying the original scan size \(by paper size\)](#) (page 57)

Specifying the send size of the image

Specify the send size as a paper size. If a send size bigger than the scan size is selected, the image will be enlarged. If a send size smaller than the scan size is selected, the image will be reduced.

- The send size cannot be specified when [Long Size] is selected for the scan size, or when the scan size is specified by numerical values.
- The send size cannot be specified when [TIFF-S] is selected for the format in Internet fax mode. (The send size is fixed at A4R (8-1/2" x 11"R).)

1

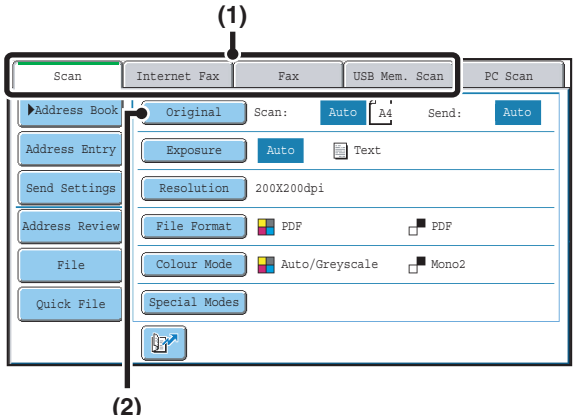

Select the mode and display the image settings screen.

(1) Touch the tab of the mode that you wish to use.

(2) Touch the [Original] key.

2

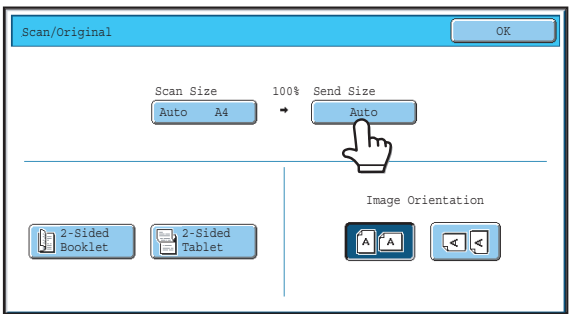

Touch the [Send Size] key.

3

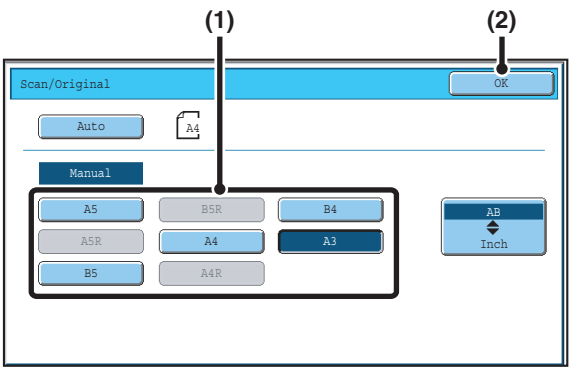

Specify the send size.

(1) Touch the desired send size key.

(2) Touch the [OK] key.

- Depending on the paper size specified for the "Scan Size", it may not be possible to select some sizes for the "Send Size". Size keys that cannot be specified for the "Send Size" are greyed out to prevent selection.
- To specify an inch size for the send size, touch the [AB ◆ Inch] key to highlight the [Inch] side and then specify the send size.

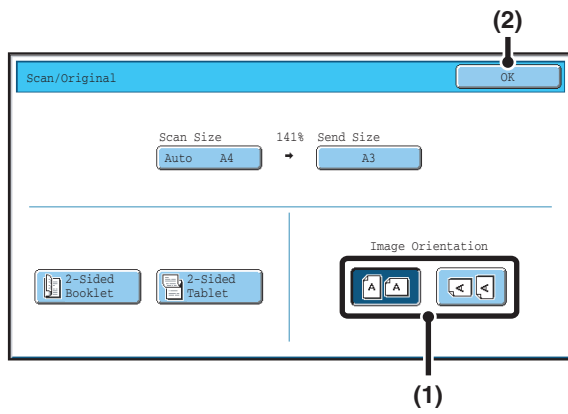

Specify the orientation in which the original is placed.

(1) Touch the appropriate [Image Orientation] key.

If this setting is not correct when sending an image with a changed ratio, a suitable image may not be transmitted.

(2) Touch the [OK] key.



The ratio used for reduction or enlargement of the original will appear between the "Scan Size" and the "Send Size".

CHANGING THE EXPOSURE AND EXPOSURE MODE (ORIGINAL IMAGE TYPE)

The exposure can be changed to match the darkness of the original. In scan mode and USB memory mode, the exposure mode can be set to match the original image type.

Refer the following tables to select appropriate settings.

How to select the exposure

| Exposure | | When to select |
|----------|-----|---|
| Auto | | This setting automatically adjusts the exposure for light and dark parts of the original. |
| Manual | 1-2 | Select this setting when the original consists of dark text. |
| | 3 | Select this setting for a normal original (neither dark nor light). |
| | 4-5 | Select this setting when the original consists of faint text. |

How to select the original image type

| Setting | Description |
|-----------------|--|
| Text/Prt. Photo | This mode provides the best balance for scanning an original which contains both text and printed photographs, such as a magazine or catalogue. |
| Text/Photo | This mode provides the best balance for scanning an original which contains both text and photographs, such as a text document with a photo pasted on. |
| Text | Use this mode for regular text documents. |
| Photo | Use this mode to scan photos. |
| Printed Photo | This mode is best for scanning printed photographs, such as photos in a magazine or catalogue. |
| Map | This mode is best for scanning the colour shading and fine details found on most maps. |

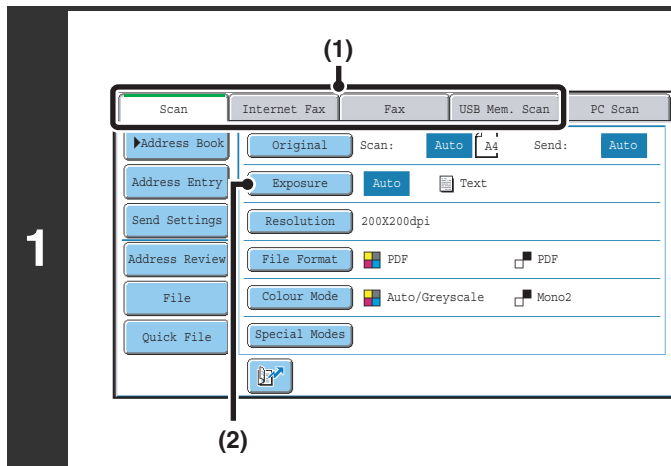

Select the mode and display the exposure settings screen.

- (1) Touch the tab of the mode that you wish to use.
- (2) Touch the [Exposure] key.

2

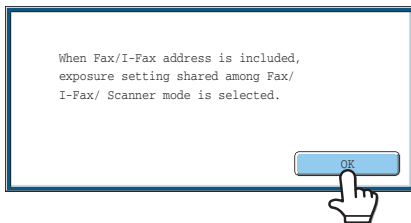

Read the displayed message and touch the [OK] key.

This message does not appear in USB memory mode or Internet fax mode. Go to the next step.



If a broadcast transmission is performed that includes both scan mode destinations and Internet fax destinations, the exposure settings for Internet fax mode will have priority.

3

Scan mode, USB memory mode

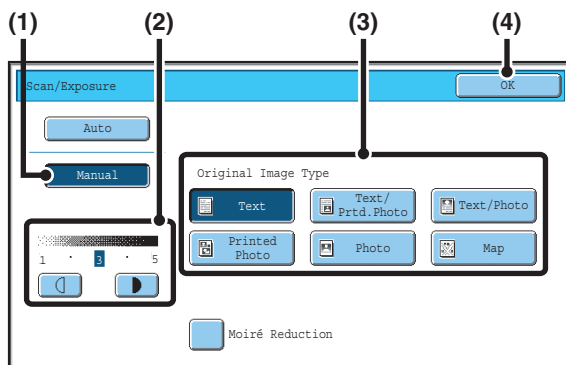

Select the exposure and original image type.

(1) Touch the [Manual] key.

(2) Adjust the exposure with the keys.

When the exposure is set to [Auto], the keys cannot be used.

The exposure darkens when the key is touched, and lightens when the key is touched.

To return to auto exposure adjustment, touch the [Auto] key.

(3) Select the original image type.

Touch the original image type key that matches the original image type.

(4) Touch the [OK] key.

Internet fax mode

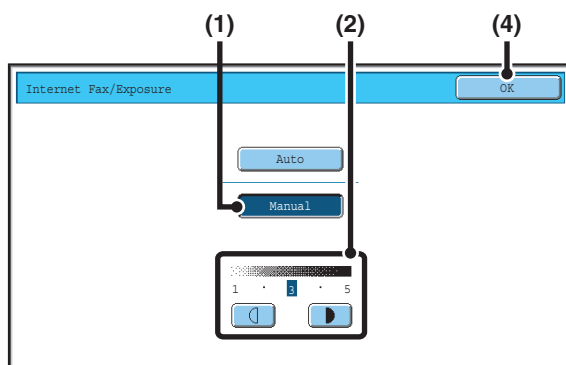

- In Internet fax mode, the original image type and moiré reduction cannot be selected.
- When the exposure is set to [Auto], [Printed Photo], [Photo] and [Map] do not appear.
- When the original image type is set to [Printed Photo], [Photo], or [Map], [Auto] will not appear.
- To reduce the occurrence of line patterns (moiré effect) when scanning printed matter, touch the [Moiré Reduction] checkbox so that a checkmark appears.



When using the document glass to scan multiple original pages, the exposure setting can be changed each time you change pages. When using the automatic document feeder, the exposure setting cannot be changed once scanning has begun. (However, when "Job Build" is used in the special modes, the exposure can be changed each time a new set of originals is inserted.)



System Settings (Administrator): Default Exposure Settings

This is used to change the default exposure setting.

CHANGING THE RESOLUTION

The resolution setting can be selected.

1

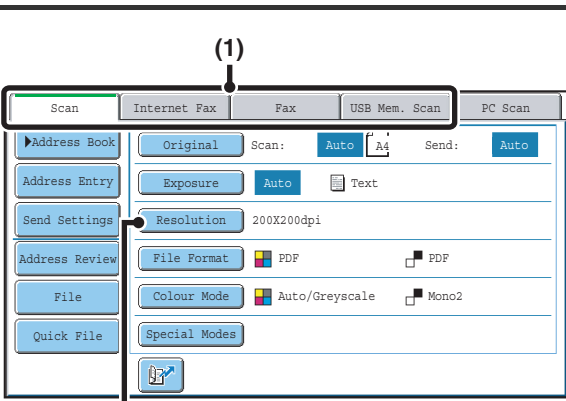

(1) Select the mode and display the image settings screen.

(1) Touch the tab of the mode that you wish to use.

(2) Touch the [Resolution] key.

(2)

2

Scan mode, USB memory mode



(1) Touch the key of the desired resolution.

(2) Touch the [OK] key.

Internet fax mode



(1) Touch the key of the desired resolution.

(2) Touch the [OK] key.



In Internet fax mode, the [Half Tone] key can be touched to select halftone (except when [200X100dpi] is selected). When the original has many gradations of light and dark such as a photo or colour illustration, halftone provides a more attractive image than regular transmission.

How to select the resolution

For normal text originals, 200X200dpi (200X100dpi in Internet fax mode) produces an image that is sufficiently legible. For photos and illustrations, a high resolution setting (600X600dpi, etc.) will produce a sharp image. However, a high resolution setting will result in a large file, and if the file is too large, transmission may not be possible. In this event, reduce the number of pages scanned or take other measures to decrease the file size.

CHANGING THE FILE FORMAT

Specifying the send size of the image (page 60)

- When using the document glass to scan multiple original pages, the resolution setting can be changed each time you change pages. When using the automatic document feeder, the resolution setting cannot be changed once scanning has begun. (However, when "Job Build" is used in the special modes, the resolution can be changed each time a new set of originals is inserted.)
- When [TIFF-S] is selected for the format in Internet fax mode, only [200X100dpi] or [200X200dpi] can be selected.



System Settings (Administrator): Initial Resolution Setting

This is used to change the default resolution setting.

CHANGING THE FILE FORMAT

Changing the format (scan mode and USB memory mode)

The file format (file type and compression mode/compression ratio) for sending a scanned image can be changed at the time of transmission. In addition, if the scanned originals are divided into separate files, the number of pages per file can be changed.

- The file format for sending a scanned image is specified when the destination is stored in a one-touch key; however, you can change the format at the time of transmission.

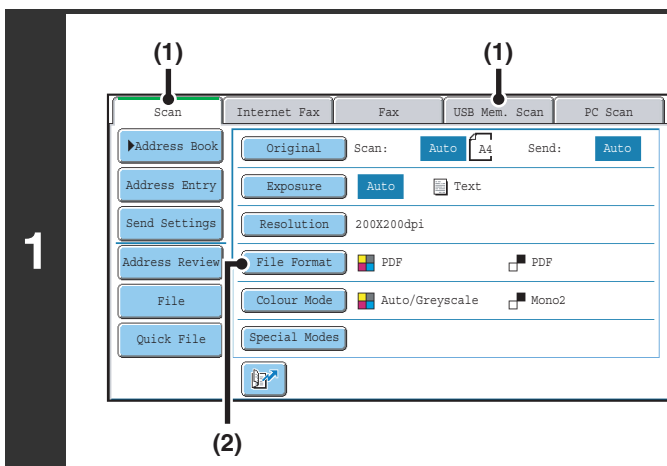

Select the mode and display the image settings screen.

- Touch the tab of the mode that you wish to use.
- Touch the [File Format] key.

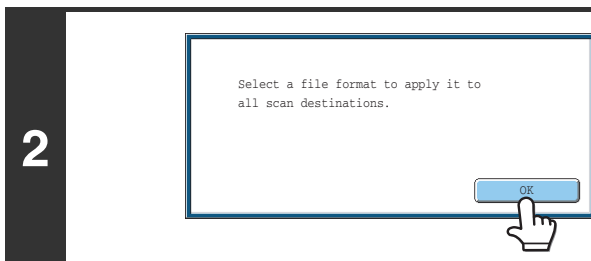

Read the displayed message and touch the [OK] key.

The message does not appear in USB memory mode. Go to the next step.

Set the format.

● Scanning in Mono2

- (1) Select the file type.
- (2) Select the compression mode.

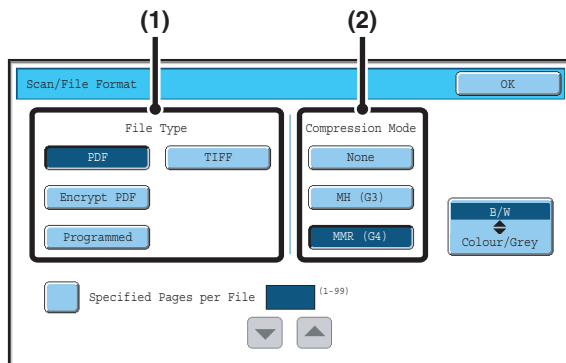

● Scanning in colour/greyscale

- (1) Touch the indicated key to select [Colour/Greyscale] mode.

When [Colour/Greyscale] is highlighted, [Colour/Greyscale] mode is selected.

- (2) Select the file type.
- (3) Select the compression ratio.

High compression results in a smaller file size, however, the image quality is slightly degraded.

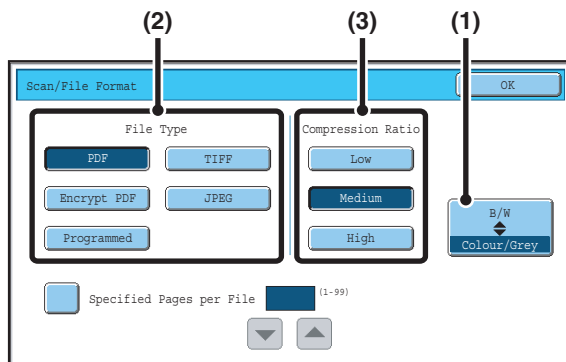

3



- The [Programmed] key does not appear in USB memory mode.
- When this screen is displayed, the setting screen of [B/W] mode initially appears.
- The format setting for [B/W] mode is the file format that is used when the [BLACK & WHITE START] key (○●) is pressed with the B/W mode set to [Mono2].
- The format setting for [Colour/Greyscale] mode is the file format that is used when the [COLOUR START] key (●●●) is pressed, or when the [BLACK & WHITE START] key (○●) is pressed with the B/W mode set to [Greyscale].
- The file type of [B/W] mode and the file type of [Colour/Greyscale] mode are linked. The file type cannot be set separately for each. (When [JPEG] is selected for [Colour/Greyscale] mode, [TIFF] is automatically selected for [B/W] mode.)

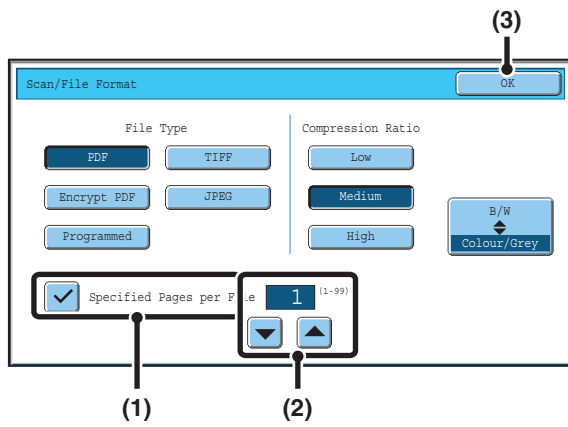

To change the number of pages per file, enter the number of pages and exit the format settings.

- (1) Touch the [Specified Pages per File] checkbox so that a checkmark appears.
- (2) Set the number of pages per file with the keys.
- (3) Touch the [OK] key.



- When a checkmark does not appear in the [Specified Pages per File] checkbox , one file is created for all scanned pages.
- When [Specified Pages per File] is selected, consecutive numbers are added to the created file names.
- When [JPEG] is selected for the file type, one file is created for each page (a file cannot be created for multiple pages). For this reason, the [Specified Pages per File] checkbox does not appear.



When [Encrypt PDF] is selected, a password entry screen will appear when the [START] key is pressed to begin scanning and transmission.

Touch the [Entry] key in the displayed screen to open the keyboard screen. Enter a password (maximum of 32 characters) and touch the [OK] key. Scanning and transmission will begin.



System Settings (Administrator): Initial File Format Setting

This sets the default file format setting for scanner transmission.

Changing the format (Internet fax mode)

The file format for sending an Internet fax is normally set to [TIFF-F]. If the destination Internet fax machine does not support full mode (it only supports simple mode), follow the steps below to select [TIFF-S].

1

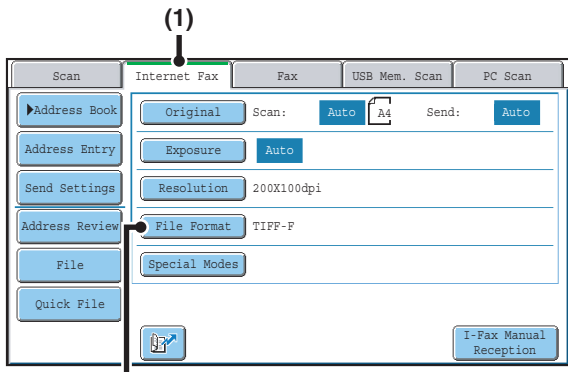

(1)

(2)

Switch to Internet fax mode and display the file format settings screen.

- (1) Touch the [Internet Fax] tab.
- (2) Touch the [File Format] key.

2

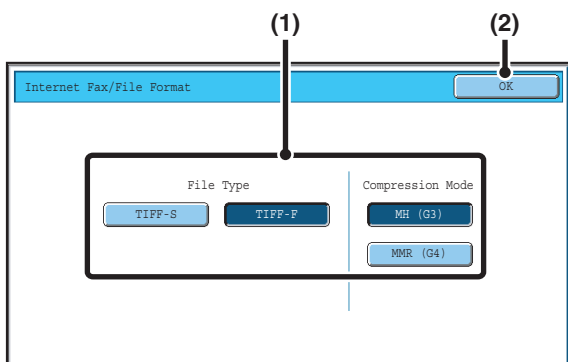



(1)

(2)

Select the file format.

- (1) Touch the key of the desired format.
If you selected [TIFF-F], select the compression mode.
- (2) Touch the [OK] key.

-  When [TIFF-S] is selected, the transmission settings are restricted as follows:
- Resolution: The selections are [200X100dpi] and [200X200dpi]. If [TIFF-S] is selected after [200X400dpi], [400X400dpi] or [600X600dpi] is selected, the resolution automatically changes to [200X200dpi].
 - Send size: Always A4R (8-1/2" x 11"R). If [TIFF-S] is selected after the send size is changed, the send size is automatically changed to A4R (8-1/2" x 11"R). If a size larger than A4 (8-1/2" x 11") is scanned, the size will automatically be reduced to A4R (8-1/2" x 11"R). When this format is included in a broadcast transmission, the image will be transmitted to all destinations at A4R (8-1/2" x 11"R).
 - Special modes: When a ratio setting is selected and the original size is entered, Dual Page Scan, Card Shot, 2in1, and Mixed Size Original cannot be used.

 **System Settings (Administrator): Compression Setting**
This is used to set the default compression mode for Internet fax transmission.

CHANGING THE COLOUR MODE

This procedure is used to change the colour mode used to scan the original when the [COLOUR START] key (●●●●) or the [BLACK & WHITE START] key (○●) is pressed.

 This function cannot be used in Internet fax mode.

| Start key | Mode | Scanning method |
|---------------------------|-------------|---|
| [COLOUR START] key | Auto | The machine detects whether the original is colour or black and white and automatically selects full colour or black and white (Mono2 or Greyscale) scanning. |
| | Full Colour | The original is scanned in full colour. This mode is best for full colour originals such as catalogues. |
| [BLACK & WHITE START] key | Mono2 | Colours in the original are scanned as black or white. This mode is best for text-only originals. |
| | Greyscale | The colours in the original are scanned in black and white as shades of grey (greyscale). |

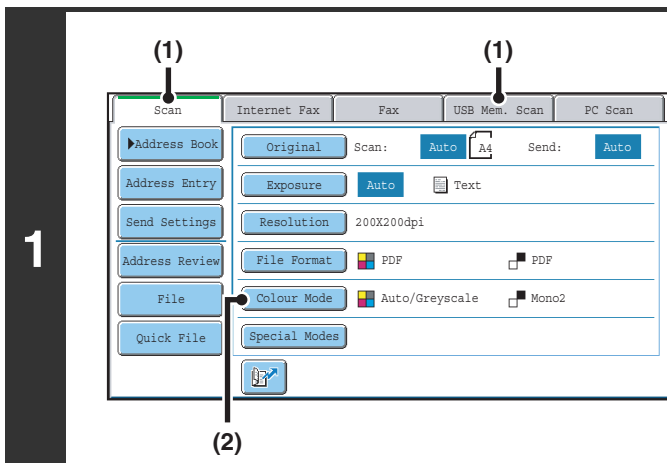

Select the mode and display the colour mode settings screen.

- (1) Touch the tab of the mode that you wish to use.
- (2) Touch the [Colour Mode] key.

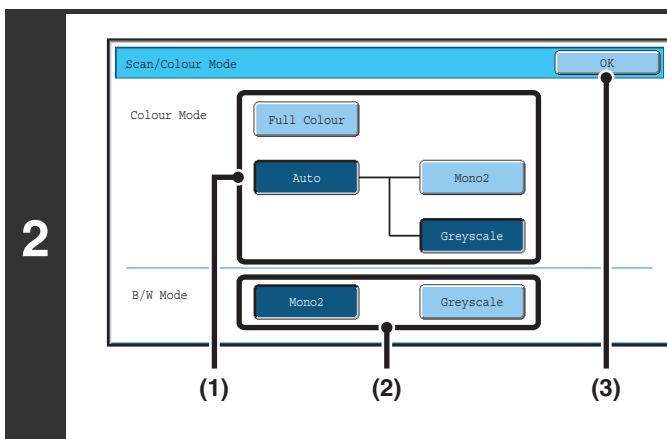

Select the colour mode.

- (1) Touch the key of the mode to be used when the [COLOUR START] key (●●●●) is pressed.
You can select whether black & white scanning will take place in Mono2 or greyscale when [Auto] is selected and a black and white original is scanned. Note that if the file format is set to JPEG, scanning will take place in greyscale.
- (2) Touch the key of the mode to be used when the [BLACK & WHITE START] key (○●) is pressed.
- (3) Touch the [OK] key.



System Settings (Administrator): Default Colour Mode Settings

The default colour mode can be changed.

System Settings (Administrator): Disable Change of B/W Setting in Auto Mode

This prohibits selection of the black and white original scanning setting when [Auto] is selected for the colour mode.

4 SPECIAL MODES

This chapter explains special modes that can be used in scan send mode.

SPECIAL MODES

When the [Special Modes] key is pressed in the base screen, the special modes menu screen appears. When the [OK] key is touched in the special modes screen, the selected settings are entered and the base screen reappears.

Scan mode, USB memory mode, Data entry mode

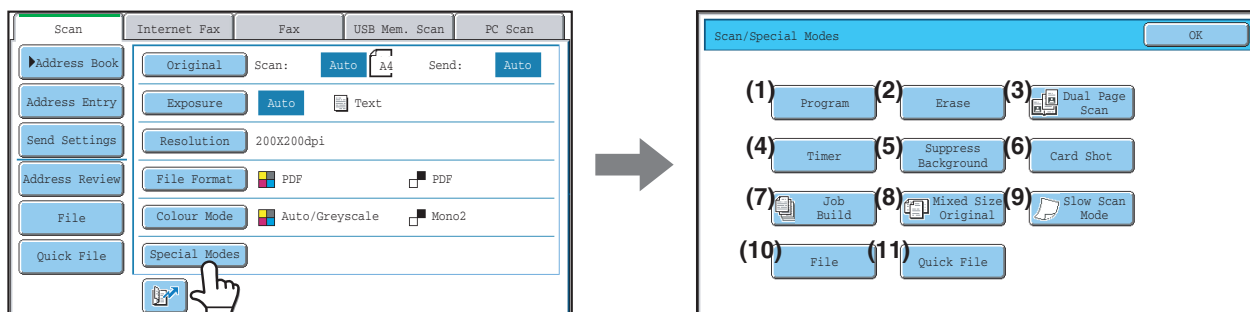



- (1) **[Program] key*1, 2**
☞ [STORING SCAN OPERATIONS \(Programs\)](#) (page 72)
- (2) **[Erase] key**
☞ [ERASING PERIPHERAL SHADOWS ON THE IMAGE \(Erase\)](#) (page 74)
- (3) **[Dual Page Scan] key**
☞ [SCANNING AN ORIGINAL AS TWO SEPARATE PAGES \(Dual Page Scan\)](#) (page 77)
- (4) **[Timer] key*1**
☞ [SENDING AN IMAGE AT A SPECIFIED TIME \(Timer Transmission\)](#) (page 79)
- (5) **[Suppress Background] key**
☞ [WHITENING FAINT COLOURS IN THE IMAGE \(Suppress Background\)](#) (page 82)
- (6) **[Card Shot] key**
☞ [SCANNING BOTH SIDES OF A CARD ONTO A SINGLE PAGE \(Card Shot\)](#) (page 84)

- (7) **[Job Build] key**
☞ [SCANNING MANY ORIGINALS AT ONCE \(Job Build\)](#) (page 87)
- (8) **[Mixed Size Original] key**
☞ [SCANNING ORIGINALS OF DIFFERENT SIZES \(Mixed Size Original\)](#) (page 90)
- (9) **[Slow Scan Mode] key**
☞ [SCANNING THIN ORIGINALS \(Slow Scan Mode\)](#) (page 92)
- (10) **[File] key*1**
Touch this to use the File function of document filing mode. For more information on File, see the Document Filing Guide.
- (11) **[Quick File] key*1**
Touch this to use the Quick File function of document filing mode. For more information on Quick File, see the Document Filing Guide.

*1 Does not appear in USB memory mode.

*2 Does not appear in data entry mode.

Internet fax mode

There are two special mode menu screens in Internet fax mode. Touch the   keys to switch between the two screens.

The keys explained below can only be used in Internet fax mode. The other keys are the same as those explained in "Scan mode, USB memory mode, Data entry mode" (page 70).

1st screen

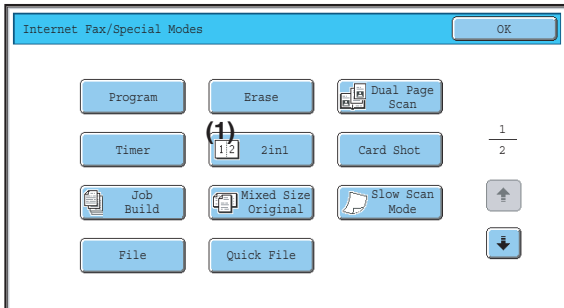

2nd screen

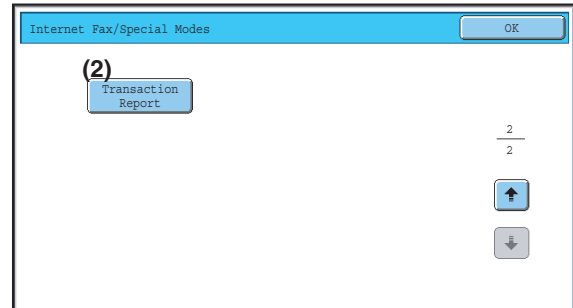

(1) [2in1] key

 [SENDING TWO PAGES AS A SINGLE PAGE \(2in1\)](#)
(page 94)

(2) [Transaction Report] key

 [CHANGING THE PRINT SETTINGS FOR THE TRANSACTION REPORT \(Transaction Report\)](#)
(page 97)

 Special modes can generally be combined with other special modes, however, there are some combinations that are not possible. If a prohibited combination is selected, a message will appear in the touch panel.

[OK] key and [Cancel] key

In some cases two [OK] keys and one [Cancel] key will appear in the special mode screens. The keys are used as follows:

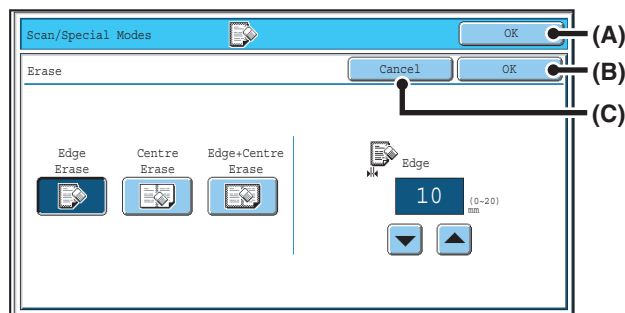

(A) Enter the selected special mode setting and return to the base screen.

(B) Enter the selected special mode setting and return to the special mode menu screen. Touch this key when you wish to continue selecting other special mode settings.

(C) During selection of special mode settings, this key returns you to the special mode menu screen without saving the settings. When settings have been completed, this cancels the settings and returns you to the special mode menu screen.

STORING SCAN OPERATIONS (Programs)

A destination, original settings, and functions can be stored in a program. When you wish to use those settings to send an image, they can be retrieved with ease.

For example, suppose A4 (8-1/2" x 11") size documents are scanned into a file and sent to each branch office once a month.

- (1) The same documents are sent to each branch office
- (2) Each page of a bound document is successively transmitted
- (3) Smudges on the edges of the documents are erased before transmission

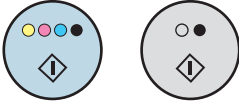
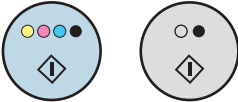
| When a job program is not stored | When a job program is stored |
|--|--|
| <p>Enter the address of each branch office.</p> <p style="text-align: center;">↓</p> <p>Select Dual Page Scan</p> <p style="text-align: center;">↓</p> <p>Select Erase settings</p> <p style="text-align: center;">↓</p>  <p>Press the [START] key. The originals are scanned and transmitted.</p> | <p>Touch a stored program key.</p> <p style="text-align: center;">↓</p>  <p>Press the [START] key. The originals are scanned and transmitted.</p> |
| <p>Considerable time is required to send the documents each month because the above settings must be selected. In addition, mistakes may occasionally be made when selecting the settings, so incorrect transmissions may occur.</p> | <p>When a program is used, settings are selected with ease by simply pressing the stored key. In addition, transmission takes place based on the stored settings so there are no chances for mistakes.</p> |

-  **Programs are stored, edited, and deleted using "Address Control" in the system settings. See "Program" in the System Settings Guide.**
- Programs can also be stored in the Web pages. Click [Job Programs] and then [Program Registration] in the Web page menu.
- The settings stored in a program will be retained even after the program is used for transmission. The same settings can be used repeatedly for transmission.
- The following settings can be stored in programs.
 - Image send mode: Scan, Internet fax
 - Destinations
 - Image settings: Exposure, Resolution
 - Special modes: Erase, Dual Page Scan, Suppress Background, 2in1
- Up to 48 programs can be stored.
- Up to 500 destinations can be stored in one program. (If a Scan to Network Folder destination is selected, only one destination can be stored.)
- This function cannot be used in USB memory mode or data entry mode.

1

Place the original.

Place the original in the document feeder tray or on the document glass as appropriate for the functions stored in the program.

Select the special modes.

2

(1) Touch the [Special Modes] key.

(2) Touch the [Program] key.

[SPECIAL MODES](#) (page 70)

3

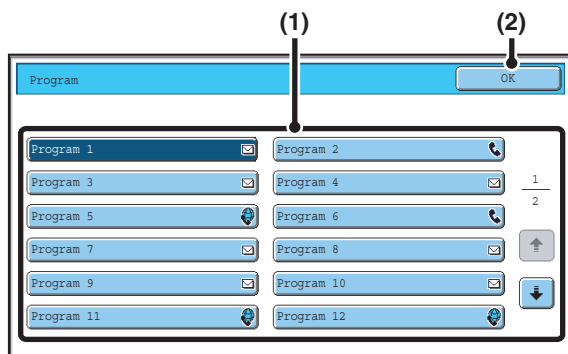

Retrieve the stored program.

(1) Touch the desired program key.

(2) Touch the [OK] key.

4

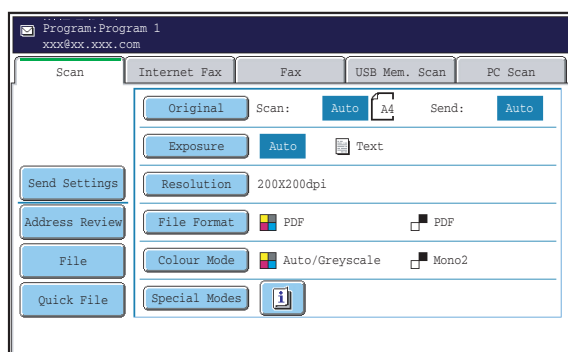

Select additional settings.

Select any settings or functions that you wish to use that cannot be stored in a program. The following items can be selected.

- Image Settings: original scan size, send size, 2-sided scanning, file format, colour mode
- Send settings
- Special modes: Timer Transmission, Card Shot, Job Build, Mixed Size Original, Slow Scan Mode, File, Quick File, Transaction Report



- The screen that appears will vary depending on the destination stored in the program.
- The mode cannot be changed here.
- Functions stored in the program cannot be cancelled here.

5

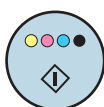

or



Press the [COLOUR START] key (●●●●) or the [BLACK & WHITE START] key (●●).

Scanning begins.

- If you inserted the original pages in the document feeder tray, all pages are scanned. A beep will sound to indicate that scanning is finished.
- If you are scanning the original on the document glass, scan each page one page at a time. When scanning finishes, place the next original and press the [COLOUR START] key (●●●●) or the [BLACK & WHITE START] key (●●). Repeat until all pages have been scanned and then touch the [Read-End] key. A beep will sound to indicate that scanning is finished.



To cancel scanning...

Press the [STOP] key (⏏) to cancel the operation.

ERASING PERIPHERAL SHADOWS ON THE IMAGE (Erase)

The erase function is used to erase shadows on images produced when scanning thick originals or books. (This function erases the parts of the image where shadows tend to form. The function does not detect shadows and erase only the shadows.)

Scanning a thick book

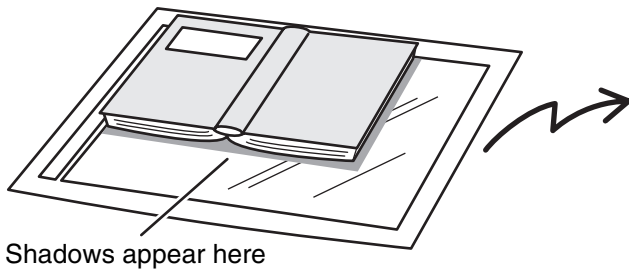

| Not using the erase function | Using the erase function |
|-------------------------------------|---------------------------|
| <p>Shadows appear in the image.</p> | <p>No shadows appear.</p> |

Erase modes

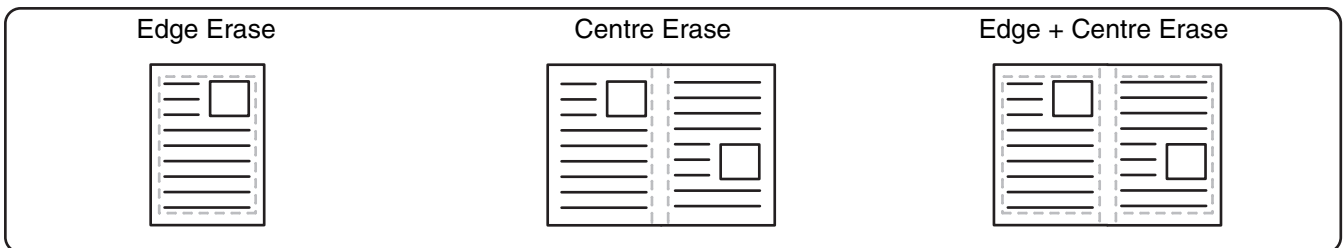

- Shadows at the edges of the original can also be erased when the automatic document feeder is used.
- When using USB memory mode, connect the USB memory device to the machine before performing the procedure below.

1 Place the original.

Place the original face up in the document feeder tray, or face down on the document glass.

2 Select the special modes.



- (1) Touch the tab of the mode that you wish to use.
- (2) Touch the [Special Modes] key.
- (3) Touch the [Erase] key.

 [SPECIAL MODES](#) (page 70)

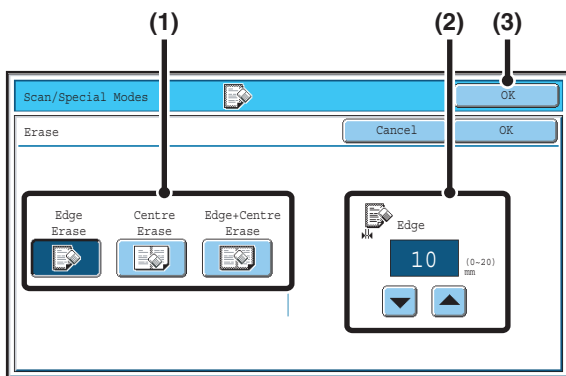
3



Select the erase settings.

- (1) **Touch the desired erase mode.**
Select one of the three erase modes.
- (2) **Set the erasure width with the   keys.**
0 mm to 20 mm (0" to 1") can be entered.
- (3) **Touch the [OK] key.**

4

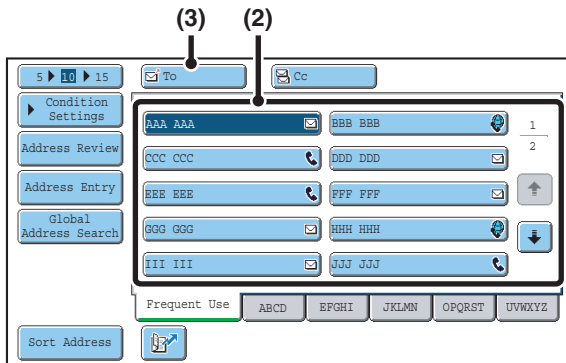

Specify the destination.

- (1) **Touch the [Address Book] key in the base screen.**
- (2) **Touch one-touch keys of the destinations that you wish to store in the group.**
- (3) **Touch the [To] key.**



- When scanning to USB memory, there is no need to specify the destination. Go to step 5.
- In addition to specification by a one-touch key, a destination can also be specified by a search number. You can also manually enter an e-mail address or look up an e-mail address in a global address book. For more information, see "2. ENTERING DESTINATIONS" (page 20).

5



or



Press the [COLOUR START] key (●●●●) or the [BLACK & WHITE START] key (●●).

Scanning begins.

- If you inserted the original pages in the document feeder tray, all pages are scanned.
A beep will sound to indicate that scanning is finished.
- If you are scanning the original on the document glass, scan each page one page at a time.
When scanning of one page finishes, replace it with the next page and press the [COLOUR START] key (●●●●) or the [BLACK & WHITE START] key (●●). Repeat until all pages have been scanned and then press the [Read-End] key.
A beep will sound to indicate that scanning is finished.



- If the destination is an Internet fax destination, press the [BLACK & WHITE START] key (●●).



- To cancel scanning...**
Press the [STOP] key (⏹) to cancel the operation.



When the erase function is used, erase takes place at the edges of the original image. If you also use a reduction or an enlargement setting, the erase width will change according to the selected ratio. For example, if the erase width setting is 20 mm (1") and the image is reduced to 50%, the erase width will be 10 mm (1/2").



To cancel the erase setting...

Touch the [Cancel] key in the screen of step 3.



System Settings (Administrator): Erase Width Adjustment

The default erase width setting is linked to the copy mode system setting, and can be set from 0 mm to 20 mm (0" to 1"). The factory default setting is 10 mm (1/2").

SCANNING AN ORIGINAL AS TWO SEPARATE PAGES (Dual Page Scan)

The left and right sides of an original can be scanned as two separate pages. This function is useful when you wish to successively scan each page of a book or other bound document.

Example: Scanning the left and right pages of a book

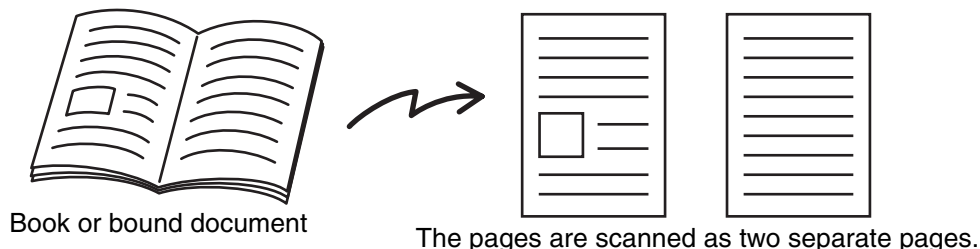

Example:

| Original scan size | Transmitted image |
|-------------------------|-----------------------------|
| A3 (11" x 17") x 1 page | A4 (8-1/2" x 11") x 2 pages |

- When using dual page scan, the original must be placed on the document glass.
- The send size cannot be changed.
- When using USB memory mode, connect the USB memory device to the machine before performing the procedure below.

1

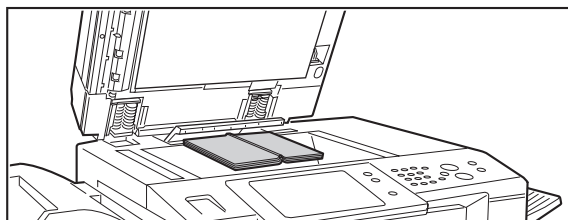

Place the original face down on the document glass.

Align the centre of the original with the appropriate size mark ▼.

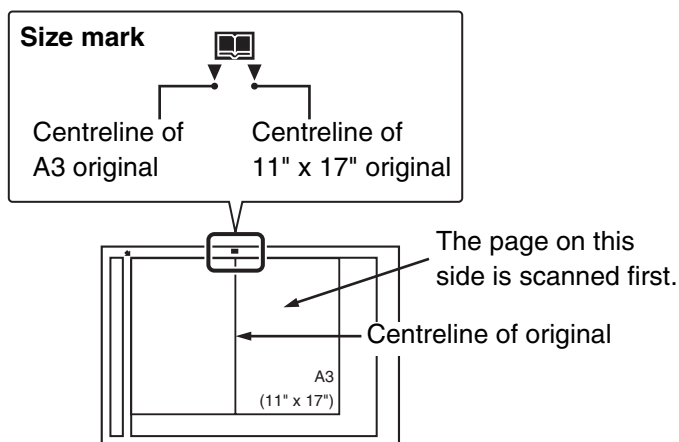

2

Select the special modes.

- (1) Touch the tab of the mode that you wish to use.
- (2) Touch the [Special Modes] key.

📖 [SPECIAL MODES](#) (page 70)

3

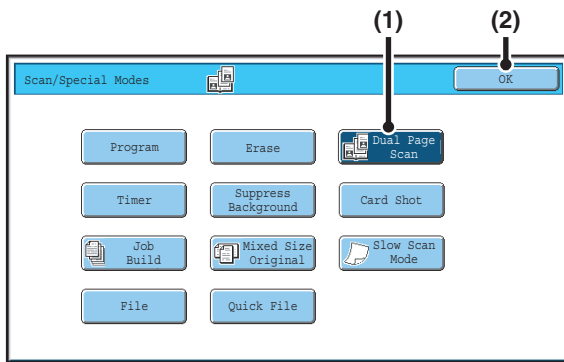

Select Dual Page Scan.

- (1) Press the [Dual Page Scan] key so that it is highlighted.
- (2) Touch the [OK] key.

4

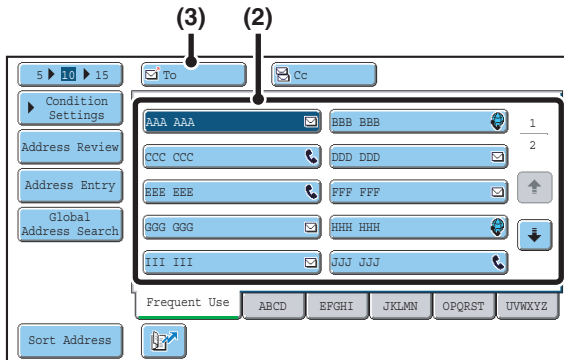

Specify the destination.

- (1) Touch the [Address Book] key in the base screen.
- (2) Touch one-touch keys of the destinations that you wish to store in the group.
- (3) Touch the [To] key.



- When scanning to USB memory, there is no need to specify the destination. Go to step 5.
- In addition to specification by a one-touch key, a destination can also be specified by a search number. You can also manually enter an e-mail address or look up an e-mail address in a global address book. For more information, see "2. ENTERING DESTINATIONS" (page 20).

5

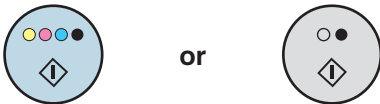

Press the [COLOUR START] key (●●●●) or the [BLACK & WHITE START] key (○●).

Scanning begins.

When scanning finishes, place the next original and press the [COLOUR START] key (●●●●) or the [BLACK & WHITE START] key (○●). Repeat until all pages have been scanned and then touch the [Read-End] key.

A beep will sound to indicate that scanning is finished.



- If the destination is an Internet fax destination, press the [BLACK & WHITE START] key (○●).



To cancel scanning...

Press the [STOP] key (⊞) to cancel the operation.



- To erase shadows caused by the binding of a book or other bound document, use the erase function. (Note, however, that "Centre Erase" and "Edge + Centre Erase" cannot be used.)
- When the scan size of the original is specified by numerical values, this function cannot be used.



To cancel the dual page scan setting...

Touch the [Dual Page Scan] key in the screen of step 3 so that it is no longer highlighted, and touch the [OK] key.

SENDING AN IMAGE AT A SPECIFIED TIME (Timer Transmission)

This function lets you specify a time at which a transmission or broadcast transmission will automatically take place. Transmission begins automatically at the specified time.

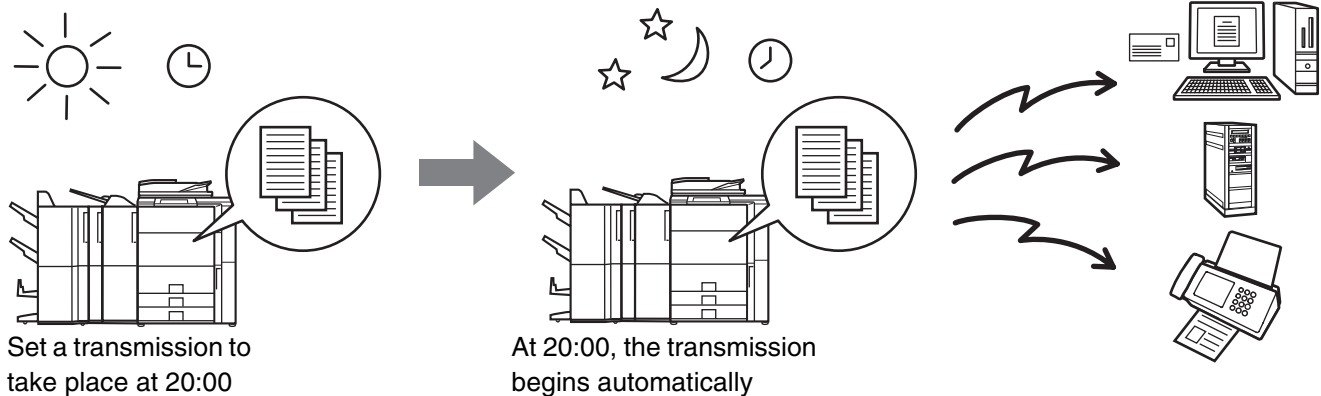

- When a timer transmission is stored, keep the main power switch in the "on" position. If the main power switch is in the "off" position at the specified time, transmission will not take place.
- When performing a timer transmission, you must scan the original into memory when you set up the transmission. It is not possible to leave the document in the auto document feeder or on the document glass and have it scanned at the specified time of transmission.
- Settings selected for a timer transmission (exposure, resolution, special modes, etc.) are automatically cleared after the transmission is finished. (However, when the document filing function is used, the scanned original and settings are stored on the built-in hard drive. For more information on the document filing function, see the Document Filing Guide.)
- This function cannot be used in USB memory mode.

1

Place the original.

Place the original face up in the document feeder tray, or face down on the document glass.

2

Select the special modes.

(1) Touch the tab of the mode that you wish to use.

(2) Touch the [Special Modes] key.

(3) Touch the [Timer] key.

 [SPECIAL MODES](#) (page 70)

3

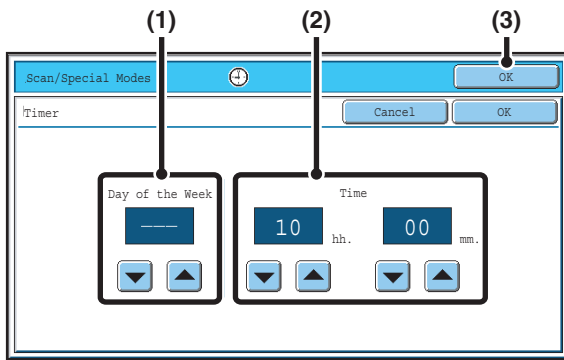

Set the time with the   keys.

(1) Specify the day.

If you do not wish to specify a day, select [--]. In this case, transmission will begin when the time specified in (2) arrives.

(2) Specify the time (hour, minute)

Select the time in 24-hour format.

(3) Touch the [OK] key.



When this screen is opened, the setting will show the current time. If the time is not correct, press the [CLEAR ALL] key (CA) to cancel the operation. Correct the time in the system settings and then perform the timer transmission procedure. [CHECKING THE DATE AND TIME](#) (page 8)

4

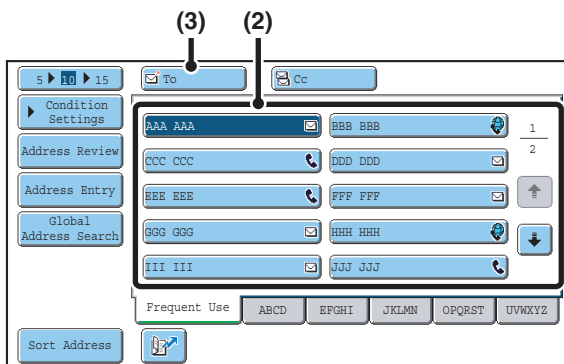

Specify the destination.

(1) Touch the [Address Book] key in the base screen.

(2) Touch one-touch keys of the destinations that you wish to store in the group.

(3) Touch the [To] key.



In addition to specification by a one-touch key, a destination can also be specified by a search number. You can also manually enter an e-mail address or look up an e-mail address in a global address book. For more information, see ["2. ENTERING DESTINATIONS"](#) (page 20).

5

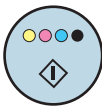

or



Press the [COLOUR START] key (●●●●) or the [BLACK & WHITE START] key (●●).

Scanning begins.

- If you inserted the original pages in the document feeder tray, all pages are scanned. A beep will sound to indicate that scanning is finished.
- If you are scanning the original on the document glass, scan each page one page at a time. When scanning finishes, place the next original and press the [COLOUR START] key (●●●●) or the [BLACK & WHITE START] key (●●). Repeat until all pages have been scanned and then touch the [Read-End] key. A beep will sound to indicate that scanning is finished.



- If the destination is an Internet fax destination, press the [BLACK & WHITE START] key (●●).
- The original is scanned into memory. The original cannot be scanned at a specified time.



To cancel scanning...

Press the [STOP] key (⊘) to cancel the operation.



- The time can be specified up to a week in advance.
 - Up to 94 timer transmissions can be stored at once.
 - If another transmission is in progress when the specified time arrives, the timer transmission will begin after that transmission is finished.
 - Other transmissions can be performed as usual after a timer transmission is stored.
 - A timer transmission can be deleted in the job status screen.
 - If a timer transmission is given priority in the job status screen, the time specification is cancelled. The transmission will begin as soon as the job in progress is completed.
- [GIVING PRIORITY TO A SCAN TRANSMISSION JOB](#) (page 106)



To cancel timer transmission...

Touch the [Cancel] key in the screen of step 3.

WHITENING FAINT COLOURS IN THE IMAGE (Suppress Background)

This feature is used to suppress light background areas.

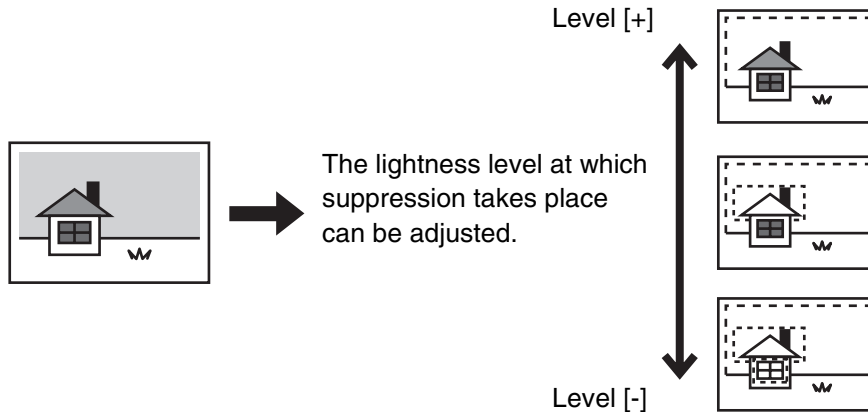

- This function cannot be used in Internet fax mode.
- When using USB memory mode, connect the USB memory device to the machine before performing the procedure below.

1 Place the original.

Place the original face up in the document feeder tray, or face down on the document glass.

2 Select the special modes.

- (1) Touch the tab of the mode that you wish to use.
- (2) Touch the [Special Modes] key.
- (3) Touch the [Suppress Background] key.

Read the message that appears and then touch the [OK] key.

[SPECIAL MODES](#) (page 70)

3

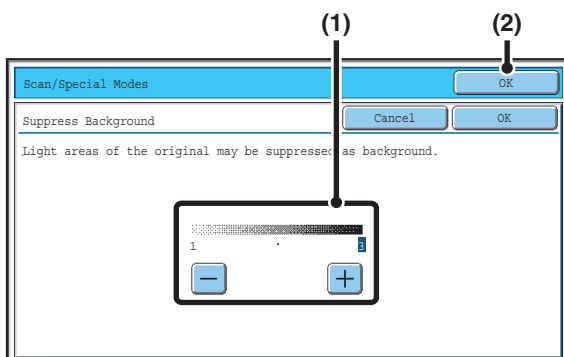

Select the suppress background setting.

- (1) **Adjust the background suppression level.**
Touch the [+] key to suppress only faint background.
Touch the [-] key to suppress faint to dark background.
- (2) **Touch the [OK] key.**

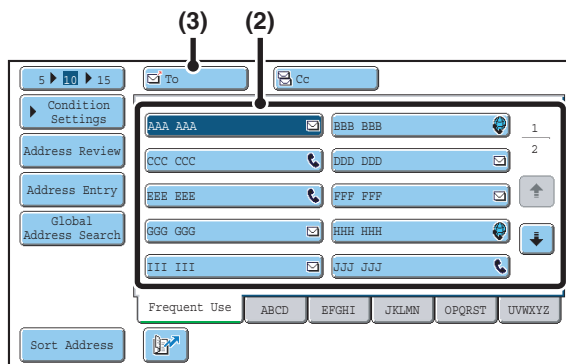

Specify the destination.

- (1) Touch the [Address Book] key in the base screen.
- (2) Touch one-touch keys of the destinations that you wish to store in the group.
- (3) Touch the [To] key.



- When scanning to USB memory, there is no need to specify the destination. Go to step 5.
- In addition to specification by a one-touch key, a destination can also be specified by a search number. You can also manually enter an e-mail address or look up an e-mail address in a global address book. For more information, see "2. ENTERING DESTINATIONS" (page 20).



or

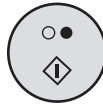

Press the [COLOUR START] key (●●●●) or the [BLACK & WHITE START] key (●●).

Scanning begins.

- If you inserted the original pages in the document feeder tray, all pages are scanned. A beep will sound to indicate that scanning is finished.
- If you are scanning the original on the document glass, scan each page one page at a time. When scanning finishes, place the next original and press the [COLOUR START] key (●●●●) or the [BLACK & WHITE START] key (●●). Repeat until all pages have been scanned and then touch the [Read-End] key. A beep will sound to indicate that scanning is finished.



When the colour mode setting of the [BLACK & WHITE START] key (●●) is [Mono2], the suppress background function will not operate if the [BLACK & WHITE START] key (●●) is pressed.



To cancel scanning...

Press the [STOP] key (⊘) to cancel the operation.



To cancel the background suppression setting...

Touch the [Cancel] key in the screen of step 3.

SCANNING BOTH SIDES OF A CARD ONTO A SINGLE PAGE (Card Shot)

This function lets you send the front and reverse sides of a card as a single page, without the need to send each side separately.

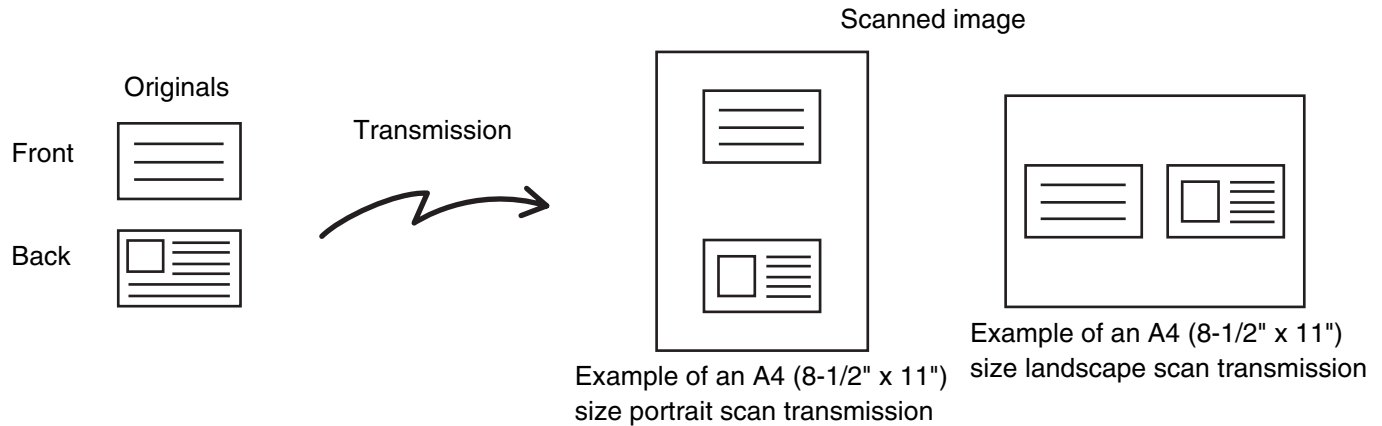

- When using card shot, the original must be placed on the document glass.
- When using USB memory mode, connect the USB memory device to the machine before performing the procedure below.

1

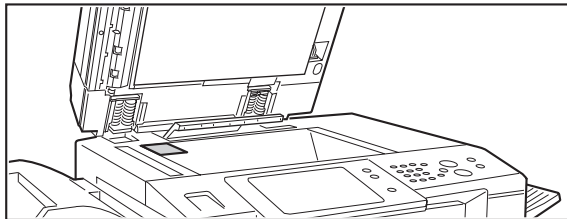

Place the original face down on the document glass.

2

Select the special modes.

- (1) Touch the tab of the mode that you wish to use.
- (2) Touch the [Special Modes] key.
- (3) Touch the [Card Shot] key.

[SPECIAL MODES](#) (page 70)

3

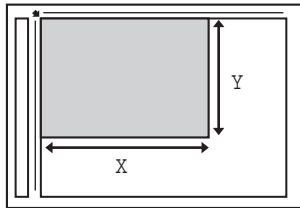
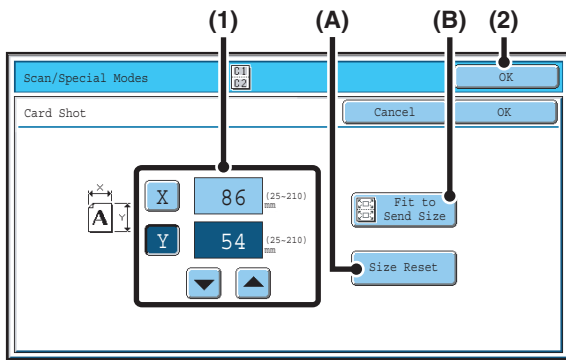

Specify the original size.

(1) Enter the original size.

- Touch the [X] key and enter the horizontal dimension (X) of the original with the keys.
- Touch the [Y] key and enter the vertical dimension (Y) of the original with the keys.

(A) To return the original size to the default size, touch the [Size Reset] key.

(B) To automatically enlarge or reduce the image to fit the send size, touch the [Fit to Send Size] key. If you wish to scan the original at the entered original size, there is no need to touch this key.

(2) Touch the [OK] key.



- The send size will be selected automatically based on the entered original size.
- After selecting Card Shot, you can touch the [Original] key in the base screen to change the original scan size or the send size. In this case, the screen of this step appears when you touch the scan size key. For the procedure for setting the send size, see "[Specifying the send size of the image](#)" (page60).

4

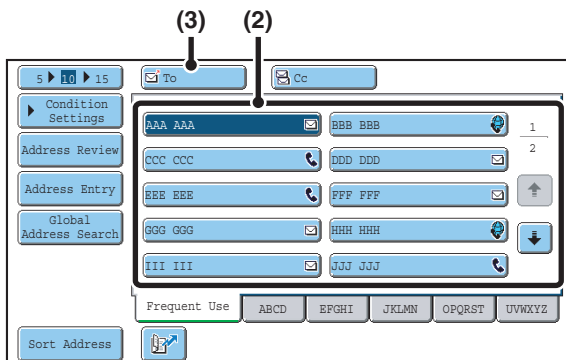

Specify the destination.

(1) Touch the [Address Book] key in the base screen.

(2) Touch one-touch keys of the destinations that you wish to store in the group.

(3) Touch the [To] key.



- When scanning to USB memory, there is no need to specify the destination. Go to step 5.
- In addition to specification by a one-touch key, a destination can also be specified by a search number. You can also manually enter an e-mail address or look up an e-mail address in a global address book. For more information, see "[2. ENTERING DESTINATIONS](#)" (page 20).

5

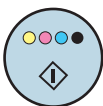

or



Press the [COLOUR START] key (●●●●) or the [BLACK & WHITE START] key (○●) to scan the front side of the card.



If the destination is an Internet fax destination, press the [BLACK & WHITE START] key (○●).



To cancel scanning...

Press the [STOP] key (⊘) to cancel the operation.

6

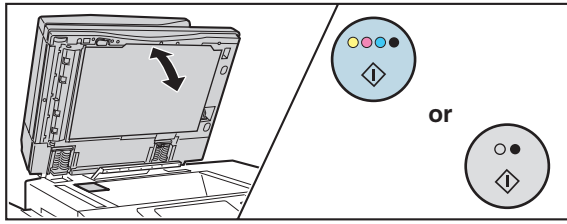

Turn the card over and press the [COLOUR START] key (●●●●) or the [BLACK & WHITE START] key (●●) to scan the reverse side of the card.

Press the same [START] key that was used to scan the front side.



Before scanning the back of the card, you can touch the [Configure] key in the touch panel to change the exposure.



To cancel scanning...

Press the [STOP] key (⊘) to cancel the operation.

7

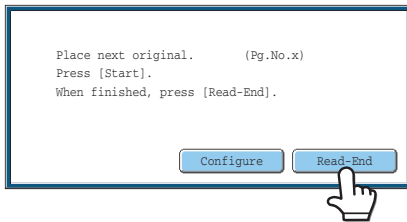

Touch the [Read-End] key.



If you will continue by scanning the front of the card, you can touch the [Configure] key to change the exposure, resolution, scan size, and send size.



The ratio cannot be specified and "Rotation Sending Setting" cannot be selected.



To cancel Card Shot...

Touch the [Cancel] key in the screen of step 3.

SCANNING MANY ORIGINALS AT ONCE (Job Build)

This function lets you separate an original consisting of numerous pages into sets, scan each set using the automatic document feeder, and transmit the pages in a single transmission. Use this function when the number of originals that you wish to scan exceeds the maximum number of sheets that can be inserted in the automatic document feeder at once.

When scanning originals that are separated into sets, scan the set that has the first page first. The settings that you select for the first set can be used for all remaining sets.

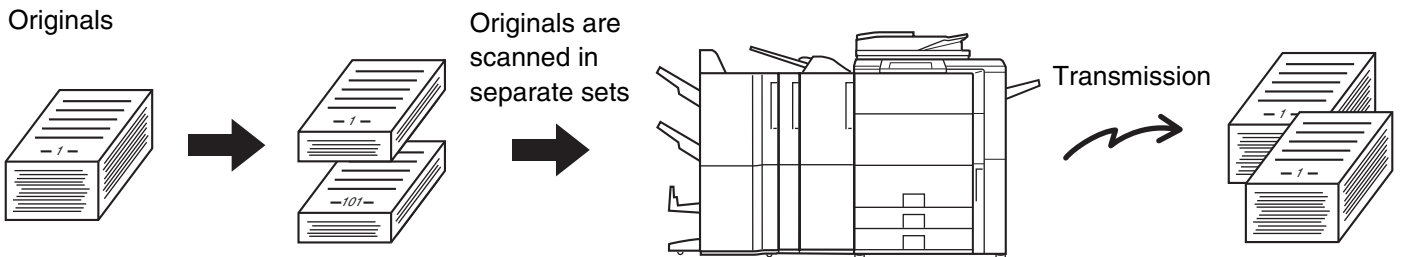

 When using USB memory mode, connect the USB memory device to the machine before performing the procedure below.

1

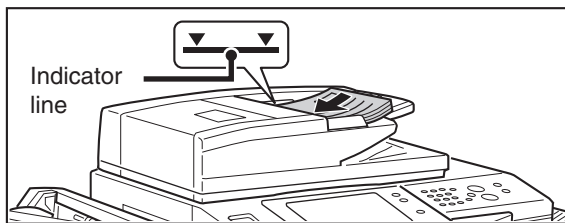

Insert the originals face up in the document feeder tray.

Insert the originals all the way into the document feeder tray. Multiple originals can be placed in the document feeder tray. The stack of originals must not be higher than the indicator line on the tray.

2

Select the special modes.

- (1) Touch the tab of the mode that you wish to use.
- (2) Touch the [Special Modes] key.

 [SPECIAL MODES](#) (page 70)

3

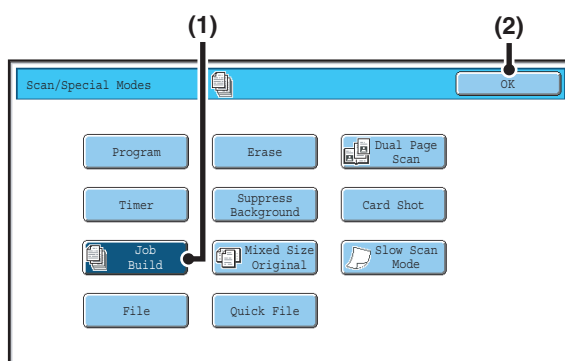

Select job build mode.

- (1) Touch the [Job Build] key so that it is highlighted.
- (2) Touch the [OK] key.

4

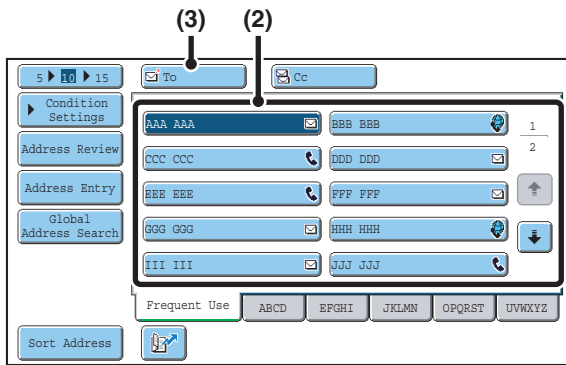

Specify the destination.

- (1) Touch the [Address Book] key in the base screen.
- (2) Touch one-touch keys of the destinations that you wish to store in the group.
- (3) Touch the [To] key.



- When scanning to USB memory, there is no need to specify the destination. Go to step 5.
- In addition to specification by a one-touch key, a destination can also be specified by a search number. You can also manually enter an e-mail address or look up an e-mail address in a global address book. For more information, see "2. ENTERING DESTINATIONS" (page 20).

5

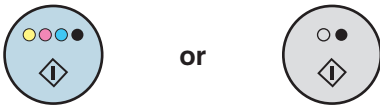

Press the [COLOUR START] key (●●●●) or the [BLACK & WHITE START] key (●●) to scan the first set of originals.



If the destination is an Internet fax destination, press the [BLACK & WHITE START] key (●●).



To cancel scanning...
Press the [STOP] key (⊘) to cancel the operation.

6

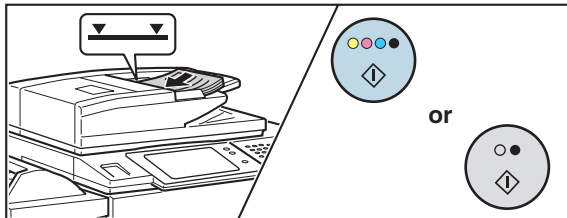

Insert the next set of originals and press the [COLOUR START] key (●●●●) or the [BLACK & WHITE START] key (●●).

Press the [START] key pressed in step 5.
Repeat until all originals have been scanned.



To cancel scanning...
Press the [STOP] key (⊘) to cancel the operation. All scanned data will be cleared.

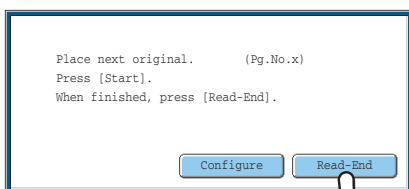

Touch the [Read-End] key.



- If no action is taken for one minute after the confirmation screen appears, scanning automatically ends and the transmission is reserved.
- The [Configure] key can be touched to change the exposure, resolution, scan size, and send size for each original page scanned. However, when Job Build is used in combination with "2in1" in the special modes, only the exposure can be changed when scanning each even-numbered page of the original pages.



If the memory becomes full during scanning, a message will appear and the transmission will be cancelled.



To cancel the job build function....

Touch the [Job Build] key in the screen of step 3 so that it is not highlighted.

SCANNING ORIGINALS OF DIFFERENT SIZES (Mixed Size Original)

This feature lets you scan originals of different sizes at the same time; for example, B4 (8-1/2" x 14") size originals mixed together with A3 (11" x 17") size originals. When scanning the originals, the machine automatically detects the size of each original.

Originals

(B4 (8-1/2" x 14") original mixed in with A3 (11" x 17") originals)

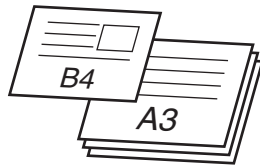

Files created

1st page

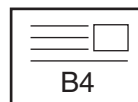

Scanned in at B4 (8-1/2" x 14") size

2nd to 4th pages

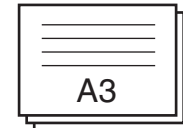

Scanned in at A3 (11" x 17") size

This feature can only be used with the following combinations of original sizes:

- A3 and B4
- A3 and B5
- B4 and A4
- A4 and B5
- A4R and B5
- B4 and A4R
- B4 and A5
- B5 and A5
- 11" x 17" and 8-1/2" x 14"
- 11" x 17" and 8-1/2" x 13"
- 11" x 17" and 5-1/2" x 8-1/2"

 When using USB memory mode, connect the USB memory device to the machine before performing the procedure below.

1

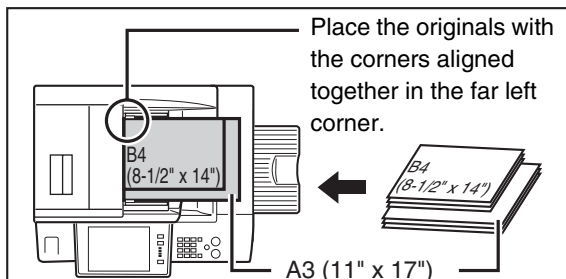

Insert the originals face up in the document feeder tray.

Insert the originals with the corners aligned together in the far left corner of the document feeder tray.

2

Select the special modes.

- (1) Touch the tab of the mode that you wish to use.
- (2) Touch the [Special Modes] key.

 [SPECIAL MODES](#) (page 70)

3

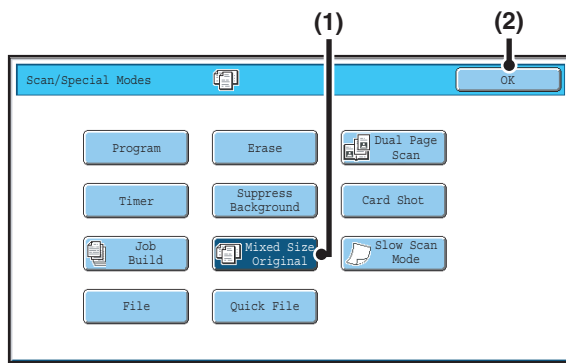

Select the mixed size original setting.

- (1) Touch the [Mixed Size Original] key so that it is highlighted.
- (2) Touch the [OK] key.



If an original scan size has been specified, a message will appear when the [Mixed Size Original] key is touched. To enable the Mixed Size Original setting, change the scan size setting to auto and then touch the [Mixed Size Original] key again.

4

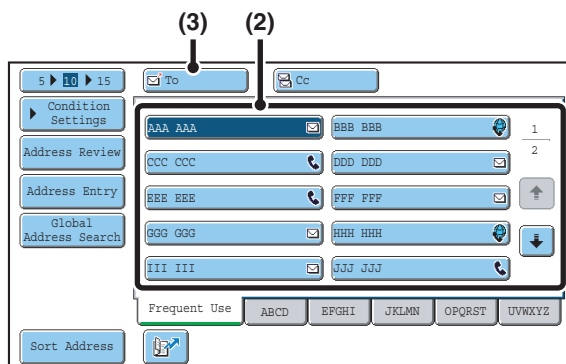

Specify the destination.

- (1) Touch the [Address Book] key in the base screen.
- (2) Touch one-touch keys of the destinations that you wish to store in the group.
- (3) Touch the [To] key.



- When scanning to USB memory, there is no need to specify the destination. Go to step 5.
- In addition to specification by a one-touch key, a destination can also be specified by a search number. You can also manually enter an e-mail address or look up an e-mail address in a global address book. For more information, see "2. ENTERING DESTINATIONS" (page 20).

5

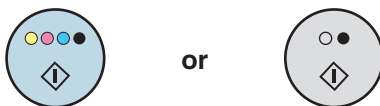

Press the [COLOUR START] key (●●●●) or the [BLACK & WHITE START] key (○●).

Scanning begins. A beep will sound to indicate that scanning is finished.



If the destination is an Internet fax destination, press the [BLACK & WHITE START] key (○●).



To cancel scanning...
Press the [STOP] key (⊞) to cancel the operation.



If an original scan size is specified after selecting the "Mixed Size Original" setting, the original scan size setting will be enabled and the "Mixed Size Original" setting will be cleared.



To cancel the Mixed Size Original setting...
Touch the [Mixed Size Original] key in the screen of step 3 so that it is not highlighted.



System Settings (Administrator): Original Feeding Mode
The original feeding mode can be set to always scan mixed size originals.

SCANNING THIN ORIGINALS (Slow Scan Mode)

Use this function when you wish to scan thin originals using the automatic document feeder. This function helps prevent thin originals from misfeeding.



 When using USB memory mode, connect the USB memory device to the machine before performing the procedure below.

1

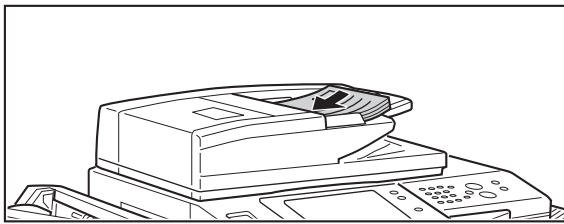

Insert the originals face up in the document feeder tray.

Adjust the original guides slowly.

 If the originals are inserted with too much force, they may crumple and misfeed.

2

Select the special modes.

(1) Touch the tab of the mode that you wish to use.

(2) Touch the [Special Modes] key.

 [SPECIAL MODES](#) (page 70)

3

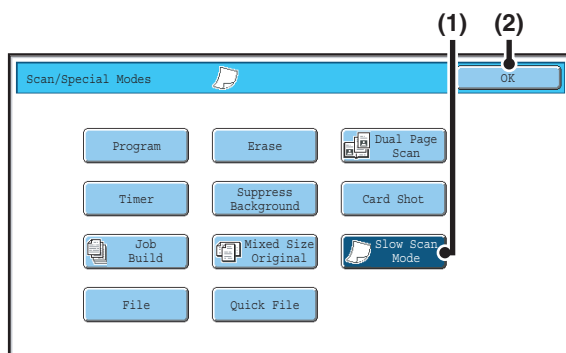

Select slow scan mode.

(1) Touch the [Slow Scan Mode] key so that it is highlighted.

(2) Touch the [OK] key.

4

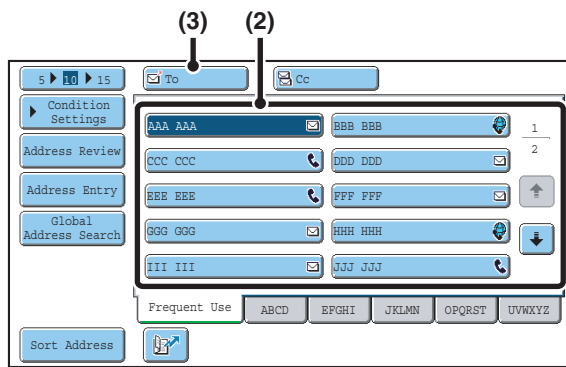

Specify the destination.

- (1) Touch the [Address Book] key in the base screen.
- (2) Touch one-touch keys of the destinations that you wish to store in the group.
- (3) Touch the [To] key.



- When scanning to USB memory, there is no need to specify the destination. Go to step 5.
- In addition to specification by a one-touch key, a destination can also be specified by a search number. You can also manually enter an e-mail address or look up an e-mail address in a global address book. For more information, see "2. ENTERING DESTINATIONS" (page 20).

5



or

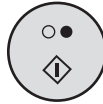

Press the [COLOUR START] key (●●●●) or the [BLACK & WHITE START] key (●●).

Scanning begins. A beep will sound to indicate that scanning is finished.



- If the destination is an Internet fax destination, press the [BLACK & WHITE START] key (●●).



To cancel scanning...

Press the [STOP] key (⊘) to cancel the operation.



When this function is selected, automatic 2-sided scanning is not possible.



To cancel slow scan mode...

Touch the [Slow Scan Mode] key in the screen of step 3 so that it is not highlighted.



System Settings (Administrator): Original Feeding Mode

This is used to have scanning always take place in slow scan mode.

SENDING TWO PAGES AS A SINGLE PAGE (2in1)

Two original pages can be reduced to half their original size and sent together as a single page.

Portrait-oriented originals

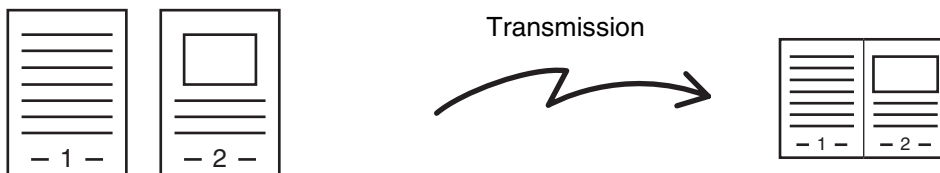

Landscape-oriented originals



This function cannot be used in scan mode, USB memory mode, or data entry mode.

1 Place the original.



When placing the originals, orient them as shown below.

| Originals | Document feeder tray Place the originals face up. | Document glass Place the originals face down. |
|---------------------------|--|--|
| Portrait orientation | | |
| Landscape orientation | | |

Select the special modes.

2

- (1) Touch the [Internet Fax] tab.
- (2) Touch the [Special Modes] key.

☞ [SPECIAL MODES](#) (page 70)

3

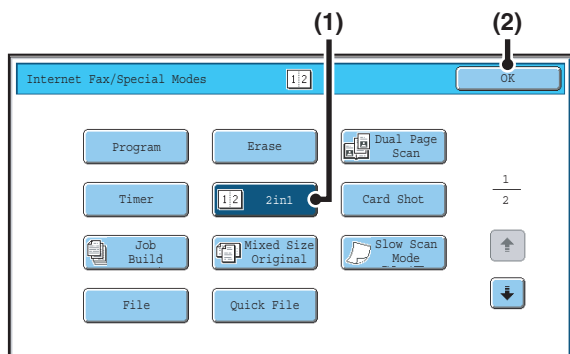

Select 2in1.

- (1) Touch the [2in1] key so that it is highlighted.
- (2) Touch the [OK] key.

4

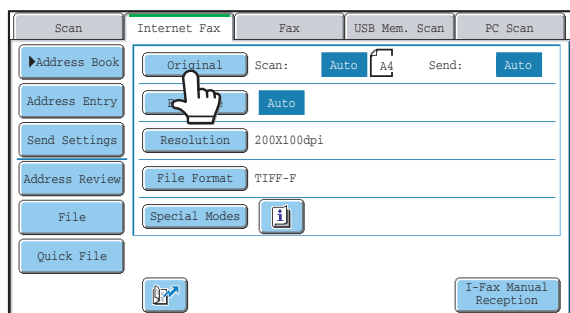

Touch the [Original] key.

5

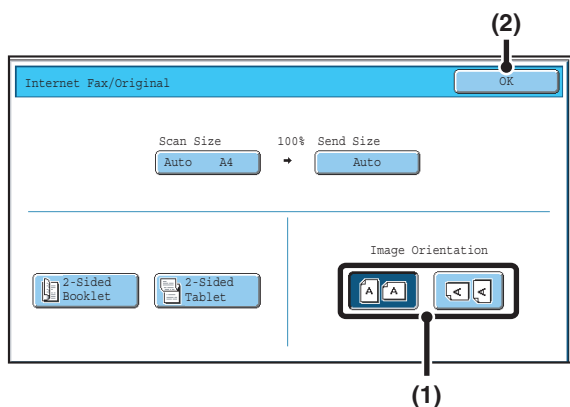

Specify the orientation in which the original is placed.

- (1) Touch the "Image Orientation" key with the same orientation as the original image.
If this setting is not correct, a suitable image may not be transmitted.
- (2) Touch the [OK] key.

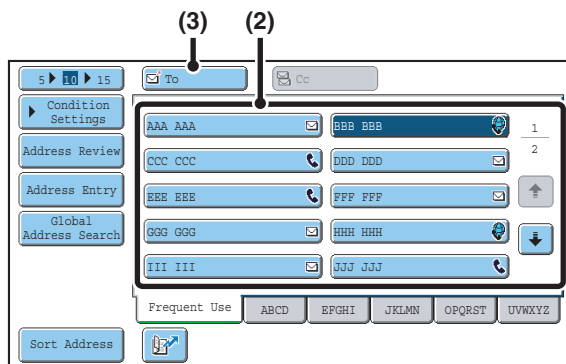

Specify the destination.

- (1) Touch the [Address Book] key in the base screen.
- (2) Touch one-touch keys of the destinations that you wish to store in the group.
- (3) Touch the [To] key.



In addition to specification by a one-touch key, a destination can also be specified by a search number. You can also manually enter an e-mail address or look up an e-mail address in a global address book. For more information, see "2. ENTERING DESTINATIONS" (page 20).

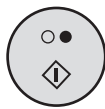

Press the [BLACK & WHITE START] key (○●).

Scanning begins.

- If you inserted the original pages in the document feeder tray, all pages are scanned. A beep will sound to indicate that scanning is finished.
- If you are scanning the original on the document glass, scan each page one page at a time. When scanning finishes, place the next original and press the [BLACK & WHITE START] key (○●). Repeat until all pages have been scanned and then touch the [Read-End] key. A beep will sound to indicate that scanning is finished.



The [Configure] key can be touched in the scan-end confirmation screen to change the exposure, resolution, scan size, and send size. (However, when scanning each even-numbered page of the original, only the exposure can be changed.)



To cancel scanning...

Press the [STOP] key (⊘) to cancel the operation.



- Transmission is not possible at a size smaller than the original size.
- The 2in1 function cannot be used when the original is other than A4, B5, or A5 (8-1/2" x 11" or 5-1/2" x 8-1/2") size.
- When the scan size of the original is specified by numerical values, this function cannot be used.



To cancel 2in1...

Touch the [2in1] key in the screen of step 3 so that it is not highlighted.

CHANGING THE PRINT SETTINGS FOR THE TRANSACTION REPORT (Transaction Report)

A transaction report is automatically printed out to alert you when an Internet fax transmission fails or when a broadcast transmission is performed. The transaction report contains a description of the transmission (date, start time, name of other party, time required, number of pages, result, etc.).

 [INFORMATION APPEARING IN THE RESULT COLUMN](#) (page 107)



This function cannot be used in scan mode, USB memory mode, or data entry mode.

Transaction reports are printed based on conditions set in the system settings; however, you can temporarily select different conditions for a transmission. To change the transaction report print conditions at the time of transmission, follow the steps below.

1

Place the original.

Place the original face up in the document feeder tray, or face down on the document glass.

2

Select the special modes.

(1) Touch the [Internet Fax] tab.

(2) Touch the [Special Modes] key.

(3) Touch the   keys to switch through the screens.

(4) Touch the [Transaction Report] key.

 [SPECIAL MODES](#) (page 70)

3

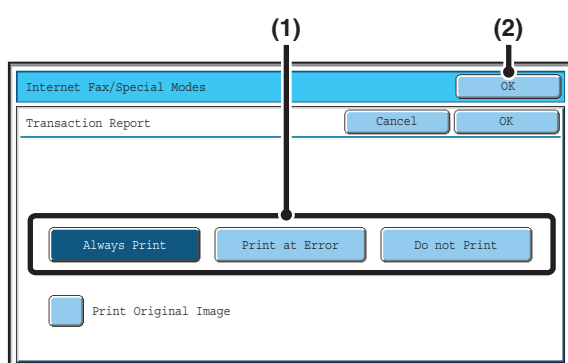

Select print conditions.

(1) Select the print conditions.

(2) Touch the [OK] key.



When the [Print Original Image] checkbox is selected , part of the transmitted original is included on the transaction report.

4

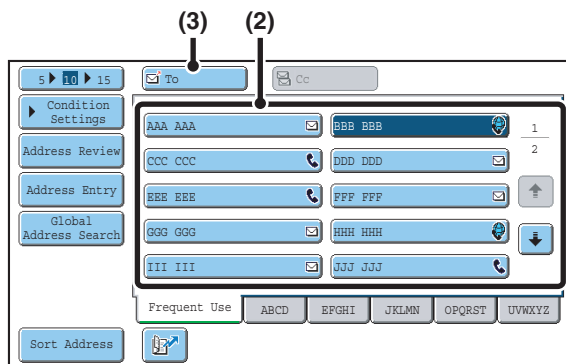

Specify the destination.

- (1) Touch the [Address Book] key in the base screen.
- (2) Touch one-touch keys of the destinations that you wish to store in the group.
- (3) Touch the [To] key.



In addition to specification by a one-touch key, a destination can also be specified by a search number. You can also manually enter an e-mail address or look up an e-mail address in a global address book. For more information, see "2. ENTERING DESTINATIONS" (page 20).

5



Press the [BLACK & WHITE START] key (○●).

Scanning begins.

- If you inserted the original pages in the document feeder tray, all pages are scanned. A beep will sound to indicate that scanning is finished.
- If you are scanning the original on the document glass, scan each page one page at a time. When scanning finishes, place the next original and press the [BLACK & WHITE START] key (○●). Repeat until all pages have been scanned and then touch the [Read-End] key. A beep will sound to indicate that scanning is finished.



To cancel scanning...

Press the [STOP] key (⊘) to cancel the operation.



For a broadcast transmission, changes to the transaction report print conditions apply to all destinations.



To cancel the transaction report setting...

Touch the [Cancel] key in the screen of step 3.



• System Settings (Administrator): Transaction Report Print Select Setting

This is used to set the conditions for printing transaction reports.

The factory default settings are print at below.

Single Sending: Print Out All Report//Print Out Error Report Only/No Printed Report

Broadcasting: /Print Out Error Report Only/No Printed Report

Receiving: Print Out All Report/Print Out Error Report Only/

• System Settings (Administrator): Original Print on Transaction Report

This is used to have part of the transmitted original printed on the transaction report.

5

CHECKING THE STATUS OF TRANSMISSION/RECEPTION JOBS

This chapter explains how to check the status of reserved transmission jobs and received Internet faxes.

JOB STATUS SCREEN

The job status screen is displayed when the [JOB STATUS] key on the operation panel is pressed. The job status screen shows the status of jobs by mode. When the [JOB STATUS] key is pressed, the job status screen of the mode that was being used before the key was pressed appears.

Reserved transmissions and received Internet faxes are referred to as jobs here.

Example: Pressing the tab in scan mode

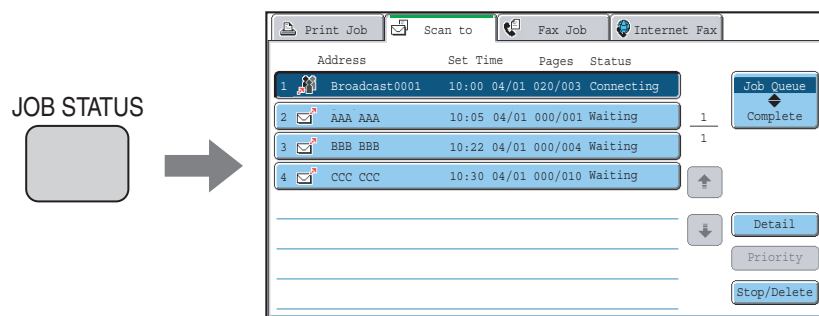

 The job status display is in the lower left corner of the touch panel. The job status display can be touched to display the job status screen.

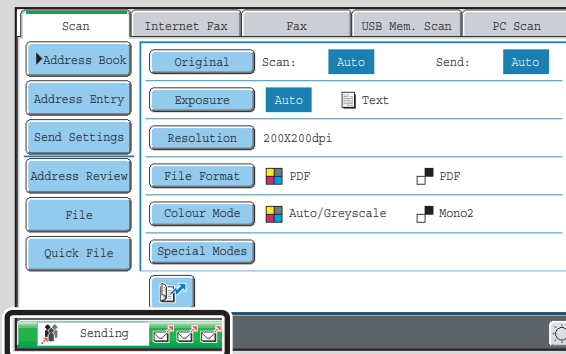

JOB QUEUE SCREEN AND COMPLETED JOB SCREEN

The job status screen consists of two screens: the job queue screen that shows reserved jobs and the job currently in progress, and the completed jobs screen. To switch between the two screens, touch the job status screen selector key ((2) below).

Job queue screen

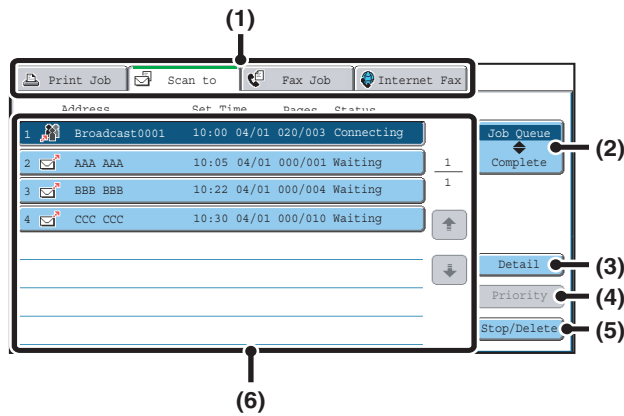

Complete screen

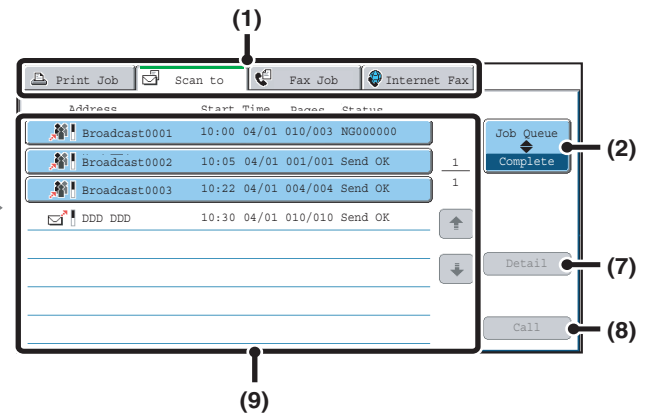

(1) Mode switch tabs

Use these tabs to change the job status screen mode.

(2) Job status screen selector key

Touch this key to switch between the job queue screen and the completed jobs screen.

(3) Job queue screen [Detail] key

This shows detailed information on broadcast transmission jobs and the status of jobs. Select the key of the desired job in the job queue screen (6) and then touch the [Details] key.

(4) [Priority] key

Touch this key to give priority to a selected job.
[GIVING PRIORITY TO A SCAN TRANSMISSION JOB](#) (page 106)

(5) [Stop/Delete] key

Touch this key to stop or delete a selected job.
[STOPPING A SCAN JOB BEING TRANSMITTED OR WAITING TO BE TRANSMITTED](#) (page 105)

(6) Job queue screen

Jobs are shown as keys in the order they were reserved. Each key shows information on the job and its current status.
[Job key display](#) (page 101)

(7) Completed jobs screen [Detail] key

This shows detailed information on the results of completed broadcast transmissions and jobs that used the document filing function. Select the key of the desired job in the completed jobs screen (9) and then touch the [Detail] key.
[CHECKING COMPLETED JOBS](#) (page 104)

(8) [Call] key

Touch this key to call up and use a transmission or reception job stored with the document filing function.

(9) Completed jobs screen

This shows up to 99 completed transmission or reception jobs in each mode. A description of the job and the result (status) are shown. Jobs that used document filing function, broadcast transmission jobs, and received Internet fax forwarding jobs are indicated as keys.

Job key display

The following information is shown in the job queue keys and completed job keys that appear in the job status screen.

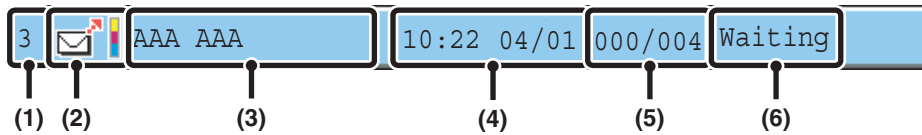

(1) Displays the number (position) of the job in the job queue.

When the job currently being transmitted is finished, the job moves up one position in the job queue. This number does not appear in keys in the completed jobs screen.

(2) Mode icon

This indicates the type of job. In the completed jobs screen, a colour bar appears next to the icon to indicate whether the job was executed in colour or black & white. (However, the colour bar icon does not appear in the key of a job stored using the document filing function.)

| Icon | Job type |
|------|---------------------------|
| | Scan to E-mail |
| | Scan to FTP |
| | Scan to Network Folder |
| | Scan to Desktop |
| | Internet fax transmission |
| | Internet fax reception |
| | PC-I-Fax transmission |
| | Broadcast transmission |

(3) Name of communicating party (address)

For a transmission, the name or address of the destination. For a reception, the address of the sending party. For a broadcast transmission, the function name and a broadcast control number (4-digits).

(4) Time reserved/Time started

In the job queue screen, the date and time the job was reserved. In the completed jobs screen, the date and time the job was started.

(5) Number of pages

Shows the number of pages transmitted/total number of original pages.

(6) Status

Shows the job status.

- Job in progress

| Display | Status |
|--------------|---|
| "Connecting" | Connecting to the destination. |
| "Sending" | Sending data. |
| "Receiving" | Receiving an Internet fax. |
| "Stopped" | The job has been stopped. |
| "Error" | An error occurred while the job was being executed. |

- Job waiting to be executed

| Display | Status |
|-----------------------------|--|
| "Waiting" | The job is waiting to be executed. |
| "Retry Mode" | The job is being re-attempted due to a communication error or other problem. |
| "Report Wait" | An Internet fax has been sent for which a receive report was requested, and the machine is waiting for the receive report. |
| A day and time is displayed | Timer transmission job (the specified time is displayed) |

- Completed job

| Display | Status |
|---|--|
| "Send OK" | Transmission was completed. |
| "In Memory" | An Internet fax has been received but has not yet been printed. |
| "Printed" | A received Internet fax has been printed. |
| "Forward OK" | A received Internet fax has been forwarded. |
| "Holding" | Received Internet fax held by print hold. |
| "Stopped" | The job was stopped. |
| "Number of successful transmission destinations/ Total destinations OK" | A broadcast transmission has been completed. If transmission to 3 destinations was successful out of a total of 5, "003/005 OK" will appear. |
| "No Response" | An error occurred because there was no response from the destination. |
| "OK Report" | A receive report was requested for a transmission, the transmission was completed normally, and the receive report was received from the destination. |
| "NG Report" | A receive report was requested for a transmission, however, the transmission did not take place correctly and a transmission failed report was received. |
| "No Report" | An e-mail was received without an attached file and thus printing was not possible. |
| "Received" | An e-mail was received, however, the attached file was not a TIFF-F file or there was no attached file, and thus printing was not possible. |
| "Rejected" | An Internet fax was sent from a party that is blocked. |
| "NGxxxxx" | Transmission/reception was not successful because a communication error occurred (a 6-digit error code appears in xxxxxx.) |
| "Error" | An error occurred while the job was being executed. |

OPERATION WHEN A JOB IN THE JOB QUEUE IS COMPLETED

When a normal transmission job is completed, it moves to the completed jobs screen and "Send OK" appears in the status column.

Received Internet faxes, timer transmission jobs, and forwarding jobs are handled in the job status screen as explained below.

Internet fax reception jobs

While an Internet fax is being received, "Receiving" appears.

When reception is completed, the job moves to the completed jobs screen and "In Memory" appears.

When printing ends, the status changes to "Printed" and the job is completed.

Timer transmission jobs

A timer transmission job appears at the bottom of the job queue until the specified time arrives.

When the specified time arrives, the job is executed. If another job is in progress, the timer job is started when the other job is completed.

Internet fax transmission jobs that request a receive report

After completion of an Internet fax transmission job that requests a receive report, the job is placed on standby at the bottom of the job queue screen. "Report Wait" appears in the status column. When the receive report is received from the destination, or if the report is not received within the timeout time, the job moves to the completed jobs screen.

Reception jobs when "Inbound Routing Settings" are enabled

When "Inbound Routing Settings" are enabled, reception jobs are handled as follows depending on the print setting.

 [FORWARDING RECEIVED INTERNET FAXES TO AN E-MAIL ADDRESS \(Inbound Routing Settings\)](#) (page 111)

- **Received Internet fax is not printed**

"Receiving" appears while the Internet fax is being received. When reception is completed, the job moves to the job queue of the job status screen of scan mode.

- **Received Internet fax is printed**

When reception is completed, the job moves to the completed jobs screen and "In Memory" appears. When printing ends, the status changes to "Printed" and the job is completed. In addition, the job is added to the job queue of the job status screen of scan mode. When forwarding received Internet faxes is finished, "Forward OK" appears.

CHECKING COMPLETED JOBS

You can check a list of the destinations, the destinations for which transmission failed, and other detailed information on completed jobs that used document filing function, broadcast transmission jobs, and received Internet fax forwarding jobs. Touch the key of the job for which you wish to display information in the completed jobs screen and touch the [Detail] key. The job detail screen (see below) will appear.

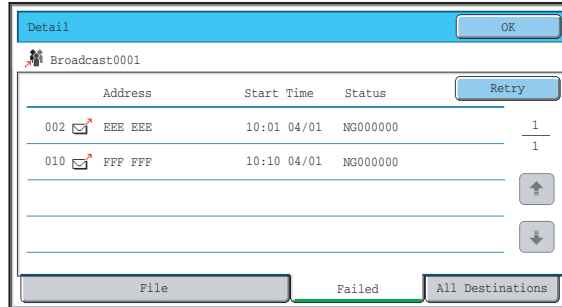

The job name appears at the top of the job detail screen.

To view details on the job, touch one of the tabs. The following information appears on each tab.

| Tab name | Information displayed |
|------------------|---|
| File | Shows information on a transmission/reception that used document filing function. To call up the file and use it, touch the [Call] key. |
| Failed | Shows information on addresses for which communication failed. Address: Address name or number Start time: Time at which communication began. Status: Description of failure (error) The [Retry] key can be touched to re-attempt transmission to that address. |
| All Destinations | Shows all addresses specified in the job. Address: Address name or number Start time: Time at which communication began. Status: Communication result The [Retry] key can be touched to transmit to all addresses again. |

STOPPING A SCAN JOB BEING TRANSMITTED OR WAITING TO BE TRANSMITTED

Follow the steps below to stop a job that is being transmitted or is waiting to be transmitted.

1

JOB STATUS



Press the [JOB STATUS] key.

2

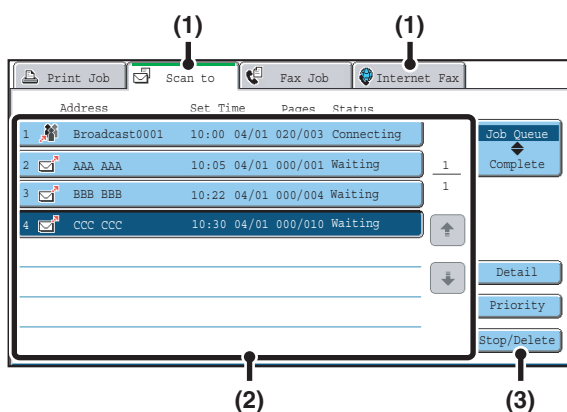

Select the job that you wish to stop.

- (1) Touch the mode tab of the job to be stopped.
- (2) Touch the key of the job to be stopped.
- (3) Touch the [Stop/Delete] key.

3

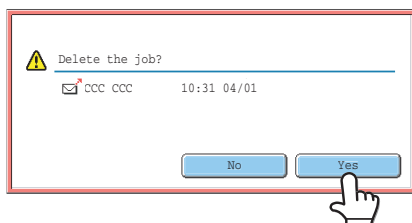

Touch the [Yes] key.



If you do not want to stop the selected job...

Touch the [No] key.



Printing of a received Internet fax cannot be stopped.

GIVING PRIORITY TO A SCAN TRANSMISSION JOB

When multiple jobs are waiting to be transmitted, the jobs are normally transmitted in the order they were reserved. If you need to give priority to a job and send it ahead of the other jobs, follow the steps below.

1

JOB STATUS



Press the [JOB STATUS] key.

2

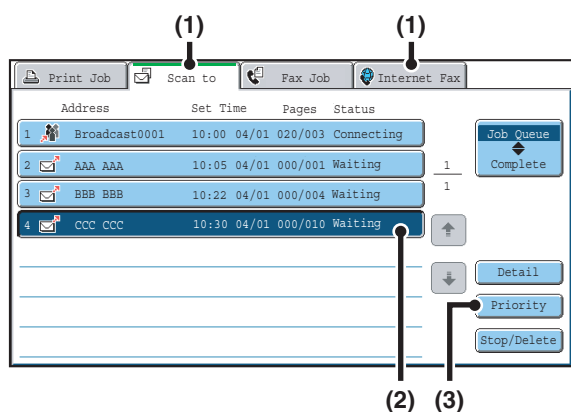

Select the job to which you wish to give priority.

- (1) Touch the mode tab of the job to be given priority.
- (2) Touch the key of the job to be given priority.
- (3) Touch the [Priority] key.

The selected job moves up to the position immediately following the job in progress. The job will be executed when the job in progress is completed.

CHECKING THE INTERNET FAX ACTIVITY LOG (Image Sending Activity Report)

You can have the machine print a log of recent image sending activity (date, name of other party, time required, result, etc.). The Image Sending Activity Report contains useful information such as the types of errors that occurred.

The most recent 199 transactions are included in the report.

You can have the machine print the Image Sending Activity Report each time the number of transactions reaches 200, or at a specified time (once a day only).

 The contents of the Image Sending Activity Report are erased when the report is printed, and thus it cannot be reprinted.

 **System Settings (Administrator): Activity Report Print Select Setting**
This is used to set the conditions for printing activity reports. The factory default setting is not to print. The Image Sending Activity Report can be set to print each time the number of transactions reaches 200, or at a specified time (once a day only).

INFORMATION APPEARING IN THE RESULT COLUMN

Error types and other information are printed in the result column of transaction and activity reports. When a transaction report or activity report is printed, check the result of the transaction in the result column and take action as needed.

Examples of messages that are printed in the result column

| Message | Explanation |
|----------------|--|
| OK | The transaction was completed normally. |
| OK REPORT | A receive report was requested for a transmission, the transmission was completed normally, and the receive report was received from the destination. |
| CANCEL | A transmission was stopped while in progress, or a reserved transmission job was cancelled. |
| MEM. FULL | The memory became full during reception. |
| REJECTED | An Internet fax was sent from a party that is blocked. |
| NG REPORT | A receive report was requested for a transmission, however, the transmission did not take place correctly and a transmission failed report was received. |
| NO REPORT | A receive report was requested for a transmission, however, a report was not received within the timeout time. |
| NG LIMIT | Transmission was not possible because the file size exceeded the machine's file size limit setting. |
| RECEIVED | An e-mail was received, however, the attached file was not a TIFF-F file or there was no attached file, and thus printing was not possible. |
| FAIL xx (xxxx) | The transaction failed due to a communication error. First 2 digits of communication error number: Error code from 00 to 99. Last 4 digits of communication error number: Code for use by service technicians. |

6

INTERNET FAX RECEPTION FUNCTIONS

This chapter explains the basic procedures for receiving Internet faxes.

RECEIVING AN INTERNET FAX

The Internet fax function periodically* connects to the mail server (POP3 server) and checks whether or not Internet faxes have been received. When faxes have been received, the faxes are automatically retrieved and printed.

* The default setting is once every 5 minutes.



If faxes will be received at night, keep the main power switch in the "on" position.

1

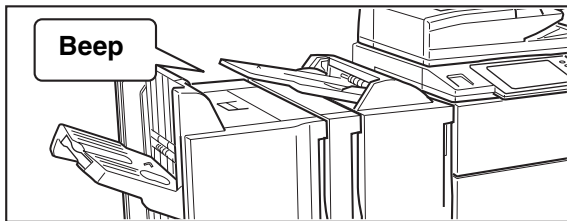

Internet faxes are received automatically.

A beep sounds when reception ends.

2

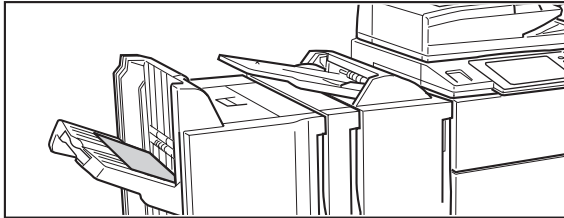

The faxes are printed automatically.



If the machine is out of paper or there is no paper that matches the size of the received fax, a message will appear in the touch panel. Follow the instructions in the message to load an appropriate size of paper.



• **System Settings: Fax Data Receive/Forward**

When printing is not possible because the machine has run out of paper or toner, received Internet faxes can be forwarded to and printed by another previously stored Internet fax machine.

• **System Settings (Administrator): I-Fax Default Settings**

These settings are used to select how received faxes are handled when the [POWER] key () is "off" (the main power switch is "on"), the volume of the beep that sounds when reception ends, and whether or not received e-mail messages are printed.

• **System Settings (Administrator): I-Fax Receive Settings**

Settings related to Internet fax reception can be configured such as the interval for checking for received faxes, duplex reception, output settings, auto reduction printing, and storing reject reception addresses.

MANUALLY RECEIVING INTERNET FAXES

If the interval for checking for received faxes is somewhat long and you wish to check immediately, you can manually initiate reception.

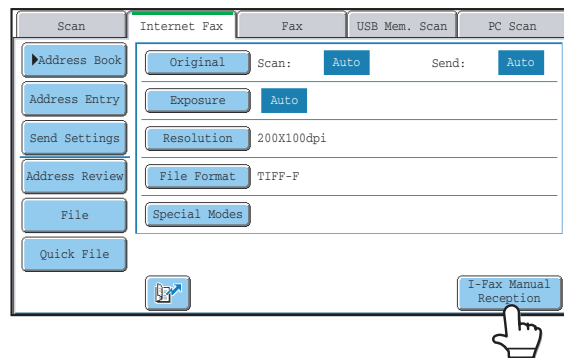

Touch the [I-Fax Manual Reception] key to connect to the mail server and retrieve received faxes.



 If POP3 server settings are not configured in the Web pages, the [I-Fax Manual Reception] key is greyed out to prevent selection.

 **System Settings: Fax Data Receive/Forward**
This setting is used to hide the [I-Fax Manual Reception] key that appears in the base screen of Internet Fax mode. When the [I-Fax Manual Reception] key is hidden, manual reception is initiated by touching the [Reception Start] key in the screen that appears when "Fax Data Receive/Forward" - "I-Fax Settings" is selected.

PRINTING A PASSWORD-PROTECTED FAX (Hold Setting For Received Data Print)

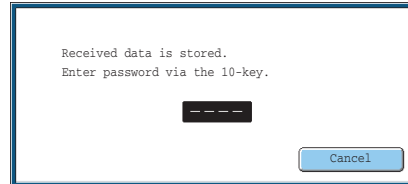
"Hold Setting for Received Data Print" in the system settings (administrator) can be enabled to have faxes received to memory without being printed. To print the faxes, a password must be entered. When this function is enabled, a password entry screen appears in the touch panel when received Internet faxes are retrieved.



When the previously programmed 4-digit password is entered with the numeric keys, printing begins. The [Cancel] key can be touched to close the password entry screen; however, the data in memory key () will blink in the touch panel. The password entry screen will reappear when you touch the blinking key () or change modes.



- The received faxes will be retained in memory regardless of whether they were received automatically or manually. If a transaction report is set to print when a fax is received, the transaction report will also be retained in memory.
- If "Fax Data Receive/Forward" is enabled in the system settings so that received faxes are forwarded to another machine, faxes retained in memory are also forwarded. At that time, the same password entry screen will appear as for printing. Forwarding will not take place unless the password is entered.



System Settings (Administrator): Hold Setting for Received Data Print

Enable this setting to have faxes received to memory without being printed. This setting is also used to program the password that must be entered to print the faxes.

FORWARDING RECEIVED INTERNET FAXES TO AN E-MAIL ADDRESS (Inbound Routing Settings)

Received Internet faxes can be automatically forwarded to a specified E-mail address. This function can be used to forward received Internet faxes directly to an e-mail address without printing the faxes.

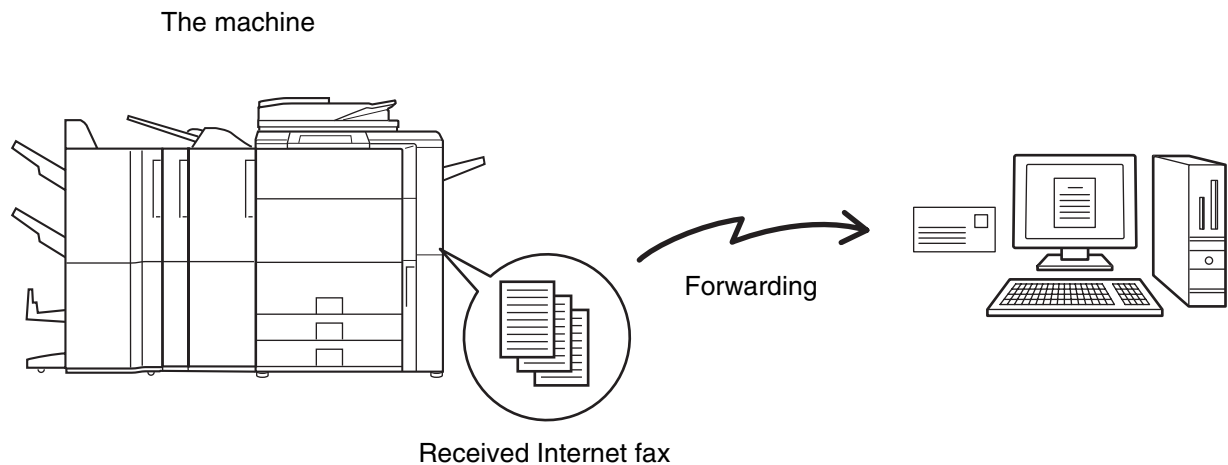

To configure inbound routing settings, click [Application Settings] and then [Inbound Routing Settings] in the Web page menu. (Administrator rights are required.)



The format of the forwarded file is TIFF-F.

7

SCANNING FROM A COMPUTER (PC Scan Mode)

BASIC SCANNING PROCEDURE

You can install the scanner driver on your computer from the CD-ROM that accompanies the machine, and use a TWAIN* compliant application to scan an image using your computer.

Scanning from your computer is most useful for scanning a single original such as a photo, particularly when you want to adjust scan settings as you scan. By contrast, scanning at the machine is most useful for continuous scanning of multiple originals.

* An interface standard used for scanners and other image input devices. When the scanner driver is installed on your computer, you can use any TWAIN-compliant application to scan an image.



- Scanning in PC scan mode is only possible when the scanner driver has been installed from the "Software CD-ROM" using the integrated installer. For the procedures for installing the scanner driver and configuring settings, see the Software Setup Guide.
- This function cannot be used when it has been disabled using "Disable Scan Function" in the system settings (administrator).
- The procedures for selecting the scanner driver and starting scanning vary depending on the TWAIN-compliant application. For more information, see the manual for the application or Help.
- When a large image is scanned at high resolution, the amount of data will be very large and scanning will take a long time. Be sure to select appropriate scan settings for the original (text, photo, etc.).

As an example, the procedure for scanning from the "Sharpdesk" application that accompanies the machine is explained below.

[At the machine]

1

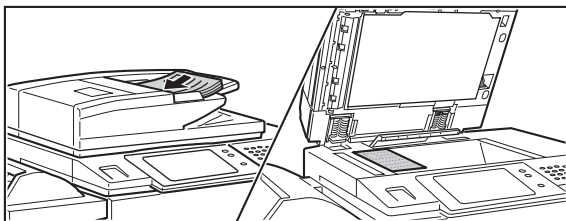

Place the original.

Place the original face up in the document feeder tray, or face down on the document glass.

2

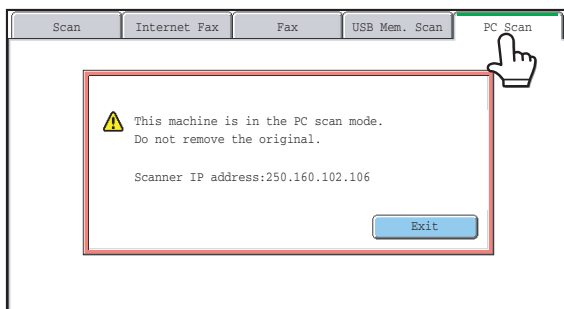

Touch the [PC Scan] tab to switch to PC Scan mode.

If the [PC Scan] tab does not appear, touch the  tab to move the screen.



When PC scan mode is selected, only the [Exit] key displayed in the touch panel can be used on the machine; no other keys can be used.

[At your computer]

3

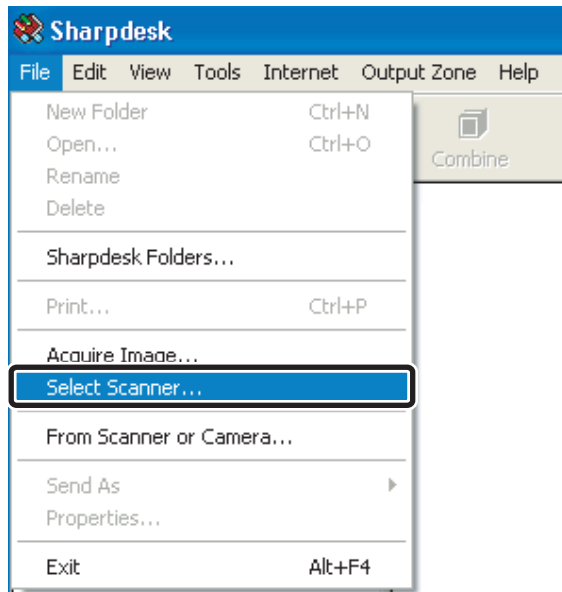

Start the TWAIN-compliant application on your computer and select [Select Scanner] from the [File] menu.

4

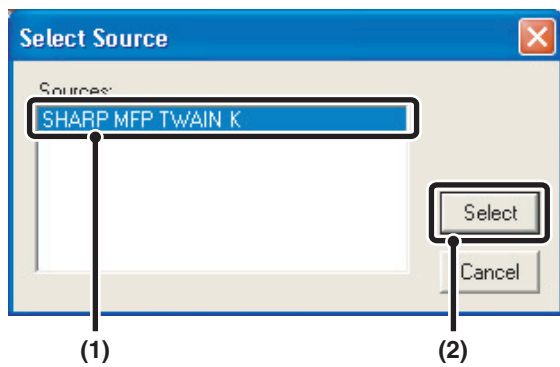

Select the scanner driver of the machine.

- (1) Select [SHARP MFP TWAIN K].
- (2) Click the [Select] button.

5

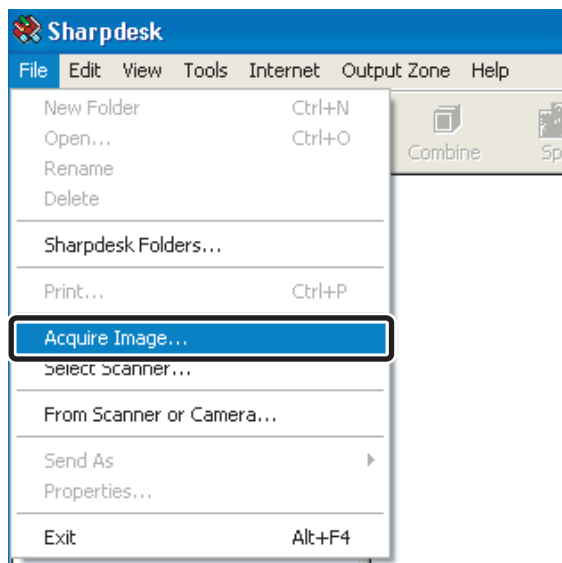

Select [Acquire Image] from the [File] menu.

The scanner driver opens.

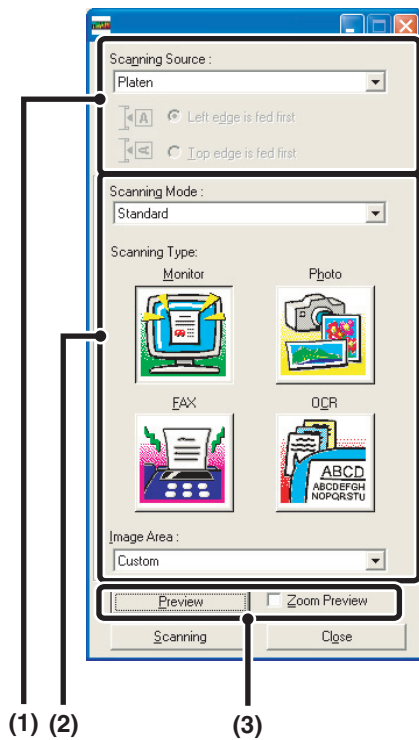

Preview the image.

(1) Select the location where the original is placed.

"Scanning Source" menu:

- If the original is a one-sided original and is placed in the document feeder tray, select [SPF(Simplex)].
- If the original is a 2-sided original and is placed in the document feeder tray, select [SPF(Duplex - Book)] or [SPF(Duplex - Tablet)] depending on whether the original is a book-style or tablet-style original. In addition, select [Left edge is fed first] or [Top edge is fed first] depending on the orientation of the original.

(2) Select scan settings.

"Scanning Mode" menu:

Switch between the "Standard" screen and the "Professional". In the "Standard" screen, select "Monitor", "Photo", "FAX" or "OCR" depending on the original type and your scanning purpose.

If you wish to change the initial settings of any of the four buttons or select the resolution or other advanced settings, change to the "Professional" screen.

"Image Area" menu:

Select the scan area. If "Auto" is selected, the original size detected by the machine will be scanned. You can also set the scanning area in the preview window with your mouse.

(3) Click the [Preview] button.

The preview image will appear in the scanner driver.

If you are not satisfied with the preview image, repeat (2) and (3).

If the [Zoom Preview] checkbox is selected before the [Preview] button is clicked, the selected area will be enlarged in the preview window. If the checkmark is removed, the preview image will return to normal. Note that if SPF is selected in the "Scanning Source" menu, the [Zoom Preview] function cannot be used.



- For further information on the scan settings, click the  button in the preview image screen of step 7 to open scanner driver Help.
- If the [Preview] button is clicked when scanning from the document feeder tray, only one original page will be scanned for the preview image. If you wish to include that original in the scan, return it to the document feeder tray.

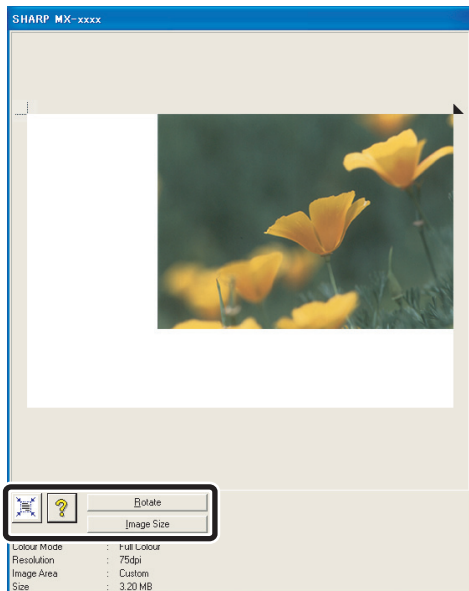

Select scanning settings while viewing the image.

[Rotate] button:

Each time this button is clicked, the preview image rotates 90 degrees. This lets you change the orientation of the image without picking up and placing the original again. The image file will be created using the orientation that appears in the preview window.

[Image Size] button:

Click this button to specify the scan area by entering numerical values. Pixels, mm, or inches can be selected for the units of the numerical values. If a scanning area has already been specified, the entered numbers will change the area relative to the top left corner of the specified area.

button:

When a preview image is displayed and a scanning area is not specified, you can click the  button to automatically set the scanning area to the entire preview image.



- For further information on the scan settings, click the  button to open scanner driver Help.
- If the originals are placed in the document feeder tray, only the top page will be previewed. The top page will be delivered to the original exit tray. Be sure to return the previewed page to the document feeder tray before previewing again or scanning.

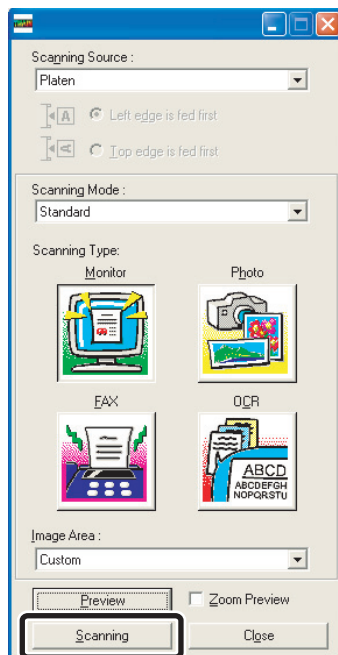

Click the [Scanning] button.

Scanning begins. The image appears in your application. Assign a file name to the scanned image and save it as appropriate in the software application you are using.

[At the machine]

9

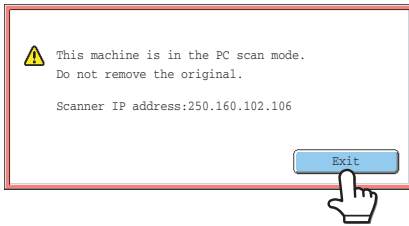

Touch the [Exit] key in the touch panel.

10

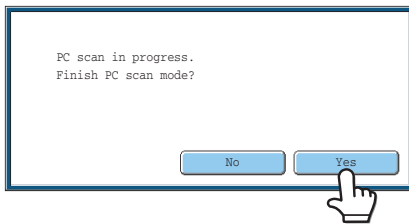

Touch the [Yes] key.

8

METADATA DELIVERY

This chapter explains metadata delivery, which can be used when the application integration module kit is installed.

METADATA DELIVERY (Data Entry)

When the application integration module kit is installed and an image file is generated for a scan send transmission, metadata (data indicating the attributes of the image file and how it is to be processed) can be generated based on pre-stored information and transmitted as a separate file. The metadata file is created in XML format. By linking the metadata with applications such as document management software, a workflow application, or an encryption server, a sophisticated document solution environment can be built.

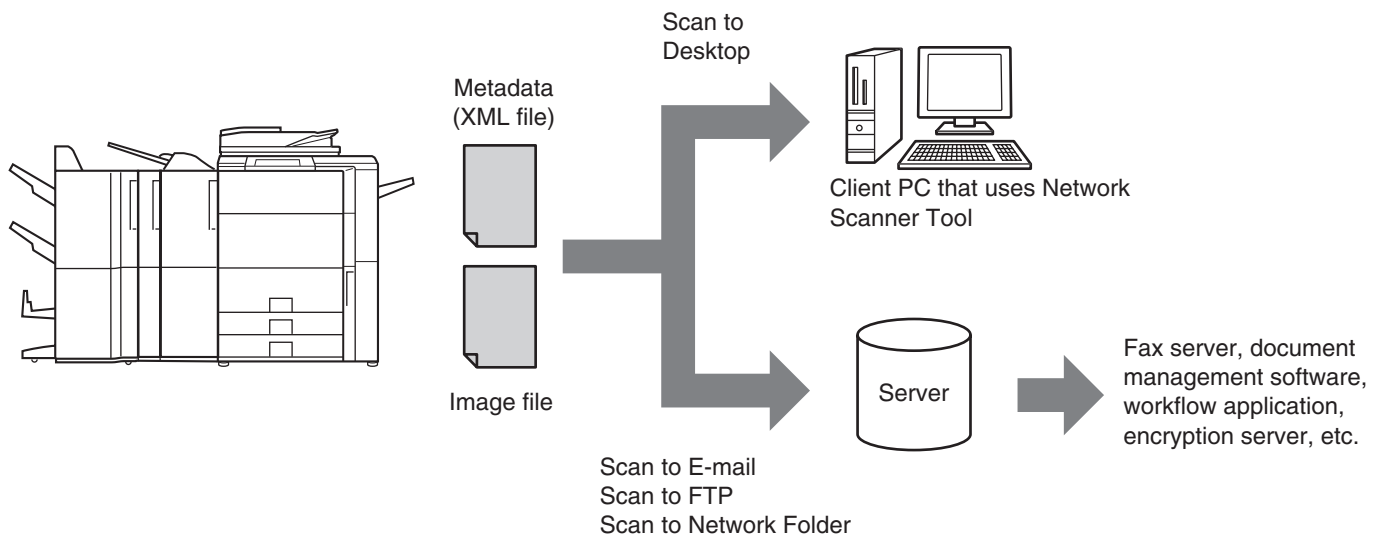

Using the application integration module kit, information on a generated image file can be entered at the touch panel and transmitted along with the image as an XML file.

PREPARATIONS FOR METADATA TRANSMISSION

SETTINGS REQUIRED IN THE WEB PAGES

All settings related to metadata are configured in the Web pages. (Administrator rights are required.) To configure metadata settings, click [Application Settings] and then [Metadata Settings] in the Web page menu. When configuring settings, be sure to enable metadata transmission.

Storing Metadata Sets

Store the items (the metadata set) that are written to the XML file that is generated during scanning. Up to 10 metadata items can be configured in a metadata set. A stored metadata set can be selected at the time of transmission.

 Addresses specified in "Address Type Allowing Metadata Entry" when a metadata set is stored can be selected as transmission destinations at the time of transmission using one-touch keys, manual entry, and/or a global address book search. (Addresses for which metadata entry is not allowed cannot be specified as transmission destinations.)

METADATA TRANSMISSION FOR SCAN TO DESKTOP

When Network Scanner Tool is used in its factory default configuration, a file will be generated with a new file name on the computer. When Network Scanner Tool is used as a means of sending a metadata file to a third party software application, this setting must be disabled to allow cross referencing between the image file and XML file by means of the file name generated by the computer. (When setting the file name in [Send Settings], to ensure that a previously existing file on a computer is not overwritten by a transmitted file of the same name, be sure to configure the file name so that name duplication cannot occur; for example, by including a unique extension (the date, etc.) in the generated file name. If the file name setting is left blank, the machine will automatically generate a file name that is unique.)

-  • It is recommended that you use Network Scanner Tool to receive metadata. For more information, see the Network Scanner Tool User's Guide (PDF format) on the "Sharpdesk/Network Scanner Utilities" CD-ROM.
- For information on the license agreement and how to use the CD-ROM that accompanies the application integration module, see the separate "Sharpdesk licence kit" manual.
- **Using third party software applications**
Various types of third party software applications exist. Some applications can start automatically from Network Scanner Tool and some cannot. When the auto-run function of an application is enabled, Network Scanner Tool will start the application with the ".exe" command using the file name as a parameter. Normally an application is started twice, once for the image file and once for the XML file. For example, when Network Scanner Tool is set to start the application "APP.EXE", the following commands are applied when the two files "IMG.TIF" and "IMG.XML" are received.
- ```
APP.EXE IMG.TIF
APP.EXE IMG.XML
```

# TRANSMITTING METADATA

Follow the steps below to select a metadata set, enter each item, and perform metadata transmission.

1

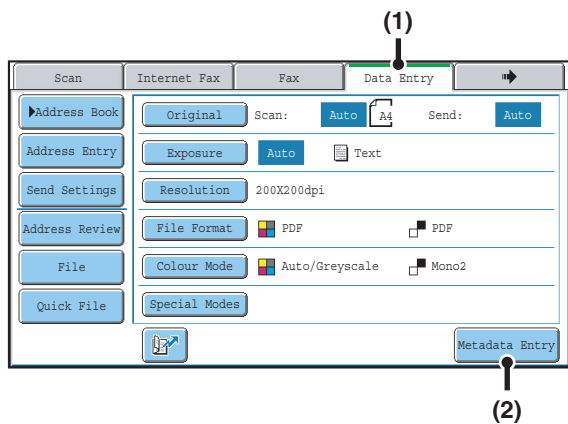

**Switch to data entry mode and display the metadata set screen.**

- (1) Touch the [Data Entry] tab.
- (2) Touch the [Metadata Entry] key.



- If no metadata sets have been stored, the [Data Entry] tab cannot be selected. Store a metadata set in the Web pages and then perform the transmission procedure.
- If a specific metadata set has been specified as the default set, go to step 3.

2

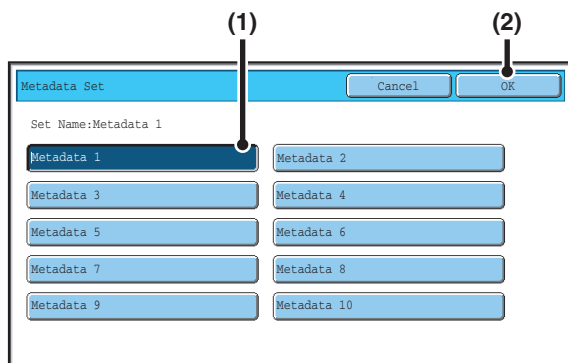

**Select a metadata set.**

- (1) Touch the key of the metadata set that you wish to use.
- (2) Touch the [OK] key.

3



**The keys of the items stored in the metadata set will appear. Touch the key of the item that you want to enter.**



- If you accidentally selected the wrong metadata set or wish to use a different metadata set when a default metadata set has been set, touch the [Metadata Set] key. Touch the [OK] key in the message screen that appears. You will return to the screen of step 2. Metadata items entered to that point will be cancelled.

4

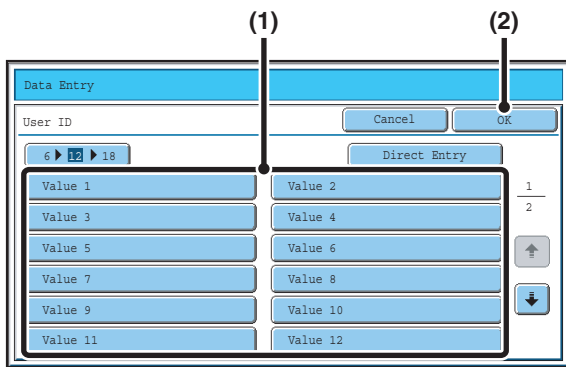

## Enter the selected metadata item.

(1) Touch the key of the value that you wish to enter.

- When the entry values of the metadata item are in the form of selections, the selections are shown as keys. When a value is editable, you can touch the [Direct Entry] key to manually enter the value.
- If the metadata item requires the entry of text, a text entry screen will appear. Enter the required information.

(2) Touch the [OK] key.



- To change the number of keys displayed in the screen, touch the number of displayed items selector key. Select 6, 12, or 18 keys.
- For the procedure for entering text, see "6. ENTERING TEXT" in the User's Guide.

5

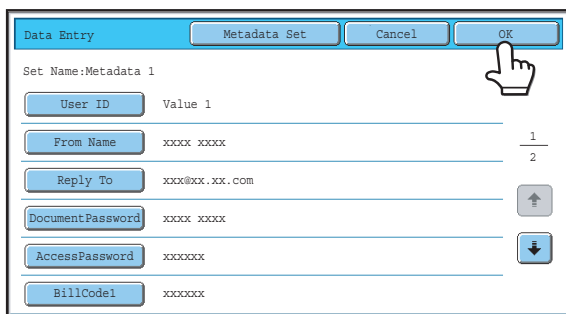

## When you have finished entering all items, touch the [OK] key.

6

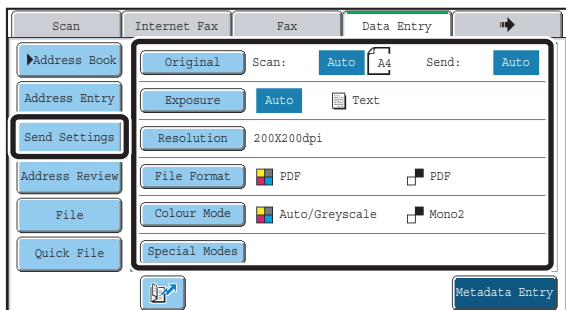

## Select image settings and any other settings, and perform the scan send procedure.

- The procedures for selecting settings and performing transmission are the same as in the other modes.
- To make changes to entered values, touch the [Metadata Entry] key once again. The entry screen of the selected metadata set will appear.



- Transmission cannot be performed if the [Data Entry] tab is displayed and no metadata settings have been configured. To perform transmission without sending metadata, switch to a different mode by touching the tab of that mode and then perform transmission.
- Before configuring metadata settings, you can specify addresses in all modes to be used. After metadata settings have been configured, only addresses in modes that are allowed in the selected metadata set can be specified.
- When metadata settings have been configured or an address is specified in the [Data Entry] tab, it will not be possible to switch to another mode.
- Metadata delivery is possible using the document filing function. The [Data Entry] tab appears in the transmission settings screen of document filing mode to allow metadata delivery. In addition, metadata delivery using document filing can be performed in [Document Operations] in the Web pages.



# METADATA FIELDS

The following three types of metadata are included in the XML file that is transmitted.

- Data automatically generated by the machine: These data are always included in the XML file and are automatically stored on your computer.
- Previously defined fields: These fields are automatically recognized by the machine and assigned to appropriate XML tags. These fields are selectable, and can only be included in the XML file if enabled in the Web pages.
- User defined fields: Custom fields can be added to the XML file. These fields are selectable and can be defined in the Web pages.

If a defined metadata field is one of the following fields, a message will appear informing you that the field cannot be entered. Enter appropriate information in the related items of the send settings.

| Name entered in metadata field | Description                                                                                                                                                                                                     | Where entered                                                                                                                                                                                                                   |
|--------------------------------|-----------------------------------------------------------------------------------------------------------------------------------------------------------------------------------------------------------------|---------------------------------------------------------------------------------------------------------------------------------------------------------------------------------------------------------------------------------|
| fromName                       | Name of the user who sent the job. If the name is not entered as metadata, the sender name determined by the usual rules for determining the sender name will be applied as metadata.                           | [Reply-To]<br>(Sender name of selected sender)                                                                                                                                                                                  |
| replyTo                        | E-mail address to which the transmission result will be sent.                                                                                                                                                   | [Reply-To]<br>(E-mail address of selected sender)                                                                                                                                                                               |
| documentSubject                | Job name appearing in the e-mail "Subject" line, or job name on the fax cover sheet. When the user enters a [Subject] in the send settings screen in the touch panel, the entered value is applied as metadata. | [Subject]<br>(Blank until a value is set in the send settings screen.)                                                                                                                                                          |
| fileName                       | Enter the file name of the image to be sent.                                                                                                                                                                    | [File Name]<br>(Only when the [Allow Custom Filenames] checkbox is selected <input checked="" type="checkbox"/> in the metadata settings screen in the Web pages.)<br>(Blank until a value is set in the send settings screen.) |

# Scanner Guide

MODEL: MX-5500N  
MX-6200N  
MX-7000N



# SHARP®

MX7000-GB-SCN-Z1

## Free Manuals Download Website

<http://myh66.com>

<http://usermanuals.us>

<http://www.somanuals.com>

<http://www.4manuals.cc>

<http://www.manual-lib.com>

<http://www.404manual.com>

<http://www.luxmanual.com>

<http://aubethermostatmanual.com>

Golf course search by state

<http://golfingnear.com>

Email search by domain

<http://emailbydomain.com>

Auto manuals search

<http://auto.somanuals.com>

TV manuals search

<http://tv.somanuals.com>