



SHARP®

OPERATION MANUAL MODEL PG-A20X

Introduction

Connections and Setup

Basic Operation

Easy to Use Functions

Appendix



LCD PROJECTOR



香港電器安全規格
(國際電工委員會規格適合)



IMPORTANT

For your assistance in reporting the loss or theft of your Projector, please record the Serial Number located on the bottom of the projector and retain this information. Before recycling the packaging, please be sure that you have checked the contents of the carton thoroughly against the list of "Supplied accessories" on page 14.

Model No.: PG-A20X

Serial No.:

This equipment complies with the requirements of Directives 89/336/EEC and 73/23/EEC as amended by 93/68/EEC.

Dieses Gerät entspricht den Anforderungen der EG-Richtlinien 89/336/EWG und 73/23/EWG mit Änderung 93/68/EWG.

Ce matériel répond aux exigences contenues dans les directives 89/336/CEE et 73/23/CEE modifiées par la directive 93/68/CEE.

Dit apparaat voldoet aan de eisen van de richtlijnen 89/336/EEG en 73/23/EEG, gewijzigd door 93/68/EEG.

Dette udstyr overholder kravene i direktiv nr. 89/336/EEC og 73/23/EEC med tillæg nr. 93/68/EEC.

Quest' apparecchio è conforme ai requisiti delle direttive 89/336/EEC e 73/23/EEC, come emendata dalla direttiva 93/68/EEC.

Η εγκατάσταση αυτή ανταποκρίνεται στις απαιτήσεις των οδηγιών της Ευρωπαϊκής Ένωσης 89/336/EOK και 73/23/EOK, όπως οι κανονισμοί αυτοί συμπληρώθηκαν από την οδηγία 93/68/EOK.

Este equipamento obedece às exigências das directivas 89/336/CEE e 73/23/CEE, na sua versão corrigida pela directiva 93/68/CEE.



Este aparato satisface las exigencias de las Directivas 89/336/CEE y 73/23/CEE, modificadas por medio de la 93/68/CEE.

Denna utrustning uppfyller kraven enligt riktlinjerna 89/336/EEC och 73/23/EEC så som kompletteras av 93/68/EEC.

Dette produktet oppfyller betingelsene i direktivene 89/336/EEC og 73/23/EEC i endringen 93/68/EEC.

Tämä laite täyttää direktiivien 89/336/EEC ja 73/23/EEC vaatimukset, joita on muutettu direktiivillä 93/68/EEC.

**SPECIAL NOTE FOR USERS IN THE U.K.**

The mains lead of this product is fitted with a non-rewireable (moulded) plug incorporating a 5A fuse. Should the fuse need to be replaced, a BSI or ASTA approved BS 1362 fuse marked  or  and of the same rating as above, which is also indicated on the pin face of the plug, must be used.

Always refit the fuse cover after replacing the fuse. Never use the plug without the fuse cover fitted.

In the unlikely event of the socket outlet in your home not being compatible with the plug supplied, cut off the mains plug and fit an appropriate type.

DANGER:

The fuse from the cut-off plug should be removed and the cut-off plug destroyed immediately and disposed of in a safe manner.

Under no circumstances should the cut-off plug be inserted elsewhere into a 5A socket outlet, as a serious electric shock may occur.

To fit an appropriate plug to the mains lead, follow the instructions below:

IMPORTANT:

The wires in the mains lead are coloured in accordance with the following code:

Blue: Neutral

Brown: Live

As the colours of the wires in the mains lead of this product may not correspond with the coloured markings identifying the terminals in your plug, proceed as follows:

- The wire which is coloured blue must be connected to the plug terminal which is marked N or coloured black.
 - The wire which is coloured brown must be connected to the plug terminal which is marked L or coloured red.
- Ensure that neither the brown nor the blue wire is connected to the earth terminal in your three-pin plug.

Before replacing the plug cover make sure that:

- If the new fitted plug contains a fuse, its value is the same as that removed from the cut-off plug.
- The cord grip is clamped over the sheath of the mains lead, and not simply over the lead wires.

IF YOU HAVE ANY DOUBT, CONSULT A QUALIFIED ELECTRICIAN.



The supplied CD-ROM contains operation instructions in English, German, French, Swedish, Spanish, Italian, Dutch, Portuguese, Chinese (Traditional Chinese and Simplified Chinese) and Korean. Carefully read through the operation instructions before operating the projector.

Die mitgelieferte CD-ROM enthält Bedienungsanleitungen in Englisch, Deutsch, Französisch, Schwedisch, Spanisch, Italienisch, Niederländisch, Portugiesisch, Chinesisch (Traditionelles Chinesisch und einfaches Chinesisch) und Koreanisch. Bitte lesen Sie die Bedienungsanleitung vor der Verwendung des Projektors sorgfältig durch.

Le CD-ROM fourni contient les instructions de fonctionnement en anglais, allemand, français, suédois, espagnol, italien, néerlandais, portugais, chinois (chinois traditionnel et chinois simplifié) et coréen. Veuillez lire attentivement ces instructions avant de faire fonctionner le projecteur.

Den medföljande CD-ROM-skivan innehåller bruksanvisningar på engelska, tyska, franska, svenska, spanska, italienska, holländska, portugisiska, kinesiska (traditionell kinesiska och förenklad kinesiska) och koreanska. Läs noga igenom bruksanvisningen innan projektorn tas i bruk.

El CD-ROM suministrado contiene instrucciones de operación en inglés, alemán, francés, sueco, español, italiano, holandés, portugués, chino (chino tradicional y chino simplificado) y coreano. Lea cuidadosamente las instrucciones de operación antes de utilizar el proyector.

Il CD-ROM in dotazione contiene istruzioni per l'uso in inglese, tedesco, francese, svedese, spagnolo, italiano, olandese, portoghese, cinese (cinese tradizionale e cinese semplificato) e coreano. Leggere attentamente le istruzioni per l'uso prima di usare il proiettore.

De meegeleverde CD-ROM bevat handleidingen in het Engels, Duits, Frans, Zweeds, Spaans, Italiaans, Nederlands, Portugees, Chinees (Traditioneel Chinees en Vereenvoudigd Chinees) en Koreaans. Lees de handleiding zorgvuldig door voor u de projector in gebruik neemt.

O CD-ROM fornecido contém instruções de operação em Inglês, Alemão, Francês, Sueco, Espanhol, Italiano, Holandês, Português, Chinês, (Chinês Tradicional e Chinês Simplificado) e Coreano. Leia cuidadosamente todas as instruções de operação antes de operar o projetor.

附送之CD-ROM光碟中，有用英文、德文、法文、瑞典文、西班牙文、意大利文、荷蘭文、葡萄牙文、中文（繁體中文和簡體中文）和韓國文所寫的使用說明書。在操作本投影機之前，請務必仔細閱讀整本使用說明書。

附送之CD-ROM光碟中，有用英文、德文、法文、瑞典文、西班牙文、意大利文、荷兰文、葡萄牙文、中文（繁体中文和简体中文）和韩国文所写的使用说明书。在操作本投影机之前，请务必仔细阅读整本使用说明书。

제공된 CD-ROM에는 영어, 독일어, 프랑스어, 스웨덴어, 스페인어, 이탈리아어, 네덜란드어, 포르투갈어, 중국어(번체자와 간체자), 그리고 한국어로 작성된 조작 설명서가 포함되어 있습니다. 프로젝터를 조작하기 전에 조작 지침을 상세하게 숙지하십시오.



Before using the projector, please read this operation manual carefully.

Introduction ENGLISH

There are two important reasons for prompt warranty registration of your new SHARP Projector, using the REGISTRATION CARD packed with the projector.

1. WARRANTY

This is to assure that you immediately receive the full benefit of the parts, service and labor warranty applicable to your purchase.

2. CONSUMER PRODUCT SAFETY ACT

To ensure that you will promptly receive any safety notification of inspection, modification, or recall that SHARP may be required to give under the 1972 Consumer Product Safety Act, PLEASE READ CAREFULLY THE IMPORTANT "LIMITED WARRANTY" CLAUSE. U.S.A. ONLY

WARNING: High brightness light source. Do not stare into the beam of light, or view directly. Be especially careful that children do not stare directly into the beam of light.

WARNING: To reduce the risk of fire or electric shock, do not expose this product to rain or moisture.

See bottom of projector.

	<p>CAUTION RISK OF ELECTRIC SHOCK. DO NOT REMOVE SCREWS EXCEPT SPECIFIED USER SERVICE SCREW.</p>	
<p>CAUTION: TO REDUCE THE RISK OF ELECTRIC SHOCK, DO NOT REMOVE COVER. NO USER-SERVICEABLE PARTS EXCEPT LAMP UNIT. REFER SERVICING TO QUALIFIED SERVICE PERSONNEL.</p>		



The lightning flash with arrowhead symbol, within an equilateral triangle, is intended to alert the user to the presence of uninsulated "dangerous voltage" within the product's enclosure that may be of sufficient magnitude to constitute a risk or electric shock to persons.



The exclamation point within a triangle is intended to alert the user to the presence of important operating and maintenance (servicing) instructions in the literature accompanying the product.

WARNING: FCC Regulations state that any unauthorized changes or modifications to this equipment not expressly approved by the manufacturer could void the user's authority to operate this equipment. U.S.A. ONLY

INFORMATION

This equipment has been tested and found to comply with the limits for a Class A digital device, pursuant to Part 15 of the FCC Rules. These limits are designed to provide reasonable protection against harmful interference when the equipment is operated in a commercial environment. This equipment generates, uses, and can radiate radio frequency energy and, if not installed and used in accordance with the operation manual, may cause harmful interference to radio communications. Operation of this equipment in a residential area is likely to cause harmful interference, in which case the user will be required to correct the interference at his own expense. U.S.A. ONLY

The enclosed computer cable must be used with the device. The cable is provided to ensure that the device complies with FCC Class A verification. U.S.A. ONLY

WARNING:

This is a Class A product. In a domestic environment this product may cause radio interference in which case the user may be required to take adequate measures.





WARNING:

The cooling fan in this projector continues to run for about 90 seconds after the projector enters the standby mode. During normal operation, when putting the projector into the standby mode always use the STANDBY button on the projector or on the remote control. Ensure the cooling fan has stopped before disconnecting the power cord. DURING NORMAL OPERATION, NEVER TURN THE PROJECTOR OFF BY DISCONNECTING THE POWER CORD. FAILURE TO OBSERVE THIS WILL RESULT IN PREMATURE LAMP FAILURE.

PRODUCT DISPOSAL

This projector utilizes tin-lead solder, and a pressurized lamp containing a small amount of mercury. Disposal of these materials may be regulated due to environmental considerations. For disposal or recycling information, please contact your local authorities or, if you are located in the United States of America, the Electronic Industries Alliance: www.eiae.org.

Caution Concerning Lamp Replacement

See "Replacing the Lamp" on page 57.

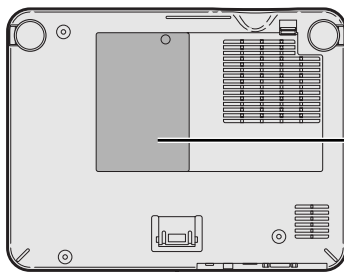

! LAMP REPLACEMENT CAUTION
 BEFORE REMOVING THE SCREW, DISCONNECT POWER CORD. HOT SURFACE INSIDE. ALLOW 1 HOUR TO COOL BEFORE REPLACING THE LAMP. REPLACE WITH SAME SHARP LAMP UNIT TYPE BQC-PGA20X/1 ONLY.
 UV RADIATION : CAN CAUSE EYE DAMAGE. TURN OFF LAMP BEFORE SERVICING.
 HIGH PRESSURE LAMP : RISK OF EXPLOSION. POTENTIAL HAZARD OF GLASS PARTICLES IF LAMP HAS RUPTURED. HANDLE WITH CARE. SEE OPERATION MANUAL.

! PRECAUTIONS A OBSERVER LORS DU REMPLACEMENT DE LA LAMPE.
 DEBRANCHER LE CORDON D'ALIMENTATION AVANT DE RETIRER LA VIS. L'INTERIEUR DU BOITIER ETANT EXTREMEMENT CHAUD, ATTENDRE 1 HEURE AVANT DE PROCEDER AU REMPLACEMENT DE LA LAMPE. NE REMPLACER QUE PAR UNE LAMPE SHARP DE TYPE BQC-PGA20X/1.
 RAYONS ULTRAVIOLETS : PEUVENT ENDOMMAGER LES YEUX. ETEINDRE LA LAMPE AVANT DE PROCEDER A L'ENTRETIEN.
 LAMPE A HAUTE PRESSION : RISQUE D'EXPLOSION. DANGER POTENTIEL DE PARTICULES DE VERRE EN CAS D'ECLATEMENT DE LA LAMPE. A MANIPULER AVEC PRECAUTION, SE REPORTER AU MODE D'EMPLOI.

When Attaching the "QUICK GUIDE" Label

Attaching the "QUICK GUIDE" Label (supplied) on the projector will help you check the setup procedure. When you attach the "QUICK GUIDE" Label on the projector, be sure to align the label bottom and the upper part of the "Notevision" logo on the top cabinet of the projector as shown in the drawing on the right. Do not attach the "QUICK GUIDE" Label anywhere else.

"QUICK GUIDE" Label

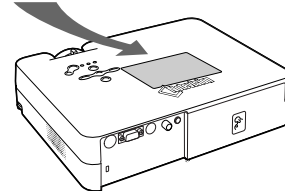

This SHARP projector uses an LCD (Liquid Crystal Display) panel. This very sophisticated panel contains 786,432 pixels (x RGB) TFTs (Thin Film Transistors). As with any high technology electronic equipment such as large screen TVs, video systems and video cameras, there are certain acceptable tolerances that the equipment must conform to.

This unit has some inactive pixels within acceptable tolerances which may result in inactive dots on the picture screen. This will not affect the picture quality or the life expectancy of the unit.





Outstanding Features

1. Light and Compact Design

- A4 / letter size projector weighing only 2.9 kg / 6.4 lbs can be easily transported from room to room or location to location.

2. Comfortable Operation, Classroom and Meeting Room Friendly

- Low fan noise and front directed exhaust outlet insure minimal disturbance to your audience seated adjacent to the projector.
- Short throw lens allows for image size of 100" at just 3.3 meters (10' 10").

3. Simply and Easy Operation

- Color-coded connections allows for hassle-free set-up.
- Frequently used buttons, lens placement are positioned for easy operation.

4. High Brightness Despite Compact Size

- Use of 180 W SHP lamp achieves excellent color uniformity and high brightness.
- The Eco mode function reduces noise levels and power consumption while also extending lamp life.

5. Wide Input Signal Compatibility

- Video systems compatible (NTSC3.58, PAL, SECAM, PAL-N, PAL-M, PAL-60 and NTSC4.43)
- HD input compatible (1080I, 720P and 480P)
- Computer input compatible (VGA, SVGA, XGA, SXGA and SXGA+)

6. Anti-Theft and Keylock

- The Anti-Theft function renders the projector useless to prevent unauthorized use until a keycode is entered.
- The Keylock function allows you to easily lock the operation buttons on the projector to prevent unauthorized adjustment.

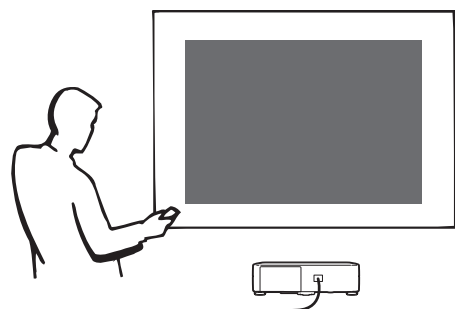

7. XXXXXXXX

- XXXXXXXX



Contents

Introduction

- Outstanding Features 3**
- Contents 4**
- IMPORTANT SAFEGUARDS 6**
- How to Access the PDF Operation Manuals 9**
- Part Names 10**
 - Projector (Front and Top View) 10
 - Projector (Rear View) 11
 - Remote Control (Front View) 12
- Using the Remote Control 13**
 - Usable Range 13
 - Inserting the Batteries 13
- Accessories 14**

Connections and Setup

- Connecting the Projector to Other Devices 15**
 - Before Connecting 15
 - This projector can be connected to: 15
 - Connecting the Power Cord 15
- Connecting the Projector to a Computer 16**
- Connecting to Video Equipment 18**
- Controlling the Projector Using a Computer 20**
- Setup 21**
 - Using the Adjustment Feet 21
 - Adjusting the Lens 22
 - Setting up the Screen 23
 - Screen Size and Projection Distance 24
 - Projecting a Reversed/Inverted Image 25

Basic Operation

- Image Projection 26**
 - Basic Procedure 26
 - Selecting the On-screen Display Language 28
 - Turning the Power off 28
- Keystone Correction
(Correcting Trapezoidal Distortion) 29**
- Menu Items 30**
- Using the Menu Screen 32**
 - Menu Selections (Adjustments) 32
 - Menu Selections (Settings) 34
- Picture Adjustment 36**
 - Adjusting the Image 36
 - CLR Temp (Adjusting the Color Temperature) 36
 - Gamma (Gamma Correction) 37
 - sRGB (sRGB Setting) 37
 - Signal Type (Signal Type Setting) 37
 - Memory (Storing and Selecting the Adjustment Settings) 37
- Computer Image Adjustment 38**
 - Adjusting the Computer Image 38
 - Special Modes (Special Mode Settings) 38

- Auto Sync (Auto Sync Adjustment) 39
- Signal Info (Checking the Input Signal) 39

Easy to Use Functions

- Picture Display Mode 40**
 - Switching the Picture Display Mode 40
- Still and Zoom Image 42**
 - Freezing a Moving Image 42
 - Displaying an Enlarged Portion of an Image 42
- Keylock Function 43**
 - Locking the operation Buttons 43
 - Taking the Keylock off 43
- Using the "Options" Menu 44**
 - Lamp Timer (Life) (Checking the Lamp Life Status) 44
 - Keystone (Setting the Keystone Correction Mode) 44
 - OSD Display (Setting On-screen Display) 45
 - Video System (Setting the Video System) 45
 - Background (Selecting a Startup and Background Image) 45
 - Eco Mode (Setting the Eco Mode) 45
 - Auto Power Off (Auto Power Off Function) 46
 - Menu Position (Selecting the Menu Screen Position) 46
 - Menu Color (Selecting the Menu Color) 46
 - Password (Setting a Password) 47
 - If You Forget Your Password 47
 - Anti-Theft (Setting the Anti-Theft) 48
- Reversing /Inverting Projected Images 50**
 - Setting the Projection Mode 50



Appendix

Carrying the Projector	51
How to Use the Carrying Case	51
Maintenance	52
Replacing the Air Filter	53
Cleaning and Replacing the Air Filter	53
Maintenance Indicators	55
Regarding the Lamp	57
Lamp	57
Caution Concerning the Lamp	57
Replacing the Lamp	57
Removing and Installing the Lamp Unit	58
Resetting the Lamp Timer	59
Connecting Pin Assignments	60
RS-232C Specifications and	
Command Settings	61
Computer Compatibility Chart	62
Troubleshooting	63
For SHARP Assistance	65
Specifications	66
Dimensions	67
Glossary	68
Index	69



IMPORTANT SAFEGUARDS

CAUTION: Please read all of these instructions before you operate this product and save these instructions for later use.

Electrical energy can perform many useful functions. This product has been engineered and manufactured to assure your personal safety. BUT IMPROPER USE CAN RESULT IN POTENTIAL ELECTRICAL SHOCK OR FIRE HAZARDS. In order not to defeat the safeguards incorporated in this product, observe the following basic rules for its installation, use and servicing.

1. Read Instructions

All the safety and operating instructions should be read before the product is operated.

2. Retain Instructions

The safety and operating instructions should be retained for future reference.

3. Heed Warnings

All warnings on the product and in the operating instructions should be adhered to.

4. Follow Instructions

All operating and use instructions should be followed.

5. Cleaning

Unplug this product from the wall outlet before cleaning. Do not use liquid cleaners or aerosol cleaners. Use a damp cloth for cleaning.

6. Attachments

Do not use attachments not recommended by the product manufacturer as they may cause hazards.

7. Water and Moisture

Do not use this product near water—for example, near a bath tub, wash bowl, kitchen sink, or laundry tub; in a wet basement; or near a swimming pool; and the like.

8. Accessories

Do not place this product on an unstable cart, stand, tripod, bracket, or table. The product may fall, causing serious injury to a child or adult, and serious damage to the product. Use only with a cart, stand, tripod, bracket, or table recommended by the manufacturer, or sold with the product. Any mounting of the product should follow the manufacturer's instructions, and should use a mounting accessory recommended by the manufacturer.

9. Transportation

A product and cart combination should be moved with care. Quick stops, excessive force, and uneven surfaces may cause the product and cart combination to overturn.



10. Ventilation

Slots and openings in the cabinet are provided for ventilation to ensure reliable operation of the product and to protect it from overheating, and these openings must not be blocked or covered. The openings should never be blocked by placing the product on a bed, sofa, rug, or other similar surface. This product should not be placed in a built-in installation such as a bookcase or rack unless proper ventilation is provided or the manufacturer's instructions have been adhered to.

11. Power Sources

This product should be operated only from the type of power source indicated on the marking label. If you are not sure of the type of power supply to your home, consult your product dealer or local power company. For products intended to operate from battery power, or other sources, refer to the operating instructions.

12. Grounding or Polarization

This product is provided with one of the following types of plugs. If the plug should fail to fit into the power outlet, please contact your electrician.

Do not defeat the safety purpose of the plug.

- Two-wire type (mains) plug.
- Three-wire grounding type (mains) plug with a grounding terminal.

This plug will only fit into a grounding type power outlet.

13. Power-Cord Protection

Power-supply cords should be routed so that they are not likely to be walked on or pinched by items placed upon or against them, paying particular attention to cords at plugs, convenience receptacles, and the point where they exit from the product.

14. Lightning

For added protection for this product during a lightning storm, or when it is left unattended and unused for long periods of time, unplug it from the wall outlet and disconnect the cable system. This will prevent damage to the product due to lightning and power-line surges.

15. Overloading

Do not overload wall outlets, extension cords, or integral convenience receptacles as this can result in a risk of fire or electric shock.

16. Object and Liquid Entry

Never push objects of any kind into this product through openings as they may touch dangerous voltage points or short-out parts that could result in a fire or electric shock. Never spill liquid of any kind on the product.

17. Servicing

Do not attempt to service this product yourself as opening or removing covers may expose you to dangerous voltage or other hazards. Refer all servicing to qualified service personnel.



18. Damage Requiring Service

Unplug this product from the wall outlet and refer servicing to qualified service personnel under the following conditions:

- a. When the power-supply cord or plug is damaged.
- b. If liquid has been spilled, or objects have fallen into the product.
- c. If the product has been exposed to rain or water.
- d. If the product does not operate normally by following the operating instructions. Adjust only those controls that are covered by the operating instructions, as an improper adjustment of other controls may result in damage and will often require extensive work by a qualified technician to restore the product to normal operation.
- e. If the product has been dropped or damaged in any way.
- f. When the product exhibits a distinct change in performance, this indicates a need for service.

19. Replacement Parts

When replacement parts are required, be sure the service technician has used replacement parts specified by the manufacturer or have the same characteristics as the original part. Unauthorized substitutions may result in fire, electric shock, or other hazards.

20. Safety Check

Upon completion of any service or repairs to this product, ask the service technician to perform safety checks to determine that the product is in proper operating condition.

21. Wall or Ceiling Mounting

This product should be mounted to a wall or ceiling only as recommended by the manufacturer.

22. Heat

This product should be situated away from heat sources such as radiators, heat registers, stoves, or other products (including amplifiers) that produce heat.

- Microsoft and Windows are registered trademarks of Microsoft Corporation in the United States and/or other countries.
- PC/AT is a registered trademark of International Business Machines Corporation in the United States.
- Adobe Acrobat is a trademark of Adobe Systems Incorporated.
- Macintosh is a registered trademark of Apple Computer, Inc. in the United States and/or other countries.
- All other company or product names are trademarks or registered trademarks of their respective companies.

IMPORTANT SAFEGUARDS

Be sure to read the following safeguards when setting up your projector.

Caution concerning the lamp unit

- Potential hazard of glass particles if lamp ruptures. In case of lamp rupture, contact your nearest Sharp Authorized Projector Dealer or Service Center for a replacement.

See "Replacing the Lamp" on page 57.

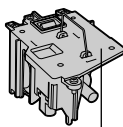

Caution concerning the setup of the projector

- For minimal servicing and to maintain high image quality, SHARP recommends that this projector be installed in an area free from humidity, dust and cigarette smoke. When the projector is subjected to these environments, the lens must be cleaned more often. As long as the projector is regularly cleaned, use in these environments will not reduce the overall operation life of the unit. Internal cleaning should only be performed by a Sharp Authorized Projector Dealer or Service Center.

Do not set up the projector in places exposed to direct sunlight or bright light.

- Position the screen so that it is not in direct sunlight or room light. Light falling directly on the screen washes out the colors, making viewing difficult. Close the curtains and dim the lights when setting up the screen in a sunny or bright room.

The projector may be safely tilted to a maximum angle of 12 degrees.

- Placement should be within ± 12 degrees of horizontal.



Do not subject the projector to hard impact and/or vibration.

- Take care with the lens so as not to hit or damage the surface of the lens.

Rest your eyes occasionally.

- Continuously watching the screen for long hours will cause eye strain. Be sure to occasionally rest your eyes.

Avoid locations with extremes of temperature.

- The operating temperature of the projector is from 41°F to 95°F (+5°C to +35°C).
- The storage temperature of the projector is from -4°F to 140°F (-20°C to +60°C).

Do not block the exhaust and intake vents.

- Allow at least 7 7/8 inches (20 cm) of space between the exhaust vent and the nearest wall or obstruction.

- Be sure that the intake vent and the exhaust vent are not obstructed.
- If the cooling fan becomes obstructed, a protection circuit will automatically put the projector into the standby mode. This does not indicate a malfunction. Remove the projector power cord from the wall outlet and wait at least 10 minutes. Place the projector where the intake and exhaust vents are not blocked, plug the power cord back in and turn on the projector. This will return the projector to the normal operating condition.

Caution regarding transportation of the projector

- When transporting the projector, be sure not to subject it to hard impact and/or vibration, as this can result in damage. Take extra care with the lens. Before moving the projector, be sure to unplug the power cord from the wall outlet, and disconnect any other cables connected to it.

Other connected equipment

- When connecting a computer or other audio-visual equipment to the projector, make the connections AFTER unplugging the power cord of the projector from the AC outlet and turning off the equipment to be connected.
- Please read the operation manuals of the projector and the equipment to be connected for instructions on how to make the connections.

Using the projector in other countries

- The power supply voltage and the shape of the plug may vary depending on the region or country you are using the projector in. When using the projector overseas, be sure to use an appropriate power cord for the country you are in.

Temperature monitor function

- If the projector starts to overheat due to setup problems or blockage of the air vents, "TEMP." and "TEMP." will illuminate in the lower left corner of the picture. If the temperature continues to rise, the lamp will turn off, the temperature warning indicator on the projector will blink, and after a 90-second cooling-off period the projector will enter the standby mode. Refer to "Maintenance Indicators" on page 55 for details.



Info

- The cooling fan regulates the internal temperature, and its performance is automatically controlled. The sound of the fan may change during projector operation due to changes in the fan speed. This does not indicate malfunction.
- Do not unplug the power cord during projection or cooling fan operation. This can cause damage due to rise in internal temperature, as the cooling fan also stops.



How to Access the PDF Operation Manuals

PDF operation manuals in several languages are included in the CD-ROM, so that you can work with the projector, even if you do not have this manual. To utilize these manuals, you need to install Adobe Acrobat Reader on your PC (Windows or Macintosh). If you have not installed Acrobat Reader yet, you can install it from the CD-ROM.

To install Acrobat Reader from the CD-ROM

For Windows:

- ① Insert the CD-ROM in the CD-ROM drive.
- ② Double click the "My Computer" icon.
- ③ Double click the "CD-ROM" drive.
- ④ Double click the "ACROBAT" folder.
- ⑤ Double click the language (name of the folder) that you want to view.
- ⑥ Double click the installation program and follow the instructions on the screen.

For Macintosh:

- ① Insert the CD-ROM in the CD-ROM drive.
- ② Double click the "CD-ROM" icon.
- ③ Double click the "ACROBAT" folder.
- ④ Double click the language (name of the folder) that you want to view.
- ⑤ Double click the installation program and follow the instructions on the screen.

For other operating systems:

Please download Acrobat Reader from the Internet (<http://www.adobe.com>).

For other languages:

If you prefer using Acrobat Reader for languages other than those included in the CD-ROM, please download the appropriate version from the Internet.

Accessing the PDF Manuals

For Windows:

- ① Insert the CD-ROM in the CD-ROM drive.
- ② Double click the "My Computer" icon.
- ③ Double click the "CD-ROM" drive.
- ④ Double click the "MANUALS" folder.
- ⑤ Double click the language (name of the folder) that you want to view.
- ⑥ Double click the "A20" pdf file to access the projector manuals.

For Macintosh:

- ① Insert the CD-ROM in the CD-ROM drive.
- ② Double click the "CD-ROM" icon.
- ③ Double click the "MANUALS" folder.
- ④ Double click the language (name of the folder) that you want to view.
- ⑤ Double click the "A20" pdf file to access the projector manuals.

Note

- If the desired pdf file cannot be opened by double clicking the mouse, start Acrobat Reader first, then specify the desired file using the "File", "Open" menu.
- See the "readme.txt" file on the CD-ROM for important information not included in this operation manual.



Part Names

Numbers in **[]** refer to the main pages in this operation manual where the topic is explained.

Projector (Front and Top View)

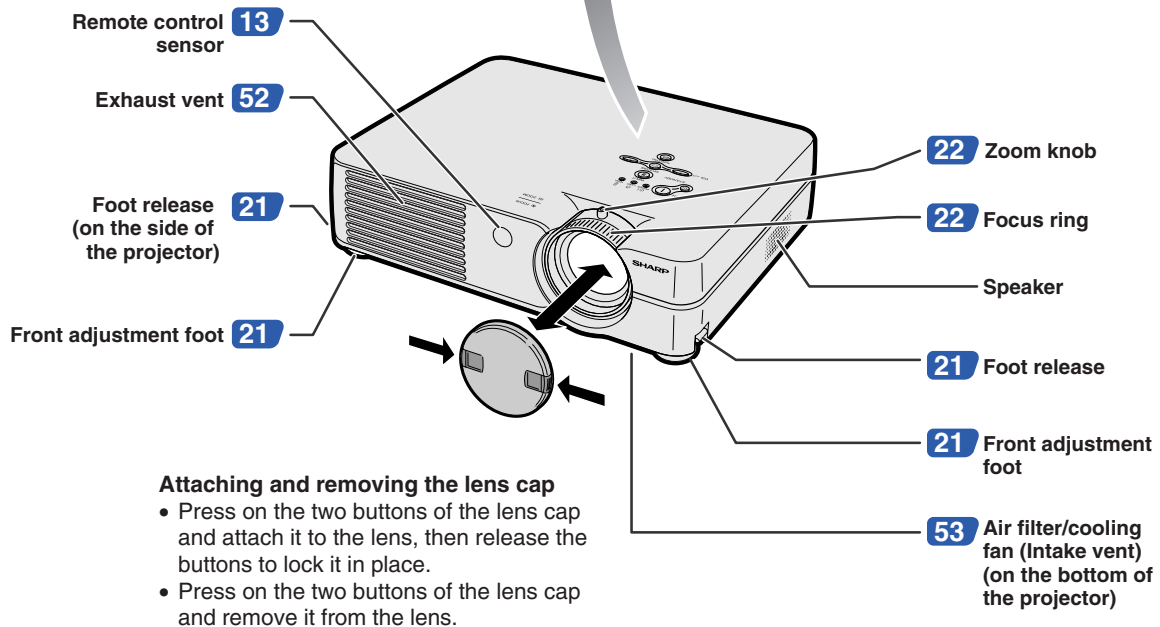
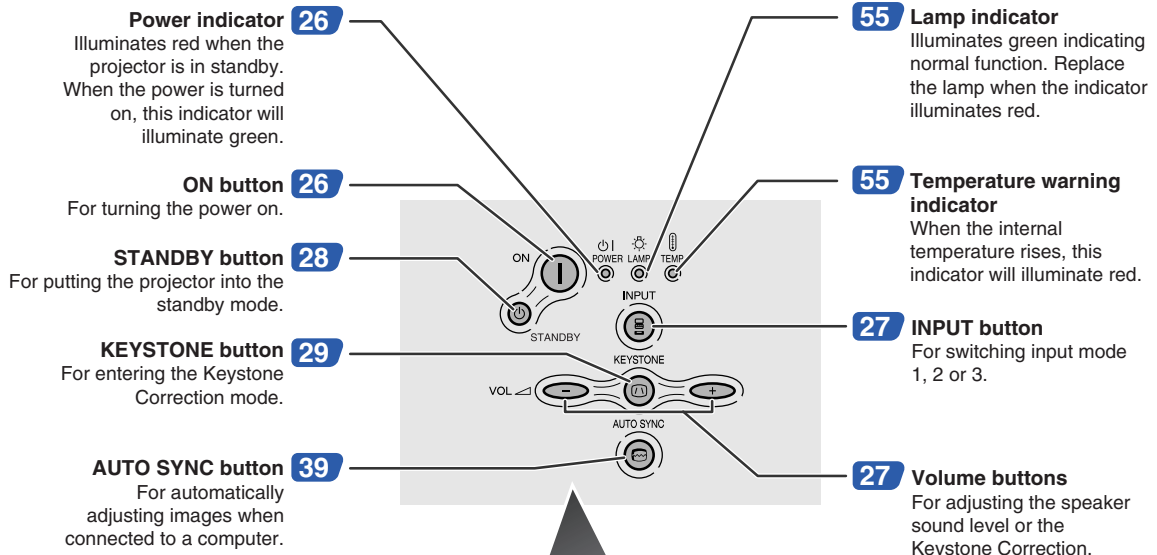

In this operation manual, the illustration and the screen display are simplified for explanation, and may differ slightly from actual display.



Projector (Rear View)

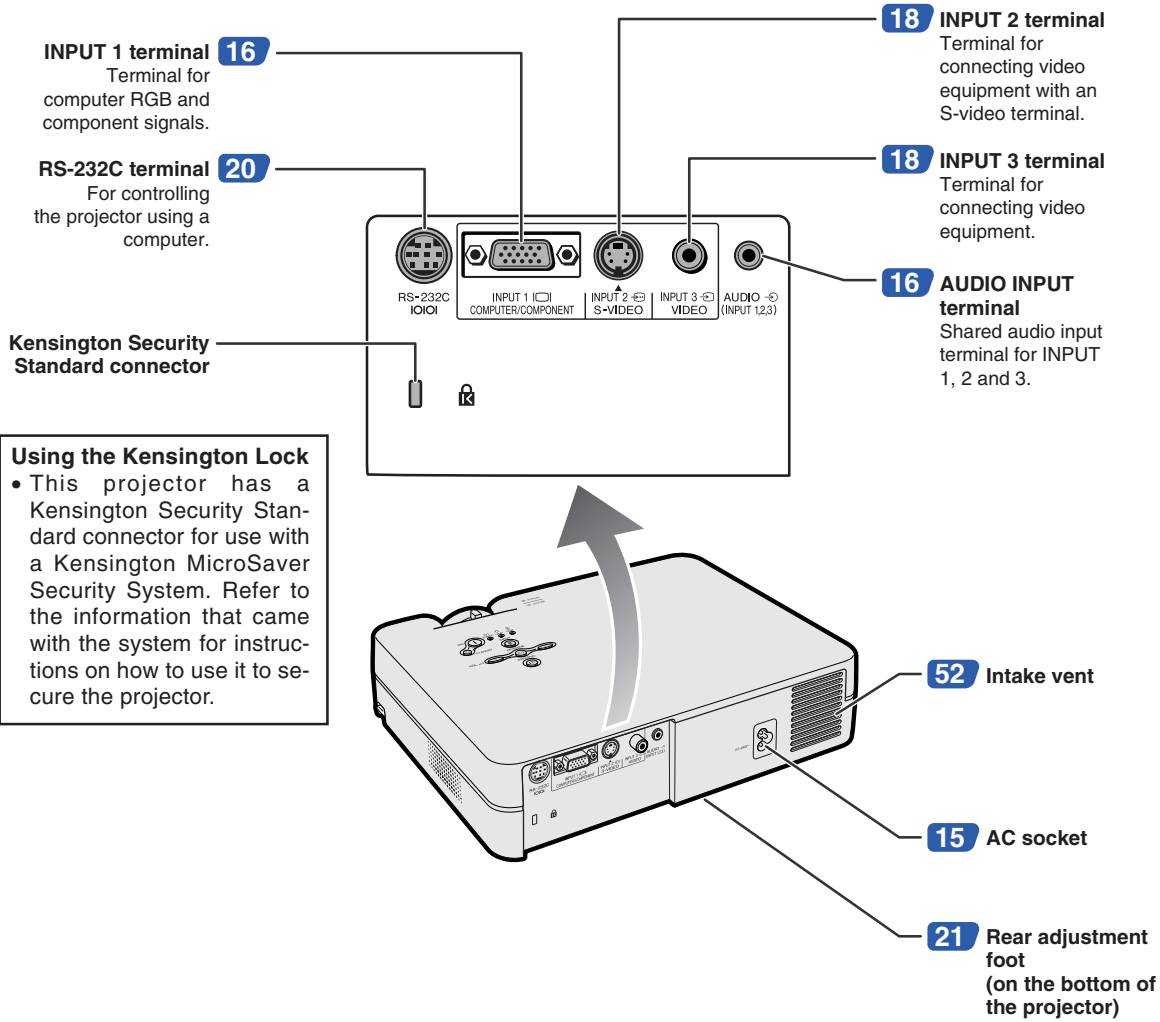

Part Names

Numbers in **[]** refer to the main pages in this operation manual where the topic is explained.

Remote Control (Front View)

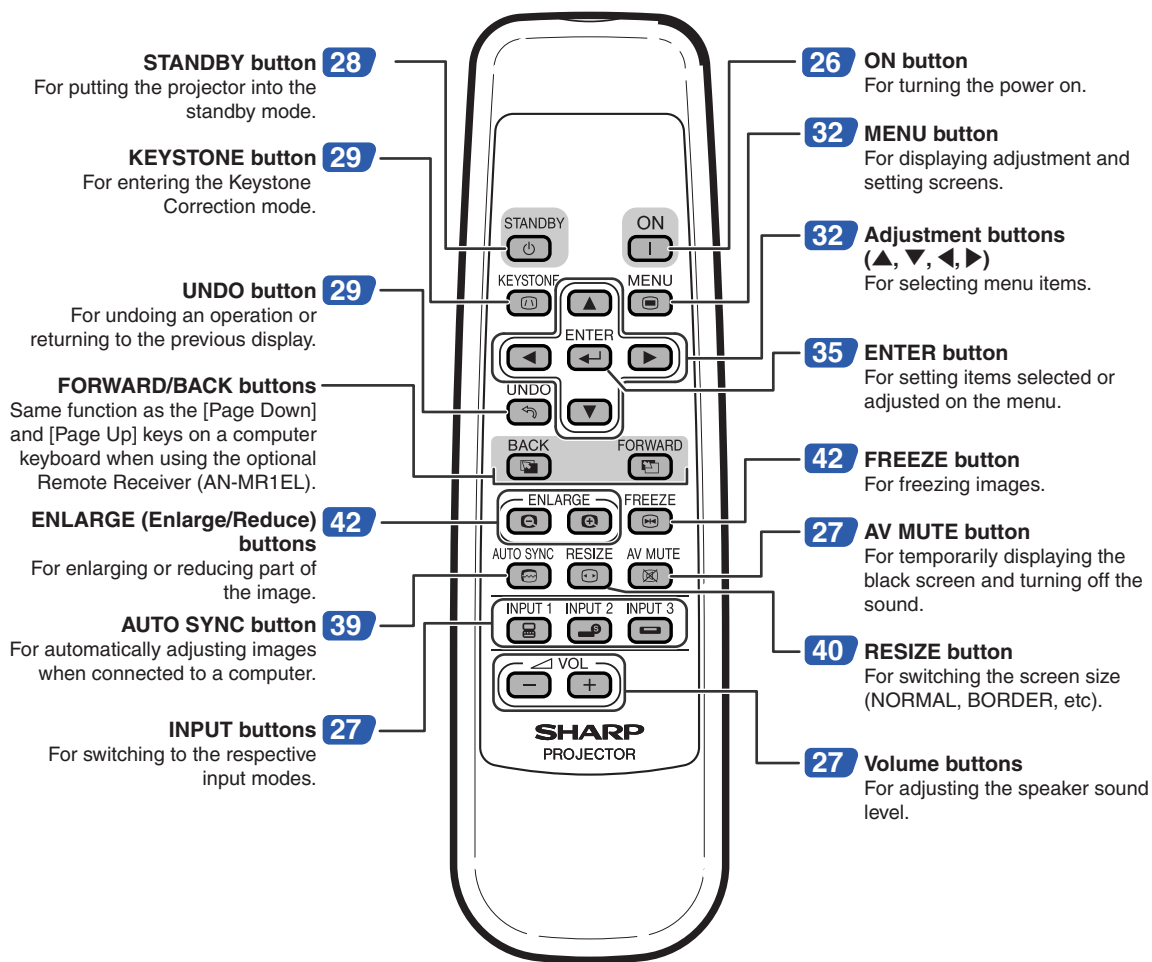



Using the Remote Control

Usable Range

- The remote control can be used to control the projector within the ranges shown in the illustration.

Note

- The signal from the remote control can be reflected off a screen for easy operation. However, the effective distance of the signal may differ depending on the screen material.

When using the remote control:

- Be sure not to drop, expose to moisture or high temperature.
- The remote control may malfunction under a fluorescent lamp. In this case, move the projector away from the fluorescent lamp.

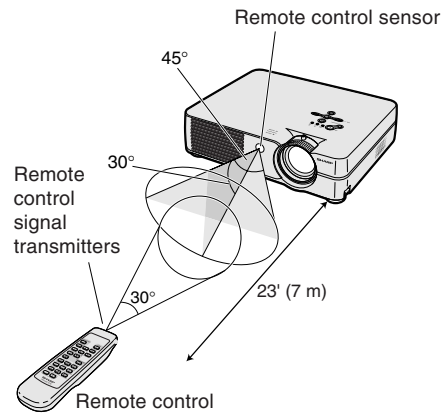

Inserting the Batteries

The batteries (two R-6 batteries ("AA" size, UM/SUM-3, HP-7 or similar)) are supplied in the package.

- 1 Press the ▲ mark on the cover and slide it in the direction of the arrow.
- 2 Insert the batteries.
 - Insert the batteries making sure the polarities correctly match the ⊕ and ⊖ marks inside the battery compartment.
- 3 Attach the cover and slide it until it clicks into place.

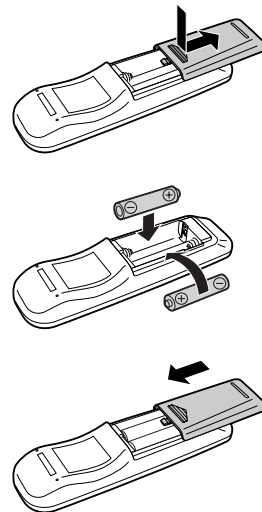

Incorrect use of the batteries may cause them to leak or explode. Please follow the precautions below.



⚠ Caution

- Insert the batteries making sure the polarities correctly match the ⊕ and ⊖ marks inside the battery compartment.
- Batteries of different types have different properties, therefore do not mix batteries of different types.
- Do not mix new and old batteries.
This may shorten the life of new batteries or may cause old batteries to leak.
- Remove the batteries from the remote control once they have run out, as leaving them in can cause them to leak. Battery fluid from leaked batteries is harmful to skin, therefore be sure to first wipe them and then remove them using a cloth.

- The batteries included with this projector may run down in a short period, depending on how they are kept. Be sure to replace them as soon as possible with new batteries.
- Remove the batteries from the remote control if you will not be using the remote control for a long time.

Accessories

Supplied accessories

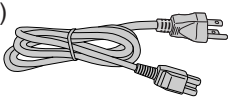
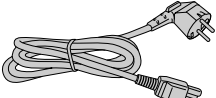
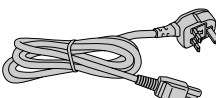
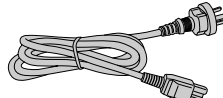
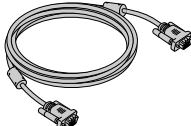
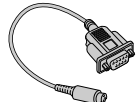
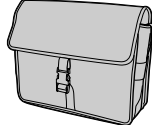
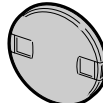
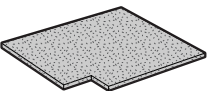
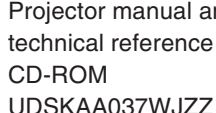
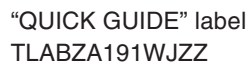
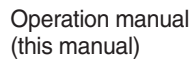
	Remote control RRMCGA187WJSA		Two R-6 batteries ("AA" size, UM/SUM-3, HP-7 or similar)
Power cord*			
(1) 	(2) 	(3) 	(4) 
For U.S., Canada, etc. (6' (1.8 m)) QACCDAA016WJPZ	For Europe, except U.K. (6' (1.8 m)) QACCVA006WJPZ	For U.K., Hong Kong and Singapore (6' (1.8 m)) QACCBA015WJPZ	For Australia, New Zealand and Oceania (6' (1.8 m)) QACCLA005WJPZ
* Use the power cord that corresponds to the wall outlet in your country.			
			
RGB cable (9'10" (3.0 m)) QCNWGA012WJPZ	DIN-D-sub RS-232C adaptor (5 57/64" (15 cm)) QCNWGA015WJPZ	Carrying case GCASNA006WJSA	Lens cap (attached) CCAPHA011WJ01
			
Extra air filter PFILDA008WJZZ	Projector manual and technical reference CD-ROM UDSKAA037WJZZ	"QUICK GUIDE" label TLABZA191WJZZ	Operation manual (this manual)

Optional accessories

- | | |
|--|---|
| ■ 3 RCA to 15-pin D-sub cable (9'10" (3.0 m)) | AN-C3CP |
| ■ Computer RGB cable (32'10" (10.0 m)) | AN-C10BM (15-pin mini D-sub male connector) |
| ■ 5 BNC to 15-pin D-sub cable (9'10" (3.0 m)) | AN-C3BN |
| ■ RS-232C serial control cable (32'10" (10.0 m)) | AN-C10RS |
| ■ Remote receiver | AN-MR1EL |

Note

- Some of the cables may not be available depending on the region. Please check with your nearest Sharp Authorized Projector Dealer or Service Center.



Connecting the Projector to Other Devices

Before Connecting



- Before connecting, be sure to unplug the power cord of the projector from the AC outlet and turn off the devices to be connected. After making all connections, turn on the projector and then the other devices. When connecting a computer, be sure that it is the last device to be turned on after all the connections are made.
- Be sure to read the operation manuals of the devices to be connected before making connections.

This projector can be connected to:

A computer using:

- An RGB cable and a ø3.5 mm audio cable (commercially available) (See page 16.)
- A DIN-D-sub RS-232C adaptor and an RS-232C serial control cable (AN-C10RS) (sold separately) (See page 20.)

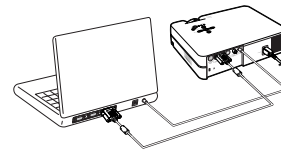

Component video or audio-visual equipment:

- A VCR, Laser disc player or other audio-visual equipment (See page 18.)
- A DVD player or DTV* decoder (See page 19.)

*DTV is the umbrella term used to describe the new digital television system in the United States.

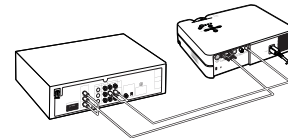
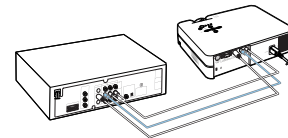

Connecting the Power Cord

Plug the supplied power cord into the AC socket on the rear of the projector.

Supplied accessory

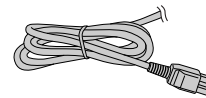

Power cord

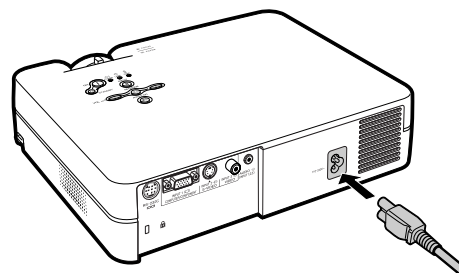



Connecting the Projector to Other Devices

Connecting the Projector to a Computer

Connecting to a Computer Using the RGB Cable

1 Connect the projector to the computer using the supplied RGB cable.

- Secure the connectors by tightening the thumbscrews.

2 To input an audio signal, connect the projector to the computer using a $\varnothing 3.5$ mm audio cable (commercially available or available as Sharp service part QCNWGA013WJPZ).

Note

- When connecting the projector to a computer in this way, select "RGB" for "Signal Type" in the "Picture" menu. See page 37.
- See page 62 "Computer Compatibility Chart" for a list of computer signals compatible with the projector. Use with computer signals other than those listed may cause some of the functions to not work.
- A Macintosh adaptor may be required for use with some Macintosh computers. Contact your nearest Sharp Authorized Projector Dealer or Service Center.
- Depending on the computer you are using, an image may not be projected unless the signal output setting of the computer is switched to the external output. Refer to the computer operation manual for switching the computer signal output settings.

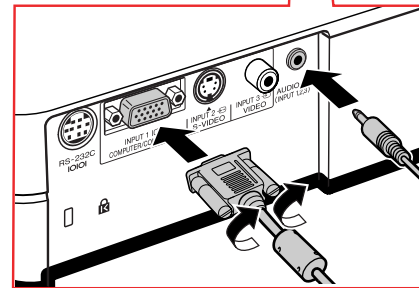
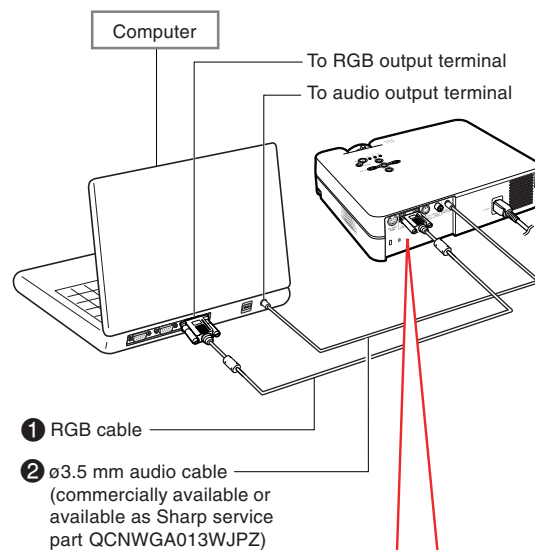
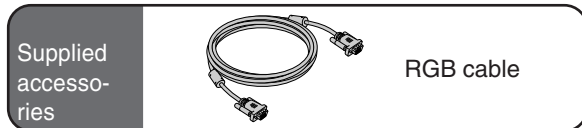

Connecting the thumbscrew cables

- Connect the thumbscrew cable making sure that it fits correctly into the terminal. Then, firmly secure the connectors by tightening the screws on both sides of the plug.
- Do not remove ferrite cores attached to the RGB cable.

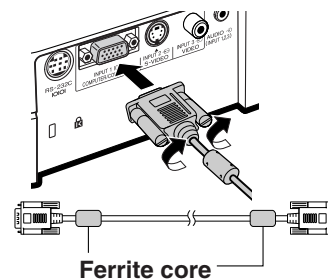



“Plug and Play” function (when connecting to a 15-pin terminal)

- This projector is compatible with VESA-standard DDC 1/DDC 2B. The projector and a VESA DDC compatible computer will communicate their setting requirements, allowing for quick and easy setup.
- Before using the “Plug and Play” function, be sure to turn on the projector first and the connected computer last.

Note

- The DDC “Plug and Play” function of this projector operates only when used in conjunction with a VESA DDC compatible computer.

Connecting to Video Equipment

Connecting to Video Equipment Using an S-video, a Composite Video or an Audio Cable

Using an S-video, video, or audio cable, a VCR, laser disc player or other audio-visual equipment can be connected to INPUT 2, INPUT 3 and AUDIO input terminals.

1 Connect the projector to the video equipment using an S-video cable or a composite video cable (both commercially available).

2 Connect the projector to the video equipment using a $\varnothing 3.5$ mm minijack to RCA audio cable (commercially available).

Note

- The INPUT 2 (S-VIDEO) terminal uses a video signal system in which the picture is separated into color and luminance signals to realize a higher-quality image. To view a higher-quality image, use a commercially available S-video cable to connect the INPUT 2 terminal on the projector and the S-video output terminal on the video equipment.
- A $\varnothing 3.5$ mm minijack to RCA audio cable (commercially available) is required for audio input.

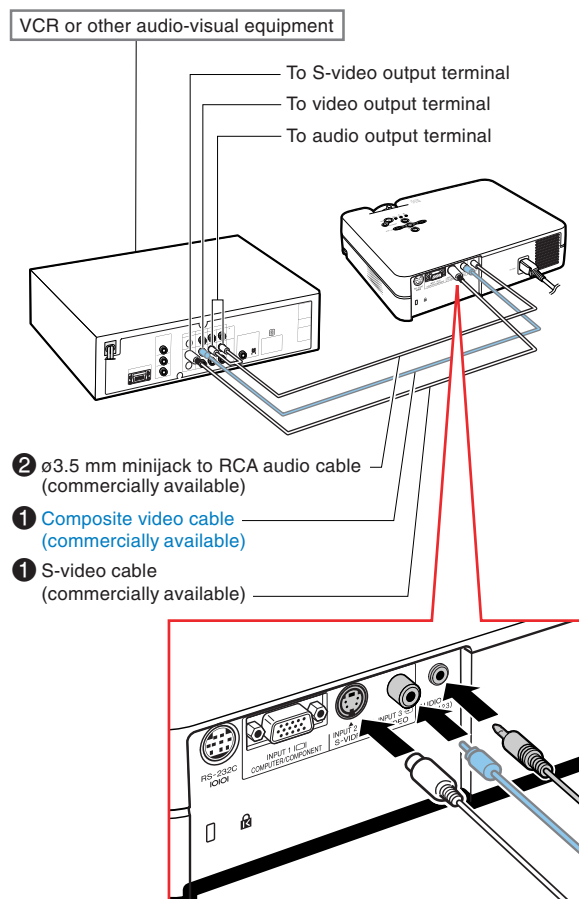



Connecting to Component Video Equipment

Use a 3 RCA to 15-pin D-sub cable when connecting to the INPUT 1 terminal, component video equipment such as DVD players and DTV* decoders.

*DTV is the umbrella term used to describe the new digital television system in the United States.

1 Connect the projector to the video equipment using the 3 RCA to 15-pin D-sub cable.

2 Connect the projector to the video equipment using a $\varnothing 3.5$ mm minijack to RCA audio cable (commercially available).

Note

- When connecting the projector to the video equipment in this way, select "Component" for "Signal Type" in the "Picture" menu. See page 37.
- A $\varnothing 3.5$ mm minijack to RCA audio cable (commercially available) is required for audio input.

Optional cable

3RCA to 15-pin D-sub cable
AN-C3CP
(9'10" (3.0 m))

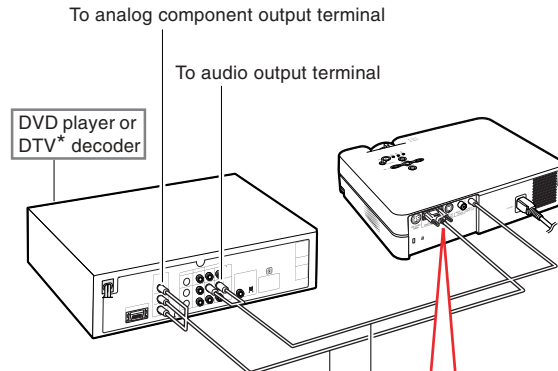

- 1 3 RCA to 15-pin D-sub cable (sold separately)
- 2 $\varnothing 3.5$ mm minijack to RCA audio cable (commercially available)

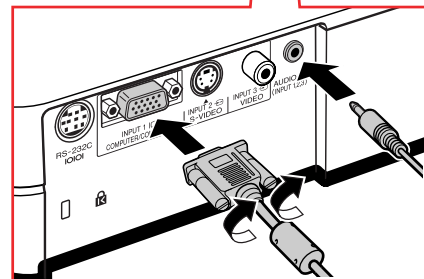



Connecting the Projector to Other Devices

Controlling the Projector Using a Computer

Connecting to a Computer Using a DIN-D-sub RS-232C Adaptor and an RS-232C Serial Control Cable

When the RS-232C terminal on the projector is connected to a computer with a DIN-D-sub RS-232C adaptor and an RS-232C serial control cable (cross type, sold separately), the computer can be used to control the projector and check the status of the projector. See page 61 for details.

1 Connect the supplied DIN-D-sub RS-232C adaptor to an RS-232C serial control cable (sold separately).

2 Use the above cables to connect the projector and the computer.

Note

- Do not connect or disconnect an RS-232C serial control cable to or from the computer while it is on. This may damage your computer.
- The RS-232C function may not operate if your computer terminal is not correctly set up. Refer to the operation manual of the computer for details.
- See page 60 for connection of an RS-232C serial control cable.

Supplied accessory

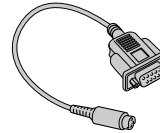

DIN-D-sub RS-232C adaptor

Optional cable

RS-232C serial control cable AN-C10RS (32'10" (10.0 m))

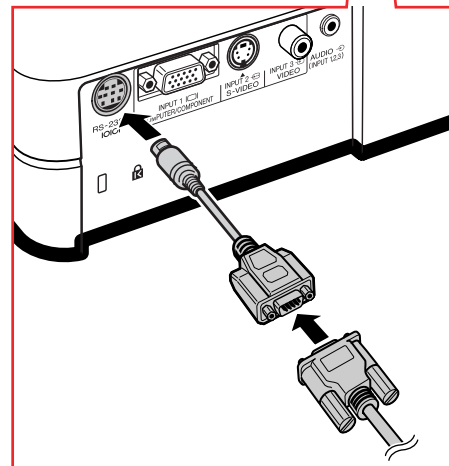
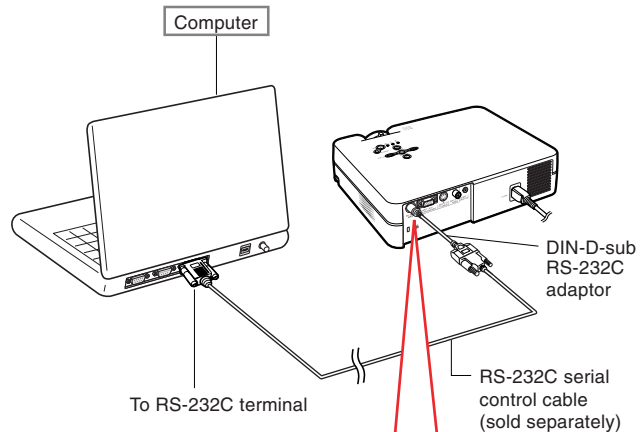

Setup

Using the Adjustment Feet

The height of the projector can be adjusted using the adjustment feet at the front and rear of the projector when the surface projector is placed on is uneven or when the screen is slanted.

The projection of the image can be made higher by adjusting the projector when it is in a lower place than the screen.

1 While pressing the foot releases on both sides, lift the projector to adjust its height and then remove your fingers from the foot releases.

2 Rotate the adjustment feet at the front of the projector for fine adjustment.

- You can adjust the projection by using the rear adjustment foot on the bottom of the projector when the projector is positioned at the higher place than the screen.

Note

- The Keystone Correction will be automatically performed when the projector is tilted. If you want to adjust the Keystone Correction manually, see page 29. (For details on setting of the Keystone Correction, see page 44.)
- When returning the projector to its original position, hold the projector firmly, press the foot releases and then gently lower it.
- The projector is adjustable up to approximately 12 degrees at the front and 3 degrees at the back from the standard position.

Info

- Do not press the foot releases when the adjustment feet are extended without firmly holding the projector.
- Do not hold the lens when lifting or lowering the projector.
- When lowering the projector, be careful not to get your fingers caught in the area between the adjustment foot and the projector.

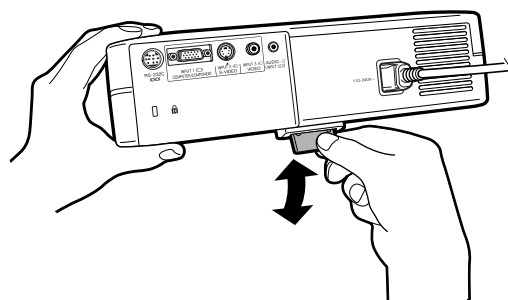
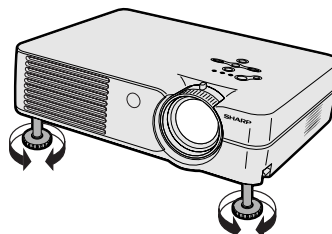
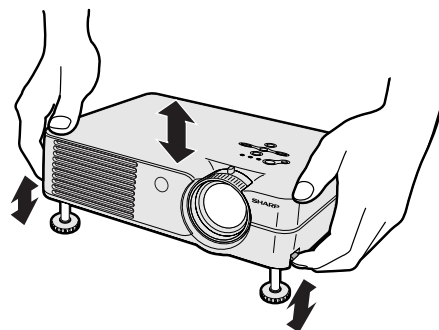
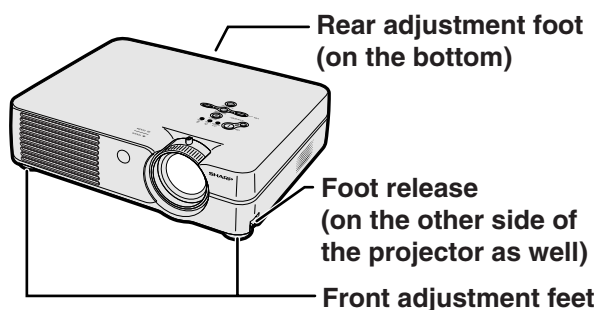



Setup

Adjusting the Lens

The image is focused and adjusted to the desired size using the focus ring or zoom knob on the projector.

- 1** Adjust the focus by rotating the focus ring.

- 2** Adjust zooming by moving the zoom knob.

Focus ring Zoom knob

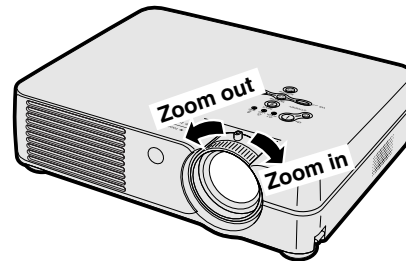
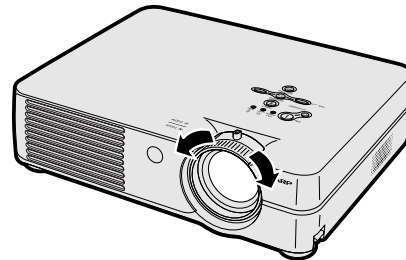
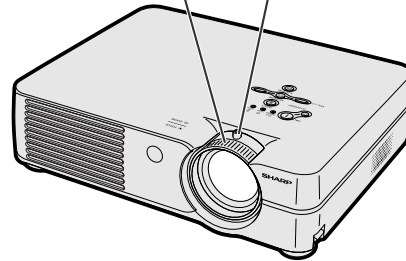



Setting up the Screen

Position the projector perpendicular to the screen with all feet flat and level to achieve an optimal image.

Note

- The projector lens should be centered in the middle of the screen. If the horizontal line passing through the lens center is not perpendicular to the screen, the image will be distorted, making viewing difficult.
- For an optimal image, position the screen so that it is not in direct sunlight or room light. Light falling directly on the screen washes out the colors, making viewing difficult. Close the curtains and dim the lights when setting up the screen in a sunny or bright room.
- A polarizing screen cannot be used with this projector.

Standard Setup (Front Projection)

- Place the projector at the required distance from the screen according to the desired picture size. (See page 24.)

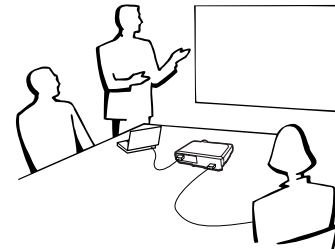

Example of standard setup

Side View

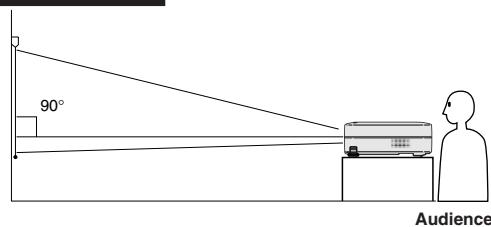

- The distance from the screen to the projector may vary depending on the size of the screen. **P.24**

- The default setting can be used, when placing the projector in front of the screen. If the projected image is reversed or inverted, readjust the setting to "Front" in the "PRJ Mode" menu. **P.50**

Top View

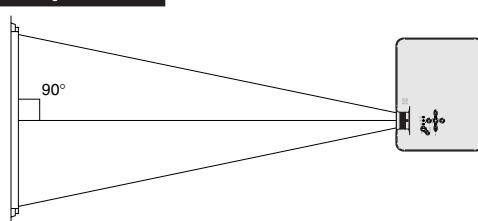

- Place the projector so that an imaginary horizontal line that passes through the center of the lens is perpendicular to the screen.



Setup

Screen Size and Projection Distance

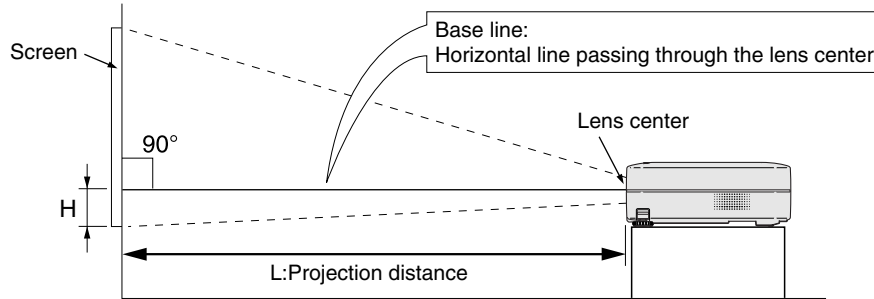

NORMAL Mode (4:3)

Picture (Screen) size			Projection distance [L]		Distance from the lens center to the bottom of the image [H]
Diag. [χ]	Width	Height	Minimum [L1]	Maximum [L2]	
300" (762 cm)	240" (610 cm)	180" (457 cm)	32'10" (10.0 m)	39' 0" (11.9 m)	17 ^{31/64"} (44.4 cm)
250" (635 cm)	200" (508 cm)	150" (381 cm)	27' 3" (8.3 m)	32' 6" (9.9 m)	14 ^{37/64"} (37.0 cm)
200" (508 cm)	160" (406 cm)	120" (305 cm)	21' 8" (6.6 m)	25'11" (7.9 m)	11 ^{21/32"} (29.6 cm)
150" (381 cm)	120" (305 cm)	90" (229 cm)	16' 5" (5.0 m)	19' 4" (5.9 m)	8 ^{3/4"} (22.2 cm)
100" (254 cm)	80" (203 cm)	60" (152 cm)	10'10" (3.3 m)	12'10" (3.9 m)	5 ^{53/64"} (14.8 cm)
84" (213 cm)	67" (170 cm)	50" (128 cm)	8'10" (2.7 m)	10'10" (3.3 m)	4 ^{57/64"} (12.4 cm)
72" (183 cm)	58" (147 cm)	43" (110 cm)	7' 7" (2.3 m)	9' 2" (2.8 m)	4 ^{7/32"} (10.7 cm)
60" (152 cm)	48" (122 cm)	36" (91 cm)	6' 3" (1.9 m)	7' 7" (2.3 m)	3 ^{33/64"} (8.9 cm)
40" (102 cm)	32" (81 cm)	24" (61 cm)	4' 3" (1.3 m)	4'11" (1.5 m)	2 ^{21/64"} (5.9 cm)

The formula for picture size and projection distance

χ: Picture size (diag.) (in)

[Feet, inches]

L1 (ft) = (0.0334χ - 0.06) / 0.3048

L2 (ft) = (0.0398χ - 0.06) / 0.3048

H (in) = 0.0583χ

[m, cm]

L1 (m) = 0.0334χ - 0.06

L2 (m) = 0.0398χ - 0.06

H (cm) = 0.0583χ × 2.54

STRETCH Mode (16:9)

Picture (Screen) size			Projection distance [L]		Distance from the lens center to the bottom of the image [H]
Diag. [χ]	Width	Height	Minimum [L1]	Maximum [L2]	
300" (762 cm)	261" (664 cm)	147" (374 cm)	35' 9" (10.9 m)	42' 8" (13.0 m)	-4 ^{47/64"} (-12.0 cm)
250" (635 cm)	218" (553 cm)	123" (311 cm)	29' 6" (9.0 m)	35' 5" (10.8 m)	-3 ^{15/16"} (-10.0 cm)
225" (572 cm)	196" (498 cm)	110" (280 cm)	26' 7" (8.1 m)	31' 10" (9.7 m)	-3 ^{35/64"} (-9.0 cm)
200" (508 cm)	174" (443 cm)	98" (249 cm)	23' 7" (7.2 m)	28' 3" (8.6 m)	-3 ^{5/32"} (-8.0 cm)
150" (381 cm)	131" (332 cm)	74" (187 cm)	17' 9" (5.4 m)	21' 2" (6.5 m)	-2 ^{3/8"} (-6.0 cm)
133" (338 cm)	116" (294 cm)	65" (166 cm)	15' 9" (4.8 m)	18' 9" (5.7 m)	-2 ^{3/32"} (-5.3 cm)
106" (269 cm)	92" (235 cm)	52" (132 cm)	12' 6" (3.8 m)	14' 11" (4.5 m)	-1 ^{11/16"} (-4.3 cm)
100" (254 cm)	87" (221 cm)	49" (125 cm)	11'10" (3.6 m)	14' 1" (4.3 m)	-1 ^{37/64"} (-4.0 cm)
92" (234 cm)	80" (204 cm)	45" (115 cm)	10'10" (3.3 m)	12' 11" (3.9 m)	-1 ^{15/32"} (-3.7 cm)
84" (213 cm)	73" (186 cm)	41" (105 cm)	9'10" (3.0 m)	11' 9" (3.6 m)	-1 ^{11/32"} (-3.4 cm)
72" (183 cm)	63" (159 cm)	35" (90 cm)	8' 6" (2.6 m)	10' 1" (3.1 m)	-1 ^{9/64"} (-2.9 cm)
60" (152 cm)	52" (133 cm)	29" (75 cm)	6'11" (2.1 m)	8' 4" (2.5 m)	-0 ^{61/64"} (-2.4 cm)
40" (102 cm)	35" (89 cm)	20" (50 cm)	4' 7" (1.4 m)	5' 6" (1.7 m)	-0 ^{41/64"} (-1.6 cm)

The formula for picture size and projection distance

χ: Picture size (diag.) (in)

[Feet, inches]

L1 (ft) = (0.0364χ - 0.06) / 0.3048

L2 (ft) = (0.0434χ - 0.06) / 0.3048

H (in) = - 0.0158χ

[m, cm]

L1 (m) = 0.0364χ - 0.06

L2 (m) = 0.0434χ - 0.06

H (cm) = - 0.0158χ × 2.54

Note

- There may be an error of ± 3% in the above values.
- Values with a minus (-) sign indicate the distance from the lens center below the bottom of the image.





Projecting a Reversed/Inverted Image

Projection from behind the Screen

- Place a translucent screen between the projector and the audience.
- Reverse the image by setting “Rear” in the “PRJ Mode” menu. See page 50 for use of this function.

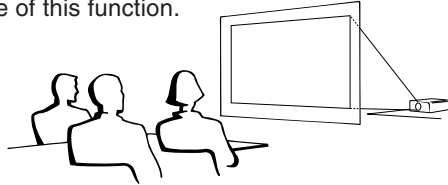

When using the default setting.
▼On-screen Display

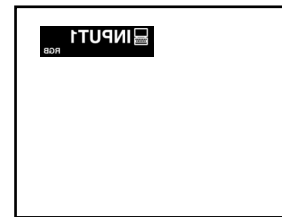

The image is reversed.

Projection Using a Mirror

- Place a mirror (normal flat type) in front of the lens.

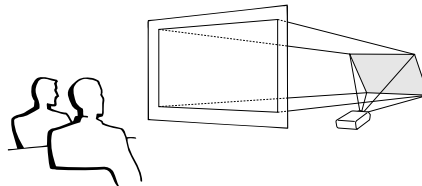

Info

- When using a mirror, be sure to carefully position both the projector and the mirror so the light does not shine into the eyes of the audience.

Ceiling-mount Setup

- It is recommended that you use the optional Sharp ceiling-mount bracket for this installation. Before mounting the projector, contact your nearest Sharp Authorized Projector Dealer or Service Center to obtain the recommended ceiling-mount bracket (sold separately).
 - AN-PGCM95 ceiling-mount bracket, its AN-EP101B extension tube and AN-JT299 universal bracket, adaptor for non-level ceiling installation (for U.S.A.).
 - BB-A10T ceiling adaptor, its BB-NVHOLDER280, BB-NVHOLDER550, BB-NVHOLDER900 ceiling mount systems (for GERMANY).
 - AN-A10T ceiling-mount bracket, its AN-TK201 and AN-TK202 extension tubes (for countries other than the U.S.A. and GERMANY).
- Be sure to adjust the position of the projector to match the distance (H) from the lens center position (see page 24) to the lower edge of the image, when mounting the projector on the ceiling.
- Invert the image by setting “Ceiling+Front” in the “PRJ Mode” menu. See page 50 for use of this function.

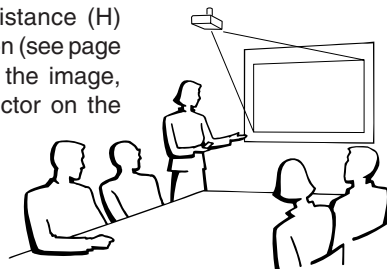

When using the default setting.
▼On-screen Display

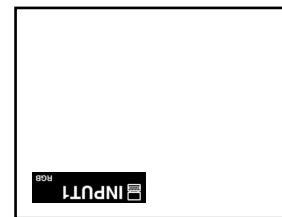

The image is inverted.

Image Projection

Basic Procedure

Connect the required external equipment to the projector before carrying out the following procedures.

Info

- The language preset at the factory is English. If you want to change the on-screen display to another language, reset the language according to the procedure on page 28.

1 Plug the power cord into the wall outlet.

- The power indicator illuminates red, and the projector enters standby mode.

2 Press **ON** (I) on the projector or **ON** (I) on the remote control.

- The power indicator illuminates green. After the lamp indicator illuminates, the projector is ready to start operation.

Note

- The lamp indicator illuminates, indicating the status of the lamp.
 - Green:** The lamp is ready.
 - Blinking in green:** The lamp is warming up or shutting down.
 - Red:** The lamp should be replaced.
- If the projector is put into the standby mode and immediately turned on again, the lamp indicator may take some time to illuminate.
- When controlling the projector using RS-232C commands from a computer, wait for at least 30 seconds after the power has been turned on, and then transmit the commands.

- When "Anti-Theft" (see page 48) is set, the keycode input box will appear. Enter the keycode.

Note

- When entering the keycode, press the buttons previously set on the projector or the remote control.
- For details about the Anti-Theft function, refer to "Anti-Theft (Setting the Anti-Theft)" on page 48.

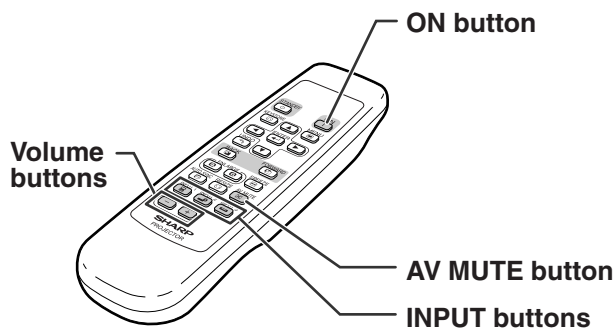
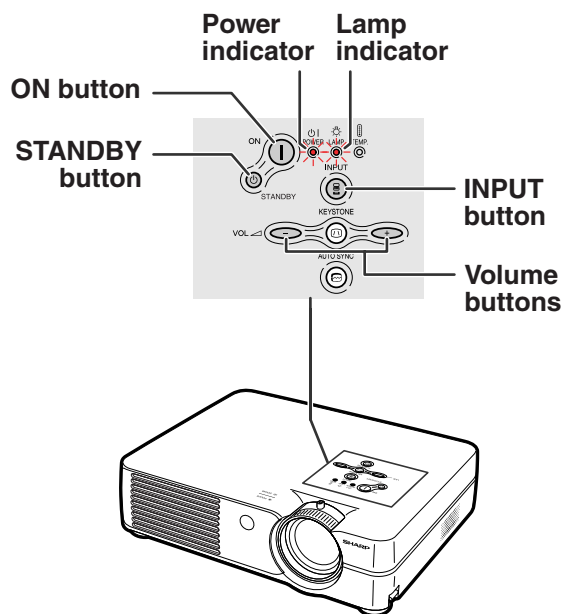



▼Keycode input box





3 Press , or on the remote control to select the INPUT mode.

- After pressing  once on the projector, use  to select the desired input mode.

Note





- When no signal is received, "NO SIGNAL" will be displayed. When a signal that the projector is not preset to receive is received, "NOT REG." will be displayed.
- The INPUT mode is not displayed when "OSD Display" is set to "OFF". (See page 45.)

About the INPUT mode

INPUT 1 (RGB/Component)	Used for projecting images from equipment that sends RGB signals or component signals connected to the RGB input terminal.
INPUT 2 (S-Video)	Used for projecting images from equipment connected to the S-VIDEO input terminal.
INPUT 3 (Video)	Used for projecting images from equipment connected to the VIDEO input terminal.

4 Press or on the remote control to adjust the volume.

Note

- Pressing  will lower the volume. Pressing  will raise the volume.
- On the projector, the volume can be adjusted by pressing  or .

5 Press on the remote control to temporarily display a black screen and turn off the sound.

Note

- Pressing  again will turn the projected image and sound back on.

▼ On-screen Display (Example)

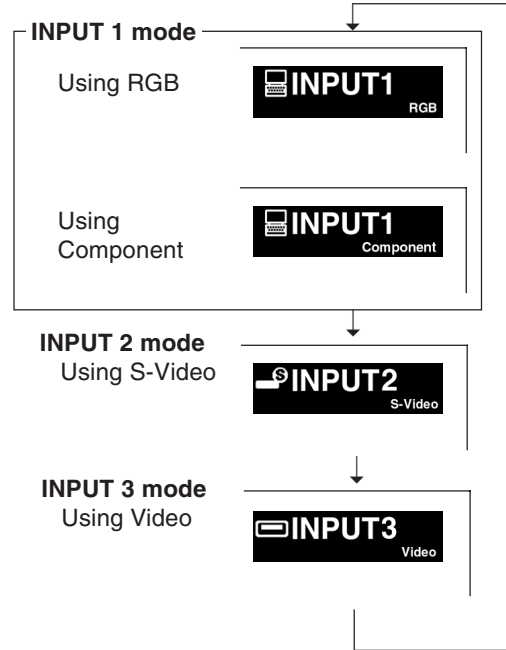







VOLUME



Image Projection

Selecting the On-screen Display Language



The on-screen display language of the projector can be set to English, German, Spanish, Dutch, French, Italian, Swedish, Portuguese, Chinese, Korean or Japanese.

- 1 Press  on the remote control.
 - The "Picture" menu will be displayed.
- 2 Press  or  to select the "Language" menu icon.
 - The "Language" menu will be displayed.
- 3 Press  or  to select the desired language, and then press .
- 4 Press .



"Language" menu icon



Turning the Power off

- 1 Press  on the projector or  on the remote control, then press that button again while the confirmation message is displayed, to put the projector into the standby mode.

Note

- If you accidentally pressed  or  and do not want to put the projector into the standby mode, wait until the confirmation message disappears.
- The projector cannot be operated while a message "Shutting Down. Please Wait." is displayed.

- 2 Unplug the power cord from the AC outlet after the cooling fan stops.

Info

- Do not unplug the power cord during projection or cooling fan operation. This can cause damage due to rise in internal temperature, as the cooling fan also stops.

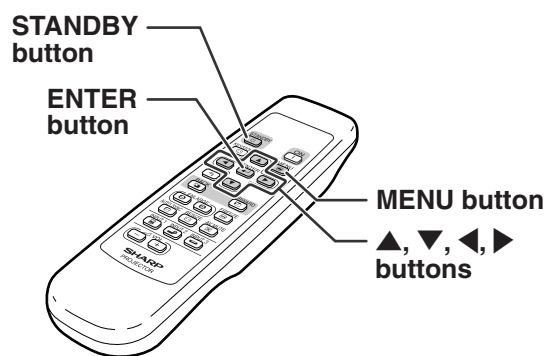

 Enter STANDBY mode?
Yes: Press Again. No: Please Wait.

Shutting Down. Please Wait.

Keystone Correction (Correcting Trapezoidal Distortion)

Correcting Trapezoidal Distortion



This function allows for Keystone (On-screen Trapezoidal Distortion) Correction.

Note



- When the image is projected either from the top or from the bottom towards the screen at an angle, the image becomes distorted trapezoidally.

The function for correcting trapezoidal distortion is called Keystone Correction.

- You can select "Auto" or "Manual" for the Keystone Correction mode. (See page 44.)
- The Keystone Correction can be adjusted up to an angle of approximately $\pm 12^\circ$ when the Keystone Correction mode is set to "Auto", or approximately $\pm 35^\circ$ when set to "manual" (when the picture display mode is set to "NORMAL" (see page 40)). Therefore, the actual screen can be diagonally set up to that angle as well.



- 1 Press  .**
 - You can also use  on the projector.

- 2 Press , ,  and  to adjust the Keystone correction.**

- You can also adjust the Keystone correction using the  or  buttons on the projector.

Note

- Press  to make the default setting.
- Straight lines or the edges of images may appear jagged while adjusting the image.

- 3 Press  .**
 - You can also use  on the projector.

Note

- You can use the same settings used in NORMAL mode 4:3 for 16:9.

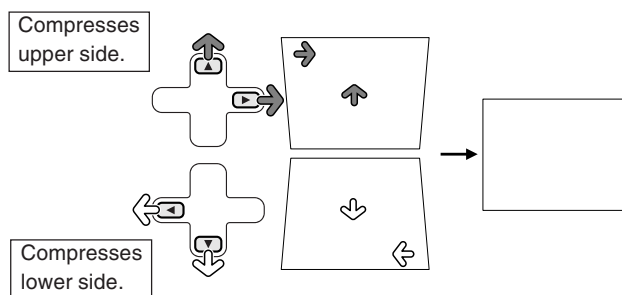
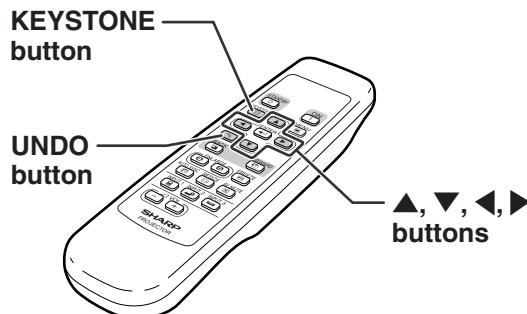



Menu Items

This list shows the items that can be set in the projector.

INPUT 1 Mode

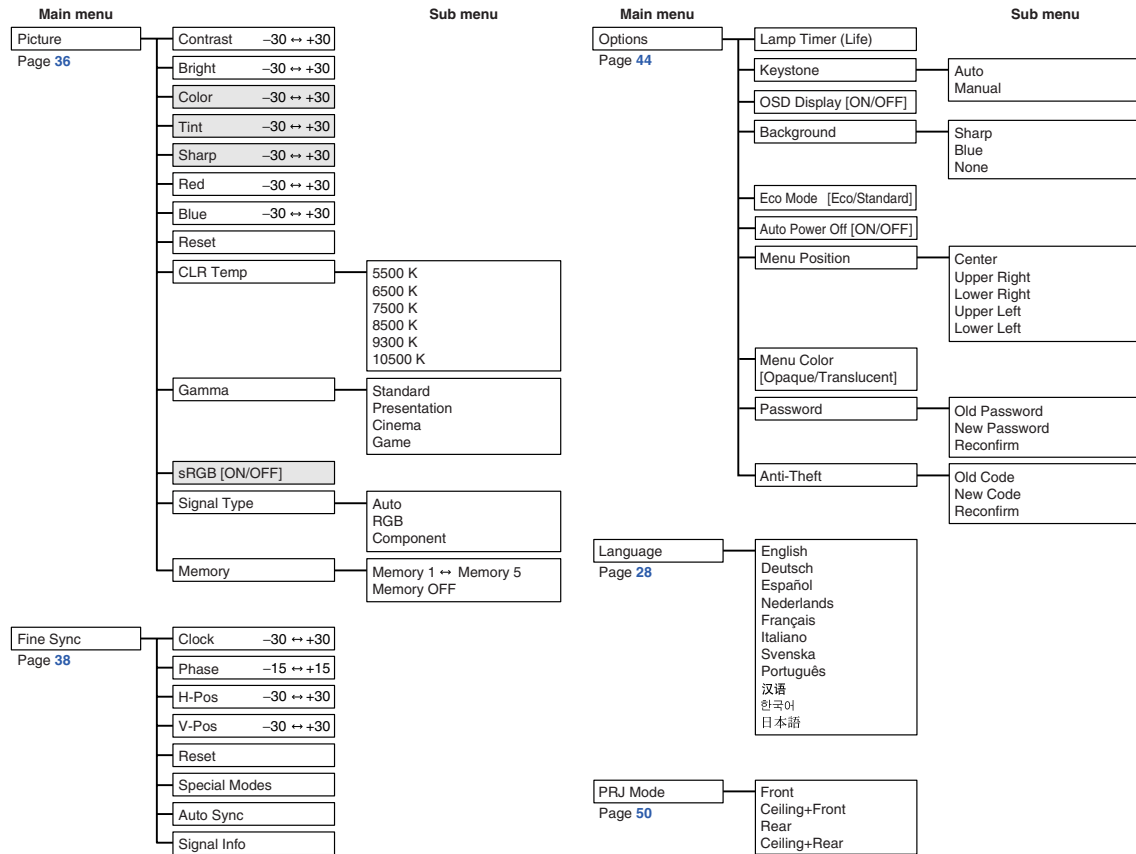

Note

- In the “Picture” menu of INPUT 1, “Color”, “Tint” and “Sharp” are only displayed when “Signal Type” is set to “Component” or set to “Auto” and the input signal is recognized as a component signal.
- In the “Picture” menu of INPUT 1, “sRGB” is only displayed when “Signal Type” is set to “RGB” or set to “Auto” and the input signal is recognized as an RGB signal.





INPUT 2 / 3 Mode

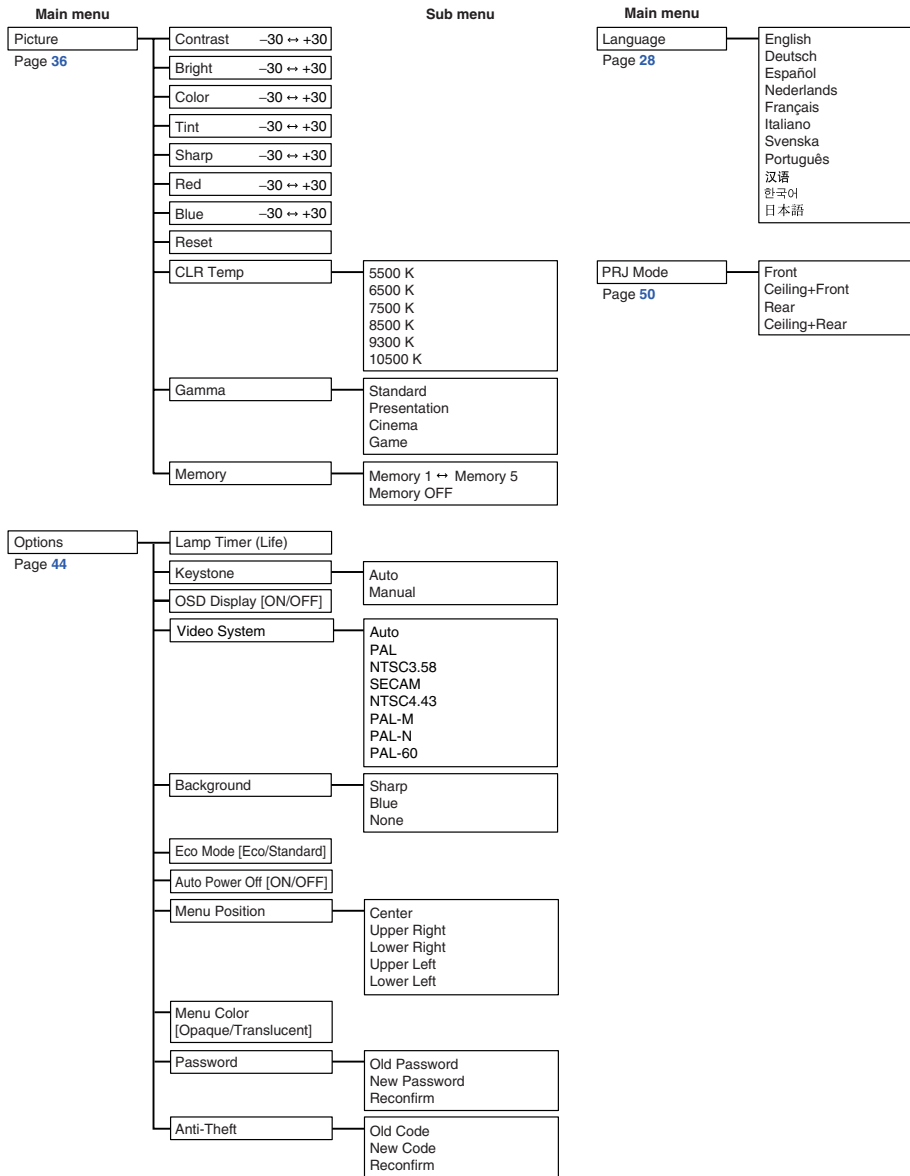

Using the Menu Screen

The menu screens allow you to adjust the image and various projector settings. You can operate the menus from the remote control using the following procedure.

Example: “Picture” menu screen for INPUT 1 (RGB) mode

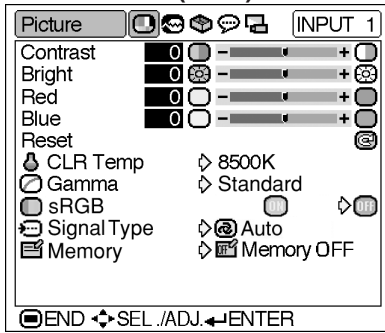

Menu Selections

(Adjustments)

1 Press .

- The “Picture” menu screen for the selected input mode is displayed.



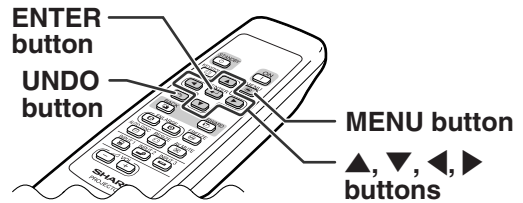

 **Note**

- The on-screen display shown on the right is displayed when the INPUT 1 (RGB) mode is selected.



2 Press  or  to display the other menu screens.

- The menu icon for the selected menu screen is highlighted.

Menu icon	Menu screen
	Picture
	Fine Sync
	Options
	Language
	PRJ Mode

 **Note**

- The “Fine Sync” menu is not available for INPUT 2 or 3.
- For details on the menus, see the tree charts on pages 30 and 31.

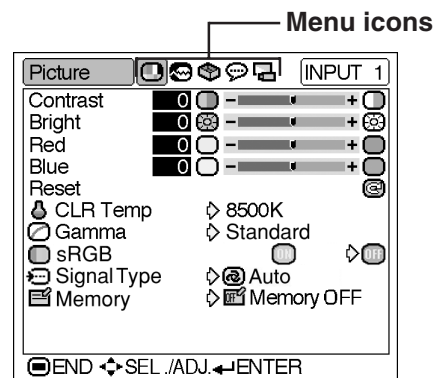





3 Press ▲ or ▼ to select the item you want to adjust.

- The selected item is highlighted.

Note

- To display a single adjustment item, press  after selecting the item. Only the selected adjustment item will be displayed. Then if you press ▲ or ▼, the following item ("Red" after "Bright") will be displayed.
- Press  to return to the previous screen.

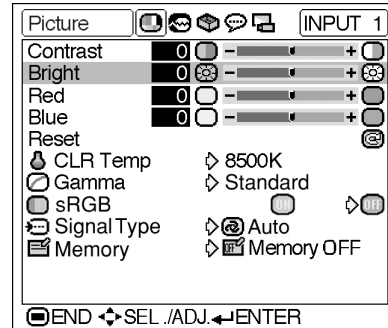

4 Press ◀ or ▶ to adjust the item selected.

- The adjustment is stored.

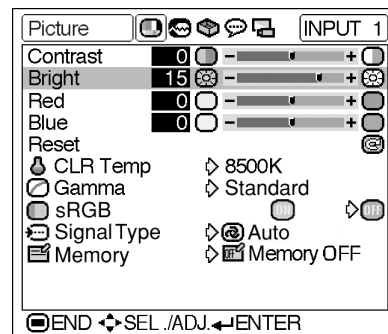

5 Press .

- The menu screen will disappear.

Using the Menu Screen

Menu Selections

(Settings)

1 Press .

- The "Picture" menu screen for the selected input mode is displayed.



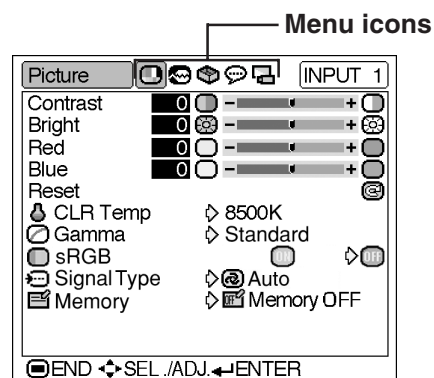
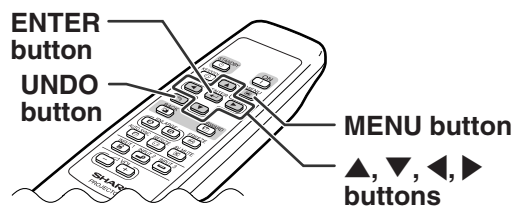

Note

- The on-screen display shown on the right is displayed when INPUT 1 (RGB) mode is selected.



2 Press or to display the other menu screens.

- The menu icon for the selected menu screen is highlighted.

Menu icon	Menu screen
	Picture
	Fine Sync
	Options
	Language
	PRJ Mode

Note

- The "Fine Sync" menu is not available for INPUT 2 or 3.
- For details on the menus, see the tree charts on pages 30 and 31.

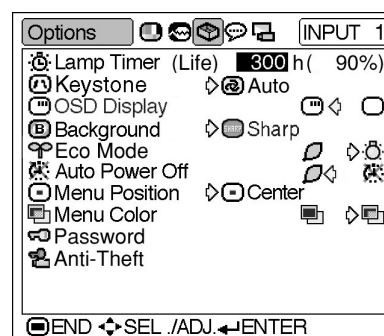



3 Press ▲ or ▼ to select the item you want to set, and then press ► to display the sub menu.

- The selected item is highlighted.

Note

- Press UNDO (undo icon) or ◀ to return to the previous screen.
- For some items, press ◀ or ▶ to select the icon using “→”.

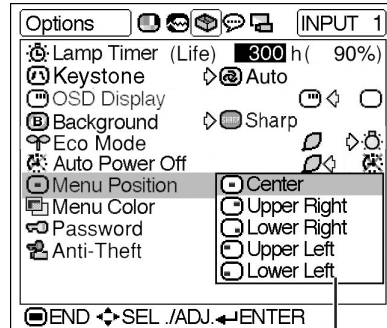

Sub menu

4 Press ▲ or ▼ to select the setting of the item displayed in the sub menu.

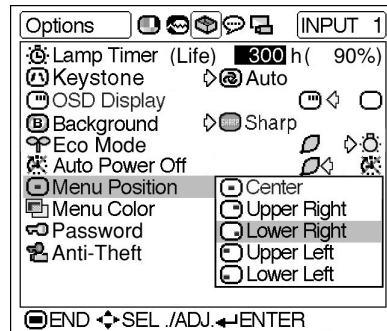

5 Press ENTER (enter icon).

- The item selected is set.

6 Press MENU (menu icon).

- The menu screen will disappear.



Picture Adjustment

You can adjust the projector's picture to your preferences using the "Picture" menu. For operation of the menu screen, see pages 32 to 35.

Example: "Picture" screen menu for INPUT 1 (RGB) mode

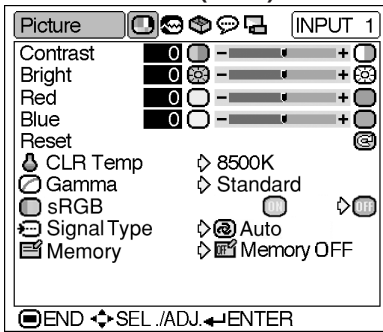

Adjusting the Image

Select the item on the "Picture" menu and adjust the image.

Description of Adjustment Items

Selectable items	Press ◀	Press ▶
Contrast	for less contrast.	for more contrast.
Bright	for less brightness.	for more brightness.
Color	for less color intensity.	for more color intensity.
Tint	for making skin tones purplish.	for making skin tones greenish.
Sharp	for less sharpness.	for more sharpness.
Red	for weaker red.	for stronger red.
Blue	for weaker blue.	for stronger blue.

Note

- "Color", "Tint" and "Sharp" are not displayed when selecting INPUT 1 and setting the "Signal Type" to "RGB" or setting the "Signal Type" to "Auto" and the input signal is recognized as an RGB signal.
- "Sharp" can be adjusted when 480I, 480P, 540P, 580I, 580P, 720P, 1035I or 1080I signals are detected while "Signal Type" for INPUT 1 is set to "Component" or set to "Auto" and the input signal is recognized as a component signal.
- To reset all adjustment items, select "Reset" and press .

CLR Temp (Adjusting the Color Temperature)

Select "CLR Temp" on the "Picture" menu and the desired color temperature setting.

Description of Color Temperature Settings

Selectable settings	Description
5500K	For lower color temperature for warmer, reddish incandescent-like images.
6500K	
7500K	
8500K	
9300K	For higher color temperature for cooler, bluish, fluorescent-like images.
10500K	

Note

- Values for "CLR Temp" are only approximations.



Gamma (Gamma Correction)

Gamma is an image quality enhancement function that offers a richer image by brightening the darker portions of the image without altering the brightness of the brighter portions.

When you are displaying images with frequent dark scenes, such as a film or concert, or when you are displaying images in a bright room, this feature makes the dark scenes easier to see and gives the impression of greater depth in the image.

Select “Gamma” on the “Picture” menu and the desired gamma mode.

Standard
Presentation
Cinema
Game

Description of Gamma Modes

Selectable settings	Description
Standard	For standard image
Presentation	Brightens darker portions of image for more enhanced presentations.
Cinema	Gives greater depth to darker portions of image for a more exciting theater experience.
Game	For natural color gradation for playing a game, etc.

Note

- Gamma is not available for INPUT 1 when “sRGB” on the “Picture” menu is set to “ON”.

sRGB (sRGB Setting)

Select “sRGB” on the “Picture” menu and set it to “ (ON)” when you want to display the image in a natural tint based on an original image.

Note

- When “sRGB” is set to “ON”;
 - Gamma is not available.
 - “Red”, “Blue” or “CLR Temp” on the “Picture” menu cannot be adjusted.
- For additional information about the sRGB function, visit “<http://www.srgb.com/>”.

Info

- When “sRGB” is set to “ON”, the projected image may become dark, but this does not indicate a malfunction.

Signal Type (Signal Type Setting)

The signal type setting is preset to “Auto”; however, in rare cases a clear picture may not be displayed. In that case, select “RGB” or “Component” in accordance with the input signal.

Select “Signal Type” on the “Picture” menu and set it to “Auto”, “RGB” or “Component” for INPUT 1.

Description of Signal Type Settings

Selectable settings	Description
Auto	Input signals are automatically recognized as RGB or Component.
RGB	Set when RGB signals are received.
Component	Set when Component signals are received.

Memory (Storing and Selecting the Adjustment Settings)

Use this function to store the adjustment settings on the “Picture” menu. No matter which input mode or signal type is selected, you can select and apply the settings you have stored in a memory location.

Select “Memory” on the “Picture” menu and the memory location where you want to store the settings. Then adjust the setting items on the “Picture” menu.

Description of Memory Positions

Selectable settings	Description
Memory 1	Settings of all items on the “Picture” menu can be stored in memory location.
Memory 2	The stored settings can be selected in any input mode.
Memory 3	
Memory 4	
Memory 5	
Memory OFF	Besides “Memory 1” to “Memory 5”, other settings on the “Picture” menu can be stored for each input mode. The settings stored in “Memory OFF” cannot be applied when another input mode is selected.

If you want to apply the stored settings on the “Picture” menu, select “Memory” on the “Picture” menu and the memory location where you have stored the settings.

Note

- You can change the stored settings after selecting the memory location for those settings.



Computer Image Adjustment

Using the “Fine Sync” menu, you can adjust the computer image, match the computer display mode, and check the input signal. For operation of the menu screen, see pages 32 to 35.

Example: “Fine Sync” menu screen for INPUT 1 mode

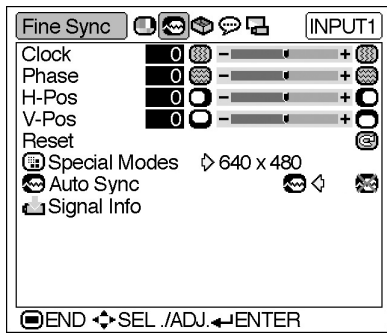

Adjusting the Computer Image

When “Auto Sync” is set to OFF or when vertical stripes or flickering occur in portions of the screen even if “Auto Sync” is set to ON, adjust “Clock”, “Phase”, “H-Pos” or “V-Pos” to obtain the best computer image.

Select the item on the “Fine Sync” menu and adjust the computer image.

Description of Adjustment Items

Selectable items	Use ◀ and ▶ to
Clock	adjust vertical noise.
Phase	adjust horizontal noise (similar to tracking on your VCR).
H-Pos	center the on-screen image by moving it to the left or right.
V-Pos	center the on-screen image by moving it up or down.

Note

- You can automatically adjust the computer image by setting “Auto Sync” on the “Fine Sync” menu or pressing the AUTO SYNC button. See next page for details.
- To reset all adjustment items, select “Reset” and press .

Special Modes (Special Mode Settings)

Ordinarily, the type of input signal is detected and the correct resolution mode is automatically selected. However, for some signals, the optimal resolution mode in “Special Modes” on the “Fine Sync” menu may need to be selected to match the computer display mode.

Select “Special Modes” on the “Fine Sync” menu and the appropriate resolution.

Note

- Avoid displaying computer patterns which repeat every other line (horizontal stripes). (Flickering may occur, making the image hard to see.)
- When a DVD player or Digital Video is connected, select 480P as the input signal.
- See “Signal Info (Checking the Input Signal)” on the next page for information on the currently selected input signal.





Auto Sync (Auto Sync Adjustment)



Used to automatically adjust a computer image.

Select “Auto Sync” on the “Fine Sync” menu and set it to “” (ON) or “” (OFF).

Description of Auto Sync Adjustment

Selectable Settings	Description
 ON	Auto Sync adjustment will occur when the projector is turned on or when the input signals are switched, when connected to a computer.
 OFF	Auto Sync adjustment is not automatically performed.

Note

- Auto Sync adjustment is also performed by pressing  on the projector or  on the remote control.
- The Auto Sync adjustment may take some time to complete, depending on the image of the computer connected to the projector.
- When the optimum image cannot be achieved with Auto Sync adjustment, use manual adjustments. (See page 38.)

Signal Info (Checking the Input Signal)

Select “Signal Info” on the “Fine Sync” menu to check the current input signal information.

Note

- The projector will display the number of scanned lines available from audio-visual equipment such as a DVD player or Digital Video.

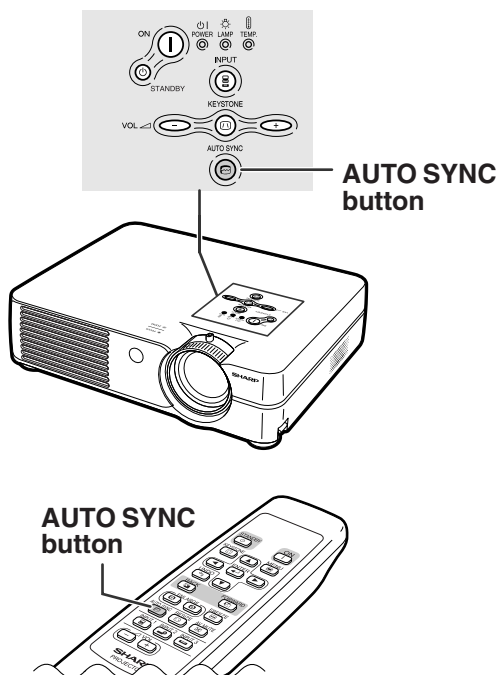



Picture Display Mode

This function allows you to modify or customize the picture display mode to enhance the input image. Depending on the input signal, you can choose “NORMAL”, “DOT BY DOT”, “BORDER” or “STRETCH” image.

Switching the Picture Display Mode

Press .

- Pressing changes the display as shown on pages 40 and 41.
- To return to the standard image, press while “RESIZE” is displayed on the screen.

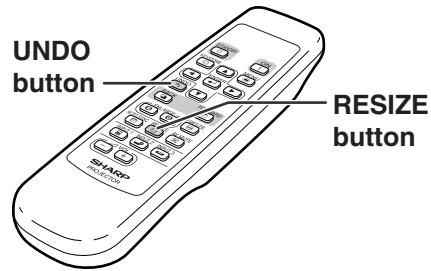

COMPUTER

		NORMAL	DOT BY DOT	BORDER	STRETCH
4:3 aspect ratio	SVGA (800 × 600)	1024 × 768	800 × 600	768 × 576	1024 × 576
	XGA (1024 × 768)		—		
	SXGA (1280 × 960)		1280 × 960		
	SXGA+ (1400 × 1050)		1400 × 1050		
Other aspect ratios	SXGA (1280 × 1024)	960 × 768	1280 × 1024	720 × 576	960 × 576
	1280 × 720	—	—	—	1024 × 576

Input Signal		Output screen image			
Computer	Image type	NORMAL Projects a full screen image while maintaining the aspect ratio.	DOT BY DOT Projects the original resolution signal of the image.	BORDER Projects 4:3 image fully in STRETCH (the following column) image.	STRETCH Projects 16:9 image evenly over entire screen (top/bottom blank bands).
Resolution lower than XGA	 4:3 aspect ratio	*	*	*	
XGA	 4:3 aspect ratio	*	—	*	
Resolution higher than XGA	 4:3 aspect ratio	*		*	
SXGA (1280 × 1024)	 5:4 aspect ratio	*		*	
1280 × 720	 16:9 aspect ratio	—	—	—	*

* Mode for projecting an image with the original aspect ratio without cutting any portions.

: Cutout area on which images cannot be projected.
 : Area where the signals are off screen.







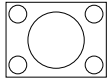
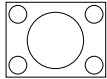
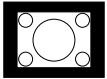
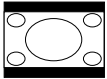
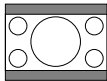
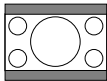
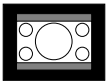
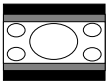
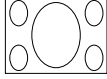
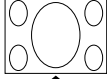
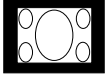
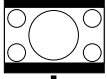
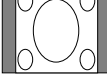
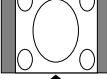
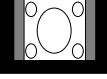
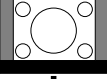
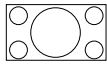
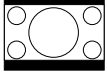

VIDEO

		NORMAL	BORDER	STRETCH
480I, 480P, NTSC, PAL, SECAM	4:3 aspect ratio. Letter box, squeeze	1024 × 768	768 × 576	1024 × 576
540P, 720P, 1080I	16:9 aspect ratio	—	—	

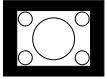
• “STRETCH” is fixed when 540P, 720P or 1080I signals are entered.

Input Signal		Output screen image		
		NORMAL Projects a full screen image.	BORDER Projects 4:3 image fully in STRETCH (the following column) image.	STRETCH Projects 16:9 image evenly over entire screen (top/bottom black bands).
DVD / Video	Image type			
480I, 480P, NTSC, PAL, SECAM	 4:3 aspect ratio	* 	* 	
	 Letter box	* 	* 	
	 Squeezed 16:9 image			* 
	 Squeezed 4:3 image			* 
540P, 720P, 1080I (16:9)	 16:9 aspect ratio	—	—	* 
	 16:9 aspect ratio (4:3 aspect ratio in 16:9 screen)	—	—	* 

* Mode for projecting an image with the original aspect ratio without cutting any portions.

 : Cutout area on which images cannot be projected.

 : Area on which the image is not included in the original signals.

Still and Zoom Image

You can instantly freeze a moving image and enlarge a specific portion of an image with the remote control. Using these functions, you can explain the image to the audience more effectively.

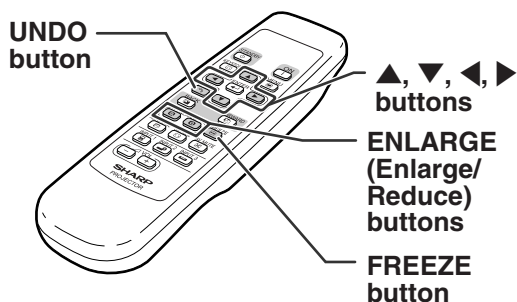

Freezing a Moving Image

- 1 Press .
 - The projected image is frozen.

- 2 Press again to return to the moving image from the currently connected device.

Displaying an Enlarged Portion of an Image

- 1 Press .
 - Pressing or enlarges or reduces the projected image.

Note

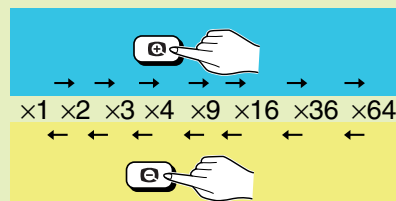

- You can change the location of the enlarged image using ▲, ▼, ◀ and ▶.

- 2 Press to cancel the operation.
 - The magnification then returns to x1.

Note

- In the following cases, the image will return to the normal size (x1).
- When switching the INPUT mode.
 - When has been pressed.
 - When the input signal is changed.
 - When the input signal resolution and refresh rate (vertical frequency) change.

Keylock Function

Use this function to lock the operation buttons on the projector.

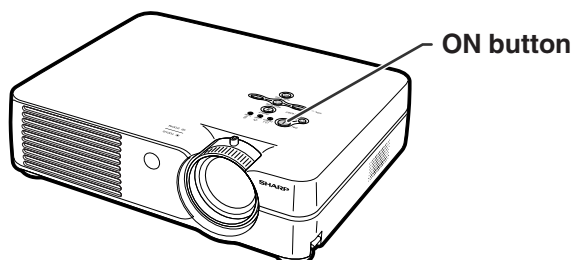

Locking the Operation Buttons

Hold down ^{ON}  on the projector for about 3 seconds while the projector is being turned on.

Note

- The keylock function does not affect the operation with the remote control buttons.
- You cannot use the keylock function while the projector is warming up or shutting down.

Keylock function ON

Taking the Keylock off

Hold down ^{ON}  on the projector for about 3 seconds.

Note

- The keylock function does not affect the operation with the remote control buttons.
- You cannot use the keylock function while the projector is warming up or shutting down.

Keylock function OFF

Using the “Options” Menu

You can use the “Options” menu to enhance the usage for the projector. For operation of the menu screen, see pages 32 to 35.

Example: “Options” menu screen for INPUT 2 (S-Video) mode

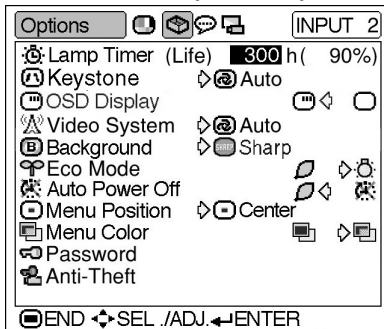

Lamp Timer (Life) (Checking the Lamp Life Status)

You can confirm the cumulative lamp usage time and the remaining lamp life (percentage).

Display the “Options” menu to check the lamp life status.

Description of Lamp Life

Lamp usage condition	Remaining lamp life	
	100%	5%
Used with only “” (Eco mode) in “Eco Mode”	4,500 hours	about 225 hours
Used with only “” (Standard mode) in “Eco Mode”	3,000 hours	about 150 hours

Note

- It is recommended that the lamp be changed when the remaining lamp life becomes 5%. For lamp replacement, contact your nearest Sharp Authorized Projector Dealer or Service Center.
- The table above indicates rough estimates in the case of using only in each mode shown. Remaining lamp life changes within the range of the values shown depending on the frequency at which “Eco Mode” is switched to “” (Eco mode) and “” (Standard mode) (see page 45).

Keystone (Setting the Keystone Correction Mode)

Select “Keystone” on the “Options” menu and the desired mode for the Keystone Correction.



Description of Keystone Correction Mode

Selectable settings	Description
<input checked="" type="radio"/> Auto	Keystone Correction is automatically performed.
<input type="radio"/> Manual	Keystone Correction can be adjusted manually.

Note

- If you want to adjust the Keystone Correction manually, see page 29.
- The Keystone Correction can be adjusted up to an angle of approximately $\pm 12^\circ$ when the Keystone Correction mode is set to “Auto”, or approximately $\pm 35^\circ$ when set to “manual” (when the picture display mode is set to “NORMAL” (see page 40)).





OSD Display (Setting On-screen Display)

This function allows you to turn the on-screen messages on or off.

Select “” (ON) or “” (OFF) in “OSD Display” on the “Options” menu.

Description of “OSD Display” Settings









Selectable settings	Description
 ON	All On-screen Displays are displayed.
 OFF	INPUT/VOLUME/AV MUTE/FREEZE/AUTO SYNC/ENLARGE/ “An invalid button has been pressed.” / **All buttons on Projector are locked.” are not displayed.

*Displayed when the STANDBY button is pressed.





Video System (Setting the Video System)

The video input system mode is preset to “Auto”; however, a clear picture from the connected audio-visual equipment may not be received, depending on the video signal difference. In that case, switch the video signal.

Select “Video System” on the “Options” menu and the appropriate video system.

 Auto
 PAL
 NTSC3.58
 SECAM
 NTSC4.43
 PAL-M
 PAL-N
 PAL-60

Description of Video Systems

Selectable settings	Description
 PAL	When connected to PAL video equipment.
 SECAM	When connected to SECAM video equipment.
 NTSC4.43	When reproducing NTSC signals in PAL video equipment.
 NTSC3.58	When connected to NTSC video equipment.

Note



- The video signal can only be set in INPUT 2 or INPUT 3 mode.
- In “Auto”, images are displayed in PAL even if PAL-N or PAL-M input signals are received.

Background (Selecting a Startup and Background Image)

Select “Background” on the “Options” menu and the image displayed upon the projector’s startup and when no signal is being sent to the projector.

 Sharp
 Blue
 None



Description of Background Images

Selectable settings	Description
 Sharp	SHARP default image
 Blue	Blue screen
 None	Black screen



Note

- If the input signal has interference, the screen will be displayed during interference.



Eco Mode (Setting the Eco Mode)

Select “” (Eco Mode) or “” (Standard Mode) in “Eco Mode” on the “Options” menu.

Description of Eco Mode

Selectable settings	Brightness	Power consumption (When using AC 110V)	Lamp life
 (Eco mode)	80%	190 W	4,500 hours
 (Standard mode)	100%	240 W	3,000 hours

Note

- Although lamp life and noise are improved when “Eco Mode” is set to “” (Eco mode), brightness decreases by 20%.
- “Eco Mode” mode is factory preset to “” (Standard mode).

Using the “Options” Menu

Example: “Options” menu screen for INPUT 2 (S-Video) mode

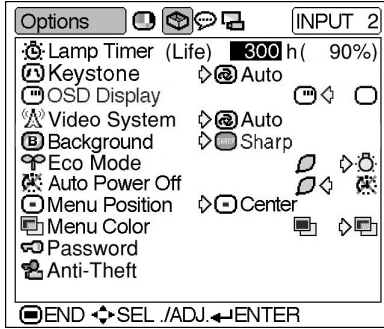

Auto Power Off (Auto Power Off Function)

When no input signal is detected for more than 15 minutes, the projector will automatically enter the standby mode if set to “ON”.

The Auto Power Off function will be disabled if it has been set to “OFF”.

Select “” (ON) or “” (OFF) in “Auto Power Off” on the “Options” menu.

Note



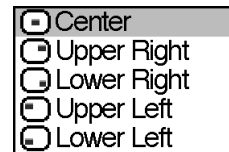

- When the Auto Power Off function is set to “ON”, 5 minutes before the projector enters the standby mode, the message “Enter STANDBY mode in X min.” will appear on the screen to indicate the remaining minutes before power off.

Menu Position (Selecting the Menu Screen Position)



Select “Menu Position” on the “Options” menu and the desired position for the menu screen.





Description of Menu Positions

Selectable settings	Description
 Center	Displayed on the center of the image.
 Upper Right	Displayed on the upper right of the image.
 Lower Right	Displayed on the lower right of the image.
 Upper Left	Displayed on the upper left of the image.
 Lower Left	Displayed on the lower left of the image.

Menu Color (Selecting the Menu Color)

Select “” (Opaque) or “” (Translucent) in “Menu Color” on the “Options” menu.

Description of Menu Colors

Selectable settings	Description
 Opaque	The menu is displayed opaquely.
 Translucent	The menu is displayed translucently. The part of the menu on the image becomes transparent.





Password (Setting a Password)

A password must be set to activate the “Anti-Theft” function (Page 48).

There is no factory preset for the password or the “Anti-Theft” settings. In this way, anyone can freely set a new password and “Anti-Theft” settings. It is therefore recommended that even if you do not want to use the “Anti-Theft” function, you at least set a password to prevent others from setting the “Anti-Theft” function.

A password can only be set by using the remote control.

Select “Password” on the “Options” menu, then press  and follow the procedure below to enter the password.

Password				
Old Password	-	-	-	-
New Password	-	-	-	-
Reconfirm	-	-	-	-
 END				

1 Press  or  to select the desired number and then press .

2 Enter the 3 remaining digits and press .

3 Enter the password again in “Reconfirm” and press .



Note

- When a password is set, you need to enter the password to change the “Anti-Theft” setting.

If you want to change the password, follow the procedure below.



Password				
Old Password	-	-	-	-
New Password	-	-	-	-
Reconfirm	-	-	-	-
 END				

1 Press ,  and  to enter the password in “Old Password” and press .

2 Press ,  and  to set the new password and press .









3 Enter the new 4-digit password again in “Reconfirm” and press .

Note

- If you do not want to set a password, leave the fields in steps 2 and 3 blank and press .
- To cancel the password settings, press .

If You Forget Your Password

If you forget the password, delete it using the following procedure and set a new password.

Press   →  →  →  →  →  → .

Note

- You can only use the buttons on the projector to delete the password.
- The password cannot be deleted using the above described procedures while the “Anti-Theft” function is set. If you forget your password while the “Anti-Theft” function is activated, you will need to contact your nearest Sharp Authorized Projector Dealer or Service Center (see page 65). You may need to bring your projector to them to restore the projector to original factory condition (password and keycode reset).

Using the “Options” Menu

Example: “Options” menu screen for INPUT 2 (S-Video) mode

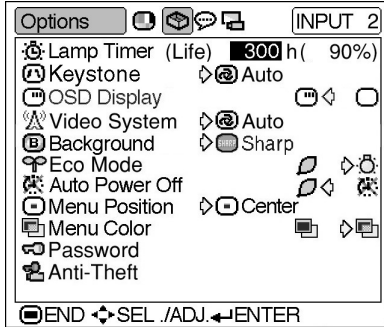

Anti-Theft (Setting the Anti-Theft)

The anti-theft function prevents unauthorized use of the projector. You can choose to use this function or not. If you do not want to use this function, just do not enter the keycode. Once the anti-theft function is activated, users will need to enter the correct keycode each time the projector is turned on. Failure to enter the correct keycode will cause images to not be projected. The following procedures explain how to use this function.

Select “Anti-Theft” on the “Options” menu, then press  and follow the procedure below to enter the keycode.

Anti-Theft				
Old Code	-	-	-	-
New Code	-	-	-	-
Reconfirm	-	-	-	-
				

Note

- “Anti-Theft” cannot be selected unless “Password” is set. (See page 47.)
- When “Anti-Theft” is selected, the password input box will appear. Enter the keycode after the right password is entered.

Info

- Once the function is activated, you must remember the correct keycode. We suggest you record the keycode in a safe place where only authorized users have access. If you lose or forget your keycode, you will need to contact your nearest Sharp Authorized Projector Dealer or Service Center (see page 65). You may need to bring your projector to them to restore the projector to original factory condition (password and keycode reset).

1 Press any button you like on the remote control or projector to set the first digit in “New Code”.

Note

- The following buttons on the remote control and projector cannot be set as keycodes:
 - ON button
 - STANDBY button
 - ENTER button
 - UNDO button
 - MENU button
 - FORWARD button
 - BACK button

2 Enter the remaining 3 digits by pressing any buttons you like.

3 Enter the same keycode once more in “Reconfirm”.

Info

When “Anti-Theft” is set, the keycode inputting box appears after the power is turned on. When it appears, enter the right keycode.

- Press the buttons on the remote control if the buttons on the remote control are used for setting the keycode. In the same manner, press the buttons on the projector if the buttons on the projector are used for setting the keycode.

If you want to change the keycode, follow the procedure below.

Anti-Theft				
Old Code	—	—	—	—
New Code	—	—	—	—
Reconfirm	—	—	—	—
 END				

 Note

- When “Anti-Theft” is selected, the password input box will appear. After the password has been entered, you can change the keycode.

1 Press the buttons on the remote control or the projector to enter the preset 4-digit keycode in “Old Code”.

2 Press any button you like on the remote control or the projector to enter the new keycode.

3 Enter the same 4-digit keycode in “Reconfirm”.

 Note

- If you do not want to set a keycode, leave the keycode field blank in steps 2 and 3 and press





Reversing/Inverting Projected Images

You can reverse or invert the projected image for various applications using the “PRJ Mode” menu. For operation of the menu screen, see pages 32 to 35.

Example: “PRJ Mode” menu screen for INPUT 1 (RGB) mode

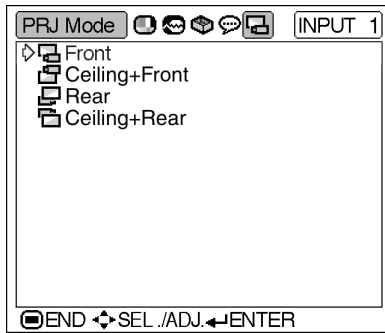

Setting the Projection Mode

Display the “PRJ Mode” menu and select the desired projection mode.

Description of Projection Modes

Selectable settings	Description
Front	Normal image
Ceiling+Front	Inverted image
Rear	Reversed image
Ceiling+Rear	Reversed and inverted image

Note

- This function is used for the reversed image and ceiling-mount setups. See page 25 for these setups.

Carrying the Projector

How to Use the Carrying Case

When carrying the projector, attach the lens cap to the lens, and place it in the supplied carrying case.

1 Open the cover of the carrying case.

2 Remove the inner padding from the carrying case, and fold it in the direction of the arrows.

3 Reinsert the inner padding into the carrying case.

Info

- Be sure to insert the inner padding to protect the lens and the projector.

4 Place the projector and the accessories in the carrying case.

Info

- Be sure to attach the lens cap to protect the lens.
- Be sure the projector has cooled down sufficiently before placing it in the case.

Info

- This carrying case is only for storing and carrying the projector.
- Sending the projector in the carrying case as a parcel may cause damage to the projector. If you send the projector in the carrying case as a parcel, be sure to place it in a sturdy case and with enough shock absorbing material to avoid any damage.
- Do not expose the carrying case or projector to direct sunlight, near heat sources, or leave them in a car. The carrying case or projector may change color or become deformed.

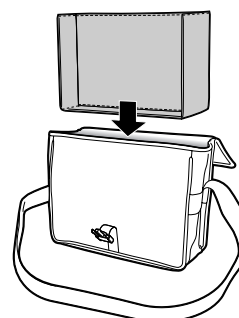
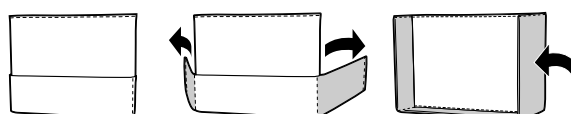
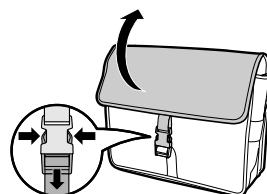

Lens cap

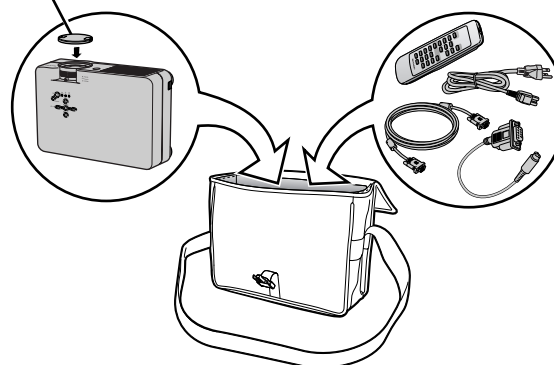

Adjust the shoulder strap.

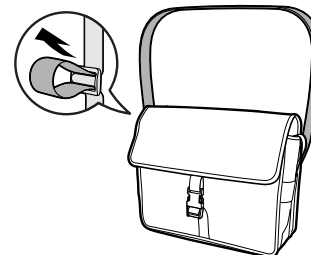



Maintenance

Cleaning the projector

- Be sure to unplug the power cord before cleaning the projector.
- The cabinet as well as the operation panel is made of plastic. Avoid using benzene or thinner, as these can damage the finish on the cabinet.
- Do not use volatile agents such as insecticides on the projector.
Do not attach rubber or plastic items to the projector for a long time.
The effects of some of the agents in the plastic may cause damage to the quality or finish of the projector.

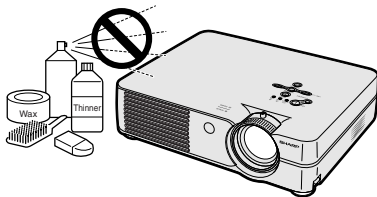

- Wipe off dirt gently with a soft flannel cloth.

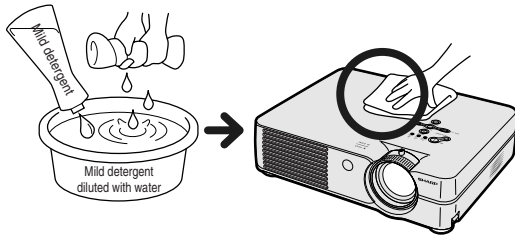

- When the dirt is hard to remove, soak a cloth in a mild detergent diluted with water, wring the cloth well and then wipe the projector.
Strong cleaning detergents may discolor, warp or damage the coating on the projector.
Make sure to test on a small, inconspicuous area on the projector before use.

Cleaning the lens

- Use a commercially available blower or lens cleaning paper (for glasses and camera lenses) for cleaning the lens. Do not use any liquid type cleaning agents, as they may wear off the coating film on the surface of the lens.
- As the surface of the lens can easily get damaged, be sure not to scrape or hit the lens.

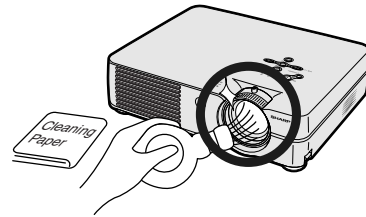

Cleaning the exhaust and intake vents

- Use a vacuum cleaner to clean dust from the exhaust vent and the intake vent.

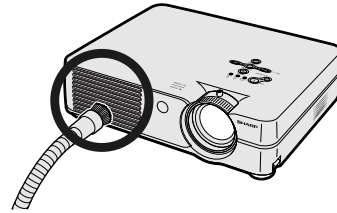

Replacing the Air Filter

- This projector is equipped with air filters to ensure the optimal operating condition of the projector.
- The air filters should be cleaned every 100 hours of use. Clean the filters more often when the projector is used in a dusty or smoky location.
- Ask your nearest Sharp Authorized Projector Dealer or Service Center to exchange the filter (PFILDA008WJZZ) when it is no longer possible to clean.

▼ Bottom view

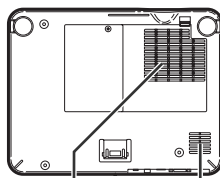

Air filter

Air filter
(not removable)

▼ Rear view



Air filter
(not removable)

Cleaning and Replacing the Air Filter

- 1 Press  on the projector or  on the remote control to put the projector into the standby mode.**

- Wait until the cooling fan stops.

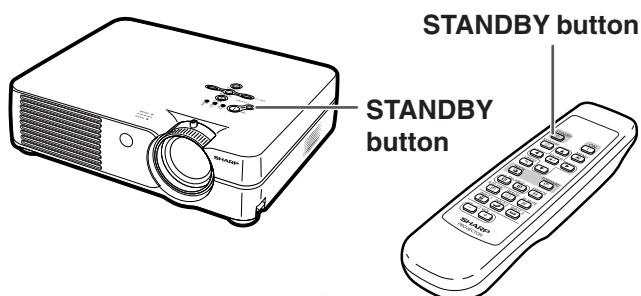

- 2 Disconnect the power cord.**
 - Unplug the power cord from the AC socket.

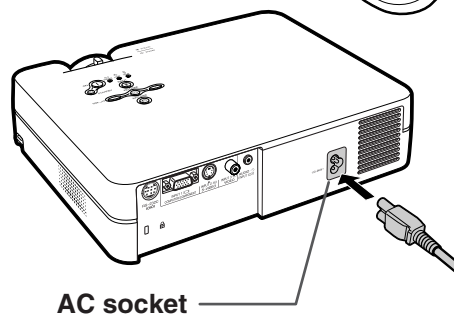

- 3 Remove the filter/lamp unit cover.**

- Turn the projector over. Loosen the user service screw (①) that secures the filter/lamp unit cover. Pressing the tab (②), remove the filter/lamp unit cover (③).

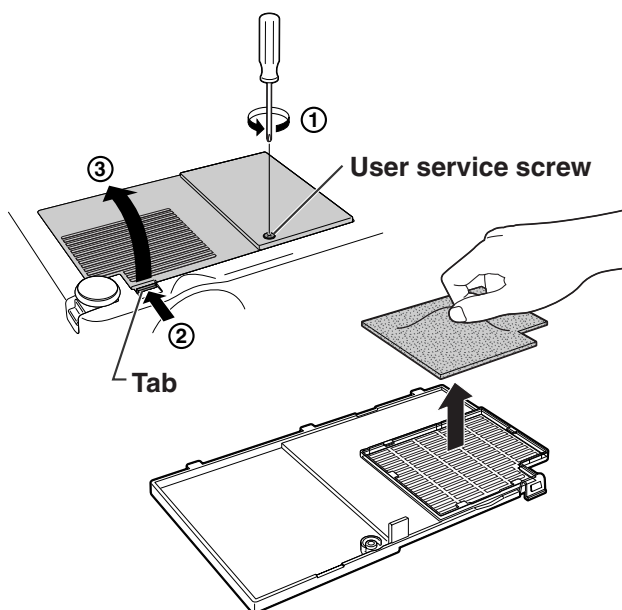

- 4 Remove the air filter.**
 - Pick the air filter up with your fingers and lift it out of the filter/lamp unit cover.



Replacing the Air Filter

5 Clean the air filter.

- Clean the dust off the air filter and cover with a vacuum cleaner extension hose.

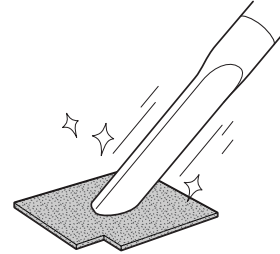

6 Replace the air filter.

- Place the air filter underneath the tabs on the filter/lamp unit cover.

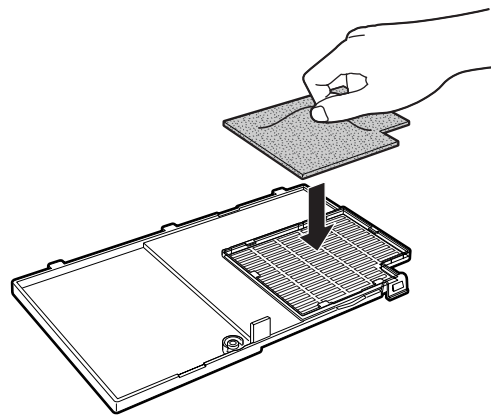

7 Replace the filter/lamp unit cover.

- Align the tab on the filter/lamp unit cover (①) and place it while pressing the tab (②) to close it. Then tighten the user service screw (③) to secure the filter/lamp unit cover.

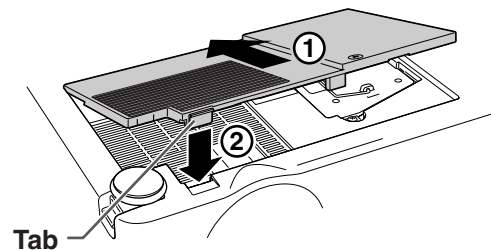

Note

- Be sure the filter/lamp unit cover is securely installed. The power will not turn on unless it is correctly installed.
- If dust or dirt has collected inside the rear and bottom air filters (not removable), clean the filter with a vacuum cleaner extension hose.

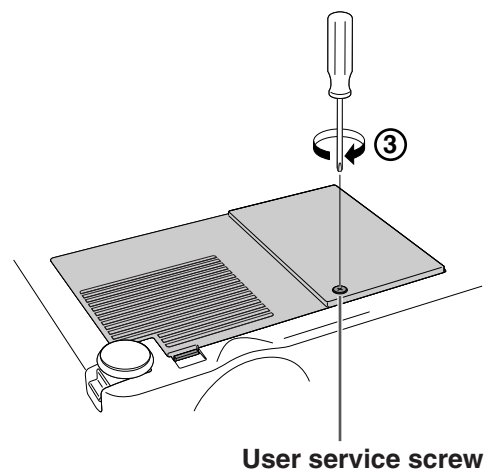

Maintenance Indicators

- The warning lights on the projector indicate problems inside the projector.
- If a problem occurs, either the temperature warning indicator or the lamp indicator will illuminate red, and the projector will enter the standby mode. After the projector has entered the standby mode, follow the procedures given below.

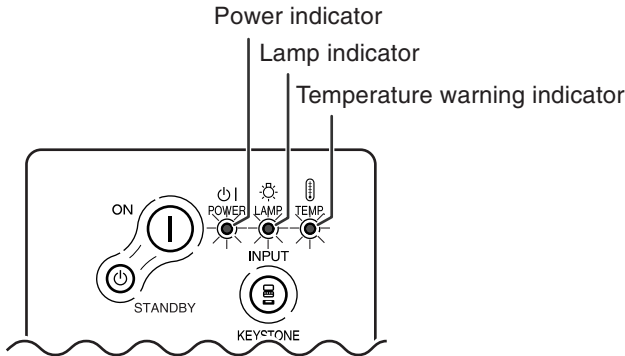

About the temperature warning indicator

If the temperature inside the projector increases, due to blockage of the air vents, or the setting location, "TEMP." will illuminate in the lower left corner of the picture. If the temperature keeps on rising, the lamp will turn off and the temperature warning indicator will blink, the cooling fan will run for a further 90 seconds, and then the projector will enter the standby mode. After "TEMP." appears, be sure to perform the following measures.



About the lamp indicator



- The lamp life becomes 0%, when used for approximately 4,500 hours with "Eco Mode" or when used for approximately 3,000 hours with "Standard Mode" (see page 45).
- When the remaining lamp life becomes 5% or less, "TEMP." (yellow) will be displayed on the screen. When the percentage becomes 0%, "TEMP." will change to "TEMP." (red), the lamp will automatically turn off and then the projector will automatically enter the standby mode. At this time, the lamp indicator will illuminate in red.
- If you try to turn on the projector a fourth time without replacing the lamp, the projector will not turn on.

Maintenance indicator	Condition		Problem	Possible Solution	
	Normal	Abnormal			
Temperature warning indicator	Off	Red on/ Standby	<ul style="list-style-type: none"> • Blocked air intake • Cooling fan break-down • Internal circuit failure • Clogged air intake 	<ul style="list-style-type: none"> • Relocate the projector to an area with proper ventilation. • Take the projector to your nearest Sharp Authorized Projector Dealer or Service Center (see page 65) for repair. 	
Lamp indicator	Green on Green blinks when the lamp is warming up or shutting down.	Red on	Time to change the lamp	<ul style="list-style-type: none"> • Remaining lamp life becomes 5% or less. 	<ul style="list-style-type: none"> • Carefully replace the lamp. (See page 58) • Take the projector to your nearest Sharp Authorized Projector Dealer or Service Center (see page 65) for repair. • Please exercise care when replacing the lamp.
		Red on/ Standby	The lamp does not illuminate.	<ul style="list-style-type: none"> • Burnt-out lamp • Lamp circuit failure 	
Power indicator	Green on/ Red on	Red blinks	<ul style="list-style-type: none"> • The filter/lamp unit cover is open. 	<ul style="list-style-type: none"> • Securely install the cover. • If the power indicator blinks even when the filter/lamp unit cover is securely installed, contact your nearest Sharp Authorized Projector Dealer or Service Center for advice. 	



Maintenance Indicators

Info

- If the temperature warning indicator illuminates, and the projector enters the standby mode, follow the possible solutions on the previous page and then wait until the projector has cooled down completely before plugging in the power cord and turning the power back on. (At least 5 minutes.)
- If the power is turned off for a brief moment due to power outage or some other cause while using the projector, and the power supply recovers immediately after that, the lamp indicator will illuminate in red and the lamp may not be lit. In this case, unplug the power cord from the AC outlet, replace the power cord in the AC outlet and then turn the power on again.
- If you want to clean the air vents during projector operation, be sure to put the projector into the standby mode. After the cooling fan has stopped, clean the vents.
- Do not unplug the power cord after the projector has entered the standby mode and while the cooling fan is running. The cooling fan runs for about 90 seconds.



Regarding the Lamp

Lamp

- It is recommended that the lamp (sold separately) be replaced when the remaining lamp life becomes 5% or less, or when you notice a significant deterioration in the picture and color quality. The lamp life (percentage) can be checked with the on-screen display. See page 44.
- For lamp replacement, please consult your nearest Sharp Authorized Projector Dealer or Service Center.

IMPORTANT NOTE TO U.S. CUSTOMERS:

The lamp included with this projector is backed by a 90-day parts and labor limited warranty. All service of this projector under warranty, including lamp replacement, must be obtained through a Sharp Authorized Projector Dealer or Service Center. For the name of the nearest Sharp Authorized Projector Dealer or Service Center, please call toll-free: 1-888-GO-SHARP (1-888-467-4277). U.S.A. ONLY

Caution Concerning the Lamp

- This projector utilizes a pressurized mercury lamp. A loud sound may indicate lamp failure. Lamp failure can be attributed to numerous sources such as: excessive shock, improper cooling, surface scratches or deterioration of the lamp due to a lapse of usage time. The period of time up to failure largely varies depending on the individual lamp and/or the condition and the frequency of use. It is important to note that failure can often result in the bulb cracking.
- When the lamp replacement indicator and on-screen display icon are illuminated, it is recommended that the lamp be replaced with a new one immediately, even if the lamp appears to be operating normally.
- Should the lamp break, the glass particles may spread inside the lamp cage or gas contained in the lamp may be vented into the room from the exhaust vent. Because the gas in this lamp includes mercury, ventilate the room well if the lamp breaks and avoid all exposure to the released gas. In case of exposure to the gas, consult a doctor as soon as possible.
- Should the lamp break, there is also a possibility that glass particles may spread inside of the projector. In such a case, it is recommended you contact your nearest Sharp Authorized Projector Dealer or Service Center to remove the damaged lamp and assure safe operation.

Replacing the Lamp

Caution

- Do not remove the lamp unit immediately after operation of the projector. The lamp will be hot and touching it can lead to burn or injury.
- Wait at least one hour after the power cord is disconnected to allow the surface of the lamp unit to fully cool before removing the lamp unit.
- If the new lamp does not light after replacement, take your projector to the nearest Sharp Authorized Projector Dealer or Service Center for repair. Purchase a replacement lamp unit of type BQC-PGA20X//1 from your nearest Sharp Authorized Projector Dealer or Service Center. Then carefully change the lamp by following the instructions described in this section. If you wish, you may have the lamp replaced at your nearest Sharp Authorized Projector Dealer or Service Center.

Regarding the Lamp

Removing and Installing the Lamp Unit

Info

- Be sure to remove the lamp unit using the handle. Be sure not to touch the glass surface of the lamp unit or the inside of the projector.
- To avoid injury to yourself and damage to the lamp, be sure to carefully follow the steps below.
- Do not loosen other screws except for the filter/lamp unit cover and lamp unit.
- Please refer to the installation manual included with the lamp unit.

- 1 Press  on the projector or  on the remote control to put the projector into the standby mode.**

Warning!

- Do not remove the lamp unit from the projector right after use. The lamp will be very hot and may cause burn or injury.

- 2 Disconnect the power cord.**
 - Unplug the power cord from the AC socket.
 - Leave the lamp until it has fully cooled down (about 1 hour).

- 3 Change the air filter.**
 - Change the air filter whenever you install the lamp unit (see pages 53 and 54).

- 4 Remove the filter/lamp unit cover.**
 - Turn the projector over. Loosen the user service screw (1) that secures the filter/lamp unit cover. Pressing the tab (2), remove the filter/lamp unit cover (3).

Lamp unit

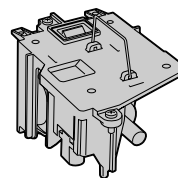

BQC-PGA20X/1

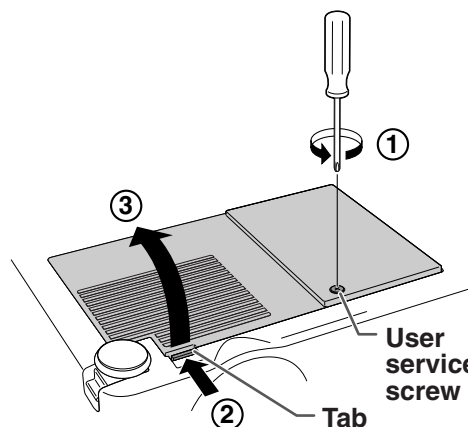
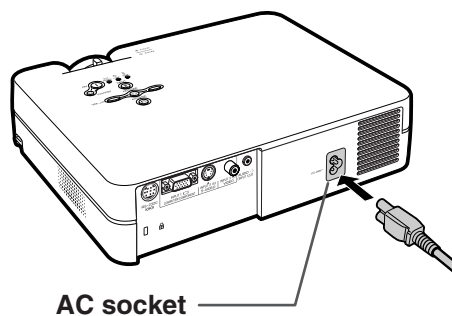
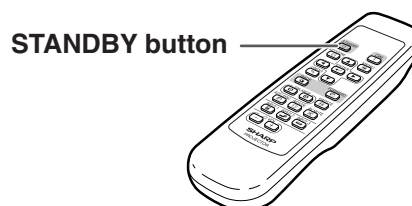
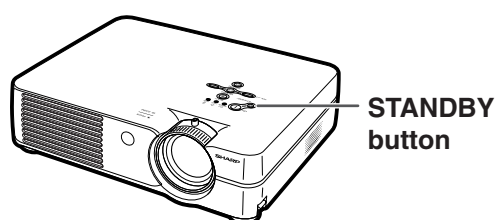



5 Remove the lamp unit.

- Loosen the securing screws from the lamp unit. Hold the lamp unit by the handle and pull it in the direction of the arrow. At this time, keep the lamp unit horizontal and do not tilt it.

6 Insert the new lamp unit.

- Press the lamp unit firmly into the lamp unit compartment. Fasten the securing screws.

7 Replace the filter/lamp unit cover.

- Align the tab on the filter/lamp unit cover (1) and place it while pressing the tab (2) to close it. Then tighten the user service screw (3) to secure the filter/lamp unit cover.

Info

- If the lamp unit and filter/lamp unit cover are not correctly installed, the power will not turn on, even if the power cord is connected to the projector.

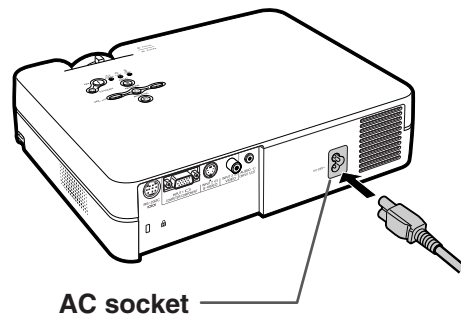
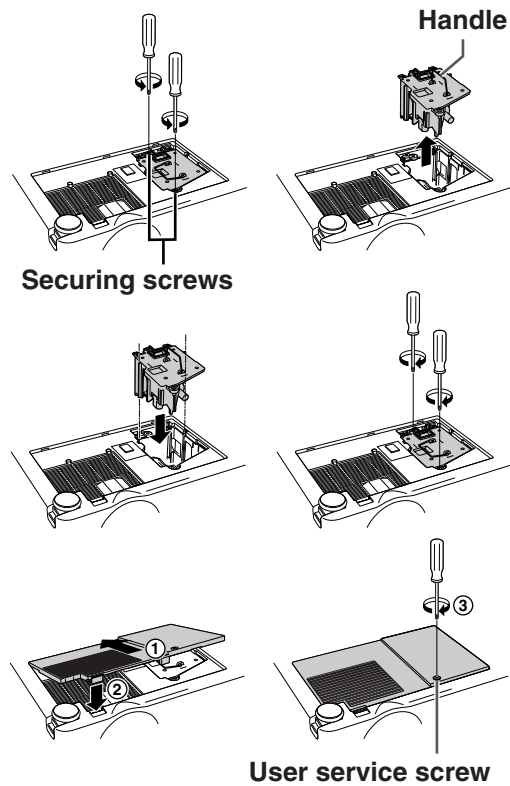

Resetting the Lamp Timer

Reset the lamp timer after replacing the lamp.

1 Connect the power cord.

- Plug the power cord into the AC socket of the projector.

2 Reset the lamp timer.

- While simultaneously holding down and on the projector, press and on the projector.
- "LAMP 0000H" is displayed, indicating that the lamp timer is reset.

Info

- Make sure to reset the lamp timer only when replacing the lamp. If you reset the lamp timer and continue to use the same lamp, this may cause the lamp to become damaged or explode.

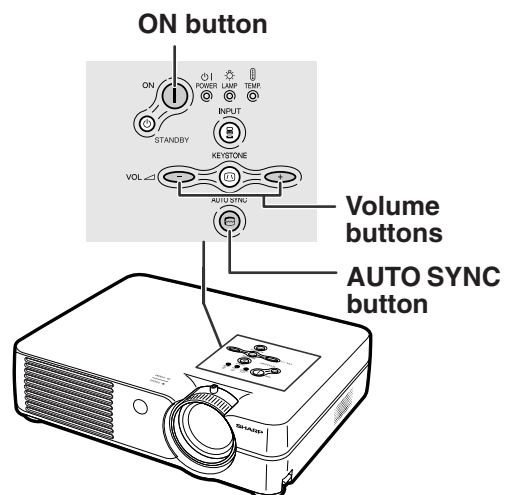

Connecting Pin Assignments

INPUT 1 RGB Signal Terminal: 15-pin Mini D-sub female connector

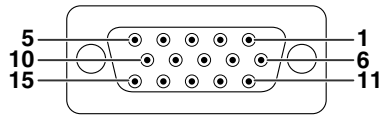

RGB Input

1. Video input (red)
2. Video input (green/sync on green)
3. Video input (blue)
4. Not connected
5. Not connected
6. Earth (red)
7. Earth (green/sync on green)
8. Earth (blue)
9. Not connected
10. GND
11. Not connected
12. Bi-directional data
13. Horizontal sync signal
14. Vertical sync signal
15. Data clock

Component Input

1. P_R (C_R)
2. Y
3. P_B (C_B)
4. Not connected
5. Not connected
6. Earth (P_R)
7. Earth (Y)
8. Earth (P_B)
9. Not connected
10. Not connected
11. Not connected
12. Not connected
13. Not connected
14. Not connected
15. Not connected

RS-232C Terminal: 9-pin Mini DIN female connector

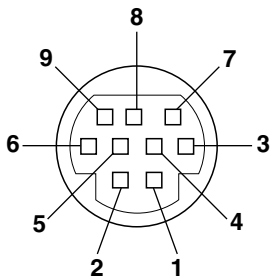

Pin No.	Signal	Name	I/O	Reference
1				Not connected
2	RD	Receive Data	Input	Connected to internal circuit
3	SD	Send Data	Output	Connected to internal circuit
4				Not connected
5	SG	Signal Ground		Connected to internal circuit
6				Not connected
7	RS			Connected to Pin 8
8	CS			Connected to Pin 7
9				Not connected

9-pin D-sub male connector of the DIN-D-sub RS-232C adaptor

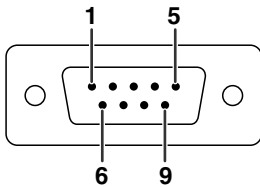

Pin No.	Signal	Name	I/O	Reference
1				Not connected
2	RD	Receive Data	Input	Connected to internal circuit
3	SD	Send Data	Output	Connected to internal circuit
4				Not connected
5	SG	Signal Ground		Connected to internal circuit
6				Not connected
7	RS			Connected to internal circuit
8	CS			Connected to internal circuit
9				Not connected

Note

- Pin 8 (CS) and Pin 7 (RS) are short circuited inside the projector.

RS-232C Cable recommended connection: 9-pin D-sub female connector

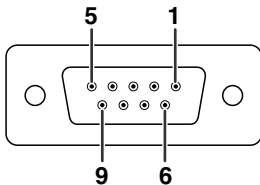

Pin No.	Signal	Pin No.	Signal
1	CD	1	CD
2	RD	2	RD
3	SD	3	SD
4	ER	4	ER
5	SG	5	SG
6	DR	6	DR
7	RS	7	RS
8	CS	8	CS
9	CI	9	CI

Note

- Depending on the controlling device used, it may be necessary to connect Pin 4 and Pin 6 on the controlling device (e.g. PC).

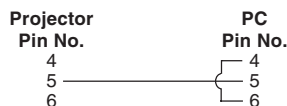

RS-232C Specifications and Command Settings

PC control

A computer can be used to control the projector by connecting an RS-232C serial control cable (cross type, sold separately) to the projector. (See page 20 for connection.)

Communication conditions

Set the serial port settings of the computer to match that of the table.

Signal format: Conforms to RS-232C standard.

Baud rate: 9,600 bps

Data length: 8 bits

Parity bit: None

Stop bit: 1 bit

Flow control: None

Basic format

Commands from the computer are sent in the following order: command, parameter, and return code. After the projector processes the command from the computer, it sends a response code to the computer.

Command format

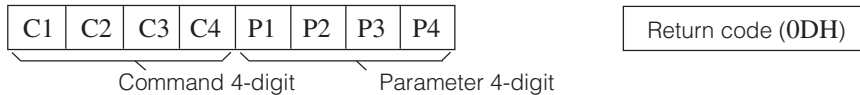

Response code format

Normal response



Problem response (communication error or incorrect command)



Info

- When more than one code is being sent, send each command only after the response code for the previous command from the projector is verified.

Note

- When the projector is put into the standby mode, a message "Shutting Down. Please Wait." is displayed for about 20 seconds. At that time, if the "POWR__1" command is being sent, "ERR" will be returned and this command is not received.

Commands

Example: When turning on the projector, make the following setting.

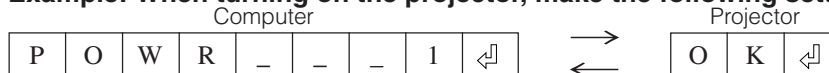

	CONTROL CONTENTS	COMMAND	PARAMETER	RETURN
BUTTONS & REMOTE CONTROL KEY	Standby	P O W R	_ _ _	0 OK or ERR
	Power On	P O W R	_ _ _	1 OK or ERR
	INPUT1	I R G B	_ _ _	1 OK or ERR
	INPUT2	I V E D	_ _ _	1 OK or ERR
	INPUT3	I V E D	_ _ _	2 OK or ERR
	INPUT1 SIGNAL TYPE : AUTO	I A S I	_ _ _	0 OK or ERR
	INPUT1 SIGNAL TYPE : RGB	I A S I	_ _ _	1 OK or ERR
	INPUT1 SIGNAL TYPE : COMPONENT	I A S I	_ _ _	2 OK or ERR
	Lamp Usage Time (hour)	T L T T	_ _ _	1 0-9999
	Remaining Lamp Life (Percentage)	T L T L	_ _ _	1 0-100
	Lamp Status	T L P S	_ _ _	1 0:Off, 1:On, 2:Retry, 3:Waiting, 4:Lamp Error
	Unit Status	T A B N	_ _ _	1 0:Normal, 1:Temp High, 2:Fan Err, 4:Filter Cover Err, 8:Lamp Life 5% or less, 16:Lamp Burnt-out, 32:Lamp Not Lit, 64:Temp Abnormally High
	Model Name Check	T N A M	_ _ _	1 PROJECTOR NAME
	AV Mute Off	I M B K	_ _ _	0 OK or ERR
	AV Mute On	I M B K	_ _ _	1 OK or ERR
	Auto Sync Start	A D J S	_ _ _	1 OK or ERR

Note

- If an underbar (_) appears in the parameter column, enter a space. If an asterisk (*) appears, enter a value in the range indicated in brackets under CONTROL CONTENTS.

GB-61

Computer Compatibility Chart

Computer

- Multiple signal support
Horizontal Frequency: 15–70 kHz, Vertical Frequency: 43–85 Hz, Pixel Clock: 12–108 MHz
- Compatible with sync on green signal
- SXGA+ and SXGA compatible in [intelligent compression](#)
- Intelligent Compression and Expansion System resizing technology

The following is a list of modes that conform to VESA. However, this projector supports other signals that are not VESA standards.

PC/MAC/WS	Resolution	Horizontal Frequency (kHz)	Vertical Frequency (Hz)	VESA Standard	Display			
PC	VGA	640 × 350	27.0	60		Upscale		
			31.5	70				
			37.5	85	✓			
		VGA	640 × 400	27.0	60			
				31.5	70			
				37.9	85		✓	
	VGA		720 × 350	27.0	60			
				31.5	70			
				37.9	85		✓	
		VGA	720 × 400	26.2	50			
				31.5	60		✓	
				34.7	70			
	37.9			72	✓			
	37.5			75	✓			
	43.3			85	✓			
	SVGA	800 × 600	31.4	50				
			35.1	56	✓			
			37.9	60	✓			
			46.6	70				
			48.1	72	✓			
			46.9	75	✓			
			53.7	85	✓			
			XGA	1,024 × 768	35.5		43	
					40.3		50	
					48.4		60	✓
	56.5	70			✓			
	60.0	75			✓			
68.7	85	✓						
SXGA	1,152 × 864	55.0	60					
		66.2	70					
		67.5	75	✓				
		64.0	60	✓				
SXGA+	1,280 × 1,024	64.0	60					
		64.0	60					
MAC 13"	VGA	640 × 480	34.9	67				
MAC 16"	SVGA	832 × 624	49.7	75				
MAC 19"	XGA	1,024 × 768	60.2	75				
MAC 21"	SXGA	1,152 × 870	68.7	75				





Note

- This projector may not be able to display images from notebook computers in simultaneous (CRT/LCD) mode. Should this occur, turn off the LCD display on the notebook computer and output the display data in "CRT only" mode. Details on how to change display modes can be found in your notebook computer's operation manual.
- When this projector receives 640 × 350 VESA format VGA signals, "640 × 400" appears on the screen.

DTV

Signal	Horizontal Frequency (kHz)	Vertical Frequency (Hz)
480I	15.7	60
480P	31.5	60
540P	33.8	60
580I	15.6	50
580P	31.3	50
720P	45.0	60
1035I	28.1	50
1035I	33.8	60
1080I	28.1	50
1080I	33.8	60

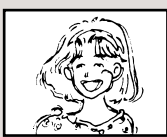
Troubleshooting

Problem	Check	Page
 No picture and no sound or projector does not start.	<ul style="list-style-type: none"> Projector power cord is not plugged into the wall outlet. 	15
	<ul style="list-style-type: none"> Power to the external connected devices is off. 	—
	<ul style="list-style-type: none"> The selected input mode is wrong. 	27
	<ul style="list-style-type: none"> The AV MUTE function is working. 	27
	<ul style="list-style-type: none"> Cables incorrectly connected to rear panel of the projector. 	16-20
	<ul style="list-style-type: none"> Remote control batteries have run out. 	13
	<ul style="list-style-type: none"> External output has not been set when connecting notebook computer. 	16
	<ul style="list-style-type: none"> The filter/lamp unit cover is not installed correctly. 	54,59
 Sound is heard but no picture appears.	<ul style="list-style-type: none"> Cables incorrectly connected to the rear panel of the projector. 	16-20
	<ul style="list-style-type: none"> “Bright” is set to minimum position. 	36
 Color is faded or poor.	<ul style="list-style-type: none"> Picture adjustments are incorrectly set. 	36
	(Video Input only) <ul style="list-style-type: none"> Video input system is incorrectly set. 	45
	(INPUT 1 only) <ul style="list-style-type: none"> Input signal type (RGB/Component) is incorrectly set. 	37
 Picture is blurred; noise appears.	<ul style="list-style-type: none"> Adjust the focus. 	22
	<ul style="list-style-type: none"> The projection distance exceeds the focus range. 	24
	(Computer Input only) <ul style="list-style-type: none"> Perform “Fine Sync” Adjustments (“Clock” Adjustment) Perform “Fine Sync” Adjustments (“Phase” Adjustment) 	38 38
	<ul style="list-style-type: none"> Noise may appear depending on the computer. 	—
 Picture appears but no sound is heard.	<ul style="list-style-type: none"> Cables incorrectly connected to rear panel of projector. 	16-20
	<ul style="list-style-type: none"> Volume is set to minimum. 	27
An unusual sound is occasionally heard from the cabinet.	<ul style="list-style-type: none"> If the picture is normal, the sound is due to cabinet shrinkage caused by room temperature changes. This will not affect operation or performance. 	—
Maintenance indicator illuminates.	<ul style="list-style-type: none"> See “Maintenance Indicators”. 	55
The projector cannot be turned on or put into the standby mode using the ON or STANDBY button on the projector.	<ul style="list-style-type: none"> The keylock is set. If the keylock is set to ON, all the buttons are locked. 	43



Troubleshooting

Problem	Check	Page
Picture is green on INPUT 1 COMPONENT.	• Change the input signal type setting.	37
Picture is pink (no green) on INPUT 1 RGB.		
Picture is dark.	• The lamp indicator is illuminating in red. Replace the lamp.	55
Picture is too bright and whitish.	• Picture adjustments are incorrectly set.	36

For SHARP Assistance

If you encounter any problems during setup or operation of this projector, first refer to the “Troubleshooting” section on pages 63 and 64. If this operation manual does not answer your question, please contact the SHARP Service departments listed below.

U.S.A.	Sharp Electronics Corporation 1-888-GO-SHARP (1-888-467-4277) lcdsupport@sharpsec.com http://www.sharplcd.com	Benelux	SHARP Electronics Benelux BV 0900-SHARPCE (0900-7427723) Nederland 9900-0159 Belgium http://www.sharp.nl http://www.sharp.be http://www.sharp.lu
Canada	Sharp Electronics of Canada Ltd. (905) 568-7140 http://www.sharp.ca	Australia	Sharp Corporation of Australia Pty. Ltd. 1300-135-022 http://www.sharp.net.au
Mexico	Sharp Electronics Corporation Mexico Branch (525) 716-9000 http://www.sharp.com.mx	New Zealand	Sharp Corporation of New Zealand (09) 634-2059, (09) 636-6972 http://www.sharpnz.co.nz
Latin America	Sharp Electronics Corp. Latin American Group (305) 264-2277 www.servicio@sharpsec.com http://www.siempresharp.com	Singapore	Sharp-Roxy Sales (S) Pte. Ltd. 65-226-6556 ckng@srs.global.sharp.co.jp http://www.sharp.com.sg
Germany	Sharp Electronics (Europe) GMBH 01805-234675 http://www.sharp.de	Hong Kong	Sharp-Roxy (HK) Ltd. (852) 2410-2623 dcmktg@srh.global.sharp.co.jp http://www.sharp.com.hk
U.K.	Sharp Electronics (U.K.) Ltd. 0161-205-2333 custinfo@sharp-uk.co.uk http://www.sharp.co.uk	Taiwan	Sharp Corporation (Taiwan) 0800-025111 http://www.sharp-scot.com.tw
Italy	Sharp Electronics (Italy) S.P.A. (39) 02-89595-1 http://www.sharp.it	Malaysia	Sharp-Roxy Sales & Service Co. (60) 3-5125678
France	Sharp Electronics France 01 49 90 35 40 hotlined@sef.sharp-eu.com http://www.sharp.fr	U.A.E.	Sharp Middle East Fze 971-4-81-5311 helpdesk@smef.global.sharp.co.jp
Spain	Sharp Electronica Espana, S.A. 93 5819700 sharplcd@sees.sharp-eu.com http://www.sharp.es	Thailand	Sharp Thebnakorn Co. Ltd. 02-236-0170 svc@stcl.global.sharp.co.jp http://www.sharp-th.com
Switzerland	Sharp Electronics (Schweiz) AG 0041 1 846 63 11 cattaneo@sez.sharp-eu.com http://www.sharp.ch	Korea	Sharp Electronics Incorporated of Korea (82) 2-3660-2002 lcd@sharp-korea.co.kr http://www.sharpkorea.co.kr
Sweden	Sharp Electronics (Nordic) AB (46) 8 6343600 vision.support@sen.sharp-eu.com http://www.sharp.se	India	Sharp Business Systems (India) Limited (91) 11- 6431313 service@sharp-oa.com
Austria	Sharp Electronics Austria (Ges.m.b.H.) 0043 1 727 19 123 pogats@sea.sharp-eu.com http://www.sharp.at		

Specifications

Product type	LCD Projector
Model	PG-A20X
Video system	NTSC3.58/NTSC4.43/PAL/PAL-M/PAL-N/PAL-60/SECAM/ DTV480I/DTV480P/DTV540P/DTV580I/DTV580P/DTV720P/DTV1035I/DTV1080I
Display method	LCD panel × 3, RGB optical shutter method
LCD panel	Panel size: 0.79" (20.0 mm) (12 [H] × 16 [W] mm) No. of dots: 786,432 dots (1,024 [H] × 768 [V])
Standard lens	1–1.2 × zoom lens, F1.7–1.94, f = 26–31 mm
Projection lamp	SHP 180 W lamp
Component input signal	15-pin mini D-sub connector
(INPUT1)	Y: 1.0 Vp-p, sync negative, 75 Ω terminated P _B : 0.7 Vp-p, 75 Ω terminated P _R : 0.7 Vp-p, 75 Ω terminated
Horizontal resolution	700 TV lines (DTV720P)
Computer RGB input signal	15-pin mini D-sub connector
(INPUT 1)	RGB separate/sync on green type analog input: 0–0.7 Vp-p, positive, 75 Ω terminated HORIZONTAL SYNC. SIGNAL: TTL level (positive/negative) VERTICAL SYNC. SIGNAL: Same as above
S-video input signal	4-pin mini DIN connector
(INPUT 2)	Y (luminance signal): 1.0 Vp-p, sync negative, 75 Ω terminated C (chrominance signal): Burst 0.286 Vp-p, 75 Ω terminated
Video input signal	RCA connector: VIDEO, composite video, 1.0 Vp-p, sync negative, 75 Ω
(INPUT 3)	terminated
Computer control signal (RS-232C)	9-pin mini DIN connector
Pixel clock	12–108 MHz
Vertical frequency	43–85 Hz
Horizontal frequency	15–70 kHz
Audio input signal	ø3.5 mm minijack: AUDIO, 0.5 Vrms, more than 47 kΩ (stereo)
Audio output	1.0 W (monaural)
Speaker system	2.8 cm round × 1
Rated voltage	AC 110–240 V
Input current	2.6 A
Rated frequency	50/60 Hz
Power consumption	XXX W (Standard mode)/XXX W (Eco mode) with AC 110 V XXX W (Standard mode)/XXX W (Eco mode) with AC 240 V
Power consumption (standby)	4 W (AC 110 V) – 6 W (AC 240 V)
Heat dissipation	XXX BTU/hour (Standard mode)/XXX BTU/hour (Eco mode) with AC 110 V XXX BTU/hour (Standard mode)/XXX BTU/hour (Eco mode) with AC 240 V
Operating temperature	41°F to 95°F (+5°C to +35°C)
Storage temperature	–4°F to 140°F (–20°C to +60°C)
Cabinet	Plastic
I/R carrier frequency	38 kHz
Dimensions (approx.)	11 45/64" × 3 13/64" × 9 1/32" (297 (W) × 81 (H) × 229 (D) mm) (main body only) 11 45/64" × 3 33/64" × 9 1/32" (297 (W) × 89 (H) × 229 (D) mm) (including adjustment foot and projecting parts)
Weight (approx.)	XXX lbs. (XXX kg)
Supplied accessories	Remote control, Two R-6 batteries, Power cord for U.S., Canada etc. (6', 1.8 m), Power cord for Europe, except U.K. (6', 1.8 m), Power cord for U.K., Hong Kong and Singapore (6', 1.8 m), Power cord for Australia, New Zealand and Oceania (6', 1.8 m), RGB cable (9'10", 3.0 m), DIN-D-sub RS-232C adaptor (5 57/64", 15 cm), Carrying case, Lens cap (attached), Extra air filter, Projector manual and technical reference CD-ROM, "QUICK GUIDE" label, Operation manual
Replacement parts	Lamp unit (Lamp/cage module) (BQC-PGA20X//1), Remote control (RRMCGA187WJSA), Two R-6 batteries ("AA" size, UM/SUM-3, HP-7, or similar), Power cord for U.S., Canada etc. (QACCDAA016WJPZ), Power cord for Europe, except U.K. (QACCVA006WJPZ), Power cord for U.K., Hong Kong and Singapore (QACCBA015WJPZ), Power cord for Australia, New Zealand and Oceania (QACCLA005WJPZ), RGB cable (QCNWGA012WJPZ), DIN-D-sub RS-232C adaptor (QCNWGA015WJPZ), Carrying case (GCASNA006WJSA), Lens cap (CCAPHA011WJ01), Air filter (PFILDA008WJZZ), Projector manual and technical reference CD-ROM (UDSKAA037WJZZ), "QUICK GUIDE" label (TLABZA191WJZZ), Operation manual (TINS-A850WJZZ)

As a part of policy of continuous improvement, SHARP reserves the right to make design and specification changes for product improvement without prior notice. The performance specification figures indicated are nominal values of production units. There may be some deviations from these values in individual units.



Dimensions

Units: inches (mm)

Rear View

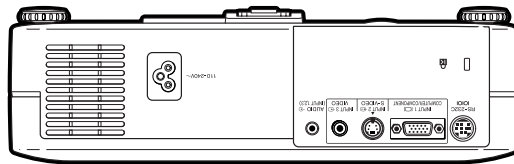

Top View

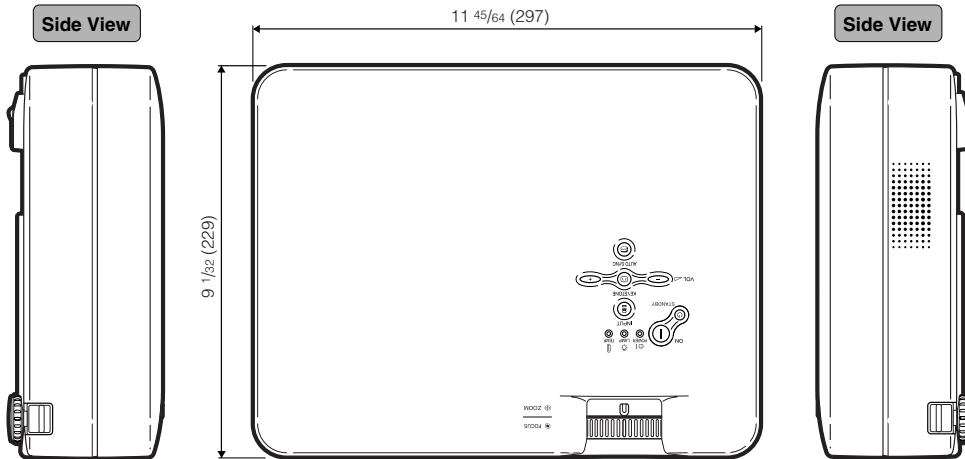

Front View

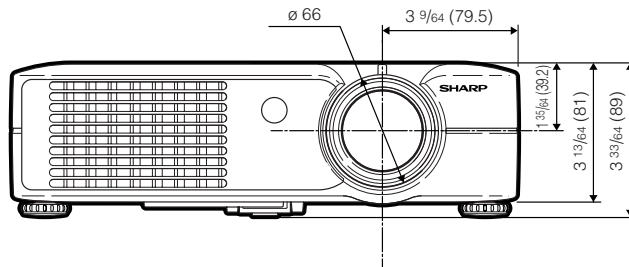

Bottom View

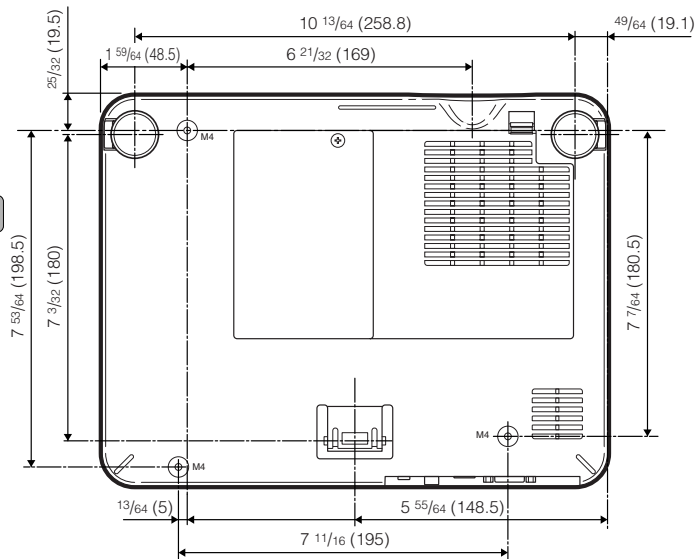



Glossary

Anti-Theft

If the "Keycode" set in the projector is not correctly entered, the projector will not operate even if signals are entered.

Aspect Ratio

Width and height ratio of an image. The normal aspect ratio of a computer and video image is 4:3. There are also wide images with an aspect ratio of 16:9 and 21:9.

Auto Sync

Optimizes projected computer images by automatically adjusting certain characteristics.

Background

Initial setting image projected when no signal is being output.

Border

Projects a 4:3 image fully within a 16:9 screen by keeping the aspect ratio at 4:3.

Clock

Clock adjustment is used to adjust vertical noise when clock level is incorrect.

CLR Temp (Color temperature)

Function that can be used to adjust the color temperature to suit the type of image input to the projector. Decrease the color temperature to create warmer, reddish images for natural flesh tones, or increase to create cooler, bluish images for a brighter picture.

Dot by dot

Mode that projects images in their native resolution.

Gamma

Image quality enhancement function that offers a richer image by brightening the darker portions of the image without altering the brightness of the brighter portions. You can select four different modes: STANDARD, PRESENTATION, CINEMA and GAME.

Intelligent compression

High quality resizing of lower and higher resolution images to fit the projector's native resolution.

Keylock

Mode that can lock the operation of projector buttons to prevent unauthorized adjustment.

Keystone correction

Function to digitally correct a distorted image when the projector is set up at an angle, smoothens out jaggies on keystone images and compresses the image not only horizontally but vertically keeping the 4:3 aspect ratio.

Password

A password is set so that changes cannot be made in the "Anti-Theft" setting.

Phase

Phase shift is a timing shift between isomorphic signals with the same resolution. When phase level is incorrect, the projected image typically displays horizontal flicker.

Resize

Allows you to modify or customize the picture display mode to enhance the input image. You can select four different modes: NORMAL, DOT BY DOT, BORDER and STRETCH.

sRGB

An international standard of color reproduction regulated by the IEC (International Electrotechnical Commission). As the fixed color area has been decided by the IEC, the color changes according to LCD features, so that the images are displayed in a natural tint based on an original image, when "sRGB" is set to "ON".

Stretch

Mode that stretches the 4:3 image horizontally to display it fully on a 16:9 screen.



Index

AC socket	15	Memory	37
Adjusting the Lens	22	MENU button	32
Adjustment buttons	32	Menu Color	46
Adjustment feet	21	Menu Position	46
Air filter	53	NORMAL	40
Anti-Theft	48	ON button	26
Aspect ratio	40	Optional accessories	14
AUDIO INPUT terminal	16	Options	44
Auto Power off	46	OSD Display	45
Auto Sync (Auto Sync adjustment)	39	Password	47
AUTO SYNC button	39	PDF	9
AV MUTE button	27	Phase	38
BACK button	12	Picture Adjustment	36
Background	45	Power cord	15
Batteries	13	Power indicator	26
Blue	36	PRJ mode (Reversing/Inverting Projected Images)	50
BORDER	40	Red	36
Bright	36	Remote control	12
Carrying case	51	Remote control sensor	13
Ceiling-mount setup	25	Replacing the lamp	57
Clock	38	RESIZE button	40
CLR Temp (Color Temperature)	36	RGB cable	16
Color	36	RS-232C terminal	20
Computer Image Adjustment	38	Sharp	36
Contrast	36	Signal Info	39
DIN-D-sub RS-232C adaptor	20	Signal Type	37
DOT BY DOT	40	Special Modes	38
Eco Mode	45	sRGB	37
ENLARGE buttons	42	STANDBY button	28
ENTER button	35	STRETCH	40
Exhaust vent	52	Supplied accessories	14
Fine Sync	38	Temperature warning indicator	55
Focus ring	22	Tint	36
Foot release	21	UNDO button	29
FORWARD button	12	Video System	45
FREEZE button	42	Volume buttons	27
Gamma	37	V-Pos	38
H-Pos	38	Zoom knob	22
INPUT 1 terminal	16		
INPUT 1 – 3 modes	27		
INPUT 2 terminal	18		
INPUT 3 terminal	18		
INPUT button	27		
Intake vent	52		
Kensington Security Standard connector	11		
Keylock	43		
KEystone button	29		
Keystone correction	29		
Lamp	57		
Lamp indicator	55		
Lamp Timer (Life)	44		
Language (on-screen display language)	28		
Lens cap	10		



SHARP®

SHARP CORPORATION

Free Manuals Download Website

<http://myh66.com>

<http://usermanuals.us>

<http://www.somanuals.com>

<http://www.4manuals.cc>

<http://www.manual-lib.com>

<http://www.404manual.com>

<http://www.luxmanual.com>

<http://aubethermostatmanual.com>

Golf course search by state

<http://golfingnear.com>

Email search by domain

<http://emailbydomain.com>

Auto manuals search

<http://auto.somanuals.com>

TV manuals search

<http://tv.somanuals.com>