

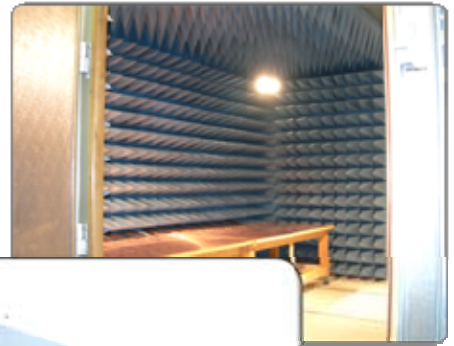

Technology Advancement Group®, Inc.

SV-2003-X2 Server Operations Manual



TAG
22355 TAG Way
Dulles, VA
20166

1 Copyright © 2008 Technology Advancement Group®, Inc. (TAG®)

All rights reserved. This publication and its contents are proprietary to TAG. No part of this publication may be reproduced in any form or by any means without the written permission of TAG, 22355 TAG Way, Dulles, Virginia 20166-9310.

TAG has made every effort to ensure the correctness and completeness of the material in this document. TAG shall not be liable for errors contained herein. The information in this document is subject to change without notice. TAG makes no warranty of any kind with regard to this material, including, but not limited to, the implied warranties of merchantability and fitness for a particular purpose.

1.1 Trademarks

All trademarks, marks, names, or product names referenced in this publication are the property of respective owners, and TAG neither endorses nor otherwise sponsors any such products or services referred to herein.

2 About This Manual

2.1 Scope and Audience

This manual provides information on the SV-2003-X2 Server. The SV-2003-X2 Server allows for up to 8 cores in a 2U chassis as well as up to 64GB of RAM. Each server features (2) Dual Core LV Xeon processors to maximize processing performance, while reducing power dissipation. Each server is capable of handling (2) Quad-Core Xeon processors.

The dual server suite meets military standards such as shock, vibration, and humidity. TAG built the SV-2003-X2 to relieve potential problems with a single failing power supply and to create a product that end users can rely on. The SV-2003-X2 is ideal for transit case and deployable situations where such high density computing minimizes size, weight, and power.

2.1.1 Organization

This manual is divided into the following chapters and appendix:

- **Chapter 1** Cautions and Warnings when handling the SV-2003-X2 Server.
- **Chapter 2** provides detailed information on the external and internal server components.
- **Chapter 3** provides procedures for replacing Hot-Swappable and LRU components, as well as for replacing or adding system memory.
- **Chapter 4** provides a high-level overview that defines RAID, the advantages and disadvantages of various RAID levels, and guidelines to observe when implementing RAID.

2.2 About TAG

2.2.1 Summary of Qualifications

Providing engineering services and solutions for our national defense and homeland security is a responsibility that we don't take lightly. TAG is a recognized industry leader in developing defense technologies and advanced electronics that support some of the most complex solutions for battlespace information networks and management systems in the world.

Our customers depend on our expertise to translate functional requirements and performance objectives into specific design criteria for individual elements and sub-systems that comprise larger mission critical systems. For more than twenty years, we have dedicated our experience in engineering to the design of innovative rugged solutions for military and government, and to providing a wide range of enterprise services and Information Assurance in support of the Defense Information Systems Agency's (DISA) Net-Centric initiatives.

2.2.2 Core Competencies

TAG designs, manufactures, and supports advanced communications electronics as well as integrates, operates, and supports the users of defense communication and information networks for several technology programs in the United States and abroad. TAG has two operating segments consisting of the Tactical Systems and Information and Engineering Services business units;

Tactical Systems provides mechanical, electrical, and thermal engineering for the design and development of MIL-STD certified electronic data enabled systems that are built for in-theater survivability and communication capability over joint enterprise platforms such

as DSN, GIG, STEP, GBS, and JTRS. This includes the custom ruggedization of commercial-off-the-shelf (COTS) and non-developmental items (NDI). TAG's mechanical engineering division designs and fabricates custom hardened enclosures, using high performance metal materials, to house and protect a variety of sensitive devices and controls. TAG's electrical engineering division designs programmable power solutions and advanced sensor technologies including digital receivers, advanced digital signal processors and thermal detection systems. TAG's thermal engineering applies survivability techniques to ensure systems and instruments are designed to withstand harsh environmental conditions encountered by land-based, airborne, and shipboard system in operations

Information and Engineering Services provides a wide range of customer support operations, enterprise network and communications engineering services combining the experience and expertise required to achieve network and communication interoperability for component hardware and software elements. This includes design, simulation, analysis, and testing of the components or systems for the support of command and control operations. Our team of national security cleared network engineering professionals provides planning support for information systems, architectures, and networks while developing strategies that lay the groundwork for sound technical foundations for programmatic plans. Our expertise in analyzing, designing, implementing, and managing network, telecommunication and security solutions addresses the full lifecycle approach to providing mission oriented enterprise class services.

Document Revision History

Date	Version Number	Updated By	Description of Changes
02/14/2008	1.0	Alan Huckerby	Author
03/20/2008	1.1	Alan Huckerby	Author

Table of Contents

Contents

1	Copyright © 2008 Technology Advancement Group®, Inc. (TAG®)	2
1.1	Trademarks	2
2	About This Manual	3
2.1	Scope and Audience	3
2.1.1	Organization	3
2.2	About TAG	4
2.2.1	Summary of Qualifications	4
2.2.2	Core Competencies	4
3	Safety Instructions	12
3.1	Types of warnings used in this manual	12
3.1.1	Safety Symbols and Labels	12
3.1.2	Conventions	12
4	Server Overview	15
4.1	Product Information	15
4.2	SV-2003-X2 Server	15
4.2.1	Specifications	15
4.2.2	Additional Specifications	16
4.2.3	Server Highlights	17
4.2.4	SV-2003-X2 Server	17
4.3	Server Components	17
4.3.1	Motherboard and Type	18
4.3.2	SV-2003-X2 Server Motherboard	18
4.3.3	Connector and Component Locations	19
4.4	System Memory	20
4.4.1	Identifying System Memory	20
4.5	TAG Approved BIOS	21
4.5.1	Common BIOS Settings	21
4.6	Identifying your I/O Connectors	24
4.7	Standard Server Components	25
4.7.1	CD/DVD Drive	25
4.7.2	Dual-redundant, auto-sensing power supply	26
4.8	PCI I/O Expansion Cards	27
4.8.1	Adaptec PCI-Express RAID Controller	27
4.8.2	PCI Audio Card	28
4.8.3	Intel Remote Management Module	28
5	Procedures	31
5.1	Installing Red Hat 4.5 for S5000PAL and Adaptec 3805 system	31
5.2	Server Startup	50
5.3	Server Shutdown	50
5.3.1	BIOS Configuration for SV-2003-X3	51

5.4	Upgrading Memory and Replacing Hot-Swap and LRU Components	58
5.4.1	Preventing Static Electricity	58
5.5	Replacing a Hot-Swap Power Supply Module	59
5.6	Replacing a Hot-Swap Hard Drive	60
5.6.1	147GB SAS Hard Drive	61
5.7	Removing the Server Cover	61
5.8	Adding or Replacing System Memory	62
5.8.1	Install system memory.	63
6	RAID	65
6.1	RAID Defined.....	65
6.1.1	Reasons for RAID	66
6.1.2	RAID Level 0	66
6.1.3	RAID Level 1	66
6.2	Configuring RAID 1 ON ADAPTEC 3805	68
6.2.1	72	

List of Figures

Figure 4-1 SV-2003-X2 Server Components and Connectors (Front View)	17
Figure 4-2 Server Mother Board.....	18
Figure 4-3 Server Mother Board.....	19
Figure 4-4 I/O Connectors.....	25
Figure 4-5 Slot-loading low-profile DVD±R (DL)/-RAM/CD-RW Drive	25
Figure 4-6 Hot-Swap Power Supply	27
Figure 5-1 Confirm Boot order.....	31
Figure 5-2 Introductory Screen.....	32
Figure 5-3 Loading Drivers.....	32
Figure 5-4 Welcome Screen.....	33
Figure 5-5 Language Screen.....	33
Figure 5-6 Keyboard Selection.....	34
Figure 5-7 Search for previously installed installations.....	34
Figure 5-8 Disk Partitioning Setup.....	35
Figure 5-9 Disk Partition Warning	35
Figure 5-10 Automatic partitioning	36
Figure 5-11 Automatic Partitioning (Warning)	36
Figure 5-12 Disk Setup.....	37
Figure 5-13 Boot Loader Configuration	37
Figure 5-14 Firewall Configuration	38
Figure 5-15 Additional Language Support.....	38
Figure 5-16 Time Zone Selection	39
Figure 5-17 Set Root Password	39
Figure 5-18 Set Root Password (Confirmation).....	40
Figure 5-19 Package Installation Defaults.....	40
Figure 5-20 About to Install	41
Figure 5-21 Installation.....	41
Figure 5-22 Still Installing Buttons are disabled.	42
Figure 5-23 Installation Complete	42
Figure 5-24 System Check.....	43
Figure 5-25 Welcome	43
Figure 5-26 License Agreement	44
Figure 5-27 Set Date and Time	44
Figure 5-28 Set Display Color and Resolution.	45
Figure 5-29 Set Color Depth	45
Figure 5-30 Display	46
Figure 5-31 System User (Non Administrative)	46
Figure 5-32 Personal user Account.....	47
Figure 5-33 Additional CDs	47
Figure 5-34 Finish Setup.....	48
Figure 5-35 Log In Screen.....	48
Figure 5-36 Log in Screen.....	49
Figure 5-37 BIOS Setup	51

Figure 5-38 Processor Configuration.....	51
Figure 5-39 Processor Configuration.....	52
Figure 5-40 Memory Configuration.....	52
Figure 5-41 ATA Controller Configuration	53
Figure 5-42 Serial Port Configuration	53
Figure 5-43 Floppy/USB Configuration.....	54
Figure 5-44 PCI Configuration.....	54
Figure 5-45 System Acoustic Configuration	55
Figure 5-46 Security	55
Figure 5-47 Server Management	56
Figure 5-48 Boot Order.	56
Figure 5-49 Save Changes	57
Figure 5-50 Grounding Wrist Strap	58
Figure 5-51 Hot-Swap of 2U Server Power Supply Module	60
Figure 5-52 147GB SAS HDD (Removed from HD Carrier)	61
Figure 5-53 DIMM Module Bank	63
Figure 6-1 RAID Level 1 (Mirroring)	67
Figure 6-2 Raid Setup Utility	68
Figure 6-3 Array Configuration Utility	68
Figure 6-4 Create Array.....	69
Figure 6-5 Select Both Drives	69
Figure 6-6 Highlight RAID	70
Figure 6-7 Array Properties	70
Figure 6-8 Array Properties	71

List of Tables

Table 4-1 Mother Server Board Components.....	20
---	----

Chapter 1

Cautions and Warnings.

Electronically distributed. Subject to user discretion when printed.

3 Safety Instructions

3.1 Types of warnings used in this manual

Read this manual thoroughly, paying special attention to the cautions and warnings.

3.1.1 Safety Symbols and Labels



DANGER



WARNING



CAUTION

These warnings and cautions indicate situations or practice that might result in property damage.

3.1.2 Conventions

3.1.2.1 Important Messages

Important messages appear where mishandling of components is possible or when work orders can be misunderstood. These messages also provide vital information associated with other aspects of system operation. The word “important” is written as **“IMPORTANT,”** both capitalized and bold and is followed by text in italics. The italicized text is the important message.

3.1.2.2 Warnings

Warnings appear where overlooked details may cause damage to the equipment or result in personal injury. Warnings should be taken seriously. Warnings are easy to recognize. The word “warning” is written as **“WARNING,”** both capitalized and bold and is followed by text in italics. The italicized text is the warning message.

3.1.2.3 Cautions

Cautionary messages should also be heeded to help you reduce the chance of losing data or damaging the system. Cautions are easy to recognize. The word “caution” is written as **“CAUTION,”** both capitalized and bold and is followed by text in italics. The italicized text is the cautionary message.

3.1.2.4 Notes

Notes inform the reader of essential but non-critical information. These messages should be read carefully as any directions or instructions contained therein can help you avoid making mistakes. Notes are easy to recognize. The word “note” is written as **“NOTE,”**

Chapter 2

SV-2003-X2 Server.

Electronically distributed. Subject to user discretion when printed.

4 Server Overview

4.1 Product Information

This chapter provides an introductory overview of the TAG family of rugged servers. TAG servers are highly customizable; the specific components vary depending on the mission requirements. Your system may contain components not described in this chapter. For detailed information on these components, refer to the manufactures website or contact TAG Technical Support at tech.support@tag.com.

TAG's rugged servers combine Intel® technology with state-of-the-art mechanical, thermal and electrical engineering to create customized systems that perform above and beyond end user or program specifications. Our rugged servers are designed to meet and exceed many MIL-STD requirements to ensure survivability in the field.

4.2 SV-2003-X2 Server

4.2.1 Specifications

Chassis & power supply:

- 2U Heavy-duty, .090inch Aluminum/Magnesium alloy, strain hardened and stabilized rack-mount chassis
- Chassis is designed to EIA-310-D Standards
- 3.5"H x 19"W x 24"D
- Redundant, Hot-Swap, auto-sensing power supplies
- Cooling system developed specifically for harsh environments
- Front accessible on/off switches

Intelligent Fan Controller

- Acoustically optimized, environmentally aware

Processor & Cache:

- (2) Dual Core Intel Xeon 5138 CPU's

Motherboard and On-board Features:

- Intel 5000P chipset, 1333MHz FSB
- On-board ATI graphics controller with 16MB RAM
- On-board SATA controllers
- (2) 10/100/1000 Ethernet ports
- One serial port (RJ-45 connection)
- (2) USB 2.0 ports front, (2) USB 2.0 ports rear
- PS/2 Keyboard & Mouse port
- Expandable to 32GB FBDIMM

System Components:

- 8GB FB DIMM
- (2) 400GB Hot-Swap, removable SAS hard drives with rugged metal carriers and receivers
- (2) Additional hard drive expansion bays
- PCI Audio card
- Intel remote server management module
- Low-profile DVD±RW(DL),-RAM,CD-RW drive
- PCI Express SAS RAID controller (Support for RAID 0,1, and 5)

4.2.2 Additional Specifications

- Total Weight: 42lbs
- Input Voltage Range: 115 Vrms nominal, 98 to 138 Vrms (-15%, +20%)
- Input Frequency Range: 60 Hz nominal, 56.4 to 63.6 Hz (- 6%, + 6%)
- Maximum Operating Power: 494.4 Watts
- Maximum Operating Current: 4.12 Amps
- Typical Operating Power: 410.4 Watts
- Typical Operating Current: 3.42 Amps
- Idle Power: 367 Watts
- Idle Current: 3.059 Amps
- AC Input Power Connector: IEC 320
- PFC: .97 Typical
- Operating Temp Range: 0-50°C
- Non-Operating Temp range: -40-70°C
- Operating Humidity: up to 90% non-condensing
- Shock: Designed to meet MIL-STD-901D Grade B
- Vibration: Designed to meet MIL-STD-167-1

4.2.3 Server Highlights

- The SV-2003-X2 is unlike any other server that is currently on the market. The SV-2003-X2 is ideal for use in deployable situations where the product's compact size, high density computing, minimized size, weight, and power make for a highly portable, rugged and reliable system
- Designed to meet MIL-STD-901D, MIL-STD-810F, MIL-STD-167, MIL-STD-461E, and MIL-STD-740
- Contains an intelligent fan controller (acoustically optimized, environmentally aware)
- The chassis is made of environmentally protected 5052 aluminum-alloy strain hardened and stabilized chassis
- Proven to function in extreme operating temperature ranges

4.2.4 SV-2003-X2 Server

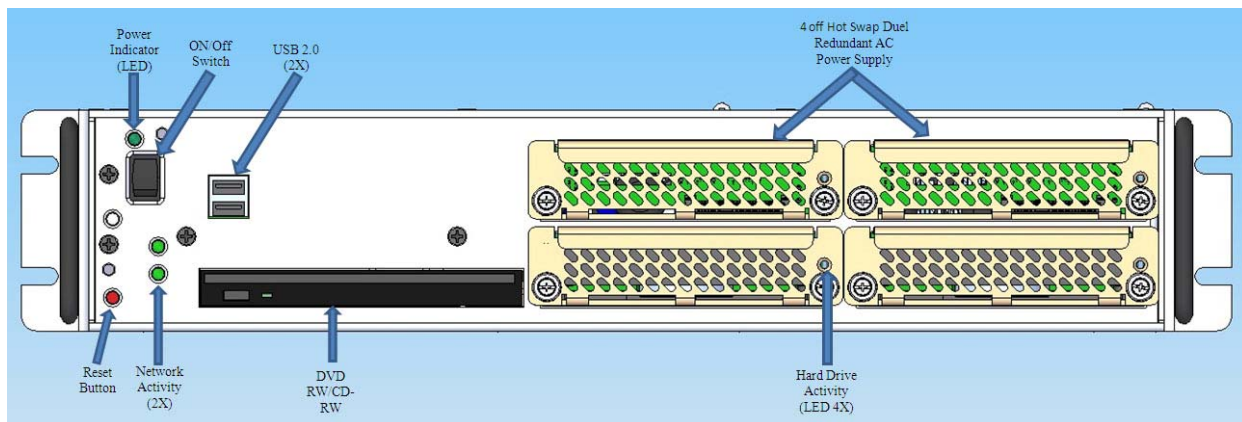

Figure 4-1 SV-2003-X2 Server Components and Connectors (Front View)

4.3 Server Components

This section provides an overview of the most common components installed in TAG rugged servers. Information is also provided on how to identify specific components within your server. For detailed information on the specific components installed in your server, refer the manufactures website.

4.3.1 Motherboard and Type

The version of an Intel server motherboard can be determined by decoding the last three digits of the board part number.

For example: For the product C44686-703, the number following the "-" is as follows:

7 = Fabrication (FAB) Number
03 = Revision 3.

The board part number can be found on the motherboard. The board part number can also be determined by using Intel Server Management software.

4.3.2 SV-2003-X2 Server Motherboard

Figure 4-2 shows the primary components of the motherboard.

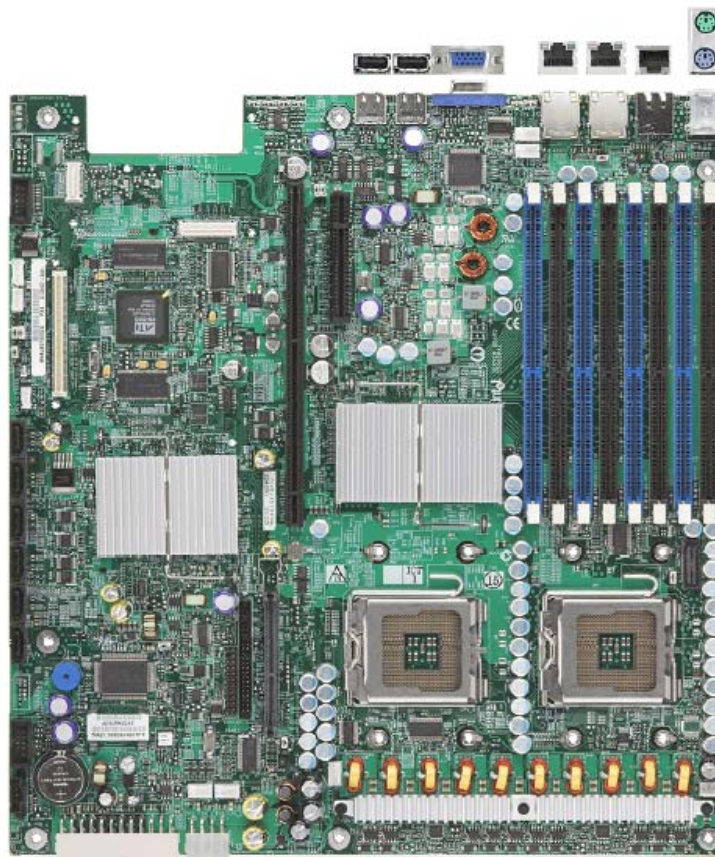

Figure 4-2 Server Mother Board

4.3.3 Connector and Component Locations

Figure 4.3 shows the board layout of the server board. Each connector and major component is identified by a number or letter, and a description is given below in Table 4.3.

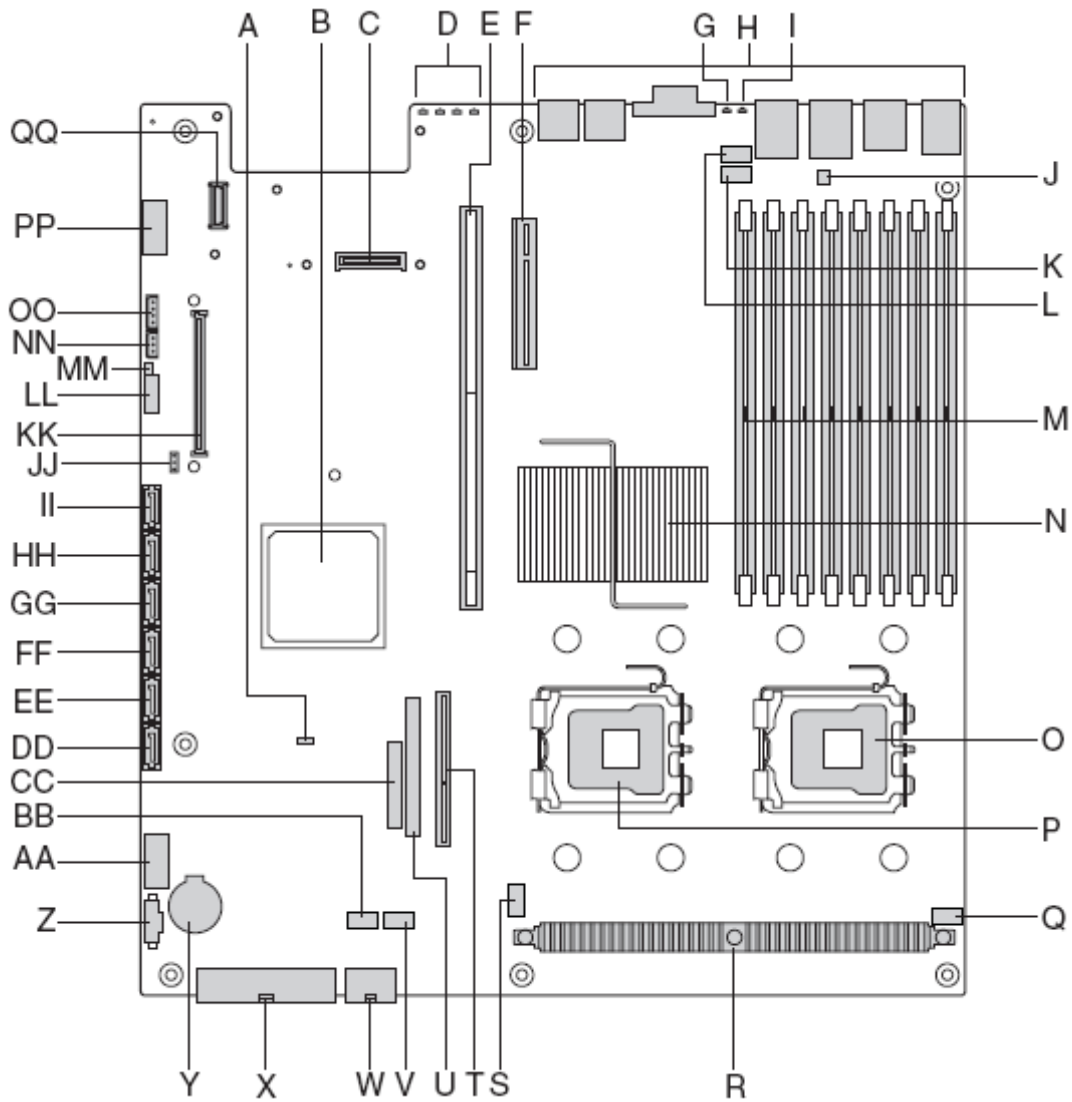

Figure 4-3 Server Mother Board

	Description		Description
A	BIOS Bank Select Jumper	V	System Fan #2 Header
B	Intel® ESB-2 IO Controller Hub	W	CPU Power Connector
C	IO Module Option Connector	X	Main Power Connector
D	POST Code Diagnostic LEDs	Y	Battery
E	Intel® Adaptive Slot – Full Height	Z	Power Supply Management Connector
F	PCI Express* Riser Slot – Low Profile	AA	Dual Port USB 2.0 Header
G	System Identification LED - Blue	BB	System Fan #1 Header
H	External IO Connectors	CC	SSI 24-pin Control Panel Header
I	Status LED – Green / Amber	DD	SATA 0
J	Serial 'B' Port Configuration Jumper	EE	SATA 1
K	System Fan #4 Header	FF	SATA 2
L	System Fan #3 Header	GG	SATA 3
M	FBDIMM Slots	HH	SATA 4
N	Intel® 5000P Memory Controller Hub (MCH) or Intel® 5000X Memory Controller Hub (MCH)	II	SATA 5
O	CPU #1 Connector	JJ	SATA SW RAID 5 Activation Key Connector
P	CPU #2 Connector	KK	Intel® Remote Management Module (RMM) Connector
Q	CPU #1 Fan Header	LL	System Recovery Jumper Block
R	Voltage Regulator Heat Sink	MM	Chassis Intrusion Switch Header
S	CPU #2 Fan Header	NN	3-pin IPMB Header
T	Bridge Board Connector	OO	Intel® Local Control Panel Header
U	ATA-100 Optical Drive Connector (Power+IO)	PP	Serial 'A' Header
		QQ	Intel® RMM NIC Connector

Table 4-1 Mother Server Board Components

4.4 System Memory

The type and amount of system memory, or RAM (random access memory), on your server depends on the motherboard installed and how it was configured.

4.4.1 Identifying System Memory

Refer to your Motherboard and Type on Page 19.” Once you have identified the motherboard, TAG technical support can assist you in determining the type and amount of system memory in your system. See “Contacting information on TAG on back page of this manual for information on how to contact Technical Support.

For information on replacing or upgrading your system memory, refer to “Adding and Replacing System Memory on page 58.”

4.5 TAG Approved BIOS

The BIOS (basic input/output system) is the program stored on the CMOS that the server's microprocessor uses to get the system started after you turn it on. The BIOS also manages data flow between the computer's operating system and attached devices such as the hard disk, video adapter, keyboard, and mouse.

CAUTION: *The BIOS installed on your server was loaded and tested with all the devices initially installed in your system. If you desire to have the BIOS updated, consult TAG technical support in advance as updates to your approved BIOS may cause your system to become unstable or inoperable.*

4.5.1 Common BIOS Settings

Printer Parallel Port-Uni., Bi-directional, Disable, Enable, ECP, EPP

4.5.1.1 Printer Parallel Port Uni., Bi-Directional, Disable, Enable, ECP, EPP.

Settings in the CMOS enable you to configure a parallel port to use Enhanced Parallel Port (EPP) or Enhanced Parallel Port (ECP). ECP, EPP and ECP are bi-directional standards, operate in 8-bit, and allow data transfer speed of approximately 2 MB/s. Some of the main differences are that ECP supports Direct Memory Access (DMA) and data compression, which enables higher transfer rates.

It is also possible to completely disable the parallel port in the BIOS. Most BIOS' allow you to set the DMA channel, when the port mode is set to ECP.

4.5.1.2 Com / Serial Port

Most personal computers have two serial ports. In the BIOS you can assign COM1/COM2/COM3/COM4 to serial port 1 or 2.

Most BIOS' also allow you to set the I/O and IRQ but this is mostly done automatically.

4.5.1.3 Hard Drives

Most modern BIOS' allow automatic detection of disk parameters. The settings can be individually configured for the primary master and slave device and the secondary master and slave device. The following are some of the primary settings that apply to hard drives as well as CD/DVD-ROM drives, tape backup drive, etc.

Common disk types are:

- User-defined Cylinders, Heads, Sectors (CHS) values
- Auto-automatically detects hard disks parameters at every startup
- 1-46-predefined combinations of CHS values
- CDROM-used for AT Attachment Packet Interface (ATAPI) CD-ROM drives
- ARMD-used for ATAPI ZIP and LS 120 drives
- DVDROM

Size - Determines the capacity of the drive **CHS** values

- Number of Cylinders
- Number of Heads
- Number of Sectors
- **LBA** (Large Block Addressing)-technology to overcome the 528 MB limit

4.5.1.4 Boot Sector Virus

A common setting related to hard drives. When enabled, the BIOS issues a warning message/beep if an attempt is made to write to the boot sector or partition table of a hard disk.

4.5.1.5 Memory

Parity adds an extra bit (odd or even) to the 8-bit data-string to ensure data integrity in memory modules. Its successor, ECC, provides improved data integrity by adding information about individual bits.

4.5.1.6 Boot Sequence

This setting is used to control the order that the BIOS uses during the boot process to look for a boot device from which to load the operating system. For example:

- CD
- Floppy
- Hard Disk

4.5.1.7 Date and Time

The Date and Time is set in the BIOS, stored in CMOS, and maintained by CMOS battery.

4.5.1.8 Passwords

In most cases a user (startup) password and a supervisor (setup) password can be set in the CMOS. When a Setup password is required, the computer will prompt for it when you try to access the BIOS setup. When a Startup password is configured, the computer will prompt for it at every startup.

The CMOS password can be reset by shortening the "CMOS restore to factory defaults jumper" or by temporarily removing the CMOS battery.

4.5.1.9 Plug and Play BIOS

Today's BIOS' are Plug and Play (PnP)-aware. This means they are able to automatically assign resources such as IRQ and DMA to PnP devices.

Information about PnP devices is stored in a separate area of non-volatile CMOS memory, called the Extended System Configuration Database (ESCD). Both the PnP BIOS and the operating system can access this area and communicate with each other about resource settings assigned to PnP devices as well as non-PnP devices. For example, when a fixed interrupt request (IRQ) is manually assigned to a particular device using Device Manager, Windows will write this information to the ESCD on shutdown thereby preventing the BIOS from assigning the same IRQ to a PnP device at startup.

You can also reserve IRQs for non-PnP devices in the CMOS setup, this will prevent the BIOS from assigning these reserved resources to PnP devices, a common example is a legacy sound card that needs IRQ 5.

4.5.1.10 Power Management

Modern motherboards provide Advanced Configuration and Power Management Interface (ACPI) settings such as wake-up, power button function and standby/suspend timers. These functions are configured in the CMOS Setup.

4.6 Identifying your I/O Connectors

Figure4-4 shows a typical configuration of I/O connectors. Your configuration may vary depending on the motherboard installed in your server.

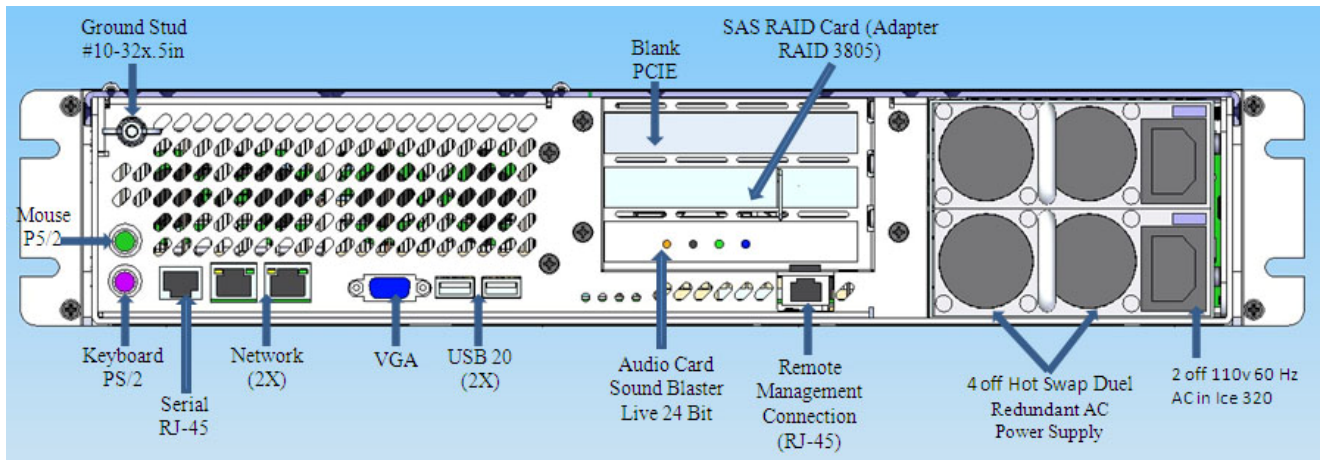

Figure 4-4 I/O Connectors

4.7 Standard Server Components

The following sections provide information on the standard system components installed on TAG servers

4.7.1 CD/DVD Drive

The type of optical drive installed in your server varies per configuration. Figure 4.5.



Figure 4-5 Slot-loading low-profile DVD±R (DL)/-RAM/CD-RW Drive

4.7.2 Dual-redundant, auto-sensing power supply

Power for all the equipment in the system is a dual redundant Hot-Swap AC input Power supply with an Input AC Voltage Range of 115 Vrms nominal, 98 to 138 Vrms (-15%, +20%).

Input Power Line Frequency

The system shall operate over the input power frequency range of 60 Hz nominal, 56.4 to 63.6 Hz (- 6%, + 6%).

Power Connector

The AC input power connector is IEC 320

WARNING

Power supplies contain dangerous voltages. Before attempting to work on any power supply always unplug the device and drain the power source by turning the server on after the power supply has been disconnected. Failure to follow these instructions could result in serious injury due to electrical shock.

To satisfy reliability requirements, TAG servers are designed with Hot-Swappable power supplies. If in the event of a power supply module failure or if the power source fails and only one module is receiving power, an audible alarm sounds. For procedures on how to Hot-Swap a power supply module refer to the Procedures Section of this manual. Replacing a Hot-Swap power supply.

Although most TAG power supplies for the 1U and 4U series servers are similar in physical sizes, and physical characteristics, some servers use smaller foot print power supplies. Figure 4-11 shows a typical 4U Hot-Swap power supply.

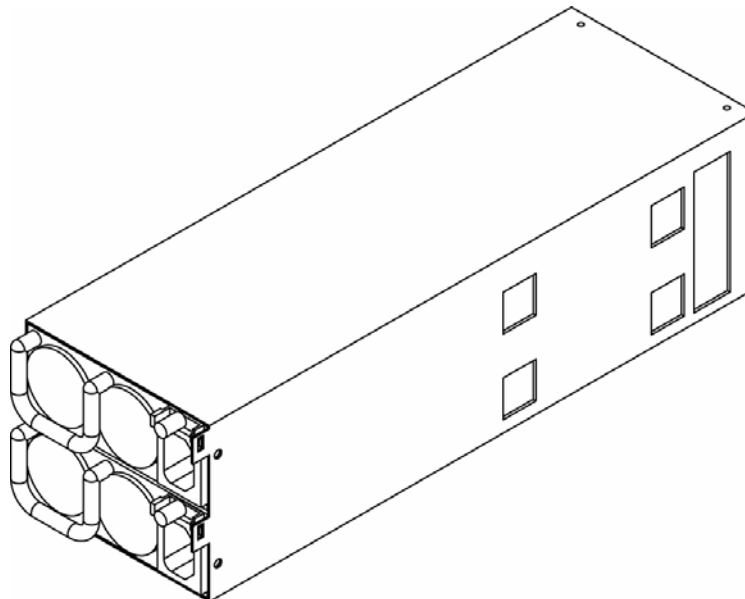

Figure 4-6 Hot-Swap Power Supply

NOTE: *If your server has two power input receptacles, then the server is equipped with a redundant Hot-Swap power supply. Section 5.8.*

4.8 PCI I/O Expansion Cards

The following sections provide an overview of the PCI I/O components that may be included with your server. For detailed information on these components, refer to the manufacturers' websites, or contact TAG Technical Support at tech.support@tag.com. For more information, See back page of this document.

4.8.1 Adaptec PCI-Express RAID Controller

The Adaptec RAID 3805 is an 8-port controller that supports SATA and SAS drives. It features Adaptec RAID Code (ARC) with RAID levels 0, 1, 1E, 5, 5EE, 6, 10, 50, 60, JBOD, as well as Copy back Hot Spare and optional Snapshot Backup. The card has 128MB of DDR2 memory.

4.8.2 PCI Audio Card

The SV-2003-X2 server carries a PCI Sound Blaster 24 –bit Audio card with:

- Patented CMSS 3D Audio Technology
- EAX Music Enhancements
- Full Windows Media Player 9 Support
- Complete Cinematic Surround Sound

4.8.3 Intel Remote Management Module

The Intel RMM2 is used for the initial server set-up, on-going production monitoring and troubleshooting, and for server recovery and maintenance.

Features

- Embedded Web Server Connects administrators to remote servers over a secured connection to monitor system health and perform a variety of maintenance tasks with a supported web browser
- Soft Keyboard via KVM Multiple language support
- Customized Branding Promotes OEM brand through selection of icons, colors, and logos on user interface
- Remote KVM provides full keyboard, mouse, and video access to the server over the LAN
- Virtual Media Redirection allows remote OS and/or software installation and maintenance to access locally attached devices such as floppy drives, CD-ROM drives, hard disks, and USB Flash devices
- Dedicated Network Segments manages traffic onto dedicated networks for administrative and bandwidth optimization
- Interface Card

- Security SSL, SSH, KVM Encryption, authentication using LDAP or RADIUS
- Remote Management, power control or reset remote servers, monitor system sensors, and view the hardware event log
- SMASH CLP, WS-MAN
- Email Alert sends system administrators notifications via email of system changes

Chapter 3

Procedures.

Electronically distributed. Subject to user discretion when printed.

5 Procedures

The procedures within this Chapter contain relevant information to ensure your SV-2003-X2 Server maintains its maximum performance potential.

5.1 Installing Red Hat 4.5 for S5000PAL and Adaptec 3805 system

1. Make sure that the supplied floppy is in a USB floppy drive and attached to the system; be sure the DVD is in the DVD-ROM.
2. With the hard drives set in RAID, enter BIOS and confirm the boot order: **[IDE PM: MATSHITACD...], [AAR-3805 PCI-E RAI...], [IBA GE Slot 0500 v...], [Y-E DATAUSB-FDU ...], [[EFI Shell]]**. (Figure 5.1)

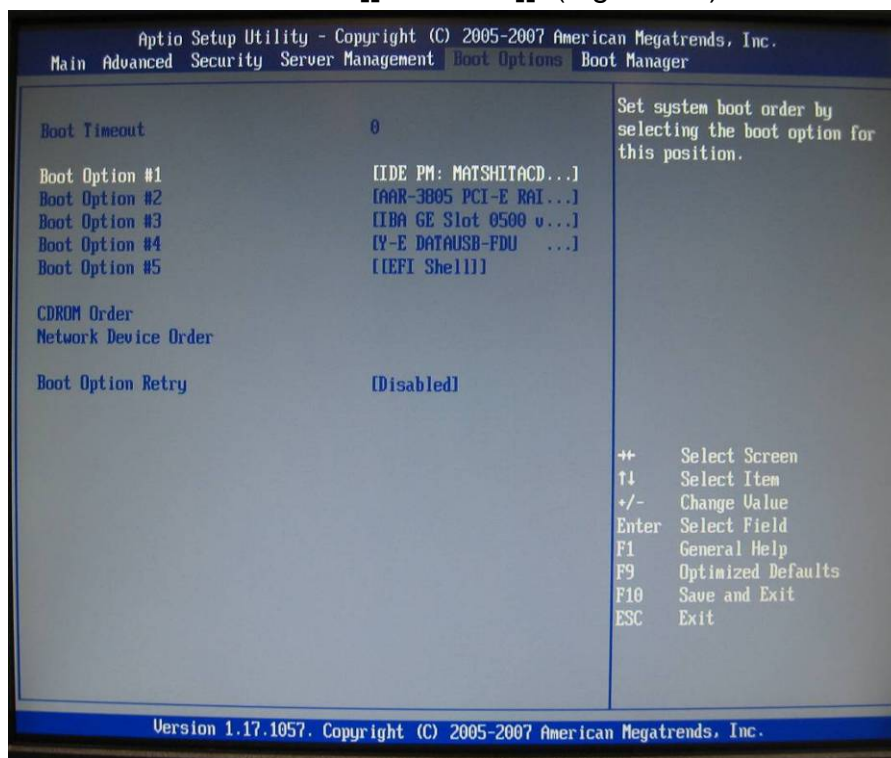

Figure 5-1 Confirm Boot order

3. Once the computer boots to the Red Hat Enterprise Linux 4.5 main screen (Figure 5.2), type the following command as written: Press **Enter**.

This will trigger the automated format and install onto the RAID. After the install is complete the DVD will eject and boot into the Linux OS.



Figure 5-2 Introductory Screen

4. Press Enter

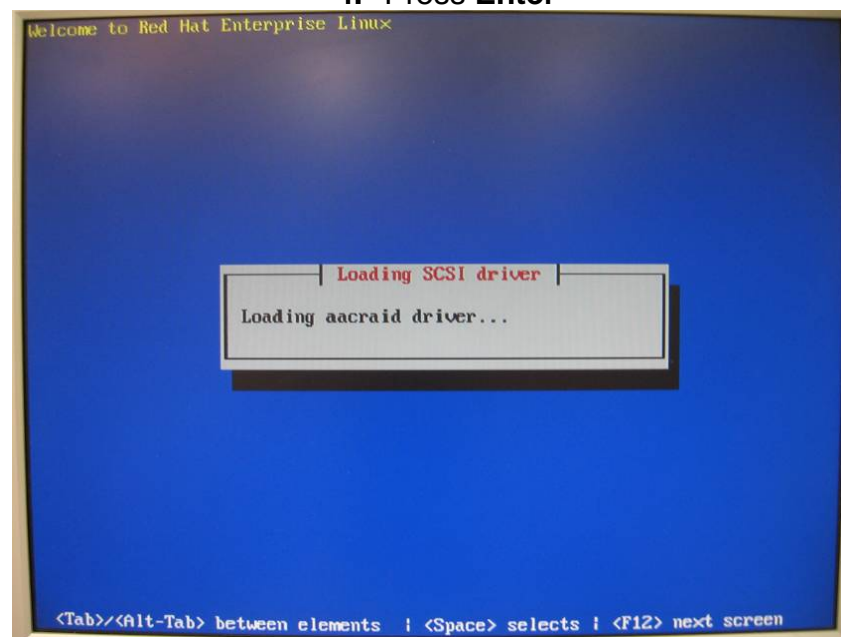

Figure 5-3 Loading Drivers

After the drivers have been installed you will see the full welcoming screen that will allow you to install the full version of Linux 4.5.

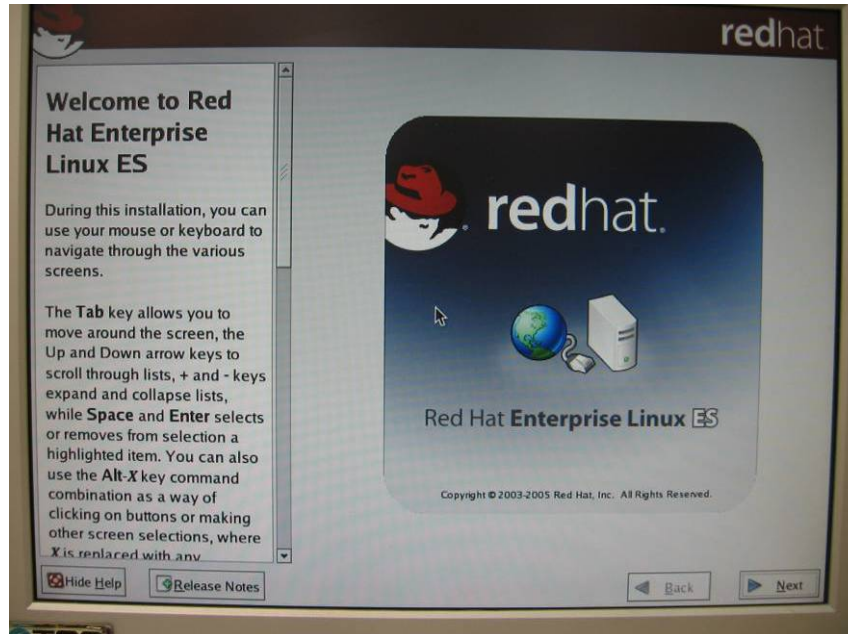

Figure 5-4 Welcome Screen

5. Press **Next**. This will take you to the language screen.

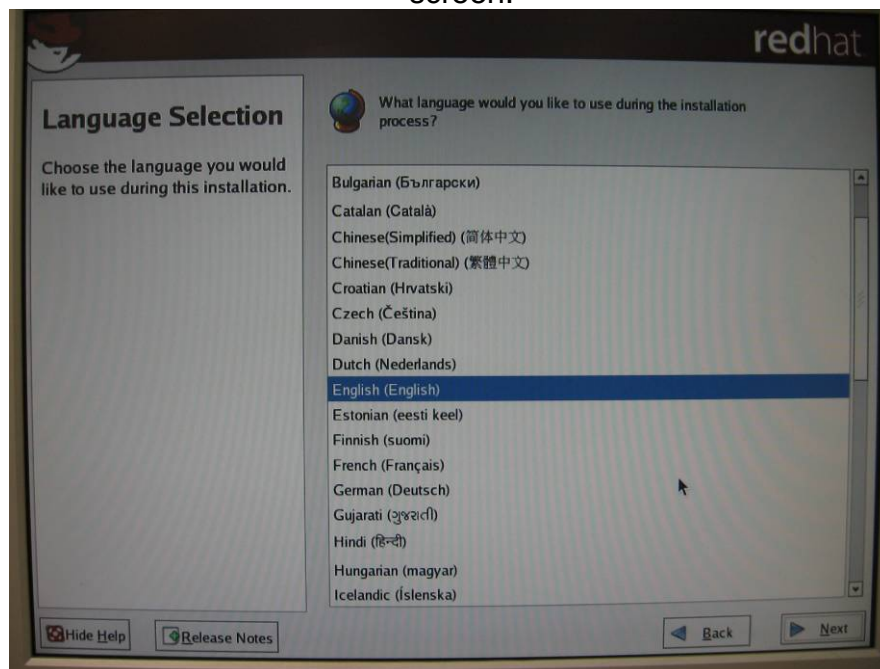

Figure 5-5 Language Screen

6. At the language screen **select** English (English) and Press **Next**.

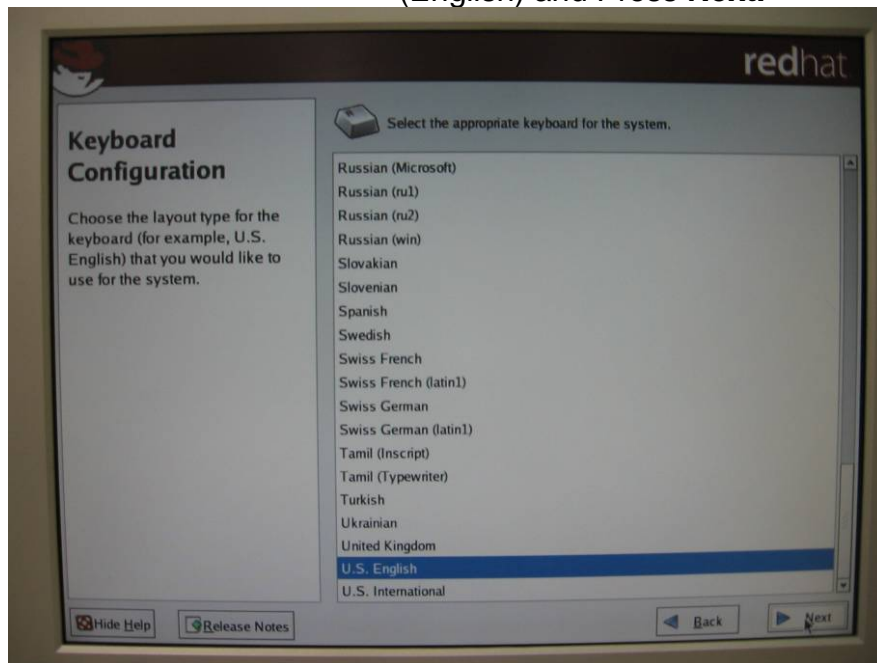

Figure 5-6 Keyboard Selection

7. Select the appropriate keyboard selection and press **Next**.

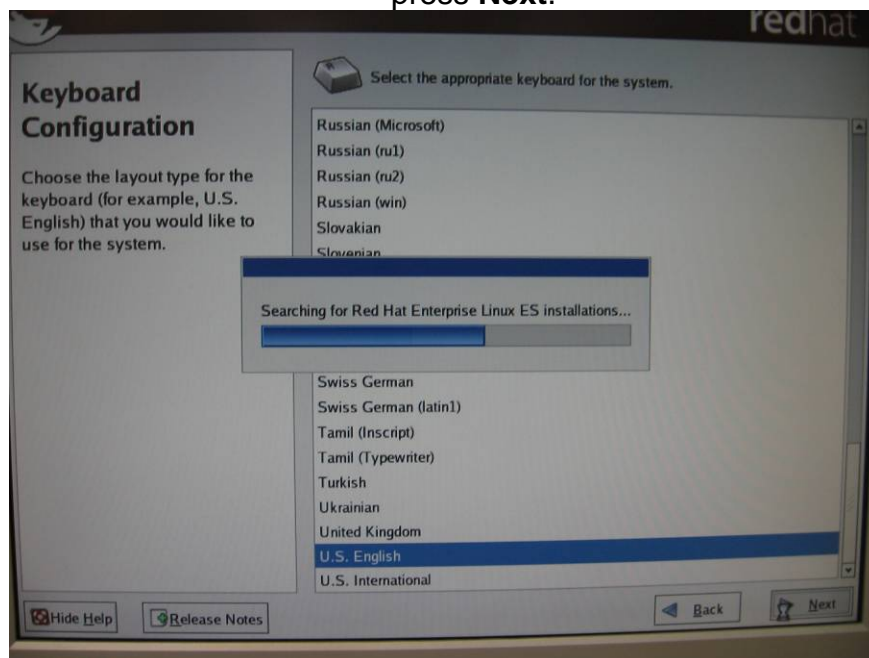

Figure 5-7 Search for previously installed installations

- At the keyboard screen and after keyboard is chosen the system will automatically search for previously installed configurations. Press **Next**.

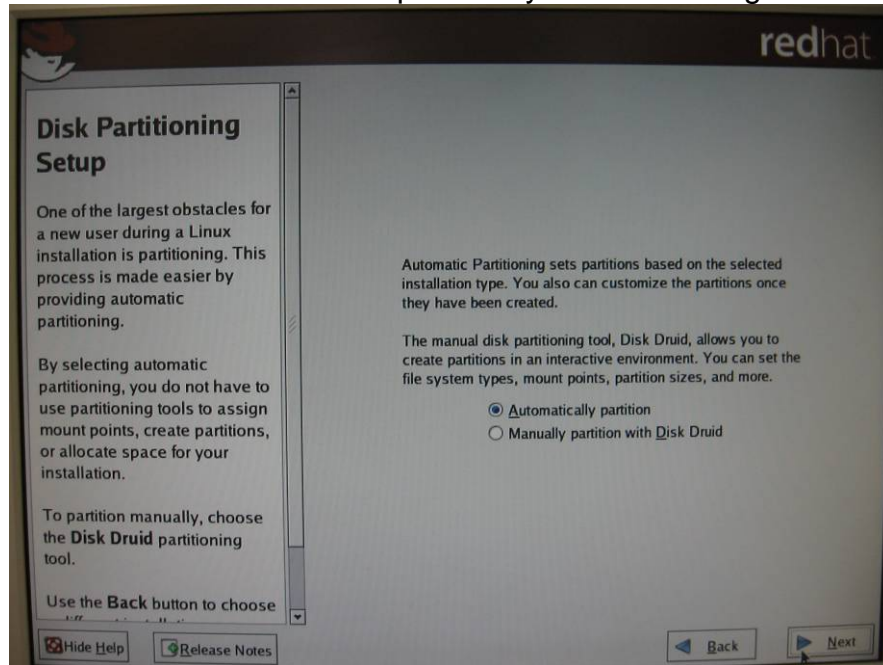

Figure 5-8 Disk Partitioning Setup

- Select Automatic Partitioning and Press **Next**.

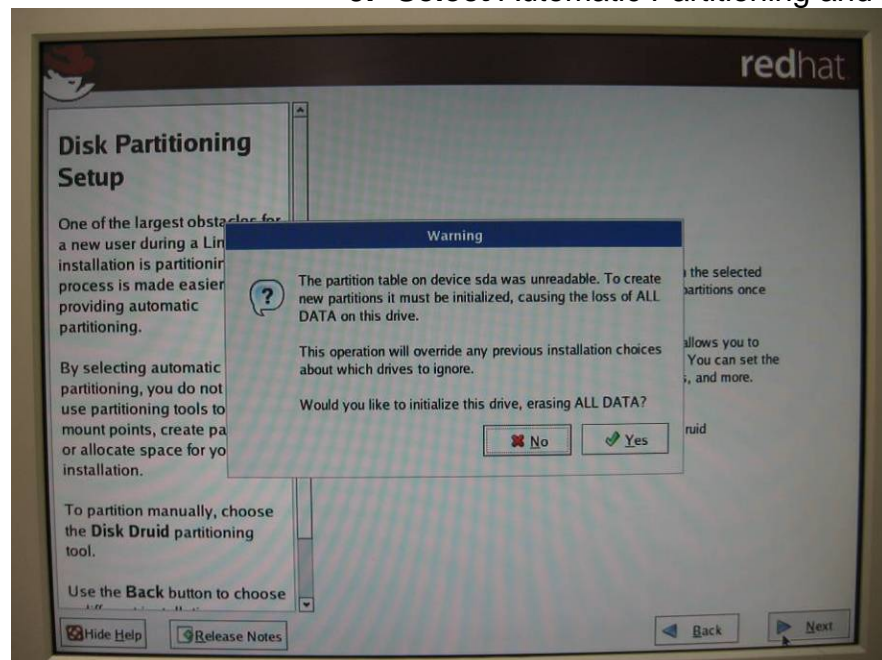

Figure 5-9 Disk Partition Warning

10. At the Disk Partitioning Warning Select YES and Press Next.

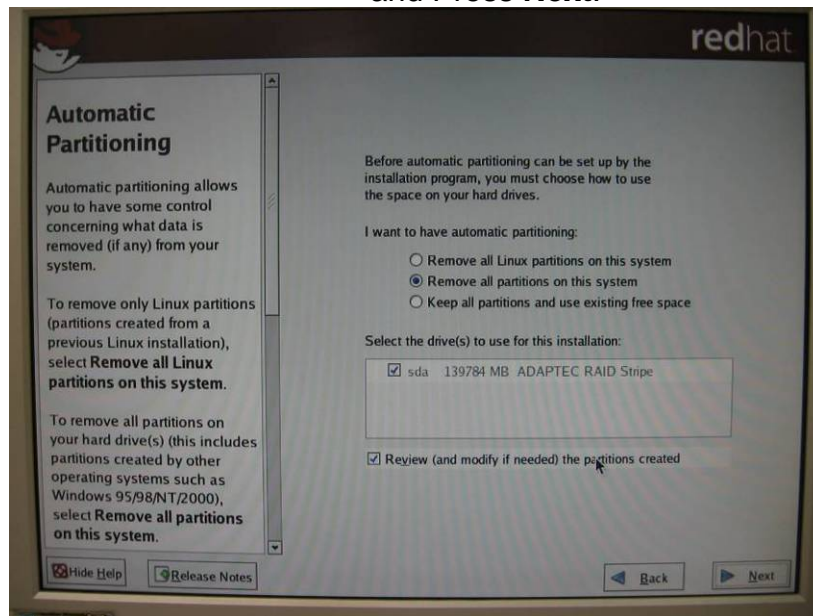

Figure 5-10 Automatic partitioning

At the Automatic partitioning screen Select **“Remove all Partitions on this system.”** Ensure that both driver sda-139784 MB ADAPTEC RAID stripe and Review (and modify if needed) the partitions created are **checked**. Press **Next**.

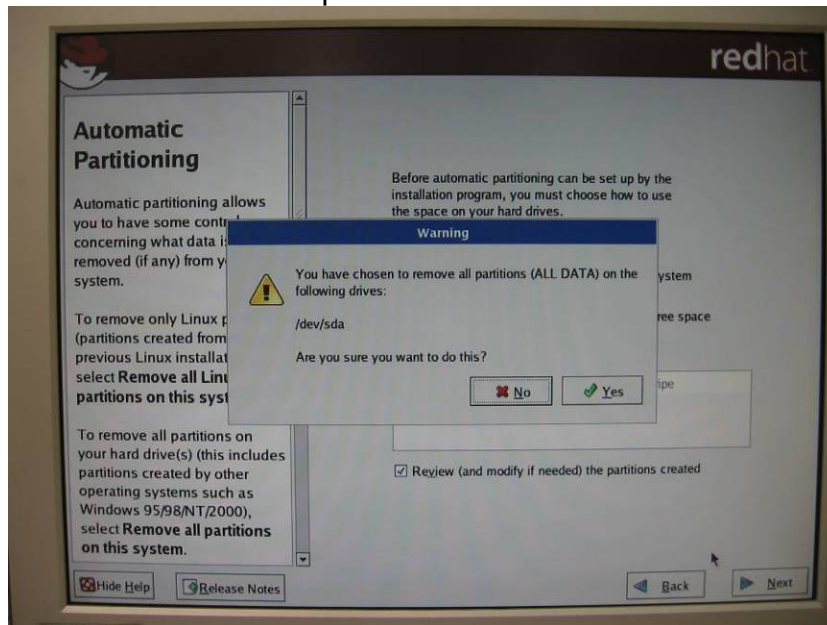

Figure 5-11 Automatic Partitioning (Warning)

11. At the Automatic Partitioning screen a further warning will appear. Select **YES** and Press **Next**.

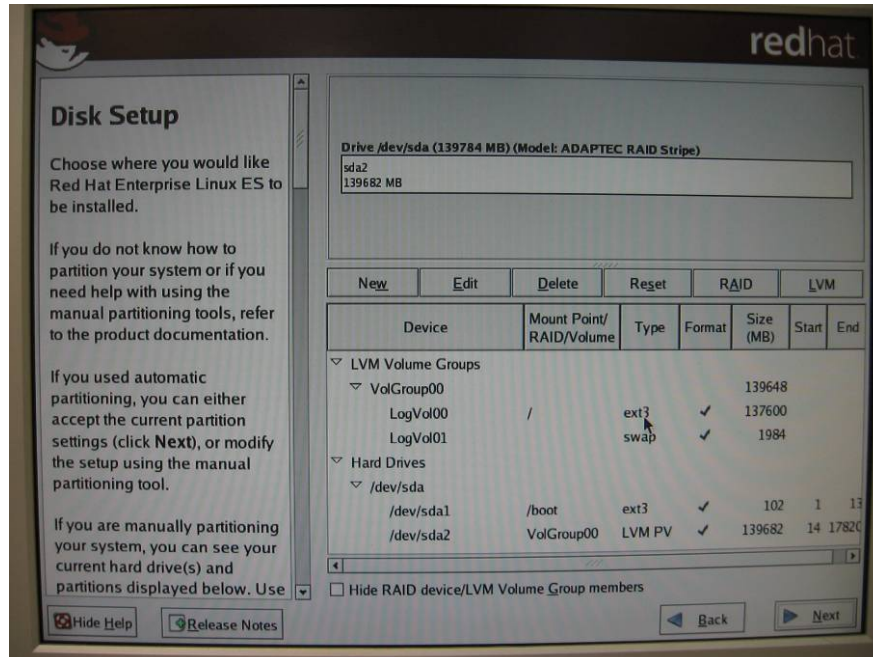

Figure 5-12 Disk Setup

12. Leave the settings on default and Press **Next**.

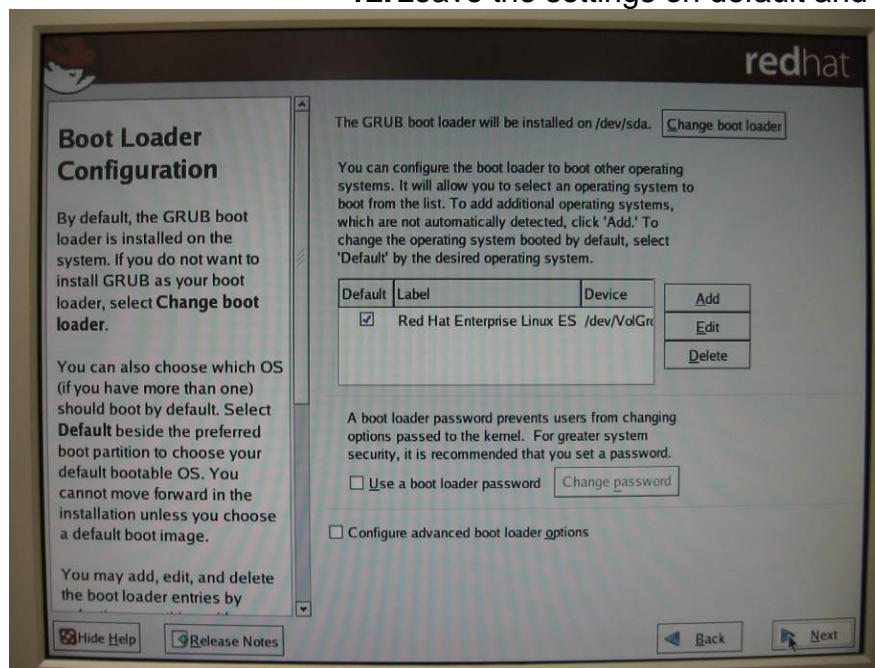

Figure 5-13 Boot Loader Configuration

13. Leave the settings on default and Press Next

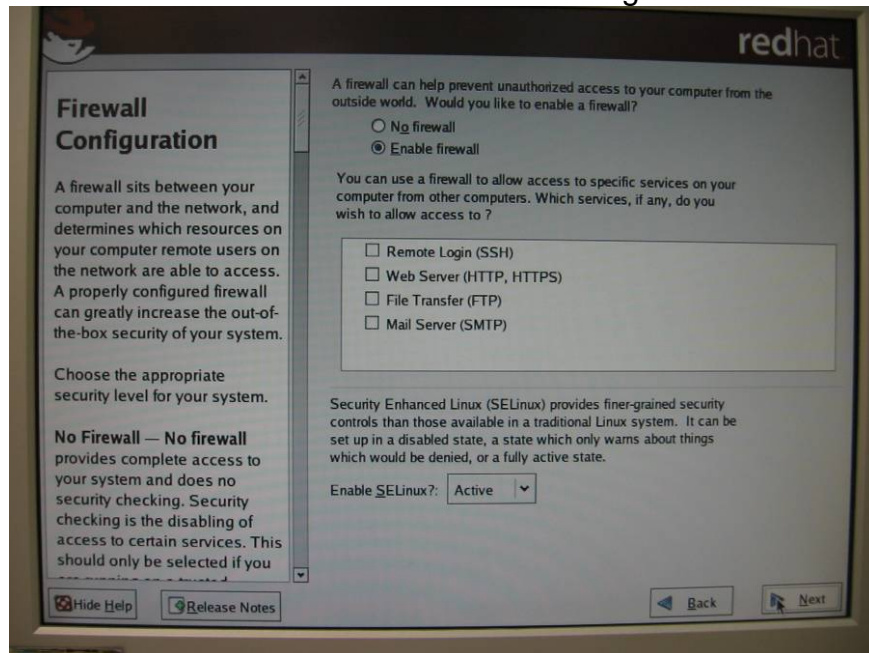

Figure 5-14 Firewall Configuration

14. Check “Enable Fire Wall” Press Next.

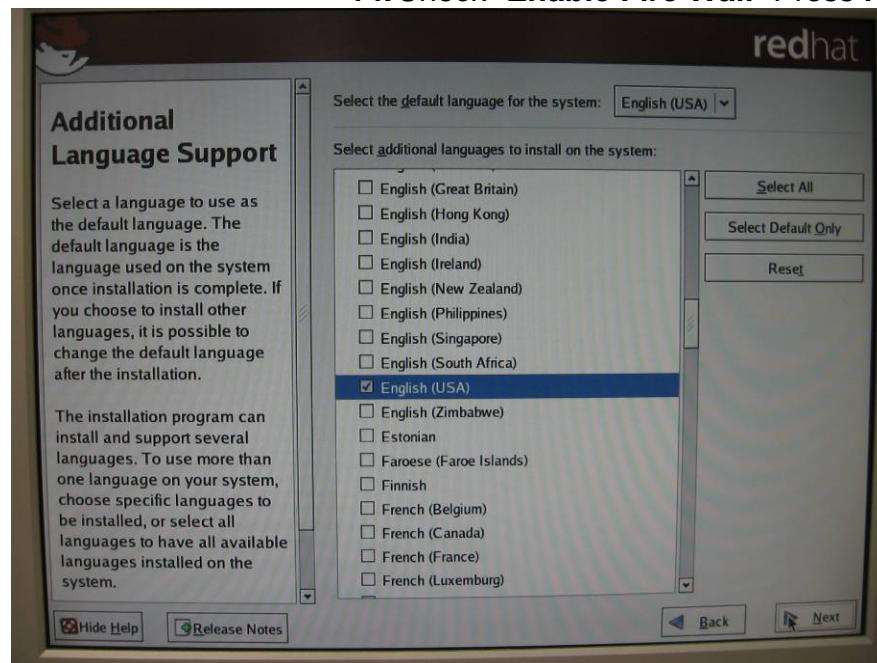

Figure 5-15 Additional Language Support

15. At the “Additional Language Support” screen Check **English (USA)**. Press **Next**.

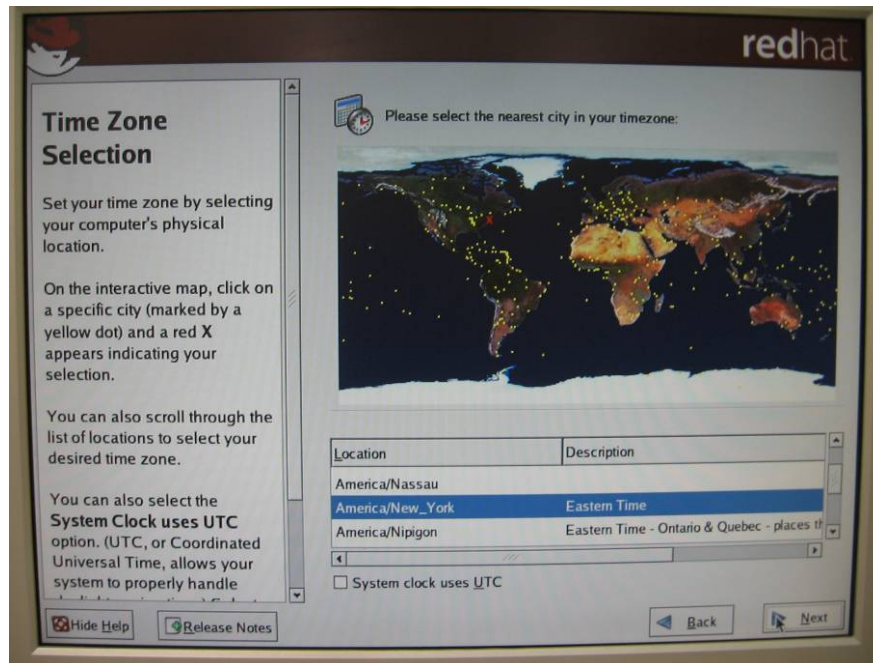

Figure 5-16 Time Zone Selection

16. At the “Time Zone Selection” screen Select **America/New York, Eastern Time**. Press **Next**.

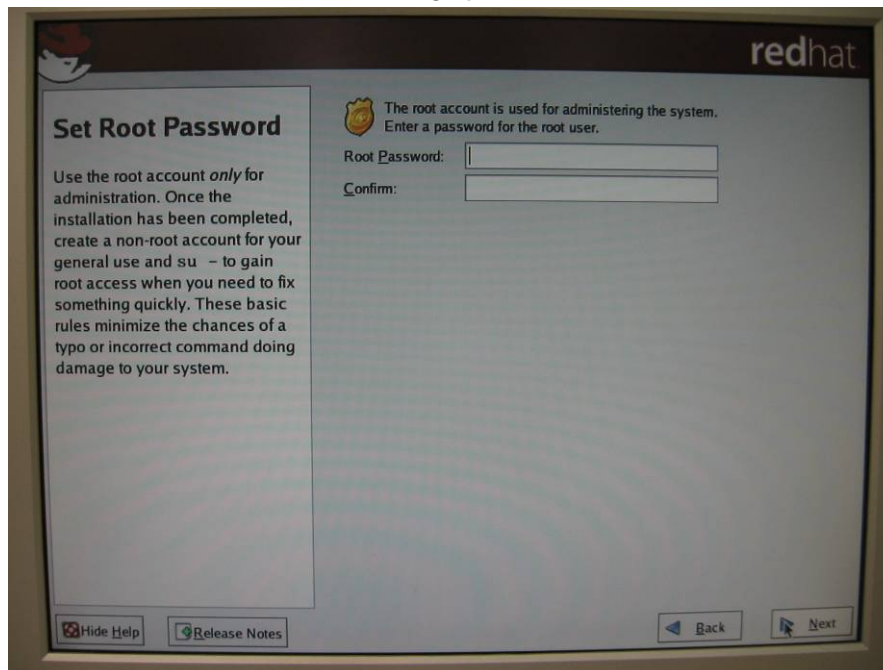

Figure 5-17 Set Root Password

17. Enter and confirm account password. Must enter Password as **“Password”** selection. Press **Next**.

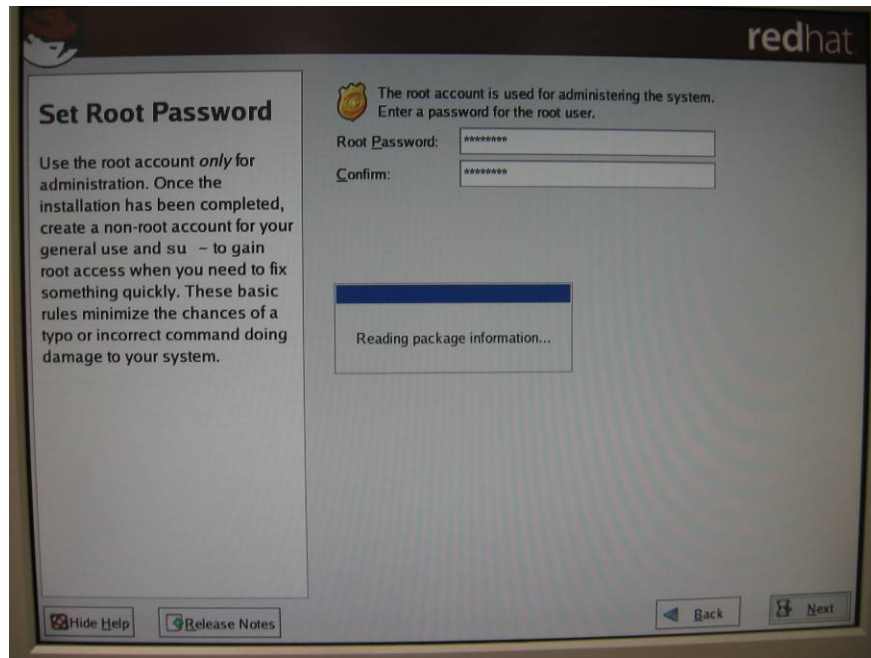

Figure 5-18 Set Root Password (Confirmation)

18. Confirm Root User password selection. Press **Next**.

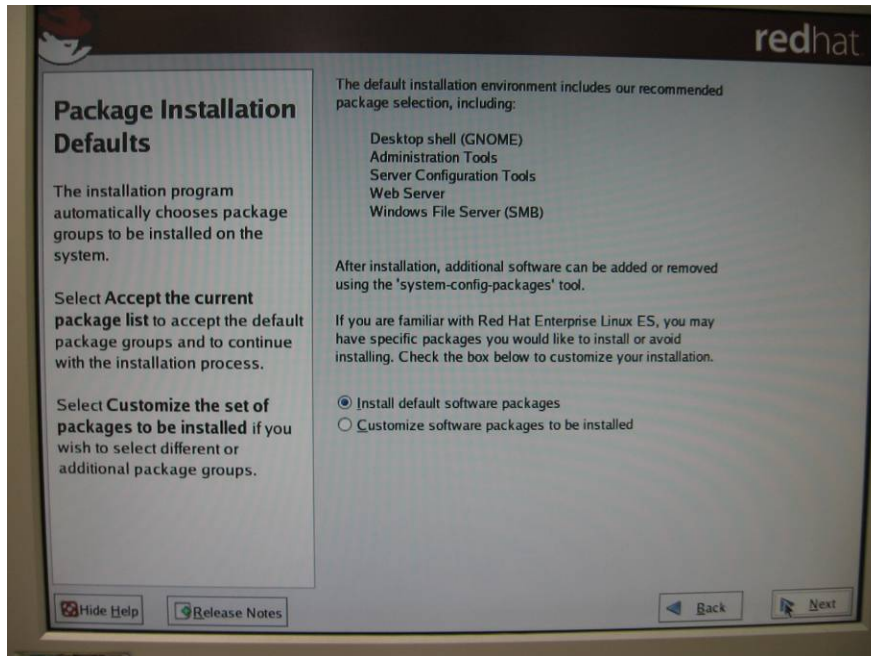

Figure 5-19 Package Installation Defaults

19. On the “Package Installation Default” screen
Select “Install Default Software Packages”.
Press **Next**.



Figure 5-20 About to Install

CAUTION: *Once you click Next there is no undo.*

20. Press **NEXT** to begin installation.



Figure 5-21 Installation

21. Press Next

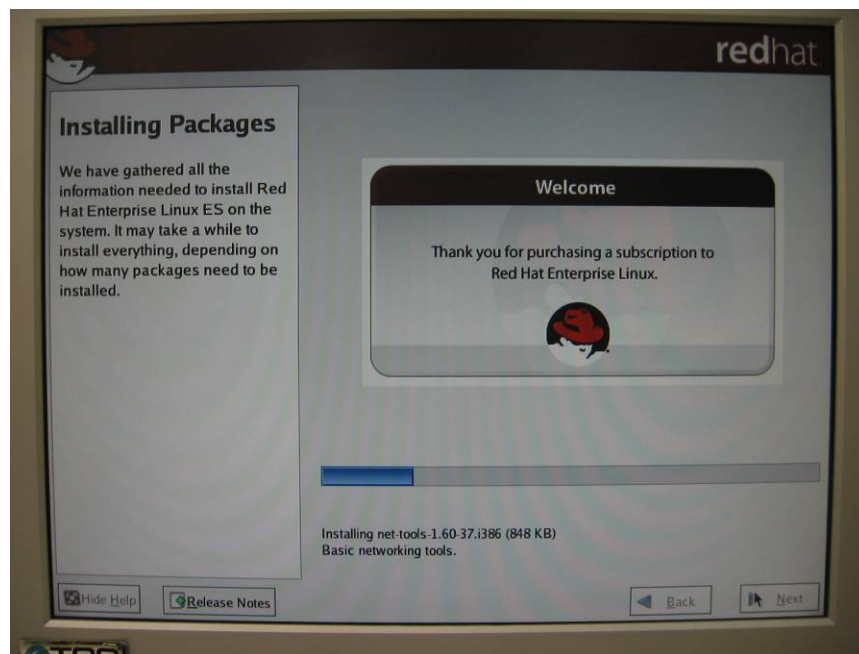

Figure 5-22 Still Installing Buttons are disabled.

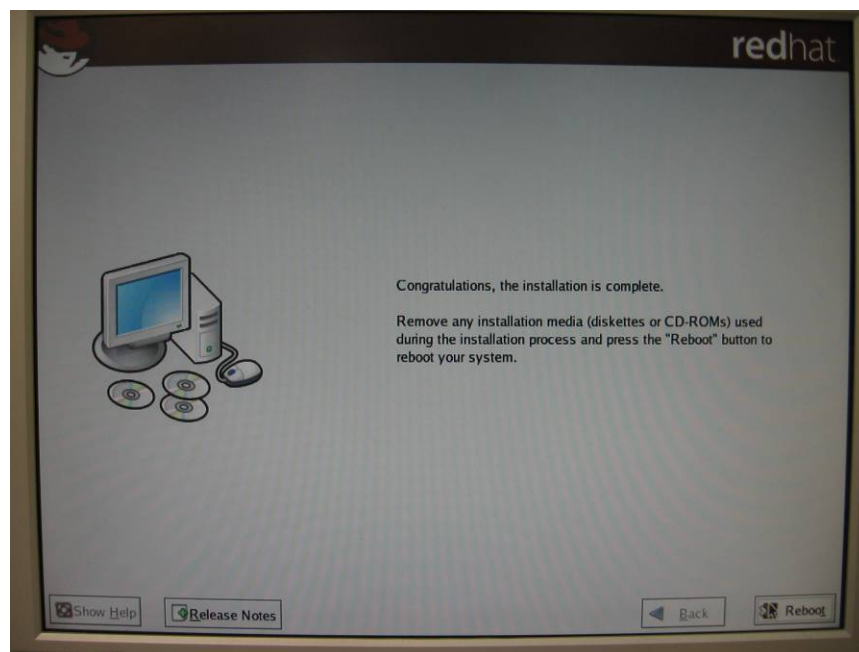

Figure 5-23 Installation Complete

22. Remove all diskettes or CD ROMs. Press **REBOOT**.

23.

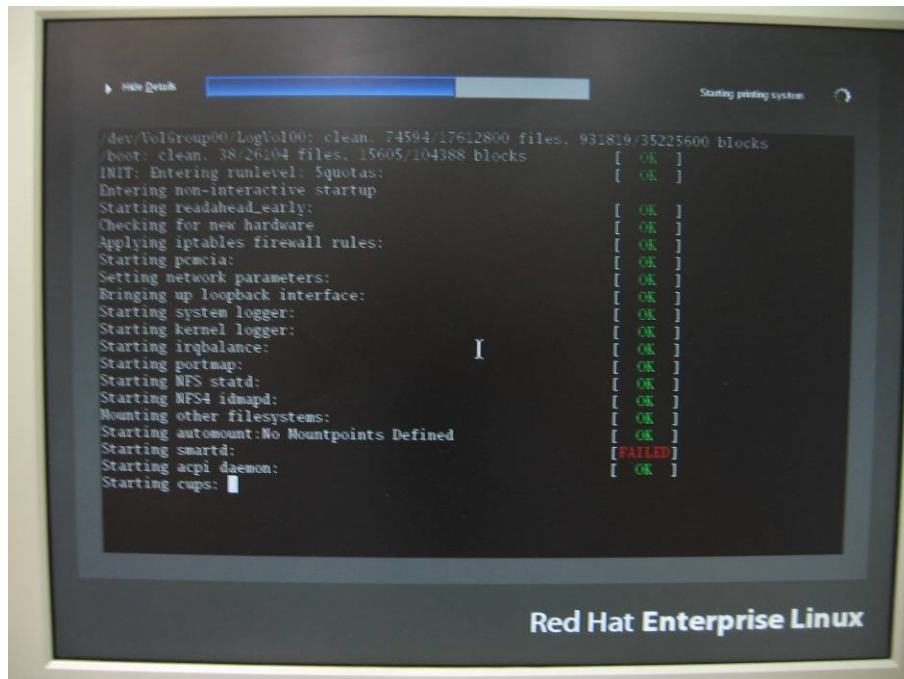

Figure 5-24 System Check



Figure 5-25 Welcome

24. Press **Next**.

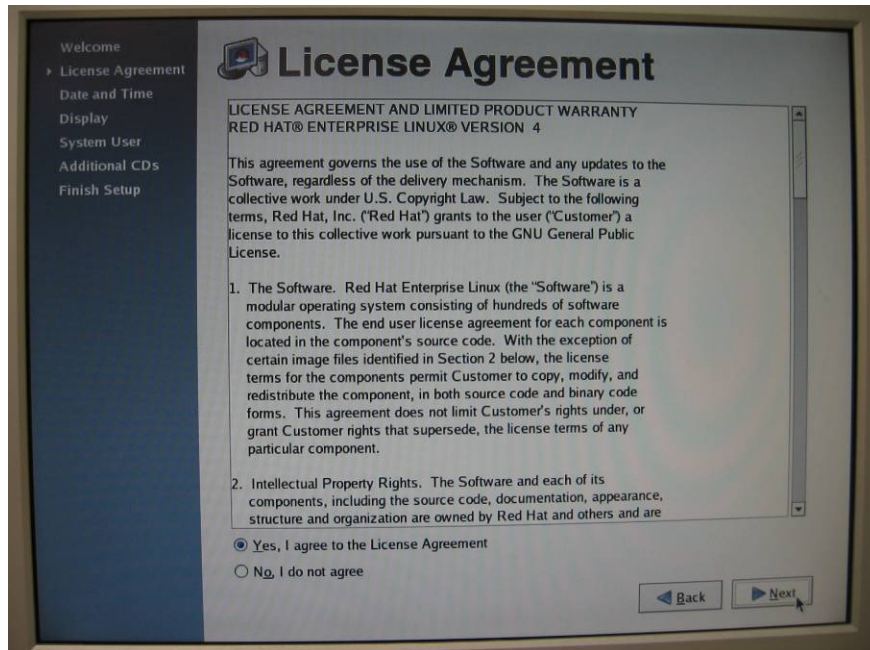

Figure 5-26 License Agreement

Check **YES** if you agree to the licensing agreement. Press **Next**.

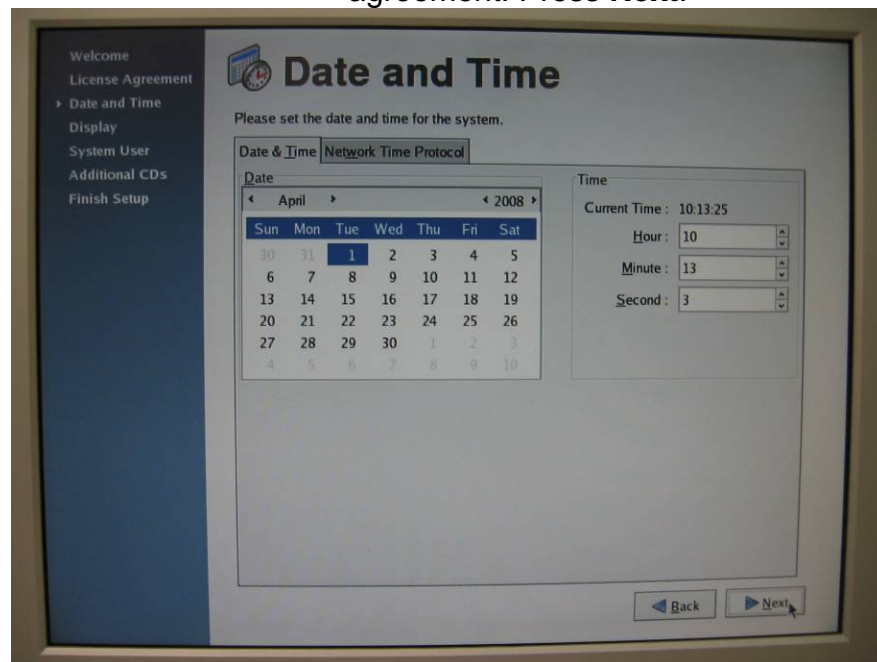

Figure 5-27 Set Date and Time

25. Set Date and Time for the system. Press **Next**.

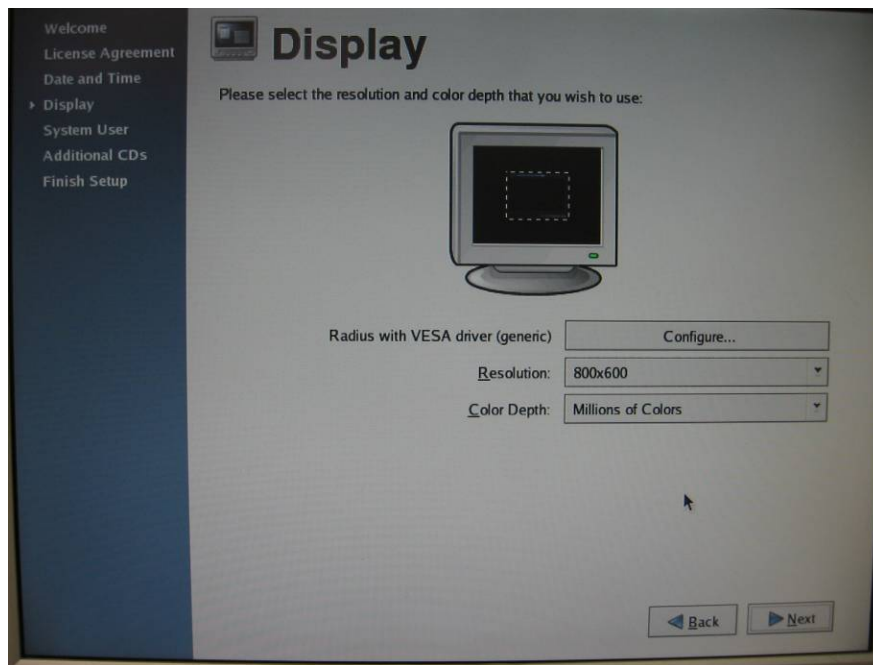

Figure 5-28 Set Display Color and Resolution.

26. Press Next.

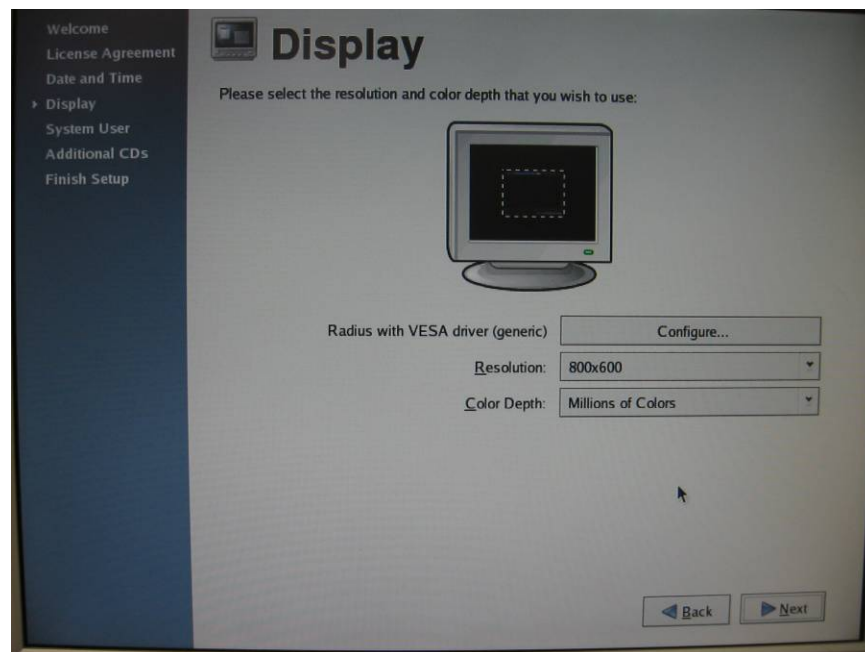

Figure 5-29 Set Color Depth

27. Change the Resolution to "1024 x 768" (Your displays optional resolution. Default is 1024 x 768.). Press Next.

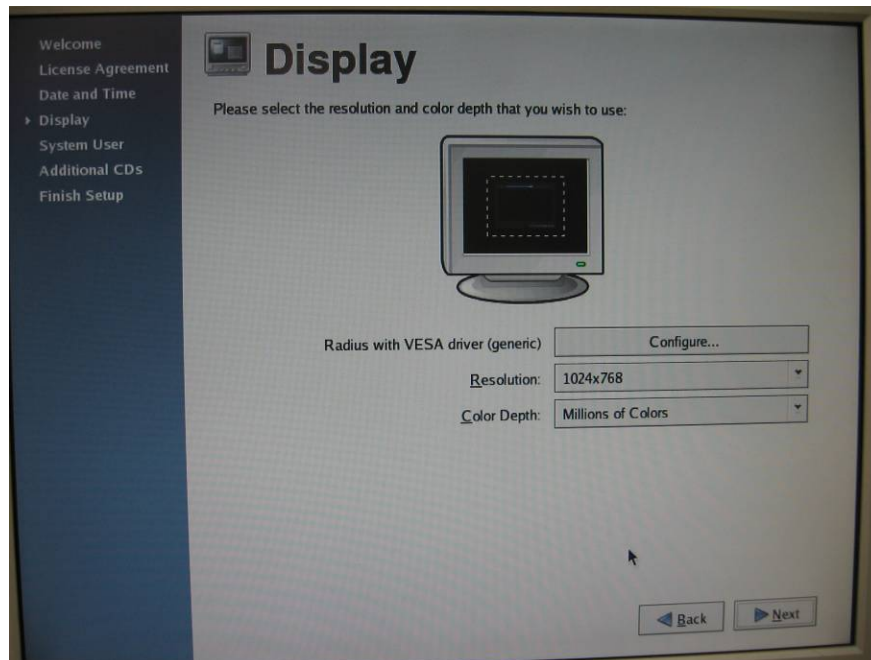

Figure 5-30 Display

28. Select Color display and Resolution. Press **Next**.

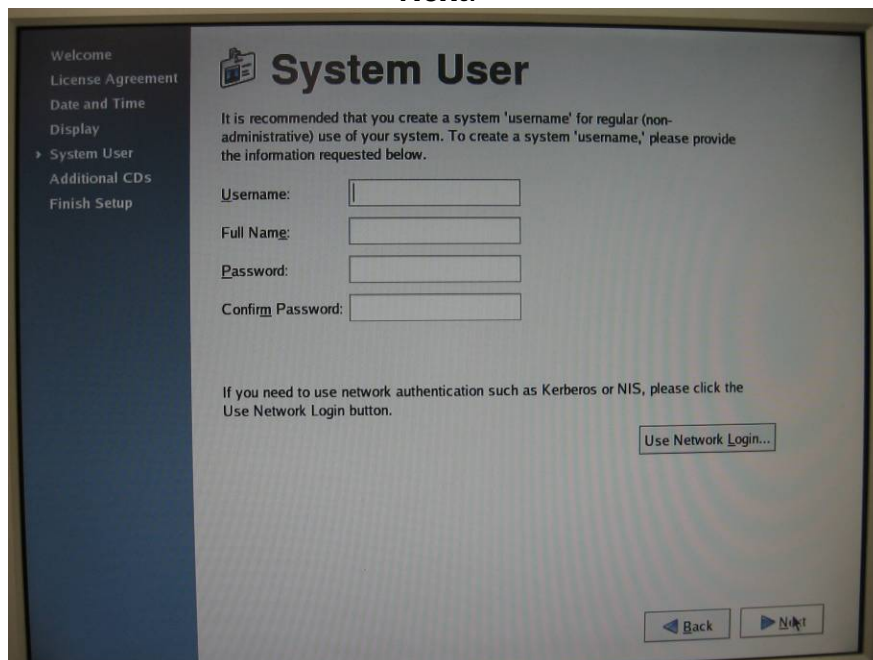

Figure 5-31 System User (Non Administrative)

29. Press Next.

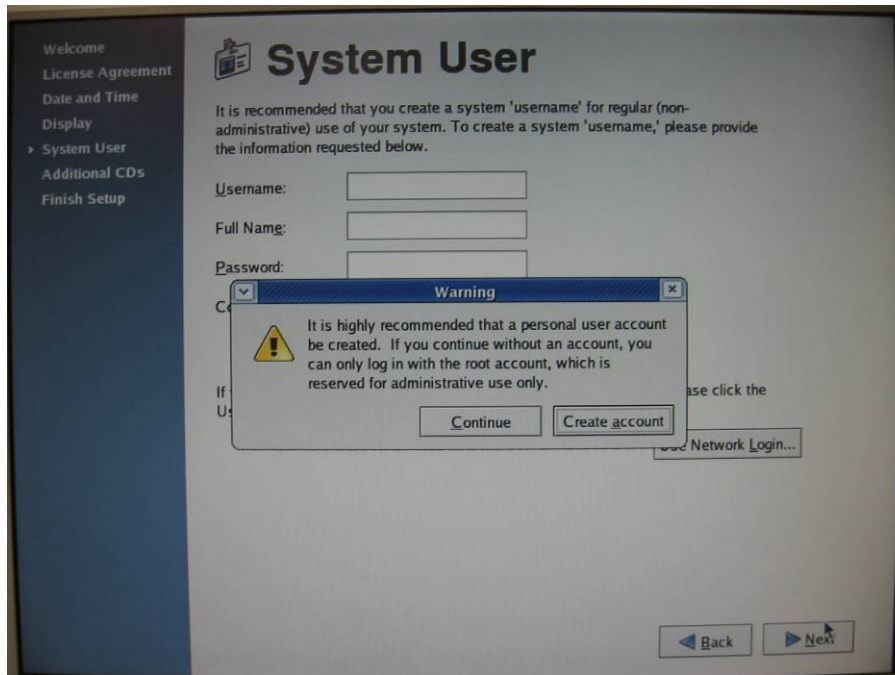

Figure 5-32 Personal user Account

30. Create a Personal User Account. Click **Continue** and Press **Next**.

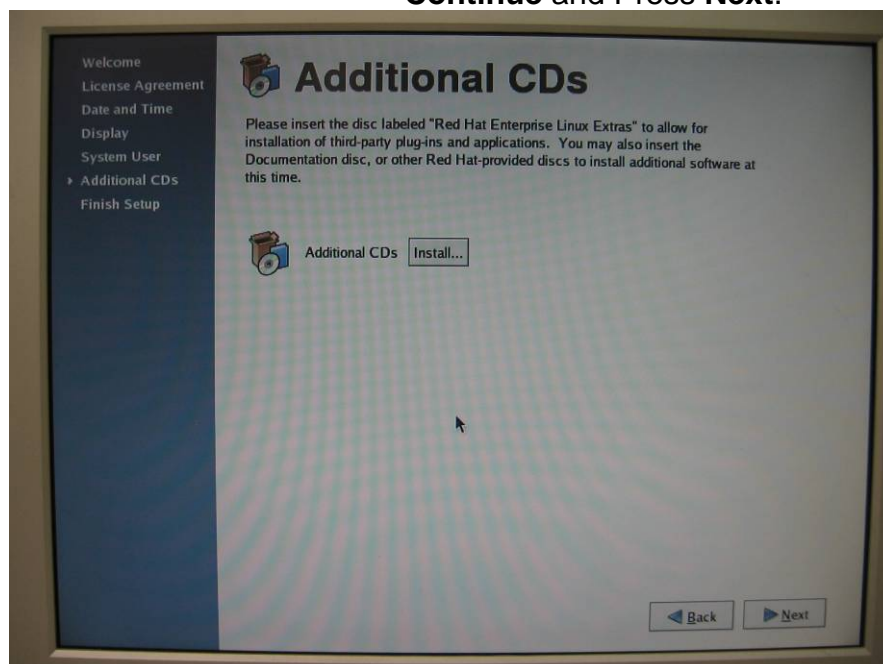

Figure 5-33 Additional CDs

31. Installation as required. Press **Next**.



Figure 5-34 Finish Setup

32. Press Next

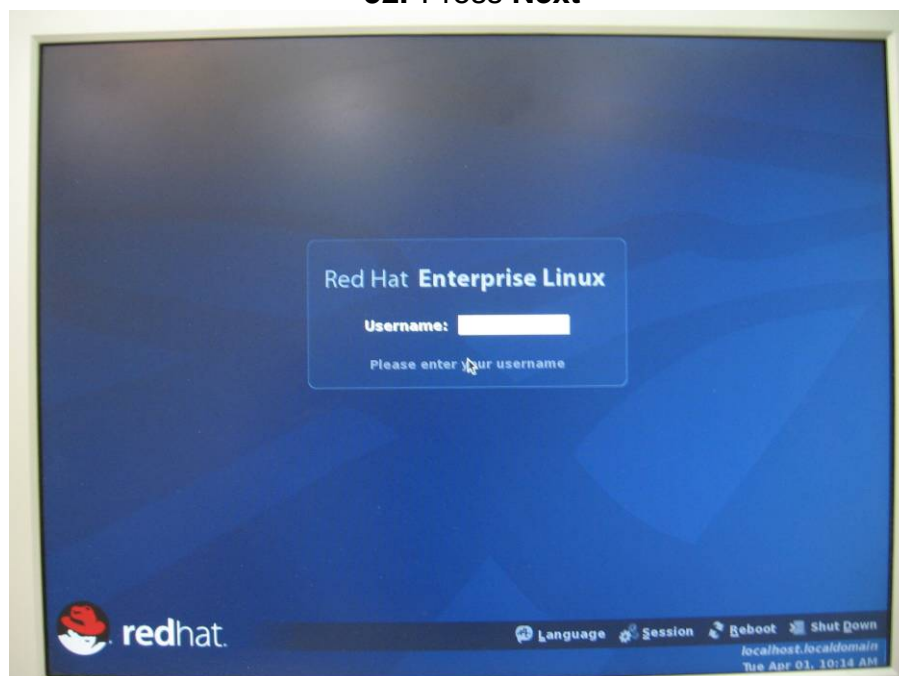

Figure 5-35 Log In Screen

33. Enter User name.

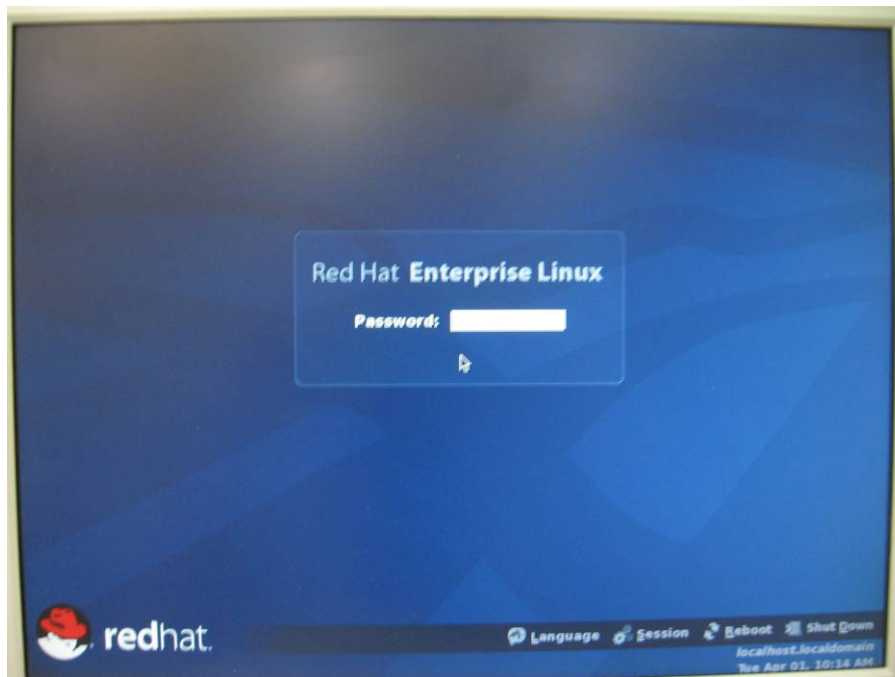

Figure 5-36 Log in Screen

34. Enter Password. Installation Complete.

5.2 Server Startup

1. Check to make sure that all the cables are seated and connected correctly to the back of the unit such as keyboard, mouse, monitor VGA cable and both power cables.
2. Then Press the **power switch** ON to start the computer (power switch is located in the front of the unit)
3. Once the unit starts, System will go thru Power On self Test (POST) (no action is required at this time)
4. At windows dialog box press **Ctrl, Alt, Delete** at once to login
5. Type in the **correct user name** and **password** and then press **enter** to login
6. Once the operator is logged on to the unit they could use the computer as they wish.

NOTE: Assuming the server is not connected to any network.

5.3 Server Shutdown

1. The operator needs save any data that is needed to be saved and then close application
2. Once all data is save and applications are closed, click on **Start menu**, select shutdown and then click **OK** to shutdown the computer.

5.3.1 BIOS Configuration for SV-2003-X3

1. On the Main page, change Quiet Boot to **[Disable]**. Set the System date and time. (Figure 5-11).

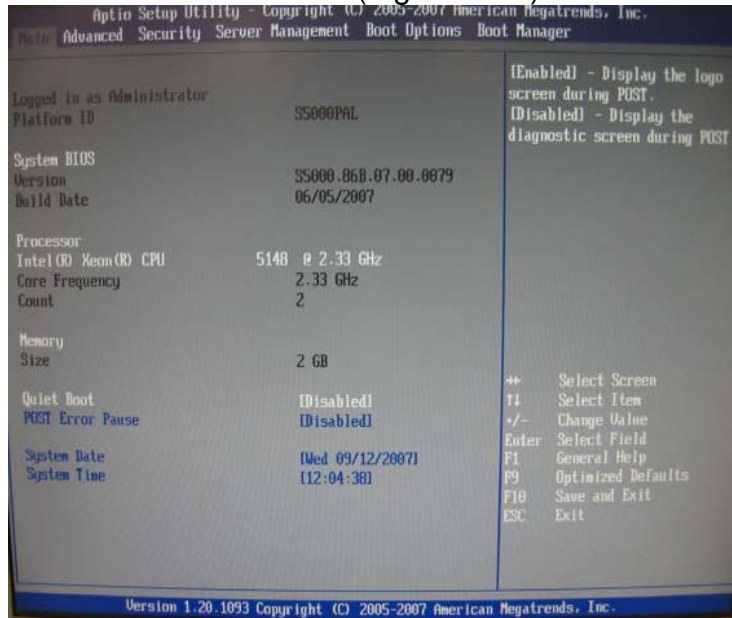

Figure 5-37 BIOS Setup

2. No changes for Processor Configuration. (Figures 5-12 & 5-13)

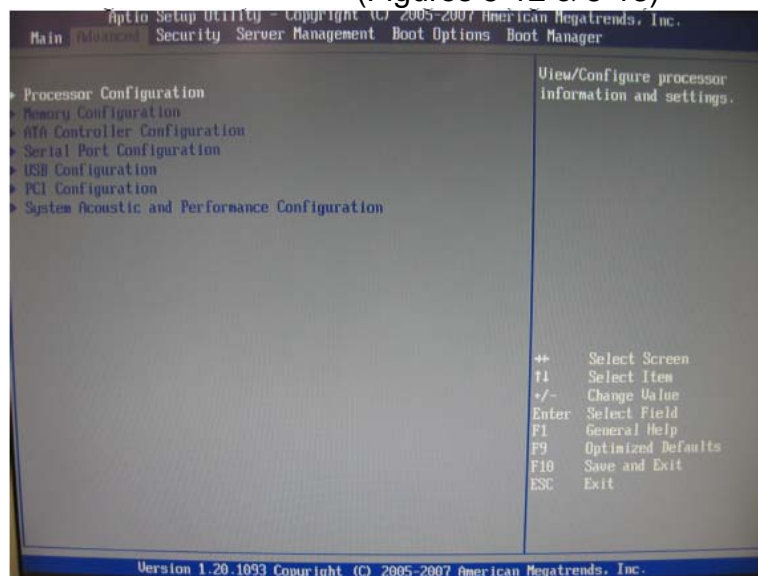

Figure 5-38 Processor Configuration

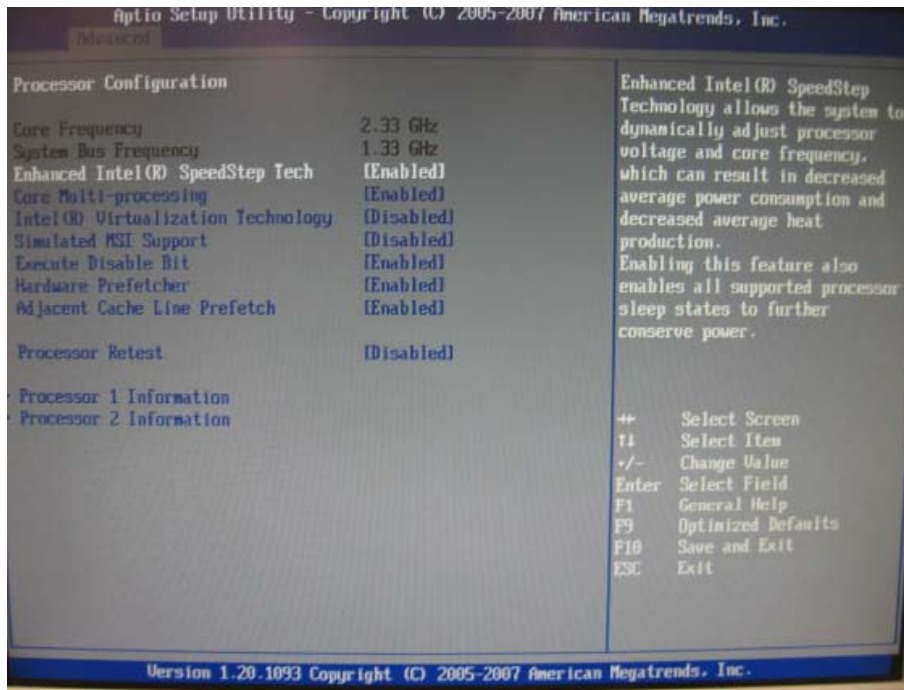

Figure 5-39 Processor Configuration

3. No changes for Memory Configuration. (Figure 5-14)

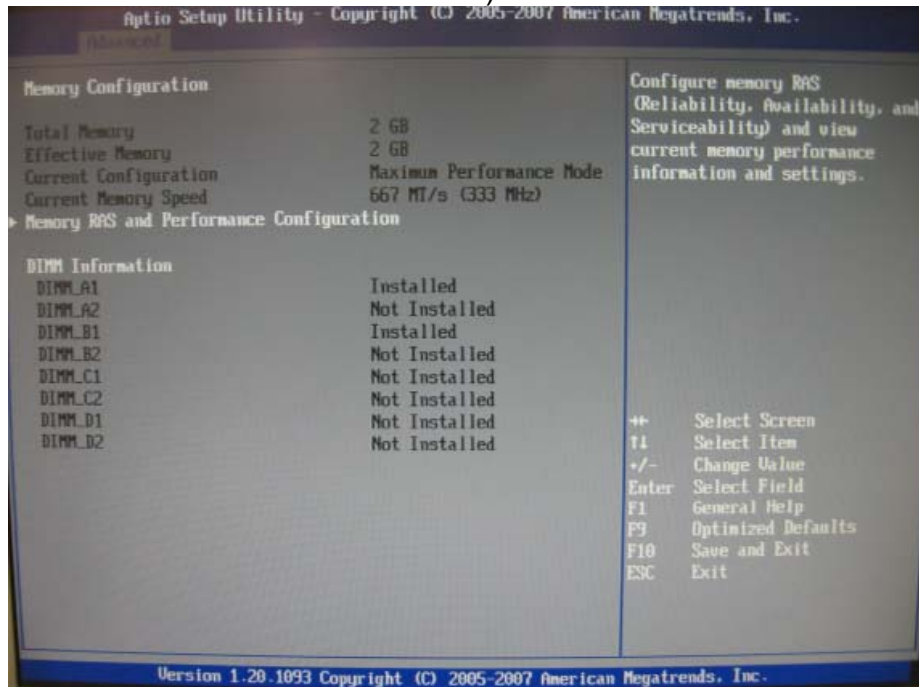

Figure 5-40 Memory Configuration

4. No changes for ATA Controller Configuration.
(Figure 5-15)



Figure 5-41 ATA Controller Configuration

5. No changes for Serial Port Configuration.
(Figure 5-16)



Figure 5-42 Serial Port Configuration

6. No changes for USB Configuration. (Figure 5-17)

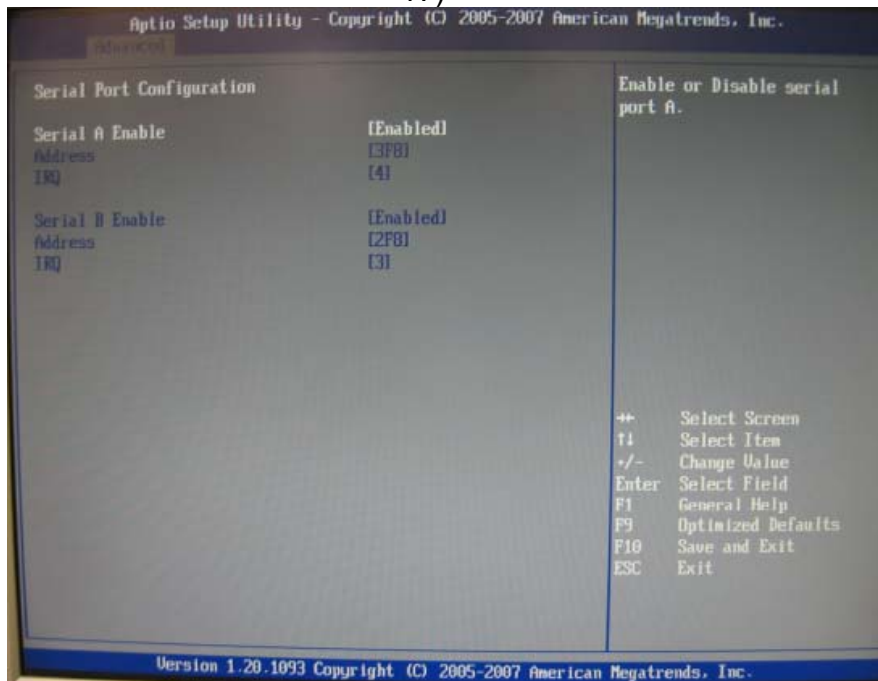

Figure 5-43 Floppy/USB Configuration

7. No changes are necessary for PCI Configuration. (Figure 5-18)

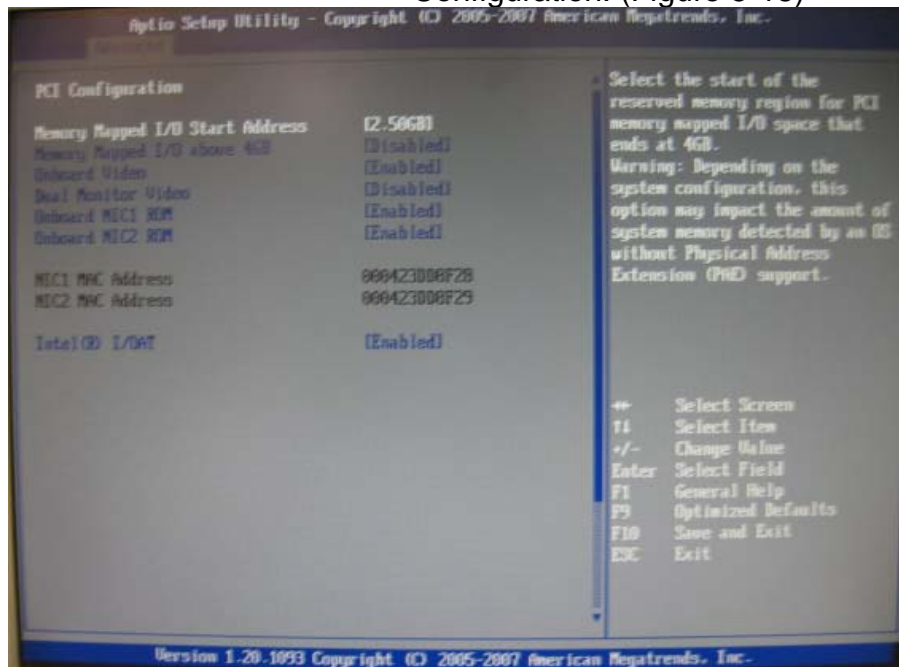

Figure 5-44 PCI Configuration

8. No changes for System Acoustic and Performance Configuration. (Figure 5-19)

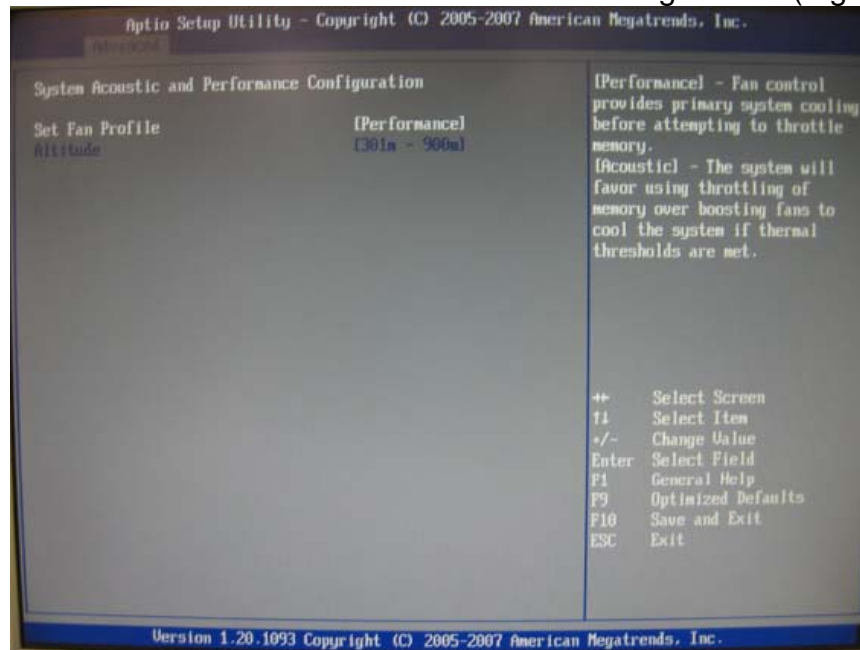

Figure 5-45 System Acoustic Configuration

9. No changes for Security. (Figure 5-20)

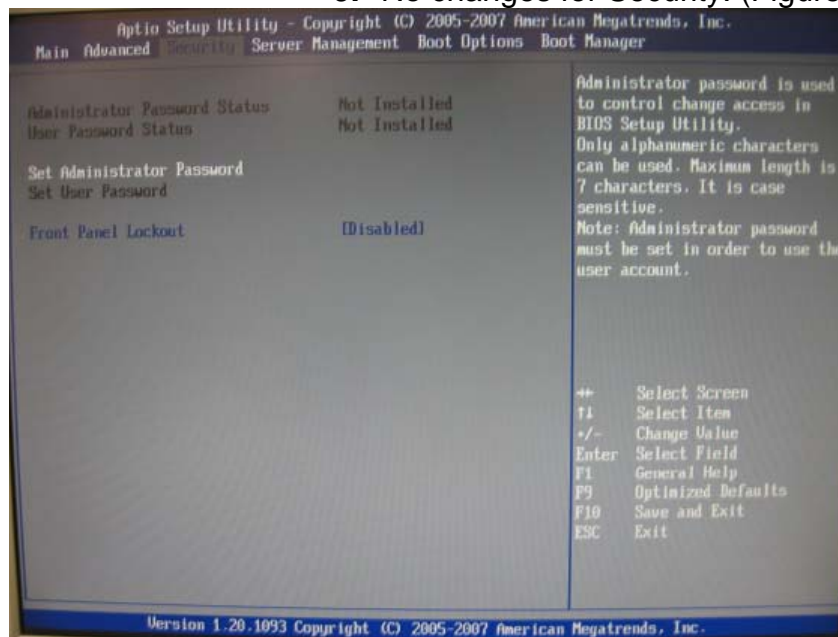

Figure 5-46 Security

10. No changes for Server Management. (Figure 5-21)

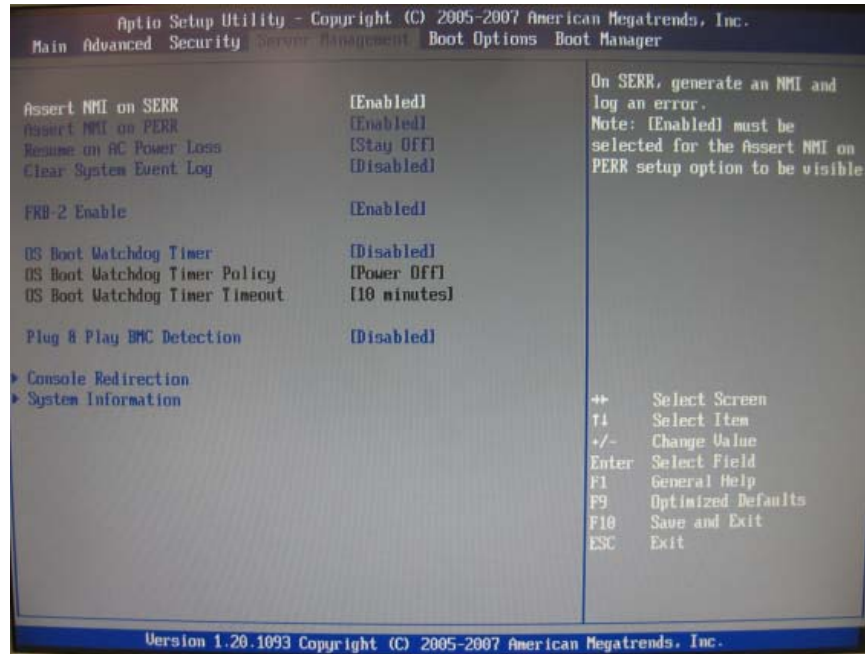

Figure 5-47 Server Management

11. Set boot order as follows: **DVD (IDE PS)**, **RAID (AAR-3805)**, **LAN (IBA GE)** and finally the **EFI Shell**. (Figure 5.22).

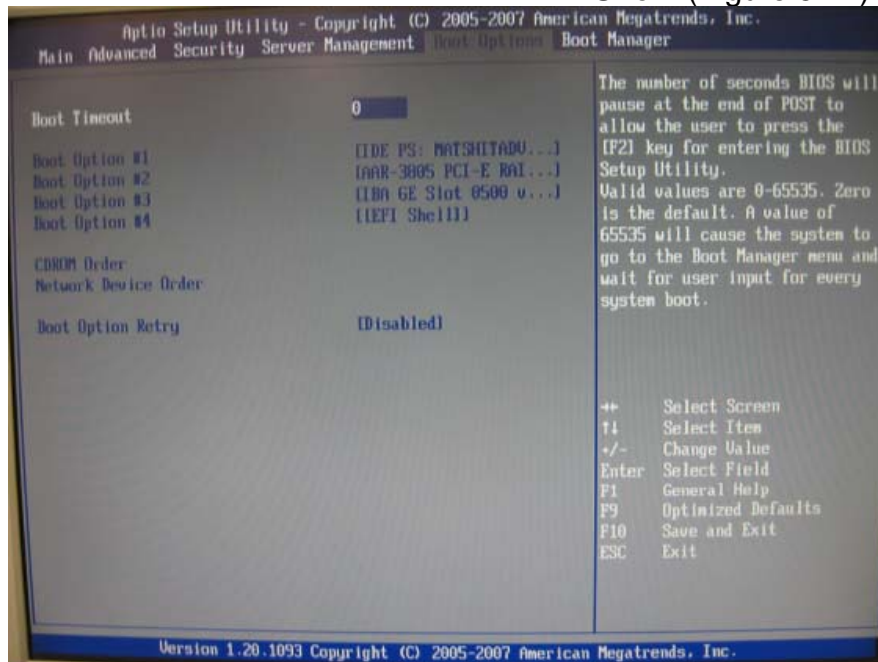

Figure 5-48 Boot Order.

12. Select **Save changes** and Exit.. (Figure 5-23)

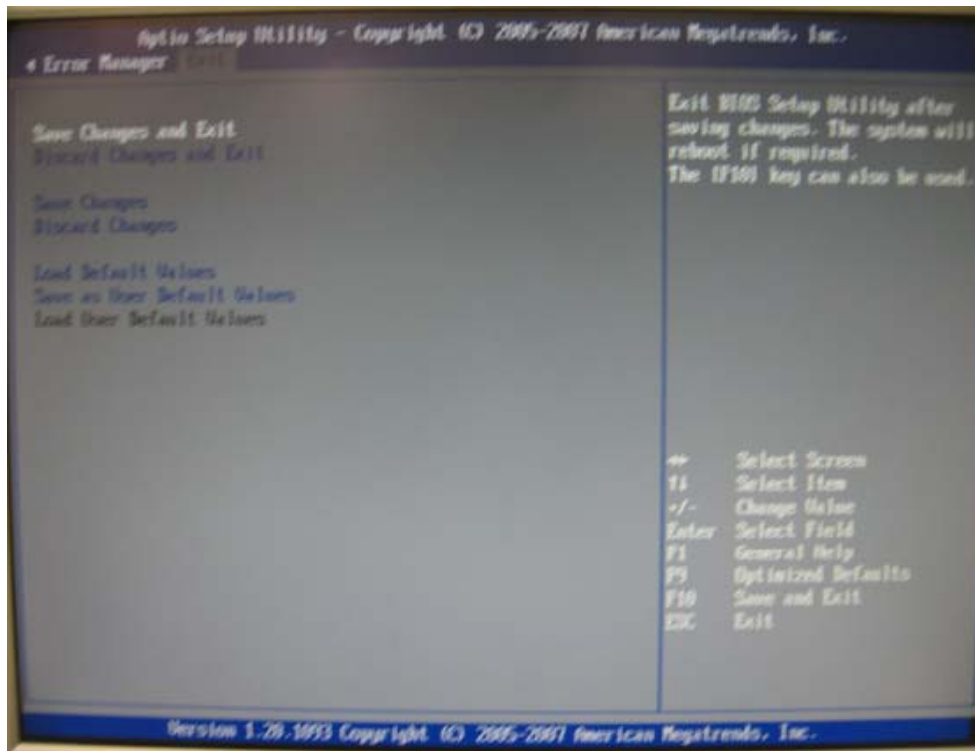

Figure 5-49 Save Changes

5.4 Upgrading Memory and Replacing Hot-Swap and LRU Components

5.4.1 Preventing Static Electricity

This section provides procedures for replacing all Hot-Swappable and LRU components, including procedures for replacing or adding system memory.

The components inside your computer are extremely sensitive to static electricity, also known as electrostatic discharge (ESD). ESD can permanently damage electrostatic discharge-sensitive components in your server.

To prevent ESD damage, follow these guidelines before opening the server case:

1. Turn off the **server** and unplug the **power cord** before opening the case.
2. Wear a **grounding wrist strap** and attach it to a **bare metal** part of the server, workbench, or other grounded connection.

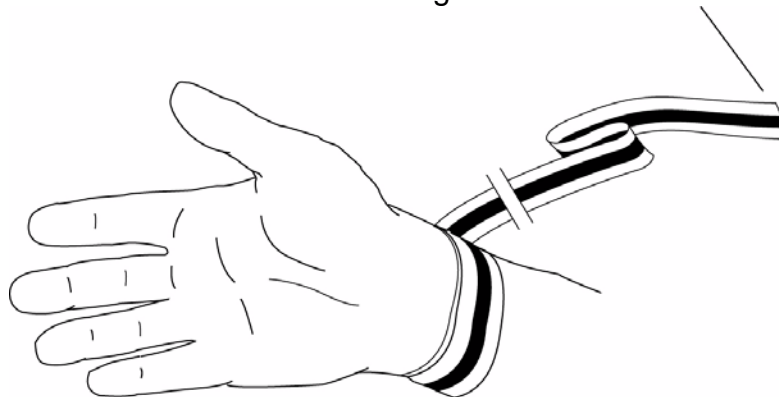

Figure 5-50 Grounding Wrist Strap

3. Do not insert any object into the vent holes on the case or the power supply. Touch a bare metal surface on the back of the computer, a bare metal surface on your workbench, or other grounded object before handling DIMMs or other components.

Before working with computer components, follow these guidelines:

- Avoid static-causing surfaces such as carpeted floors, plastic, and packing foam.
- Remove components from their antistatic bags only when you are ready to use them. Do not lay components on the outside of antistatic bags because only the inside of the bags provide electrostatic protection. Always hold memory modules and components by their edges or their metal mounting brackets.
- Avoid touching the edge connectors and components on the cards. Never slide memory modules or components over any surface.

5.5 Replacing a Hot-Swap Power Supply Module

Your TAG server was designed with the ability to Hot-Swap a power supply module without disconnecting system power. Refer to Figure 4-12 and the steps that follow to Hot-Swap a power supply module.

NOTE: *If you need to remove both modules, you must shutdown the system, unplug the power source from the unit and drain the systems onboard battery by pressing the on/off switch and holding it in place for approximately 10 seconds to drain any charge that might be retained by the systems motherboard.*

1. Obtain certified replacement module from TAG. For more information on contact information see document back page.
2. Depending on the series of your server, either a retention bracket or filtering cover that is secured with thumb screws will need to be removed first.

NOTE: *In some cases a screw driver (Phillips head) might be required to remove a retention bar that is screwed into the power supply.*

3. Loosen the **thumb screws** on the desired module to be replaced.
4. Depress the **module safety latch** and gently pull the handle as shown in Figure 4-12.

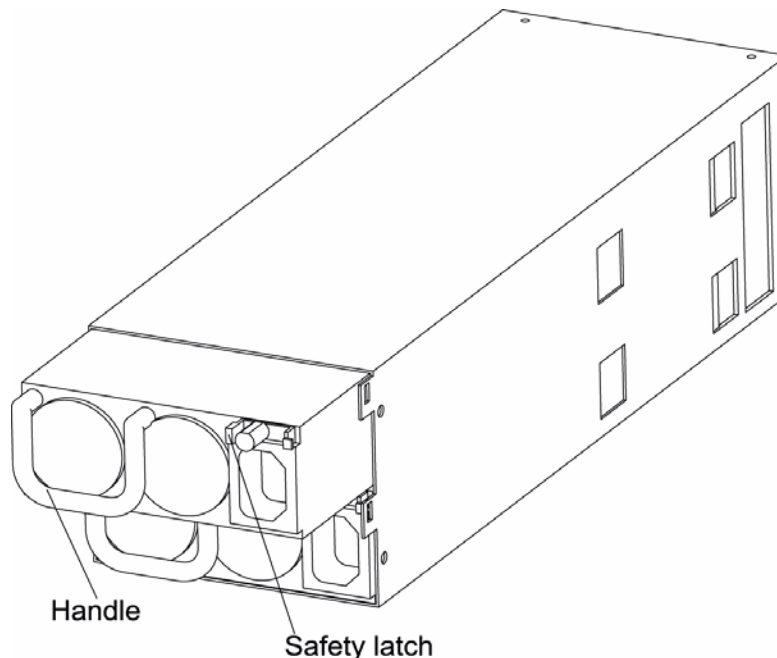

Figure 5-51 Hot-Swap of 2U Server Power Supply Module

5. Slide the replacement module into the **power supply**.
6. Press firmly and evenly on the power module until you feel the module seat in the back of the power supply.

5.6 Replacing a Hot-Swap Hard Drive

The system's hard drive Hot-Swap feature enables you to remove a hard drive without shutting down the operating system or turning off the system power. The way in which you remove a hard drive depends on the application you are using and whether you are replacing a drive, adding a new one, or removing a drive permanently.

When you remove a drive using the Hot-Swap operation, you need to stop the hard drive and take it offline to remove the logical software links to the hard drive, and to reconfigure the file system so that it will now ignore the removed drive. You might also have to reconfigure your application software to operate without the removed drive. Therefore it is strongly recommended that you contact TAG Technical Support at tech.support@tag.com before attempting to Hot-Swap a hard drive. For more information on contact information see document back page.

5.6.1 147GB SAS Hard Drive

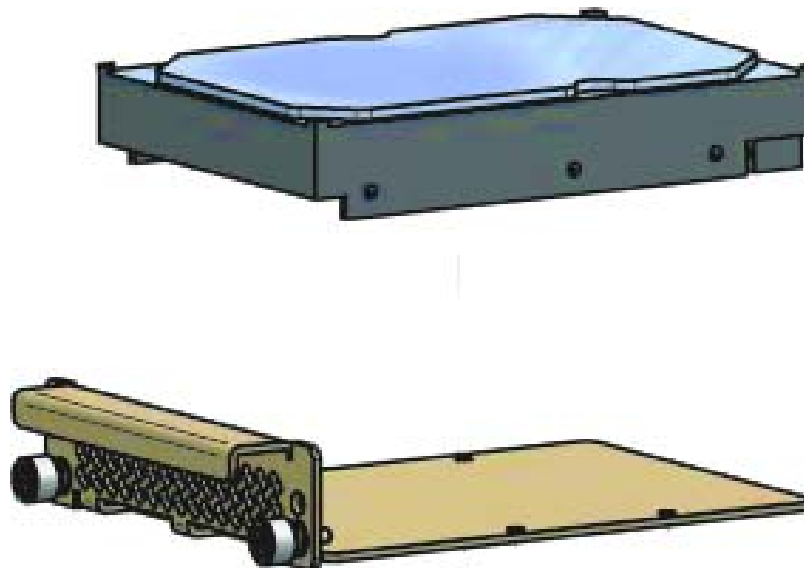

Figure 5-52 147GB SAS HDD (Removed from HD Carrier)

5.7 Removing the Server Cover

The location of the mounting screws securing the server cover varies per server . To remove the cover, use a Phillips screwdriver to remove all screws from the sides and top of the cover.

NOTE: *It is important to make note of the location from which screws are removed since different screw lengths may be used to secure the cover.*

**CAUTION**

It is not safe to operate TAG servers without the cover in place. Failure to take this precaution may result in personal injury and system damage.

5.8 Adding or Replacing System Memory

This section lists the procedures for adding or replacing system memory.

**WARNING**

Ensure that the system is powered-down and all power sources have been disconnected from the server prior to removing or replacing system memory. Failure to do so could result in serious injury from electrical shock.

**CAUTION**

Printed circuit boards and hard drives contain electronic components that are extremely sensitive to static electricity. Ordinary amounts of static from your clothes or the work environment can destroy components. Do not touch the components or any metal parts without taking proper antistatic precautions.

AG's rugged servers combine Intel® SV-2003-X2® technology with state-of-the-art mechanical, thermal and electrical engineering to create customized systems that perform above and beyond end user or program specifications. Our rugged servers are

designed to meet and exceed many MIL-STD requirements to ensure survivability in the field.

5.8.1 Install system memory.

Unlatch both DIMM socket levers, as shown in Figure 4-14.

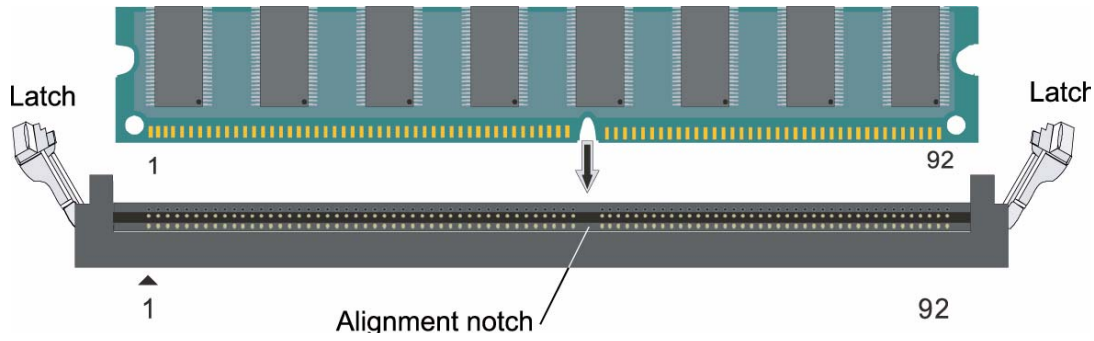

Figure 5-53 DIMM Module Bank

1. Note the location of the alignment notch.
2. Align the notches on the new module with the notches on the memory and press it firmly into the bank.

NOTE: *The tabs on the sides of the memory module should secure the DIMM automatically. When the DIMM locks into place, you will hear a click.*

Chapter 4

RAID.

Electronically distributed. Subject to user discretion when printed.

6 RAID

RAID is an acronym for Redundant Array of Inexpensive (or Independent) Disks. This section provides a high-level overview that defines RAID, the advantages and disadvantages of various RAID levels, and guidelines to observe when implementing RAID.

6.1 RAID Defined

RAID is a way of storing data on two or more physical disks for the purpose of redundancy, improved performance, or both. The combined physical disks make up what is called an array. This array appears on the host system as one disk. For example, if you have physical disk 1 and physical disk 2, those two disks appear to the host system as one disk.

RAID consists of different levels, which determine how the data is placed in the array. Each RAID level has specific data protection and system performance characteristics. The following are commonly used SCSI RAID levels:

1. **RAID Level 0:** Striping, good performance, no redundancy
2. **RAID Level 1:** Mirroring, one-to-one redundancy
3. **RAID Level 5:** Striping with parity striped across all drives; offers performance and redundancy
4. **RAID Level 10:** Mirroring and striping; best redundancy and best performance
5. **RAID Level 50:** Parity striped across all drives in a mirrored set; redundancy and performance

You can manage RAID arrays with a RAID controller (hardware RAID) or with software alone (software RAID).

6.1.1 Reasons for RAID

Depending on how you implement RAID (which RAID level you use), the benefits include one or both of the following:

- **Faster performance:** In RAID 0, 10, or 50 arrays, the host system can access multiple disks simultaneously. This improves performance because each disk in an array has to handle only part of the request. For example, in a two-disk array, each disk needs to provide only its part of the requested data.
- **Data protection:** In RAID 1, 10, 5, and 50 arrays, the data is backed up either on an identical disk (mirror) or on multiple disks (parity disks). RAID 10 and 50 also allow the host to access disks simultaneously.

6.1.2 RAID Level 0

RAID Level 0 is not redundant, hence does not truly fit the "RAID" acronym. In Level 0, data is split across drives, resulting in higher data throughput. Since no redundant information is stored, performance is very good, but the failure of any disk in the array results in all data loss. This level is commonly referred to as striping.

6.1.3 RAID Level 1

See Figure 6-1 RAID Level 1 is commonly referred to as mirroring with 2 hard drives. It provides redundancy by duplicating all data from one drive on another drive. The performance of a Level 1 array is slightly better than a single drive, but if either drive fails, no data is lost. This is a good entry-level redundant system, since only two drives are required. However, since one drive is used to store a duplicate of the data, the cost per megabyte is high.

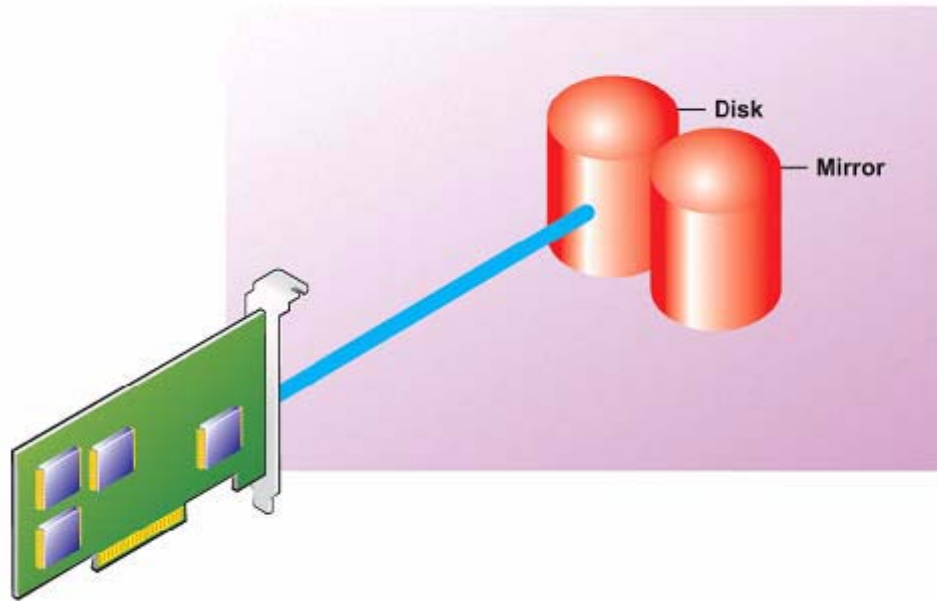

Figure 6-1 RAID Level 1 (Mirroring)

6.2 Configuring RAID 1 ON ADAPTEC 3805

1. When prompted, press Ctrl A to enter the RAID menu. (Figure 6.2)

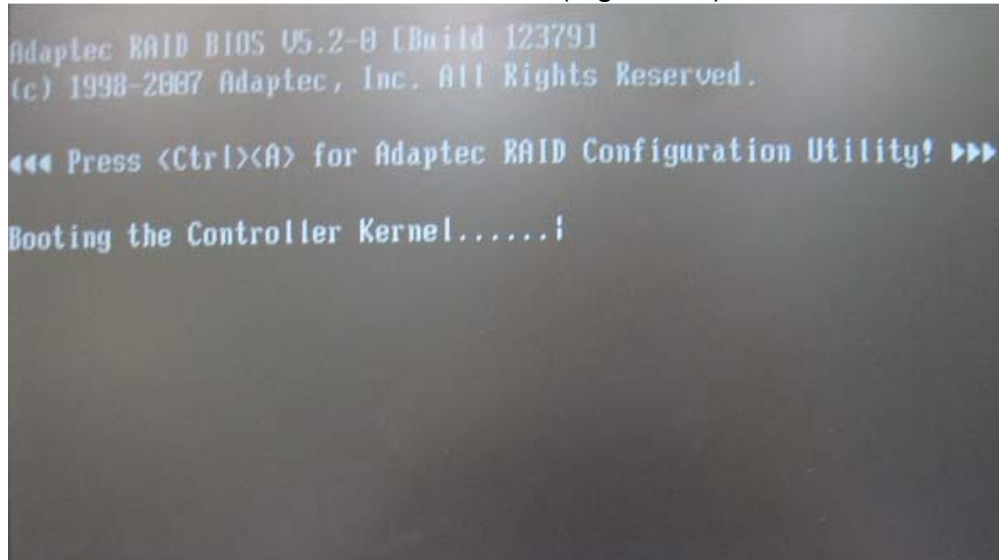

Figure 6-2 Raid Setup Utility

1. Select Array Configuration Utility from the menu then press “Enter” (Figure 6.3).



Figure 6-3 Array Configuration Utility

3. Select Create Array from the menu and press Enter. (Figure 6-4)

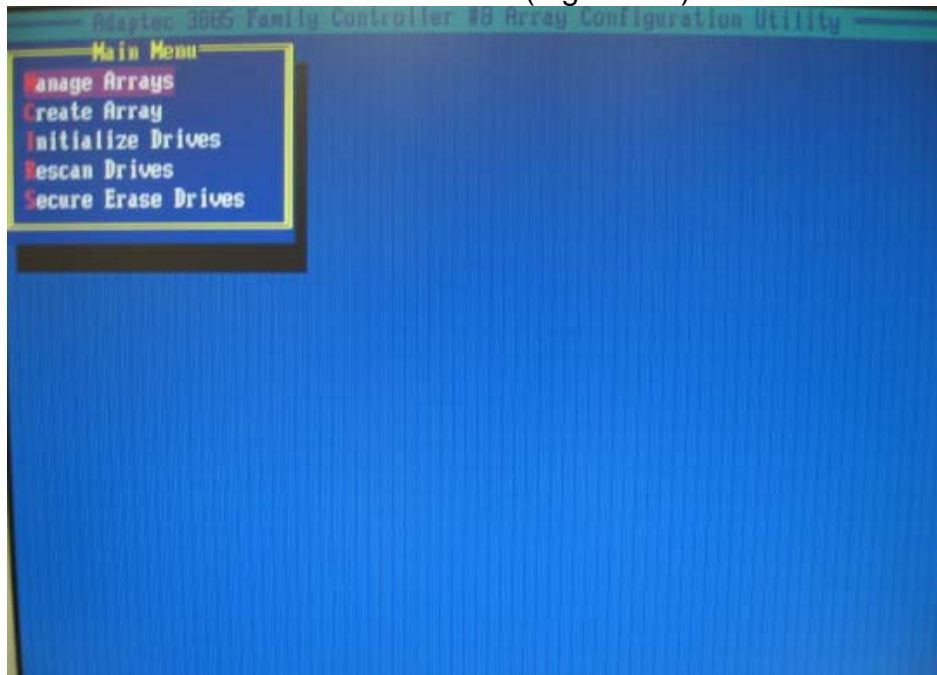

Figure 6-4 Create Array

2. Press the **Space bar twice** to select both drives. Then press **Enter** to continue. (Figure 6.5).

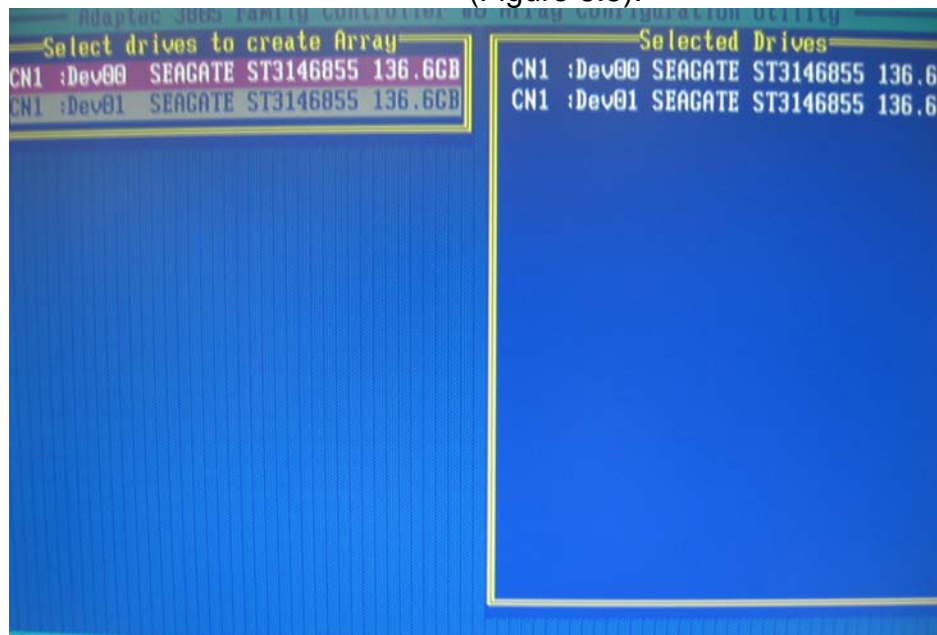

Figure 6-5 Select Both Drives

3. Highlight **RAID 1(Mirror)** press **Enter**.
(Figure 6-6)

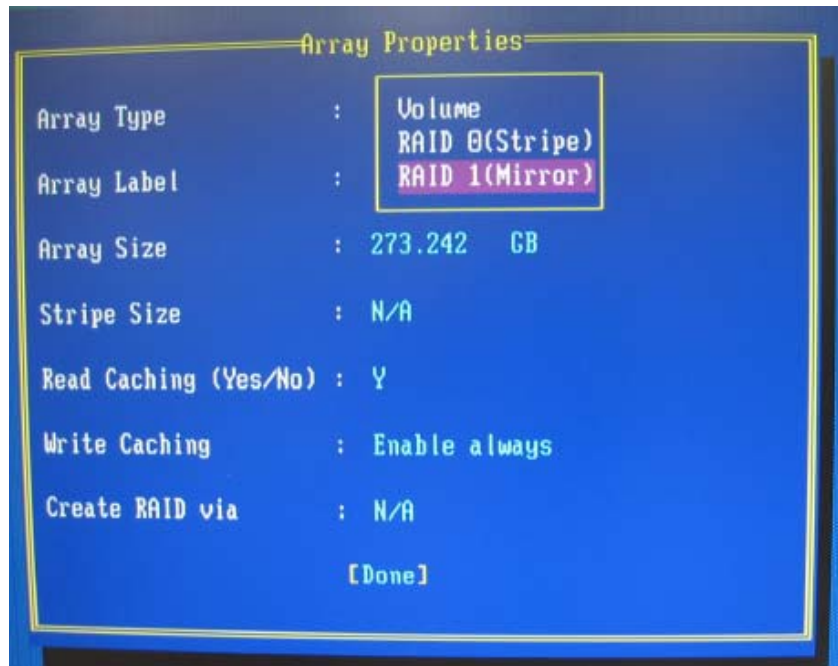

Figure 6-6 Highlight RAID

4. Press **Enter** to continue. (Figure 6.7)

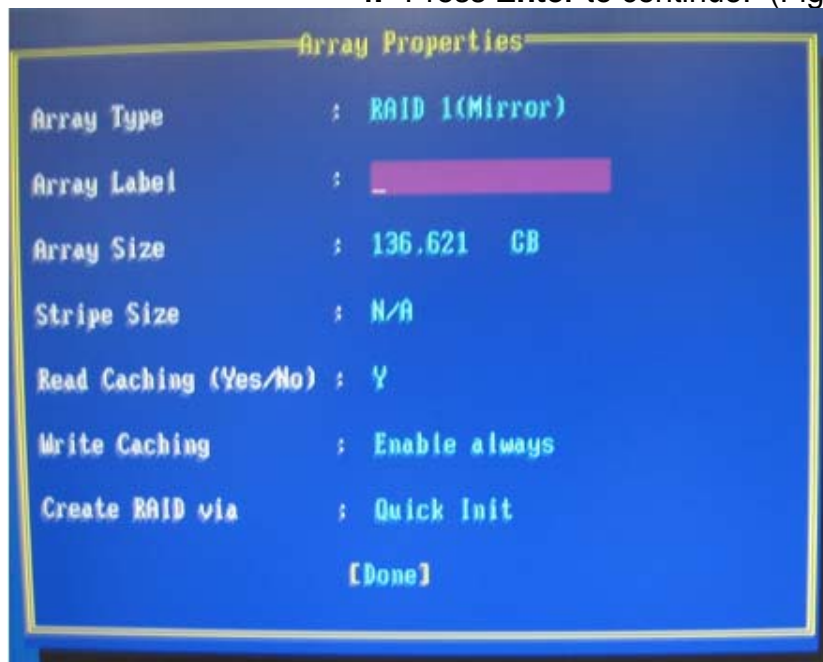

Figure 6-7 Array Properties

5. Select **Disable** for Write Caching and press **Enter**. Then select **Quick Init** and press **Enter twice** to continue. (Figure 6-8)



Figure 6-8 Array Properties

6. A warning will appear, press **Enter** to create the RAID.

CONTACT



Technology Advancement Group®, Inc.

22355 TAG Way

Dulles, VA 20166

Tel: 1-800-824-8693

www.tag.com

Technical Support

USA 1-800-TAG-TECH

Outside USA

While every precaution has been taken to ensure the accuracy and completeness of this literature. TAG assumes no responsibility and disclaims and liability for damage resulting from use of this information or for any errors or omissions.

Free Manuals Download Website

<http://myh66.com>

<http://usermanuals.us>

<http://www.somanuals.com>

<http://www.4manuals.cc>

<http://www.manual-lib.com>

<http://www.404manual.com>

<http://www.luxmanual.com>

<http://aubethermostatmanual.com>

Golf course search by state

<http://golfingnear.com>

Email search by domain

<http://emailbydomain.com>

Auto manuals search

<http://auto.somanuals.com>

TV manuals search

<http://tv.somanuals.com>