

SHARP®

LC-37HV4U

LIQUID CRYSTAL TELEVISION
TÉLÉVISEUR ACL
TELEVISOR CON PANTALLA DE
CRISTAL LIQUIDO
TELEVISOR DE CRISTAL LÍQUIDO

OPERATION MANUAL
MODE D'EMPLOI
MANUAL DE OPERACIÓN
MANUAL DE OPERAÇÃO

AQUOS



ENGLISH

FRANÇAIS

ESPAÑOL

PORTUGUÊS

LC-37HV4U

LIQUID CRYSTAL TELEVISION

ENGLISH

OPERATION MANUAL

IMPORTANT:





To aid reporting in case of loss or theft, please record the TV's model and serial numbers in the space provided. The numbers are located at the rear of the TV.

Model No.:

Serial No.:

IMPORTANT INFORMATION

WARNING: TO REDUCE THE RISK OF FIRE OR ELECTRIC SHOCK, DO NOT EXPOSE THIS PRODUCT TO RAIN OR MOISTURE.

 <div data-bbox="359 1585 662 1697" style="border: 1px solid black; padding: 5px; text-align: center;"> <p>CAUTION RISK OF ELECTRIC SHOCK DO NOT OPEN</p> </div> 	 <p>The lightning flash with arrow-head symbol, within an equilateral triangle, is intended to alert the user to the presence of uninsulated "dangerous voltage" within the product's enclosure that may be of sufficient magnitude to constitute a risk of electric shock to persons.</p>
<p>CAUTION: TO REDUCE THE RISK OF ELECTRIC SHOCK, DO NOT REMOVE COVER (OR BACK). NO USER-SERVICEABLE PARTS INSIDE. REFER SERVICING TO QUALIFIED SERVICE PERSONNEL.</p>	 <p>The exclamation point within a triangle is intended to alert the user to the presence of important operating and maintenance (servicing) instructions in the literature accompanying the product.</p>

CAUTION:

This product satisfies FCC regulations when shielded cables and connectors are used to connect the unit to other equipment. To prevent electromagnetic interference with electric appliances such as radios and televisions, use shielded cables and connectors for connections.

IMPORTANT INFORMATION

CAUTION: TO PREVENT ELECTRIC SHOCK, MATCH WIDE BLADE OF PLUG TO WIDE SLOT, FULLY INSERT.

CAUTION:

DO NOT PLACE THIS PRODUCT ON AN UNSTABLE CART, STAND, TRIPOD, BRACKET, OR TABLE. THE PRODUCT MAY FALL CAUSING SERIOUS PERSONAL INJURY AND SERIOUS DAMAGE TO THE PRODUCT. USE ONLY WITH A CART, STAND, TRIPOD, BRACKET, OR TABLE RECOMMENDED BY THE MANUFACTURER OR SOLD WITH THE PRODUCT. FOLLOW THE MANUFACTURER'S INSTRUCTIONS WHEN INSTALLING THE PRODUCT AND USE MOUNTING ACCESSORIES RECOMMENDED BY THE MANUFACTURER. A PRODUCT AND CART COMBINATION SHOULD BE MOVED WITH CARE. QUICK STOPS, EXCESSIVE FORCE, AND UNEVEN SURFACES MAY CAUSE THE PRODUCT AND CART COMBINATION TO OVERTURN.



WARNING: FCC Regulations state that any unauthorized changes or modifications to this equipment not expressly approved by the manufacturer could void the user's authority to operate this equipment.

DECLARATION OF CONFORMITY

SHARP LIQUID CRYSTAL TELEVISION, MODEL LC-37HV4U.

This device complies with Part 15 of the FCC Rules. Operation is subject to the following two conditions: (1) This device may not cause harmful interference, and (2) this device must accept any interference received, including interference that may cause undesired operation.

RESPONSIBLE PARTY:

SHARP ELECTRONICS CORPORATION
Sharp Plaza, Mahwah, New Jersey 07430-2135
TEL: 1-800-BE-SHARP

For Business Customers: URL <http://www.sharppusa.com>

INFORMATION:

This equipment has been tested and found to comply with the limits for a Class B digital device, pursuant to Part 15 of the FCC Rules. These limits are designed to provide reasonable protection against harmful interference in a residential installation. This equipment generates, uses and can radiate radio frequency energy and, if not installed and used in accordance with the instructions, may cause harmful interference to radio communications. However, there is no guarantee that interference will not occur in a particular installation. If this equipment does cause harmful interference to radio or television reception, which can be determined by turning the equipment off and on, the user is encouraged to try to correct the interference by one or more of the following measures:

- Reorient or relocate the receiving antenna.
- Increase the separation between the equipment and receiver.
- Connect the equipment into an outlet on a circuit different from that to which the receiver is connected.
- Consult the dealer or an experienced radio/TV technician for help.

"Note to CATV system installer: This reminder is provided to call the CATV system installer's attention to Article 820-40 of the National Electrical Code that provides guidelines for proper grounding and, in particular, specifies that the cable ground shall be connected to the grounding system of the building, as close to the point of cable entry as practical."

This product utilizes tin-lead solder, and fluorescent lamp containing a small amount of mercury. Disposal of these materials may be regulated due to environmental considerations. For disposal or recycling information, please contact your local authorities or the Electronic Industries Alliance: www.eia.org

DEAR SHARP CUSTOMER

Thank you for your purchase of the Sharp Liquid Crystal Television. To ensure safety and many years of trouble-free operation of your product, please read the Important Safety Precautions carefully before using this product.

IMPORTANT SAFETY PRECAUTIONS

Electricity is used to perform many useful functions, but it can also cause personal injuries and property damage if improperly handled. This product has been engineered and manufactured with the highest priority on safety. However, improper use can result in electric shock and/or fire. In order to prevent potential danger, please observe the following instructions when installing, operating and cleaning the product. To ensure your safety and prolong the service life of your Liquid Crystal Television, please read the following precautions carefully before using the product.

- Read Instructions — All the safety and operating instructions should be read before the product is operated.
- Retain Instructions — The safety and operating instructions should be retained for future reference.
- Heed Warnings — All warnings on the product and in the operating instructions should be adhered to.
- Follow Instructions — All operating and use instructions should be followed.
- Attachments — Do not use attachments not recommended by the product manufacturer as they may cause hazards.
- Power Sources — This product should be operated only from the type of power source indicated on the marking label. If you are not sure of the type of power supply to your home, consult your product dealer or local power company. For products intended to operate from battery power, or other sources, refer to the operating instructions.
- AC Cord Protection — AC cords should be routed so that they are not likely to be walked on or pinched by items placed upon or against them, paying particular attention to cords at plugs, convenience receptacles, and the point where they exit from the product.
- Overloading — Do not overload wall outlets, extension cords, or integral convenience receptacles as this can result in a risk of fire or electric shock.
- Object and Liquid Entry — Never push objects of any kind into this product through openings as they may touch dangerous voltage points or short-out parts that could result in a fire or electric shock. Never spill liquid of any kind on the product.
- Servicing — Do not attempt to service this product yourself as opening or removing covers may expose you to dangerous voltage or other hazards. Refer all servicing to qualified service personnel.
- Damage Requiring Service — Unplug this product from the wall outlet and refer servicing to qualified service personnel under the following conditions:
 - a) When the AC cord or plug is damaged,
 - b) If liquid has been spilled, or objects have fallen into the product,
 - c) If the product has been exposed to rain or water,
 - d) If the product does not operate normally by following the operating instructions.
Adjust only those controls that are covered by the operating instructions as an improper adjustment of other controls may result in damage and will often require extensive work by a qualified technician to restore the product to its normal operation,
 - e) If the product has been dropped or damaged in any way, and
 - f) When the product exhibits a distinct change in performance – this indicates a need for service.
- Replacement Parts — When replacement parts are required, be sure the service technician has used replacement parts specified by the manufacturer or have the same characteristics as the original part. Unauthorized substitutions may result in fire, electric shock, or other hazards.
- Safety Check — Upon completion of any service or repairs to this product, ask the service technician to perform safety checks to determine that the product is in proper operating condition.
- Wall or ceiling mounting — When mounting the product on a wall or ceiling, be sure to install the product according to the method recommended by the manufacturer.
- Polarization — The product may be equipped with a polarized alternating current line plug (a plug having one blade wider than the other). This plug will fit into the AC outlet only one way. This is a safety feature. If you are unable to insert the plug fully into the outlet, try reversing the plug. If the plug should still fail to fit, contact your electrician to replace your obsolete outlet. Do not defeat the safety purpose of the polarized plug.
- Unplug the AC cord from the AC outlet before installing the speakers.

IMPORTANT SAFETY PRECAUTIONS

- **Cleaning** — Unplug this product from the wall outlet before cleaning. Do not use liquid cleaners or aerosol cleaners. Use a damp cloth for cleaning.



- **Water and Moisture** — Do not use this product near water – for example, near a bath tub, wash bowl, kitchen sink, or laundry tub; in a wet basement; or near a swimming pool; and the like.



- **Stand** — Do not place the product on an unstable cart, stand, tripod or table. Placing the product on an unstable base can cause the product to fall, resulting in serious personal injuries as well as damage to the product. Use only a cart, stand, tripod, bracket or table recommended by the manufacturer or sold with the product. When mounting the product on a wall, be sure to follow the manufacturer's instructions. Use only the mounting hardware recommended by the manufacturer.



- A product and cart combination should be moved with care. Quick stops, excessive force, and uneven surfaces may cause the product and cart combination to overturn.



- **Ventilation** — The vents and other openings in the cabinet are designed for ventilation. Do not cover or block these vents and openings since insufficient ventilation can cause overheating and/or shorten the life of the product. Do not place the product on a bed, sofa, rug or other similar surface, since they can block ventilation openings. This product is not designed for built-in installation; do not place the product in an enclosed place such as a bookcase or rack, unless proper ventilation is provided or the manufacturer's instructions are followed.

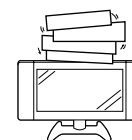

- The Liquid Crystal panel used in this product is made of glass. Therefore, it can break when the product is dropped or applied with impact. Be careful not to be injured by broken glass pieces in case the panel breaks.



- **Heat** — The product should be situated away from heat sources such as radiators, heat registers, stoves, or other products (including amplifiers) that produce heat.

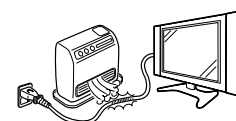

- The Liquid Crystal panel is a very high technology product with 3,147,264 thin film transistors, giving you fine picture details. Occasionally, a few non-active pixels may appear on the screen as a fixed point of blue, green or red. Please note that this does not affect the performance of your product.

Precautions when transporting the display

When transporting the display, never carry it by holding onto the speakers. Be sure to always carry the display by two people holding it with two hands-one hand on each side of the display.

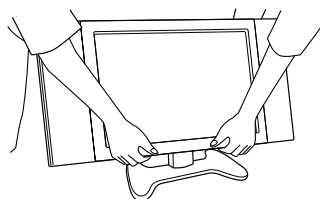

IMPORTANT SAFETY PRECAUTIONS

- **Outdoor Antenna Grounding** — If an outside antenna is connected to the television equipment, be sure the antenna system is grounded so as to provide some protection against voltage surges and built-up static charges. Article 810 of the National Electrical Code, ANSI/NFPA 70, provides information with regard to proper grounding of the mast and supporting structure, grounding of the lead-in wire to an antenna discharge unit, size of grounding conductors, location of antenna-discharge unit, connection to grounding electrodes, and requirements for the grounding electrode.

EXAMPLE OF ANTENNA GROUNDING AS PER NATIONAL ELECTRICAL CODE, ANSI/NFPA 70

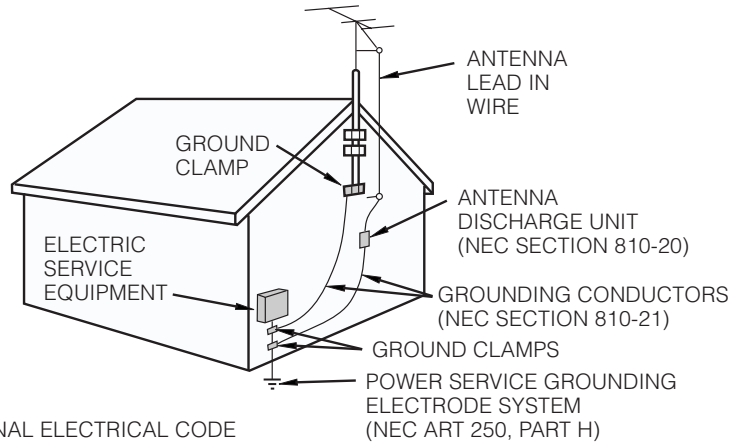

- **Lighting** — For added protection for this television equipment during a lightning storm, or when it is left unattended and unused for long periods of time, unplug it from the wall outlet and disconnect the antenna. This will prevent damage to the equipment due to lightning and power-line surges.

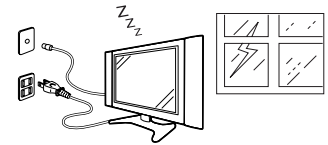

- **Power Lines** — An outside antenna system should not be located in the vicinity of overhead power lines or other electric light or power circuits, or where it can fall into such power lines or circuits. When installing an outside antenna system, extreme care should be taken to keep from touching such power lines or circuits as contact with them might be fatal.

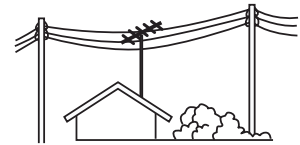





Contents

IMPORTANT INFORMATION	1	Using external equipment	41
DEAR SHARP CUSTOMER	3	Watching a DVD image	42
IMPORTANT SAFETY PRECAUTIONS	3	Connecting a DVD player	42
Contents	6	Displaying a DVD image	42
Supplied accessories	7	Watching a VCR image	43
Preparation	8	Connecting a VCR	43
Attaching the speakers	8	Displaying a VCR image	43
Where to place the System	9	Watching broadcasts via a Digital TV tuner ...	44
Setting the System	10	Connecting a Digital TV tuner	44
Setting the Display on the wall	12	Displaying broadcasts	
Setting the AVC System with the stand	12	via a Digital TV tuner	44
Inserting the batteries	13	Enjoying a game console	
Using the remote control unit	13	or viewing camcorder images	45
Cautions regarding remote control unit ...	13	Connecting a game console	
Part names	14	or camcorder	45
Display	14	Displaying an image of the game	
AVC System	15	console or camcorder	45
Remote control unit	16	Viewing an image from a PC	46
Watching TV	17	Connecting a PC	46
Antennas	17	Displaying an image from a PC	46
Cable converter/VCR connection	17	Useful adjustment settings	47
Outdoor antenna connection	19	Image position (AV input mode only)	47
Connecting the AC cord	20	Moving the picture on the screen	48
Turning on the power	21	Auto Sync. adjustment (PC input mode only) ...	49
Turning off the power	21	Fine Sync. adjustment (PC input mode only) ...	49
Initial setup	22	Input signal source	50
Simple button operations		Picture flip	51
for changing channels	23	AV MODE	52
Simple button operations		View modes for 4:3 Programs	52
for changing volume/sound	24	View mode (for PC input mode)	53
Using FRONT SURROUND		Input signal (for PC input mode)	54
on the remote control unit	25	Noise clean	54
Setting MTS/SAP stereo mode	25	Sleep timer	55
Basic adjustment settings	26	Audio out	55
AV input mode menu items	26	Connecting external speakers	56
PC input mode menu items	26	Selecting speakers	57
EZ setup	27	Cool climate	58
Channel setup	28	Closed caption	59
Language setting	31	Secret number setting for parental control	
Picture adjustments	32	(AV input mode only)	60
C.M.S. (Color Management System)	33	Parental control (setting V-CHIP level)	62
Color temperature	34	How to temporarily release	
Black	34	the V-CHIP BLOCK	66
3D-Y/C	35	Reactivating the temporarily released	
Monochrome	35	V-CHIP BLOCK	66
Film mode (3:2 pull-down)	36	Other viewing options	67
I/P Setting	36	Twin picture functions	67
Sound adjustment	37	Learning remote control function	68
Power control	38	Using the TV remote control unit	
Power control for AV source	38	to control other devices	70
Power control for PC source	40	Appendix	76
		Troubleshooting	76
		PC compatibility chart	77
		RS-232C port specifications	78
		Specifications	80
		Optional accessories	80
		Dimensional drawings	81

Supplied accessories

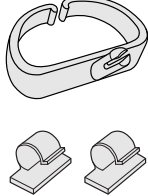
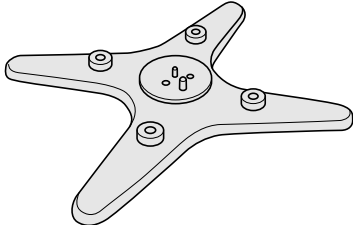
Make sure the following accessories are provided with the product.

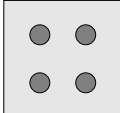
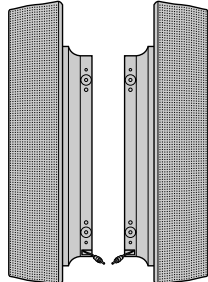
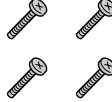
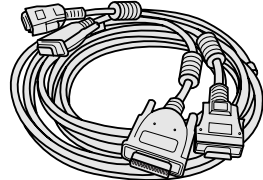
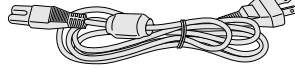
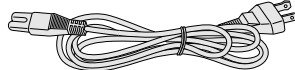
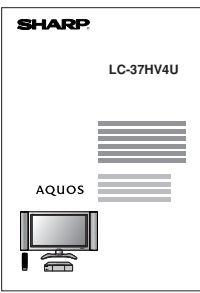
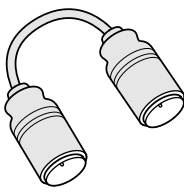
<p>Remote control unit (× 1)</p>	<p>“AA” size Alkaline battery (× 2)</p>	<p>Cable clamp (Large × 1, Small × 2)</p>
 <p>RRMCGA037WJSA Page 13</p>	 <p>UBATA0018CEZZ Page 13</p>	 <p>LHLDW0110CEZZ (Large) LHLDZ0139CEZZ (Small) Page 11</p>
<p>Stand unit (for AVC System) (× 1)</p>	<p>Speaker unit (× 1)</p>	<p>System cable (× 1)</p>
 <p>GDAI-A059WJSA PSPAHA101WJZZ</p>  <p>GLEGA013WJZZ</p>  <p>XBPSN40P14JS0</p> <p>Stand (× 1) Stand cushion (× 4) Stand spacer (× 4) Stand screw (× 2) Page 12</p>	 <p>RSP-ZA027WJN1 (Left) RSP-ZA027WJN2 (Right)</p> <hr/>  <p>XBBSF40P25000</p> <p>Speaker (L × 1, R × 1) Speaker screw (× 4) Page 8</p>	 <p>QCNW-6117CEZZ Page 10</p> <p>AC cord (× 2)</p>  <p>(for Display) QACCCA019WJPZ</p>  <p>(for AVC System) QACCD3097CEPZ Page 10</p>
<p>Operation manual (× 1)</p>	<p>RF cable (× 1)</p>	<p>NOTE</p> <ul style="list-style-type: none"> Always use the AC cord supplied with the Liquid Crystal Television and the one supplied with the AVC System for each respective unit. AC cords enclosed in this product are for 110-125V. In using it on the 125-240V AC, please consult to the following. <p>SHARP ELECTRONICS CORPORATION 1300 Naperville Drive, Romeoville, Illinois 60446-1091, U.S.A. TEL: 630-226-2400</p>
 <p>TINS-A529WJZZ</p>	 <p>QCNW-A342WJZZ Pages 18 and 19</p>	

Preparation

Attaching the speakers

The supplied speaker unit can be attached to or detached from the Display. It must be attached unless you use external amplifier/speakers.

Before attaching (or detaching) speakers, unplug the AC cord from the AC outlet.

Be sure to attach or detach the speakers with two or more people.

Example: Attaching right speaker.

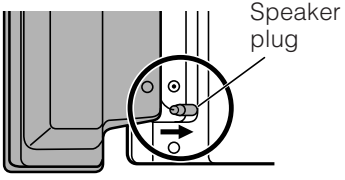
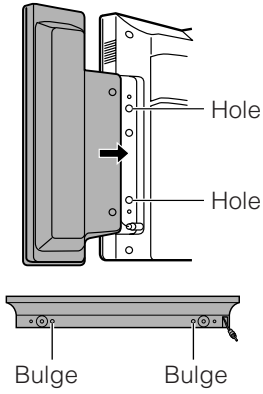
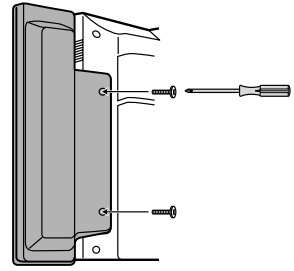
<p>1</p>  <p>Insert the speaker plug into the terminal on the Display.</p> <ul style="list-style-type: none">• Make sure that the speaker plug is inserted completely.	<p>2</p>  <p>Take hold of the speaker and slowly slide it to the Display.</p> <ul style="list-style-type: none">• Make sure that the two bulges of the speaker align with the holes on the Display.	<p>3</p>  <p>Fasten the screws to secure the speaker in place.</p> <ul style="list-style-type: none">• Use a screwdriver.• Perform the same steps for attaching left speaker.
--	---	--

CAUTION

- The speaker terminals on the Display are only for the supplied speaker unit. Do not connect any third party plug to the terminal or speaker to the Display.
- Do not handle or move the Display by the speakers.

NOTE

- Perform the same steps for both left and right speakers.
- To detach the speakers, perform the above steps in reverse order.
- You can connect your own amplifier/speakers to the Display. See page 56 for connecting external speakers.

Where to place the System

“System” means the Display and AVC System. First select the location where to place the System.

1 Selecting the location of the System

- Select a place with no direct sunlight and good ventilation.
- The Display and the AVC System are connected by the system cable. (See page 10 for details.)

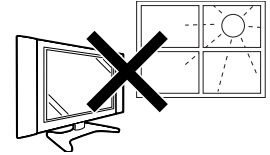

Display

System cable

AVC System

If you want to keep a longer distance between the Display and AVC System, please purchase the optional system cable AN-07SC1 (about 23 feet/7 meters). (See page 80.)

2 Setting the System in place

Handling the Display



- The Display is very heavy. Move it with two or more people.
- Do not remove the stand from the Display unless using an optional bracket to mount it.
- When moving, put your hands on the Display, but never on the Display speakers.
- Keep enough space above and behind the Display.

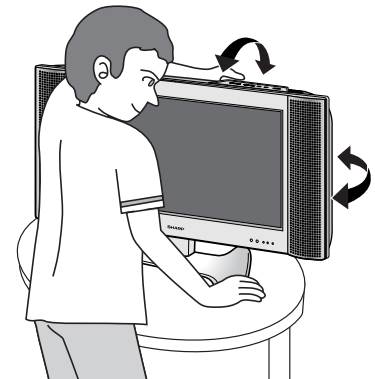

Handling the AVC System



- Do not put a VCR or other device on the AVC System.
- Keep enough space above and on the sides of the AVC System.
- Do not block the ventilation openings on the top and left side, and the exhaust fan on the right side.
- Do not spread a thick cloth beneath the AVC System, or cover it with one, as this can cause overheating and result in malfunction.



Adjust the screen with both hands. Put one hand on the Display and tilt the screen while steadying the stand with your other hand.

You can adjust the screen vertically up to 4 degrees forward or 6 degrees backward, or rotate 10 degrees horizontally.

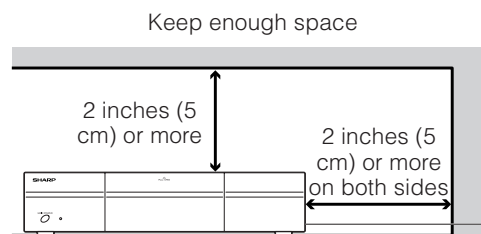
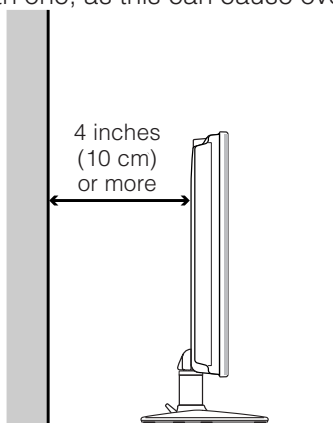

There is an exhaust fan on the right side.

Setting the System

After putting the Display and the AVC System in place, connect the system cables and AC cords. Use the cable clamps for bundling the cables.

1 Removing the terminal cover

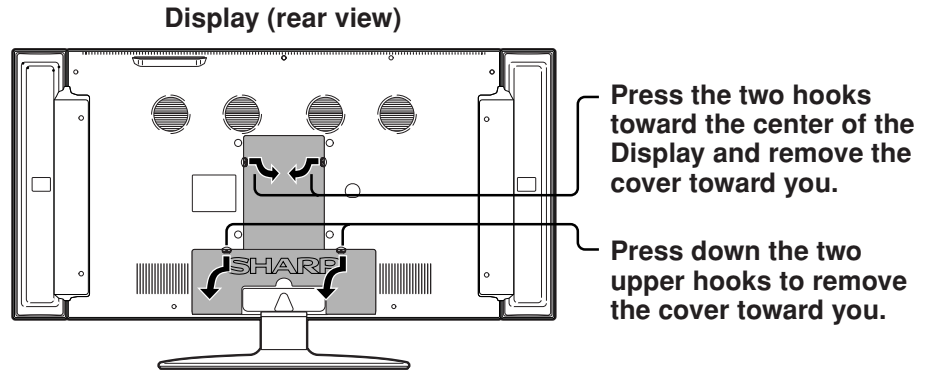

2 Connecting the system cable and the AC cord to the Display

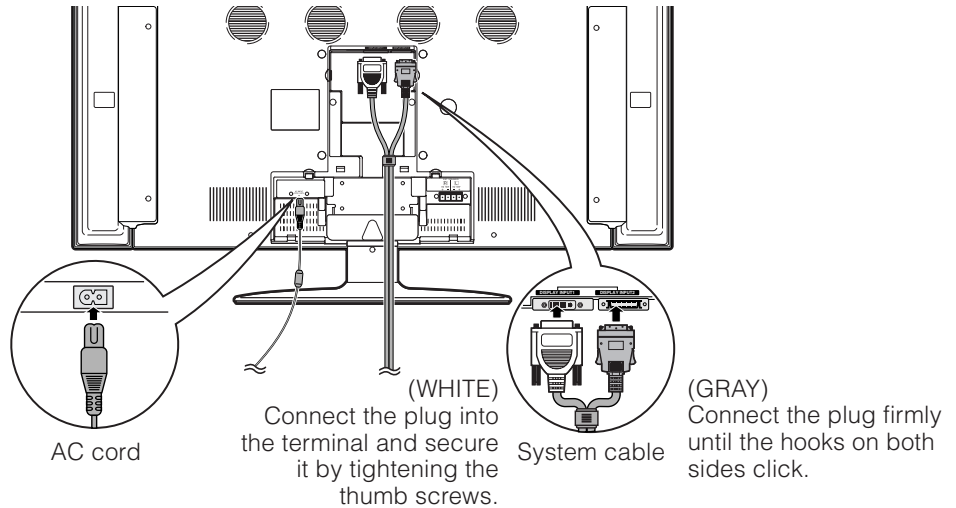

3 Connecting the system cable and the AC cord to the AVC System

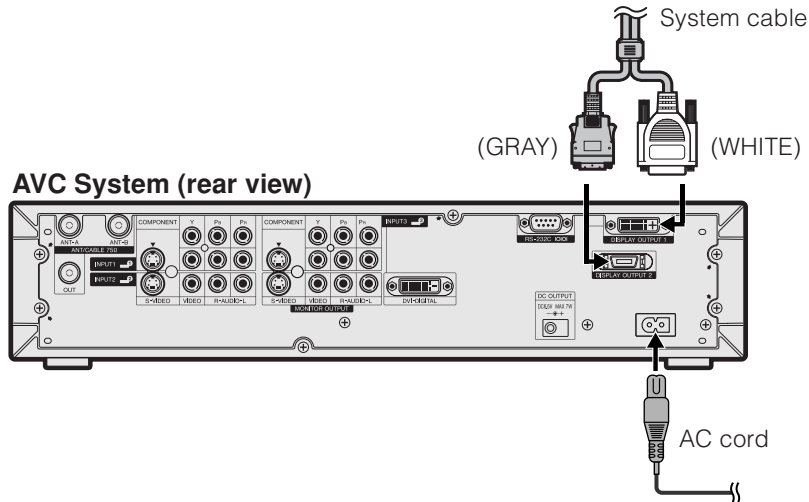

CAUTION

- TO PREVENT RISK OF ELECTRIC SHOCK, DO NOT TOUCH UN-INSULATED PARTS OF ANY CABLES WITH THE AC CORD CONNECTED.

4

Attaching the clamps and bundling the cables with the clamp

Cable clamp (Large)

Insert the cable clamp in the hole on the Display leg as shown.

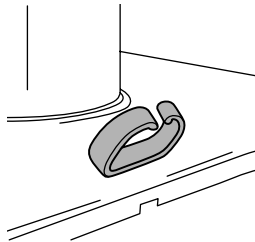

Cable clamp (Small)

Peel off the seal on the back and attach as shown.

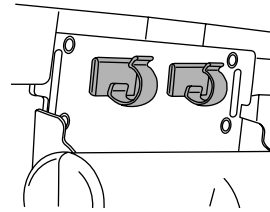

Display (rear view)

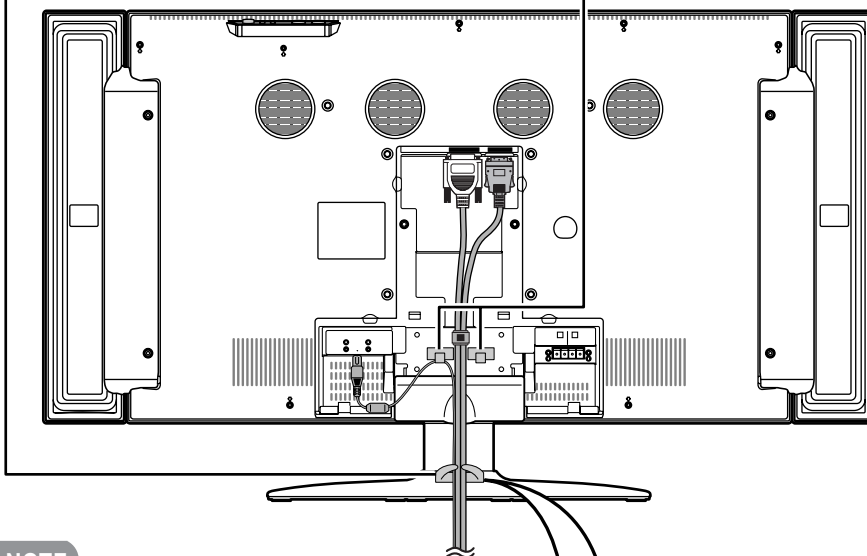

NOTE

- The small clamp on the right is used for bundling external speakers. (See page 56.)

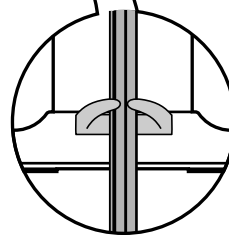

5

Closing the terminal cover

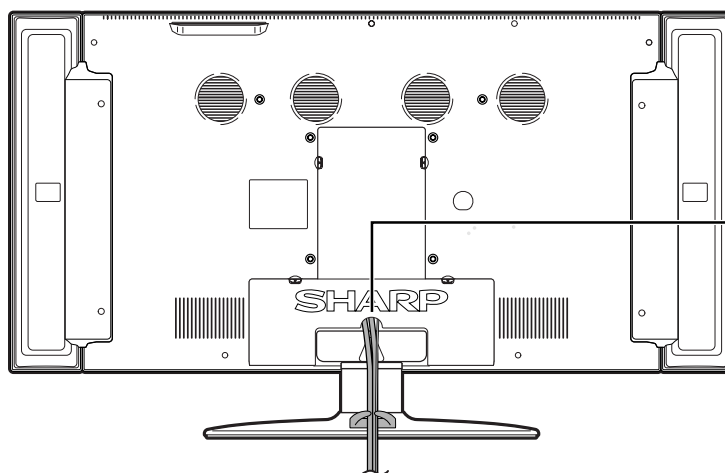

Cables come out from the small opening.

Preparation

Setting the Display on the wall

Using an optional bracket to mount the Display

- You can ask a qualified service personnel about using an optional AN-37AG1 bracket to mount the Display to the wall.
- Carefully read the instructions that come with the bracket before beginning work.

Hanging on the wall

AN-37AG1 wall mount bracket. (See the bracket instructions for details.)

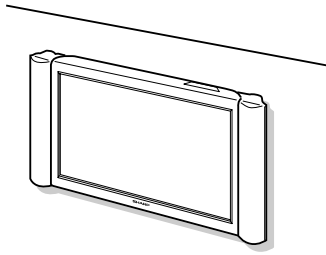

Vertical mounting

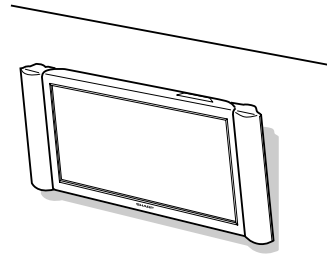

Angular mounting

CAUTION

- Installing the Liquid Crystal Television requires special skill that should only be performed by qualified service personnel. Customers should not attempt to do the work themselves. SHARP bears no responsibility for improper mounting or mounting that results in accident or injury.

Setting the AVC System with the stand

How to install the AVC System vertically using the stand unit.

- Use the supplied stand unit for installing the AVC System vertically in an upright position.

1 Stick each spacer to the stand as shown.

Peel each spacer away from the paper and attach to the four bulging areas on the stand.

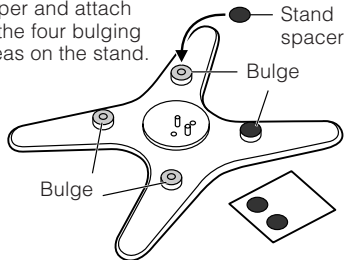

2 Attach each cushion to the stand as shown.

Peel each cushion away from the paper and attach to the four areas at the bottom.

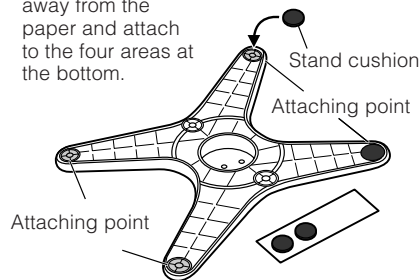

3 Fit the stand to the AVC System.

Insert the stand into the AVC System, making sure that the thick and thin bulges of the stand align with the big and small holes on the AVC System.

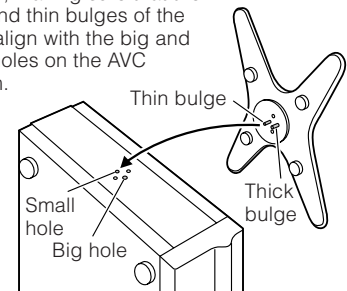

4 Attach the stand using the stand screws as shown.

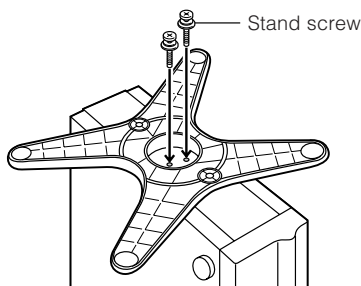

The AVC System installed vertically with the stand.

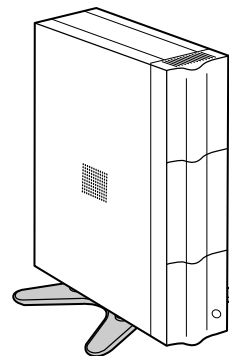

NOTE

- When mounting the AVC System vertically, always use the supplied stand. Be careful not to block vent holes when standing up directly on the floor or a flat surface as this can result in equipment failure.

Preparation

Inserting the batteries

If the remote control fails to operate Liquid Crystal Television functions, replace the batteries in the remote control unit.

1 Open the battery cover.

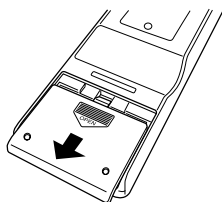

2 Insert two "AA" size Alkaline batteries (supplied with the product).

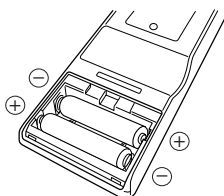

3 Close the battery cover.

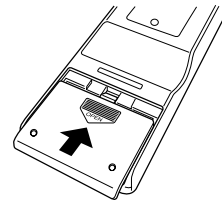

- Place the batteries with their terminals corresponding to the (+) and (-) indications in the battery compartment.

CAUTION

Improper use of batteries can result in chemical leakage or explosion. Be sure to follow the instructions below.

- Do not use manganese batteries. When you replace the batteries, use alkaline ones.
- Place the batteries with their terminals corresponding to the (+) and (-) indications.
- Do not mix batteries of different types. Different types of batteries have different characteristics.
- Do not mix old and new batteries. Mixing old and new batteries can shorten the life of new batteries or cause chemical leakage in old batteries.
- Remove batteries as soon as they are worn out. Chemicals that leak from batteries can cause a rash. If you find any chemical leakage, wipe thoroughly with a cloth.
- The batteries supplied with this product may have a shorter life expectancy due to storage conditions.
- If you will not be using the remote control unit for an extended period of time, remove batteries from it.

Using the remote control unit

Use the remote control unit by pointing it towards the remote control sensor on the Display. Objects between the remote control unit and the remote control sensor may prevent proper operation.

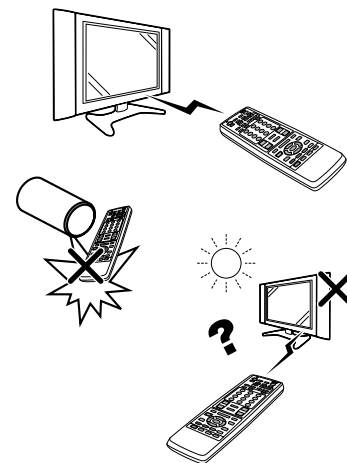

Cautions regarding remote control unit

- Do not expose the remote control unit to shock. In addition, do not expose the remote control unit to liquids, and do not place in an area with high humidity.
- Do not install or place the remote control unit under direct sunlight. The heat may cause deformation of the remote control unit.
- The remote control unit may not work properly if the remote control sensor on the Display is under direct sunlight or strong lighting. In such cases, change the angle of the lighting or the Display, or operate the remote control unit closer to the remote control sensor.

Part names

Display

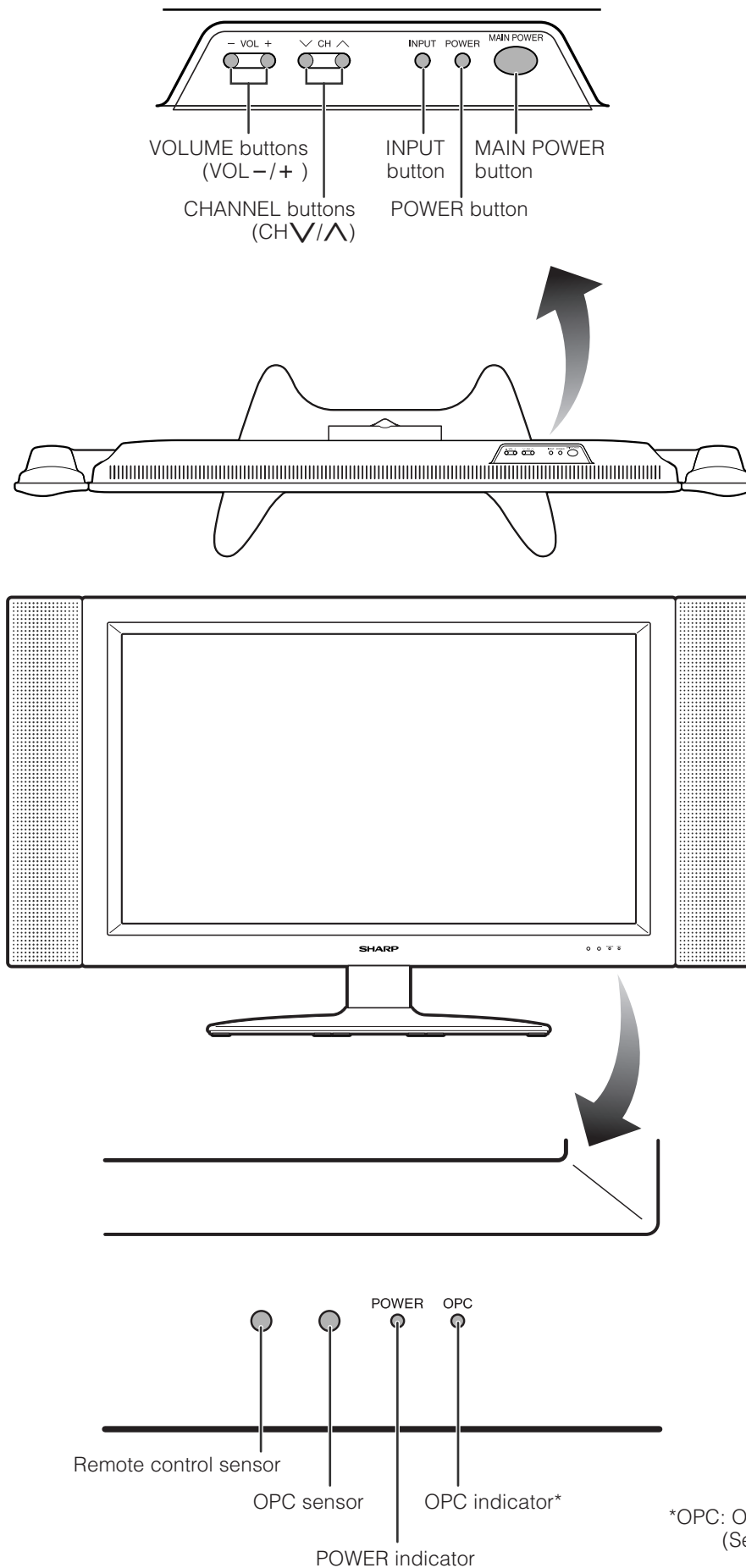

Part names

AVC System

Front view

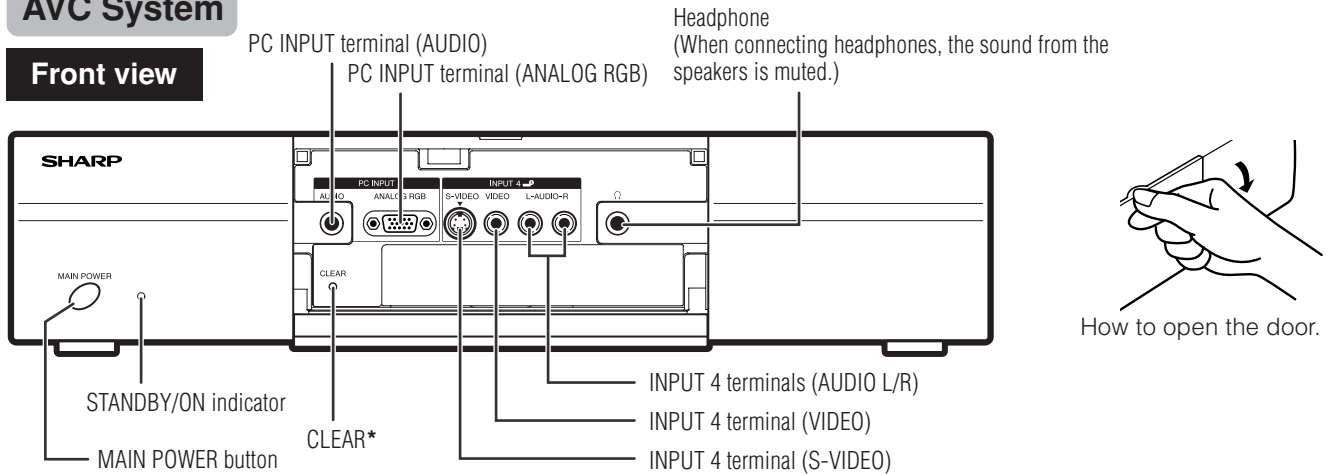

* If the AVC System is switched on but it does not appear to be operating correctly, it may need resetting. In this case, press **CLEAR**, shown in the diagram, lightly with the end of a ballpoint pen or other pointed object. This will reset the System as shown below.

- AV MODE resets to USER
- TV channel returns to initial channel setting (Air:2ch, Cable:1 or 2ch)
- Twin picture resets to normal
- Audio setting initializes
- SRS resets to off
- Image position initializes

NOTE

- Pressing **CLEAR** will not work if the System is in standby mode (indicator lights red).
- Pressing **CLEAR** will not delete channel preset or secret number. See page 61 for clearing the secret number when you know it. See page 83 for initializing to the factory preset values when you forget your secret number.

Rear view

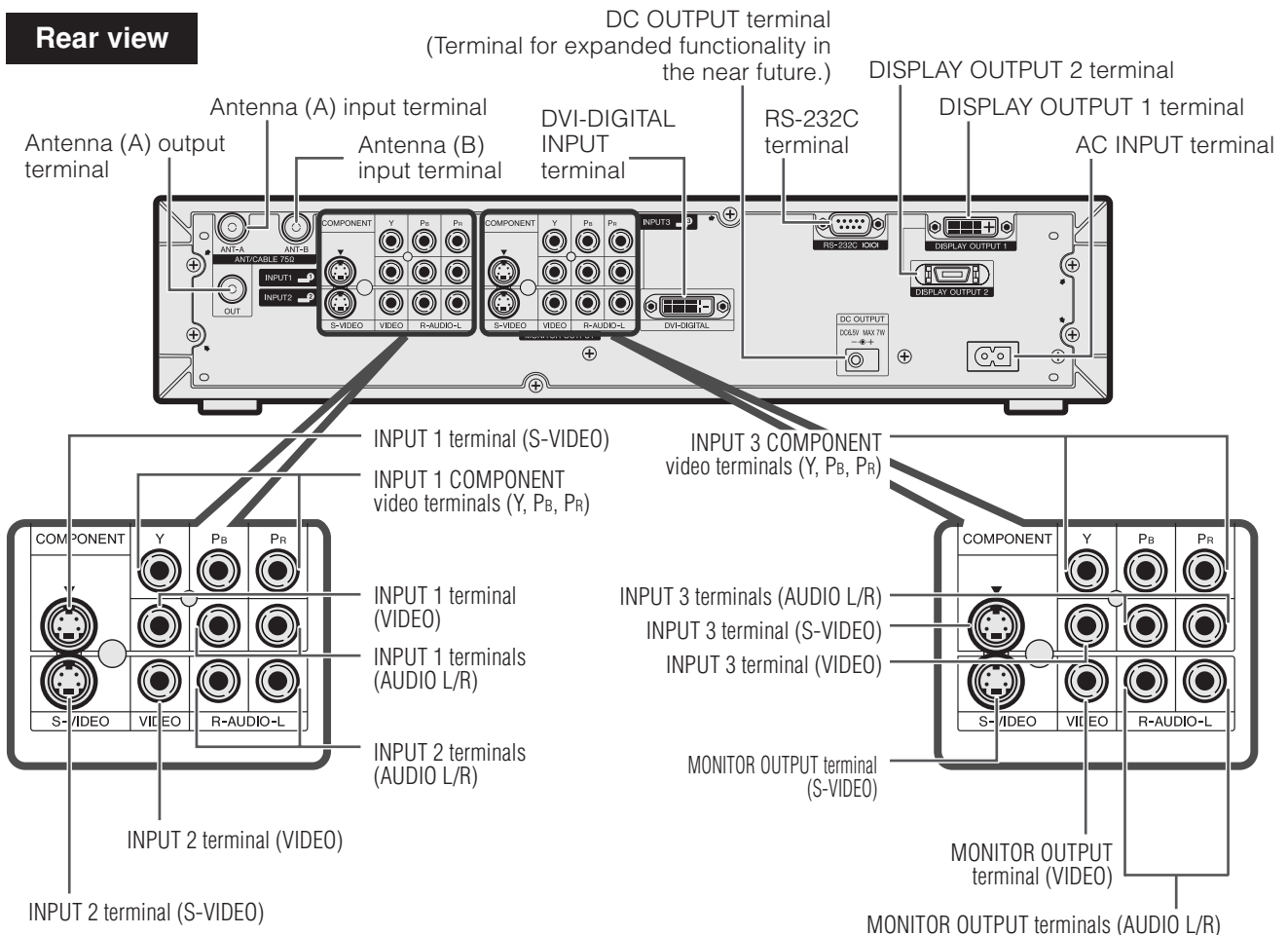

Remote control unit

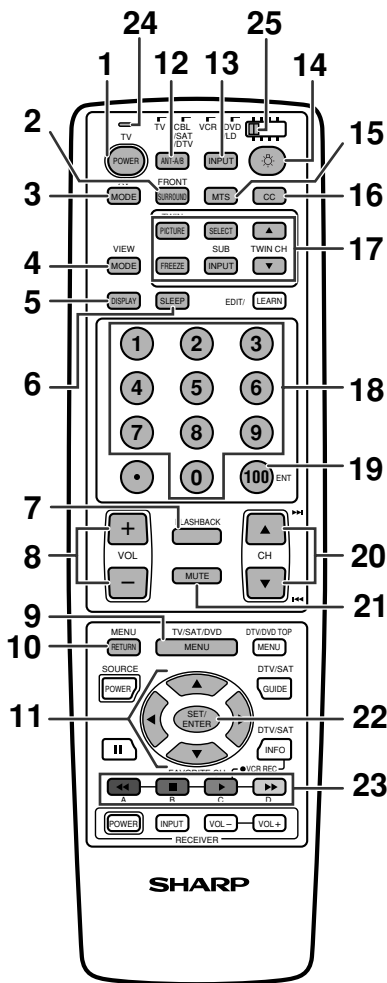

NOTE

- When using the remote control unit, point it at the Liquid Crystal Television.
- See pages 68 to 75 for operating buttons not listed on this page.

* **SRS**  **FOCUS** is a trademark of SRS Labs, Inc. FOCUS technology is incorporated under license from SRS Labs, Inc.

- TV POWER:** Switch the Liquid Crystal Television power on or off. (See page 21.)
- FRONT SURROUND:** Set SRS* and FOCUS* Sound System mode. (See page 25.)
- AV MODE:** Select an audio or video setting. (See page 52.) (AV mode: STANDARD, DYNAMIC, MOVIE, GAME, USER. PC mode: STANDARD, USER.)
- VIEW MODE:** Select the screen size. (See pages 52 and 53.)
- DISPLAY:** Display the channel information.
- SLEEP:** Set the sleep timer. (See page 55.)
- FLASHBACK:** Return to the previous channel or input external mode. (See page 23.)
- VOL +/-:** Set the volume. (See page 24.)
- MENU:** Display the menu screen.
- MENU RETURN:** Return to the previous menu screen.
- ▲/▼/◀▶:** Select a desired item on the screen.
- ANT-A/B:** Select between ANT-A and B to watch broadcasts via the two tuners.
- INPUT:** Select a Liquid Crystal Television input source. (TV, INPUT 1, INPUT 2, INPUT 3, INPUT 4, PC) (See pages 42–46 and 50.)
- ☼:** When pressed all buttons on the remote control unit will light. The lighting will turn off if no operations are performed within about 5 seconds. This button is used for performing operations in dark places.
- MTS:** Select the MTS/SAP. (See page 25.)
- CC:** Display captions during closed-caption source. (See page 59.)
- TWIN CH buttons**
TWIN PICTURE: Set the twin picture mode. Press again to return to normal screen. (See page 67.)
FREEZE: Set the still image. Press again to return to normal screen. (See page 67.)
SELECT: Select the active screen. (See page 67.)
SUB INPUT: Select an input source of sub screen. (See page 67.)
TWIN CH ▲/▼: Select the channel of sub screen. (See page 67.)
- 0 – 9:** Set the channel.
- 100 ENT:** Select the three digit mode. Execute a command of the channel.
- CH ▲/▼:** Select the channel.
- MUTE:** Mute the sound. (See page 24.)
- SET/ENTER:** Execute a command.
- FAVORITE CH**
A, B, C, D: Select four preset favorite channels in four different categories. (See page 30 for details.)
 When viewing via ANT-A: up to 16 channels can be assigned in A, B, C and D.
 When viewing via ANT-B: up to 16 channels can be assigned in A, B, C and D.
 With ANT-A and B combined, you can preset up to 32 favorite channels in advance.

 While watching, you can toggle the selected channels by pressing A, B, C and D.
- LED for transmission confirmation**
- Mode switch:** (See pages 68 to 75 for details.)

Watching TV

Simple operations for watching a TV program

Antennas

To enjoy a clearer picture, use an outdoor antenna. The following is a brief explanation of the types of connections that are used for a coaxial cable. If your outdoor antenna uses a 75-ohm coaxial cable with an F-type connector, plug it into the antenna terminal at the rear of the AVC System.

NOTE

- The antenna and the cable converter cannot be connected at the same time.

- A 75-ohm system is generally a round cable with F-type connector that can easily be attached to a terminal without tools (not supplied).
- A 300-ohm system is a flat "twin-lead" cable that can be attached to a 75-ohm terminal through a 300/75-ohm adapter (not supplied).

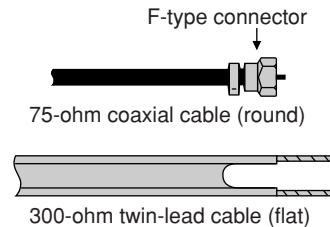

Cable converter/VCR connection

- Be sure to connect the antenna or the cable converter as follows. Signal reception may fail if improperly connected.
- Be sure to remember what kind of connection is made with your System.
- The connection type will determine whether to select "Air" or "Cable" for both ANT-A and B when configuring "Air/Cable" settings.

A-1. Connecting with Converter/Descrambler Box and VCR

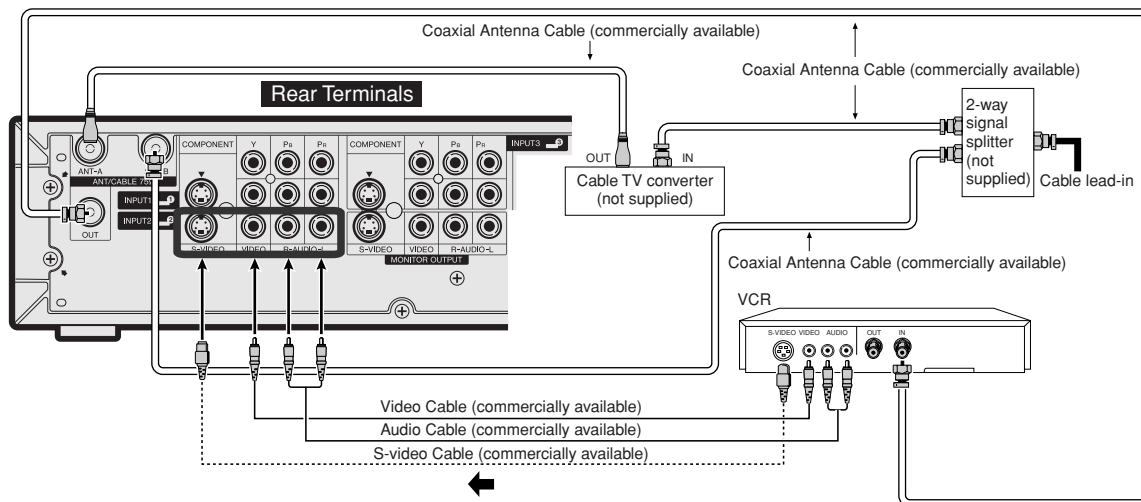

NOTE

- Be sure to remember what kind of connection is made with your System.
- Shown here is the preferred method of connecting a VCR and CATV Converter to your TV if you are in an area with good signal reception. This way you can view either TV programs or VCR tapes and not be concerned about the position of the VCR's TV/VCR switch and you can enjoy stereo tape playback from a stereo VCR.
- If your VCR has an S-Video terminal, S-video connection is recommended.

Cable converter/VCR connection (continued)

A-2. Connecting with cable converter using AUX terminals for audio and video output.
 (If your cable TV converter has both RF OUTPUT and AUX terminals, it is recommended to connect it as shown in example A-1.)

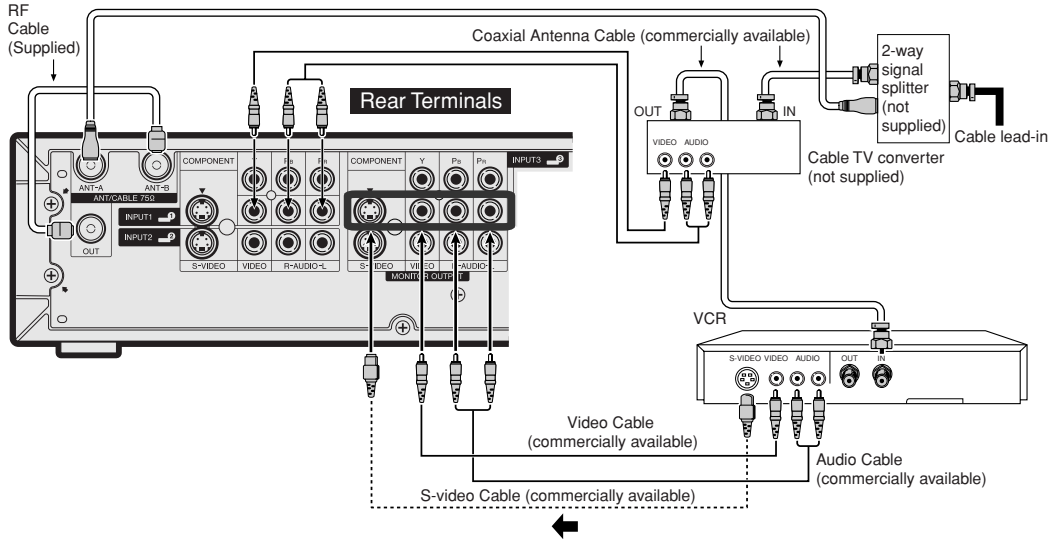

NOTE

- Be sure to remember what kind of connection is made with your System.
- Shown here is the preferred method of connecting a VCR and CATV Converter to your TV if you are in an area with good signal reception. This way you can view either TV programs or VCR tapes and not be concerned about the position of the VCR's TV/VCR switch and you can enjoy stereo tape playback from a stereo VCR.
- If your VCR has an S-Video terminal, S-video connection is recommended.

B. Connecting with Converter/Descrambler Box without VCR

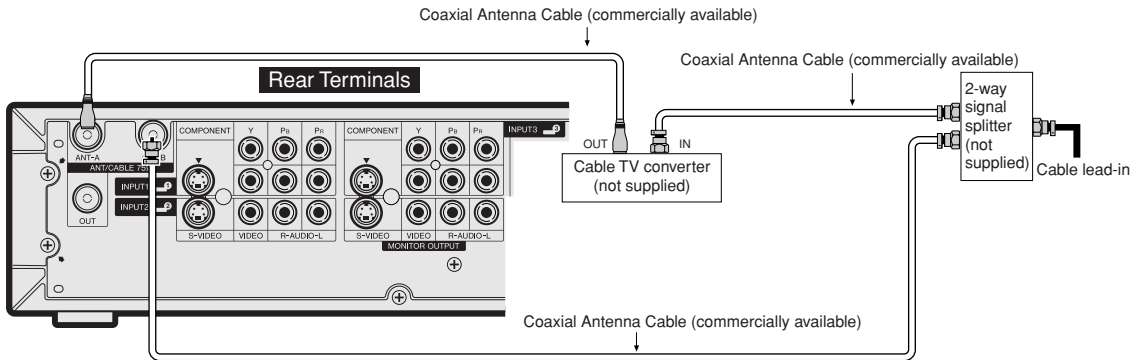

NOTE

- Be sure to remember what kind of connection is made with your System.
- Switching between Antenna-A and Antenna-B is possible by pressing the **ANT-A/B** button on the remote control.
- A good color picture depends on a good TV signal. So does good multi-channel sound. Ask your dealer for advice on how to install your outdoor antenna to receive the best possible signal.
- If you subscribe to Cable TV or have a central antenna for your building, you may not need an outdoor antenna.

Watching TV

C. Connecting Antenna Cable with VCR

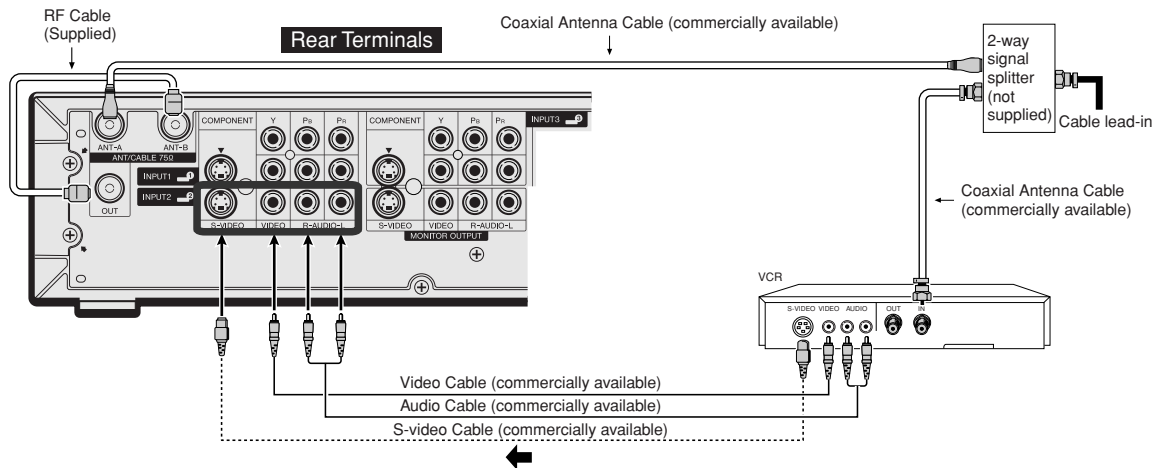

NOTE

- Be sure to remember what kind of connection is made with your System.
- Shown here is the preferred method of connecting a VCR to your TV if you are in an area with good signal reception. This way you can view either TV programs or VCR tapes and not be concerned about the position of the VCR's TV/VCR switch and you can enjoy stereo tape playback from stereo VCR.
- If your VCR has an S-Video terminal, S-video connection is recommended.
- If your lead cable is a 300-ohm twin-lead cable or UHF/VHF separate cable, use a 300/75-ohm adapter or combiner (output side is 75-ohm coaxial) to connect to the TV (see below).

Outdoor antenna connection

Connecting Antenna Cable

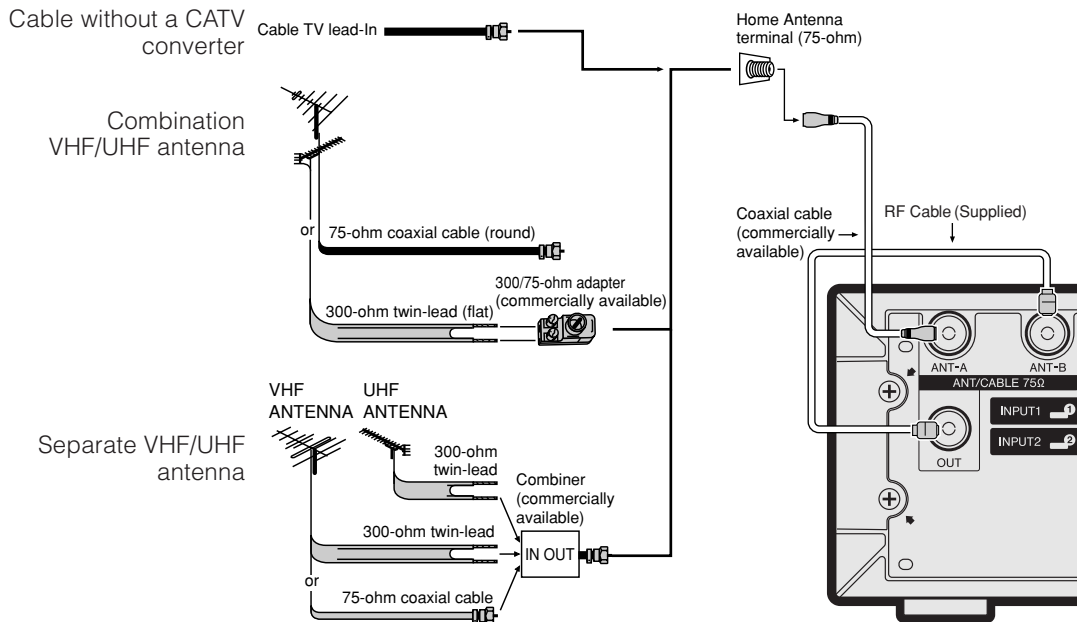

NOTICE

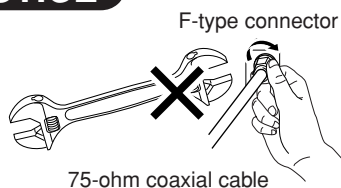

F-type connector should be finger-tightened only.

When connecting the RF cable to the TV set, do not tighten F-type connector with tools. If tools are used, it may cause damage to your TV set. (The breaking of internal circuit, etc.)

Watching TV

Connecting the AC cord

Connect the AC cords after all component connections have been completed.

Display (rear view)

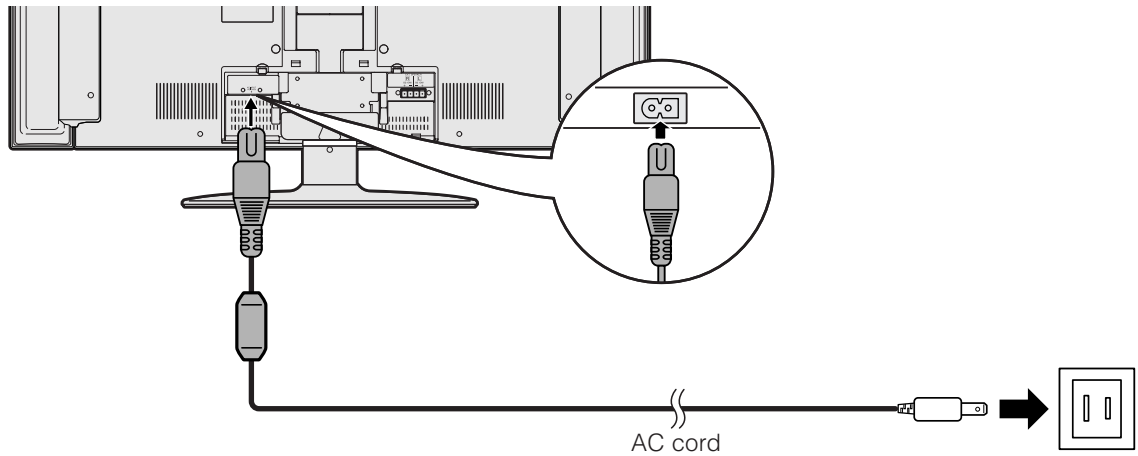

AVC System (rear view)

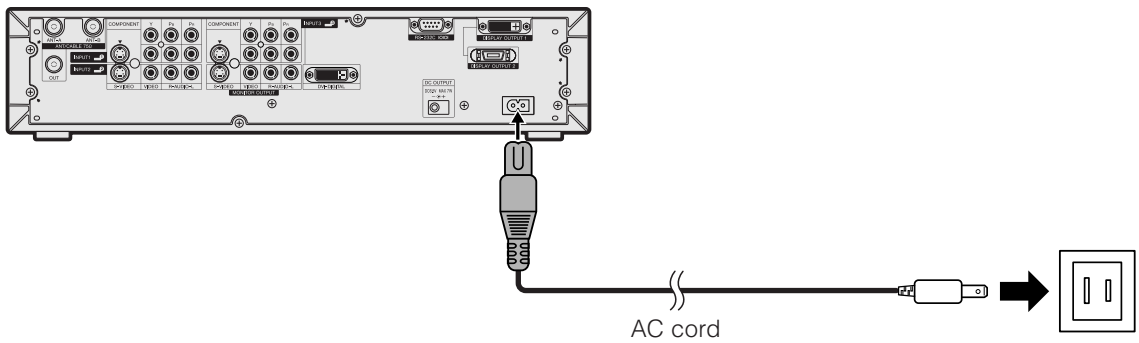

NOTE

- Always turn off the main power of the Display and AVC System when connecting the AC cords.
- Disconnect the AC cords from the AC outlet, Display and AVC System when the System is not going to be used for a long period of time.

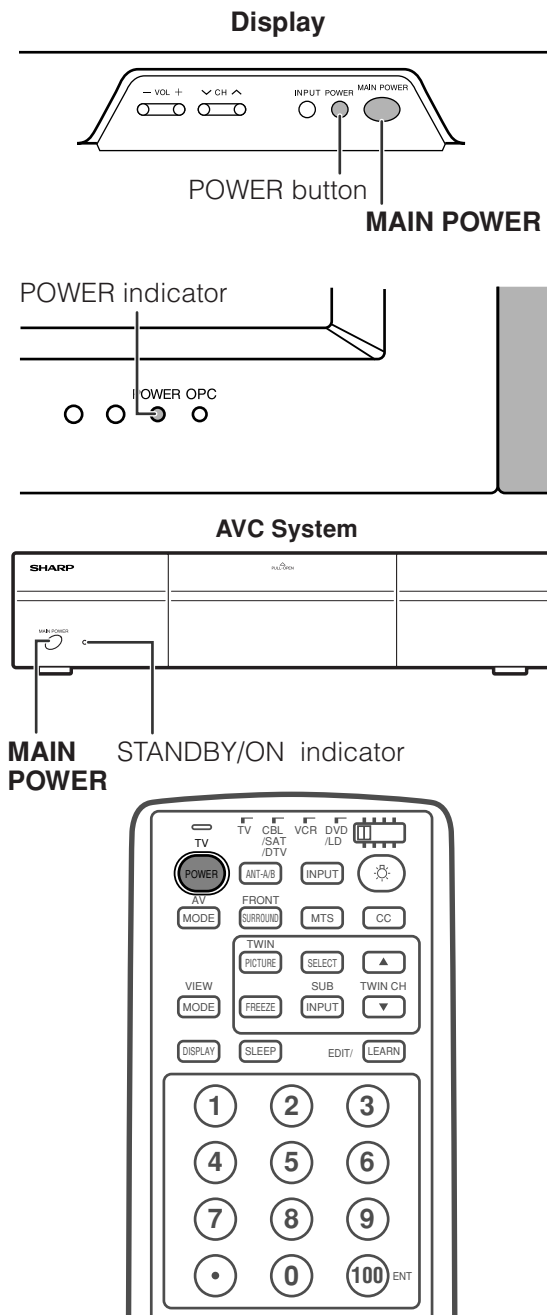

Turning on the power

- 1 Press **MAIN POWER** on the Display.
 - The POWER indicator on the Display flashes red.
- 2 Press **MAIN POWER** on the AVC System.
 - The System turns the power on.
 - The POWER indicator on the Display lights up green and the STANDBY/ON indicator on the AVC System lights up green.
 - If the STANDBY/ON indicator on the AVC System and the POWER indicator on the Display still light up red, press **TV POWER** on the remote control unit or **MAIN POWER** on the AVC System to turn the System on.

First time turning on the AVC System

- 1 Press **MAIN POWER** on the AVC System.
 - The STANDBY/ON indicator on the AVC System lights up red.
- 2 Press **MAIN POWER** on the Display.
 - The System turns the power on.
 - The POWER indicator on the Display lights up green and the STANDBY/ON indicator on the AVC System lights up green.
 - If the STANDBY/ON indicator on the AVC System and the POWER indicator on the Display still light up red, press **TV POWER** on the remote control unit or **POWER** button on the Display to turn the System on.

NOTE

- The initial setup starts when the System powers on for the first time. If the System has been turned on before, the EZ setup will not be invoked. See page 27 to try EZ setup from the Setup menu.

Turning off the power

- 1 Press **TV POWER** on the remote control unit or **POWER** button on the Display.
 - The System enters standby mode and the image on the screen disappears.
 - Both the STANDBY/ON indicator on the AVC System and the POWER indicator on the Display change from green to red.
- 2 Press **MAIN POWER** on the AVC System.
 - The STANDBY/ON indicator on the AVC System turns off and the POWER indicator on the Display flashes red.
- 3 Press **MAIN POWER** on the Display.
 - The POWER indicator on the Display gradually turns off.

NOTE

- If you are not going to use this System for a long period of time, be sure to remove the AC cords from the power outlet.
- When the STANDBY/ON indicator lights up red, it takes about 10 to 15 seconds for the indicator to turn off if **MAIN POWER** on the AVC System is turned "Off" or the AC cord is unplugged from the AC outlet.

Display status indicator

Off	Power off
Flashing red	AVC System does not turn on or its AC cord is disconnected.
Red	The System is in standby mode.
Green	The System is on.

AVC System status indicator

Off	Power off
Red	Only the AVC System is in standby mode or the System is in standby mode.
Green	The System is on.

Watching TV

Initial setup

When you turn on the System for the first time, it will automatically memorize the broadcasting channels where you live. Perform the following steps before you press **TV POWER** on the remote control unit.

1. Insert the batteries into the remote control unit. (See page 13.)
2. Connect the antenna cable to the AVC System. (See pages 17 to 19.)
3. Plug in the AC cord to the AC outlet. (See page 20.)

Language setting

Select from among 3 languages: English, French and Spanish.

1

Press **▲/▼** to select the desired language listed on the screen, and then press **SET/ENTER**.

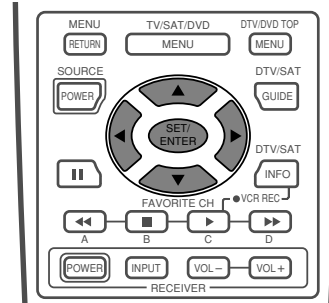

Channel search

Channel auto search makes the System look for all channels viewable in the set area.

Antenna setting

NOTE

- Make sure what kind of connection is made with your System when selecting "Air" or "Cable" for both ANT-A and B.

2

Press **◀/▶** to select "Air" or "Cable" for ANT-A, then press **▲/▼** to move down. Press **◀/▶** to select "Air" or "Cable" for ANT-B.

Press **SET/ENTER** to enter the setting.

- This operation makes the System search for both ANT-A and B.

Example

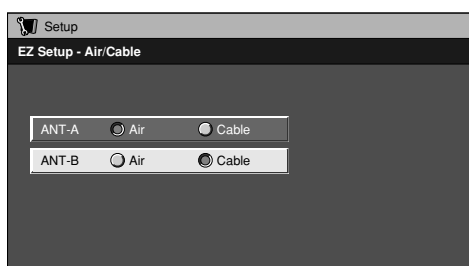
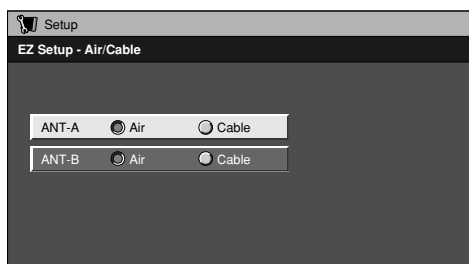

3

Example

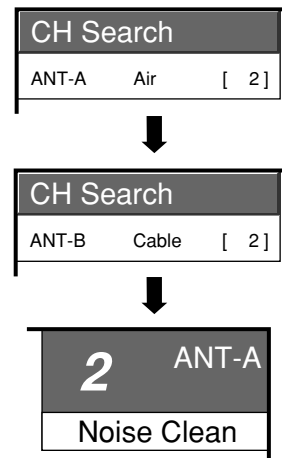

NOTE

- Make sure what kind of connection is made with your System when selecting "Air" or "Cable" for both ANT-A and B.
- If no channel is found, make sure what kind of connection is made with your System and try EZ setup again (see page 27).
- The illustrations and on-screen displays in this operation manual are for explanation purposes and may vary slightly from the actual operations.

Watching TV

Simple button operations for changing channels

You can change channels in several ways.

NOTE

- While watching a broadcast, press **ANT-A/B** to view the image received from the other tuner.

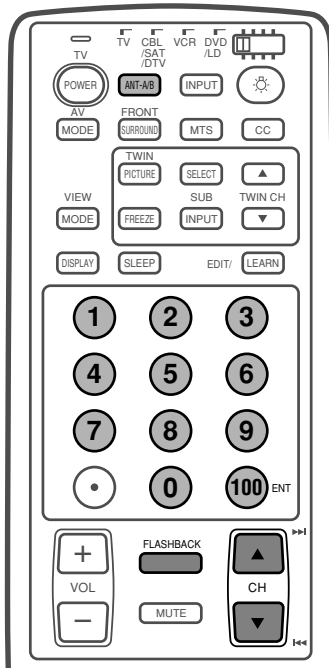

Using CH▲/▼ on the remote control unit

- Press **CH▲** to increase the channel number.
- Press **CH▼** to decrease the channel number.

NOTE

- CH▼/▲** on the Display operates the same as **CH▲/▼** on the remote control unit.

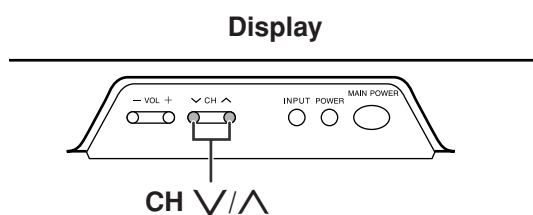

Changing channels with CH▲/▼ on the remote control unit or CH▼/▲ on the Display

Air: Press **CH▲** and the channel change in the order shown below:

2→3→...→68→69→2→3...

Press **CH▼** and the channel change in the order shown below:

3→2→69→68→...→3→2...

Cable: Press **CH▲** and the channel change in the order shown below:

1→2→3→...→125→1→2→3...

Press **CH▼** and the channel change in the order shown below:

3→2→1→125→...→3→2→1→...

Using FLASHBACK on the remote control unit

Press **FLASHBACK** to switch the currently tuned channel to the previously tuned channel.

Press **FLASHBACK** again to switch back to the currently tuned channel.

NOTE

- FLASHBACK** will not work if no channel has been changed after the System is turned on.

Using 0 – 9 and 100 on the remote control unit

Select the channels directly by pressing buttons **0** to **9** and **100**.

- The System allows you to select up to 125 channels (1 to 125). To select a channel, enter a 2 or 3-digit number.

EXAMPLE

To select a 1 or 2-digit channel number (e.g., Channel 5):

Complete the following steps within 3 seconds.

1

Press the **0** button.

- Complete the step 2 within 3 seconds after the step 1.

2

Press the **5** button.

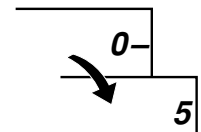

NOTE

- When selecting a 1-digit channel number, do not fail to press the **0** button.

To select a 3-digit channel number (e.g., Channel 115):

Complete the following steps within 3 seconds.

1

Press the **100** button.

- Complete the step 2 within 3 seconds after the step 1.

2

Press the **1** button.

- Complete the step 3 within 3 seconds after the step 2.

3

Press the **5** button.

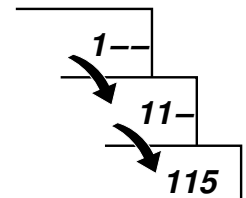

NOTE

- The **100** button is only enabled when selecting channels in Cable mode.

Simple button operations for changing volume/sound

Changing the volume

You can change the volume on the Display or on the remote control unit.

Display

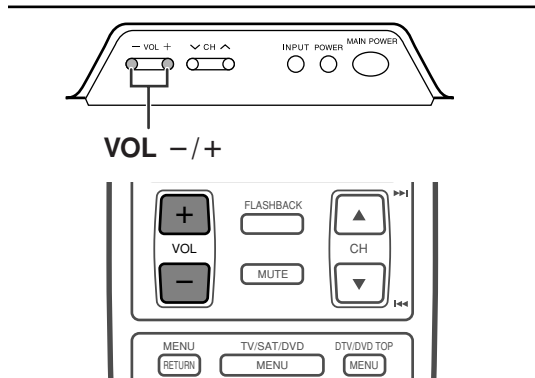

Using VOL +/- on the remote control unit

- To increase the volume, press **VOL +**.
- To decrease the volume, press **VOL -**.

Volume adjustment



NOTE

- **VOL -/+** on the Display operates the same as **VOL +/-** on the remote control unit.

Audio status

Output device	Audio out	
	Fixed	Variable
Speaker	Variable sound	Mute
MONITOR OUT	Constant as specified	Variable sound

* When "Audio Out" is set to "Variable", the indicator on the screen changes as shown below.



NOTE

- See page 55 for details on the audio out function.

Using MUTE on the remote control unit

Mutes the current sound output.

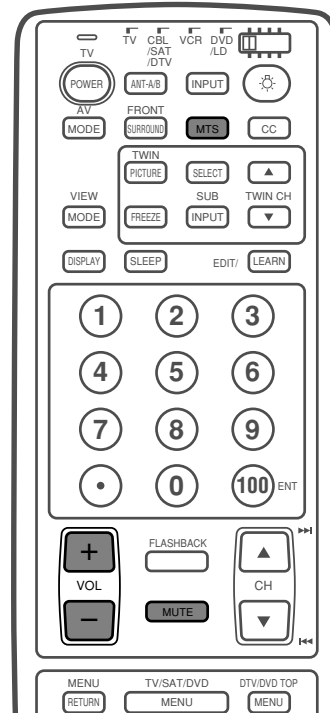

1

Press **MUTE**.

- "M" has been displayed on the screen for 30 minutes, and the sound is silenced.

Mute

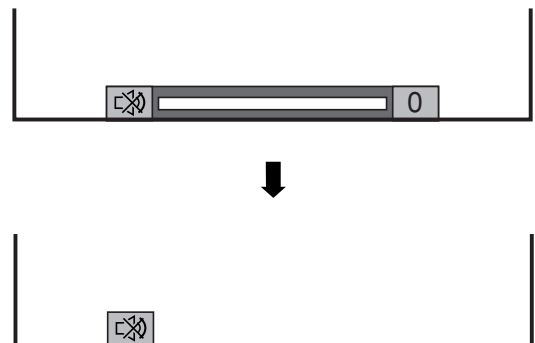

NOTE

- Within 30 minutes of pressing **MUTE**, mute can be canceled by using one of the methods below.
 - Pressing **VOL -/+** on the Display or **VOL +/-**, **MTS** or **MUTE** on the remote control unit can also cancel the mute.
- **Mute will be canceled after 30 minutes have passed. However, the System will not suddenly output a loud sound as the volume level is set to 0 automatically.**

2

Within 30 minutes, press **MUTE** again to cancel the mute.

- Before 30 minutes, the volume level returns to the previous setting.
- After 30 minutes, increase the volume level by pressing **VOL +**.

Using FRONT SURROUND on the remote control unit

(●) produces SRS and FOCUS effects from the speakers.
 Each time you press **FRONT SURROUND**, the mode changes among SRS, FOCUS, FOCUS + SRS and Off.

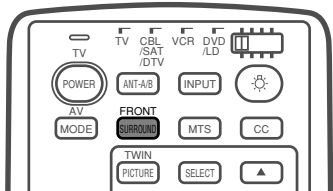

SRS sound options

- **SRS (Sound Retrieval System):** Creates more a natural sound retrieving the spatial information from any stereo recording and restoring the original three-dimensional sound field.
- **FOCUS:** Repositions a sound image from two speakers to a more optimal listening position or height without moving them.
- **FOCUS + SRS:** Produces both SRS and FOCUS effects.
- **Off:** Outputs the normal sound.

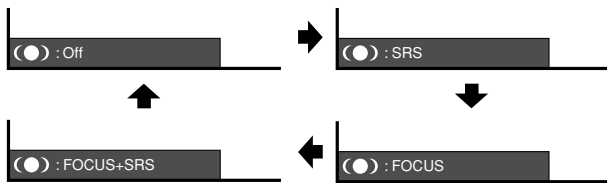

Setting MTS/SAP stereo mode

The System has a feature that allows reception of sound other than the main audio for the program. This feature is called Multi-channel Television Sound (MTS). The System with MTS can receive mono sound, stereo sound and Secondary Audio Programs (SAP). The SAP feature allows a TV station to broadcast other information, which could be audio in another language or something completely different like weather information.

You can enjoy Hi-Fi stereo sound or SAP broadcasts where available.

- **Stereo broadcasts**
View programs like live sporting events, shows and concerts in dynamic stereo sound.
- **SAP broadcasts**
Receive TV broadcasts in either MAIN or SAP sound.
 MAIN sound: The normal program soundtrack (either in mono or stereo).
 SAP sound: Listen to second language, supplementary commentary and other information. (SAP is mono sound.)

If stereo sound is difficult to hear.

- Obtain a clearer sound by manually switching to fixed mono-sound mode.

NOTE

- Once "MONO" mode is selected, the sound remains mono even if the System receives a stereo broadcast. You must switch the mode back to "STEREO" if you want to hear stereo sound again.
- Selecting MTS while in the input mode does not change the type of sound. In this case, sound is determined by the video source.

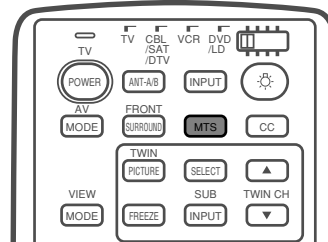

Each time you press **MTS**, MTS toggles as shown below.

Examples: when receiving MTS and SAP

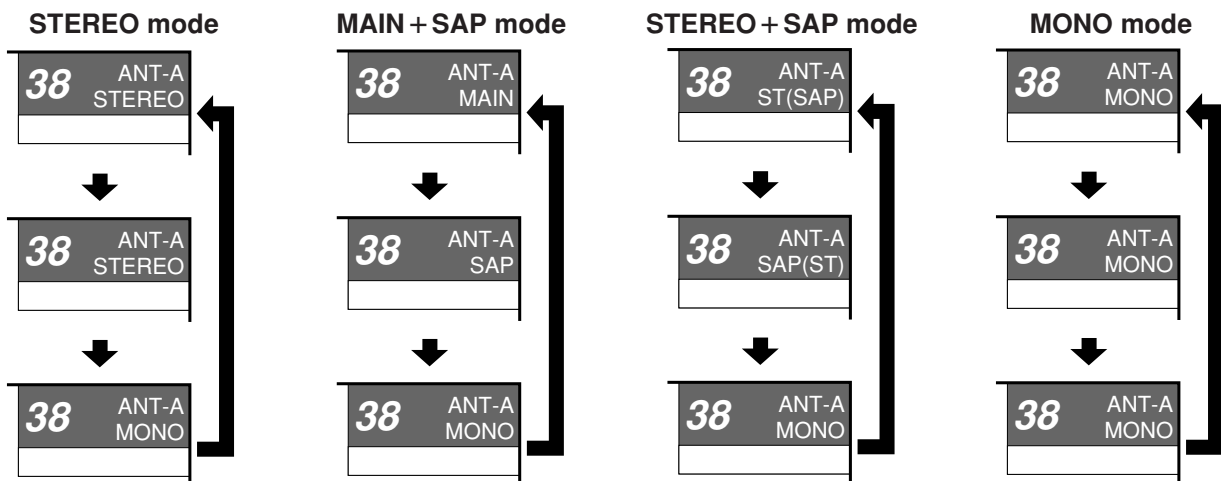

Basic adjustment settings

AV input mode menu items

List of AV menu items to help you with operations



Contrast	Page 32
Brightness	Page 32
Color	Page 32
Tint	Page 32
Sharpness	Page 32
Advanced	
C.M.S.	Page 33
Color Temp	Page 34
Black	Page 34
3D-Y/C	Page 35
Monochrome	Page 35
Film Mode	Page 36
I/P Setting	Page 36



Treble	Page 37
Bass	Page 37
Balance	Page 37
Speaker	Page 57

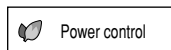

Power Save	Page 38
No Signal Off	Page 39
No Operation Off	Page 39

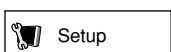

EZ Setup	Page 27
CH Setup	Pages 28-30
Input Signal	Page 50
Parental CTRL	Pages 60-66
Position	Page 47
Picture Flip	Page 51
Language	Page 31

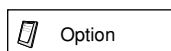

Input Select	Page 50
Noise Clean	Page 54
Audio Out	Page 55
Cool Climate	Page 58

PC input mode menu items

List of PC menu items to help you with operations



Contrast	Page 32
Brightness	Page 32
Red	Page 32
Green	Page 32
Blue	Page 32
C.M.S.	Page 33

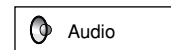

Treble	Page 37
Bass	Page 37
Balance	Page 37
Speaker	Page 57

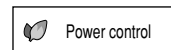

Power Save	Page 40
Power Management	Page 40

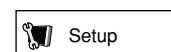

Input Signal	Page 54
Auto Sync.	Page 49
Fine Sync.	Page 49
Picture Flip	Page 51
Language	Page 31

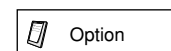

Audio Out	Page 55
Cool Climate	Page 58

Basic adjustment settings

EZ setup

You can run EZ Setup again, even after setting up the preset channels.

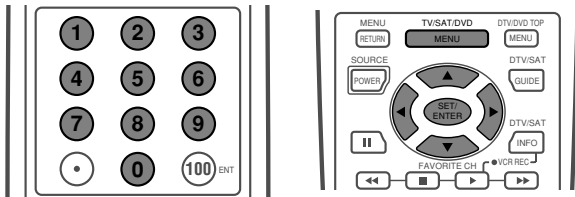

Language setting

Select from among 3 languages: English, French and Spanish.

1 Press **MENU** and the TV MENU screen displays.

2 Press **◀/▶** to select "Setup".

3 Press **▲/▼** to select "EZ Setup", and then press **SET/ENTER**.

- If you already set the Secret No., go to step 4. If not, skip to step 5.

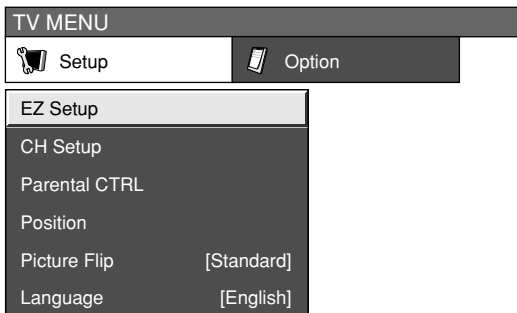

4 Input the 4-digit secret number by using **0 - 9**.

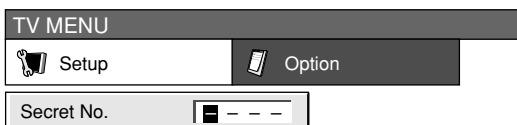

5 Press **▲/▼** to select the desired language listed on the screen, and then press **SET/ENTER**.



Antenna setting

NOTE

- Make sure what kind of connection is made with your System when selecting "Air" or "Cable" for both ANT-A and B.

6

Press **◀/▶** to select "Air" or "Cable" for ANT-A, then press **▲/▼** to move down. Press **◀/▶** to select "Air" or "Cable" for ANT-B. Press **SET/ENTER** to enter the setting.

- This operation makes the System search for both ANT-A and B.

Example

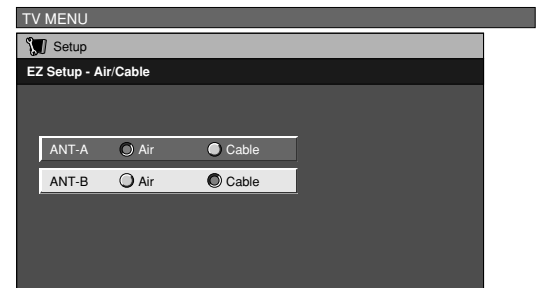
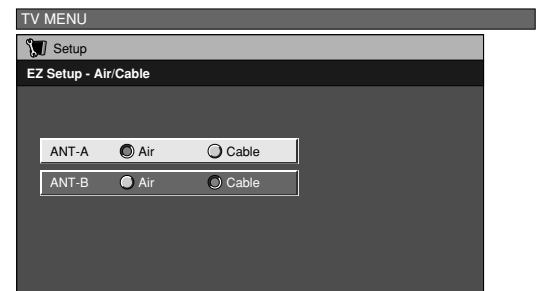

Channel search

Channel auto search makes the System look for all channels viewable in the set area.

7

Searching TV channels

Example

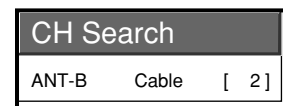

NOTE

- If no channel is found, make sure what kind of connection is made with your System and try EZ setup again.
- Make sure what kind of connection is made with your System when selecting "Air" or "Cable" for both ANT-A and B.

Basic adjustment settings

Channel setup

If initial setup does not memorize all the channels in your region, follow the instructions below to manually memorize the channels.

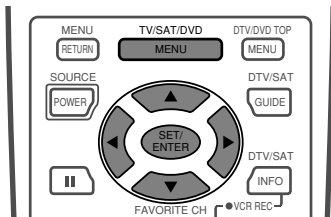

Antenna setting

- 1 Press **MENU** and the TV MENU screen displays.
- 2 Press **◀/▶** to select "Setup".
 - Setup menu displays.
- 3 Press **▲/▼** to select "CH Setup", and then press **SET/ENTER**.
 - If you already set the Secret No., input the 4-digit secret number here. See page 60 for setting a secret number.

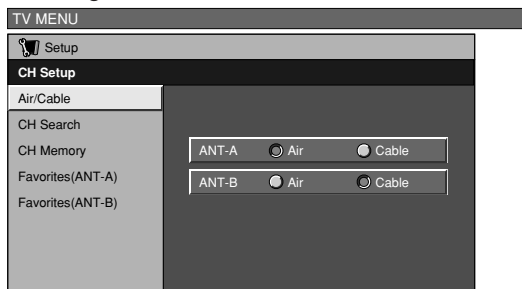

- 4 Press **▲/▼** to select "Air/Cable", and then press **SET/ENTER**.
- 5 Press **◀/▶** to select "Air" or "Cable" for ANT-A, then press **▲/▼** to move down. Press **◀/▶** to select "Air" or "Cable" for ANT-B. Press **SET/ENTER** to enter the setting.

Example

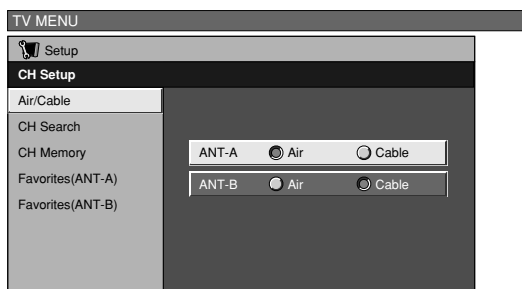

NOTE

- Make sure what kind of connection is made with your System when selecting "Air" or "Cable" for both ANT-A and B.

Channel search

Channel auto search makes the System look for all channels viewable in the set area.

- 1 Press **MENU** and the TV MENU screen displays.
- 2 Press **◀/▶** to select "Setup".
 - Setup menu displays.
- 3 Press **▲/▼** to select "CH Setup", and then press **SET/ENTER**.
 - If you already set the Secret No., input the 4-digit secret number here. See page 60 for setting a secret number.
- 4 Press **▲/▼** to select "CH Search", and then press **SET/ENTER**.
 - Search All: searches both ANT-A and B successively.
 - Search for ANT-A: searches ANT-A only.
 - Search for ANT-B: searches ANT-B only.

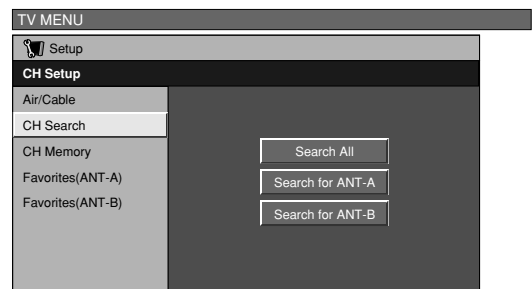

- 5 Press **▲/▼** to select the desired item, and then press **SET/ENTER**.
 - Channel Search automatically starts.

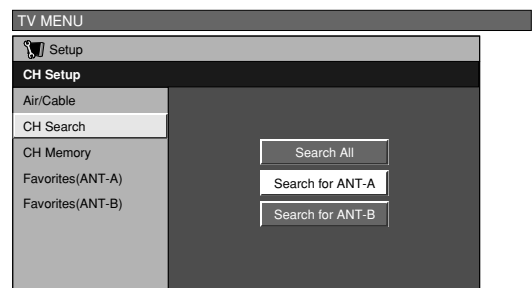

Example

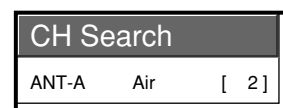

NOTE

- Make sure what kind of connection is made with your System.

Basic adjustment settings

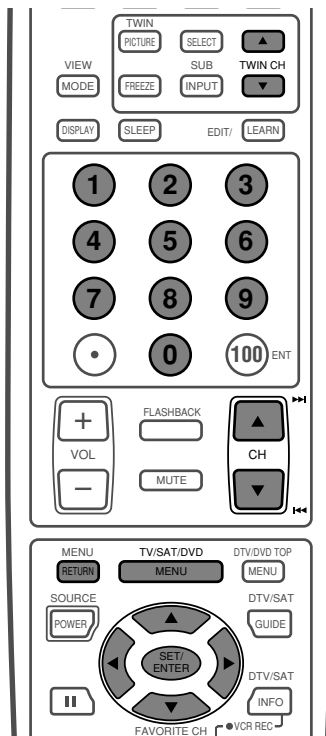

7 Press ▲/▼ to select “Skip”, and press ◀/▶ to select “On” or “Off”.

- On: Skips channels. (Channel selection disabled using **CH▲/▼** and **TWIN CH▲/▼**.)
- Off: Does not skip channels. (Channel selection enabled using **CH▲/▼** and **TWIN CH▲/▼**.)

NOTE

- Make sure what kind of connection is made with your System.

Channel memory setting

1 Press **MENU** and the TV MENU screen displays.

2 Press ◀/▶ to select “Setup”.

- Setup menu displays.

3 Press ▲/▼ to select “CH Setup”, and then press **SET/ENTER**.

- If you already set the Secret No., input the 4-digit secret number here. See page 60 for setting a secret number.

4 Press ▲/▼ to select “CH Memory”, and then press **SET/ENTER**.

Example

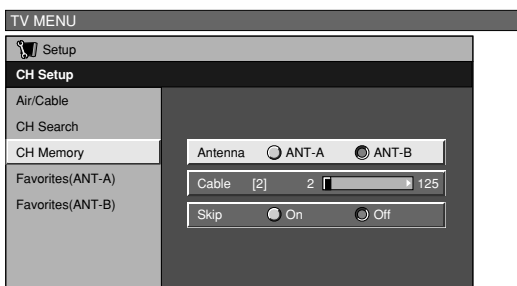

5 Press ◀/▶ to select ANT-A or B.

6 Press ▲/▼ and press ◀/▶ to select the channel you want to skip or not.

Channel setup (continued)

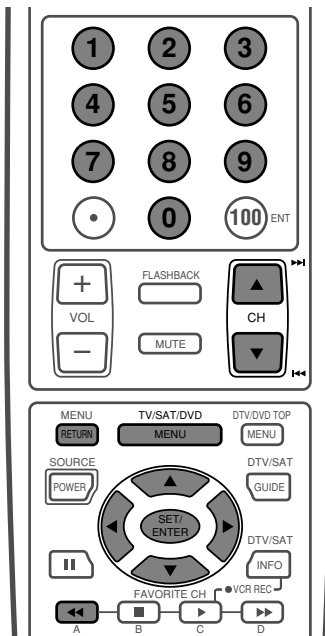

Favorite channel setting

This function allows you to program 4 favorite channels, in 4 different categories. (A total of 32 channels with ANT-A and B combined.) By setting the favorite channels in advance, you can select your favorite channels easily.

NOTE

- Make sure what kind of connection is made with your System.

- 1 Press **MENU** and the TV MENU screen displays.
- 2 Press **◀/▶** to select "Setup".
- 3 Press **▲/▼** to select "CH Setup", and then press **SET/ENTER**.
 - If you already set the Secret No., input the 4-digit secret number here. See page 60 for setting a secret number.

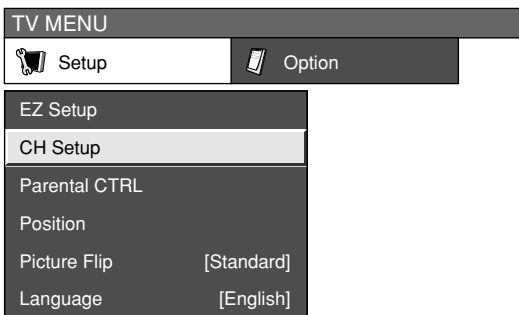

4

Press **▲/▼** to select "Favorites(ANT-A)" or "Favorites(ANT-B)", and then press **SET/ENTER**.

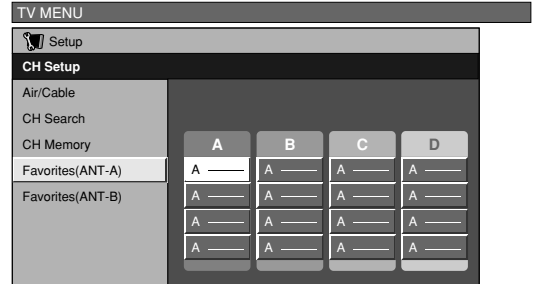

(On-screen display when "Favorites(ANT-A)" is selected.)

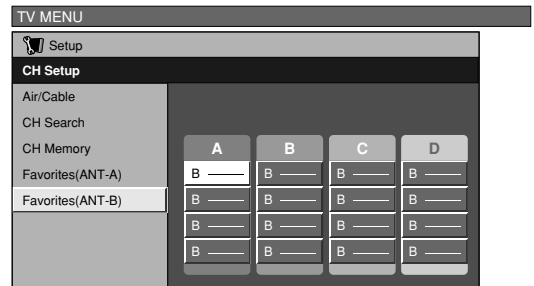

(On-screen display when "Favorites(ANT-B)" is selected.)

5

- ① Press **▲/▼/◀/▶** to select the position in the area.
- ② Press **SET/ENTER**, and press **▲/▼** to select your favorite channel to register.
- ③ Press **SET/ENTER** to register the setting.
- ④ Repeat steps ① to ③ until your desired channels are assigned.

Example

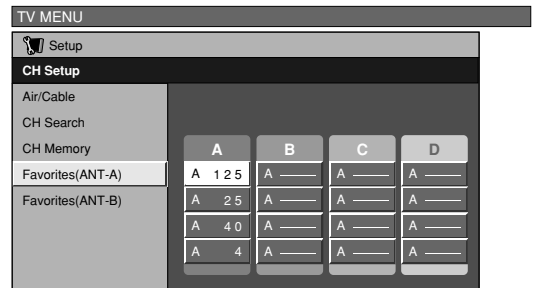

6

Press **MENU** or **MENU/RETURN** to exit.

NOTE

- If the channels are memorized as shown, you can toggle the assigned channels by pressing **FAVORITE CH A**.

Example: Cable

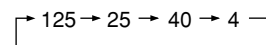

Basic adjustment settings

Language setting

You can also select a language from the setup menu. Select from among 3 languages: English, French and Spanish.

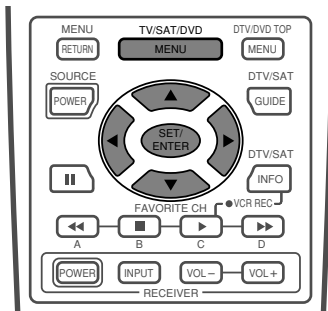

AV input mode

- 1 Press **MENU** and the TV MENU screen displays.
- 2 Press **◀/▶** to select "Setup".
- 3 Press **▲/▼** to select "Language", and then press **SET/ENTER**.

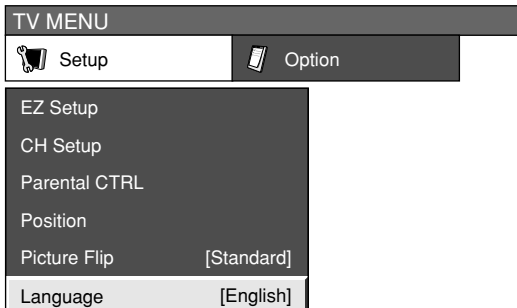

- 4 Press **▲/▼** to select the desired language listed on the screen, and then press **SET/ENTER**.



PC input mode

- 1 Press **MENU** and the PC MENU screen displays.
- 2 Press **◀/▶** to select "Setup".
- 3 Press **▲/▼** to select "Language", and then press **SET/ENTER**.



- 4 Press **▲/▼** to select the desired language listed on the screen, and then press **SET/ENTER**.



Basic adjustment settings

Picture adjustments

Adjust the picture to your preference with the following picture settings.

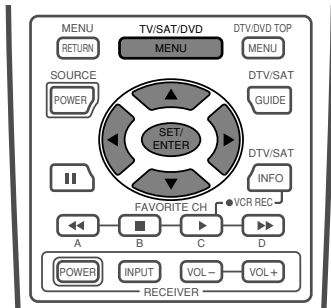

1

Press **MENU** and the TV MENU (PC MENU) screen displays.

2

Press ◀/▶ to select "Picture".
• Picture menu displays.

3

Press ▲/▼ to select a specific adjustment item.

4

Press ◀/▶ to adjust the item to your desired position.

NOTE

- When all adjustments set to factory preset values,
 - Press ▲/▼ to select "Reset", and then press **SET/ENTER**.
 - Press ◀/▶ to select "Yes", and then press **SET/ENTER**.

Adjustments items for AV source



Adjustments items for PC source



Selected item	◀ button	▶ button
Contrast	For less contrast	For more contrast
Brightness	For less brightness	For more brightness
Color	For less color intensity	For more color intensity
Tint	Skin tones become purplish	Skin tones become greenish
Sharpness	For less sharpness	For more sharpness

Selected item	◀ button	▶ button
Contrast	For less contrast	For more contrast
Brightness	For less brightness	For more brightness
Red	For weaker red	For stronger red
Green	For weaker green	For stronger green
Blue	For weaker blue	For stronger blue

NOTE

- Select "Advanced" and then press **SET/ENTER** to set "C.M.S.", "Color Temp", "Black", "3D-Y/C", "Monochrome", "Film Mode" or "I/P Setting". See pages 33 to 36.

Basic adjustment settings

C.M.S. (Color Management System)

Color tone is managed using the six-color adjustment setting.

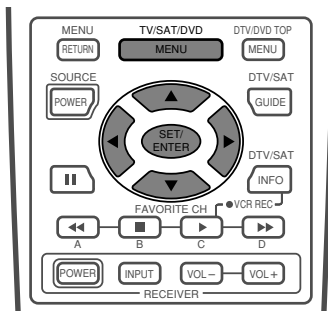

AV input mode

1 Press **MENU** and the TV MENU screen displays.

2 Press **◀/▶** to select "Picture".

3 Press **▲/▼** to select "Advanced", and then press **SET/ENTER**.



4 Press **▲/▼** to select "C.M.S.", and then press **SET/ENTER**.

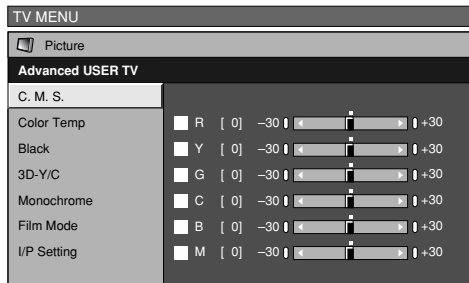

5

Press **▲/▼** to select a specific adjustment item. Press **◀/▶** to adjust the item to your desired position.

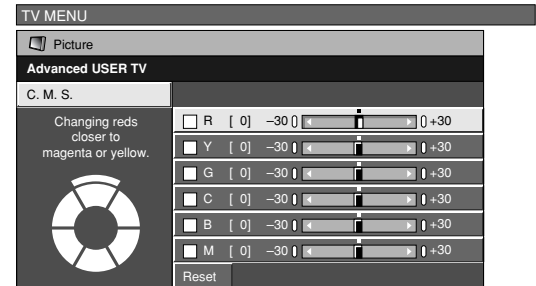

NOTE

- For resetting all adjustment items to the factory preset values, press **▲/▼** to select "Reset", and then press **SET/ENTER**.

PC input mode

1 Press **MENU** and the PC MENU screen displays.

2 Press **◀/▶** to select "Picture".

3 Press **▲/▼** to select "C.M.S.", and then press **SET/ENTER**.



4

Press **▲/▼** to select a specific adjustment item. Press **◀/▶** to adjust the item to your desired position.

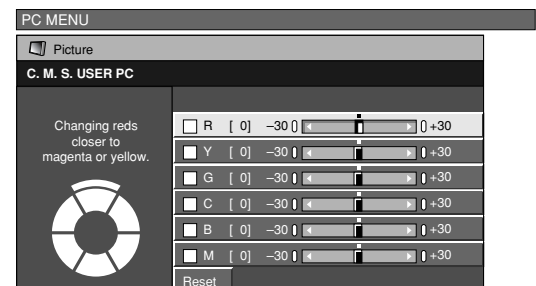

NOTE

- For resetting all adjustment items to the factory preset values, press **▲/▼** to select "Reset", and then press **SET/ENTER**.

Basic adjustment settings

Color temperature

Adjusts the color temperature to give a better white balance.

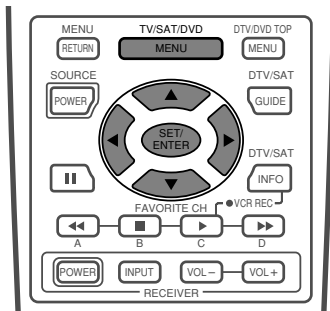

1 Press **MENU** and the TV MENU screen displays.

2 Press **◀/▶** to select "Picture".

3 Press **▲/▼** to select "Advanced", and then press **SET/ENTER**.



4 Press **▲/▼** to select "Color Temp", and then press **SET/ENTER**.



5 Press **▲/▼** to select the desired level, and then press **SET/ENTER**.

Selected item	Description
High	White with Bluish tone ↑ ↓ White with Reddish tone
Mid-High	
Mid	
Mid-Low	
Low	

Black

Select a level for automatically adjusting blackish tone to suit viewing conditions.

1 Press **MENU** and the TV MENU screen displays.

2 Press **◀/▶** to select "Picture".

3 Press **▲/▼** to select "Advanced", and then press **SET/ENTER**.

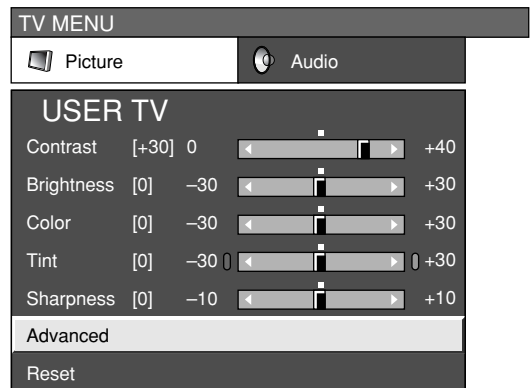

4 Press **▲/▼** to select "Black", and then press **SET/ENTER**.



5 Press **▲/▼** to select the desired level, and then press **SET/ENTER**.

Selected item	Description
Off	No adjustment
High	For high detail in black portions
Low	For low detail in black portions

Basic adjustment settings

3D-Y/C

Provides high quality images with minimal dot crawl and cross color noise.

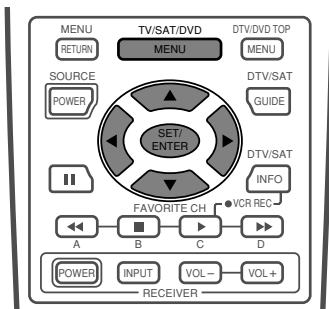

1 Press **MENU** and the TV MENU screen displays.

2 Press **◀/▶** to select "Picture".

3 Press **▲/▼** to select "Advanced", and then press **SET/ENTER**.



4 Press **▲/▼** to select "3D-Y/C", and then press **SET/ENTER**.

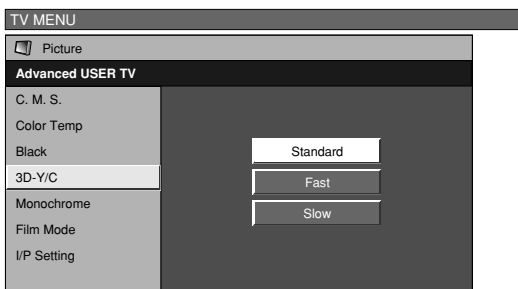

5 Press **▲/▼** to select the desired level, and then press **SET/ENTER**.

Selected item	Description
Standard	Normal adjustment
Fast	For movie image
Slow	For still image

NOTE

- "3D-Y/C" is not selectable when receiving images from DVI or component video terminals.

Monochrome

For viewing a video in monochrome.

1 Press **MENU** and the TV MENU screen displays.

2 Press **◀/▶** to select "Picture".

3 Press **▲/▼** to select "Advanced", and then press **SET/ENTER**.



4 Press **▲/▼** to select "Monochrome", and then press **SET/ENTER**.

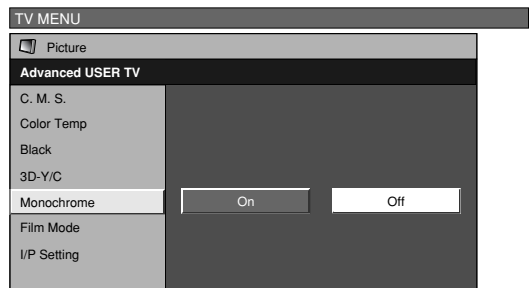

5 Press **◀/▶** to select "On", and then press **SET/ENTER**.

Selected item	Description
Off	Normal color
On	For viewing in monochrome

Basic adjustment settings

Film mode (3:2 pull-down)

Automatically detects a film-based source (originally encoded at 24 frames/second), analyses it then recreates each still film frame for high-definition picture quality.

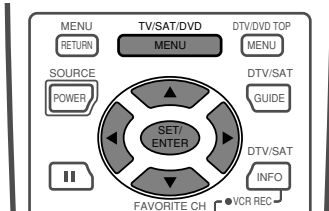

1 Press **MENU** and the TV MENU screen displays.

2 Press **◀/▶** to select "Picture".

3 Press **▲/▼** to select "Advanced", and then press **SET/ENTER**.



4 Press **▲/▼** to select "Film Mode", and then press **SET/ENTER**.
 • Some items may be grayed out. They are not selectable.

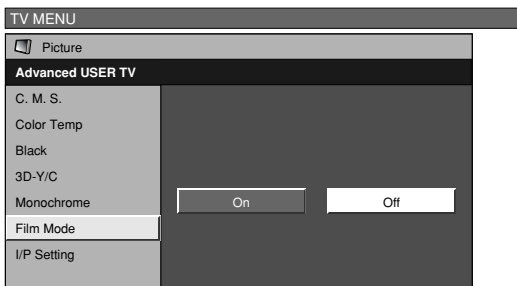

5 Press **◀/▶** to select "On", and then press **SET/ENTER**.

Selected item	Description
Off	Normal viewing mode
On	Detects, analyzes, converts film source

I/P Setting

Adjusting the image and input signal can give you a more beautiful picture.

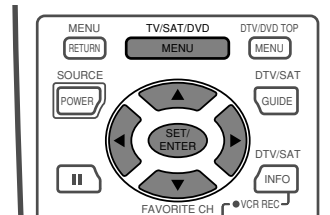

1 Press **MENU** and the TV MENU screen displays.

2 Press **◀/▶** to select "Picture".

3 Press **▲/▼** to select "Advanced", and then press **SET/ENTER**.



4 Press **▲/▼** to select "I/P Setting", and then press **SET/ENTER**.
 • Some items may be grayed out. They are not selectable.

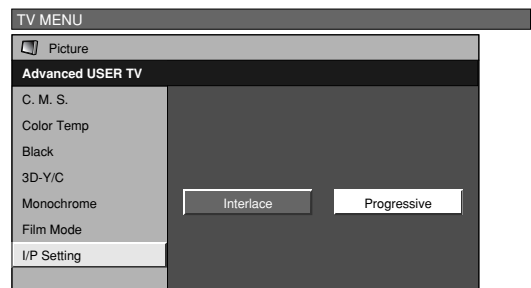

5 Press **◀/▶** to select "Interlace" or "Progressive", and then press **SET/ENTER**.

NOTE

- I/P Setting is set to Progressive when Film Mode is "On".
- "I/P Setting" is not selectable when channel display shows an input resolution of 480P, 720P or 1080I.

Basic adjustment settings

Sound adjustment

You can adjust the sound quality to your preference with the following settings.

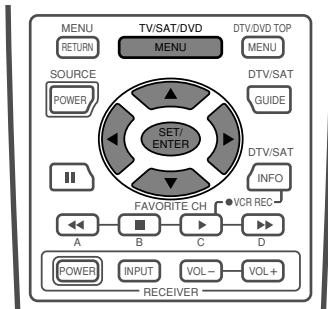

1 Press **MENU** and the TV MENU (PC MENU) screen displays.

2 Press ◀/▶ to select "Audio".

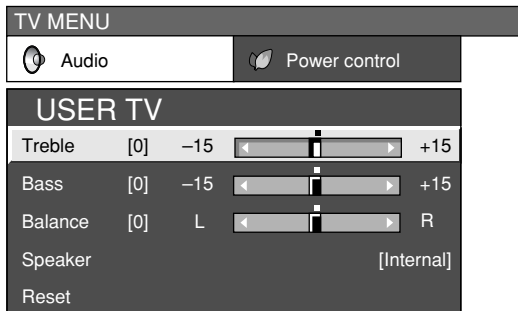

3 Press ▲/▼ to select a specific adjustment item.

4 Press ◀/▶ to adjust the item to your desired position.

Selected item	◀button	▶button
Treble	For weaker treble	For stronger treble
Bass	For weaker bass	For stronger bass
Balance	Decrease audio from the right speaker	Decrease audio from the left speaker

NOTE

- When all adjustments set to factory preset values,
 - Press ▲/▼ to select "Reset", and then press **SET/ENTER**.
 - Press ◀/▶ to select "Yes", and then press **SET/ENTER**.

Basic adjustment settings

Power control

Power control setting allows you to save energy.

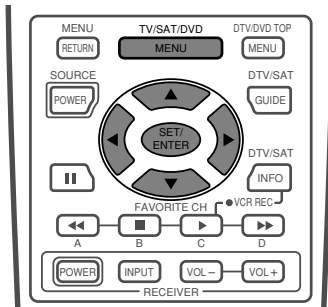

Power control for AV source

Power save

When set to "Manual" or "Auto", power consumption is reduced by decreasing backlight brightness.

1 Press **MENU** and the TV MENU screen displays.

2 Press **◀/▶** to select "Power control".

3 Press **▲/▼** to select "Power Save", and then press **SET/ENTER**.

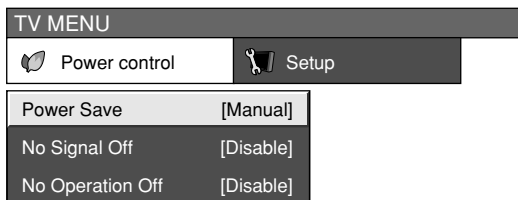

4 Press **◀/▶** to select the desired backlight brightness, and then press **SET/ENTER**.

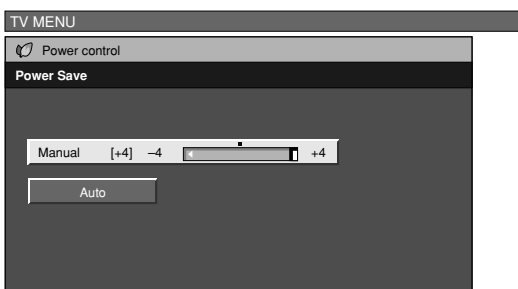

NOTE

- When setting to "Auto", the OPC indicator lights up green, senses the surrounding light and automatically adjusts the backlight brightness. Make sure no object obstructs the OPC sensor, which could affect its ability to sense surrounding light.

Basic adjustment settings

No signal off

When set to "Enable", the power will automatically shut down if no signal inputs for 15 minutes.

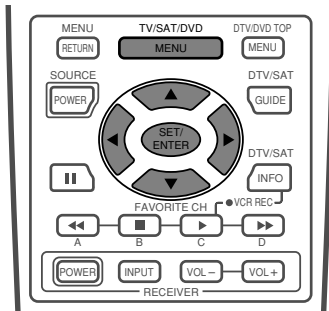

1 Press **MENU** and the TV MENU screen displays.

2 Press **◀/▶** to select "Power control".

3 Press **▲/▼** to select "No Signal Off", and then press **SET/ENTER**.

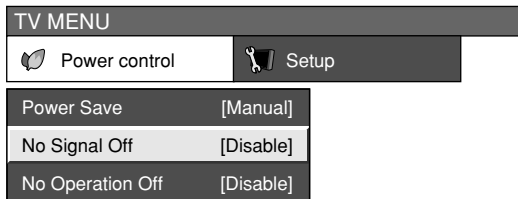

4 Press **◀/▶** to select "Enable", and then press **SET/ENTER**.

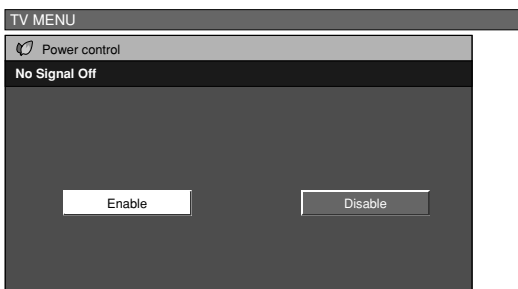

- Five minutes before the power shuts down, remaining time displays every minute.

NOTE

- "Disable" is factory preset value.
- When a TV program finishes, and the AVC System receives signal input, this function may not operate.

No operation off

When set to "Enable", the power will automatically shut down if there is no operation for 3 hours.

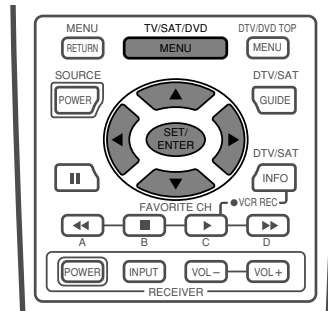

1 Press **MENU** and the TV MENU screen displays.

2 Press **◀/▶** to select "Power control".

3 Press **▲/▼** to select "No Operation Off", and then press **SET/ENTER**.

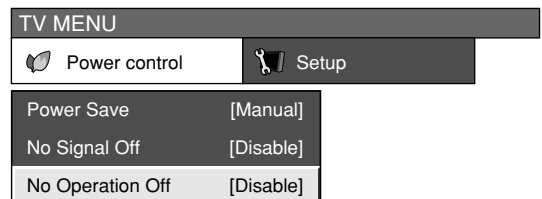

4 Press **◀/▶** to select "Enable", and then press **SET/ENTER**.

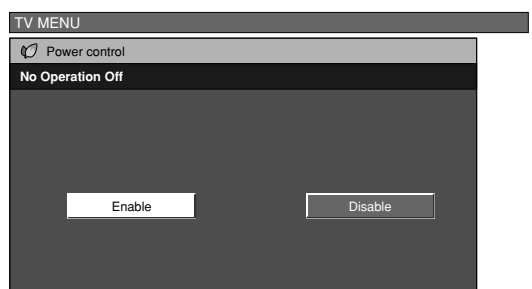

- Five minutes before the power shuts down, remaining time displays every minute.

NOTE

- "Disable" is factory preset value.

Basic adjustment settings

Power control for PC source

Power control setting allows you to save energy.

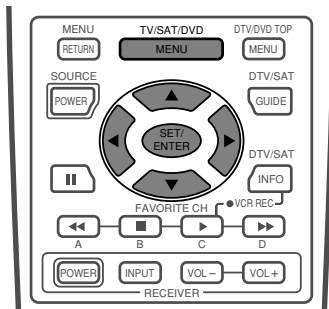

Power save

1 Press **MENU** and the PC MENU screen displays.

2 Press **◀▶** to select "Power control".

3 Press **▲▼** to select "Power Save", and then press **SET/ENTER**.

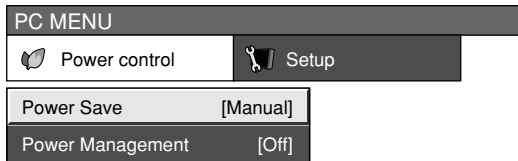

4 Press **◀▶** to select the desired backlight brightness, and then press **SET/ENTER**.

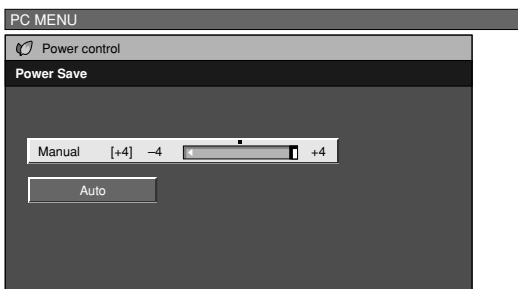

NOTE

- When setting to "Auto", the OPC indicator lights up green, senses the surrounding light and automatically adjusts the backlight brightness. Make sure no object obstructs the OPC sensor, which could affect its ability to sense surrounding light.

Power management

When set, the power will automatically shut down.

1 Press **MENU** and the PC MENU screen displays.

2 Press **◀▶** to select "Power control".

3 Press **▲▼** to select "Power Management", and then press **SET/ENTER**.

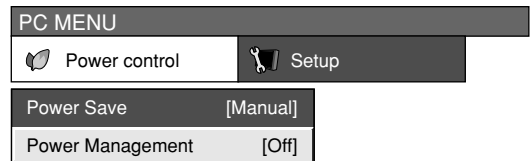

4 Press **▲▼** to select "Mode1" or "Mode2", and then press **SET/ENTER**.

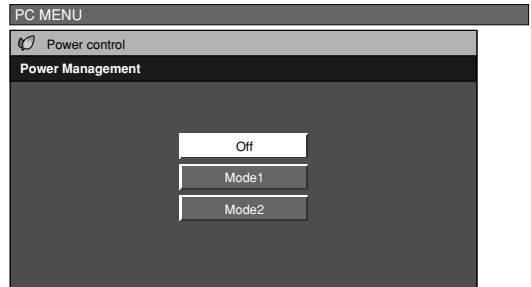

Selected item	Description
Off	<ul style="list-style-type: none"> No power management Factory preset value.
Mode1	<ul style="list-style-type: none"> If no signal inputs for 8 minutes, the power shuts down. Even if you start using the PC and the signal inputs again, the System stays off. The System turns on again by pressing POWER button on the Display or TV POWER on the remote control unit. (See page 21).
Mode2	<ul style="list-style-type: none"> If no signal inputs for 8 seconds, the power shuts down. When you start using the PC and the signal inputs again, the System turns on.

Using external equipment

You can connect many types of external equipment to your System, like a DVD player, VCR, Digital TV tuner, PC, game console and camcorder. To view external source images, select the input source from **INPUT** on the remote control unit or on the Display.

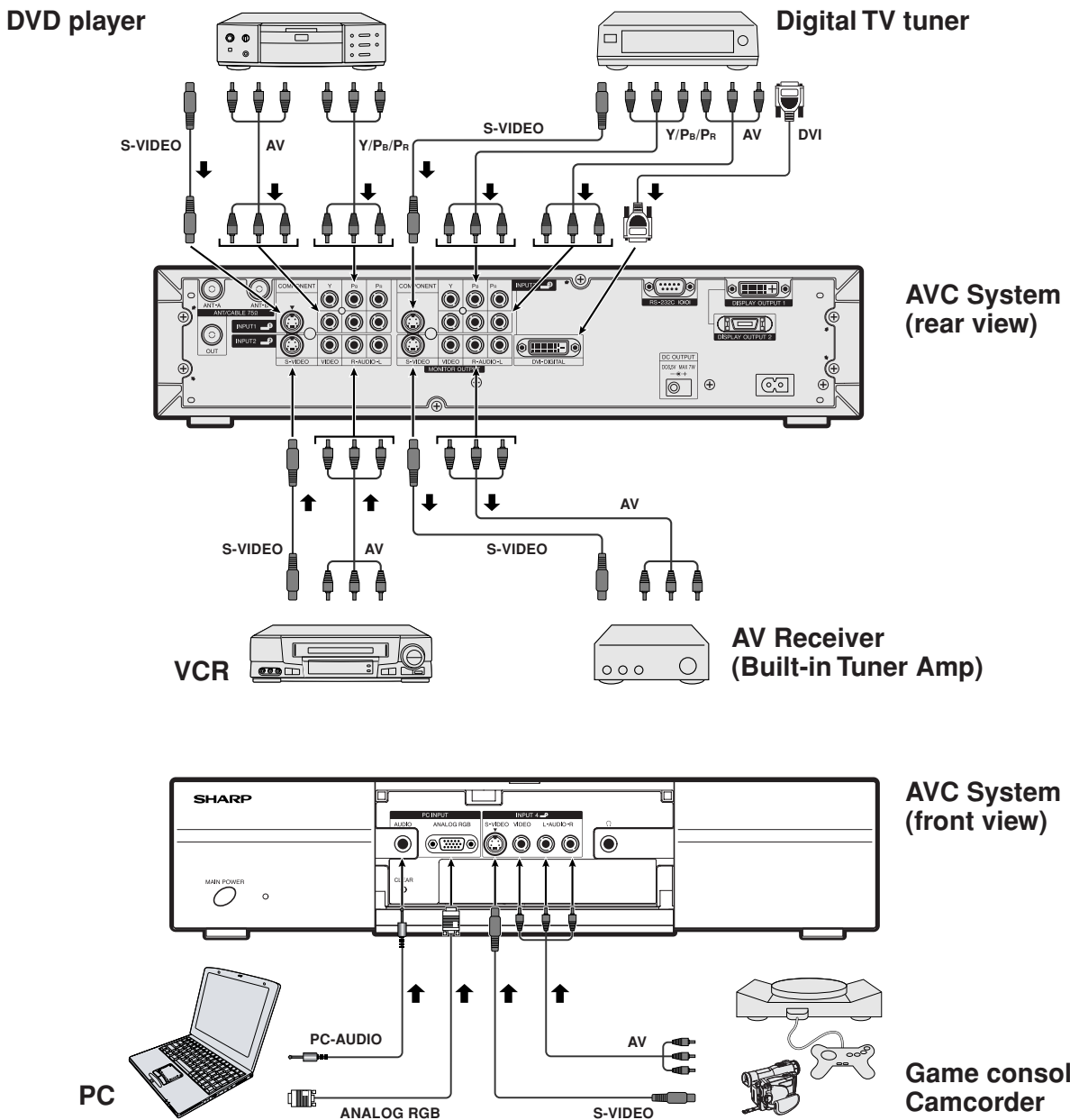

CAUTION

- To protect all equipment, always turn off the AV System before connecting to a DVD player, VCR, Digital TV tuner, PC, game console, camcorder or other external equipment.

NOTE

- Please refer to the relevant operation manual (DVD player, PC, etc.) carefully before making connections.

Using external equipment

Watching a DVD image

Connecting a DVD player

You can use the INPUT 1 terminal when connecting to a DVD player and other audiovisual equipment.

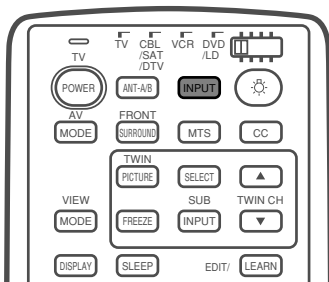
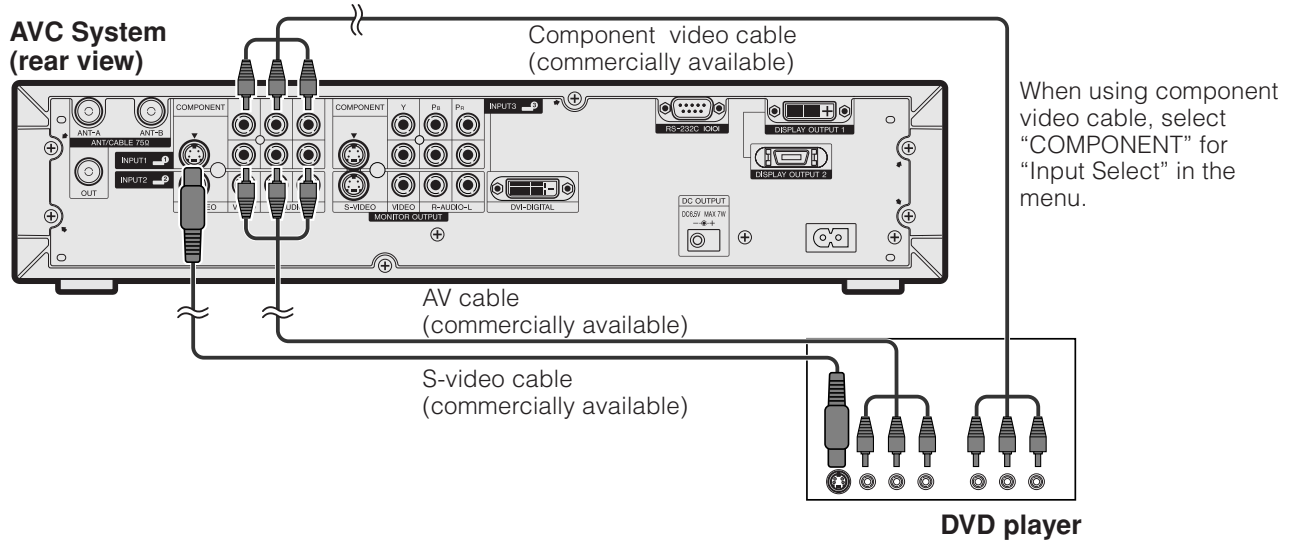

Displaying a DVD image

To watch a DVD image, select "INPUT1" from "INPUT SOURCE" menu using **INPUT** on the remote control unit or on the Display. (See page 50.)

Then select "INPUT1" on "Input Select" in the "Option" menu to set the correct input signal type. (See page 50.)

The setting is stored and can be selected on the "INPUT SOURCE" menu.

NOTE

- Each time **INPUT** is pressed, the input source toggles.
- If the DVD image does not come in clearly, you may need to change the input signal type setting on the "Input Select" menu.
- Refer to your DVD player operation manual for the signal type.

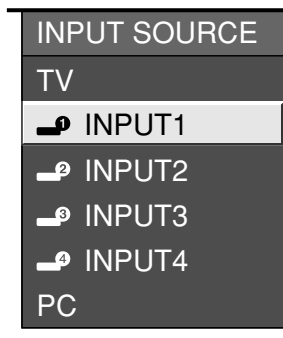

For INPUT1 signal

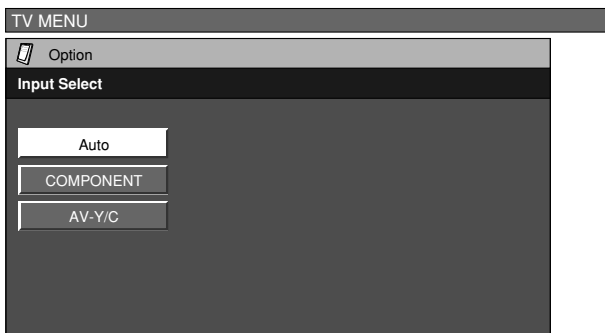

Using external equipment

Watching a VCR image

Connecting a VCR

You can use the INPUT 2 terminal when connecting a VCR and other audiovisual equipment.

AVC System (rear view)

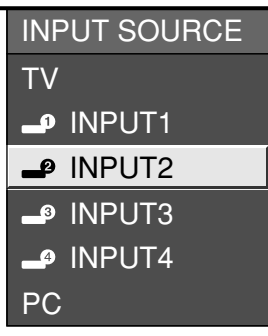
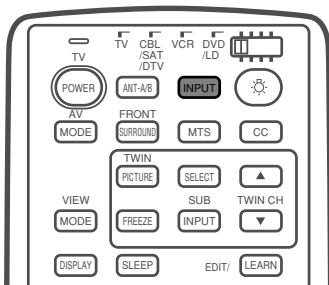
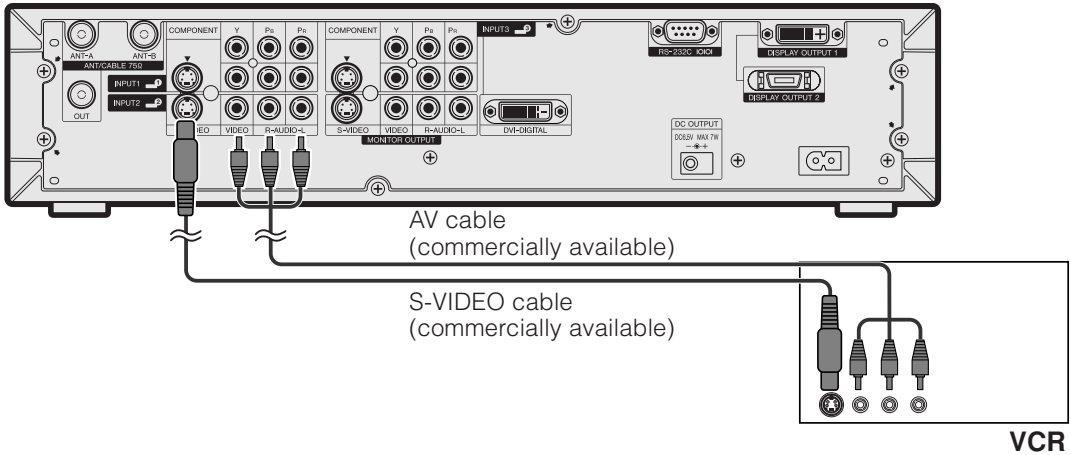

Displaying a VCR image

To watch a VCR image, select "INPUT2" from the "INPUT SOURCE" menu using **INPUT** on the remote control unit or on the Display. (See page 50.)

When connecting to the INPUT 2 terminals, select "INPUT2".

You only need to select the input source on the "INPUT SOURCE" menu.

NOTE

- Each time **INPUT** is pressed, the input source toggles.
- Refer to your VCR operation manual for the signal type.

Using external equipment

Watching broadcasts via a Digital TV tuner

Connecting a Digital TV tuner

You can use the INPUT 3 terminal when connecting a Digital TV tuner and other audiovisual equipment.

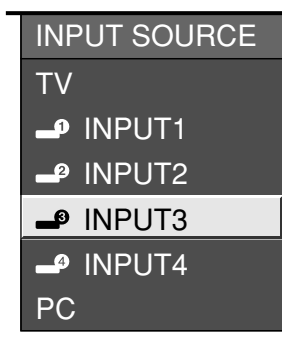
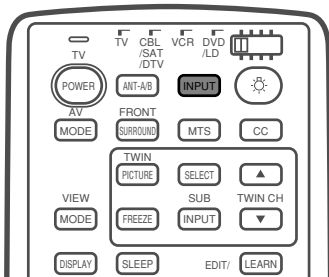
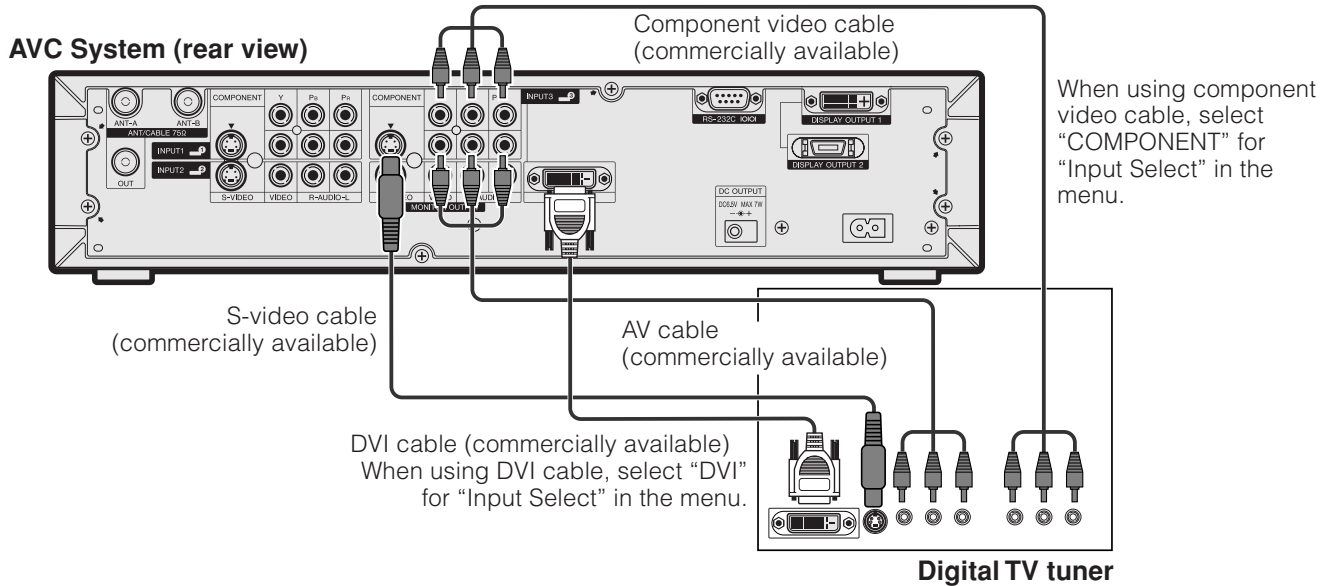

For INPUT3 signal

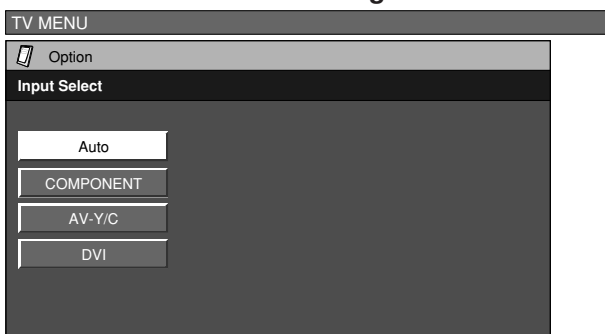

Displaying broadcasts via a Digital TV tuner

To watch a Digital TV tuner image, select "INPUT3" from the "INPUT SOURCE" menu using **INPUT** on the remote control unit or on the Display. (See page 50.)

Then select "INPUT3" on "Input Select" in the "Option" menu to set the correct input signal type. (See page 50.)

The setting is stored and can be selected on the "INPUT SOURCE" menu.

NOTE

- Each time **INPUT** is pressed, the input source toggles.
- If the Digital TV tuner image does not come in clearly, you may need to change the input signal type setting on the "Input Select" menu.
- Refer to your Digital TV tuner operation manual for the signal type.
- DVI-DIGITAL INPUT cannot connect to a PC. Input resolution is compatible with 1080I, 720P, 480P and VGA (60Hz).
- Use the PC INPUT terminals on the front of the AVC System when connecting a PC. (See page 46.)
- When connecting to the DVI-DIGITAL INPUT terminal, be sure to use a commercially available DVI cable with ferrite core attached.

Using external equipment

Enjoying a game console or viewing camcorder images

Connecting a game console or camcorder

A game console, camcorder and some other audiovisual equipment are conveniently connected using the INPUT 4 terminals.

NOTE

- The S-video terminal has priority over the video terminals.

AVC System (front view)

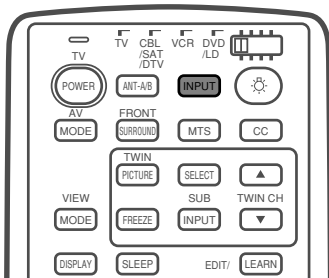
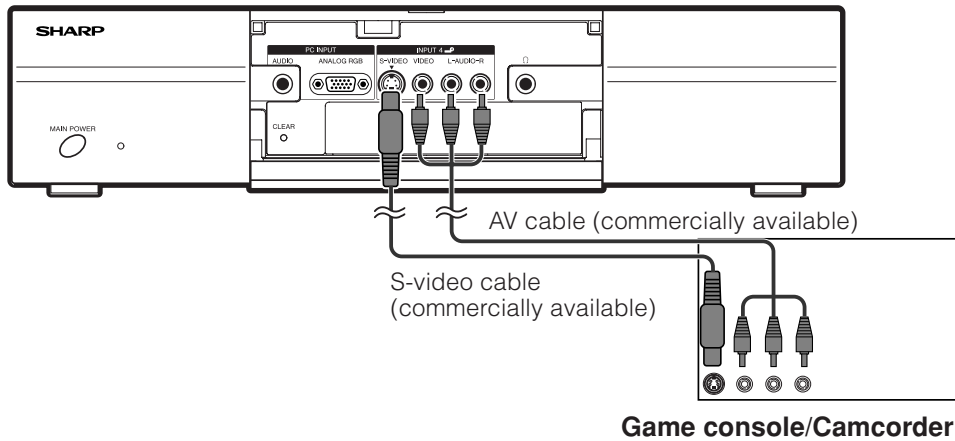

Displaying an image of the game console or camcorder

To connect a game console or view a camcorder, select "INPUT4" from the "INPUT SOURCE" menu using **INPUT** on the remote control unit or on the Display. (See page 50.)

When connecting to the INPUT 4 terminals, select "INPUT4".

You only need to select the input source on the "INPUT SOURCE" menu.

NOTE

- Each time **INPUT** is pressed, the input source toggles.

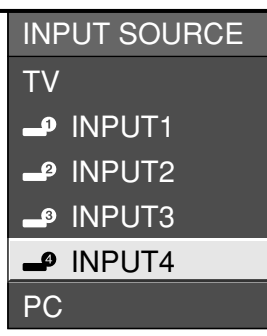

Using external equipment

Viewing an image from a PC

Connecting a PC

Use the PC terminals to connect a PC.

NOTE

- The PC input terminals are DDC1/2B-compatible.
- Refer to page 77 for a list of PC signals compatible with the System.

AVC System (front view)

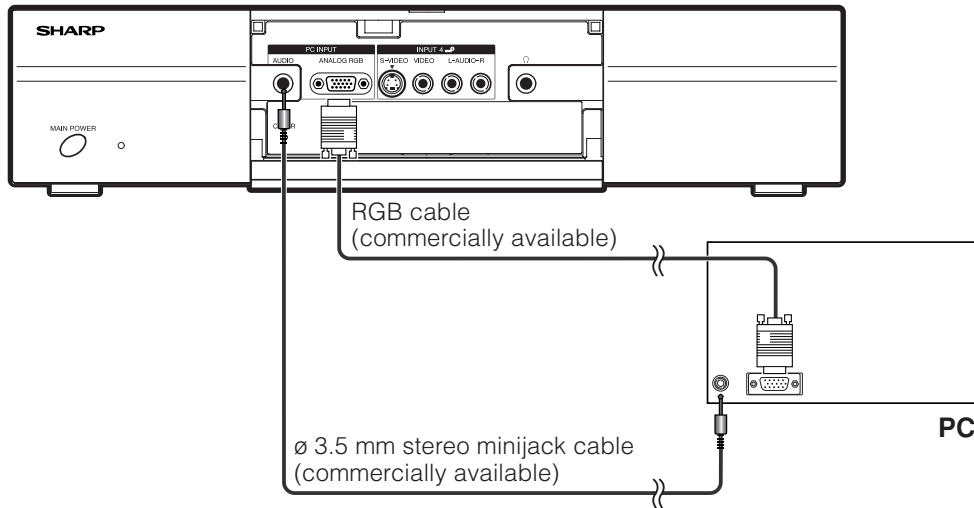

Signal names for 15-pin mini D-sub connector

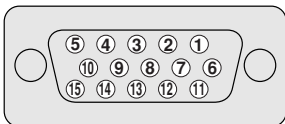

Pin No.	Signal name	Pin No.	Signal name	Pin No.	Signal name
①	R	⑥	GND (Ground)	⑪	Not connected
②	G	⑦	GND (Ground)	⑫	SDA
③	B	⑧	GND (Ground)	⑬	HD
④	Not connected	⑨	+5V	⑭	VD
⑤	CSYNC	⑩	GND (Ground)	⑮	SCL

NOTE

- Macintosh adaptor may be required for use for some Macintosh computers.

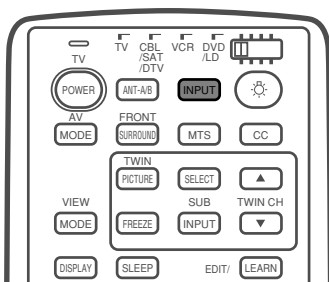

INPUT SOURCE

- TV
- ➊ INPUT1
- ➋ INPUT2
- ➌ INPUT3
- ➍ INPUT4
- PC

Displaying an image from a PC

To view an image from a PC, select "PC" from the "INPUT SOURCE" menu using **INPUT** on the remote control unit or on the Display. (See page 50.)

When connecting to a PC, the correct input signal type is automatically detected. If the PC image does not come in clearly, you may need to set the Auto Sync. adjustment on the "Auto Sync." in the "Setup" menu. (See page 49.)

You only need to select the input source on the "INPUT SOURCE" menu.

NOTE

- Each time **INPUT** is pressed, the input source toggles.

Useful adjustment settings

Image position (AV input mode only)

For adjusting a picture's horizontal and vertical position.

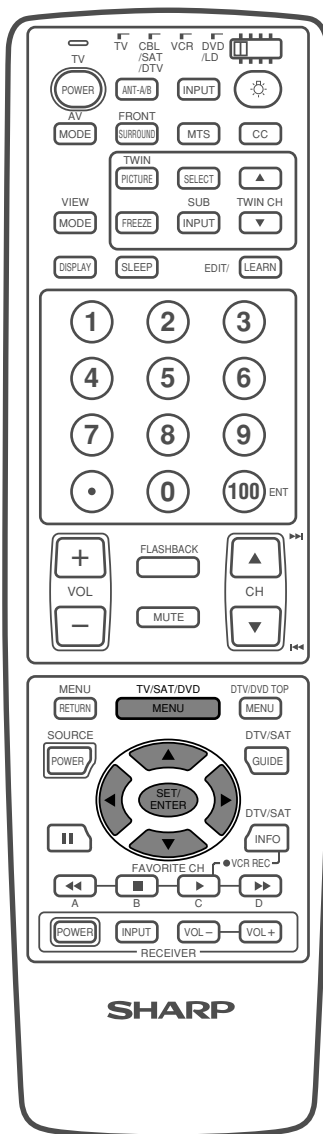

1

Press **MENU** and the TV MENU screen displays.

2

Press ◀▶ to select "Setup".

3

Press ▲/▼ to select "Position", and then press **SET/ENTER**.

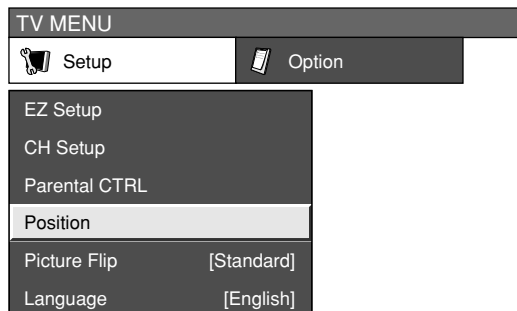

4

Press ▲/▼ to select "H-Pos." or "V-Pos.".



5

Press ◀▶ to adjust the item to your desired position.

NOTE

- For resetting all adjustment items to the factory preset values, press ▲/▼ to select "Reset", and then press **SET/ENTER**.
- **Adjustments are stored separately according to input source.**
- You can easily move the image position as shown on page 48, but when the power is switched off the image will return to the previously memorized position.

Selected item	Description
H-Pos.	Centers the image by moving it to the left or right.
V-Pos.	Centers the image by moving it up or down.

Moving the picture on the screen

You can move the picture around on the screen.

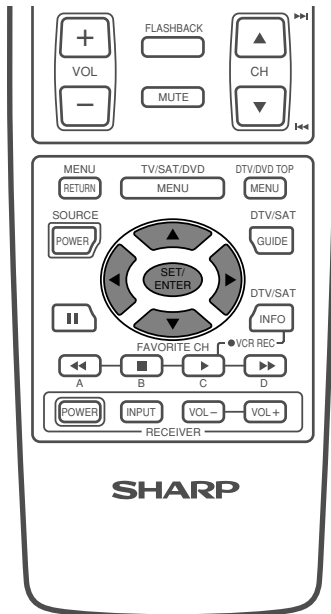

Press ▲/▼/◀/▶ to move an image on the screen to the desired position. Press **SET/ENTER** to return to the initial image position.

NOTE

- While pressing ▲/▼/◀/▶, an on-screen image, "Adjusting Position" displays to the desired position.
- This setting cannot be stored. Once the System shuts down or enters standby mode, the setting is erased. To move the picture around the screen again, you must perform the above procedure again.
- The image position setting using the steps on page 47 can be stored. Select either according to your objectives.
- "TV", "INPUT1", "INPUT2", "INPUT3" and "INPUT4" can each adjust the image position setting on this page. The same for view modes.
- An on-screen image from a PC source cannot be moved around.
- Even when the image fills the screen, its position can be adjusted with this function.
- Initialize the image position by pressing **SET/ENTER**.

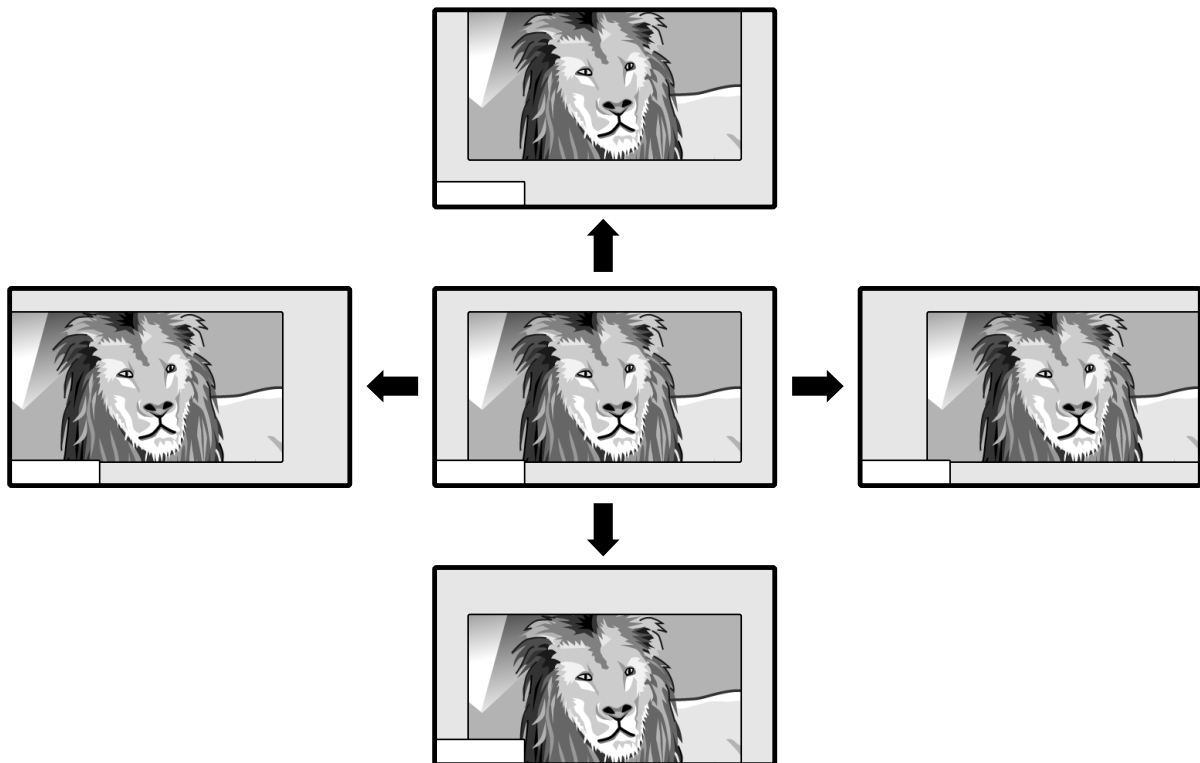

Useful adjustment settings

Auto Sync. adjustment (PC input mode only)

For automatically adjusting the PC image.

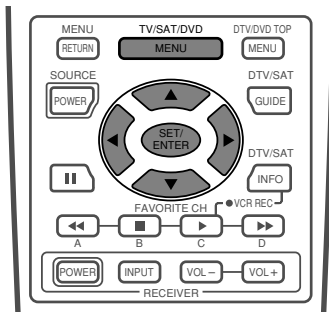

1 Press **MENU** and the PC MENU screen displays.

2 Press **◀/▶** to select "Setup".
• Setup menu displays.

3 Press **▲/▼** to select "Auto Sync.", and then press **SET/ENTER**.

4 Press **◀/▶** to select "Yes", and then press **SET/ENTER**.
• Auto Sync. starts and "Adjusting the image" displays.

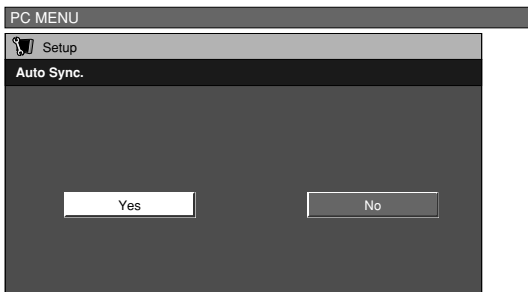

NOTE

- When Auto Sync. is successful, "Auto Sync completed successfully" displays. If not, Auto Sync. failed.
- Auto Sync. may fail even if "Auto Sync completed successfully" displays.
- Auto Sync. may fail with a PC image composed of similar patterns or monochrome. If not successful, change the PC image and try again.
- Be sure to connect the PC to the AVC System and switch it on before starting Auto Sync.

Fine Sync. adjustment (PC input mode only)

Ordinarily you can easily adjust the picture as necessary to change image position using Auto Sync. In some cases, however, manual adjustment is needed to optimize the image.

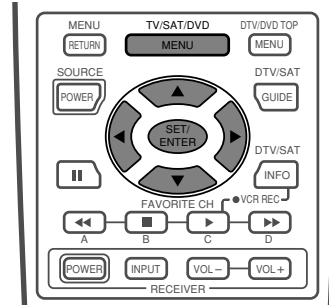

1 Press **MENU** and the PC MENU screen displays.

2 Press **◀/▶** to select "Setup".
• Setup menu displays.

3 Press **▲/▼** to select "Fine Sync.", and then press **SET/ENTER**.

4 Press **▲/▼** to select the specific adjustment item.

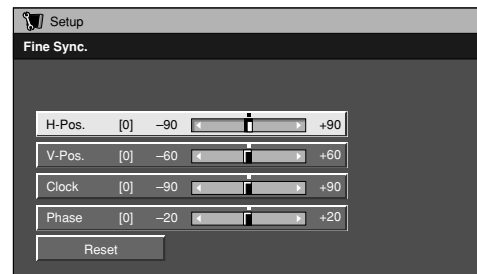

5 Press **◀/▶** to adjust the item to your desired position.

NOTE

- For resetting all adjustment items to the factory preset values, press **▲/▼** to select "Reset", and then press **SET/ENTER**.

Selected item	Description
H-Pos.	Centers the image by moving it to the left or right.
V-Pos.	Centers the image by moving it up or down.
Clock	Adjusts the clock frequency.
Phase	Adjusts the clock phase.

Useful adjustment settings

Input signal source

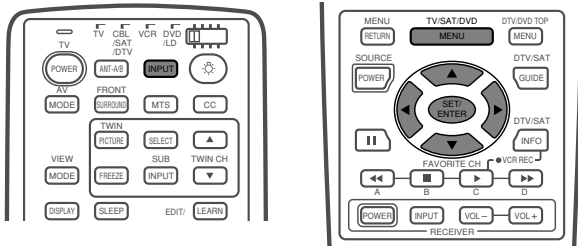

Input selection

Can use for selecting the input source.

- 1 Press **INPUT** on the remote control unit or on the Display.
- 2 Press **INPUT** on the remote control unit or on the Display to select the input source.
 - An image from the selected source automatically displays.
 - You can also select the input source by pressing **▲/▼**.

NOTE

- Some items may be grayed out. They are not selectable.

Input signal setting

For setting the signal type of external equipment connected to INPUT 1 or 3 terminals.

- 1 Press **MENU** and the TV MENU screen displays.
- 2 Press **◀/▶** to select "Option".
 - Option menu displays.
- 3 Press **▲/▼** to select "Input Select", and then press **SET/ENTER**.
- 4 Press **▲/▼** to select a signal type you want to set, and then press **SET/ENTER**.
 - If the selected signal type is incorrect, an image does not display or no color image displays.

NOTE

- The System automatically sets input signals from "INPUT2", "INPUT4" and "PC".
- **If no (color) image displays, try to change the signal type.**
- Check the operation manual of the external equipment for the signal type.
- Setting INPUT 1 and INPUT 3 signal selection to "Auto" when other equipment is connected will result in the following connectivity priority.

INPUT 1	INPUT 3
1. COMPONENT VIDEO	1. COMPONENT VIDEO
2. S-VIDEO	2. S-VIDEO
3. VIDEO	3. VIDEO
	4. DVI

DVI input signal setting

Selecting the image resolution of the DVI-DIGITAL input signal.

The DVI-DIGITAL terminal of this System supports the HDCP* standard.

- 1 Press **INPUT** on the remote control unit or on the Display and select "INPUT3", as explained in **Input selection**.
- 2 Select "Auto" or "DVI" from the "Input Select" menu for INPUT 3 signals, as explained in **Input signal setting**.
- 3 Press **MENU** and TV MENU screen displays.
- 4 Press **◀/▶** to select "Setup".
- 5 Press **▲/▼** to select "Input Signal", and then press **SET/ENTER**.

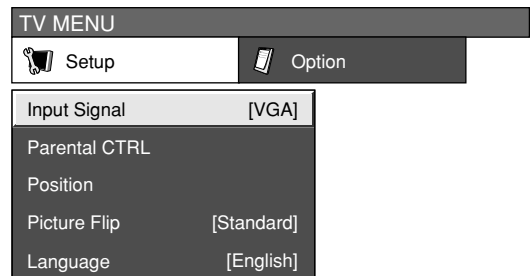

- 6 Press **◀/▶** to select a signal type you want to set, and then press **SET/ENTER**.

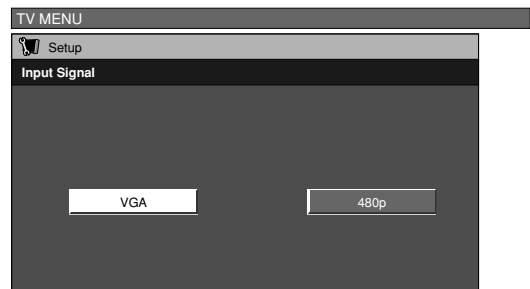

NOTE

- * What is HDCP (High-Bandwidth Digital Content Protection)?
 - HDCP is a copyright protection technology that uses TMDS (Transmission Minimized Differential Signal).
 - HDCP was developed to prevent the illegal copying of DVI signals.

Useful adjustment settings

Picture flip

You can set the orientation of the picture.

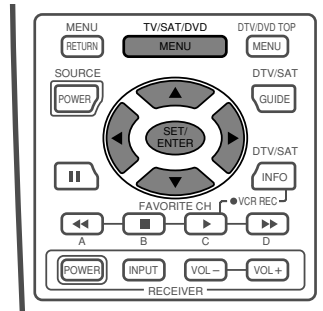

AV input mode

1 Press **MENU** and the TV MENU screen displays.

2 Press ◀/▶ to select "Setup".

3 Press ▲/▼ to select "Picture Flip", and then press **SET/ENTER**.

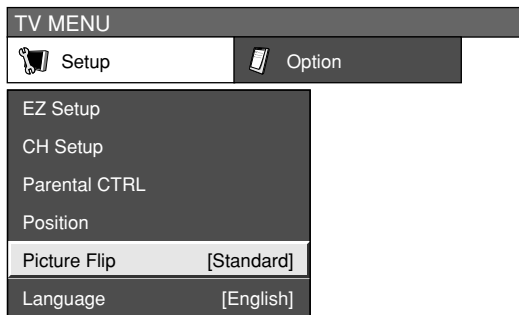

4 Press ▲/▼ to select the desired mode, and then press **SET/ENTER**.

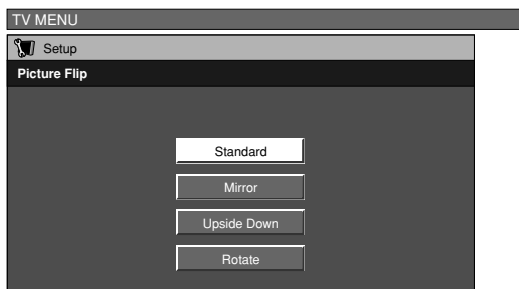

PC input mode

1 Press **MENU** and the PC MENU screen displays.

2 Press ◀/▶ to select "Setup".

3 Press ▲/▼ to select "Picture Flip", and then press **SET/ENTER**.

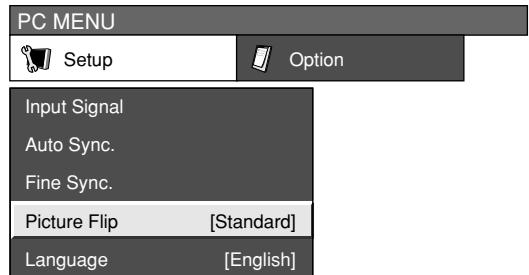

4 Press ▲/▼ to select the desired mode, and then press **SET/ENTER**.

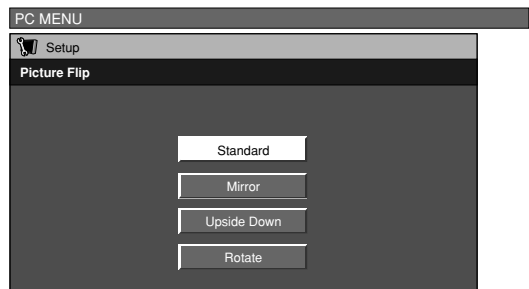

[Standard]: normal image.

[Mirror]: mirror image.

[Upside Down]: upside down image.

[Rotate]: rotated image.

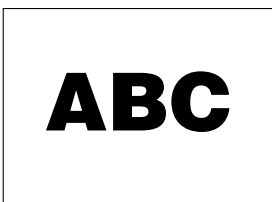

NOTE

- If you choose "Mirror" or "Rotate", the sound orientation also changes.

Useful adjustment settings

AV MODE

AV MODE gives you five viewing options to choose from to best match environment of the System, which can vary due to factors like room brightness, type of program watched or the type of image input from external equipment.

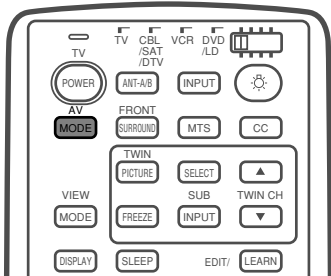

1

Press **AV MODE**.

- Present AV MODE displays.

2

Press **AV MODE** again before the mode displayed on the screen disappears.

- The mode changes as shown below.

Mode selection for the INPUT 1 to 4 terminals (Example)

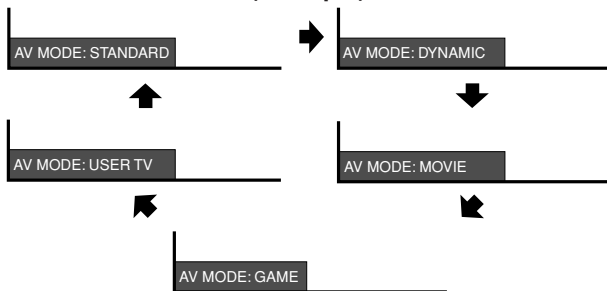

Mode selection for the PC terminal (Example)



Selected item	Description
STANDARD	For a highly defined image in a normally bright room
DYNAMIC	For a clear-cut image emphasizing high contrast for sports viewing
MOVIE	For a movie
GAME	Lowers image brightness for easier viewing
USER	Allows the user to customize settings as desired. You can set the mode for each input source.

View modes for 4:3 Programs

1

Press **VIEW MODE**.

- The View mode menu displays.
- The menu lists the view mode options selectable for the type of video signal currently received.

2

Press **VIEW MODE** or ▲/▼ while the View mode menu is still on the screen.

- You can sequentially select a view mode that has its own aspect ratio.

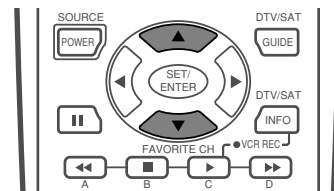
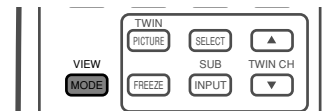

View Mode

Side Bar

S. Stretch
Zoom
Stretch

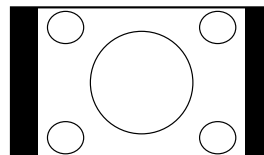

Side Bar: Suitable for viewing conventional 4:3 programs in their normal format.

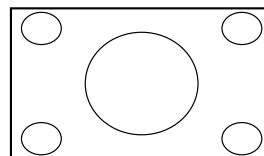

S.Stretch (Smart stretch): Suitable for stretching 4:3 programs to fill the screen.

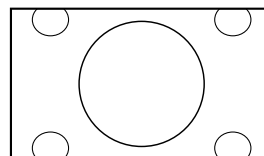

Zoom: Suitable for viewing wide-screen 2.35:1 anamorphic DVDs in full screen.

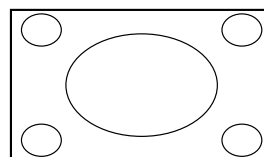

Stretch: This mode is useful for 1.78:1 DVDs. When viewing 1.85:1 DVDs, stretch mode will still show very thin black bands at the top and bottom of the screen.

Useful adjustment settings

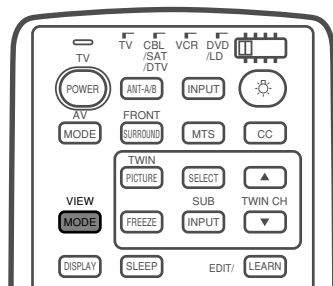

EXAMPLE

**Input signal
(640 × 480)**

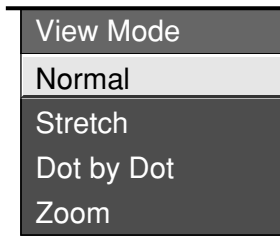

**Input signal
(1024 × 768)**

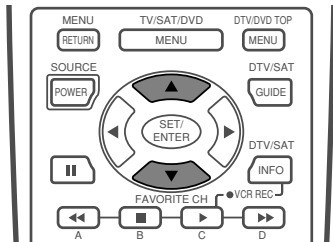
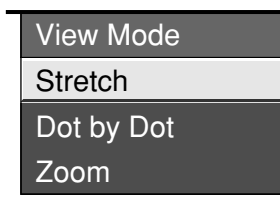

View mode (for PC input mode)

You can select the screen size.

NOTE

- Connect the PC before making adjustments. (See page 46.)
- Selectable screen size may vary with input signal type.

1

Press **VIEW MODE**.

- The View mode menu displays.

2

Press **VIEW MODE** or **▲/▼** to select a desired item on the menu.

EXAMPLE

Screen size images.

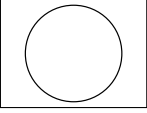
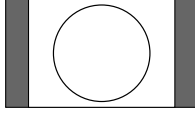
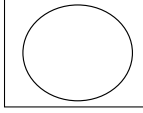
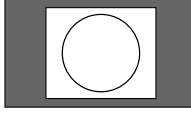
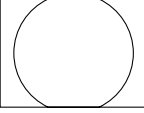
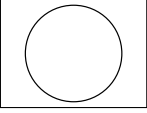
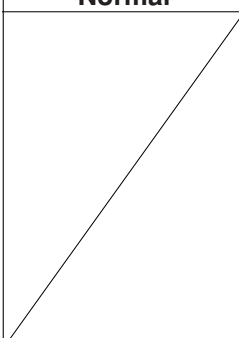
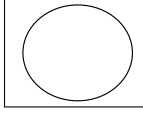
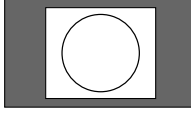
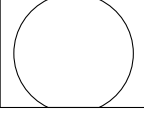
Input signal	Normal	Stretch	Dot by Dot	Zoom
<p>Input signal</p>  <p>640 × 480</p>	 <p>Keeps the original aspect ratio in a full screen display.</p>	 <p>An image fully fills the screen.</p>	 <p>Detects the resolution of the signal and displays an image with the same number of pixels on the screen.</p>	 <p>Keeps the original aspect ratio in a full screen display. The top and bottom of the image is slightly cropped.</p>
<p>Input signal</p>  <p>1024 × 768</p>		 <p>An image fully fills the screen.</p>	 <p>Detects the resolution of the signal and displays an image with the same number of pixels on the screen.</p>	 <p>Keeps the original aspect ratio in a full screen display. The top and bottom of the image is slightly cropped.</p>

Useful adjustment settings

Input signal (for PC input mode)

- Some input signals may have to be registered manually to display properly.
- The pairs of input signals (resolutions) in the list below are not distinguishable when received. In such case, you have to set the correct signal manually. After setting once, it will display when the same signal (resolution) is input again.

640 × 400	720 × 400
640 × 480	848 × 480
1024 × 768	1280 × 768

NOTE

- You can only select the "Input Signal" on the Setup menu when receiving one of the 6 input signals listed above.

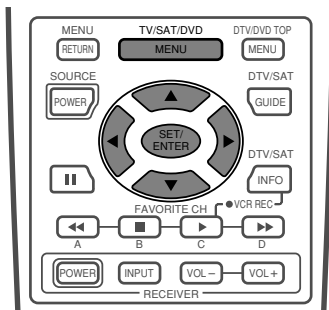

1 Press **MENU** and the PC MENU screen displays.

2 Press **◀▶** to select "Setup".

3 Press **▲▼** to select "Input Signal" and then press **SET/ENTER**.

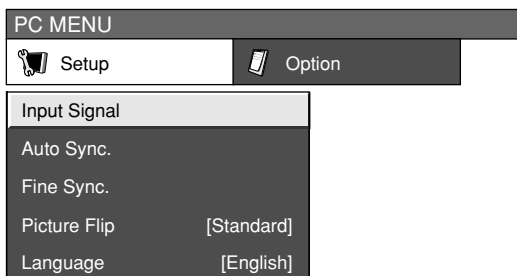

4 Press **▲▼** to select the desired input signal on the display.

Example

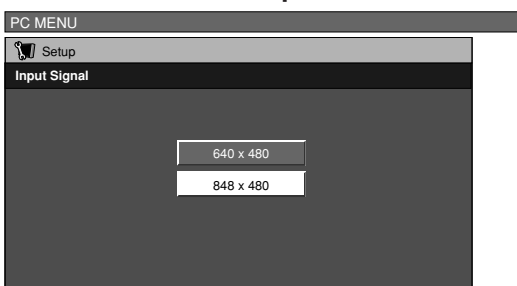

Noise clean

Produces a clearer video image.

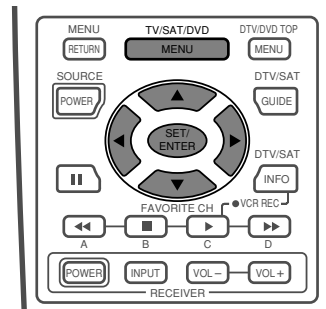

1 Press **MENU** and the TV MENU screen displays.

2 Press **◀▶** to select "Option".

3 Press **▲▼** to select "Noise Clean", and then press **SET/ENTER**.

- Some items may be grayed out. They are not selectable.

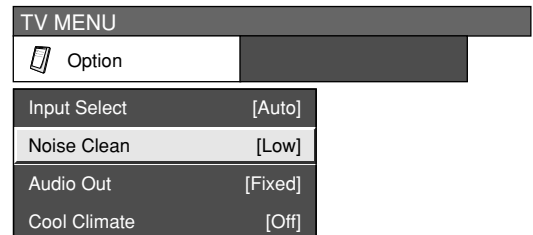

4 Press **▲▼** to select the desired level, and then press **SET/ENTER**.



NOTE

- "Noise Clean" is not selectable when channel display shows an input resolution of 480P, 720P or 1080i.

Useful adjustment settings

Sleep timer

Allows you to set a time when the TV automatically switches to standby.

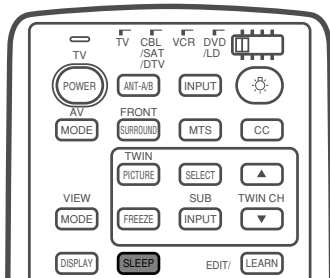

1

Press **SLEEP**.

- Remaining time displays when sleep timer has been set.

Sleep Timer: Remaining 30

2

Each time you press **SLEEP**, the remaining time switches as shown below.

- When set, the time automatically starts counting down.
- If you want to adjust the sleep timer, you can press **SLEEP** twice then change the time setting.
- Five minutes before time expires, the remaining time displays each minute.

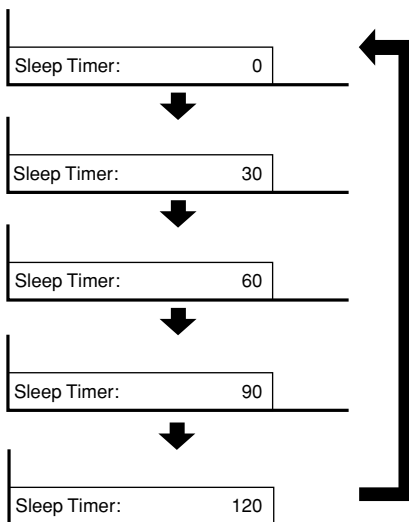

NOTE

- Select "0" by pressing **SLEEP** to cancel the sleep timer.

Audio out

Allows you to select what controls the audio output.

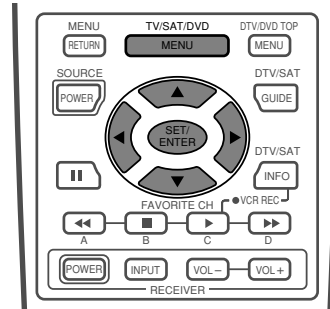

1

Press **MENU** and the TV MENU (PC MENU) screen displays.

2

Press **◀/▶** to select "Option".

3

Press **▲/▼** to select "Audio Out", and then press **SET/ENTER**.

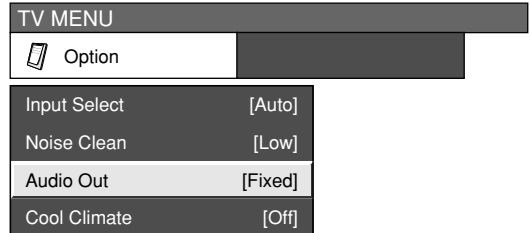

(On-screen display for AV input mode.)

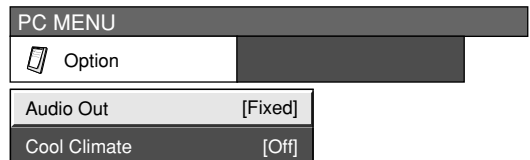

(On-screen display for PC input mode.)

4

Press **◀/▶** to select "Fixed" or "Variable", and then press **SET/ENTER**.



(On-screen display for AV input mode.)

Selected item	Description
Fixed	<ul style="list-style-type: none"> • Sound via optional speakers is adjusted with VOL +/- on the remote control unit or VOL -/+ on the Display. • Sound via the MONITOR OUTPUT terminal is not adjustable and constantly outputs.
Variable	<ul style="list-style-type: none"> • Sound via the MONITOR OUTPUT terminal is adjusted with VOL +/- on the remote control unit or VOL -/+ on the Display. • Sound via optional speakers is muted.

Connecting external speakers

Rear view

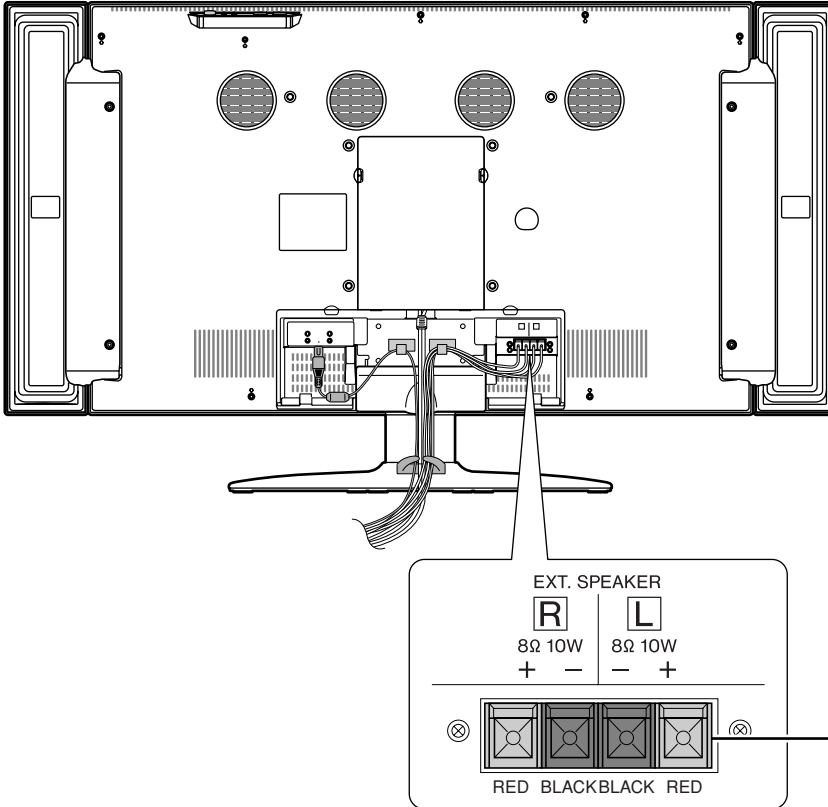

How to connect the speaker cable

- 1 Pull up the lid.
- 2 Insert the edge of the cable.
- 3 Put the lid back down.

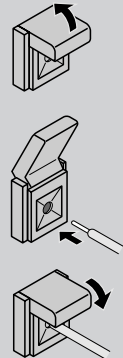

- Bundle the cables of the external speakers with clamps as shown above.

When using external speakers

- Change the speaker setting to external speakers. (See page 57.)

Make sure to connect the speaker jack and cable polarity (+, -) properly

- The speaker jacks have plus (+) and minus (-) polarity.
- Plus is red and minus is black.
- The cables are also divided into plus and minus.
- When connecting the left/right speakers, be sure to connect the plus/minus jacks with the correct cables.

NOTE

- See page 11 for bundling the cables of the external speakers.
- Unplug the AC cord from the AC outlet before installing the speakers.

CAUTION

- Make sure external speakers have 8 ohm and 10 watt specifications.
- Connect the plus/minus jacks with the correct cables. Incorrect connection may cause a short.

Useful adjustment settings

Selecting speakers

You can output audio using the supplied speakers (internal) or other external speakers.

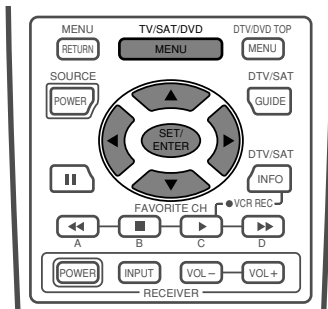

1 Press **MENU** and the TV MENU screen displays.

2 Press **◀/▶** to select “Audio”.

3 Press **▲/▼** to select “Speaker”, and then press **SET/ENTER**.

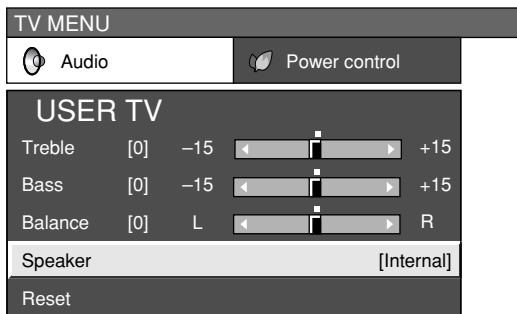

4 Press **◀/▶** to select “External” or “Internal”, and then press **SET/ENTER**.



Useful adjustment settings

Cool climate

Improves the response of Liquid Crystal Panel when viewing fast-moving images. The effect is greater at low room temperatures (at or below 59°F/15°C).

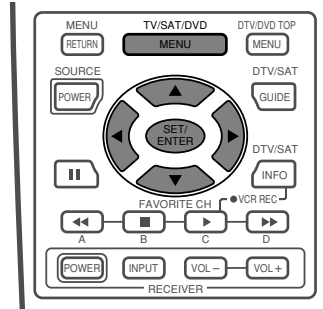

AV input mode

1 Press **MENU** and the TV MENU screen displays.

2 Press ◀/▶ to select "Option".

3 Press ▲/▼ to select "Cool Climate", and then press **SET/ENTER**.

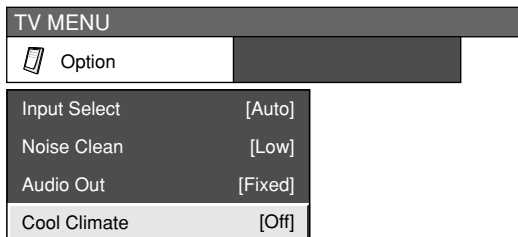

4 Press ◀/▶ to select "On", and then press **SET/ENTER**.

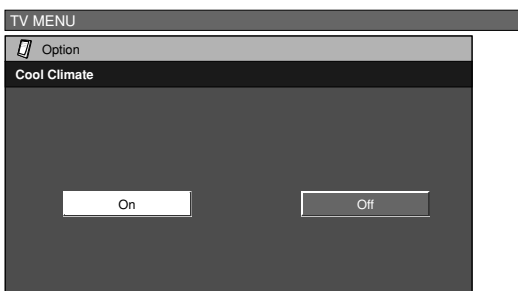

NOTE

- Cool climate may cause image noise. If this occurs turn the function "Off".

PC input mode

1 Press **MENU** and the PC MENU screen displays.

2 Press ◀/▶ to select "Option".

3 Press ▲/▼ to select "Cool Climate", and then press **SET/ENTER**.

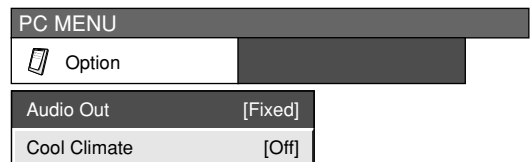

4 Press ◀/▶ to select "On", and then press **SET/ENTER**.

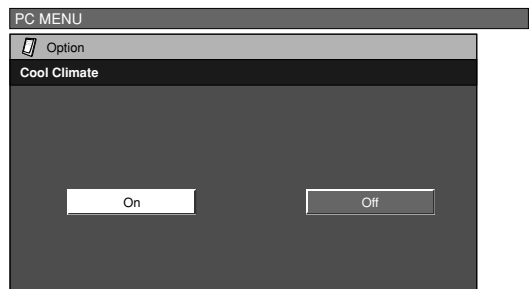

NOTE

- Cool climate may cause image noise. If this occurs turn the function "Off".

Useful adjustment settings

Closed caption

- Your System is equipped with an internal closed caption decoder. Closed caption is the System which allows you to view conversations, narration, and sound effects in TV programs and home videos as subtitles on your Display.
- Not all programs and videos offer closed caption. Please look for the “**CC**” symbol to ensure that captions will be shown.
- “CC1” or “CC2” displays subtitles of TV dramas and news programs while allowing a full view of the picture.
- “T1” or “T2” superimposes on the picture other information (e.g. TV guide, weather) that is independent of the TV in progress.

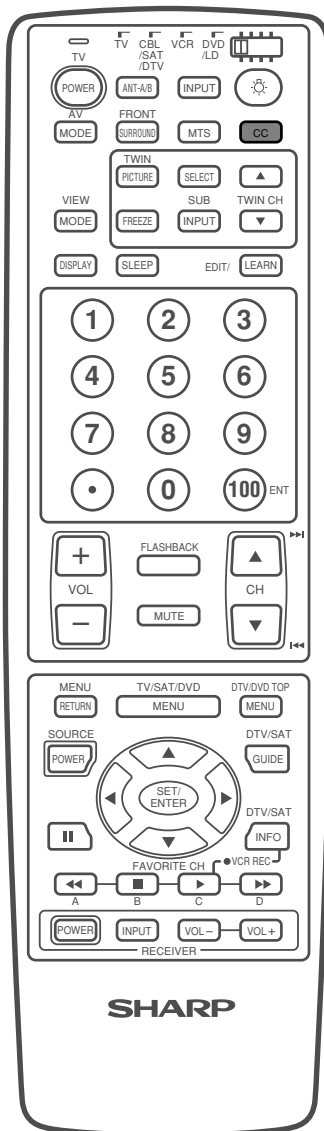

Each time you press **CC**, the closed caption toggles as shown below.

NOTE

- When using Twin Picture (see page 67) and Still Image (see page 67) functions, the right screen cannot display closed caption data.

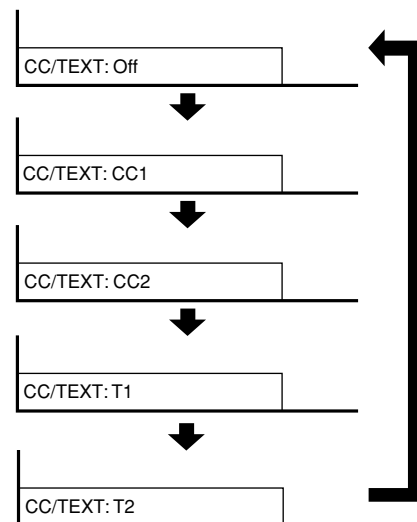

Useful adjustment settings

Secret number setting for parental control (AV input mode only)

Allows you to use a secret number to protect certain settings from being accidentally changed.

IMPORTANT:

Three conditions must be met to enable V-Chip (see pages 62 to 66):

- ① Secret No. is registered.
- ② V-Chip settings have been made.
- ③ "Status" is set to "On".

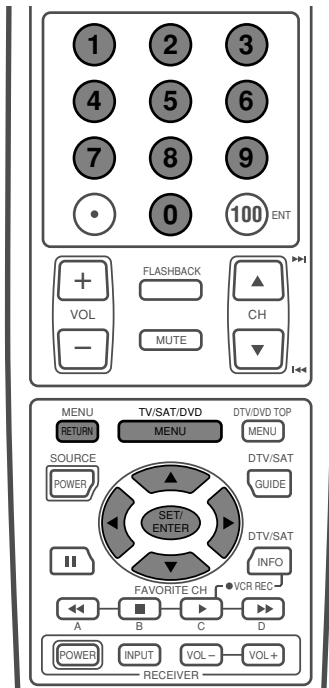

Setting a secret number

- 1 Press **MENU** and TV MENU screen displays.
- 2 Press **◀/▶** to select "Setup".
 - Setup menu displays.
- 3 Press **▲/▼** to select "Parental CTRL", and then press **SET/ENTER**.
- 4 Press **▲/▼** to select "Secret No.", and then press **SET/ENTER**.

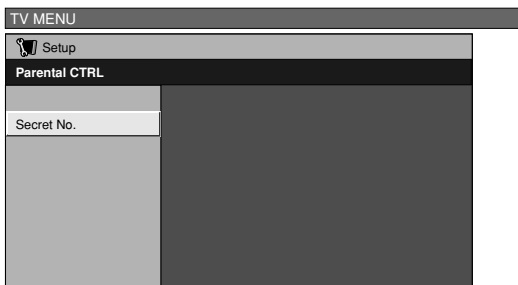

5

Select "New Secret No.", and then press **SET/ENTER**.

Input the new 4-digit secret number by using **0 – 9**.

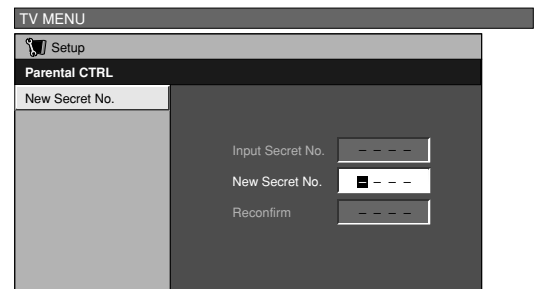

6

Input the same 4-digit number on the "Reconfirm" screen as in step 5 to confirm.

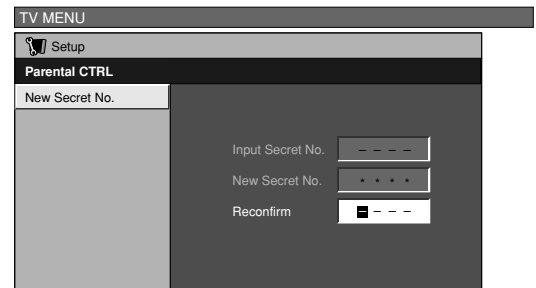

7

Press **MENU/RETURN** to start configuring V-Chip settings. (See pages 63 and 65 for details.)

Setting parental control status

Used to enable or disable the parental control function.

1

Repeat steps 1 to 3 in **Setting a secret number**.

- Secret number setting menu displays.

2

Input the 4-digit secret number by using **0 – 9**.

3

Press **▲/▼** to select "Status", and then press **SET/ENTER**.

4

Press **◀/▶** to select "On" or "Off", and then press **SET/ENTER**.

- Select "On" to enable and "Off" to disable Parental CTRL.



NOTE

- You can skip step 1 and 2 above while in parental CTRL screen.

Useful adjustment settings

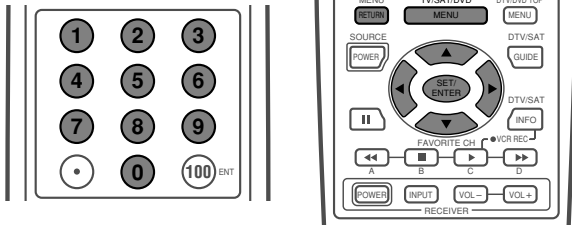

Changing the secret number

Allows you to change your current secret number.

- 1 Repeat steps 1 to 3 in **Setting a secret number**.
 - Secret number setting menu displays.
- 2 Input the 4-digit secret number by using **0 – 9**.
- 3 Press **▲/▼** to select “Secret No.”, and then press **SET/ENTER**.
- 4 Press **▲/▼** to select “New Secret No.”, and then press **SET/ENTER**.
- 5 Input the old 4-digit number you have set using **0 – 9**.

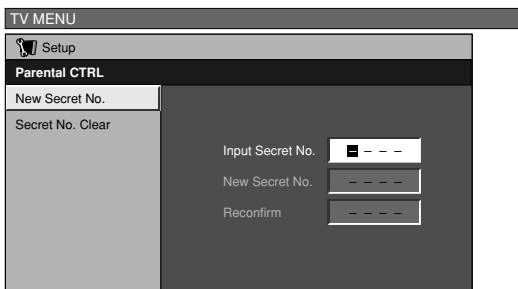

- 6 Input the new 4-digit number using **0 – 9**.

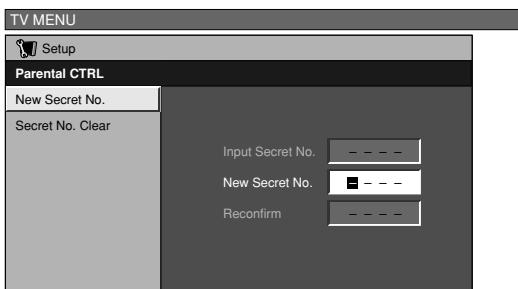

- 7 Input the same 4-digit number on the “Reconfirm” screen as in step 6 to confirm.

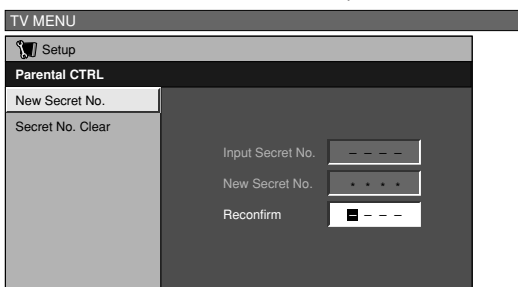

Clearing the secret number

Allows you to clear your secret number.

- 1 Repeat steps 1 to 3 in **Setting a Secret Number**.
 - Secret number setting menu displays.
- 2 Input the 4-digit secret number by using **0 – 9**.
- 3 Press **▲/▼** to select “Secret No.”, and then press **SET/ENTER**.
- 4 Press **▲/▼** to select “Secret No. Clear”, and then press **SET/ENTER**.
- 5 Press **◀/▶** to select “Yes”, and then press **SET/ENTER**.
 - Your secret number is cleared.

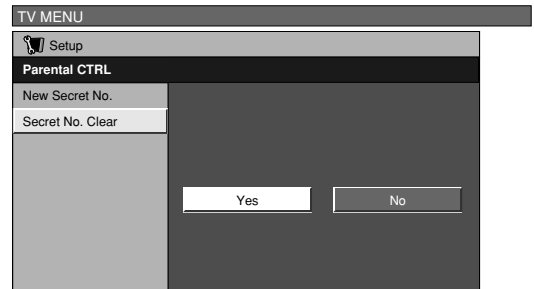

NOTE

- See page 60 for re-registering with a new secret number after being cleared.
- **As a precautionary measure, make a note of your secret number and keep it in a familiar place. If you lose or forget your secret number, initialize the Liquid Crystal Television to return all settings except for the TV channel settings to factory preset values. (See page 83.)**
- If the secret number is cleared the Status setting automatically sets to “Off”. “V-Chip” and “Status” will not be selectable from the menu.

Useful adjustment settings

Parental control (setting V-CHIP level)

V-CHIP is an electronic filtering device built into your System. This tool gives parents a great degree of control over broadcasts accessed by their children. It allows parents to select programs judged suitable for child viewing while blocking ones judged not suitable. It does so automatically once you activate the V-CHIP feature in your Liquid Crystal Television.

“V-Chip” and “Status” will not be selectable from the menu if you do not first configure your secret number. (See page 60 for Secret number setting for parental control.)

- The U.S. has two rating systems for viewing content: TV Parental Guidelines and movie ratings.
- The TV Parental Guidelines work in conjunction with the V-CHIP to help parents screen out inappropriate television shows from their children.
- Movie ratings are used for original movies rated by the Motion Picture Association of America (MPAA) as watched on cable TV and not edited for television. The V-CHIP can also be set to block MPAA-rated movies.

Voluntary movie rating system (MPAA)

Rating		Description
Age	G	General audiences. All ages admitted.
	PG	Parental guidance suggested. Some material may not be suitable for children.
	PG-13	Parents strongly cautioned. Some material may be inappropriate for children under 13.
	R	Restricted. Under 17 requires accompanying parent or adult guardian (age varies in some jurisdictions).
	NC-17	No one 17 and under admitted.
	X	A rating that has now been superseded by NC-17.

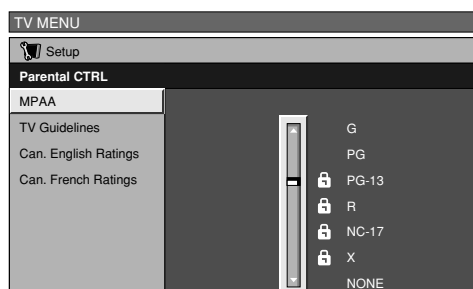

EXAMPLE

- If you select “PG-13”, this will automatically block the higher ratings “R”, “NC-17” and “X”.

NOTE

- Voluntary movie rating system only uses an age-based rating.

TV Parental Guidelines

Rating		Content				
		FV (Fantasy violence)	V (Violence)	S (Sexual situation)	L (Adult language)	D (Sexually suggestive dialog)
Suggested age	TV-Y (All children)					
	TV-Y7 (Directed to older children)	X				
	TV-G (General audience)					
	TV-PG (Parental Guidance suggested)		X	X	X	X
	TV-14 (Parents strongly cautioned)		X	X	X	X
	TV-MA (Mature audience only)		X	X	X	

X: Content rating can be set.

Useful adjustment settings

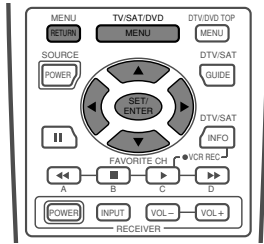
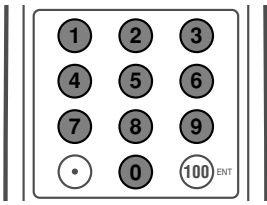

Voluntary movie rating system (MPAA)

1 Press **MENU** and the TV MENU screen displays.

2 Press **◀/▶** to select "Setup".

- Setup menu displays.

3 Press **▲/▼** to select "Parental CTRL", and then press **SET/ENTER**.

- Secret number setting menu displays only when "Secret No." is set. (See page 60.)
- "V-Chip" and "Status" will not be selectable from the menu if you do not first configure your secret number. (See page 60.)

4 Input the 4-digit secret number by using **0 – 9**.

5 Press **▲/▼** to select "V-Chip", and then press **SET/ENTER**.

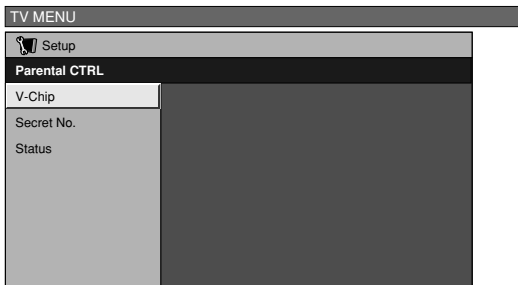

6 Press **▲/▼** to select "MPAA", and then press **SET/ENTER**.

7 Press **▲/▼** to adjust the item to your desired position. "🔒" indicates the item is blocked. Press **MENU/RETURN**.

- The setting automatically enters "Block" for any ratings below your selection.
- If Status is not set to "On" the configuration settings will not work. (See page 60.)

Example

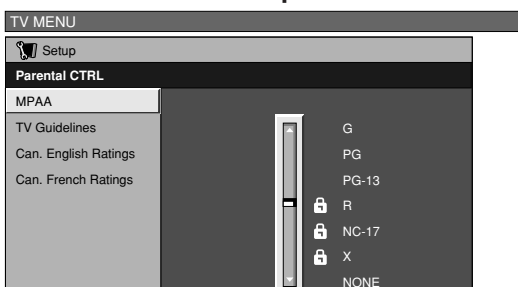

TV Parental Guidelines (TV Guidelines)

1 Repeat steps 1 to 5 in **Voluntary movie rating system (MPAA)**.

2 Press **▲/▼** to select "TV Guidelines", and then press **SET/ENTER**.

3 Press **▲/▼** to adjust the item to your desired position. "🔒" indicates the item is blocked.

- The setting automatically enters "Block" for any ratings below your selection.

Example

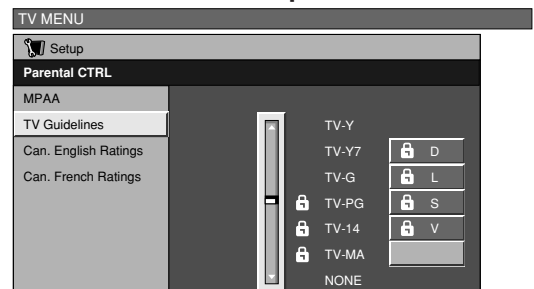

When setting an individual content-based rating item, do as follows:

- ① Press **▶** to access block content items from the currently selected age-based rating item.
- ② Press **▲/▼** to select an individual item, and then press **SET/ENTER** to unblock ("🔒" is removed). Repeat the same steps for other items.
- ③ Press **◀** or **MENU/RETURN** to register after all individual content rating items are set.

Example

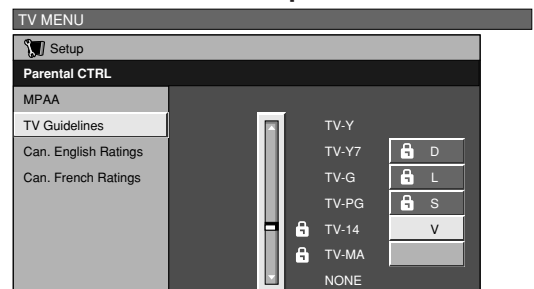

- If Status is not set to "On" the configuration settings will not work. (See page 60.)

Useful adjustment settings

Canadian Rating Systems

- The TV rating systems in Canada are based on the Canadian Radio-Television and Telecommunications Commission (CRTC) policy on violence in television programming.
- While violence is the most important content element to be rated, the structure developed takes into consideration other program content like language, nudity, sexuality and mature themes.
- When setting the V-CHIP on the Canadian system you can choose either the Canadian English ratings or the Canadian French ratings.

Canadian English ratings

Rating		Description
Age	E	Exempt: Includes news, sports, documentaries and other information programming; talk shows, music videos, and variety programming.
	C	Children: Intended for younger children under the age of 8 years. Pays careful attention to themes that could threaten their sense of security and well-being.
	C8+	Children over 8 years old: Contains no portrayal of violence as the preferred, acceptable, or only way to resolve conflict; nor encourage children to imitate dangerous acts which they may see on the screen.
	G	General: Considered acceptable for all age groups. Appropriate viewing for the entire family, contains very little violence, physical, verbal or emotional.
	PG	Parental Guidance: Intended for a general audience, but may not be suitable for younger children (under the age of 8) because it could contain controversial themes or issues.
	14+	Over 14 Years: Could contain themes where violence is one of the dominant elements of the storyline, but it must be integral to the development of plot or character. Language usage could be profane and nudity present within the context of the theme.
	18+	Adults: Intended for viewers 18 years and older and might contain depictions of violence, which while related to the development of plot, character or themes, are intended for adult viewing. Could contain graphic language and portrayals of sex and nudity.

Canadian French ratings

Rating		Description
Age	E	Exempt programming.
	G	General: All ages and children, contains minimal direct violence, but may be integrated into the plot in a humorous or unrealistic manner.
	8ans +	General but inadvisable for young children: May be viewed by a wide public audience, but could contain scenes disturbing to children under 8 who cannot distinguish between imaginary and real situations. Recommended for viewing with parent.
	13ans +	Over 13 years: Could contain scenes of frequent violent scenes and therefore recommended for viewing with parent.
	16ans +	Over 16 years: Could contain frequent violent scenes and intense violence.
	18ans +	Over 18 years: Only for adult viewing. Could contain frequent violent scenes and extreme violence.

Useful adjustment settings

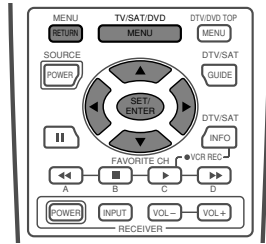
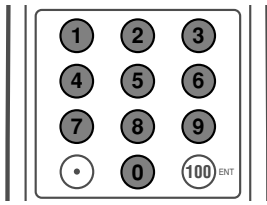

Canadian English ratings

1 Press **MENU** and the TV MENU screen displays.

2 Press **◀/▶** to select "Setup".

3 Press **▲/▼** to select "Parental CTRL", and then press **SET/ENTER**.

- Secret number setting menu displays only when "Secret No." is set. (See page 60.)
- "V-Chip" and "Status" will not be selectable from the menu if you do not first configure your secret number. (See page 60.)

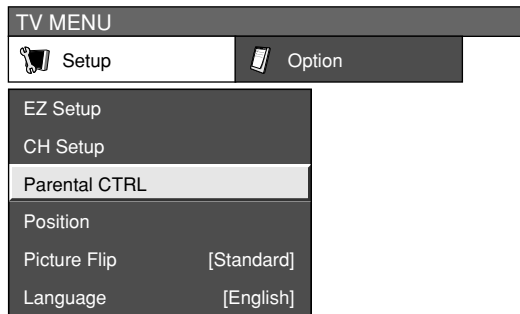

4 Input the 4-digit secret number by using **0 – 9**.

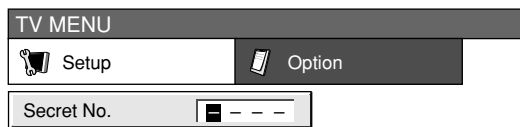

5 Press **▲/▼** to select "V-Chip", and then press **SET/ENTER**.



6 Press **▲/▼** to select "Can. English Ratings", and then press **SET/ENTER**.

7

Press **▲/▼** to adjust the item to your desired position. "🔒" indicates the item is blocked.

- The setting automatically enters "Block" for any ratings below your selection.
- If Status is not set to "On" the configuration settings will not work. (See page 60.)

Example

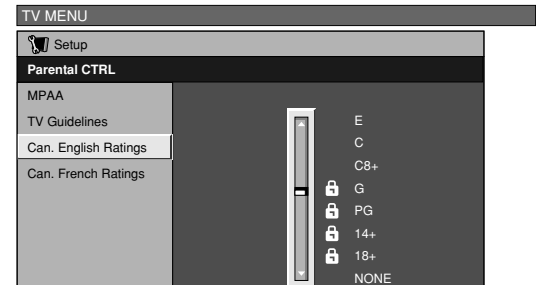

Canadian French ratings

1 Repeat steps 1 to 5 in **Canadian English ratings**.

2 Press **▲/▼** to select "Can. French Ratings", and then press **SET/ENTER**.

3 Press **▲/▼** to adjust the item to your desired position. "🔒" indicates the item is blocked.

- The setting automatically enters "Block" for any ratings below your selection.
- If Status is not set to "On" the configuration settings will not work. (See page 60.)

Example

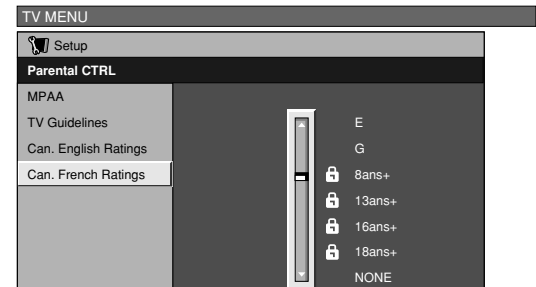

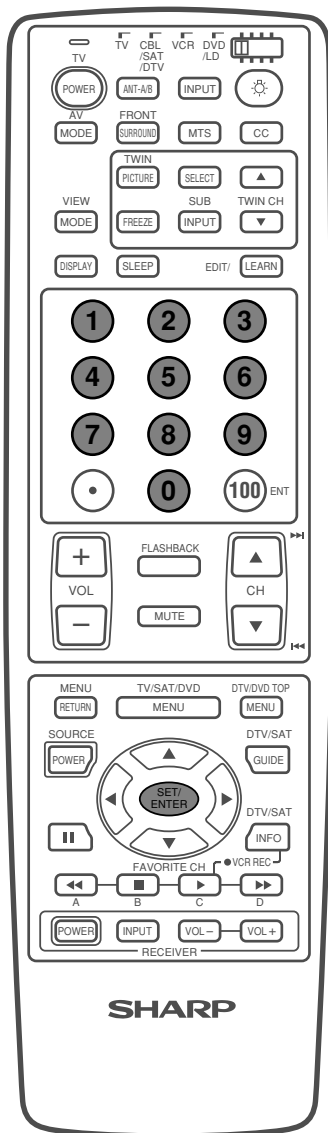

How to temporarily release the V-CHIP BLOCK

- The V-CHIP BLOCK is working and censors a broadcast, "V-CHIP HAS BEEN ACTIVATED." displays.

1

Press **SET/ENTER** while the V-CHIP is working and then the secret number setting menu displays.

2

Enter your 4-digit secret number with **0 – 9** and then press **SET/ENTER**. At this time V-CHIP BLOCK temporarily releases.

Reactivating the temporarily released V-CHIP BLOCK

- You can reactivate the temporarily released V-CHIP BLOCK as shown below.

Method 1:

Select "Status" setting from the Parental CTRL menu to reactivate BLOCK. See page 60.

Method 2:

Select "V-Chip" setting ("MPAA", "TV Guidelines", "Can. English Ratings" or "Can. French Ratings") from the Parental CTRL to reactivate BLOCK. See pages 63 and 65.

Method 3:

Switch off the AVC System power.

NOTE

- Performing any of the three above will activate the V-CHIP BLOCK.

Other viewing options

Twin picture functions

Allows you to display two pictures on the screen at one time.

Twin picture in all cases

You can display two same-sized pictures except when inputting from a PC INPUT terminal.



1

Press **TWIN PICTURE**.

- Twin picture displays and a selected input source image displays.



2

Press **SELECT** to set either screen to be active.

- “♪” displays on the active screen, which has sound output.

3

Press **TWIN CH** ▲/▼ to select another channel on the inactive screen.

4

Press **SUB INPUT** to select another input source on the inactive screen.

- A selected image displays.

5

Press **TWIN PICTURE** to exit twin picture.

NOTE

- This function does not work under the following input conditions:
 - ① PC INPUT mode,
 - ② Two pictures from the same source (e.g. INPUT 1 and INPUT 1),
 - ③ HDTV signal source is input on the right side screen display.
- When this function is not available, “No dual screen display available” will display.
- Pressing **ANT-A/B** while viewing in Twin Picture mode (TV image and video image) with TV selected will display the TV image of the other tuner.
- Pressing **ANT-A/B** while viewing Twin Picture with video selected will not change the image displayed.
- Pressing **ANT-A/B** while viewing Twin Picture with two TV images displayed will not have any effect.
- Pressing **ANT-A/B** while viewing Twin Picture with two video images displayed will switch the selected screen to a TV image.

Picture and still image

You can display two same-sized pictures – one moving and one still – when inputting from an AV source.

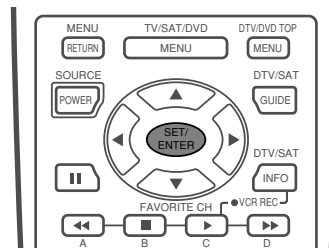
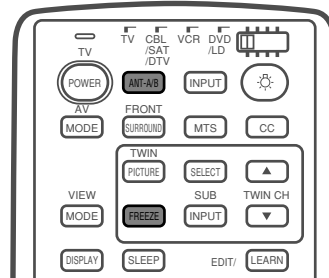

1

Press **FREEZE**.

- A moving image displays on the left screen and a still image displays on the right screen. The still image is one frame captured from a moving image at the moment you press **FREEZE**.

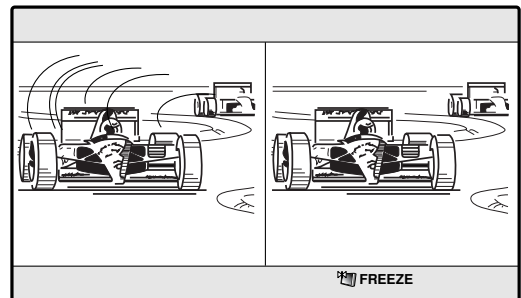

2

Update the still image by pressing **SET/ENTER**.

- Each time you press **SET/ENTER**, the image on the right screen updates.

3

Press **FREEZE** to exit still image.

NOTE

- This function does not work in PC input mode.
- When this function is not available, “No still image display available.” will display.
- The still image automatically goes out after 30 minutes.

Other viewing options

Learning remote control function

You can operate the connected AV products (AV Receiver, Cable Box, SAT tuner, DTV, VCR, DVD, LD) using the learning function for your remote control unit. This remote control unit has the function that can memorize each remote control code.



0.8 to 2.0 inch (2 to 5 cm)

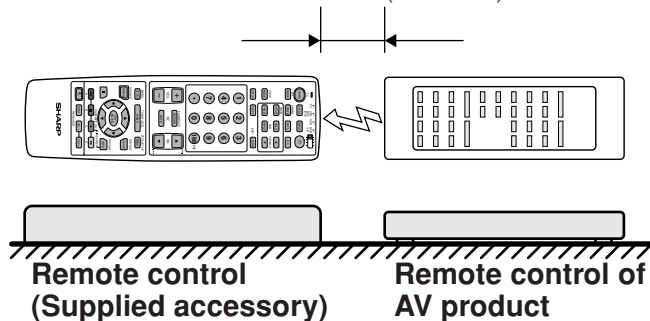

Presetting manufacturer codes

- 1 Slide the **Mode switch** to match the device to which you want to preset the remote control signal.
- 2 Press **EDIT/LEARN** and **1** at the same time.
 - LED flashes continuously.
- 3 Press **0 – 9** to enter the manufacturer code. (See page 69.)
 - Preset mode is finished once the LED no longer lights up.

NOTE

- To stop the EDIT mode in the middle, press **EDIT/LEARN** once more.
- If **Mode switch** is switched while in EDIT mode, EDIT mode will be canceled.
- If there is no operation for over 1 minute running, exit this mode.
- When you enter a code that is not listed, LED flashes quickly.
- If the table on page 69 does not include your desired manufacturer or the remote control does not work, you can make the memory learn its signal by the learn mode.
- The initial mode is "00".

Learning the remote control

- 1 Be sure to slide the **Mode switch** to match the device whose remote control signal you want to be learned.
- 2 Press **EDIT/LEARN** and **2** at the same time.
 - LED flashes continuously.
- 3 Press a button for you want to learn.
 - Refer to the assigning buttons to functions on each page.(See page 70 to 75.)
 - The LED changes from lit up to flashing state.
 - When the learn mode is finished, LED lights up once and returns to the learn mode (LED flashes continuously).
- 4 To exit learn mode, press **EDIT/LEARN**.

NOTE

- To stop the EDIT mode in the middle, press **EDIT/LEARN** once more.
- If **Mode switch** is switched while in EDIT mode, EDIT mode will be canceled.
- If there is no operation for over 1 minute running, exit this mode.
- If **TV POWER** is pressed over 2 seconds running (LED flashes continuously, step 2 above), the learning codes of the current **Mode switch** position clear, changing back to preset manufacturer codes. In this case, the LED turns off after 2 seconds exiting learning mode.

Other viewing options

Manufacturer codes

	CATV/SAT/ DTV	VCR	DVD/LD
00	PIONEER1 (CATV)	SHARP1	SHARP (DVD)
01	PIONEER2 (CATV)	SHARP2	PIONEER (DVD)
02	JERROLD1 (CATV)	SHARP3	PANASONIC (DVD)
03	JERROLD2(CATV)	PIONEER	SAMSUNG (DVD)
04	JERROLD3 (CATV)	FISHER	SONY (DVD)
05	JERROLD4 (CATV)	FISHER	TOSHIBA (DVD)
06	JERROLD5 (CATV)	FISHER	JVC (DVD)
07	JERROLD6 (CATV)	GOLDSTAR	
08	JERROLD7 (CATV)	HITACHI1	
09	JERROLD8 (CATV)	HITACHI2	
10	JERROLD9 (CATV)	HITACHI3	
11	JERROLD10 (CATV)	MAGNAVOX2	
12	S.A.1 (CATV)	MITSUBISHI1	
13	S.A.2 (CATV)	MITSUBISHI2	
14	S.A.3 (CATV)	MITSUBISHI3	
15	S.A.4 (CATV)	MITSUBISHI4	
16	ZENITH1 (CATV)	MITSUBISHI5	
17	ZENITH2 (CATV)	MITSUBISHI6	
18	ZENITH3 (CATV)	PANASONIC1	
19		PANASONIC2	
20	PIONEER (SAT)	PANASONIC3	PIONEER (LD)
21	RCA1 (SAT)	RCA1	KENWOOD (LD)
22	RCA2 (SAT)	RCA2	PANASONIC1 (LD)
23	SONY (SAT)	RCA3	PANASONIC2 (LD)

	CATV/SAT/ DTV	VCR	DVD/LD
24		SANYO1	PHILIPS (LD)
25		SANYO2	RCA (LD)
26		SANYO3	SONY (MDP)
27		SONY (BETA)	SONY (LD)
28		SONY (VHS)	
29		SONY (8 mm)	
30	PIONEER (DTV)	TOSHIBA	
31	SHARP (DTV)	JVC1	
32		JVC2	
33		JVC3	
34		JVC4	
35		JVC5	
36		ZENITH	

Other viewing options

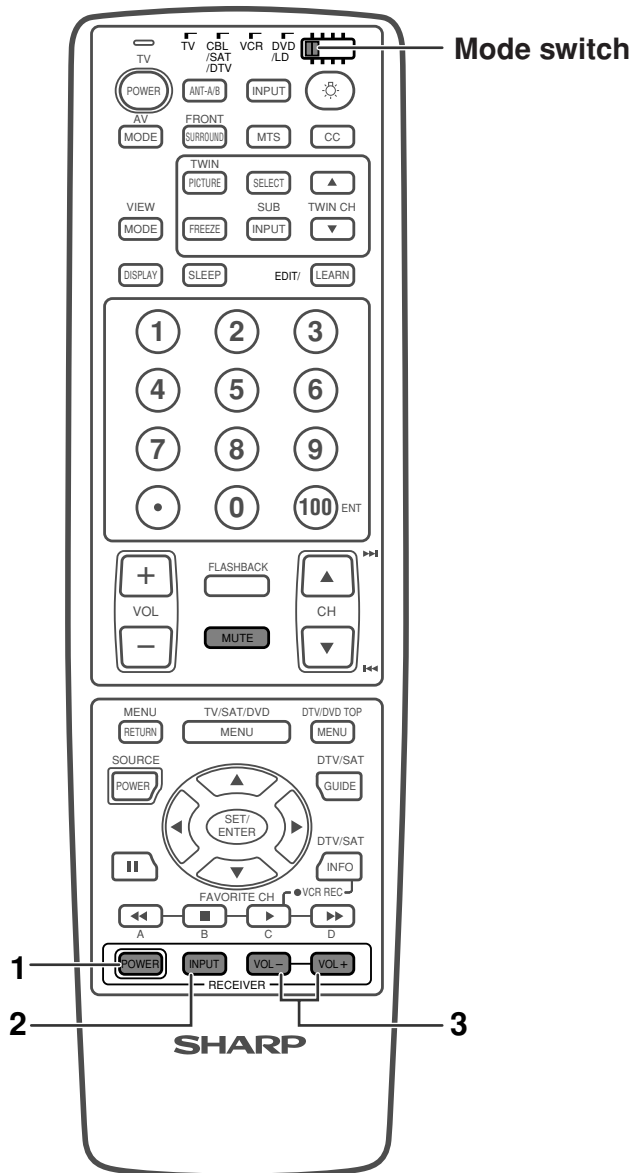

Using the TV remote control unit to control other devices

Receiver control buttons

When a SHARP receiver is connected to the Display, the receiver can operate using buttons **1** to **3**. When another non-SHARP receiver is connected to the display, the signals for **1** to **3** must first be learned before operating. (See page 68.)

- 1 RECEIVER POWER (STANDBY/ON)**
Turns receiver power on and off.
- 2 RECEIVER INPUT**
Selects the input source connected to the receiver.
- 3 RECEIVER VOL +/-**
Adjusts receiver volume level. Press **RECEIVER VOL +** to increase the volume and **RECEIVER VOL -** to decrease it.

NOTE

- **(RECEIVER) MUTE**
Allows remote unit to learn receiver's mute signal. Use this button when the mode switch is set to something other than TV.
- The color-highlighted buttons on the remote control can learn the control signal from another device's remote control.

Other viewing options

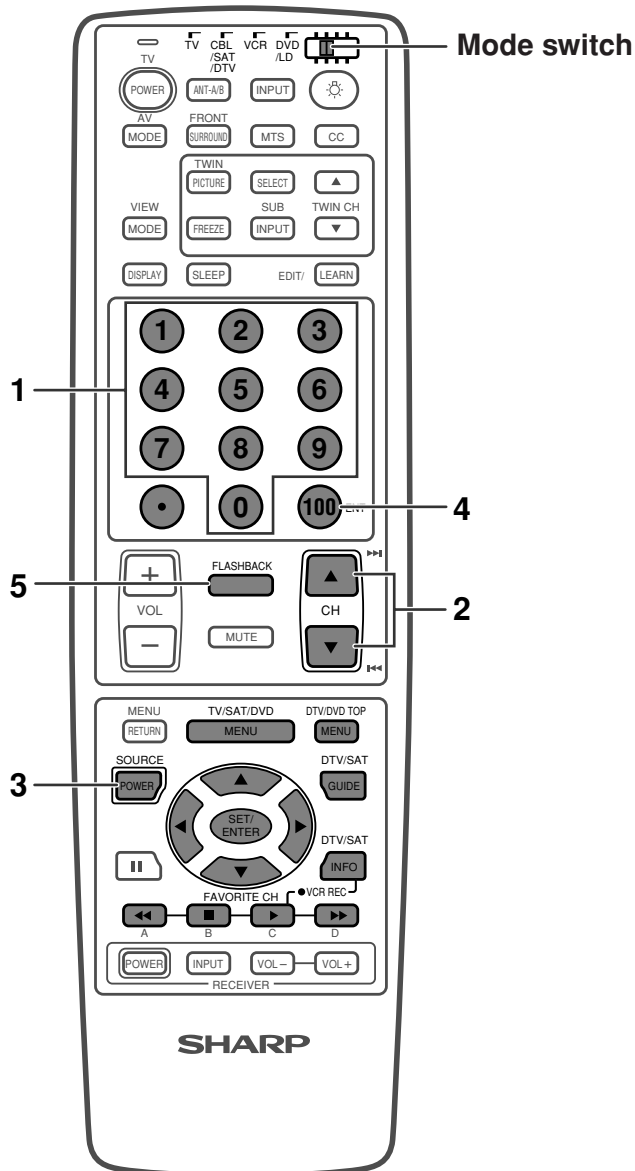

Cable control buttons

When the **Mode switch** is set to CBL/SAT/DTV the cable converter connected to the Display can operate using **1 to 5**.

Cable converters made by other manufacturers and not preset can also operate using the remote control unit if **1 to 5** have learned the functions. (See page 68.)

- 1 0 - 9**
Press a button (or buttons) that corresponds to the channel that you wish to watch.
- 2 CH ▲/▼**
Press **CH ▲** or **CH ▼** to tune in a higher or lower channel.
- 3 SOURCE POWER**
Turns the cable converter power on and off.
- 4 100 ENT ***
Fix the selected channel with the direct channel selection buttons.
- 5 FLASHBACK ***
Press to switch between the current channel and the channel you were watching immediately before.

* Some manufacturers do not preset **100 ENT** and **FLASHBACK**. Use these buttons to learn if necessary.

NOTE

- CABLE, SAT and DTV cannot be selected at the same time.
- The color-highlighted buttons on the remote control can learn the control signal from another device's remote control.

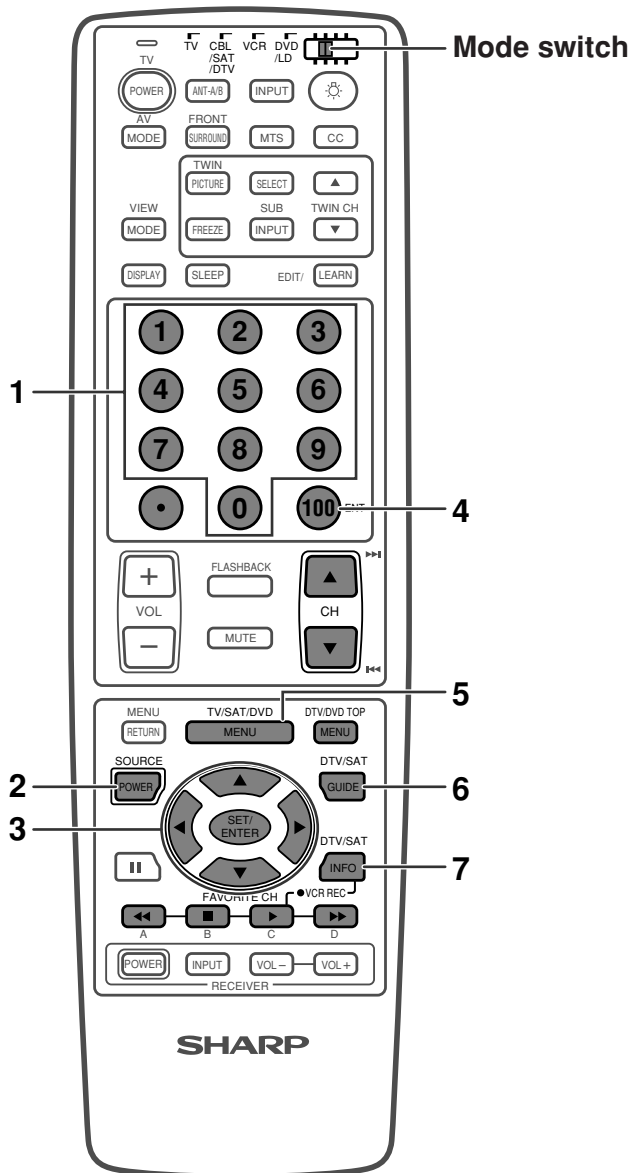

SAT control buttons

When the SAT is preset by the learning remote control function, the remote control unit buttons will function as shown below.

- When the **Mode switch** is set to CBL/SAT/DTV, satellite broadcast tuners made by other manufacturers and not preset can also operate with the remote control unit if **1** to **7** have learned the functions. (See page 68.)

- 0 – 9**
Press a button (or buttons) that corresponds to the channel that you wish to watch.
- SOURCE POWER**
Turns the Satellite broadcast tuner power on and off.
- SET/ENTER, ▲/▼/◀/▶**
SET/ENTER: Press to activate the selected function.
▲/▼/◀/▶: Press the button to select items on the SAT GUIDE screen or SAT MENU screen.
- 100 ENT**
Fix the selected channel with the direct channel selection buttons.
• Use this button to learn if necessary.
- SAT MENU**
When this button is pressed, the satellite broadcasting menu screen will display.
- SAT GUIDE**
When this button is pressed, the satellite broadcasting guide screen will display.
- SAT INFO**
When this button is pressed, information on satellite broadcasting will display.
• Use this button to learn if necessary.

NOTE

- CABLE, SAT and DTV cannot be selected at the same time.
- The color-highlighted buttons shown in the figure at left can learn the control signal from another device's remote control.

Other viewing options

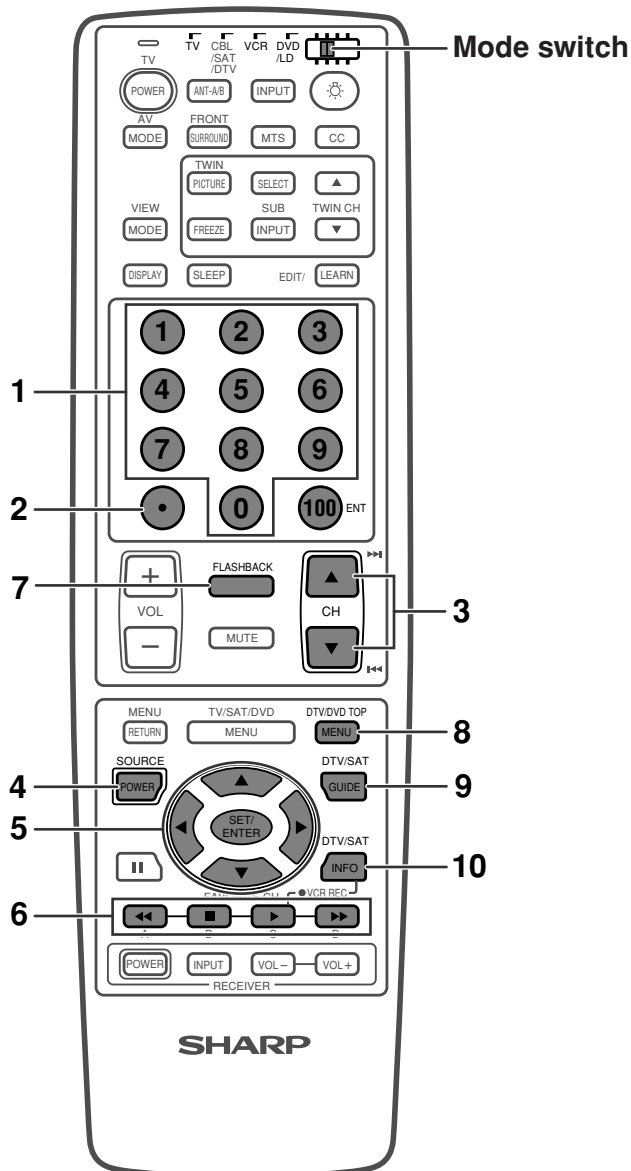

DTV control buttons

For viewing DTV broadcasts, a digital TV tuner (commercially available) is necessary.

When the **Mode switch** is set to CBL/SAT/DTV, the remote control unit buttons will function as shown below.

- Operate the tuner using **1 to 10**.

1 0 – 9

Press a button (or buttons) that corresponds to the channel that you wish to watch.

2 • (DOT)

Used for channel selection.

3 CH ▲/▼

Press **CH ▲** or **CH ▼** to tune in a higher or lower channel.

4 SOURCE POWER

Turns the digital TV tuner on and off.

5 SET/ENTER, ▲/▼/◀/▶

SET/ENTER: Press to activate the selected function.

▲/▼/◀/▶: Press the button to select items on the DTV MENU screen.

6 FAVORITE CH/Colored (blue/green/red/yellow)

FAVORITE CH: Used for making FAVORITE CH settings with the digital TV tuner.

Blue/green/red/yellow: Used to make selections from the digital TV tuner menu.

7 FLASHBACK

Press to switch between the current channel and the channel you were watching immediately before.

8 DTV/DVD TOP MENU

When this button is pressed, the DTV menu screen will display.

9 DTV/SAT GUIDE

When this button is pressed, the DTV guide screen will display.

10 DTV/SAT INFO

When this button is pressed, information on DTV will display.

NOTE

- CABLE, SAT and DTV cannot be selected at the same time.
- The color-highlighted buttons on the remote control can learn the control signal from another device's remote control.

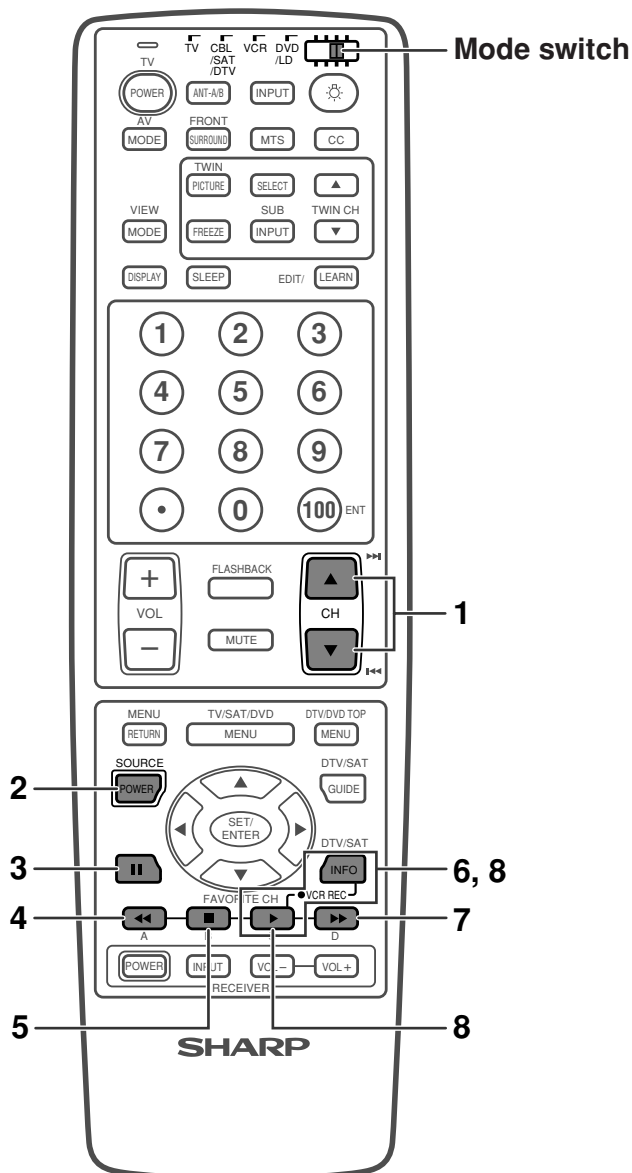

VCR control buttons

When the VCR is preset by the learning remote control function, the remote control unit button will function as follows when the **Mode switch** of the remote control unit is set to VCR.

- When the input selector button having the same number as the input terminal connecting the VCR is pressed, the VCR can operate using **1 to 8**.
- VCR made by other manufacturers and not preset can also operate using the remote control unit if **1 to 8** have learned the functions. (See page 68.)

- 1 CH ▲/▼**
Press to select the channel of the TV tuner on the VCR.
- 2 SOURCE POWER**
Turns the power of the VCR on and off.
- 3 ||**
Set pauses and still pictures.
- 4 ◀◀**
Rewinds the tape and allows picture search.
- 5 ■**
Stop the tape transport.
- 6, 8 VCR REC**
Press these buttons at the same time to start recording.

NOTE

- Depending on the VCR manufacturer, for some models, VCR REC is activated by first pressing **INFO** followed by ▶ while you keep pressing **INFO**. For other models, VCR REC is activated by following the opposite sequence; first pressing ▶ followed by **INFO** while you keep pressing ▶. Please try both methods and use the appropriate one.

- 7 ▶▶**
Rapidly advances the tape and allows picture search.

- 8 ▶**
Selects playback.

NOTE

- The color-highlighted buttons on the remote control can learn the control signal from another device's remote control.

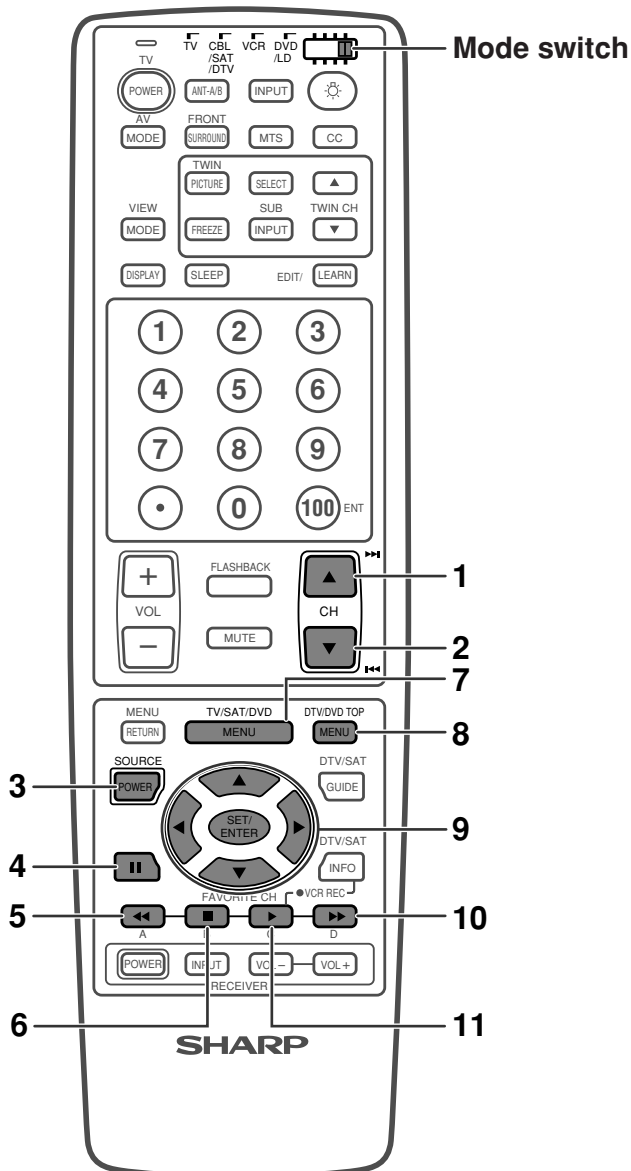

DVD/LD control buttons

When the DVD/LD is preset by the learning remote control function, the remote control unit button will function as follows when the **Mode switch** of the remote control unit is set to DVD/LD.

- When the input selector button having the same number as the input terminal connecting a DVD player or LD player is pressed, these players can operate using **1** to **11**. (**7** to **9** are for DVD players only.)
- DVD/LD players made by other manufacturers and not preset can also operate using the remote control unit if **1** to **11** have learned the functions. (See page 68.)

- Pressing quickly once takes you to the start of the next chapter. Each time you press it, you move ahead to the start of the next chapter.
- Pressing quickly once takes you to the start of the chapter currently playing. Each time you press it, you move back to the start of the previous chapter.
- SOURCE POWER**
Turns the power of the DVD/LD player on and off.
- Set pauses and still pictures.
- Continue pressing to go backward.
- Playback stops when pressing once. With some DVD/LD players, pressing the button twice may open the disc tray.
- DVD MENU (DVD only)**
When this button is pressed, the DVD menu will display.
- DVD TOP MENU (DVD only)**
When this button is pressed, the DVD top menu will display.
- SET/ENTER, ▲/▼/◀/▶ (DVD only)**
SET/ENTER: Press to activate the selected function.
▲/▼/◀/▶: Press the button to select items on the DVD MENU screen.
- Continue pressing for fast forward.
- Selects playback.

NOTE

- DVD and LD cannot be selected at the same time.
- The color-highlighted buttons on the remote control can learn the control signal from another device's remote control.

Appendix

Troubleshooting

Problem	Possible Solution
<ul style="list-style-type: none"> No power 	<ul style="list-style-type: none"> Make sure the Display and the AVC System are connected correctly. (See page 10.) Check if you pressed TV POWER on the remote control unit. (See page 21.) If the indicator on the Display lights up red, press POWER on the Display. Is the AC cord disconnected? (See page 20.) Has the main power been turned on? (See page 21.)
<ul style="list-style-type: none"> Unit cannot be operated. 	<ul style="list-style-type: none"> External influences such as lightning, static electricity, may cause improper operation. In this case, operate the unit after first turning on the power of the Display and the AVC System, or unplugging the AC cord and replugging it in after 1 or 2 minutes.
<ul style="list-style-type: none"> Remote control unit does not operate. 	<ul style="list-style-type: none"> Is the Mode switch set correctly? Slide it to the TV setting position. Are batteries inserted with polarity (+, -) aligned? (See page 13.) Are batteries worn out? (Replace with new batteries.) Are you using it under strong or fluorescent lighting? Is a fluorescent light illuminated near the remote control sensor?
<ul style="list-style-type: none"> Picture is cut off/with sidebar screen. 	<ul style="list-style-type: none"> Is the image position correct? (See pages 47 and 48.) Are screen mode adjustments such as picture size made correctly? (See page 52)
<ul style="list-style-type: none"> Strange color, light color, or color misalignment 	<ul style="list-style-type: none"> Adjust the picture tone. (See pages 32 to 36.) Is the room too bright? The picture may look dark in a room that is too bright. Check the input signal setting. (See page 50.)
<ul style="list-style-type: none"> Power is suddenly turned off. 	<ul style="list-style-type: none"> Is the sleep timer set? (See page 55.) Check the power control settings. (See pages 38 to 40.) The unit's internal temperature has increased. Remove any objects blocking vent or clean.
<ul style="list-style-type: none"> No picture 	<ul style="list-style-type: none"> Is connection to other components correct? (See pages 41 to 46.) Is correct input signal source selected after connection? (See page 50.) Is the correct input selected? (See page 50.) Is a non-compatible signal being input? (See page 77.) Is picture adjustment correct? (See pages 32 to 36.)
<ul style="list-style-type: none"> No sound 	<ul style="list-style-type: none"> Is the volume too low? (See page 24.) Is "Variable" selected in "Audio Out"? (See page 55.) Is correct speaker output ("External" or "Internal") selected in "Speaker"? (See pages 56 and 57.)

Cautions regarding use in high and low temperature environments

- When the unit is used in a low temperature space (e.g. room, office), the picture may leave trails or appear slightly delayed. This is not a malfunction, and the unit will recover when the temperature returns to normal.
 - Do not leave the unit in a hot or cold location. Also, do not leave the unit in a location exposed to direct sunlight or near a heater, as this may cause the cabinet to deform and the Liquid Crystal panel to malfunction.
- Storage temperature: -4°F to +140°F (-20°C to +60°C)

Appendix

PC compatibility chart

Resolution	Frequency	Remarks
640 × 400	85 Hz	
720 × 400	70 Hz	
	85 Hz	
640 × 480	60 Hz	
	65 Hz	Macintosh 13" (67 Hz)
	72 Hz	
	75 Hz	
	85 Hz	
848 × 480	60 Hz	
800 × 600	56 Hz	
	60 Hz	
	72 Hz	
	75 Hz	
	85 Hz	Macintosh 16"
832 × 624	74.5 Hz	
1024 × 768	60 Hz	
	70 Hz	Macintosh 19"
	75 Hz	
	85 Hz	
1280 × 768	60 Hz	
1280 × 1024	60 Hz	

Apple and Macintosh are registered trademarks of Apple Computer, Inc.
DDC is a registered trademark of Video Electronics Standards Association.
Power Management is a registered trademark of Sun Microsystems, Inc.
VGA and XGA are registered trademarks of International Business Machines Co., Inc.

RS-232C port specifications

PC Control of the System

- When a program is set, the Display can be controlled from the PC using the RS-232C terminal. The input signal (PC/AV) can be selected, the volume can be adjusted and various other adjustments and settings can be made, enabling automatic programmed playing.
- Attach an RS-232C cable cross-type (commercially available) to the supplied Din/D-Sub RS-232C for the connections.

NOTE

- This operation system should be used by a person who is accustomed to using computers.

Communication conditions

Set the RS-232C communications settings on the PC to match the display's communications conditions. The Display's communications settings are as follows:

Baud rate:	9,600 bps
Data length:	8 bits
Parity bit:	None
Stop bit:	1 bit
Flow control:	None

Communication procedure

Send the control commands from the PC via the RS-232C connector. The display operates according to the received command and sends a response message to the PC. Do not send multiple commands at the same time. Wait until the PC receives the OK response before sending the next command.

Command format

Eight ASCII codes + CR



Parameter

Input the parameter values, aligning left, and fill with blank(s) for the remainder. (Be sure that 4 values are input for the parameter.)

When the input parameter is not within an adjustable range, "ERR" returns. (Refer to "Response code format".) No problem to input any numerical value for "x" on the table.

0			
0	0	0	9
–	3	0	
1	0	0	
0	0	5	5

When "?" is input for some commands, the present setting value responds.

?			
?	?	?	?

Appendix

Response code format

Normal response



Return code (0DH)

Problem response (communication error or incorrect command)



Return code (0DH)

Command table

- About the command except being indicated here, it is outside the guarantee range of operation.

CONTROL ITEM		COMMAND	PARAMETER	CONTROL CONTENTS
POWER SETTING		P : O : W : R	0 _ _ _	It shifts to standby.
INPUT SELECTION A	TOGGLE	I : T : G : D	x _ _ _	(Toggle) It input-switches by the toggle. (It is the same as an input change key)
	TV	I : T : V : D	0 _ _ _	It input-switches to TV. (A channel remains as it is. (Last memory))
	INPUT1-4	I : A : V : D	* _ _ _	Input terminal number (1-4) It input-switches to INPUT1~INPUT4.
	PC	I : P : C : D	x _ _ _	It input-switches to PC.
INPUT SELECTION B	INPUT 1	I : N : P : 1	0 _ _ _	AUTO An input change is also included.
			1 _ _ _	AV-Y/C
			2 _ _ _	COMPONENT
	INPUT 3	I : N : P : 3	0 _ _ _	AUTO
			1 _ _ _	AV-Y/C
			2 _ _ _	COMPONENT
AV MODE SELECTION	A : V : M : D	0 _ _ _	(Toggle) Although it can choose now, it is toggle operation in inside.	
		1 _ _ _	STANDARD	
		2 _ _ _	DYNAMIC	
		3 _ _ _	MOVIE	
		4 _ _ _	GAME	
		5 _ _ _	USER	
VOLUME POSITION		V : O : L : M	* * _ _	Volume (0-60)
H-POSITION	H : P : O : S	* * * _	AV mode. (± 10)	
		* * * _	PC mode. (± 90)	
		* * * _	AV mode. (± 30)	
		* * * _	PC mode. (± 60)	
CLOCK	C : L : C : K	* * * _	Only PC mode. (± 90)	
		* * * _	Only PC mode. (± 20)	
VIEWMODE	P : H : S : E	0 _ _ _	(Toggle) [AV] Although it can choose now, it is toggle operation in inside.	
		1 _ _ _	Side Bar [AV]	
		2 _ _ _	S.Stretch [AV]	
		3 _ _ _	Zoom [AV]	
		4 _ _ _	Stretch [AV]	
		5 _ _ _	Normal [PC]	
		6 _ _ _	Stretch [PC]	
		7 _ _ _	Dot by Dot [PC]	
		8 _ _ _	Zoom [PC]	
		SRS	S : R : S : S	0 _ _ _
1 _ _ _	Off			
2 _ _ _	SRS			
3 _ _ _	FOCUS			
4 _ _ _	FOCUS + SRS			
TWIN PICTURE	T : W : I : N	0 _ _ _	One screen	
		1 _ _ _	Twin screens	
CHANNEL	D : I : R : E : C : T : C : H : A : N : N : E : L	* * * _	The channel number of TV (1~125) An input change is included if it is not TV display. In Air, 2-69ch is effective. In Cable, 1-125ch is effective.	
		x _ _ _	The channel number of TV + 1 If it is not TV display, it will input-switch to TV.	
		x _ _ _	The channel number of TV - 1 If it is not TV display, it will input-switch to TV.	
ANT-A/B		A : N : T : S	x _ _ _	(Toggle) Change toggle operation of tuner A/B.
CC	C : L : C : P	0 _ _ _	(Toggle) Toggle operation of a closed caption.	
		1 _ _ _	OFF	
		2 _ _ _	CC1	
		3 _ _ _	CC2	
		4 _ _ _	T1	
		5 _ _ _	T2	

NOTE

- If an underbar (_) appears in the parameter column, enter a space.
- If an asterisk (*) appears, enter a value in the range indicated in brackets under CONTROL CONTENTS.
- As long as that from which the parameter (x) in the table is a numerical value, it may write anything.

Appendix

Specifications

Item		37" LIQUID CRYSTAL TELEVISION, Model: LC-37HV4U		
LCD panel		37" Advanced Super View & BLACK TFT LCD		
Number of dots		3,147,264 dots (1366 × 768 × 3dots)		
TV Function	TV-standard (CCIR)	American TV Standard NTSC System		
	Receiving Channel	VHF/UHF	VHF 2-13ch, UHF 14-69ch	
		CATV	1-125ch	
Audio multiplex		BTSC System		
Brightness		430 cd/m ²		
Backlight		60,000 hours (at Manual Standard position)		
Viewing angles		H : 170° V : 170°		
Audio amplifier		10W × 2		
Speakers		Ø 8cm 2pcs		
Terminals	AVC System	Rear	INPUT 1	S-VIDEO in, AV in, COMPONENT in
			INPUT 2	S-VIDEO in, AV in
			INPUT 3	S-VIDEO in, AV in, COMPONENT in, DVI-DIGITAL in
		ANTENNA	75 Ω Unbalance, F Type for VHF/UHF/CATV in	
		Monitor Out	Audio (Variable, Fixed), S-VIDEO out, AV out	
		DC OUTPUT	DC 6.5V 7W MAX	
	Front	INPUT 4	S-VIDEO, AV in	
		PC	15 Pin mini D-Sub, Audio in (Ø 3.5mm jack)	
		Headphones	Ø 3.5mm jack	
OSD language		English/French/Spanish		
Power Requirement		AC 110-240 V, 50/60 Hz		
Power Consumption	AVC System	42 W (0.35W Standby with AC 120 V)		
	Display	144 W (0.4W Standby with AC 120 V)		
Weight	AVC System	12.1 lbs./5.5 kg (w/o stand), 12.3 lbs./5.6 kg (with stand)		
	Display	36.4 lbs./16.5 kg (Display only), 43.9 lbs./19.9 kg (with Display and speakers), 52.9 lbs./24.0 kg (with Display, speakers and stand)		
Accessories		Operation manual (× 1), Remote control unit (× 1), System cable (× 1), AC cord (× 2), "AA" size Alkaline battery (× 2), Stand unit (× 1), Speaker (L× 1, R× 1), Speaker screw (× 4), Cable clamp (Large × 1, Small × 2), RF cable (× 1)		

- As a part of policy of continuous improvement, SHARP reserves the right to make design and specification changes for product improvement without prior notice. The performance specification figures indicated are nominal values of production units. There may be some deviations from these values in individual units.

Optional accessories

The listed optional accessories are available for the Liquid Crystal Television. Please purchase them at your nearest shop.

- Additional optional accessories may be available in the near future. When purchasing, please read the newest catalogue for compatibility and check the availability.

No.	Part name	Part number
1	Wall mount bracket	AN-37AG1
2	System cable (23 feet/7 meters)	AN-07SC1

Dimensional drawings

Display

Unit: inch/(mm)

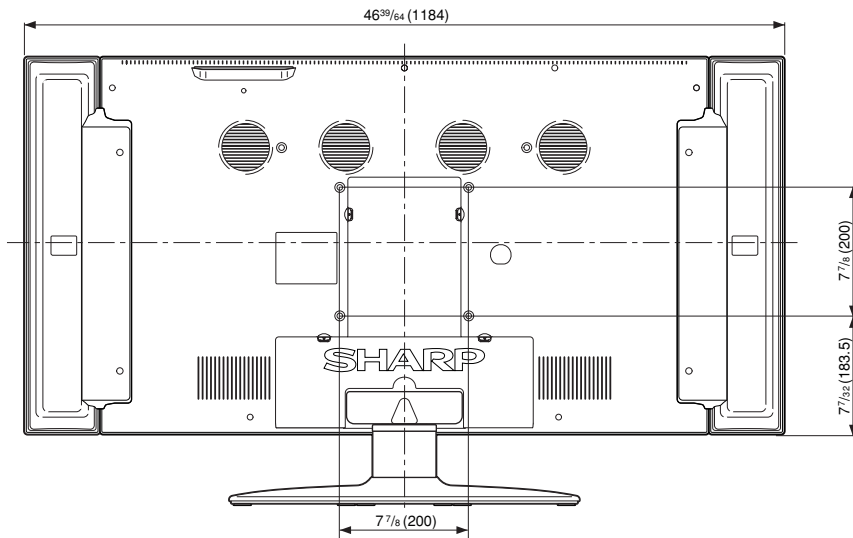
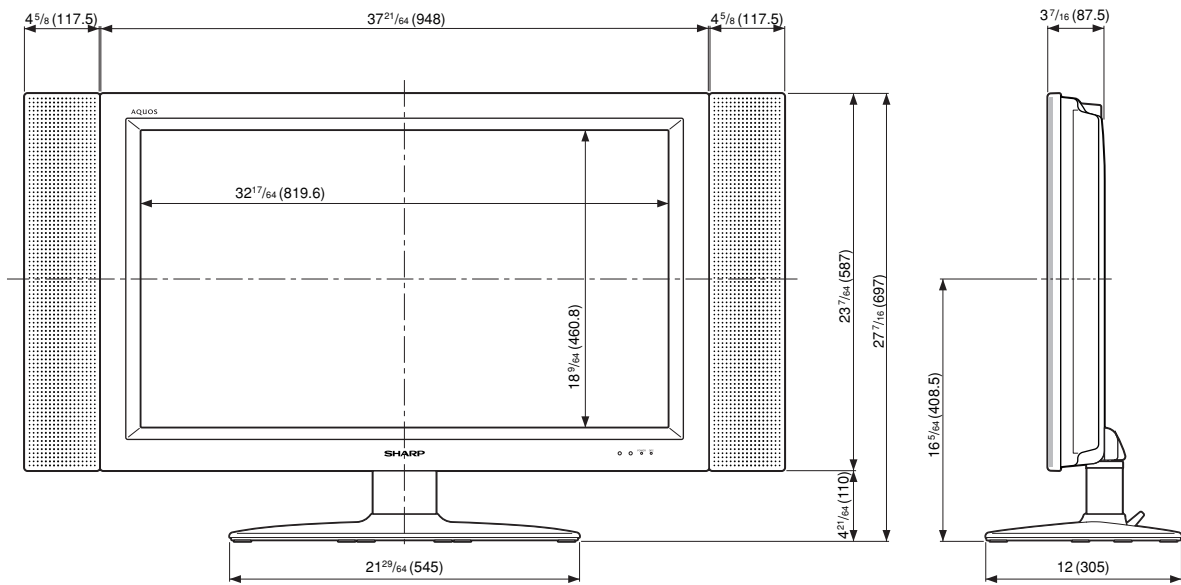
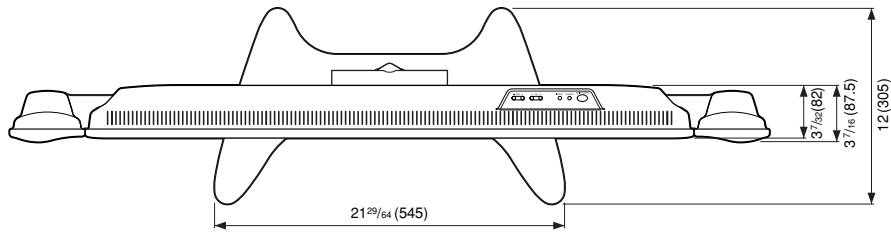

Dimensional drawings

AVC System

Unit: inch/(mm)

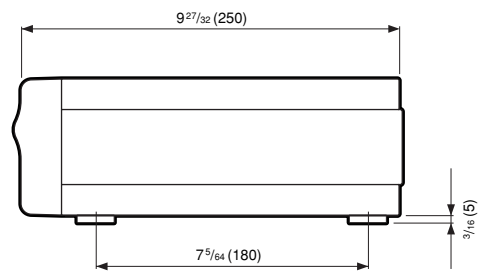
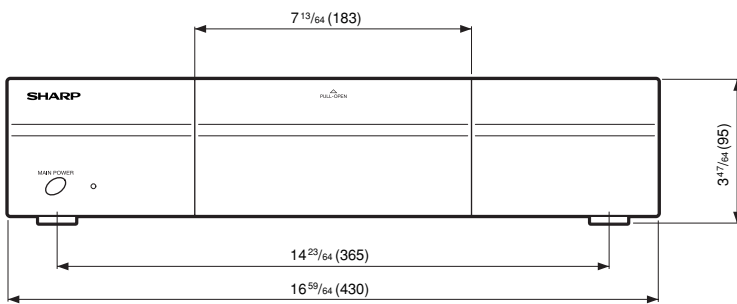
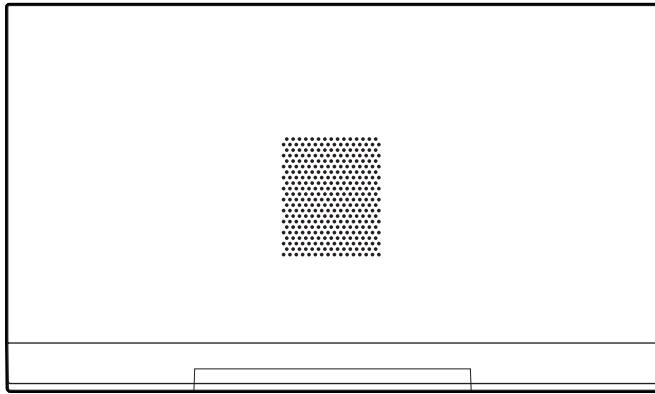

HOW TO SET THE FACTORY PRESETS

Press and hold down **CLEAR** on the AVC System while it is in standby mode. Then press **POWER** button on the Display or **TV POWER** on the remote control unit to turn the System on. All setting items (except TV channel) return to the factory presetting.

NOTE

- Running the factory presetting operation also clears the secret number.

You can run the EZ Setup again by using the following steps.

- 1** Turn on the power of the Display and the AVC System.
- 2** Press **MENU**. (Make sure the menu screen displays.)
- 3** Press **◀/▶** to select "Setup".

NOTE

- If the secret number setting screen displays, you need to enter your secret number.
- If you forget your secret number, refer to HOW TO SET THE FACTORY PRESETS above.

- 4** Press **▲/▼** to select "EZ Setup".
- 5** Press **SET/ENTER**.

The secret number is

				.
--	--	--	--	---

NOTE

- As a precautionary measure, make a note of your secret number above, scissor it from this manual, and keep it in a familiar place.



Calling for Service

For location of the nearest Sharp Authorized Service, or to obtain product literature, accessories, supplies, or customer assistance, please call 1-800-BE-SHARP.

LIMITED WARRANTY

CONSUMER LIMITED WARRANTY

SHARP ELECTRONICS CORPORATION warrants to the first consumer purchaser that this Sharp brand product (the "Product"), when shipped in its original container, will be free from defective workmanship and materials, and agrees that it will, at its option, either repair the defect or replace the defective Product or part thereof with a new or remanufactured equivalent at no charge to the purchaser for parts or labor for the period(s) set forth below.

This warranty does not apply to any appearance items of the Product nor to the additional excluded item(s) set forth below nor to any Product the exterior of which has been damaged or defaced, which has been subjected to improper voltage or other misuse, abnormal service or handling, or which has been altered or modified in design or construction.

In order to enforce the rights under this limited warranty, the purchaser should follow the steps set forth below and provide proof of purchase to the servicer.

The limited warranty described herein is in addition to whatever implied warranties may be granted to purchasers by law. ALL IMPLIED WARRANTIES INCLUDING THE WARRANTIES OF MERCHANTABILITY AND FITNESS FOR USE ARE LIMITED TO THE PERIOD(S) FROM THE DATE OF PURCHASE SET FORTH BELOW. Some states do not allow limitations on how long an implied warranty lasts, so the above limitation may not apply to you.

Neither the sales personnel of the seller nor any other person is authorized to make any warranties other than those described herein, or to extend the duration of any warranties beyond the time period described herein on behalf of Sharp.

The warranties described herein shall be the sole and exclusive warranties granted by Sharp and shall be the sole and exclusive remedy available to the purchaser. Correction of defects, in the manner and for the period of time described herein, shall constitute complete fulfillment of all liabilities and responsibilities of Sharp to the purchaser with respect to the Product, and shall constitute full satisfaction of all claims, whether based on contract, negligence, strict liability or otherwise. In no event shall Sharp be liable, or in any way responsible, for any damages or defects in the Product which were caused by repairs or attempted repairs performed by anyone other than an authorized servicer. Nor shall Sharp be liable or in any way responsible for any incidental or consequential economic or property damage. Some states do not allow the exclusion of incidental or consequential damages, so the above exclusion may not apply to you.

THIS WARRANTY GIVES YOU SPECIFIC LEGAL RIGHTS. YOU MAY ALSO HAVE OTHER RIGHTS WHICH VARY FROM STATE TO STATE.

Model Specific Section

Your Product Model Number & Description:

LC-37HV4U LCD Color Television

(Be sure to have this information available when you need service for your Product.)

Warranty Period for this Product:

One (1) year parts and labor from the date of purchase.

Additional Item(s) Excluded from Warranty Coverage (if any):

Non-rechargeable batteries.

Where to Obtain Service:

From a Sharp Authorized Servicer located in the United States. To find the location of the nearest Sharp Authorized Servicer, call Sharp toll free at 1-800-BE-SHARP.

What to do to Obtain Service:

Contact your Sharp Authorized Servicer to obtain in-home service for this Product. The Servicer will come to your home and if it is necessary to remove the Product, the Servicer will reinstall it. Be sure to have **Proof of Purchase** available.

TO OBTAIN PRODUCT INFORMATION, CALL 1-888-LCD-SHARP OR VISIT www.sharppusa.com

SHARP®

SHARP ELECTRONICS CORPORATION

Sharp Plaza, Mahwah, New Jersey 07430-2135

SHARP CORPORATION

SHARP®

LIMITED WARRANTY

Consumer Electronics Products

Congratulations on your purchase!

Sharp Electronics of Canada Ltd. (hereinafter called "Sharp") gives the following express warranty to the first consumer purchaser for this Sharp brand product, when shipped in its original container and sold or distributed in Canada by Sharp or by an Authorized Sharp Dealer:

Sharp warrants that this product is free, under normal use and maintenance, from any defects in material and workmanship. If any such defects should be found in this product within the applicable warranty period, Sharp shall, at its option, repair or replace the product as specified herein.

This warranty shall not apply to:

- (a) Any defects caused or repairs required as a result of abusive operation, negligence, accident, improper installation or inappropriate use as outlined in the owner's manual.
- (b) Any Sharp product tampered with, modified, adjusted or repaired by any party other than Sharp, Sharp's Authorized Service Centres or Sharp's Authorized Servicing Dealers.
- (c) Damage caused or repairs required as a result of the use with items not specified or approved by Sharp, including but not limited to head cleaning tapes and chemical cleaning agents.
- (d) Any replacement of accessories, glassware, consumable or peripheral items required through normal use of the product including but not limited to earphones, remote controls, AC adapters, batteries, temperature probe, stylus, trays, filters, belts, ribbons, cables and paper.
- (e) Any cosmetic damage to the surface or exterior that has been defaced or caused by normal wear and tear.
- (f) Any damage caused by external or environmental conditions, including but not limited to transmission line/power line voltage or liquid spillage.
- (g) Any product received without appropriate model, serial number and CSA/cUL markings.
- (h) Any products used for rental or commercial purposes.
- (i) Any installation, setup and/or programming charges.

Should this Sharp product fail to operate during the warranty period, warranty service may be obtained upon delivery of the Sharp product together with proof of purchase and a copy of this LIMITED WARRANTY statement to an Authorized Sharp Service Centre or an Authorized Sharp Servicing Dealer. In home warranty service may be provided at Sharp's discretion on any Sharp television with the screen size of 27" or larger and on any Sharp Over-the-Range Microwave Oven.

This warranty constitutes the entire express warranty granted by Sharp and no other dealer, service centre or their agent or employee is authorized to extend, enlarge or transfer this warranty on behalf of Sharp. To the extent the law permits, Sharp disclaims any and all liability for direct or indirect damages or losses or for any incidental, special or consequential damages or loss of profits resulting from a defect in material or workmanship relating to the product, including damages for the loss of time or use of this Sharp product or the loss of information. The purchaser will be responsible for any removal, reinstallation, transportation and insurance costs incurred. Correction of defects, in the manner and period of time described herein, constitute complete fulfillment of all obligations and responsibilities of Sharp to the purchaser with respect to the product and shall constitute full satisfaction of all claims, whether based on contract, negligence, strict liability or otherwise.

WARRANTY PERIODS:

	Parts & Labour (exceptions noted)
Audio Products	1 year
Camcorder	1 year
DVD Products	1 year
LCD Projector	1 year (lamp 90 days)
LCD TV	1 year
Microwave Oven	2 years (magnetron component-3 additional years)
Television Products	1 year (picture tube component-1 additional year)
VCR Product	1 year
Vacuum Cleaner	1 year

To obtain the name and address of the nearest Authorized Sharp Service Centre or Dealer, please contact:
SHARP ELECTRONICS OF CANADA LTD. 335 Britannia Road East, Mississauga, Ontario L4Z 1W9

For more information on this Warranty, Sharp Extended Warranty Offers, Sharp Canada Products, Accessory Sales, Dealer or Service Locations, please call (905) 568-7140
Visit our Web site: www.sharp.ca



SHARP[®]
SHARP ELECTRONICS CORPORATION
Sharp Plaza, Mahwah, New Jersey 07430-2135
SHARP CORPORATION

Printed on post-consumer recycled paper.
Imprimé sur du papier recyclé.
Impreso en papel reciclado.
Impresso em papel reciclado pós utilização.

Printed in Japan
Imprimé au Japon
Impreso en Japón
Impresso no Japão
TINS-A529WJZZ[Ⓐ]
03P02-JKG

Free Manuals Download Website

<http://myh66.com>

<http://usermanuals.us>

<http://www.somanuals.com>

<http://www.4manuals.cc>

<http://www.manual-lib.com>

<http://www.404manual.com>

<http://www.luxmanual.com>

<http://aubethermostatmanual.com>

Golf course search by state

<http://golfingnear.com>

Email search by domain

<http://emailbydomain.com>

Auto manuals search

<http://auto.somanuals.com>

TV manuals search

<http://tv.somanuals.com>