

MODEL
UX-B20

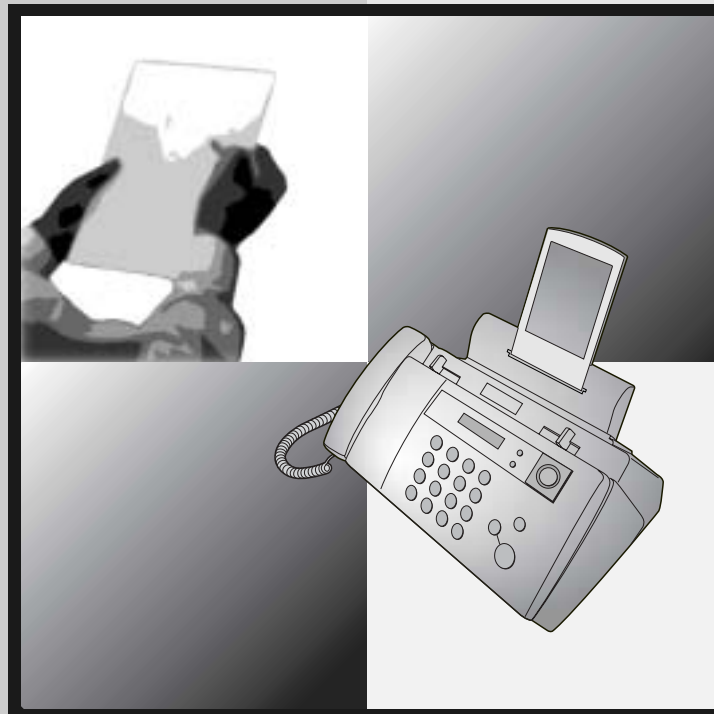

FACSIMILE
OPERATION MANUAL

1. Installation
2. Sending Faxes
3. Receiving Faxes
4. Making Copies
5. Special Functions
6. Printing Lists
7. Maintenance
8. Troubleshooting

SHARP[®]

WARNING - FCC Regulations state that any unauthorized changes or modifications to this equipment not expressly approved by the manufacturer could void the user's authority to operate this equipment.

Note: This equipment has been tested and found to comply with the limits for a Class B digital device, pursuant to Part 15 of the FCC Rules. These limits are designed to provide reasonable protection against harmful interference in a residential installation. This equipment generates, uses and can radiate radio frequency energy and, if not installed and used in accordance with the instructions, may cause harmful interference to radio communications. However, there is no guarantee that interference will not occur in a particular installation. If this equipment does cause harmful interference to radio or television reception, which can be determined by turning the equipment off and on, the user is encouraged to try to correct the interference by one or more of the following measures:

- Reorient or relocate the receiving antenna.
- Increase the separation between the equipment and the receiver.
- Connect the equipment into an outlet on a circuit different from that to which the receiver is connected.
- Consult the dealer or an experienced radio/TV technician for help.

ABOUT THE TELEPHONE CONSUMER PROTECTION ACT OF 1991

"The Telephone Consumer Protection Act of 1991 makes it unlawful for any person to use a computer or other electronic device to send any message via a telephone facsimile machine unless such message clearly contains in a margin at the top or bottom of each transmitted page or on the first page of the transmission the following information:

- (1) The date and time of transmission.
- (2) Identification of either the business, business entity or individual sending the message.
- (3) Telephone number of either the sending machine, business, business entity or individual.

In order to program this information into your facsimile machine, please refer to the appropriate instructions in the operation manual."



As an ENERGY STAR® partner, SHARP has determined that this product meets the ENERGY STAR® guidelines for energy efficiency.

Introduction

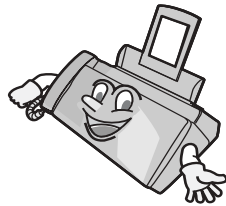

Welcome, and thank you for choosing a SHARP inkjet fax machine! The features and specifications of your inkjet fax are shown below.

Print cartridge yield* (at 4% coverage**)	Initial cartridge Quality mode OFF: Approx. 300 letter pages Quality mode ON: Approx. 200 letter pages Replacement cartridge: SHARP UX-C70B Quality mode OFF: Approx. 600 letter pages Quality mode ON: Approx. 400 letter pages
Paper tray capacity	Letter: Approx. 100 sheets (20-lb. copier paper at room temperature; maximum stack height should not be higher than the line on the tray) Legal: 10 sheets Recommended paper weight: 20-lb. Copy Bond
Recording system	Thermal inkjet
Print resolution	600 × 600 dpi
Effective printing width	8.0" (203 mm) max.
Memory size**	448 KB (approx. 24 average pages)
Modem speed	9600 bps with auto fallback to lower speeds.
Transmission time**	Approx. 15 seconds
Compatibility	ITU-T (CCITT) G3 mode
Compression scheme	MR, MH, H2
Automatic dialing	30 numbers

*Quality mode is initially turned on. To turn off Quality mode, see page 21.

**Based on Sharp Standard Chart at standard resolution, excluding time for protocol signals (i.e., ITU-T phase C time only).

Telephone function	Yes (cannot be used if power fails)
Applicable telephone line	Public switched telephone network
Reception modes	TEL/FAX
Automatic document feeder	Letter/A4: 10 sheets max. (20-lb. paper) Legal: 5 sheets max.
Input document size	Automatic feeding: Width: 5.8 to 8.5" (148 to 216 mm) Length (10 sheets): 5.5 to 11" (140 to 279 mm) Length (5 sheets): 5.5 to 14" (140 to 356 mm) Manual feeding: Width: 5.8 to 8.5" (148 to 216 mm) Length: 5.5 to 23.6" (140 to 600 mm)
Effective scanning width	8.3" (210 mm) max.
Scanning Resolution	Horizontal: 203 lines/inch (8 lines/mm) Vertical: Standard: 98 lines/inch (3.85 lines/mm) Fine /Halftone: 196 lines/inch (7.7 lines/mm) Super fine: 391 lines/inch (15.4 lines/mm)
Halftone (grayscale)	64 levels
Contrast control	Automatic/Dark selectable
Copy function	Single/Multi/Sort (99 copies/page)
Display	16-digit LCD display
Power requirements	120 V AC, 60 Hz
Power consumption	Standby: 4.5 W Maximum: 30 W
Operating temperature	60 - 90°F (15 - 32°C)
Humidity	25 - 80% RH
Dimensions (without attachments)	Width: 13.9" (354 mm) Depth: 9.7" (247 mm) Height: 5.4" (138 mm)

Weight (without attachments)

Approx. 7.0 lbs. (3.2 kg)

As a part of our policy of continuous improvement, SHARP reserves the right to make design and specification changes for product improvement without prior notice. The performance specification figures indicated are nominal values of production units. There may be some deviations from these values in individual units.

Important:

This fax machine is not designed for use on a line which has call waiting, call forwarding, or certain other special services offered by your telephone company. If you attempt to use the fax machine in conjunction with any of these services, you may experience errors during transmission and reception of facsimile messages.

The fax machine is not compatible with digital telephone systems.

Important safety information

Do not disassemble this machine or attempt any procedures not described in this manual. Refer all servicing to qualified service personnel.

Do not install or use the machine near water, or when you are wet. For example, do not use the machine near a bath tub, wash bowl, kitchen sink or laundry tub, in a wet basement, or near a swimming pool. Take care not to spill any liquids on the machine.

Unplug the machine from the power outlet and telephone jack and consult a qualified service representative if any of the following situations occur:

- Liquid has been spilled into the machine or the machine has been exposed to rain or water.
- The machine produces odors, smoke, or unusual noises.
- The power cord is frayed or damaged.
- The machine has been dropped or the housing damaged.

Do not allow anything to rest on the power cord, and do not install the machine where people may walk on the power cord.

This machine must only be connected to a 120 V, 60 Hz, grounded (3-prong) outlet. Connecting it to any other kind of outlet will damage the machine and invalidate the warranty.

Never insert objects of any kind into slots or openings on the machine. This could create a risk of fire or electric shock. If an object falls into the machine that you cannot remove, unplug the machine and consult a qualified service representative.

Do not place this machine on an unstable cart, stand or table. The machine could be seriously damaged if it falls.

Never install telephone wiring during a lightning storm.

Never install telephone jacks in wet locations unless the jack is specifically designed for wet locations.

Never touch bare telephone wires or terminals unless the telephone line has been disconnected at the network interface.

Use caution when installing or modifying telephone lines.

Avoid using a telephone (other than a cordless type) during an electrical storm. There may be a remote risk of electric shock from lightning.

Do not use a telephone to report a gas leak in the vicinity of the leak.

The power outlet must be installed near the equipment and must be easily accessible.

Table of Contents

A Look at the Operation Panel	7
<hr/>	
1. Installation	9
<hr/>	
Unpacking Checklist	9
Attachments	10
Loading Printing Paper	13
Connecting the Power Cord	14
Installing the Print Cartridge	15
Connecting the Telephone Line Cord	23
Entering Your Name and Fax Number	24
Setting the Date and Time	26
Setting the Reception Mode	28
Volume Adjustment	29
2. Sending Faxes	33
<hr/>	
Transmittable Documents	33
Loading the Document	34
Adjusting the Resolution and Contrast	36
Sending a Fax by Normal Dialing	39
Sending a Fax by Automatic Dialing	40
Batch Page Numbering	47
Sending a Fax From Memory	48
3. Receiving Faxes	51
<hr/>	
Using FAX Mode	51
Using TEL Mode	52
Optional Reception Settings	55
Substitute Reception to Memory	57
4. Making Copies	58
<hr/>	
5. Special Functions	61
<hr/>	
Caller ID (Requires Subscription to Service)	61

Table of Contents

Distinctive Ring (Requires Subscription to Service)	66
Blocking Reception of Unwanted Faxes	68
Polling (Requesting a Fax Transmission)	69
6. Printing Lists	70
<hr/>	
7. Maintenance	74
Cleaning the Machine	74
Improving Print Quality	77
8. Troubleshooting	82
<hr/>	
Problems and Solutions	82
Messages and Signals	86
Clearing Paper Jams	89
Ordering Parts.	91
FCC Regulatory Information	92
Quick Reference Guide	96
<hr/>	
Guía de referencia rápida	97
<hr/>	
Index	98
<hr/>	

A Look at the Operation Panel

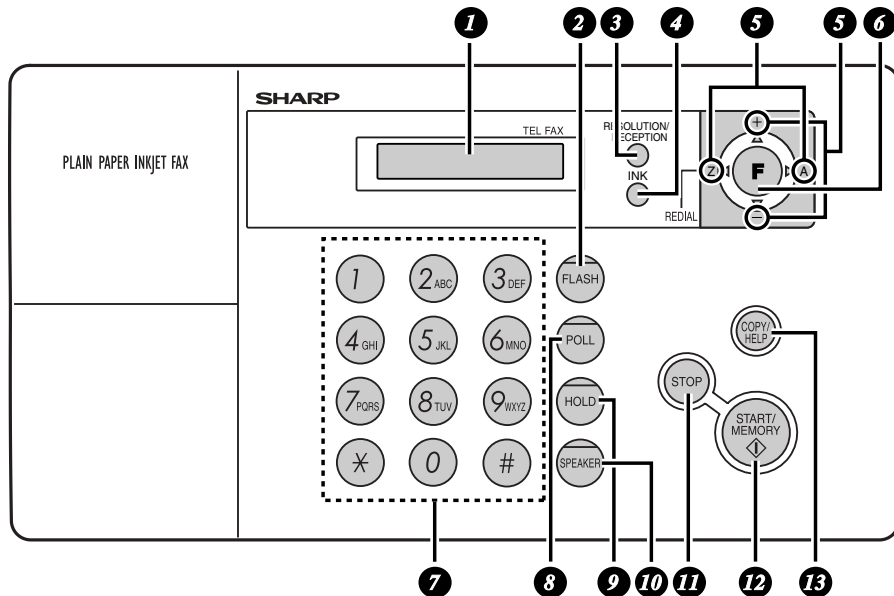

- 1 Display**
This displays messages and prompts to help you operate the machine.
- 2 FLASH key**
This key is used for Call Waiting and other special services that require subscription from your phone company. Your phone company will provide you with details on how to use the key.
- 3 RESOLUTION / RECEPTION key**
When a document is in the feeder, press this key to adjust the resolution for faxing or copying (page 37). At any other time, press this key to select the reception mode (an arrow in the display will point to the currently selected reception mode; page 28).
- 4 INK key**
Press this key before installing or replacing the print cartridge to move the print cartridge holder to the replacement position (page 16).
- 5 Arrow keys**
Use these keys to scroll through and select settings, and to search for auto-dial numbers (page 44).
- 6 FUNCTION key**
Press this key followed by the arrow keys to select special functions and settings.

- 7 Number keys**
Use these keys to dial numbers, and enter numbers and letters when storing auto-dial numbers.
- 8 POLL key**
Press this key after dialing another fax machine to receive a document (previously loaded in the other machine's feeder) without assistance from the operator of the other machine (page 69).
- 9 HOLD key**
Press this key to put the other party on hold during a phone conversation (page 54).
- 10 SPEAKER key**
Press this key to listen to the line and fax tones through the speaker when faxing a document (page 39).
Note: **This is not a speakerphone.** You must pick up the handset to talk with the other party.
- 11 STOP key**
Press this key to cancel an operation before it is completed.
- 12 START/MEMORY key**
Press this key after dialing to begin fax transmission (page 40). Press this key before dialing to send a fax through memory (page 48). The key can also be pressed in the date and time display to show the percentage of memory currently used.
- 13 COPY/HELP key**
When a document is in the feeder, press this key to make a copy of the document (page 59). At any other time, press this key to print out the Help List, a quick reference guide to the operation of your fax machine.

1. Installation

Unpacking Checklist

Before setting up, make sure you have all of the following items.



If any are missing, contact your dealer or retailer.

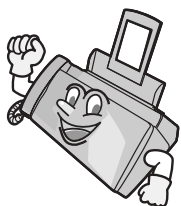

Paper tray extension

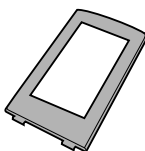

Paper tray

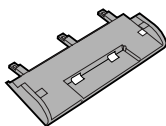

Print cartridge



Handset



Handset cord

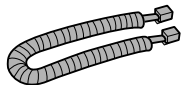

Telephone line cord

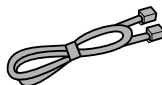

Operation manual

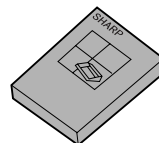

Attachments

Points to keep in mind when setting up

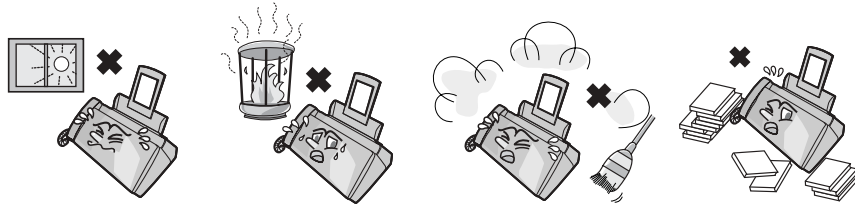

Do not place the machine in direct sunlight.

Do not place the machine near heaters or air conditioners.

Keep dust away from the machine.

Keep the area around the machine clear.

About condensation

If the machine is moved from a cold to a warm place, it is possible that condensation may form on the scanning glass, preventing proper scanning of documents for transmission. To remove the condensation, turn on the power and wait approximately two hours before using the machine.

Removing the packing tape

1 Open the operation panel.



2 Open the print compartment cover.

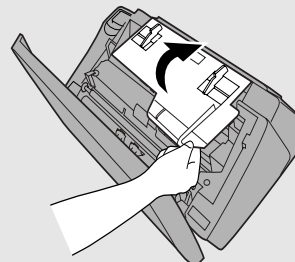

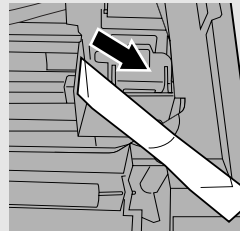
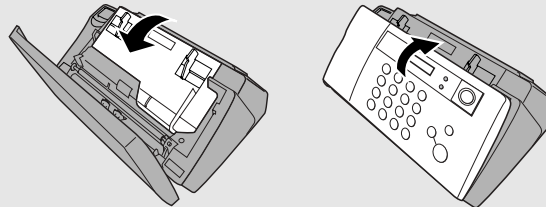
3 Remove the tape.**4 Close the print compartment cover and then the operation panel.****Connecting the handset**

Connect the handset as shown and place it on the handset rest.

- ◆ The ends of the handset cord are identical, so they will go into either jack.

Make sure the handset cord goes into the jack marked with a handset symbol on the side of the machine!

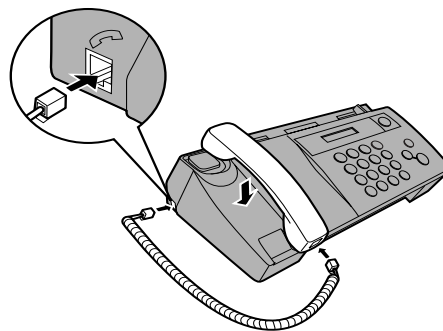
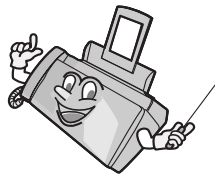

Use the handset to make ordinary phone calls, or to transmit and receive faxes manually.

Attachments

Attaching the paper tray

Attach the paper tray.

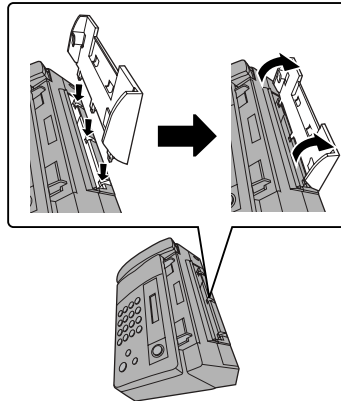

Attach the paper tray extension.

Insert
horizontally
and rotate up

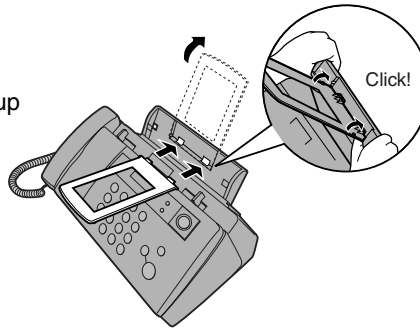

Note: The paper tray extension has a top side and a bottom side. If the tabs do not go into the holes, turn the support over.

Caution!

Do not touch or pull out the black plastic strip shown below. If the strip is pulled out, paper will not feed correctly.

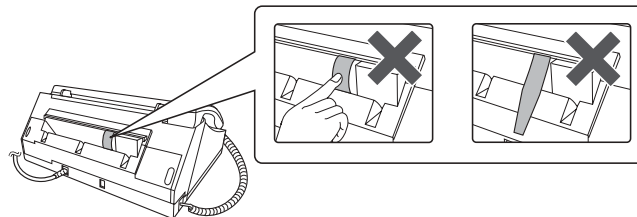

Loading Printing Paper

You can load letter or legal size paper in the paper tray. Recommended paper weight is 20-lb. Copy Bond. The maximum number of sheets is as follows:

- Letter size:** Approx. 100 sheets (20-lb. copier paper at room temperature; maximum stack height should not be higher than the line on the tray)
- Legal size:** 10 sheets (20-lb. copier paper at room temperature)

- 1 Fan the paper, and then tap the edge against a flat surface to even the stack. Make sure the stack edges are even.**

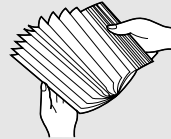

- 2 Insert the stack of paper into the tray, *PRINT SIDE UP*.**

- If paper remains in the tray, take it out and combine it into a single stack with the new paper.
- Be sure to load the paper so that printing takes place on the **print** side of the paper. Printing on the reverse side may result in poor print quality.
- **GENTLY LOAD PAPER INTO THE PAPER TRAY.**
- **DO NOT FORCE IT DOWN INTO THE FEED SLOT.**

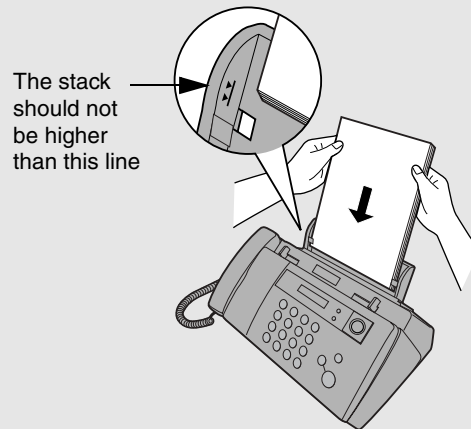

Note: Do not use paper that has already been printed on, or paper that is curled.

Connecting the Power Cord

Connecting the Power Cord

Plug the power cord into a 120 V, 60 Hz, grounded AC (3-prong) outlet.

Caution!

- ◆ Do not plug the power cord into any other kind of outlet. This will damage the machine and is not covered under the warranty.
- ◆ **Make sure you have removed all of the packing tape before plugging in the power cord (see page 10).** Plugging in the power cord without doing so may damage the machine.

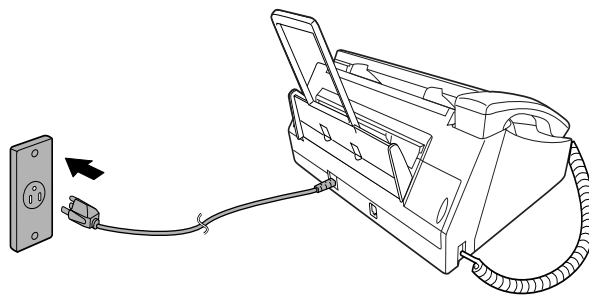

The machine does not have a power on/off switch, so the power is turned on and off by simply plugging in or unplugging the power cord.



“CHECK CARTRIDGE” normally appears in the display the first time you plug in the machine. This message appears until you install the print cartridge.

Note: If your area experiences a high incidence of lightning or power surges, we recommend that you install surge protectors for the power and telephone lines. Surge protectors can be purchased at most telephone specialty stores.

Installing the Print Cartridge

Follow these steps to install or replace the print cartridge.

- ◆ When replacing the print cartridge, be sure to use a **SHARP UX-C70B** cartridge.

Print cartridge yield (at 4% coverage)

Initial cartridge

Quality mode OFF: Approx. 300 letter pages

Quality mode ON: Approx. 200 letter pages

Replacement cartridge (SHARP UX-C70B)

Quality mode OFF: Approx. 600 letter pages

Quality mode ON: Approx. 400 letter pages

Quality mode is initially turned on. To turn off Quality mode, see page 21.

Caution!

Do not open the print compartment cover or insert your hand in the machine while it is printing.

Note: Keep print cartridges sealed in their packages until you are ready to install them. It is recommended that you do not use a cartridge that has been left unused for a long time after opening, as the print quality may be considerably degraded.

- ◆ Make sure the machine's power cord is plugged in and paper is loaded before installing or replacing the print cartridge.
- ◆ If a document is inserted in the feeder, remove the document before installing or replacing the print cartridge (see page 35).

If **PRINTER ERROR** or **PRINTER ERROR/CHECK PAPER** appears...

In the event that the display shows either of the above messages, you must clear the error before installing the print cartridge. The error can usually be cleared by pressing



, or if a paper jam has occurred, by removing the paper jam (see page 90).

Installing the Print Cartridge

1 Press .

- Make sure the handset is on its cradle. If the handset is not on the cradle, pressing  will have no effect.

- The print cartridge holder moves to the cartridge replacement position.

Display:

REPLACE INK &

PRESS INK KEY

2 Open the operation panel.



3 Open the print compartment cover.



4 Remove *only* the tape from the new cartridge.

- **Important:** Make sure you remove all of the tape.
- **CAUTION! DO NOT** touch the gold contact area on the cartridge.

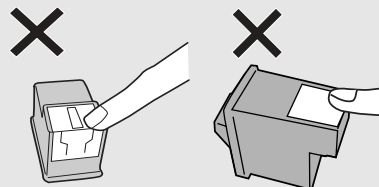
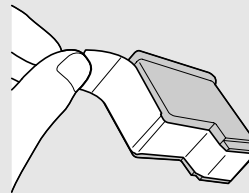

5 Make sure the cartridge holder has moved slightly away from the right side of the compartment, and then pull the green lever and open the cartridge holder cover.

- If you are replacing the cartridge, remove the old cartridge. If you are going to use the old cartridge again, place it in an air-tight container.
- **CAUTION! DO NOT** touch the contact area inside the cartridge holder, or pull on the cable that is connected to the cartridge holder.

Note: If the print compartment cover is left open for approximately 30 minutes with a cartridge installed, the cartridge will automatically return to its home position. To make the cartridge return to the cartridge replacement position

when this has happened, press .

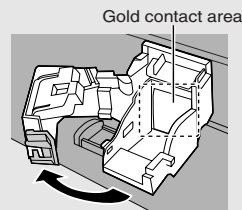
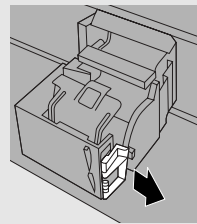
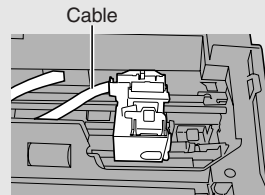

6 Insert the new print cartridge into the cartridge holder.

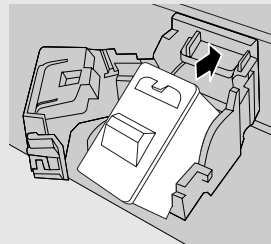

7 Place your index finger on the tab as shown and close the cartridge holder cover with your thumb. Make sure the cover clicks into place.

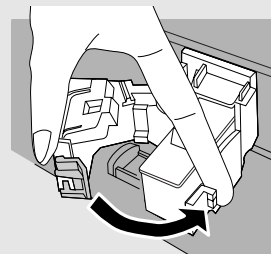

Installing the Print Cartridge

8 Close the print compartment cover.

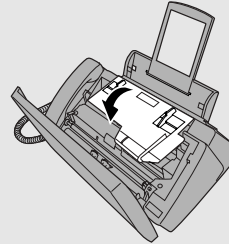

9 Close the operation panel, pressing down firmly to make sure it clicks into place.

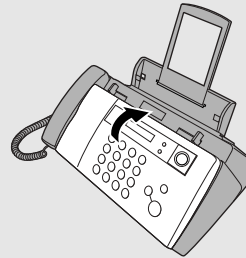

Display: REPLACE INK &
↑ ↓
PRESS INK KEY

10 Press  to make the print cartridge holder return to its home position.

CHANGE CARTRIDGE
↑ ↓
1=NEW, 2=OLD

11 Press  (NEW) if the cartridge you installed is new.

Press  (OLD) if the cartridge you installed is old.

Display when "NEW" is selected:
NEW CART. OK?
↑ ↓
OK: PRESS START

12 Press .

If you selected “OLD” in the previous step, this completes the installation procedure. (Note: If you find that print quality is not satisfactory after reinstalling the old cartridge, align the cartridge as explained on page 77.)

If you selected “NEW”, the display will show the alternating messages at right. Continue with the following steps to align the print cartridge.

Display when “NEW” is selected:

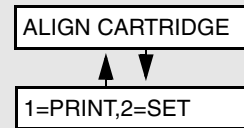

13 Press  to print an alignment page. (To enter an alignment value without printing an alignment page, press .)

14 In the alignment page that the machine prints, locate the line that comes closest to forming a completely straight line.

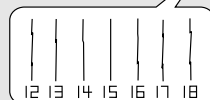
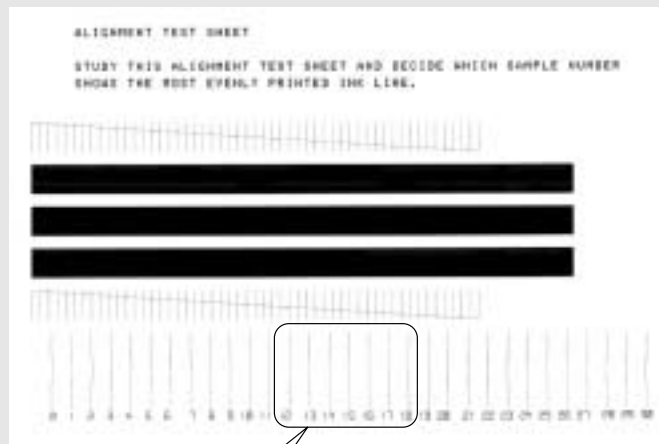

In this example, “15” comes closest to forming a straight line.

After the alignment page is printed, the display shows:

ENTER (0-30) 15

Installing the Print Cartridge

15 Press the number keys to enter the number of the straightest line.

Example:  



- If you make a mistake, press  and then repeat the entry.

16 Press .

- This completes the alignment procedure.



Setting the paper size

The machine has been set at the factory to scale received faxes to letter size paper. If you loaded legal paper, you must change the paper size setting to LEGAL.

1 Press  once and  twice.

Display:

PRINT SET-UP 

2 Press  once and  once.

PAPER SIZE SET 

3 Press  once.

1=LETTER,2=LEGAL

4 Select the paper size:

LETTER:  LEGAL: 

The display briefly shows your selection, then:

COPY CUT-OFF 

5 Press  to return to the date and time display.

Note: If at any time the display shows the alternating messages at right, check the printing paper. If the tray is empty, add paper. If there is paper in the tray, take it out and then reinsert it. When you are finished, press .

ADD PAPER &











↑ ↓

PRESS START KEY

Quality mode (using more/less ink)

If you prefer a higher quality image when printing faxes and copies, turn on Quality mode. If you wish to use less ink or speed up ink drying time, turn off Quality mode.

- ◆ Quality mode is initially turned on.

1 Press  once and  twice.	Display: <div style="border: 1px solid black; padding: 2px; text-align: center;">PRINT SET-UP </div>
2 Press  once and  3 times.	<div style="border: 1px solid black; padding: 2px; text-align: center;">QUALITY MODE </div>
3 Press  once.	<div style="border: 1px solid black; padding: 2px; text-align: center;">1=ON, 2=OFF</div>
4 Press  to turn on Quality mode, or  to turn it off.	The display briefly shows your selection, then: <div style="border: 1px solid black; padding: 2px; text-align: center;">HQ FAX PRINT </div>
5 Press  to return to the date and time display.	











Installing the Print Cartridge

High-quality fax print setting (fast/slow printing of faxes)

The high-quality fax print setting controls the speed at which faxes are printed. If you prefer a higher quality image at a slower printing speed, turn on this setting. If you prefer a faster printing speed over image quality, turn off the setting.

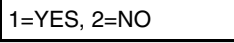
Note: This setting only affects the printing speed. It does not affect the amount of ink used.

- ◆ The high-quality fax print setting is initially turned off.

1 Press  once and  twice.	Display: 
2 Press  once and  4 times.	
3 Press  once.	
4 Press  to turn on high-quality fax print, or  to turn it off.	The display briefly shows your selection, then: 
5 Press  to return to the date and time display.	





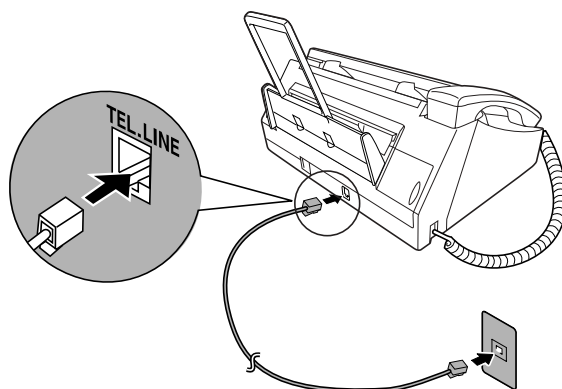





Connecting the Telephone Line Cord

Insert one end of the line cord into the jack on the back of the machine marked **TEL. LINE**. Insert the other end into a standard (RJ11C) single-line wall telephone jack.



Setting the dial mode

The fax machine is set for tone dialing. If you are on a pulse dial line, you must set the fax machine for pulse dialing. Press the panel keys as follows:

- | | |
|--|--|
| 1 Press F once and  3 times. | Display:
OPTION SETTING  |
| 2 Press  once and  3 times. | DIAL MODE  |
| 3 Press  once. | 1=TONE, 2=PULSE |
| 4 Select the dial mode:
TONE:  PULSE:  | The display briefly shows your selection, then:
DISTINCTIVE  |
| 5 Press  to exit. | |

Entering Your Name and Fax Number

Entering Your Name and Fax Number

Before you can begin sending faxes, you must enter your name and fax (telephone) number. You also need to set the date and time.





Once you enter this information, it will automatically appear at the top of each fax page you send.

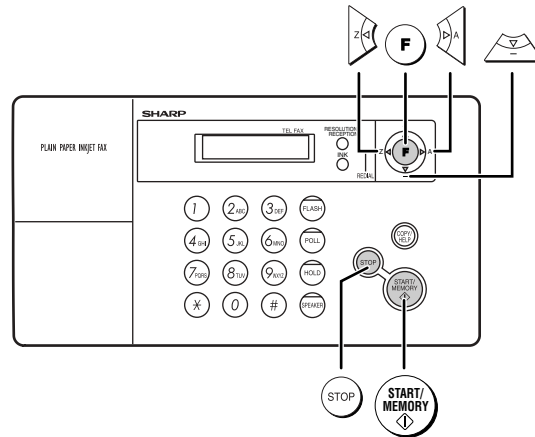

Important!

FCC regulations require that your name, telephone/fax number, and the date and time appear on each fax message you send. Enter your name and fax number here and set the date and time as explained in the following section to have the fax machine include this information automatically at the top of your fax messages.



1 Press **F** once and  twice.

Display:

ENTRY MODE 



2 Press  once.

OWN NUMBER SET 

3 Press  once.

ENTER FAX #

























































4 Enter your fax number by pressing the number keys (max. 20 digits).





- To insert a space between digits, press .
- To clear a mistake, press .

5 Press .

6 Enter your name by pressing number keys for each letter as shown in the chart below. Up to 24 characters can be entered.

Example: SHARP = 7777 44 2 777  7

SPACE = 	G = 	N =  	U =  
A = 	H =  	O =   	V =   
B =  	I =   	P = 	W = 
C =   	J = 	Q =  	X =  
D = 	K =  	R =   	Y =   
E =  	L =   	S =    	Z =    
F =   	M = 	T = 	

- ◆ To enter two letters in succession that require the same key, press  after entering the first letter.
- ◆ To clear a mistake, press .
- ◆ To enter a lower case letter, continue pressing the key for the letter until the lower case letter appears. To enter one of the following symbols, press  or  repeatedly: . / ! " # \$ % & ' () * + , - : ; < = > ? @ [\] ^ _ ' { | } → ←

7 Press .

Display:



8 Press  to return to the date and time display.

Setting the Date and Time

Setting the Date and Time



The date and time appear in the display and are printed at the top of every page you fax. Set the date and time as shown below.

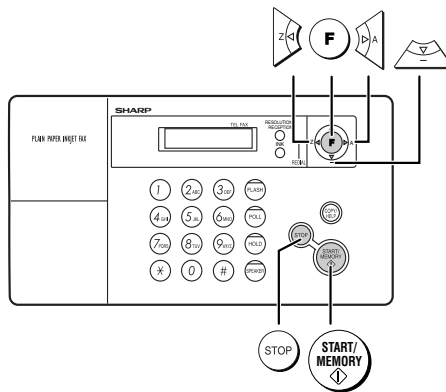

1 Press **F** once and twice. Display: **ENTRY MODE**













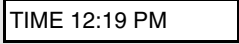

2 Press once and once. **DATE&TIME SET**

3 Press once. The currently set date appears (example): **DATE 08-15-2004**

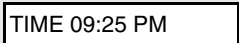
4 Enter a two-digit number for the month ("01" for January, "02" for February, "12" for December, etc.).
Example: January → **DATE 01-15-2004**









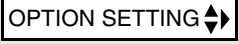

- To correct a mistake, press to move the cursor back to the mistake and then enter the correct number.

5 Enter a two-digit number for the day ("01" to "31").
Example: the 5th → **DATE 01-05-2004**

<p>6 Enter the year (four digits). Example: 2004    </p>	<p>The currently set time appears (example): </p>
<p>7 Enter a two-digit number for the hour (“01” to “12”) and a two-digit number for the minute (“00” to “59”). Example: 9:25    </p>	<p></p>
<p>8 Press  to select A.M. or  to select P.M.</p>	
<p>9 Press  to start the clock.</p>	<p></p>
<p>10 Press  to return to the date and time display.</p>	

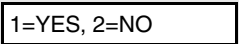
Daylight Saving Time

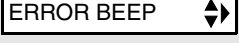
If desired, you can set the clock to move forward and backward automatically at the beginning and end of Daylight Saving Time. Follow these steps:

<p>1 Press  once and  3 times.</p>	<p>Display: </p>
<p>2 Press  once and  4 times.</p>	<p></p>
<p>3 Press  once.</p>	<p></p>
<p>4 Press  to select YES, or  to select NO.</p>	<p></p>
<p>5 Press  to return to the date and time display.</p>	

Setting the Reception Mode

Setting the Reception Mode

The machine has two modes for receiving incoming faxes:

FAX mode:

Select this mode when you only want to receive faxes on your line. The fax machine will automatically answer all calls on four rings and receive incoming faxes.

TEL mode:

Select this mode when you want to receive both phone calls and faxes on the line connected to the fax machine. **All calls, including faxes, must be answered by picking up the fax machine's handset** or an extension phone connected to the same line.

Setting the reception mode

Make sure a document *is not loaded in the document feeder*, and then press  until the arrow in the display points to the desired mode.

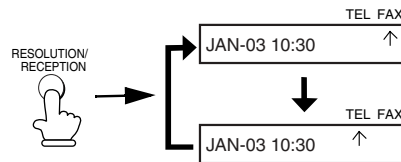
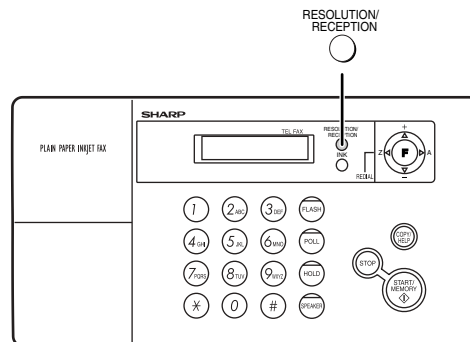

For more information on receiving faxes in FAX and TEL modes, see Chapter 3, *Receiving Faxes*.

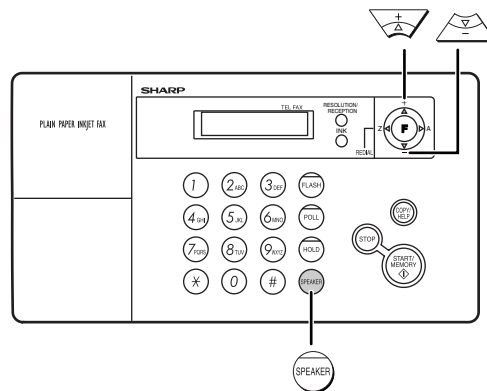

Volume Adjustment

You can adjust the volume of the speaker, handset, and ringer using the up and down arrow keys.



Speaker

1 Press .

2 Press  or  to select the desired volume level.

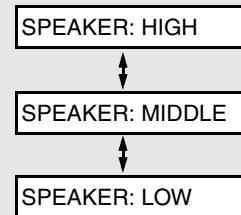

- Press  again to turn off the speaker.

Display:



Volume Adjustment

Handset

1 When talking through the handset, press  or  to select the desired volume level.

- **Note:** The volume reverts to MIDDLE each time you replace the handset.

Display:

RECEIVER: HIGH





RECEIVER: MIDDLE



RECEIVER: LOW

Ringer

1 Press  or  to select the desired volume level. (Make sure  has not been pressed, the handset is not lifted, and a document is not loaded in the feeder.)

- The ringer will ring once at the selected level.

Display:

RINGER: HIGH



RINGER: MIDDLE



RINGER: LOW









RINGER: OFF OK ?

2 If you selected RINGER: OFF OK ? to

turn off the ringer, press .





Error beep off

The machine normally sounds three beeps to alert you when an error occurs during transmission, reception, or copying. The machine also sounds a double-beep when you press an invalid key on the operation panel. If you wish to turn off the error beep, follow the steps below.





1 Press F once and  3 times.	Display: OPTION SETTING 
2 Press  once and  3 times.	ERROR BEEP 
3 Press  once.	1=YES, 2=NO
4 Press 1 to turn on the error beep or 2 to turn off the error beep.	The display briefly shows your selection, then: END BEEP 
5 Press STOP to return to the date and time display.	

End beep off

The fax machine normally sounds one long beep when transmission, reception, or copying ends normally. If you wish to turn off the end beep, follow the steps below.









1 Press F once and  3 times.	Display: OPTION SETTING 
2 Press  once and  twice.	END BEEP 

Volume Adjustment

3 Press  once.	1=YES, 2=NO
4 Press  to turn on the end beep or  to turn off the end beep.	The display briefly shows your selection, then: KEY TONE
5 Press  to return to the date and time display.	

Key tone off

The fax machine normally sounds a beep (key tone) each time you press a key on the operation panel. If you wish to turn off the key tone, follow the steps below.

1 Press  once and  3 times.	Display: OPTION SETTING
2 Press  once and  once.	KEY TONE
3 Press  once.	1=YES, 2=NO
4 Press  to turn on the key tone or  to turn off the key tone.	The display briefly shows your selection, then: FINE PRIORITY
5 Press  to return to the date and time display.	

2. Sending Faxes

Transmittable Documents

Size and weight

Minimum document size:

Minimum size

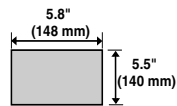

Minimum weight

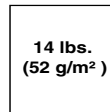

Maximum document size:

The maximum size and weight of documents that you can load in the document feeder depend on how many sheets you load.

10 sheets at once:

Size: Letter
(8.5" x 11", 216 x 279 mm)
Weight: 21.5 lbs. (80 g/m²)

1 sheet at a time (manual feeding):

Size: 8.5" x 23.6" (216 x 600 mm)
Weight: 42 lbs. (157 g/m²)

5 sheets at once:

Size: Legal
(8.5" x 14", 216 x 356 mm)
Weight: 21.5 lbs. (80 g/m²)

Letters or graphics on the edges of a document will not be scanned. (The maximum scanning width is 8.3" (210 mm), and the top and bottom 0.16" (4 mm) of the document cannot be scanned.)

Loading the Document

Other restrictions

- ◆ The scanner cannot recognize yellow, greenish yellow, or light blue ink.
- ◆ Ink, glue, and correcting fluid on documents must be dry before they pass through the document feeder.
- ◆ All clips, staples, and pins must be removed from documents before loading in the feeder. If these are not removed, they may damage the machine.
- ◆ Documents which are patched, taped, torn, smaller than the minimum size, carbon backed, easily smudged, or have a slick coated surface should be photocopied, and the copy loaded in the feeder.

Loading the Document

Up to 10 letter-size sheets, or 5 legal-size sheets, can be placed in the feeder at once. The sheets will automatically feed into the machine starting from the bottom sheet.

- ◆ If you need to send or copy more than the maximum number of sheets, place the additional sheets gently and carefully in the feeder just before the last sheet is scanned. Do not try to force them in, as this may cause double-feeding or jamming.
- ◆ If your document consists of several large or thick sheets which must be loaded one at a time, insert each sheet into the feeder as the previous sheet is being scanned. Insert gently to prevent double-feeding.

- 1** Adjust the document guides to the width of your document.

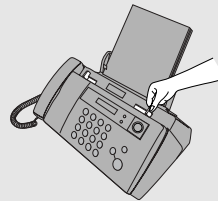

- 2** Insert the document face down in the document feeder. The top edge of the document should enter the feeder first.

- READY TO SEND will appear in the display.

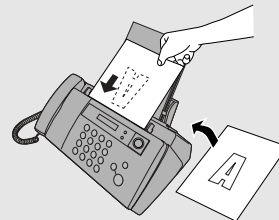

- 3** Adjust the resolution and/or contrast settings as explained on page 36, then dial the receiving machine as explained on page 39.

Removing a document from the feeder

If you need to remove a document from the feeder, open the operation panel.

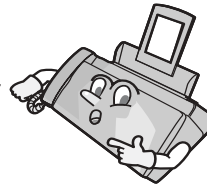

Important!

Do not try to remove a document without opening the operation panel. This may damage the feeder mechanism.

- 1** Open the operation panel.

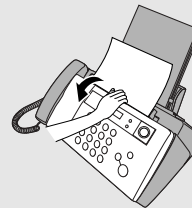

- 2** Remove the document.

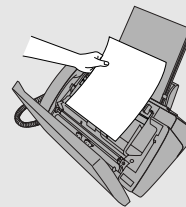

- 3** Close the operation panel, pressing down firmly on both front corners to make sure it clicks into place.



Adjusting the Resolution and Contrast

If desired, you can adjust the resolution and contrast before sending a document.

The default resolution setting is STANDARD and the default contrast setting is AUTO.



You must adjust the settings each time you don't want to use the default settings.

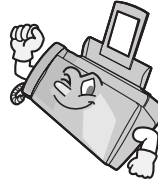

Note: The resolution and contrast settings are only effective for sending a document. They are not effective for receiving a document.

Resolution settings

STANDARD	Use STANDARD for ordinary documents. This setting gives you the fastest and most economical transmission.
FINE	Use FINE for documents containing small letters or fine drawings.
SUPER FINE	Use SUPER FINE for documents containing very small letters or very fine drawings.
HALF TONE	Use HALF TONE for photographs and illustrations. The original will be reproduced in 64 shades of gray.

Contrast settings

AUTO	Use AUTO for normal documents.
DARK	Use DARK for faint documents.

Adjusting the Resolution and Contrast

1 Load the document(s).

- The document must be loaded before the resolution and contrast can be adjusted.

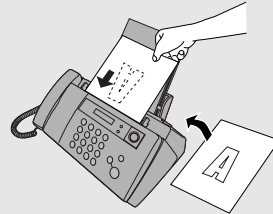

2 Press one or more times until the desired resolution and contrast settings appear in the display.

- The first time you move through the list of resolution settings, the contrast setting AUTO will appear next to each resolution setting. The second time you move through the list, the contrast setting DARK will appear.

Display:

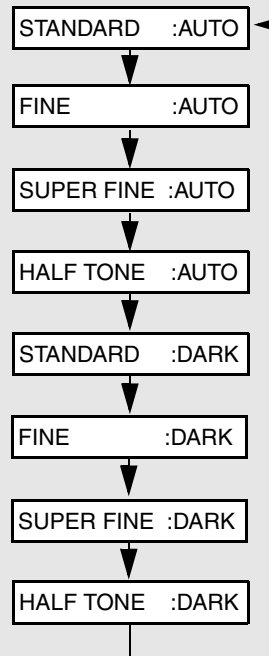











Note: In order to transmit in SUPER FINE resolution, the receiving fax machine must also have that resolution. If it doesn't, your machine will automatically step down to the next best available setting.

Adjusting the Resolution and Contrast

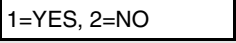
Changing the default resolution

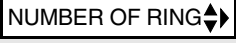
If desired, you can change the default resolution for faxing documents to FINE. Follow the steps below.

1 Press  once and  3 times.	Display: 
2 Press  once.	
3 Press  once.	
4 Press  to set the default resolution to FINE, or  to set it to STANDARD.	The display briefly shows your selection, then: 
5 Press  to return to the date and time display.	

Sending a Fax by Normal Dialing

With Normal Dialing, you pick up the handset (or press ) and dial by pressing the number keys.

- ◆ If a person answers, you can talk with them through the handset before sending the fax. (If you pressed , you must pick up the handset to talk.)
- ◆ Normal Dialing allows you to listen to the line and make sure the other fax machine is responding.

1 Load the document(s).

- If desired, press  to set the resolution and/or contrast.

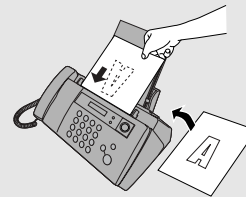

READY TO SEND

2 Pick up the handset or press . Listen for the dial tone.

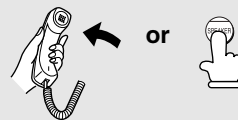

3 Dial the number of the receiving machine by pressing the number keys.



4 Wait for the connection. Depending on the setting of the receiving machine, you will either hear a fax tone or the other person will answer.

- If the other person answers, ask them to press their Start key (if you pressed , pick up the handset to speak with them). This causes the receiving machine to issue a fax tone.

Sending a Fax by Automatic Dialing

5 When you hear the fax tone, press . Replace the handset.

- **Important:** Remove the document as soon as it exits the machine. Otherwise, ink from received faxes and copies may soil the document.
- If the transmission is completed successfully, the machine will beep once.
- If an error occurs, the machine will beep three times and print a Transaction Report to inform you of the problem (see page 72).

Note: If the transmission is unsuccessful and DOCUMENT JAMMED appears in the display, remove the document as explained on page 89. (This may occur if the other fax machine doesn't respond properly when you attempt to send the document.)



Sending a Fax by Automatic Dialing

You can store your most frequently dialed fax or phone numbers in the machine for automatic dialing. Up to 30 numbers can be stored.

◆ Auto-dial numbers are dialed by pressing  until the desired number

appears in the display, and then .

Storing fax and phone numbers for automatic dialing

1 Press  once and  once.



Display:

<NEW NUMBER> 

2 Press  once.

ENTER FAX #

























3 Enter the fax or phone number by pressing the number keys. Up to 32 digits can be entered. (Note: A space cannot be entered.)



- To clear a mistake, press .
- If a pause is required between any of the digits to access a special service or an outside line, press . The pause appears as a hyphen (two seconds per pause). Several pauses can be entered in a row.

4 Press .

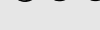
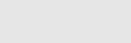
5 Enter a name by pressing number keys for each letter as shown in the chart below. Up to 15 characters can be entered. (If you do not wish to enter a name, go directly to Step 6.)

Example: SHARP = 7777 44 2 777  7

SPACE = 	G = 	N = 	U = 
A = 	H = 	O = 	V = 
B = 	I = 	P = 	W = 
C = 	J = 	Q = 	X = 
D = 	K = 	R = 	Y = 
E = 	L = 	S = 	Z = 
F = 	M = 	T = 	

- ◆ To enter two letters in succession that require the same key, press  after entering the first letter.
- ◆ To enter a lower case letter, continue pressing the key for the letter until the lower case letter appears.
- ◆ To enter one of the following symbols, press  or  repeatedly:
 . / ! " # \$ % & ' () * + , - . : ; < = > ? @ [\] ^ _ ' { | } → ←

Sending a Fax by Automatic Dialing

6 Press .

Display:

<NEW NUMBER> 

7 Return to Step 2 to store another number, or press  to return to the date and time display.



Editing and clearing auto-dial numbers

If you need to make changes to a previously stored auto-dial number, or clear a number, follow these steps:

1 Press  once and  once.

Display:

<NEW NUMBER> 

2 Press  or  until the number that you wish to edit or clear appears in the display.



3 Press .

1=EDIT, 2=CLEAR

4 Press  for EDIT or  for CLEAR.



- If you selected CLEAR, go to Step 8.

5 If you selected EDIT, make the desired changes to the number.

- Press  or  to move the cursor to the digit or digits you wish to change, and then enter the new digit. The new digit will replace the old digit.
- If you do not wish to change the number, go directly to Step 6.

6 Press .

7 Make the desired changes to the name.

- Press  or  to move the cursor to the letter or letters you wish to change, and then press the appropriate number key repeatedly until the desired letter appears (see Step 5 on page 41). The new letter will replace the old letter.
- If you do not wish to change the name, go directly to Step 8.

8 Press .

9 Return to Step 2 to edit or clear another number, or press  to return to the date and time display.

Sending a Fax by Automatic Dialing



Using an auto-dial number

Once you have stored a fax or phone number, you can use it to send a fax or make a phone call.

1 If you are sending a fax, load the document(s).

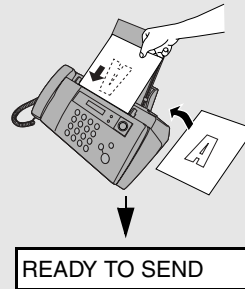
- If desired, press  to set the resolution and/or contrast.



2 Press  (or ) until the name of the other party appears in the display (if no name was stored, the number will appear).

3 If you are sending a fax, press . Dialing and transmission begins.

- **Important:** Remove the document as soon as it exits the machine. Otherwise, ink from received faxes and copies may soil the document.
- If the transmission is completed successfully, the machine will beep once.
- If an error occurs, the machine will beep three times and print a Transaction Report to inform you of the problem (see page 72).

If you are making a phone call, lift the handset. Dialing begins. (If you lifted the handset before searching for the number, press  to begin dialing.)

Sending a fax by Direct Keypad Dialing

You can also enter a full number with the number keys and then press the



key to begin dialing. You can use this method to dial a full number when you don't need to speak to the other party before faxing.

1 Load the document(s).

- If desired, press  to set the resolution and/or contrast.

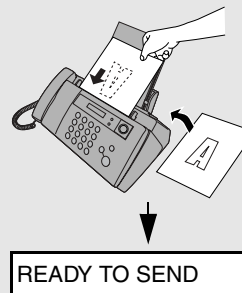

2 Enter the number of the receiving machine by pressing the number keys.

- If a pause is required between any of the digits to access a special service or an outside line, press . The pause will appear as a hyphen (two seconds per pause). Several pauses can be entered in a row.

3 Check the display. If the number of the receiving machine shown is

correct, press .

- If the number is not correct, press  to backspace and clear one digit at a time, and then re-enter the correct digit(s).

Sending a Fax by Automatic Dialing

Redial

You can automatically redial the last number dialed on the fax machine. This procedure can be used to send a fax or make a phone call.

1 If you are sending a fax, load the document(s).

- If desired, press  to set the resolution and/or contrast.

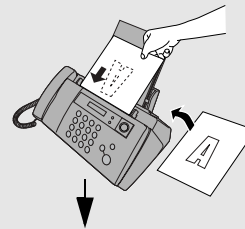

READY TO SEND

2 Press  once. <REDIAL> appears in the display, followed by the last number dialed. Make sure the number that appears is the number you wish to dial.

3 If you are sending a fax, press . Dialing begins.

If you are making a phone call, lift the handset. Dialing begins.

Note: If the transmission is unsuccessful and DOCUMENT JAMMED appears in the display, remove the document as explained on page 89. (This may occur if the other fax machine doesn't respond properly when you attempt to send the document.)

Automatic redialing

If you use automatic dialing (including Direct Keypad Dialing) to send a fax and the line is busy, the fax machine will automatically redial the number. The fax machine will make three redial attempts at intervals of five minutes. During this time, RECALLING will appear in the display, followed by a two-digit number assigned to the fax job. You will not be able to dial any other locations while the message appears.

- ◆ You can press  to clear the message and stop automatic redialing.
- ◆ Under certain conditions (for example if a person answers the call on a telephone), automatic redialing may stop before three redialing attempts are made.

Batch Page Numbering

You can change the page numbering of the transmitted document from simple numbering ("P.01", "P.02", etc.) to batch numbering, which means that a slash and the total number of pages being sent are added after each page number (for example, "P. 01/05", "P.02/05", etc.). This allows the recipient to check for missing pages.

1 Load the document(s).

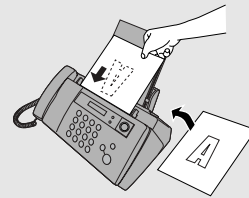

2 Press **F** once and once.

Display:

PAGE COUNTER 

3 Press once.

ENTER # (01 - 99)

4 Enter the total number of pages ("01" to "99") by pressing the numeric keys.

Example: 5 pages  

5 If desired, press to set the resolution and/or contrast.

6 Dial the receiving machine and send the fax.

- ◆ If you need to cancel a batch number entry, remove the document from the feeder or press .
- ◆ If the number of pages actually transmitted does not coincide with the batch number entered, the alarm will sound and PAGE COUNT ERROR will appear in the display. PAGE E. will also appear in the NOTE column of the Transaction Report if printed.

Sending a Fax From Memory

Sending a Fax From Memory

You can scan a document into the machine's memory and send the document from memory. This increases transmission speed and allows you to send a fax to multiple destinations in a single operation. After transmission, the document is automatically cleared from memory.

Note: If a power failure occurs while sending a fax from memory, you will need to repeat the operation.

Broadcasting (sending a fax to multiple destinations)

This function allows you to send the same fax to as many as 20 different destinations in just one operation.

- ◆ When sending to multiple destinations, only auto-dial numbers can be used to dial the numbers of the receiving machines.

1 Load the document(s).

- If desired, press  to set the resolution and/or contrast.

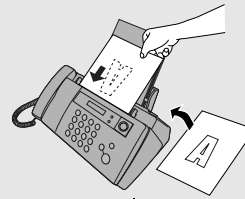



READY TO SEND

2 Press .

3 Press or until the name of the destination appears in the display (if no name was stored, the number will appear).

4 Press to store the destination.

5 Repeat Steps 3 and 4 for each of the other destinations to which you wish to send the fax (maximum of 20).

- To check your selected destinations, press  to scroll through them. To delete a destination, scroll to the destination and then press .





6 When you are ready to begin transmission, press .

- A Transaction Report is automatically printed out after Broadcasting is completed. Check the "Note" column of the report to see if any of the destinations are marked "Busy" or have a communication error code. If so, send the document to those destinations again.

Memory transmission

You can also send a fax through memory when sending to a single destination. This is convenient when sending to destinations where the line is often busy, as it saves you from waiting to pick up the original document and frees the feeder for other operations.

To send a fax through memory, load the document, press , and then dial using one of the following methods:

- ◆ Press the number keys to enter the fax number and then press .
- ◆ Press  repeatedly to select an auto-dial number and then press .
- ◆ Press  once to select the last number dialed and then press .

Sending a Fax From Memory

If the memory becomes full...

If the memory becomes full while the document is being scanned, MEMORY IS FULL will appear in the display.

- ◆ Press  if you want to transmit the pages which have been stored up to that point in memory. The remaining pages will be ejected from the feeder. After transmission, the memory will be cleared and you can transmit the remaining pages. You will also need to transmit the page which was being scanned when the memory filled up.

- ◆ Press  if you want to cancel the entire transmission.

3. Receiving Faxes

Using FAX Mode

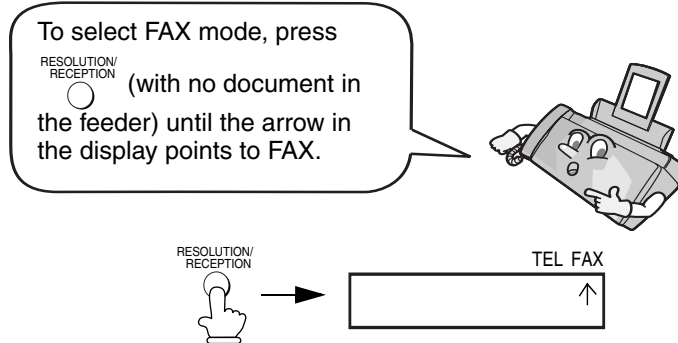

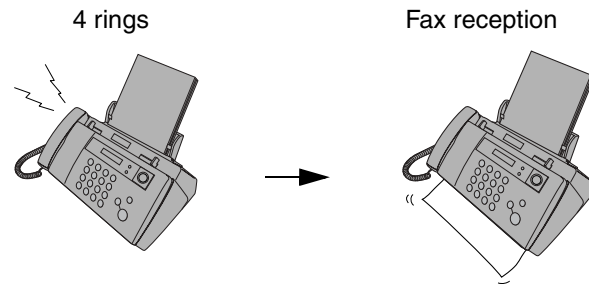

When the reception mode is set to FAX, the machine will automatically answer all calls on four rings and receive incoming faxes.



- ◆ If you pick up the handset before the machine answers, you can talk to the other party and/or receive a fax as explained in *Using TEL Mode* on page 52.
- ◆ Make sure the operation panel is closed, or the paper may jam when received faxes are printed.

Changing the number of rings







If desired, you can change the number of rings on which the machine answers incoming calls in FAX mode. Any number from 2 to 5 can be selected.

1 Press  once and  3 times.

Display:

OPTION SETTING 

Using TEL Mode

2 Press  once and  once.	NUMBER OF RING 
3 Press  once.	ENTER (2-5) (4)
4 Enter the desired number of rings (any number from 2 to 5). Example: 3 rings 	The display briefly shows your selection, then: TRANSACTION 
5 Press  to return to the date and time display.	

Note: If you are using Distinctive Ring, the machine will answer calls after two rings regardless of the above setting.

Using TEL Mode



To select TEL mode, press  (with no document in the feeder) until the arrow in the display points to TEL.



When the reception mode is set to TEL, you must answer all calls (even faxes) by picking up the machine's handset or an extension phone connected to the same line.

Answering with the machine's handset

Important: If a document is loaded in the machine's feeder, remove it before performing the steps below. (Fax reception is not possible when a document is in the feeder.)

- 1** When the machine rings, pick up the handset.



- 2** If you hear a fax tone, wait until the display shows **RECEIVING** and then replace the handset.

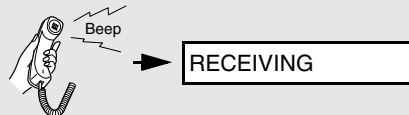

If **RECEIVING** does not appear (or if you have set the Fax Signal Receive setting to **NO**), press  to begin reception.

- 3** If the other party first speaks with you and then wants to send a fax, press



after speaking. (Press before the sender presses their Start key.)

- When **RECEIVING** appears in the display, hang up.



Answering on an extension phone connected to the same line

Important: If a document is loaded in the machine's feeder, remove it before performing the steps below. (Fax reception is not possible when a document is in the feeder.)

- 1 Answer the extension phone when it rings.**

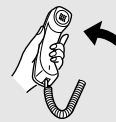

- 2 If you hear a soft fax tone, wait until your machine responds (you will hear pronounced, high-pitched tones), then hang up.**



➔ Pronounced, high-pitched tones





- 3 If the machine doesn't respond, or if the other party first talks to you and then wants to send a fax, set the phone down (do not hang up), walk**

over to the machine, lift the machine's handset, and press



- The above step is necessary if you have set the Fax Signal Receive setting to NO.







Putting a call on hold

To put the other party on hold during a phone conversation, press . When this is done, they cannot hear you. You can put the handset back in the cradle without breaking the connection. When you are ready to speak with the other party again, pick up the handset. If you did not put the handset back in the cradle, press  again to resume conversation.

Optional Reception Settings

Fax Signal Receive

The machine will automatically begin reception if you hear a soft fax tone after answering a call on the machine or an extension phone. If you use a computer fax modem to send documents on the same line, you must turn this function off in order to prevent the machine from mistakenly attempting to receive documents from the computer fax modem. Follow the steps below to change the setting.











1 Press F once and  3 times.	Display: OPTION SETTING 
2 Press  once and  5 times.	FAX SIGNAL RX 
3 Press  once.	1=YES, 2=NO
4 Press 1 to turn on the function, or 2_{ABC} to turn it off.	The display briefly shows your selection, then: CALLER-ID 
5 Press STOP to return to the date and time display.	

Optional Reception Settings

Reception Ratio

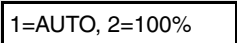
The machine has been set at the factory to automatically reduce the size of received documents to fit the size of the printing paper. This ensures that data on the edges of the document are not cut off. If desired, you can turn this function off and have received documents printed at full size.

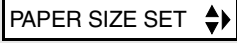
- ◆ If a document is too long to fit on the printing paper, the remainder will be printed on a second page. In this case, the cut-off point may occur in the middle of a line.
- ◆ Automatic reduction may not be possible if the received document is too large, contains too many fine graphics or images, or is sent at high resolution. In this case, the remainder of the document will be printed on a second page.

1 Press  once and  twice.	Display: 
2 Press  once.	
3 Press  once.	
4 Press  to select AUTO, or  to select 100%.	The display briefly shows your selection, then: 
5 Press  to return to the date and time display.	

Substitute Reception to Memory

In situations where printing is not possible, such as when the machine runs out of paper, the print cartridge needs replacement, or the paper jams, incoming faxes will be received to memory.

When you have received a document in memory, FAX RX IN MEMORY will appear in the display, alternating with ADD PAPER & PRESS START KEY, PAPER JAMMED, OUT OF INK, or PRINTER ERROR / CHECK PAPER.

When you add paper (and press ), or clear the jam, or replace the print cartridge, the stored documents will automatically print out.

- ◆ If you received documents in memory because the machine ran out of paper, be sure to add paper which is the same size as the paper previously used. If not, the document print-out size may not match the size of the printing paper.

Caution!

- ◆ When documents are stored in memory, do not turn the power off. This will erase all of the contents.

4. Making Copies



Your fax machine can also be used to make copies. Single and multiple copies (up to 99 per original) can be made, enabling the machine to double as a convenience office copier.

1 Load the document(s) face down. (Maximum of 10 letter sheets or 5 legal sheets.)

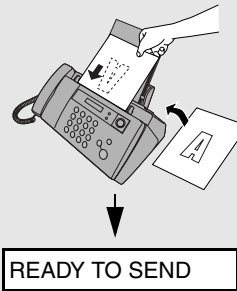
- If desired, press  to set the resolution and/or contrast. (The default resolution setting for copying is FINE.)





2 Select any of the following copy settings as needed:

- **Enlarge/reduce:** Press  or  until the desired setting appears in the display. Settings are 100%, 125%, 135%, 200%, 70%, 88%, 94%, and AUTO (automatic adjustment to match the size of the paper). The default setting is 100%.

Example: Press  twice → **COPY RATIO: 125%**

- **Number of copies per original:** Press the number keys to enter a number from 1 to 99. The default setting is 1.

Example: Press  for two copies → **2**

- **Sorted copies:** To sort the copies as shown below under “Sorted”, first set the number of copies per original (at least “2” copies must be set), and then press .

Example: Two copies each of three originals

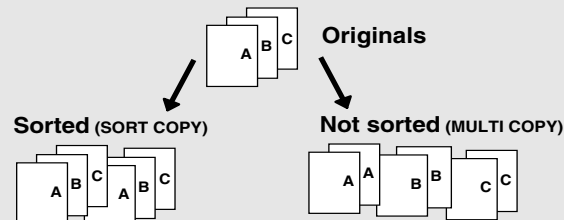

3 When you are ready to begin copying, press .

- **Important:** Remove the document as soon as it exits the machine. Otherwise, ink from the copy may soil the document.



If MEMORY IS FULL appears...

If you place a large number of originals in the feeder, the memory may become full before all pages can be scanned (the display will show MEMORY IS FULL). If this happens, only the pages that were scanned will be copied and the remaining pages will automatically feed out. Repeat the copy procedure for the remaining pages, including the page that was being scanned when the memory became full.



Note: It may not be possible to make a copy of an original if a high resolution setting is used and/or the original contains so much detailed content that the memory becomes full before scanning finishes.

Copy Cut-off

When making a copy of a document that is longer than the printing paper, use the copy cut-off setting to select whether the remaining part of the document will be cut off or printed on a second page. The initial setting is YES (cut off the remainder). To change the setting, follow the steps below.

<p>1 Press  once and  twice.</p>	<p>Display: <input type="text" value="PRINT SET-UP"/></p>
<p>2 Press  once and  twice.</p>	<p><input type="text" value="COPY CUT-OFF"/></p>
<p>3 Press  once.</p>	<p><input type="text" value="1=YES, 2=NO"/></p>

Making Copies

- 4** Press  to set copy cut-off to YES (the remaining part of the document will not be printed), or  to set copy cut-off to NO (the remaining part will be printed on a second page).

The display briefly shows your selection, then:

QUALITY MODE 



- 5** Press  to return to the date and time display.

High-quality copy setting (fast/slow printing of copies)

The high-quality copy setting controls the speed at which copies are printed. If you prefer a higher quality image at a slower printing speed, turn on this setting. If you prefer a faster printing speed over image quality, turn off the setting.



Note: This setting only affects the printing speed. It does not affect the amount of ink used.

◆ The high-quality copy setting is initially turned off.

- 1** Press  once and  twice.

Display:

PRINT SET-UP 

- 2** Press  once and  3 times.

HQ COPY 

- 3** Press  once.

1=YES, 2=NO

- 4** Press  to turn on high-quality copy, or  to turn it off.

The display briefly shows your selection, then:

ALIGN CART. 

- 5** Press  to return to the date and time display.

5. Special Functions







Caller ID (Requires Subscription to Service)

If you subscribe to a caller identification service from your telephone company, you can have the fax machine display the name and number of the caller when you receive a call.

Important:

To use this function, you must subscribe to a caller identification service from your telephone company. Note that your fax may not be compatible with some caller identification services.

- ◆ **Area Code mode:** This step is needed if your telephone exchange cannot dial a local phone number (within your calling area code) when the area code is dialed with the phone number (see Step 5).

1 Press F once and  3 times.	Display: OPTION SETTING 
2 Press  once and  5 times.	CALLER-ID 
3 Press  once.	1=YES, 2=NO
4 Press 1 (YES) to turn on Caller ID. (To turn off Caller ID, press 2 and go to Step 8.)	AREA CODE # MODE ↑ ↓ 1=SET, 2=CLEAR
5 Press 1 to select SET. (To clear a previously set area code, press 2 and go to Step 8.)	ENTER AREA CODE

Note: Entering your area code in this step causes it to be automatically removed from local numbers in the Caller ID list (page 63). This is only required if you need to eliminate dialing of the area code when dialing a local number from the list. Example (using the area code "123"): If Step 6 is skipped, the Caller ID display will show 123-444-1234, and the number that will dial from the Caller ID list is 123-444-1234. If the area code 123 is entered in Step 6, the Caller ID display will show 444-1234, and the number that will dial from the Caller ID list is 444-1234.

Caller ID (Requires Subscription to Service)

6 Enter the three digits of your area code.

7 Press  to store your area code.

DAY LIGHT SAVE 

8 Press  to return to the date and time display.

How Caller ID operates

When you receive a call, the name and phone number of the caller will appear in the display, beginning just before the second ring. The information will continue to be displayed until the line is disconnected.

Display example

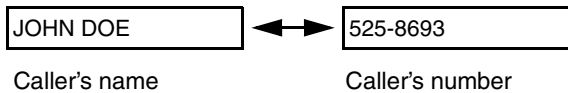

Note: Some caller ID services may not provide the name of the caller. In this case, only the phone number will appear.

Display messages

One of the following messages will appear while the fax rings if caller information is not available.

NO SERVICE	No caller information was received from your telephone company. Make sure that the telephone company has activated your service.
CALLER-ID ERROR	Noise on the telephone line prevented reception of caller information.
OUT OF AREA	The call was made from an area which does not have a caller identification service, or the caller's service is not compatible with that of your local phone company.
PRIVATE CALL	Caller information was not provided by the telephone company at the caller's request.

Viewing the Caller ID list

If you subscribe to a Caller ID service and have turned on the Caller ID function, your fax machine will keep information on the most recent 30 calls and faxes you have received. You can view this information, which consists of the name and number of each caller, in the Caller ID List.

- ◆ After you have received 30 calls, each new call will delete the oldest call.

Follow the steps below to view the Caller ID List in the display. If desired, you can immediately dial a number when it appears.

1 Press  twice.

<REVIEW CALLS> 



2 Press  or  to scroll through the list.

3 If you wish to dial one of the numbers in the list, scroll through the list until the number appears in the display.

- **Fax:** If you wish to send a fax, load the document and then press . Dialing and transmission begin.

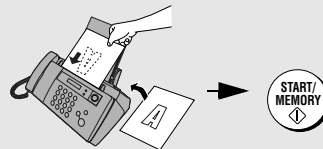
Fax:



- **Voice call:** If you wish to make a voice call, pick up the handset (or press ). Dialing begins automatically. (If you pressed , pick up the handset when the other party answers.)

Voice call:



4 Press  when you have finished viewing the list.

Caller ID (Requires Subscription to Service)









To delete calls from the Caller ID list

If you want to delete a single call from the caller list, press **#** while the call appears in the display. If you want to delete all calls from the list, hold **#** down for at least 3 seconds while you are viewing any number in the list.

Priority Call

If you have turned on Caller ID, you can set the machine to make a special ringing sound when you receive a call from a designated phone number. This lets you know immediately who is calling without having to look at the display.

To use this function, enter the desired phone number by following the steps below (only one phone number can be entered).

1 Press F once and  twice.	Display: ENTRY MODE 
2 Press  once and  once.	PRIORITY # 
3 Press  once.	1=SET, 2=CLEAR
4 Press 1 to store a number. (To clear a previously stored number, press 2 and go to Step 6.)	
5 Enter the number by pressing the number keys (max. 20 digits).	
6 Press  to store (or clear) the number.	OWN NUMBER SET 
7 Press  to return to the date and time display.	

Caller ID (Requires Subscription to Service)

Blocking voice calls

If you have turned on Caller ID, you can use the Anti Junk Fax function described in *Blocking Reception of Unwanted Faxes* in this chapter to block voice calls as well as faxes from your specified Anti Junk Number.

In this case, when a voice call or a fax transmission comes in from the number you have specified as a "Junk Number", your fax will break the connection as soon as it receives the calling phone number from the caller ID service (before the second ring).

To use this function, enter the number that you wish to block as explained in *Blocking Reception of Unwanted Faxes* (see page 68). Only one number can be blocked.

Note: This function cannot be used if you are using the Distinctive Ring function.

Distinctive Ring (Requires Subscription to Service)







Distinctive Ring (Requires Subscription to Service)

Important:

- ◆ **To use distinctive ring, you must subscribe to a distinctive ring service from your local phone company.**
- ◆ Note that your fax machine may not be compatible with some distinctive ring services.

Distinctive ring is a service offered by some local telephone companies whereby they assign an additional second number to your regular single line. The second number rings differently from your normal number.

If you subscribe to a distinctive ring service, you can set the fax machine to automatically answer when your second number is called. This allows you to use the second number as an exclusive fax number. To have your fax automatically answer when your second number is called, follow the steps below:

1 Press  once and  3 times.	Display: 
2 Press  once and  4 times.	
3 Press  once.	

Distinctive Ring (Requires Subscription to Service)

4 Press a number from 1 to 3 (1 to 5 in Canada) to select the ring pattern below that matches your second number's ring pattern. Press 6 to have your fax automatically answer your normal telephone number. Press 7 to turn off the distinctive ring function.

- | | | |
|-------------------|---------------------------------|---|
| 1 | RING PATTERN 1 | Two short rings |
| 2 _{ABC} | RING PATTERN 2 | One short, one long, and one short ring |
| 3 _{DEF} | RING PATTERN 3 | Two short rings and one long ring |
| 4 _{GHI} | RING PATTERN 4
(Canada only) | Three very short rings |
| 5 _{JKL} | RING PATTERN 5
(Canada only) | Two very short rings |
| 6 _{MNO} | STANDARD RING | Your standard (normal) ring pattern |
| 7 _{PQRS} | OFF SETTING | Turn distinctive ring off |

The display briefly shows your selection, then:

FAX SIGNAL RX 

5 Press  to return to the date and time display.

6 Set the reception mode to FAX.











- ◆ When using distinctive ring, you must set the reception mode of your fax machine to FAX. When your designated fax number is dialed, your fax will automatically answer and begin reception after two rings. Note that other devices on the same line will also ring until your fax answers. If one of your other numbers is dialed, the fax will ring; however, it will not answer.

Blocking Reception of Unwanted Faxes

Blocking Reception of Unwanted Faxes

The Anti Junk Fax function allows you to block reception of faxes from a party that you specify. This saves paper by not printing out unwanted "junk" faxes. To use this function, follow the steps below to enter the fax number from which you do not wish to receive faxes. One fax number can be entered.

1 Press  once and  twice.	Display: <input type="text" value="ENTRY MODE"/>
2 Press  once and  twice.	<input type="text" value="ANTI JUNK #"/>
3 Press  once.	<input type="text" value="1=SET, 2=CLEAR"/>
4 Press  to store an Anti Junk number, or  to clear a previously stored number (if you are clearing a number, go to Step 6).	
5 Enter the fax number by pressing the number keys (max. 20 digits).	
6 Press  and then press  to return to the date and time display.	



Polling (Requesting a Fax Transmission)

Polling allows you to call another fax machine and have it send a document (previously loaded in its feeder) to your machine without assistance from the operator of the other machine.

Hint: Polling is useful when you want the receiving fax machine, not the transmitting fax machine, to bear the cost of the call.

- ◆ To use the polling function, the other machine must be capable of being polled.
- ◆ Before polling, make sure the other machine is set up to receive your polling request.
- ◆ Your machine is not capable of being polled.

1 Dial the fax machine that you wish to poll using one of the following methods:











- Enter the full number using the numeric keys.
- Pick up the handset (or press ) and dial the full number. Wait for the fax answerback tone.
- Press  or  until the name (or number) of the other party appears in the display.

2 Press .

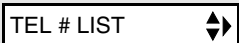
- If you used the handset, replace it when POLLING appears in the display. Reception will begin.

6. Printing Lists

You can print lists showing settings and information entered in the fax machine, and a report showing recent fax transactions. The lists and report are described below. To print a list, follow these steps.

- | | |
|--|--|
| 1 Press  once and  once. | Display:
 |
| 2 Press  once. |  |
| 3 Press  or  until the desired list appears in the display. | |
| 4 Press  once. |  |
| 5 Press  to print the list. | |

Telephone Number List

This list shows the fax and phone numbers that have been stored for automatic dialing.

Setup List

This list shows your current selections for the **FUNCTION** key settings. The list also shows your name and fax/telephone number as entered in the machine, and a sample of the header printed at the top of every page you transmit (**HEADER PRINT**).

```

                                SETUP LIST
                                APR-02-2004 07:34 PM
FOR:
-----
***ENTRY MODE***
ANTI JUNK #
PRIORITY CALL #
SENDER'S NAME
SENDER'S TELEPHONE #
HEADER PRINT
APR-02-2004 07:34 PM P.01
-----
***OPTION SETTING***
FINE PRIORITY NO
NUMBER OF RINGS IN AUTO ANSWER MODE 4 RINGS
TRANSACTION PRINT SELECT ERROR ONLY
DIAL MODE TONE
DISTINCTIVE RINGING OFF
FAX SIGNAL RECEIVE YES
CALLER-ID NO
DAY LIGHT SAVING TIME NO
ERROR BEEP YES
END BEEP YES
KEY TONE YES
-----
***PRINT SET-UP***
RECEPTION RATIO AUTO
PAPER SIZE SET LETTER
COPY CUT OFF YES
QUALITY MODE ON
HIGH QUALITY FAX PRINT NO
HIGH QUALITY COPY NO
ALIGN CARTRIDGE 12
-----

```

Caller-ID List

This list shows information on your 30 most recently received calls and faxes. (This list is only available if you are using the Caller ID function.)

Printing Lists

Transaction Report

This report is printed out automatically after an operation is completed to allow you to check the result. Your fax machine is set at the factory to print out the report only when an error occurs.

- ◆ The Transaction report cannot be printed on demand.

Headings in the Transaction Report

**SENDER/
RECEIVER** The name or fax number of the other machine involved in the transaction. If that machine does not have an ID function, the communication mode will appear (for example, "G3").

START The time at which transmission/reception started.

TX/RX TIME Total time taken for transmission/reception.

PAGES Number of pages transmitted/received.

NOTE (One of the following notes will appear under **NOTE** in the report to indicate whether the transaction was successful, and if not, the reason for the failure.)

OK - Transmission/reception was successful.

P.FAIL - A power failure prevented the transaction.

JAM - The printing paper or document jammed, preventing the transaction.







BUSY - The fax was not sent because the line was busy.

COM.E-X - (Where "X" is a number.) A telephone line error prevented the transaction. See *Line error* on page 82.

CANCEL - The transaction was cancelled because the **STOP** key was pressed, no document was in the feeder, or the other machine requested transmission using a function which your fax machine does not have. If you were attempting to fax, make sure a document is in the feeder. If you were receiving, contact the faxing party to see how they are trying to send to you.

Transaction Report print condition

You can change the condition under which a Transaction Report is printed out. Follow the steps below.

1 Press F once and  3 times.	Display: OPTION SETTING 
2 Press  once and  twice.	TRANSACTION 
3 Press  once.	1:ALWAYS PRINT (Selections appear alternately)
4 Press a number from 1 to 5 to select the condition for printing.	
1 ALWAYS PRINT	A report will be printed after each transmission, reception, or error.
2 ERROR/MEMORY	A report will be printed after an error or a memory operation.
3 SEND ONLY	A report will be printed after each transmission.
4 ERROR ONLY	A report will be printed only when an error occurs.
5 NEVER PRINT	A report will never be printed.
The display briefly shows your selection, then:	
DIAL MODE 	
5 Press STOP to return to the date and time display.	

7. Maintenance

Cleaning the Machine

Cleaning the scanning glass and rollers

Clean the scanning glass and rollers frequently to ensure the quality of transmitted images and copies.

- 1** Open the operation panel.



- 2** Push the green lever at the side of the white roller slightly to the right, and then pull it forward and down.

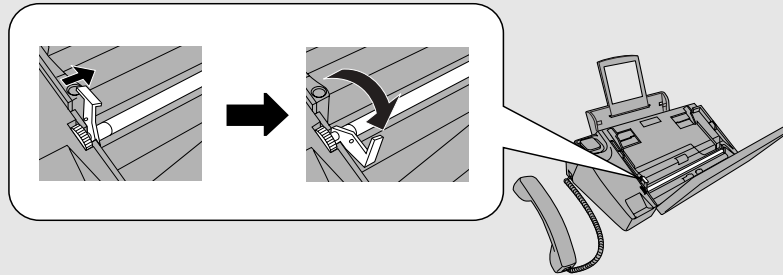

- 3** Pull the left side of the white roller up and then pull the roller to the left and out of the machine.

- Place the roller in a stable position where it will not accidentally fall to the ground.

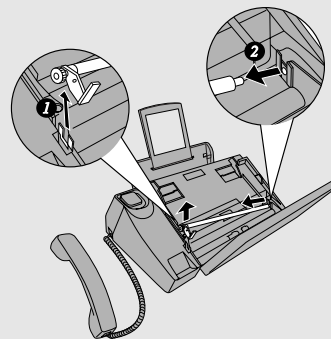

4 Wipe the scanning glass (exposed by removing the white roller) and rollers with a clean cloth.

- Make sure that all dirt and stains (such as correcting fluid) are removed. Dirt and stains will cause vertical lines on transmitted images and copies.

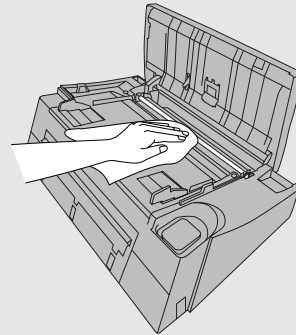

If the scanning glass is difficult to clean

If you find it difficult to remove dirt from the scanning glass, you can try moistening the cloth with isopropyl alcohol or denatured alcohol. Take care that no alcohol gets on the rollers.

5 Replace the white roller, inserting the right end first.

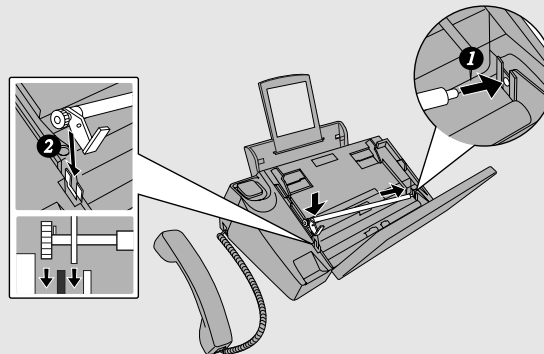

6 Push the green lever up and back. Make sure that the small knob on the lever goes into the hole on the side of the compartment.

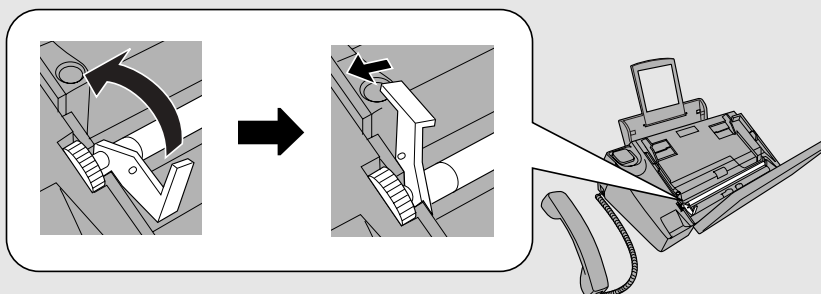

Maintenance

- 7** Close the operation panel, pressing down firmly to make sure it clicks into place.



Cleaning the paper feed roller

A dirty paper feed roller will prevent the paper from feeding correctly. To clean the roller, first remove the paper tray. The roller will be visible in the opening in the rear of the machine. Hold the roller by pressing down on the white part with your finger and wipe the black part with a clean, dry cloth. Rotate the roller as needed to wipe the entire surface of the black part.

- ◆ If you find it difficult to remove dirt from the roller, moisten the cloth with water and then wring it out thoroughly before wiping. **Do not** use alcohol, benzene, thinner, or other solvents.

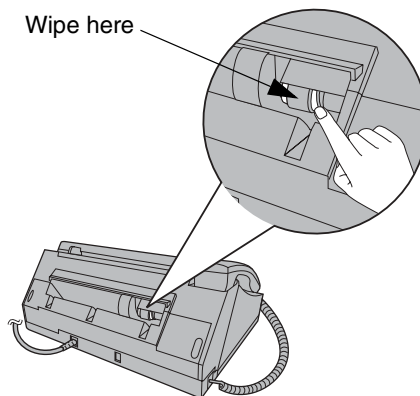

Cleaning the housing

Wipe the external parts and surface of the machine with a dry cloth.

Caution!







Do not use benzene or thinner. These solvents may damage or discolor the machine.

Improving Print Quality

Aligning the print cartridge

If print quality is not satisfactory, first try aligning the print cartridge.

Note: Make sure that paper is loaded before beginning this procedure.

- 1 Press **F** once and  twice. Display: PRINT SET-UP 
- 2 Press  once and  twice. Display: ALIGN CART. 
- 3 Press  once. Display: 1=PRINT,2=SET
- 4 Press **1** to print an alignment page. (To enter an alignment value without printing an alignment page, press **2**.)
- 5 In the alignment page that the machine prints, locate the line that comes closest to forming a completely straight line.

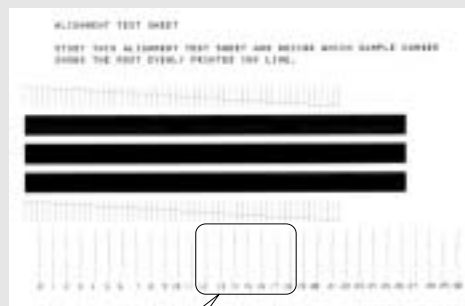

In this example, "15" comes closest to forming a straight line.

After printing the alignment page the display shows:

ENTER (0-30) 15

Maintenance

6 Press the number keys to enter the number of the straightest line.

Example:  

- If you make a mistake, press  and then repeat the entry.



7 Press .

CLEAN NOZZLES 

8 Press  to return to the date and time display.



Cleaning the print cartridge nozzles

If print quality is still not satisfactory after aligning the print cartridge, follow these steps to clean the print cartridge nozzles.

1 Press  once and  twice.

Display:

PRINT SET-UP 

2 Press  once and  once.

CLEAN NOZZLES 

3 Press  once.

PRESS START KEY

4 Press .

- The machine prints a test pattern similar to the one shown in the following step.

5 Compare the diagonal line above the printed bars to the diagonal line below the printed bars.

- Look for a break in the diagonal line above the bars. A break indicates clogged nozzles.

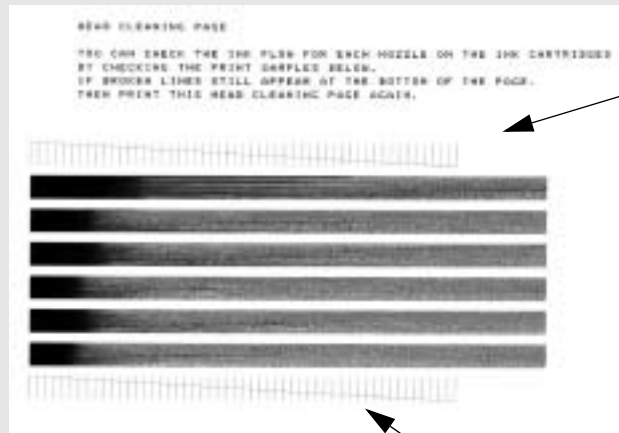

Breaks in the diagonal line at the top of the page indicate clogged nozzles.

Unbroken lines at the bottom of the page indicate the nozzles were cleaned.

6 If the bottom diagonal line still has breaks, repeat Steps 1 through 4 to run the nozzle test again. Run the test a third time if necessary.

- If the print quality is satisfactory after running the nozzle test three times, the nozzles are clean.
- If the print quality is still not satisfactory after running the test a third time, continue with Step 7.

7 Press , open the operation panel, open the print compartment cover, and remove and then reinstall the print cartridge (see the procedure beginning on page 16).

8 Repeat the nozzle test. If the lines are still broken, wipe the nozzles as explained in the following section.

Wiping the print nozzles and contacts

If you have cleaned the print nozzles as explained in the previous section at least three times and print quality is still not satisfactory, try wiping the print nozzles and contacts.

- 1** Press  ^{INK}, open the operation panel, open the print compartment cover, and remove the print cartridge (see the procedure beginning on page 16).

- **CAUTION! DO NOT** touch the gold contact area of the cartridge or the contact area of the cartridge carriage with your fingers.

- 2** Dampen a clean cloth with water, and gently wipe the nozzles and the gold-colored area around the nozzles. Wipe in one direction only.

- To dissolve dried ink, hold the damp cloth against the nozzles for about three seconds. Gently blot and wipe dry.
- When finished, allow the gold-colored area to dry.

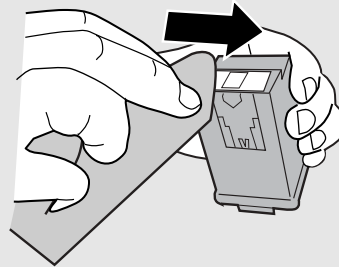

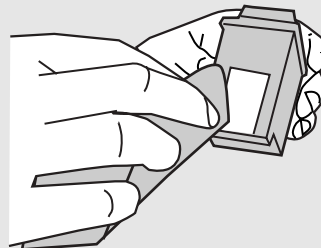

- 3** Dampen another section of clean cloth with water, and gently wipe the contacts and the gold-colored area around the contacts.

- To dissolve dried ink, hold the damp cloth against the contacts for about three seconds. Gently blot and wipe dry.
- When finished, allow the gold-colored area to dry.



- 4** Reinstall the print cartridge and repeat the nozzle test as explained in the previous section.

Cleaning the cartridge holder

A dirty print cartridge holder may cause smudges on your printed pages. To clean the print cartridge holder, press  ^{INK}, open the operation panel, open the print compartment cover, and remove the print cartridge (see the procedure beginning on page 16). Wipe  on the holder with a damp cloth.

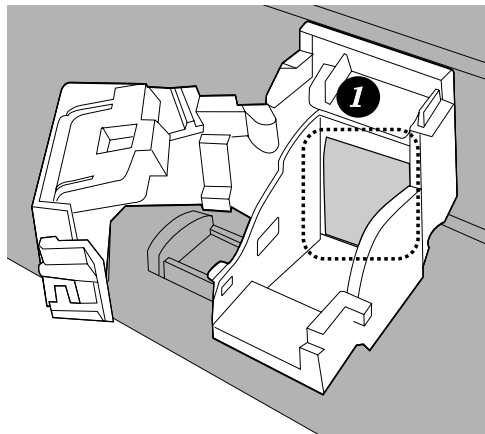

About the lithium battery:

The fax machine uses a lithium battery to retain settings and information programmed in the machine when the power is turned off. Battery power is consumed primarily when the power is off. With the power kept continuously off, the life of the battery is about 5 years. If the battery dies, have your dealer or retailer replace it. Do not try to replace it yourself.

8. Troubleshooting

Problems and Solutions

If you have any problems with the machine, first refer to the following troubleshooting guide. If you cannot solve the problem, call Sharp's Customer Assistance Center at 1-877-794-8675.

Line error

Problem	Solution
LINE ERROR appears in the display.	<p>A line error occurs when your fax machine cannot communicate correctly with the other fax machine. The error is usually due to a problem on the phone line.</p> <p>Try the transaction again. If the error persists, check the following:</p> <ul style="list-style-type: none">• Check the connection. The cord from the TEL. LINE jack to the wall jack should be no longer than six feet.• Make sure there are no modem devices sharing the same telephone line.• Check with the other party to make sure their fax machine is functioning properly.• Have your telephone line checked for line noise.• Try connecting the fax machine to a different telephone line.• If the problem still occurs, your fax machine may need service.

Dialing and transmission problems

Problem	Solution
No dial tone when you pick up the handset or press the SPEAKER key.	<ul style="list-style-type: none"> • Make sure the handset cord is connected to the correct jack. See <i>Connecting the handset</i> on page 11. • Make sure that the telephone line is properly connected to both the TEL. LINE jack and the wall jack (see page 23). • Make sure that the telephone line is good.
Dialing is not possible.	<ul style="list-style-type: none"> • Make sure the power cord is properly plugged into a power outlet. • Make sure that the telephone line is properly connected to both the TEL. LINE jack and the wall jack (see page 23). • Make sure that the fax machine is set to the correct dialing mode for your telephone line. See <i>Dial mode</i> on page 23.
The power is on, but no transmission takes place.	<ul style="list-style-type: none"> • Make sure that the receiving machine has paper. • If the receiving machine is in manual mode with no attendant, reception will not be possible. • Check the display for error messages. • Pick up the handset and check for a dial tone. Dial the receiving machine manually and make sure that it is responding (you should hear a fax tone).
Nothing is printed at the receiving end.	<ul style="list-style-type: none"> • Make sure that the document for transmission is placed face down in the feeder.
A distorted image is received at the other end.	<ul style="list-style-type: none"> • Noise on the telephone line may cause distortion. Try sending the document again. • Make a copy of the document on your fax machine. If the copy is also distorted, your fax machine may need service.

Problems and Solutions

Reception and copying problems

Problem	Solution
The fax machine doesn't receive documents automatically.	<ul style="list-style-type: none">• Make sure that the reception mode is set to FAX. If you subscribe to a distinctive ring service, make sure that the Distinctive Ring function is set to the correct ring pattern. If you do not subscribe to a distinctive ring service, make sure that Distinctive Ring is set to OFF SETTING. (See <i>Distinctive Ring</i> on page 66.)
The printing paper comes out blank when you try to receive a document.	<ul style="list-style-type: none">• Make sure that the document is loaded properly in the feeder of the transmitting machine. Make a copy or print a report to confirm the printing ability of your machine.
Print quality is poor.	<ul style="list-style-type: none">• The print cartridge may need alignment or cleaning. See page 77.
The received document is faint.	<ul style="list-style-type: none">• Ask the other party to send higher contrast documents.• The print cartridge may need replacement. Make a copy or print a report to check your machine's printing ability.
Received images are distorted.	<ul style="list-style-type: none">• Noise on the telephone line may cause distortion. Have the other party try sending the document again.• Make a copy or print a report on your fax machine. If the copy or report is also distorted, your fax machine may need service.
The quality of copies is poor and/or dark vertical lines appear.	<ul style="list-style-type: none">• Any dirt or material on the scanning glass will cause spots to appear on copies and transmitted faxes. Clean the scanning glass as explained on page 74.



General problems





Problem	Solution
Nothing appears in the display.	<ul style="list-style-type: none">• Make sure the power cord is properly plugged into a power outlet.• Connect another electrical appliance to the outlet to see if it has power.
The machine does not respond when you press any of its keys.	<ul style="list-style-type: none">• If a beep sound is not made when you press the keys, unplug the power cord and then plug it in again several seconds later.
Automatic document feeding does not work for transmission or copying.	<ul style="list-style-type: none">• Check the size and weight of the document (see <i>Transmittable Documents</i> on page 33).

Messages and Signals

Display messages

Note: If you have turned on the Caller ID function, see page 62 for display messages related to Caller ID.

<p>ADD PAPER & / PRESS START KEY (alternating messages)</p>	<p>Check the printing paper. If the tray is empty, add paper and then press . If there is paper in the tray, make sure it is inserted correctly (take out the stack, align the edges evenly, and then reinsert it in the tray) and then press .</p>
<p>CHANGE CARTRIDGE</p>	<p>This message appears after you install or replace the print cartridge (see page 18).</p>
<p>CHECK CARTRIDGE</p>	<p>The print cartridge is missing and must be installed, or is not installed correctly.</p>
<p>DOCUMENT JAMMED</p>	<p>The original document is jammed. See the following section, <i>Clearing Paper Jams</i>. Document jams will occur if you load more than 10 pages at once or load documents that are too thick (see page 33). The document may also jam if the receiving machine doesn't respond properly when you attempt to send a fax.</p>
<p>FAX RX IN MEMORY</p>	<p>A fax has been received in memory because the print cartridge needs replacement, you have run out of printing paper, or the paper is jammed. The fax will print out automatically when the problem is fixed.</p>
<p>FUNCTION MODE</p>	<p> has been pressed.</p>
<p>INK NEAR EMPTY</p>	<p>The cartridge is nearly empty (approximately one eighth of the ink remains).</p>

LINE ERROR	Transmission or reception was not successful. Press  to clear the message and then try again. If the error persists, see <i>Line error</i> on page 82.
LOW INK	The cartridge is low on ink (approximately one quarter of the ink remains).
MEMORY IS FULL	If faxes have been received to memory because printing is not possible (an additional message will indicate the problem), resolve the problem so that printing can continue (see <i>Substitute Reception to Memory</i> on page 57). If you are attempting to transmit from memory, see <i>If the memory becomes full</i> on page 50. If you are copying, see <i>If MEMORY IS FULL appears</i> on page 59.
MEMORY PRINTING	The machine is preparing to or printing out a document from memory.
NO # STORED	This appears if you attempt to search for an auto-dial number when none have been stored.
OFF HOOK	This appears if you forgot to replace the handset after using it to dial and send a fax. Replace the handset or press  to clear the message.
ON HOOK DIAL	 has been pressed and the fax machine is waiting for you to dial.
OUT OF INK	The cartridge is out of ink and must be replaced. Faxes will be received to memory.
PAPER JAMMED	The printing paper is jammed. See page 90.
PRINTER ERROR	A printer error has occurred. Open the printer compartment cover, make sure the print cartridge is installed correctly, and then close the cover. Press  to clear the message.

Messages and Signals

PRINTER ERROR/ CHECK PAPER	A paper jam may have occurred. Follow the procedure on page 90 to clear the jam.
READY TO SEND	A document has been loaded and the fax machine is waiting for you to begin faxing or copying.
RECALLING	This appears if you attempt to send a fax by automatic dialing and the line is busy or the receiving fax machine does not answer. Your fax machine will automatically reattempt the call. (See <i>Automatic redialing</i> on page 46.)
TOTAL PAGE(S) 01	Number of pages transmitted, received, or copied.

Audible signals

Continuous tone	3 seconds	Indicates the end of transmission, reception, or copying.
Intermittent tone (3 beeps)	5 seconds (1 second on, 1 second off)	Indicates incomplete transmission, reception, or copying.
Rapid intermittent tone	35 seconds (0.7 seconds on, 0.3 seconds off)	Indicates that the handset is off hook.

Clearing Paper Jams

Clearing a jammed document

If the original document doesn't feed properly during transmission or copying, or DOCUMENT JAMMED appears in the display, first try pressing . If the document doesn't feed out, remove it as explained below.

Important:

Do not try to remove a jammed document without releasing it as explained below. This may damage the feeder mechanism.

1 Open the operation panel.



2 Gently remove the document.

- Be careful not to tear the document.

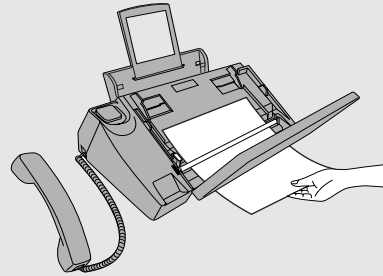

3 Close the operation panel, pressing down firmly to make sure it clicks into place.



Clearing Paper Jams

Clearing jammed printing paper

Gently pull the jammed paper out of the machine, taking care not to tear it.

After removing the jammed paper, press  to clear the error message (PAPER JAMMED) from the display.

- ◆ Normal operation cannot be resumed until you press  to clear the error message.

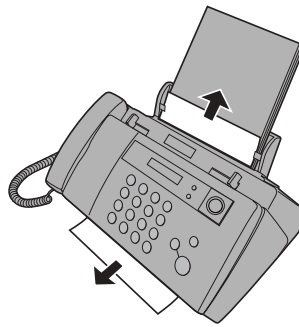

Ordering Parts

To order parts, contact the parts distribution center located nearest you. When ordering a part, use the part order number shown below.

Operation manual	TINSE4427XHTZ
Setup Guide	TCADH3685XHZZ
Handset cord	QCNWG209BXHGR
Telephone line cord	QCNWG370BXHZZ
Handset	DUNTK245DXHGY
Paper tray	LPLTP3318XHZZ
Paper tray extension	CPLTP3222XHR3

Part distribution centers

Tritronics, Inc. 1306 Continental Drive Abingdon, MD 21009	Tel: 1-800-638-3328 Fax: 1-800-888-FAXD
--	--

Tritronics, Inc. 1015 NW 52nd Street Ft. Lauderdale, FL 33309	Tel: 1-800-365-8030 Fax: 1-800-999-FAXD
---	--

Fox International, Ltd. 23600 Aurora Road Bedford Heights, OH 44146	Tel: 1-800-321-6993 Fax: 1-800-445-7991
---	--

Andrews Electronics 25158 Avenue Stanford Santa Clarita, CA 91355	Tel: 1-800-274-4666 Fax: 1-805-295-5126
---	--

Sharp Accessories and Supply Center 2130 Townline Road Peoria, IL 61615	Tel: 1-800-642-2122
--	---------------------

FCC Regulatory Information

FCC Regulatory Information

This equipment complies with Part 68 of the FCC rules and the requirements adopted by the ACTA. On the rear of this equipment is a label that contains, among other information, a product identifier in the format US:AAAEQ##TXXXX. If requested, this number must be provided to the telephone company.

A plug and jack used to connect this equipment to the premises wiring and telephone network must comply with the applicable FCC Part 68 rules and requirements adopted by the ACTA. A compliant telephone cord and modular plug is provided with this product. It is designed to be connected to a compatible modular jack that is also compliant. See installation instructions for details. This equipment connects to the telephone network through a standard USOC RJ-11C network interface jack.

The REN is used to determine the number of devices that may be connected to a telephone line. Excessive RENs on a telephone line may result in the devices not ringing in response to an incoming call. In most but not all areas, the sum of RENs should not exceed five (5.0). To be certain of the number of devices that may be connected to a line, as determined by the total RENs, contact the local telephone company. For products approved after July 23, 2001, the REN for this product is part of the product identifier that has the format US:AAAEQ##TXXXX. The digits represented by ## are the REN without a decimal point (e.g., 03 is a REN of 0.3). For earlier products, the REN is separately shown on the label.

If this equipment causes harm to the telephone network, the telephone company will notify you in advance that temporary discontinuance of service may be required. But if advance notice isn't practical, the telephone company will notify the customer as soon as possible. Also, you will be advised of your right to file a complaint with the FCC if you believe it is necessary.

The telephone company may make changes in its facilities, equipment, operations or procedures that could affect the operation of the equipment. If this happens the telephone company will provide advance notice in order for you to make necessary modifications to maintain uninterrupted service.

If trouble is experienced with this equipment, or for repair or warranty information, please contact Sharp's Customer Assistance Center. The number is 1-877-794-8675. If the equipment is causing harm to the telephone network, the telephone company may request that you disconnect the equipment until the problem is resolved.

This equipment may not be used on coin service provided by the telephone company. Connection to party line service is subject to state tariffs. Contact the state public utility commission, public service commission or corporation commission for information.

If your home has specially wired alarm equipment connected to the telephone line, ensure the installation of this equipment ID does not disable your alarm equipment. If you have questions about what will disable alarm equipment, consult your telephone company or a qualified installer.

This equipment is hearing-aid compatible.

When programming and/or making test calls to emergency numbers:

- ◆ Remain on the line and briefly explain to the dispatcher the reason for the call.
- ◆ Perform such activities in the off-peak hours, such as early morning or late evening.

S H A R P

Revised date: _____

Issued date : Sep.19.2002

MATERIAL SAFETY DATA SHEET (1/3)

MSDS No. B-1028

Section 1. Product Identification

Product Code : Ink-Cartridge (Mono) UX-C70B

Section 2. Supplier's Name and Address

Sharp Corporation

22-22 Nagaike-cho, Abeno-ku, Osaka, Japan

Local suppliers are listed below. Please contact the nearest supplier for additional information.

(Country)	(Name and Telephone Number)
U.S.A.	Sharp Electronics Corporation Telephone number for information: 1-800-237-4277 Emergency telephone number : 1-800-255-3924
Canada	Sharp Electronics of Canada Ltd. Telephone number for information : 905-890-2100 Emergency telephone number : 1-800-424-9300

Section 3. Composition / Information for Ingredients

Ingredients	Cas No.	Proportion (% by Weight)	OSHA PEL	ACGIH TLV
Carbon Black	1333-86-4	1-6	3.5 mg/m ³ (1)	3.5 mg/m ³ (1)
Acrylic Terpolymer	(2)	0.1-2	(3)	(3)
Water Soluble Organic Solvents	(2)	10-20	(3)	(3)
Hydroxylated Alkane	(2)(4)	1-10	(3)	(3)
Acrylic Resin	(2)	0.1-5	(3)	(3)
Water	7732-18-5	>55	(3)	(3)

- Notes:**
- (1) Total dust (measured carbon black)
 - (2) Trade secret of patented molecule.
 - (3) Specific workplace exposure limits have not been established.
 - (4) New Jersey Trade Secret Registration Number (NJTSRN) 80100451-5004

Section 4. Hazardous Identification

The following information is based on testing of the ink and on the characteristics of component chemicals:

Primary Routes of Entry: Ink stains on skin or mucus membranes (mouth, eyes & nose) may cause discomfort.

Medical Conditions

Aggravated by Exposure: None known at intended levels of use.

POTENTIAL HEALTH EFFECTS:

- Inhalation:** Short Term Exposure -- If ink mist is inhaled, respiratory tract irritation may occur.
Long Term Exposure -- No adverse chronic effects expected.
- Skin Contact:** Short Term Exposure -- Ink may be slightly irritating to the skin.
Long Term Exposure -- No adverse chronic effects expected. Not a dermal sensitizer.
- Eye Contact:** Short Term Exposure -- Not an eye irritant.
Long Term Exposure -- No adverse chronic effects expected.
- Ingestion:** Short Term Exposure -- Low oral toxicity.
Long Term Exposure -- No adverse chronic effects known or expected, but based on component characteristics, gastrointestinal effects, liver and kidney toxicity, and CNS effects are possible if large quantities of ink are repeatedly ingested.

S H A R P

Revised date: _____
Issued date :Sep.19.2002

MATERIAL SAFETY DATA SHEET (2/3)

MSDS No. B-1028

Section 5. First Aid Measures

Inhalation: Remove to fresh air. Seek medical attention if breathing becomes difficult.
Ingestion: Immediately rinse mouth out with plenty of water. If within 30 minutes after ingestion, give victim a small glass of water or milk (NEVER give anything by mouth to an unconscious person). Contact physician or poison center. Do not induce vomiting unless instructed to do so by a physician or poison center.
Skin Contact: Remove contaminated clothing. Flush affected area with water. Seek medical attention if irritation develops and persists.
Eye Contact: Flush immediately with plenty of water. Remove contact lenses and continue flushing for at least 15 minutes. Seek medical attention if irritation develops and persists.

Section 6. Fire Fighting Measures

Flash Point: Not applicable
Flammability Limits(%): Not applicable
Extinguishing Media: Water, foam, carbon, dioxide or dry chemical.
Fire fighting: Fire may produce small amounts of hazardous decomposition products such as carbon dioxide, carbon monoxide, and unidentified organics. NIOSH approved self-contained breathing apparatus may be required if a large volume of ink is involved.

Fire and Explosion Hazard: No unusual fire or explosion hazards are known for this product.
Hazardous Combustion Products: Oxides of carbon, organic acids, low molecular weight organics.

Section 7. Accidental Release Measures

Occupational Spill: Absorb small ink spills with cloth or paper towels or other suitable material. Place in a container for disposal. For large spills, dike around spill with absorbent material. Transfer contaminated diking material to separate, suitable containers for recovery or disposal. Ventilate area and wash spill site after material pickup is complete. Unless specifically permitted, keep waste out of sewers, watershed and waterways.

Section 8. Handling and Storage

STORE IN COOL, DRY PLACE

Section 9. Exposure Control/Personal Protection

Ventilation: Mechanical room ventilation
Eye Protection: None needed for intended use in printer.
Protective Clothing: None needed for intended use in printer.
Gloves: None needed for intended use in printer.

Section 10. Physical Chemical Characteristics

Description:	Black liquid with faint odor.	Freezing Point:	Approx. -12 to -150 °C
Pressurized:	No	pH:	7.0-8.5
Water Solubility:	Fully Miscible	Percent Volatile:	Approx. 18.7
Evaporation Rate (Butylacetate=1):	Approx. 3.5	Specific Gravity:	Approx. 1.0 mg/l
		Vapor Density (Air=1):	Approx. 1.6

Section 11. Stability and Reactivity

Stability: None known.
Incompatibilities: None known.
Thermal decomposition products: Oxides of carbon, acid gases, low molecular weight organics.
Hazardous polymerization: This product will not polymerize.

S H A R P

Revised date: _____

Issued date : Sep.19.2002

MATERIAL SAFETY DATA SHEET (3/3)

MSDS No. B-1028

Section 12. Toxicological Information

Acute Toxicity: Not expected to be acutely toxic; LD50 (oral, rat) expected to be >2000 mg/kg.
Chronic Toxicity: Not expected to be chronically toxic based on component information, volume, concentration, and intended use.
Pure carbon black, a minor component of this ink, has been listed by LARC as group 2B (possible carcinogen).
This classification is based on rat "lung particulate overload" studies performed with airborne particulate carbon black. Ink is not listed by LARC, NTP, or OSHA.
Carcinogenicity: OSHA Regulated(USA): Not listed
In 1996 the LARC reevaluated carbon black as a Group 2B carcinogen (possible human carcinogen). This evaluation is given to Carbon Black for which there is inadequate human evidence, but sufficient animal evidence. The latter is based upon the development of lung tumors in rats receiving chronic inhalation exposures to free carbon black at levels that induce particle overload of the lung.
Studies performed in animal models other than rats have not demonstrated an association between carbon black and lung tumors.

Section 13. Ecological Information

No data available.

Section 14. Disposal Consideration

This product is not a listed or hazardous waste in accordance with Federal Regulation 40 CFR Part 261. If discarded, this product would not be a hazardous waste either by listing or by characteristic. However, it is the responsibility of the product user to determine at the time of disposal whether a material has been contaminated and should be classified as a hazardous waste.
In accordance with RCRA 40 CFR Section 264.314 and 265.314, the placement of any liquid in landfills is prohibited.
Disposal is subject to local, state and federal regulations.

Section 15. Transport Information

DOT PROPER SHIPPING NAME: Not regulated as hazardous material.

Section 16. Regulatory Information

All ingredients are registered under the **Toxic Substances Control Act (TSCA)** or under polymer exemption. All ingredients are exempt, registered or considered registered (polymers) under the **European Inventory of Existing Commercial Chemical Substances(EINECS/ELINCS)**.
Preparation not classified as dangerous (**EU Directive 67/548/EEC;1999/45/EC**).
All ingredients are listed on or are considered polymers under the **Canadian Domestic Substances List (DSL) or Non Domestic Substances List (NDSL)**.
Note of the product ingredients are listed as **Emergency Planning and Community Right-to-Know Act (EPCRA)-Section 302: Extremely Hazardous Substances (EHS)**.
None of the product components are present above the minimum quantities of listed chemicals in **EPCRA Section 313 Supplier Notification**.
This product contains no known materials at levels which the State California has found to cause cancer, birth defects or other reproductive harm - **California Proposition 65**.

Section 17. Other Information

Restrictions: This information relates only to the specific material designated as supplied by the manufacturer. This information is supplied to us by the manufacturer and Sharp offers no warranties as to its accuracy and accepts no responsibilities for any typographical errors which may appear on these sheets. It is the responsibility of the user to determine the suitability of this product for each particular use.

Literature Reference:

LARC(1996): LARC monographs on the Evaluation of the Carcinogenic Risk of Chemicals to Humans, Vol.65, Printing Process and Printing Inks, Carbon Black and Some Nitro Compounds, Lyon, pp.149-261 H.Muhle, B.Bellmann, O.Creutzenberg, C.Dasenbrock, H.Ernst, R.Kilpper, J.C.MacKenzie, P.Morrow, U.Mohr, S.Takenaka, and R.Mermelstein(1991) Pulmonary Response to Toner upon Chronic Inhalation Exposure in Rats.
Fundamental and Applied Toxicology 17, pp.280-299

Quick Reference Guide

Sending Faxes

Place your document (up to 10 pages) face down in the document feeder.

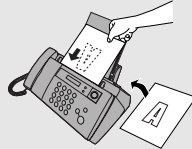



Normal Dialing

1. Lift the handset or press .
2. Dial the fax number.
3. Wait for the reception tone (if a person answers, ask them to press their Start key).

4. Press .

Automatic Dialing

1. Press  or  until the desired destination appears in the display.

2. Press .

Direct Keypad Dialing

1. Dial the fax number.

2. Press .

Receiving Faxes

Press  until the arrow in the display points to the desired reception mode.

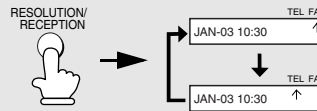



FAX mode: The fax machine automatically answers and receives faxes.

TEL mode: Answer all calls (even faxes) by picking up the handset. To begin fax

reception, press .

Storing Auto Dial Numbers

1. Press  once and  twice.

2. Enter the fax number.

3. Press .

4. Enter a name by pressing number keys. (To enter two letters in succession that

require the same key, press  after entering the first letter.)

SPACE = 1	G = 4	N = 6	U = 8
A = 2	H = 4	O = 6	V = 8
B = 2	I = 4	P = 7	W = 9
C = 2	J = 5	Q = 7	X = 9
D = 3	K = 5	R = 7	Y = 9
E = 3	L = 5	S = 7	Z = 9
F = 3	M = 6	T = 6	

5. Press  and then .

Guía de referencia rápida

Transmisión de documentos

Coloque el documento (hasta 10 páginas) mirando hacia abajo en el alimentador.

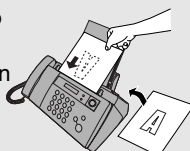

Marcación normal

1. Levante el auricular o pulse .
2. Marque el número de fax.
3. Espere a escuchar el tono de recepción (si alguien contesta al teléfono, pídale que pulse la tecla Inicio).
4. Pulse .

Marcación automática

1. Pulse o hasta que aparezcan los destinos deseados en pantalla.
2. Pulse .

Marcación directa por teclado

1. Marque el número de fax.
2. Pulse .

Recepción de documentos

Pulse hasta que la flecha de la pantalla señale el modo de recepción deseado.

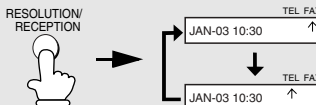

Modo FAX: El aparato de fax contestará y recibirá documentos automáticamente.

Modo TEL: Contesta todas las llamadas (incluso las de fax) levantando el auricular. Para que comience la recepción del

documento, pulse .

Programación de números de marcación automática

1. Pulse una vez y dos veces.
2. Introduzca el número de fax.
3. Pulse .
4. Introduzca un nombre pulsando las teclas numéricas. (Para introducir dos letras sucesivas que requieran la misma tecla, pulse después de introducir la primera letra).

ESPACIO =	G =	N =	U =
A =	H =	O =	V =
B =	I =	P =	W =
C =	J =	Q =	X =
D =	K =	R =	Y =
E =	L =	S =	Z =
F =	M =	T =	

5. Pulse y, a continuación, .

Index

A

- Anti Junk Fax, 68
- Audible signals, 88
- Auto-dial numbers
 - Storing, 40
 - Using, 44

B

- Batch page numbering, 47
- Broadcasting, 48

C

- Caller ID, 61-65
- Caller ID List, 71
- Contrast, 36
- Copies, 58
- Copy cut-off setting, 59

D

- Date, setting, 26-27
- Daylight Saving Time, 27
- Dial mode, 23
- Dialing
 - Automatic, 44
 - Direct Keypad, 45
 - Normal, 39
- Direct Keypad Dialing, 45
- Display messages, 62, 86
- Distinctive ring, 66
- Document feeder, 34
- Document guides, 34
- Document restrictions, 34
- Document sizes, 33
- Document, maximum scanning size, 33

E

- End beep off, 31
- Error beep off, 31
- Extension telephone
 - Using, 54

F

- FAX reception mode, 28, 51
- Fax Signal Receive, 55
- Fine resolution priority, 38

H

- Halftone setting, 36
- Handset, 11
- Handset receiver volume, 30
- High quality copy setting, 60
- High quality fax print setting, 22
- Hold, 54
- Housing, cleaning, 76

J

- Jams, clearing, 89

K

- Key tone off, 32

L

- Letters, entering, 25, 41
- Line error, 82
- Loading paper, 13
- Loading the document, 34

M

- Memory transmission, 49
- Memory, substitute reception to, 57

N

- Normal dialing, 39
- Number of rings in FAX reception mode, 51

O

- Ordering parts, 91

P

- Page numbering, batch, 47
- Paper feed roller, cleaning, 76
- Paper jams, clearing, 89
- Paper size setting, 20
- Paper trays, 12
- Paper, loading, 13
- Polling, 69
- Power cord, 14
- Print cartridge
 - Aligning, 77-78
 - Cleaning nozzles, 78
 - Installing, 15-20
 - Wiping nozzles, 80
- Print cartridge holder, wiping, 81
- Priority Call, 64

Q

- Quality mode, 21

R

- Reception mode
 - FAX mode, 28, 51

- TEL mode, 28, 52
- Reception Ratio setting, 56
- Redialing, 46
- Removing original document, 35
- Resolution, 36
- Ringer volume, 30

S

- Scanning glass, cleaning, 74
- Sender's name and number, entering,
24-25
- Setup List, 71
- Speaker volume, 29

T

- TEL reception mode, 28, 52
- TEL. LINE jack, 23
- Telephone line cord, 23
- Telephone Number List, 71
- Time, setting, 26-27
- Transaction Report, 72
 - Setting print condition, 73

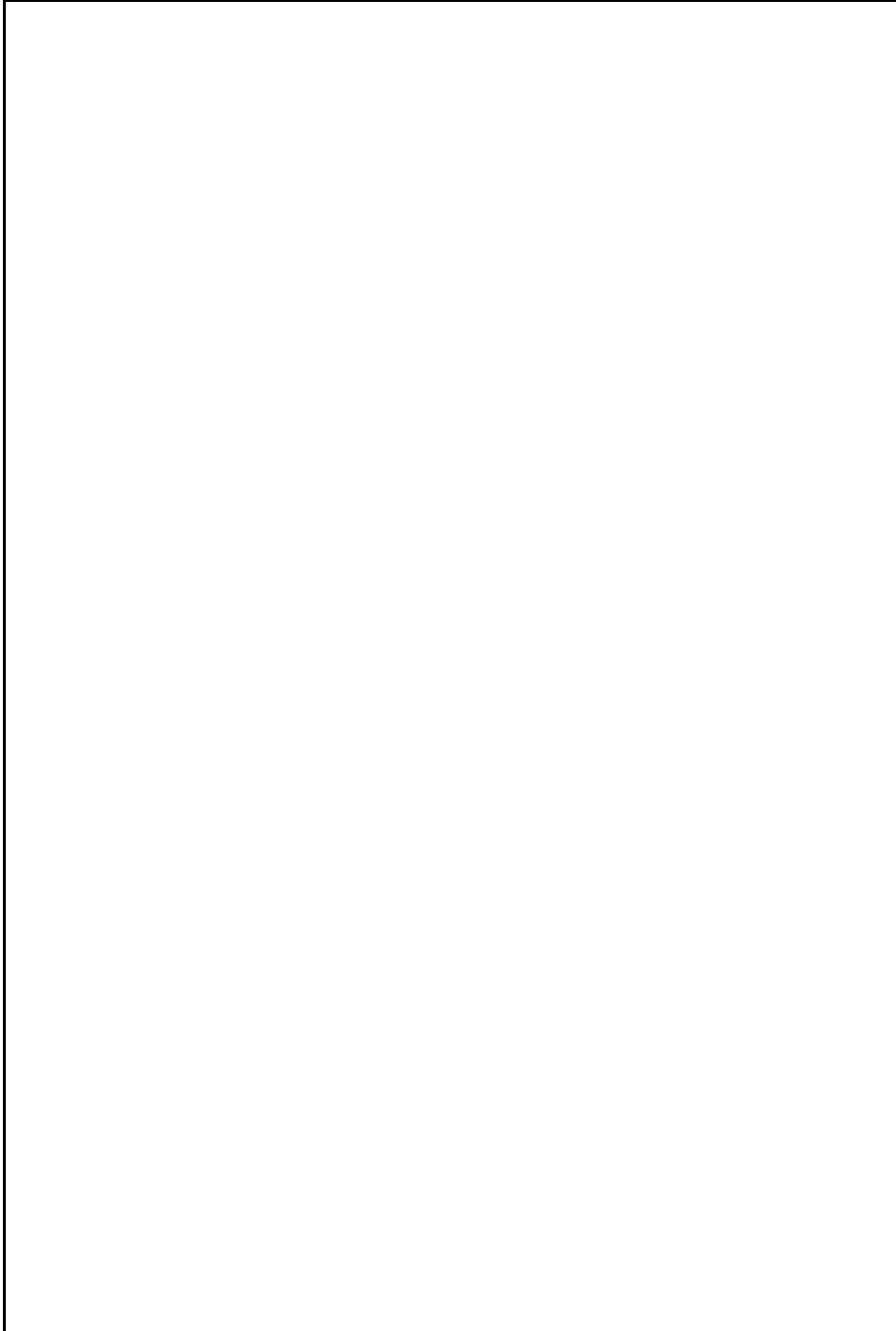

LIMITED WARRANTY

SHARP ELECTRONICS CORPORATION warrants to the first end user purchaser that this Sharp brand product (the "Product"), when shipped in its original container, will be free from defective workmanship and materials, and agrees that it will, at its option, either repair the defect or replace the defective Product or part thereof with a new or remanufactured equivalent at no charge to the purchaser for parts or labor for the period(s) set forth below.

This warranty does not apply to any appearance items of the Product nor to the additional excluded item(s) set forth below nor to any product the exterior of which has been damaged or defaced, which has been subjected to misuse, abnormal service or handling, or which has been altered or modified in design or construction.

In order to enforce the rights under this limited warranty, the purchaser should follow the steps set forth below and provided proof of purchase to the servicer.

To the extent permitted by applicable state law, the warranties set forth herein are in lieu of, and exclusive of, all other warranties, express or implied. Specifically, ALL OTHER WARRANTIES OTHER THAN THOSE SET FORTH ABOVE ARE EXCLUDED. ALL EXPRESS AND IMPLIED WARRANTIES INCLUDING THE WARRANTIES OF MERCHANTABILITY, FITNESS FOR USE, AND FITNESS FOR A PARTICULAR PURPOSE ARE SPECIFICALLY EXCLUDED. If, under applicable state law, implied warranties may not validly be disclaimed or excluded, the duration of such implied warranties is limited to the period(s) from the date of purchase set forth below.

Neither the sales personnel of the seller nor any other person is authorized to make any warranties other than those described above, or to extend the duration of any warranties beyond the time period described above on behalf of Sharp.

The warranties described herein shall be the sole and exclusive warranties granted by Sharp and shall be the sole and exclusive remedy available to the purchaser. Correction of defects, in the manner and for the period of time described herein, shall constitute complete fulfillment of all liabilities and responsibilities of Sharp to the purchaser with respect to the Product, and shall constitute full satisfaction of all claims, whether based on contract, negligence, strict liability or otherwise. In no event shall Sharp be liable, or in any way responsible, for any damages or defects in the Product which were caused by repairs or attempted repairs performed by anyone other than an authorized servicer. Nor shall Sharp be liable or in any way responsible for any incidental or consequential economic or property damage. Some states do not allow limits on warranties or on remedies for breach in certain transactions; in such state the limits herein may not apply.

<u>Your Product:</u>	Personal Facsimile
<u>Warranty Period for this Product:</u>	Ninety (90) days parts and labor from date of purchase.
<u>Additional items excluded from warranty coverage:</u>	Any consumable items such as paper supplied with the Product.
<u>Where to obtain service:</u>	At a Sharp Authorized Servicer located in the United States. To find out the location of the nearest Sharp Authorized Servicer, call Sharp toll free at 1-800-BE-SHARP.
<u>What to do to obtain service:</u>	Ship (prepaid) or carry in your Product to a Sharp Authorized Servicer. Be sure to have proof of purchase available. If you ship or mail the Product, be sure it is packaged carefully.

For product information or customer assistance, please visit <http://www.sharppusa.com> on the World Wide Web or call **1-800-BE SHARP**.

SHARP ELECTRONICS CORPORATION

Sharp Plaza,
Mahwah, New Jersey 07430-1163

SHARP®

SHARP ELECTRONICS CORPORATION

Sharp Plaza, Mahwah, New Jersey 07430-1163
<http://www.sharpusa.com>

SHARP CORPORATION

FOR YOUR RECORDS

Please record the model number and serial number below, for easy reference, in case of loss or theft. These numbers are located on the rear side of the unit. Space is also provided for other relevant information.

Model Number UX-B20
Serial Number _____
Date of Purchase _____
Place of Purchase _____

PRINTED IN THAILAND
(TINSE4427XHTZ)

Free Manuals Download Website

<http://myh66.com>

<http://usermanuals.us>

<http://www.somanuals.com>

<http://www.4manuals.cc>

<http://www.manual-lib.com>

<http://www.404manual.com>

<http://www.luxmanual.com>

<http://aubethermostatmanual.com>

Golf course search by state

<http://golfingnear.com>

Email search by domain

<http://emailbydomain.com>

Auto manuals search

<http://auto.somanuals.com>

TV manuals search

<http://tv.somanuals.com>