

# SHARP®

MODEL  
**FO-DC550**

## OPERATION MANUAL (for facsimile)

	Page
• <b>INSTALLATION</b> .....	<b>11</b>
• <b>INITIAL SETTINGS</b> .....	<b>13</b>
• <b>CHOOSING SUITABLE MEDIA</b> .....	<b>50</b>
• <b>HOW TO USE THE FAX FUNCTION</b> .....	<b>52</b>
• <b>SPECIAL FUNCTIONS</b> .....	<b>67</b>
• <b>TROUBLESHOOTING</b> .....	<b>85</b>
• <b>APPENDIX</b> .....	<b>92</b>

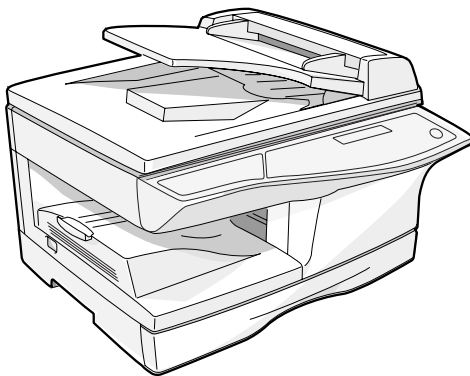

**For users in the USA**

This device complies with Part 15 of the FCC rules. Operation is subject to the following two conditions: (1) This device may not cause harmful interference, and (2) this device must accept any interference received, including interference that may cause undesired operation.

**WARNING:**

FCC Regulations state that any unauthorized changes or modifications to this equipment not expressly approved by the manufacturer could void the user's authority to operate this equipment.

**Note:**

This equipment has been tested and found to comply with the limits for a Class B digital device, pursuant to Part 15 of the FCC Rules. These limits are designed to provide reasonable protection against harmful interference in a residential installation. This equipment generates, uses and can radiate radio frequency energy and, if not installed and used in accordance with the instructions, may cause harmful interference to radio communications.

However, there is no guarantee that interference will not occur in a particular installation. If this equipment does cause harmful interference to radio or television reception, which can be determined by turning the equipment off and on, the user is encouraged to try to correct the interference by one or more of the following measures:

- Reorient or relocate the receiving antenna.
- Increase the separation between the equipment and receiver.
- Connect the equipment into an outlet on a circuit different from that to which the receiver is connected.
- Consult the dealer or an experienced radio/TV technician for help.

---

**Caution**

- Use only the line cable that was provided with the machine.
- To reduce the risk of fire, use only UL-Listed No.26 AWG or larger telecommunication line cord.

---

**Note**

- This manual describes how to use the fax function of the machine. Part names and functions shared with the copy function (for example, the misfeed indicator and add paper indicator), are described in the Operation Manual (for general information). For more information, please read the Operation Manual (for general information).
- This operation manual refers to the Reversing Single Pass Feeder as the "RSPF".

---

---

# INTRODUCTION

## TYPE OF SERVICE

This equipment may not be used on coin service provided by the telephone company. Connection to party lines service is subject to state tariffs. Contact your state's public utility commission, public service commission, or corporation commission for more information.

## ABOUT THE TELEPHONE CONSUMER PROTECTION ACT OF 1991

The Telephone Consumer Protection Act of 1991 makes it unlawful for any person to use a computer or other electronic device, including FAX machines, to send any message unless such message clearly contains in a margin at the top or bottom of each transmitted page or on the first page of the transmission, the date and time it is sent and an identification of the business or other entity, or other individual sending the message and the telephone number of the sending machine or such business, other entity, or individual.

(The telephone number provided may not be a 900 number or any other number for which charges exceed local or long-distance transmission charges.)

In order to program this information into your FAX machine, you should complete the following steps:  
See page 21 of this Operation Manual.

## Important safety information

- If any of your telephone equipment is not operating properly, you should immediately remove it from your telephone line, as it may cause harm to the telephone network.
- The AC power outlet shall be installed near the equipment and shall be easily accessible.
- Never install telephone wiring during a lightning storm.
- Never install telephone jacks in wet locations unless the jack is specifically designed for wet locations.
- Never touch uninsulated telephone wires or terminals unless the telephone line has been disconnected at the network interface.
- Use caution when installing or modifying telephone lines.
- Avoid using a telephone (other than a cordless type) during an electrical storm. There may be a remote risk of electric shock from lightning.
- Do not use a telephone to report a gas leak in the vicinity of the leak.
- Do not install or use the machine near water, or when you are wet. Take care not to spill any liquids on the machine.

---

## **FCC Notice to users:**

This equipment complies with Part 68 of the FCC rules and the requirements adopted by the ACTA. On this equipment is a label that contains, among other information, a product identifier in the format US:AAAEQ##TXXXX.

If requested, this number must be provided to the telephone company.

The REN is used to determine the number of devices that may be connected to a telephone line.

Excessive RENs on a telephone line may result in the devices not ringing in response to an incoming call.

In most but not all areas, the sum of RENs should not exceed five (5.0).

To be certain of the number of devices that may be connected to a line, as determined by the total RENs, contact the local telephone company.

For products approved after July 23, 2001, the REN for this product is part of the product identifier that has the format US:AAAEQ##TXXXX.

The digits represented by ## are the REN without a decimal point (e.g., 03 is a REN of 0.3).

For earlier products, the REN is separately shown on the label.

If this equipment causes harm to the telephone network, your telephone company may disconnect your service temporarily. If possible, They will notify you in advance. If advance notice is not practical, you will be notified as soon as possible. You will also be advised of your right to file a complaint with the FCC.

Your telephone company may make changes in its facilities, equipment, operations, or procedures that could affect the operation of your equipment. If this happens, the telephone company will provide advance notice in order for you to make necessary modifications to maintain uninterrupted service. If the equipment is causing harm to the telephone network, your telephone company may ask you to disconnect the equipment until the problem is resolved.

If you have any questions or problems which cannot be solved by reading this manual, please contact

<p><b>Sharp Electronics Corporation</b> P.O. Box 650 Mahwah, NJ 07430-1163 Telephone: 1-800-BE-SHARP</p>
--

A plug and jack used to connect this equipment to the premises wiring and telephone network must comply with the applicable FCC Part 68 rules and requirements adopted by the ACTA.

A compliant telephone cord and modular plug is provided with this product.

It is designed to be connected to a compatible modular jack that is also compliant. See installation instructions for details.

This equipment connects to the telephone network through a standard USOC RJ-11C network interface jack.

If your home has specially wired alarm equipment connected to the telephone line, ensure the installation of this equipment does not disable your alarm equipment.

If you have questions about what will disable alarm equipment, consult your telephone company or a qualified installer.

---

---

# TABLE OF CONTENTS

INTRODUCTION.....	i
QUICK REFERENCE GUIDE .....	3
LIST OF FAX FUNCTIONS.....	6

## **1** INSTALLATION

<b>CONNECTIONS</b> .....	11
● CONNECTING THE TELEPHONE LINE CORD ...	11
<b>FINAL PREPARATIONS</b> .....	12
● CONNECTING OTHER DEVICES .....	12

## **2** INITIAL SETTINGS

<b>PART NAMES</b> .....	13
<b>A LOOK AT THE FAX OPERATION PANEL</b> .....	14
<b>ABOUT THE LIQUID CRYSTAL DISPLAY</b> ....	16
<b>USING THE ARROW KEYS</b> .....	16
<b>ADJUSTING THE RINGING VOLUME</b> .....	17
<b>SETTING THE LENGTH OF ALARM BEEPS</b> ....	18
<b>ADJUSTING THE ALARM BEEP VOLUME</b> ..	19
<b>FAX SETUP</b> .....	20
● HOW TO ENTER CHARACTERS .....	20
● ENTERING YOUR NAME AND FAX NUMBER....	21
● SETTING THE DATE AND TIME .....	22
● SELECTING THE TRANSMISSION MODE ..	26
● SELECTING THE RECEPTION MODE.....	27
● SETTING THE NUMBER OF RINGS FOR AUTO RECEPTION .....	28
● SETTING THE NUMBER OF RINGS FOR MANUAL RECEPTION .....	29
● SELECTING THE RECEPTION PAPER SIZE ..	29
● SETTING THE TRAY SELECTION .....	30
● SETTING THE DIAL MODE .....	31
● SETTING THE NUMBER OF RECALL TIMES .....	32
● SETTING THE RECALL INTERVAL.....	34
● SETTING THE INDEX FUNCTION.....	36
● SETTING RESOLUTION PRIORITY .....	37
● SETTING UP THE MACHINE FOR USE WITH A PC MODEM.....	38
● USING THE REMOTE RECEPTION FUNCTION .....	39
● DISTINCTIVE RINGING .....	41
● STORING NUMBERS FOR AUTOMATIC DIALING.....	42
● STORING NUMBERS UNDER GROUP KEYS .....	45

<b>USING THE MACHINE WITH AN ANSWERING MACHINE</b> .....	48
● QUIET DETECT TIME .....	48
● ANSWERING MACHINE BACKUP.....	49

## **3** CHOOSING SUITABLE MEDIA

<b>ORIGINALS SUITABLE FOR FAXING</b> .....	50
● SIZE AND WEIGHT .....	50
● UNSUITABLE ORIGINALS.....	51

## **4** HOW TO USE THE FAX FUNCTION

<b>SENDING ORIGINALS</b> .....	<b>52</b>
● SETTING THE ORIGINAL .....	52
<b>OPTIONAL TRANSMISSION SETTINGS</b> .....	<b>54</b>
● ORIGINAL SIZE .....	54
● RESOLUTION .....	55
● CONTRAST .....	55
● COVER SHEET .....	56
● MESSAGE FUNCTION .....	57
● TWO-SIDED ORIGINAL TRANSMISSION FUNCTION .....	58
<b>DIALING AND TRANSMITTING</b> .....	<b>59</b>
● DIRECT KEYPAD DIALING .....	59
● RAPID KEY DIALING .....	59
● SPEED DIALING .....	59
● CHAIN DIALING .....	60
● NORMAL DIALING USING THE [SPEAKER] KEY .....	60
● USING THE SEARCH KEY .....	61
● REDIALING .....	61
<b>IF THE MEMORY BECOMES FULL WHILE SCANNING AN ORIGINAL</b> .....	<b>62</b>
<b>CANCELING (DELETING) A STORED FAX JOB</b> ..	<b>62</b>
<b>RECEIVING FAXES</b> .....	<b>63</b>
● USING AUTO MODE .....	63
● USING MAN. MODE .....	63
● USING A.M. MODE .....	63
<b>OPTIONAL RECEPTION SETTINGS</b> .....	<b>64</b>
● TWO-SIDED RECEPTION .....	64
● RECEIVE REDUCE .....	65
<b>WHEN USING MANUAL SENDING AND RECEIVING</b> .....	<b>66</b>

## **5** SPECIAL FUNCTIONS

<b>MEMORY</b> .....	<b>67</b>
<b>PRINT HOLD MODE</b> .....	<b>67</b>
● ENABLING PRINT HOLD MODE .....	67
● PRINT PASSCODE .....	68
● HOLD DATA PRINT .....	69
<b>TRANSMISSION RESERVATION</b> .....	<b>70</b>
<b>BROADCASTING</b> .....	<b>71</b>
<b>POLLING</b> .....	<b>73</b>
● POLLING .....	73
● SERIAL POLLING .....	74
● POLLING TRANSMISSION (MEMORY POLLING) .....	75
● RESTRICTING POLLING MACHINES (POLLING SECURITY) .....	77
<b>TIMER OPERATIONS</b> .....	<b>79</b>
● CANCELING A TIMER TRANSMISSION JOB	80
<b>ANTI JUNK FAX</b> .....	<b>81</b>
<b>OPERATION IN COPY, PRINTER, SCANNER, AND FAX MODES</b> .....	<b>84</b>

## **6** TROUBLESHOOTING

<b>PRINTING OUT REPORTS</b> .....	<b>85</b>
● ACTIVITY REPORT AUTO LISTING .....	88
● PRINTING TRANSACTION REPORTS .....	89
<b>TROUBLESHOOTING</b> .....	<b>90</b>
<b>MESSAGES AND SIGNALS</b> .....	<b>91</b>
● DISPLAY MESSAGES .....	91
● AUDIBLE SIGNALS .....	91

## **7** APPENDIX

<b>SPECIFICATIONS</b> .....	<b>92</b>
<b>INDEX</b> .....	<b>93</b>

---

---

# QUICK REFERENCE GUIDE

The following quick reference guide provides brief explanations the operation of the machine.

## Selecting the transmission mode (p.26)

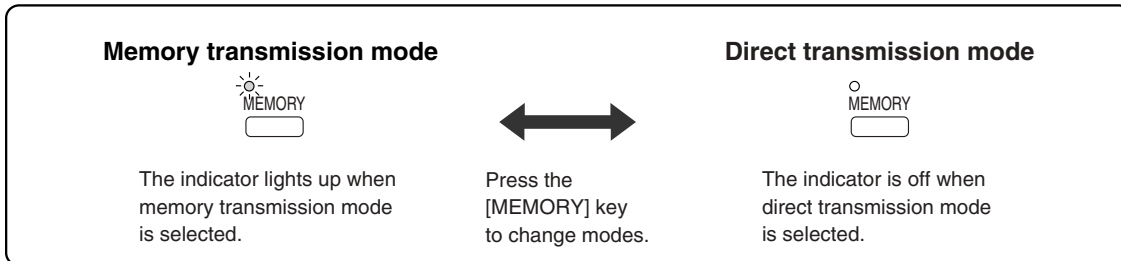



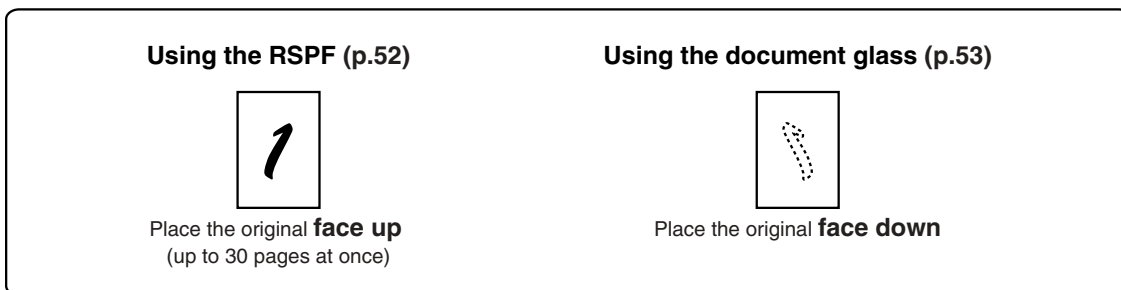

## Place the original

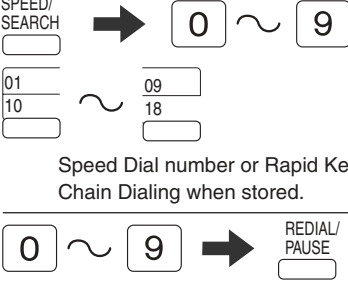
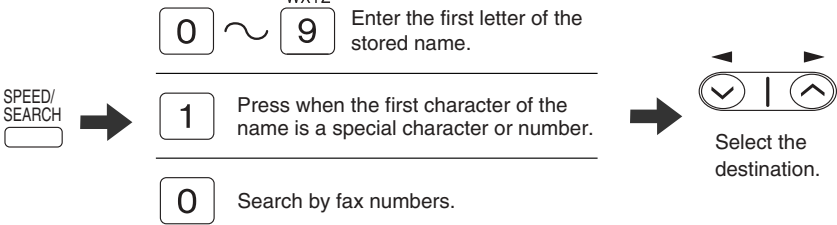

# Sending a fax

## Dialing methods

<b>Direct Dialing</b> (p.59)	 Press the numeric keys to dial.
<b>Speed Dialing</b> (p.59)	 Enter a two-digit Speed Dial number.
<b>Rapid Key Dialing</b> (p.59)	 * It is not necessary to press the [START] key after pressing a Rapid Key.
<b>Chain Dialing</b> (p.60)	 <p>Speed Dial number or Rapid Key set for Chain Dialing when stored.</p> <p>Dial with the numeric keys and then press the [REDIAL/PAUSE] key.</p> <p>Dial the next part of the number (a Group Key cannot be used).</p>
<b>Search Dialing</b> (p.61)	 <p>Enter the first letter of the stored name.</p> <p>Press when the first character of the name is a special character or number.</p> <p>Search by fax numbers.</p> <p>Select the destination.</p>
<b>Redialing</b> (p.61)	 Redial the last number dialed.

## Sending a fax

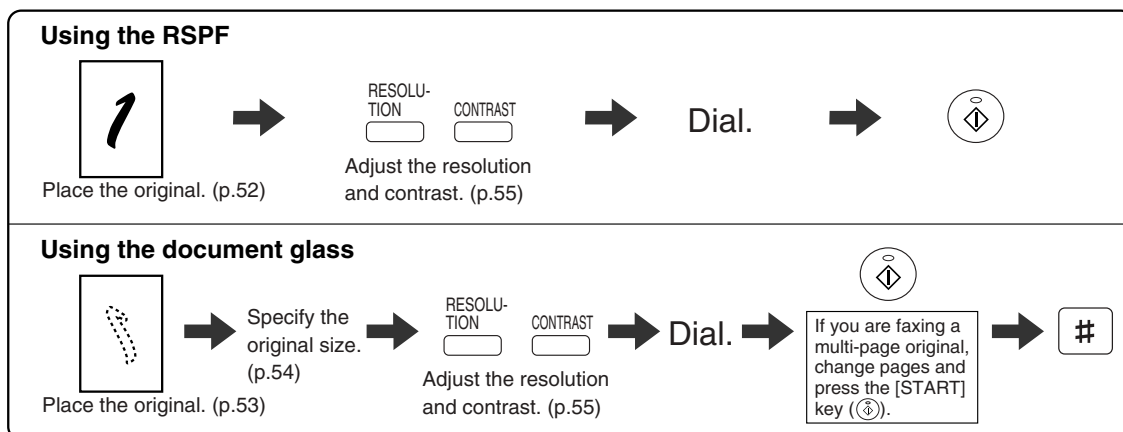



## Sending a fax to multiple destinations (Broadcasting) (p.71)

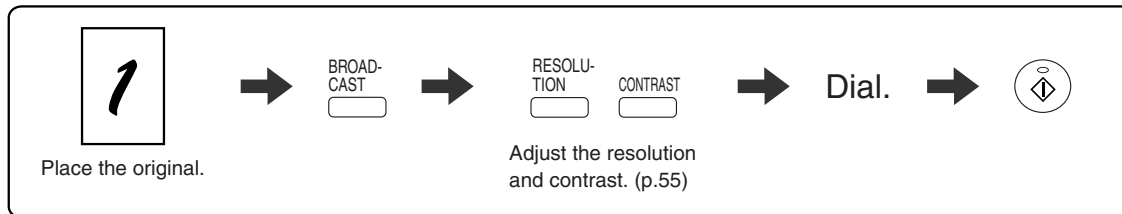

## Storing a fax job while another job is in progress

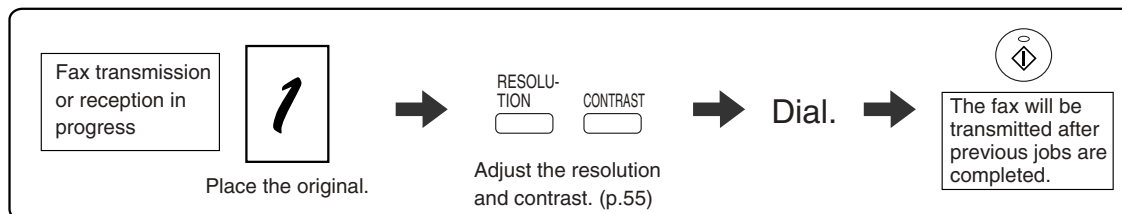

## Automatically sending a fax at a specified time (timer transmission)

To set up a timer transmission, see "TIMER OPERATIONS" (p.79).

## Receiving a fax

### Selecting the reception mode (p.63)

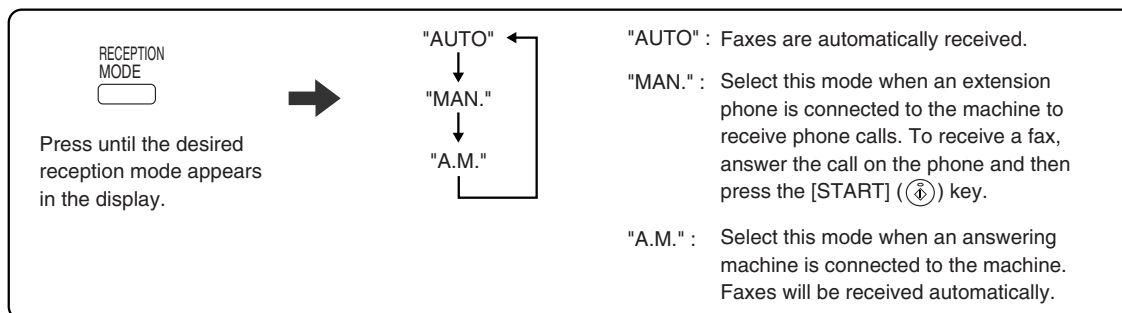

### Calling a fax machine and requesting automatic transmission of an original placed in that machine (p.73)

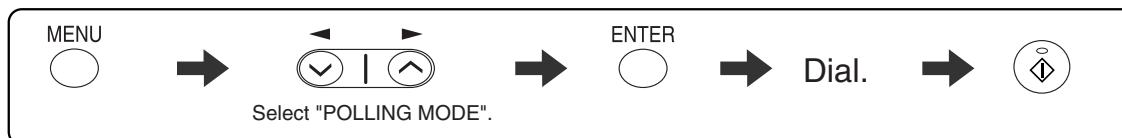

\* Another fax machine can also call your fax machine and request automatic transmission of an original placed in your machine. For this to take place, the reception mode of your machine must be set to "AUTO".

# LIST OF FAX FUNCTIONS

The FAX MAIN MENU is used to configure settings for the fax function and program information such as the fax number of the machine. The settings in the FAX MAIN MENU are shown below.  
The procedure for configuring settings is explained in "SELECTING SETTINGS FOR THE FUNCTION" (p.10).

Menu item	Settings (factory default setting appears in bold)	Page
<b>0 : HOLD DATA PRINT</b>	When "24 : PRINT HOLD MODE" in "4 : USER PROGRAM" is enabled, this function is used to print received faxes that are held in memory. To print faxes held in memory, the passcode that was programmed using "25 : PRINT PASSCODE" in "4 : USER PROGRAM" must be entered.	69
<b>1 : TIMER MODE</b>		
1 : SET	Set up a transmission or polling job to take place automatically at a specified time.	79
2 : CLEAR	Cancel a timer transmission job.	79
<b>2 : ENTRY MODE</b>		
1 : FAX NUMBER	Store (or delete) fax numbers in Rapid Keys, Speed Dial numbers, and Group Keys. 1 : RAPID KEY 2 : SPEED # 3 : GROUP KEY	42, 44, 45, 47
2 : DATE&TIME SET	Set the date and time in the machine.	22
3 : OWN PASSCODE SET	Program the name and phone number of the user of the machine.	21
4 : PASSCODE # MODE	Store fax numbers that are allowed to poll the machine when polling security is used.	78
5 : DAY LIGHT SAVING	Enable automatic adjustment of the clock at the beginning and end of daylight savings time.	25
<b>3 : MEMORY STATUS</b>	Check and delete stored fax jobs waiting for transmission and automatic recall jobs.	62
<b>4 : USER PROGRAM</b>		
1 : DOC. GLASS SIZE	Set the size of an original faxed from the document glass. 1 : <b>8.5x11</b> 2 : 8.5x14 3 : A4	54
2 : FIXED DOC. SIZE	Set the default size of originals faxed from the document glass. 1 : <b>8.5x11</b> 2 : 8.5x14 3 : A4	54
3 : RESO. PRIORITY	Set the default resolution for fax transmission. 1 : <b>STANDARD</b> 2 : FINE 3 : SUPER FINE	37
4 : # OF RINGS (AUTO)	Set the number of rings on which the machine answers calls in automatic reception mode. 0 - 9 (2)	28
5 : # OF RINGS (MANUAL)	Set the number of rings on which the machine answers calls in manual reception mode. 0 - 9 (0)	29

Menu item	Settings (factory default setting appears in bold)	Page
6 : AUTO LISTING	Enable automatic printing of the Activity Report when information on a total of 50 fax transmissions/receptions accumulates. 1 : ON <b>2 : OFF</b>	88
7 : PRINT SELECTION	1 : TRANSMISSION Select the condition for printing reports on fax transmissions. 1 : ALWAYS PRINTS <b>2 : ERROR ONLY</b> 3 : NEVER PRINTS	89
	2 : BROADCAST Select the condition for printing reports on broadcast transmissions. <b>1 : ALWAYS PRINTS</b> 2 : ERROR ONLY 3 : NEVER PRINTS	89
	3 : RECEPTION Select the condition for printing reports on received faxes. 1 : ALWAYS PRINTS 2 : ERROR ONLY <b>3 : NEVER PRINTS</b>	89
	4 : IMAGE MEM. PRINT Enable printing of the original image on transaction reports. 1 : ALWAYS PRINTS <b>2 : ERROR ONLY</b> 3 : NEVER PRINTS	89
8 : RECALL TIMES BUSY	Set the number of recall attempts that are made when the line is busy. 00 - 14 ( <b>02</b> )	32
9 : RECALL TIMES ERR	Set the number of recall attempts that are made when a communication error occurs. 0 - 1 ( <b>1</b> )	33
10 : RECALL INT. BUSY	Set the interval between recall attempts when the line is busy. 1 to 15 minutes can be selected. 01 - 15 min. ( <b>03 min.</b> )	34
11 : RECALL INT. ERR	Set the interval between recall attempts when a communication error occurs. 0 to 15 minutes can be selected. 00 - 15 min. ( <b>01 min.</b> )	35
12 : SECURITY SELECT	Enable the polling security function. <b>1 : ON</b> 2 : OFF	77
13 : FAX REMOTE NUMBER	Set the 1-digit number used to activate remote fax reception. 0 - 9 ( <b>5</b> )	40
14 : REMOTE RECEPTION	Enable the remote reception function. <b>1 : ON</b> 2 : OFF	39
15 : FAX SIGNAL RCV	Enable automatic fax reception when a fax tone is heard after answering a call on an extension phone. <b>1 : ON</b> 2 : OFF	38

Menu item	Settings (factory default setting appears in bold)	Page
16 : RCV REDUCE	When a fax is received that is larger than the printing paper, enable reduction of the fax to the size of the paper to avoid the fax being cut off. <b>1 : ON</b> 2 : OFF	65
17 : BEEP LENGTH	Set the length of the beep that sounds when fax transmission or reception ends. <b>1 : 3 SEC</b> 2 : 1 SEC 3 : NO BEEP	18
18 : RINGER VOLUME	Set the volume of the ringer. 1 : OFF 2 : LOW <b>3 : MIDDLE</b> 4 : HIGH	17
19 : BEEPER VOLUME	Set the volume of the beep that sounds when a key is pressed. 1 : OFF <b>2 : LOW</b> 3 : MIDDLE 4 : HIGH	19
20 : DIAL MODE	Set the dial mode for the type of line you are on. <b>1 : TONE</b> 2 : PULSE	31
21 : DISTINCTIVE RING	Set the ring pattern for distinctive ring. <b>1 : OFF</b> 2 : STANDARD 3 : PATTERN 1 4 : PATTERN 2 5 : PATTERN 3 6 : PATTERN 4 7 : PATTERN 5	41
22 : INDEX PRINT	Enable printing of a black mark (index) at the top of each received fax page. 1 : ON <b>2 : OFF</b>	36
23 : DATE&TIME FORMAT	1 : TIME FORMAT Select 12-hour or 24-hour format for the time set in the machine. <b>1 : 12 HOUR</b> 2 : 24 HOUR	23
	2 : DATE FORMAT Set the format of the date in the display and in printouts. <b>1 : MMDDYYYY</b> 2 : DDMMYYYY 3 : YYYYMMDD	24
24 : PRINT HOLD MODE	When this mode is enabled, received faxes are held in the memory of the machine instead of being printed out. To print received faxes, the passcode that was programmed using "25 : PRINT PASSCODE" must be entered. This mode is used to ensure that received faxes are not misplaced or taken from the paper output tray by another person. Use "0 : HOLD DATA PRINT" to print received faxes. 1 : ON <b>2 : OFF</b>	67

Menu item	Settings (factory default setting appears in bold)	Page
25 : PRINT PASSCODE	This setting is used to program the passcode that is required when "24 : PRINT HOLD MODE" is enabled. When printing received faxes with "0 : HOLD DATA PRINT", you will be prompted to enter the passcode that is programmed here. 1 : SET 2 : CLEAR	68
26 : 2-SIDED RX	Print on both sides of the paper when a multi-page fax is received. 1 : ON 2 : <b>OFF</b>	64
27 : TRAY SELECTION (When the 250-sheet paper feed unit is installed.)	Set the tray for printing received faxes. 1 : <b>AUTO</b> 2 : TRAY 1 3 : TRAY 2	30
<b>5 : ANTI JUNK FAX</b>		
1 : ANTI JUNK SELECT	Enable the anti junk function to block fax reception from specified fax numbers. 1 : ON 2 : <b>OFF</b>	81
2 : JUNK FAX #	Program (or delete) fax numbers from which fax reception is to be blocked. 1 : SET 2 : CLEAR	82
<b>6 : A.M. MODE</b>		
1 : QUIET DETECT TIME	Activate fax reception when a period of silence longer than the set time is detected. 00 - 10 ( <b>05</b> )	48
2 : AUTO RECEIVE	Enable fax reception when the answering machine is full and cannot receive messages or otherwise fails. 1 : ON 2 : <b>OFF</b>	49
<b>7 : MEMORY POLL MODE</b>		
1 : 1 TIME	Perform polling transmission once.	75
2 : REPEAT	Perform polling transmission repeatedly.	75
<b>8 : POLLING MODE</b>	Poll another fax machine.	73
<b>9 : SERIAL POLL MODE</b>	Sequentially poll multiple fax machines.	74

# SELECTING SETTINGS FOR THE FUNCTION

The general procedure for configuring settings for the fax function is explained below. Follow this procedure to configure the settings explained on pages 6 through 9.



An item can also be selected after pressing the [MENU] key by pressing the numeric key for the item (the key corresponding to the number that appears in front of the item). When the numeric key is pressed, the item is selected or entered.

## 1 Press the [MODE SELECT] key to select fax mode.

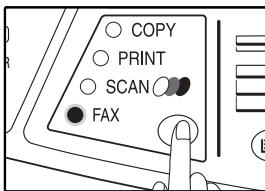

The "FAX" indicator lights up to indicate that fax mode is selected.

## 2 Press the [MENU] key.

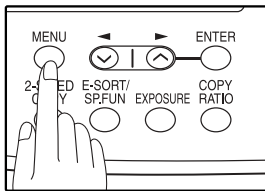

"FAX MAIN MANU" will appear in the display.

## 3 Press the [◀] key (⏪) or [▶] key (⏩) to select a menu item and press the [ENTER] key.

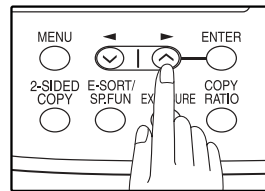

The item is selected. Repeat this step until the item that you wish to configure appears.

## 4 Select a setting or enter information.

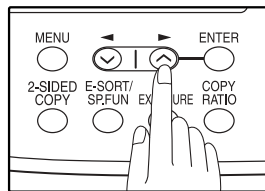

**To select a setting:** Press the [◀] key (⏪) or [▶] key (⏩) until the setting is selected.

**To enter information:** Press the numeric keys to enter characters or numbers.



- If you mistakenly select the wrong item, press the [CLEAR] key (⏴) and repeat the procedure from step 2.
- To cancel a setting for a fax function, press the [MENU] key.

## 5 Press the [ENTER] key.

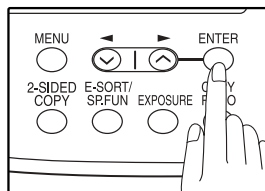

The setting or information is entered.

## 6 Press the [MENU] key.

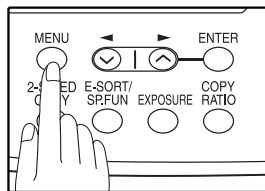

Press the [MENU] key to exit.

# 1

## Chapter 1 INSTALLATION

### CONNECTIONS

#### CONNECTING THE TELEPHONE LINE CORD

Plug one end of the telephone line cord into the jack on the machine marked "LINE." Plug the other side into a standard (RJ11C) single-line telephone wall jack. Be sure not to plug this telephone line cord into the "TEL" jack. The "TEL" jack is used to attach an extension telephone or answering machine to the machine. (See "CONNECTING OTHER DEVICES" (p.12))



If your area experiences a high incidence of lightning or power surges, we recommend that you install surge protectors for the power and telephone lines. Surge protectors can be purchased from your retailer or at most telephone specialty stores.

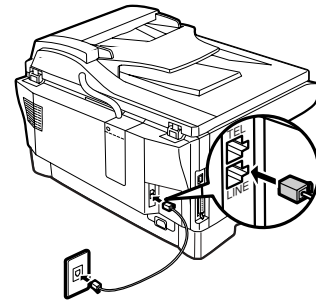

#### ABOUT THE OPERATION MANUALS

The operation manuals for the machine are as follows:

##### Operation Manual (for general information)

Explains the machine and how to use it as a copier. Also explains how to install the software that allows the machine to be used as a printer and scanner for your computer.

The following information is contained in the operation manual for the machine :

OPERATION MANUAL contents	Page
CAUTIONS	3
PART NAMES	9
POWER ON AND OFF	12
LOADING THE PAPER TRAY	15
BYPASS FEED (including special paper)	17

OPERATION MANUAL contents	Page
CHANGING A TRAY'S PAPER SIZE SETTING	19
MISFEED REMOVAL	79
TD CARTRIDGE REPLACEMENT	84
DRUM CARTRIDGE REPLACEMENT	87
CHECKING THE TOTAL COUNT	88
CLEANING THE MACHINE	89

##### Online Manual (on the CD-ROM)

This manual explains the procedures for using the machine as a printer and a scanner.

---

---

# FINAL PREPARATIONS

## CONNECTING OTHER DEVICES

If desired, an answering machine or external telephone can be connected to the machine through the telephone jack, labeled "TEL," on the rear of the machine.

- Connecting an answering machine to the machine allows you to receive both voice and fax messages when you are out. To use this feature, first change the outgoing message of your answering machine, and then set the reception mode of the machine to "A.M." (Answering Machine mode) when you go out.



If you are using distinctive ringing with an answering machine, you do not need to follow the procedure described below. (Please note that when distinctive ringing is used, the answering machine must be distinctive ring compatible.)

### Comments:

1. It is advisable to keep the length of the message under 10 seconds. If it is too long, you may have difficulty receiving faxes sent by automatic dialing.
  2. Your callers can even leave a voice message and send a fax message on the same call. Modify your outgoing message to explain that this can be done by pressing their [START] key (Ⓜ) after leaving their voice message.
- You can connect an extension phone to the machine to make and receive calls like any other extension phone on your line. Even if you pick up the extension phone and hear a fax tone, the machine will automatically cut in and take over the line. Note, however, if you also have a PC modem on the same line, you must turn on the Remote Reception function, and deactivate the Fax Signal Receive function. See "SETTING UP THE MACHINE FOR USE WITH A PC MODEM" (p.38) and "USING THE REMOTE RECEPTION FUNCTION" (p.39).



The Remote Reception function is initially set to "ON".



# 2

## Chapter 2 INITIAL SETTINGS

### PART NAMES

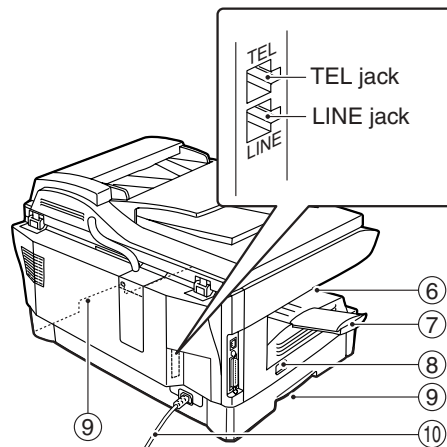
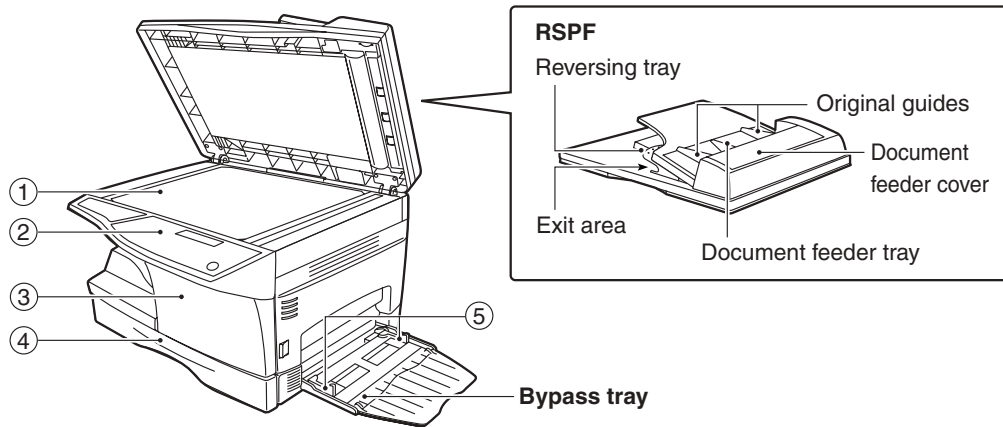

- ① Document glass
- ② Operation panel
- ③ Front cover
- ④ Paper tray
- ⑤ Bypass tray paper guides

- ⑥ Paper output tray
- ⑦ Paper output tray extension
- ⑧ Power switch
- ⑨ Handles
- ⑩ Power cord

# A LOOK AT THE FAX OPERATION PANEL

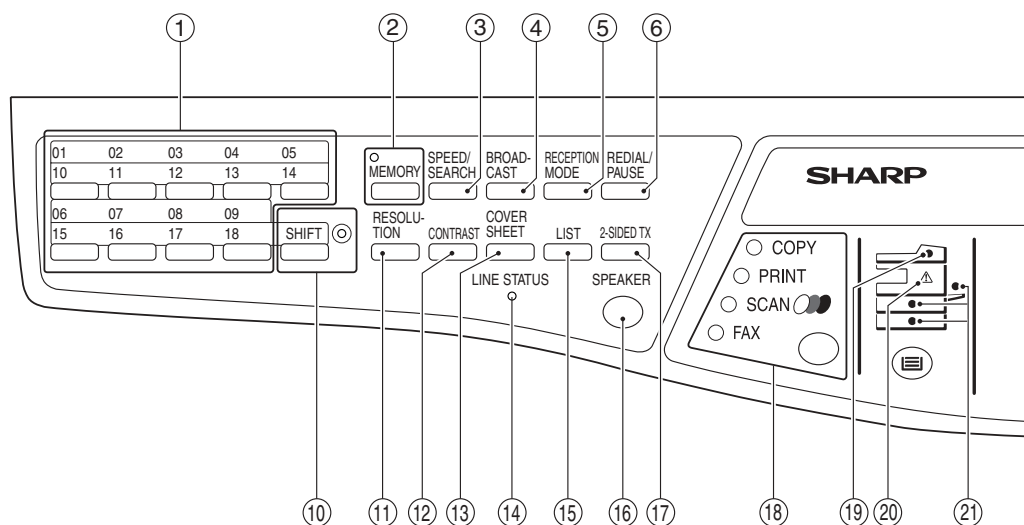

- ① **Rapid keys**  
Press one of these keys to dial a fax or telephone number automatically.
- ② **[MEMORY] key / indicator**  
Used for sending faxes in memory (indicator is lit) or direct sending (indicator is not lit).
- ③ **[SPEED/SEARCH] key**  
Press this key to dial a two digit Speed Dial number.  
During character inputting, use this key to delete an incorrect entry.  
Also, press this key twice to search for an automatic dialing number.
- ④ **[BROADCAST] key**  
Press this key to send originals to a group of receiving fax machines.
- ⑤ **[RECEPTION MODE] key**  
Press this key to select the mode of reception.
- ⑥ **[REDIAL/PAUSE] key**  
Press this key to automatically redial the last number you dialed.  
Also, press this key to insert a pause when entering numbers.
- ⑦ **Display**  
Shows various messages during fax operation and programming.
- ⑧ **[CLEAR] key (C)**  
Press this key to stop an operation before it is completed, or to delete the number that was last input.  
When a setting menu appears, use this key to move back to the previous menu level.
- ⑨ **[CLEAR ALL] key (CA)**  
This returns all functions to the default settings. When pressed in a setting menu, this returns the settings and display to the initial state.
- ⑩ **[SHIFT] key / indicator**  
Press this key to switch between upper and lower case.
- ⑪ **[RESOLUTION] key**  
Press this key to adjust the resolution before sending faxes.
- ⑫ **[CONTRAST] key**  
Press this key to adjust the contrast before sending faxes.
- ⑬ **[COVERSHEET] key**  
Press this key to automatically add a cover sheet and message to a fax.
- ⑭ **LINE STATUS indicator**  
Lit when sending/receiving faxes, blinking when receiving data.

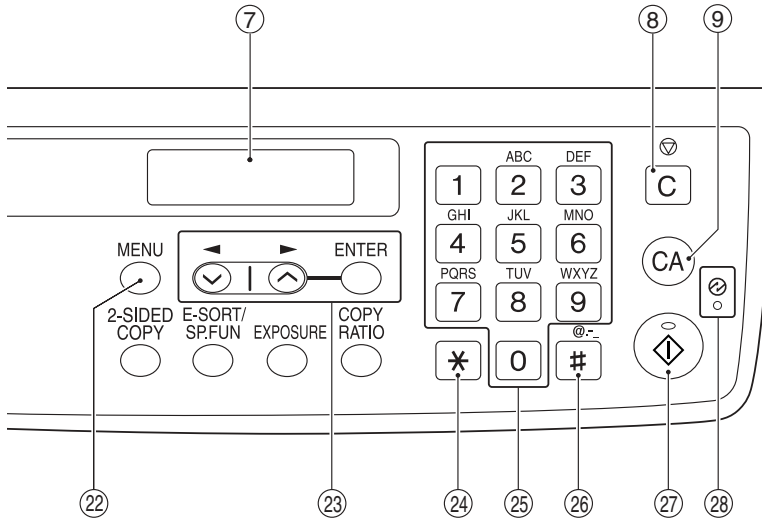

- ⑮ **[LIST] key**  
Press this key to select from a list of available reports.
- ⑯ **[SPEAKER] key**  
Press this key to begin manual dialing. (To close the line, press the [SPEAKER] key again.)
- ⑰ **[2-SIDED TX] key**  
Press this key to fax a two-sided original.
- ⑱ **[MODE SELECT] key / Mode indicators**  
Press this key to select the mode. The indicator of the selected mode lights (copy, printer, scanner, fax mode indicators).
- ⑲ **RSPF indicator**  
This lights up when an original is placed in the RSPF.
- ⑳ **Error indicator**  
This lights steadily or blinks when a paper misfeed or other error occurs.
- ㉑ **Tray location indicator**  
Indicates the selected paper tray. The indicator blinks when the tray is out of paper or is not closed.
- ㉒ **[MENU] key**  
Press this key to configure a user program.
- ㉓ **[◀] key (⏪), [▶] key (⏩), [ENTER] key**  
Press the [◀] key (⏪) or [▶] key (⏩) to select an item in a function setting menu.  
Press the [ENTER] key to enter a selection.
- ㉔ **[\*] key**  
Press this key to enter symbols during a name storing procedure.  
Press the "\*" key to change from pulse dialing to tone dialing mode.
- ㉕ **Numeric keys**  
Press these keys to dial numbers, and enter numbers and letters during number/name storing procedures.
- ㉖ **[#] key**  
Press this key to enter symbols during a name storing procedure. The [#] key scrolls through symbols in the opposite direction of the [\*] key.  
When dialing, press this key after you are finished scanning originals into memory from the document glass.
- ㉗ **[START] key (⏻) / indicator**  
Used for the following:
  - To begin sending a fax.
  - Reading an original into memory from the document glass.
  - Manually receiving a fax.
  - Entering and setting information.
  - Printing received faxes held in print hold mode.
- ㉘ **Power save indicator**  
This lights up when the power save function is activated.

---

---

# ABOUT THE LIQUID CRYSTAL DISPLAY

The machine is equipped with a two-line liquid crystal display (LCD) on the operation panel for displaying various messages and settings during operation. This LCD can display up to 20 characters on each line. When the machine is idle, the LCD shows the date, time, reception mode and the stand-by memory available.

Example:

```
NOV 05 WED 09:20 AM
STAND-BY AUTO 100%
```

When an original is placed in the RSPF, the second line changes from "STAND-BY" to "SEND READY".

When the [MENU] key is pressed to configure a setting, the display appears as shown below.

Example:

```
FAX MAIN MENU
1:TIMER MODE
```

The selected setting or entered information appears on the second line.

---

---

# USING THE ARROW KEYS

To configure settings and program information, press the [MENU] key and then press the [◀] key (⏪) or [▶] key (⏩) to select the item that you wish to configure.

The arrows keys can also be used while entering characters to move the cursor.

Example:

```
FAX MAIN MENU
1:TIMER MODE
```

Press the [◀] key (⏪) or [▶] key (⏩) to change the item selection that appears on the second line.



**Note** An item can also be selected after pressing the [MENU] key by pressing the numeric key for the item (the key corresponding to the number that appears in front of the item). When the numeric key is pressed, the item is selected or entered.

# ADJUSTING THE RINGING VOLUME

Adjust the ringing volume of the machine following the procedure below.

## 1 Press the [MENU] key.

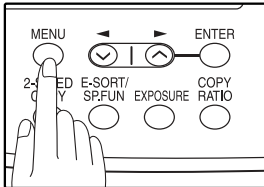

## 5 Press the [ENTER] key.

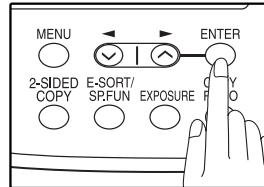

## 2 Press the [◀] key (⏪) or [▶] key (⏩) until "4:USER PROGRAM" appears, and then press the [ENTER] key.

Selection

"4:USER PROGRAM"

## 6 Press the [MENU] key.

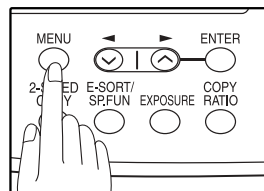

Press the [MENU] key to exit.

2

## 3 Press the [◀] key (⏪) or [▶] key (⏩) until "18:RINGER VOLUME" appears, and then press the [ENTER] key.

Selection

"18:RINGER VOLUME"

## 4 Press the [◀] key (⏪) or [▶] key (⏩) to set the ringer volume.

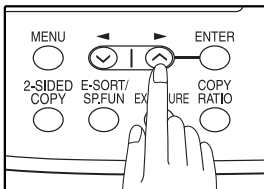

The selections are as follows:

- 1:OFF
- 2:LOW
- 3:MIDDLE
- 4:HIGH

To turn off the ringer, select "1:OFF".



**Note** An extension phone will still ring when the machine ringer is set to "1:OFF".

# SETTING THE LENGTH OF ALARM BEEPS

You can select the length in seconds of the alarm beeps (emitted at the end of transmission and reception) following the procedure below.

## 1 Press the [MENU] key.

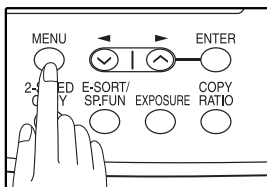

## 6 Press the [MENU] key.

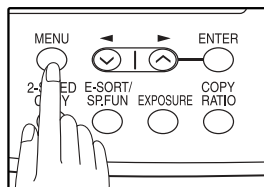

Press the [MENU] key to exit.

## 2 Press the [◀] key (⏪) or [▶] key (⏩) until "4:USER PROGRAM" appears, and then press the [ENTER] key.

Selection

"4:USER PROGRAM"

## 3 Press the [◀] key (⏪) or [▶] key (⏩) until "17:BEEP LENGTH" appears, and then press the [ENTER] key.

Selection

"17:BEEP LENGTH"

## 4 Press the [◀] key (⏪) or [▶] key (⏩) to set the alarm beeps to the desired length or to turn them off.

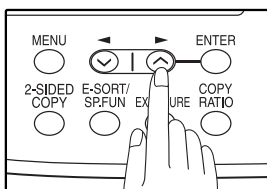

The selections are as follows:

1:3SEC

2:1SEC

3:NO BEEP

## 5 Press the [ENTER] key.

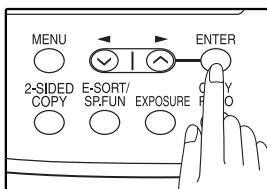

# ADJUSTING THE ALARM BEEP VOLUME

Adjust the volume of alarm beeps (emitted at the end of transmission and reception) following the procedure below.

## 1 Press the [MENU] key.

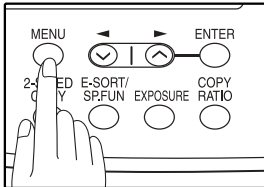

## 6 Press the [MENU] key.

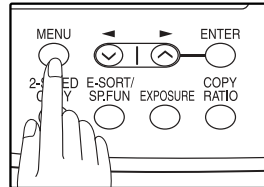

Press the [MENU] key to exit.

## 2 Press the [◀] key (⏪) or [▶] key (⏩) until "4:USER PROGRAM" appears, and then press the [ENTER] key.

Selection

"4:USER PROGRAM"

## 3 Press the [◀] key (⏪) or [▶] key (⏩) until "19:BEEPER VOLUME" appears, and then press the [ENTER] key.

Selection

"19:BEEPER VOLUME"

## 4 Press the [◀] key (⏪) or [▶] key (⏩) to set the alarm volume.

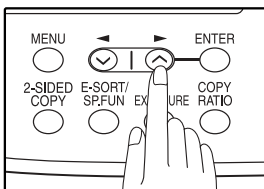

The selections are as follows:

- 1:OFF
- 2:LOW
- 3:MIDDLE
- 4:HIGH

To turn off the alarm, select "1:OFF".

## 5 Press the [ENTER] key.

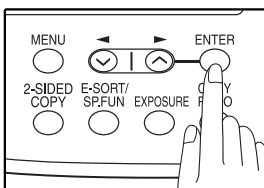

2

---

---

# FAX SETUP

## HOW TO ENTER CHARACTERS

You can enter letters with the numeric keys. Letters are marked above each of the numeric keys [2] through [9]. To enter a letter, press the appropriate key repeatedly until the desired letter appears (the number of the key appears first, followed by letters in the order marked above the key). The keys used for entering characters are shown below.



The following characters can be entered with the numeric keys:

key	Characters that can be entered
1	1 Space
2	A B C 2 a b c
3	D E F 3 d e f
4	G H I 4 g h i
5	J K L 5 j k l
6	M N O 6 m n o
7	P Q R S 7 p q r s
8	T U V 8 t u v
9	W X Y Z 9 w x y z
*	* } [ [ ? > = ; : , + ) ( & % \$ ! / _ . @ #
0	0
#	# @ . - / ! " \$ % & ' ( ) + , ; = > ? [ ] { } *

- To enter two characters in succession which require using the same key, press the [▶] key (☺) once after entering the first character, and then enter the second character.
- If you enter an incorrect character or number, follow these steps to correct the mistake.
  1. Press the [◀] key (☹) or [▶] key (☺) to move the cursor to the character immediately following the incorrect character.
  2. Press the [CLEAR] key (☐).
  - The character in front of the cursor is deleted.
  3. Enter the correct character.
  - The character is inserted in front of the cursor.



# ENTERING YOUR NAME AND FAX NUMBER



You can view all of the items in the menu display by pressing the [MENU] key, then using the [◀] key (⏪) or [▶] key (⏩) to scroll through the function list. Pressing the [ENTER] key chooses the displayed function. Procedures for inputting various items (name, telephone number, date, etc.) are given as follows.

To have your name and fax number printed at the top of every page you transmit, program them by pressing the operation panel keys as shown below.

- If you enter an incorrect character or number, follow these steps to correct the mistake.
  1. Press the [◀] key (⏪) or [▶] key (⏩) to move the cursor to the character immediately following the incorrect character.
  2. Press the [CLEAR] key (⏴). The character in front of the cursor is deleted.
  3. Enter the correct character.

## IMPORTANT

FCC regulations require that your name, telephone/fax number, and the date and time appear on each fax message you send. Enter your name and fax number here and set the date and time as explained in the following section to have the fax machine include this information automatically at the top of your fax messages.

# 2

Use the following procedure to enter your name and fax number:

### 1 Press the [MENU] key.

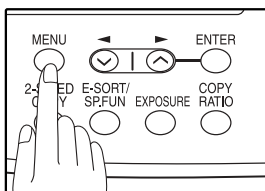

### 2 Press the [◀] key (⏪) or [▶] key (⏩) until "2:ENTRY MODE" appears, and then press the [ENTER] key.

Selection

"2:ENTRY MODE"

### 3 Press the [◀] key (⏪) or [▶] key (⏩) until "3:OWN PASSCODE SET" appears, and then press the [ENTER] key.

Selection

"3:OWN PASSCODE SET"

### 4 Press the [◀] key (⏪) or [▶] key (⏩) to select "1:SET" and then press the [ENTER] key.

Selection

"1:SET"

### 5 Enter your fax number with the numeric keys.

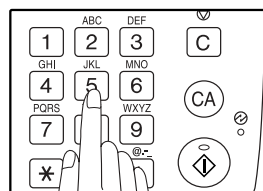

Enter your own fax number (maximum 20 digits) by pressing the Numeric keys. To insert a "+", press the [ \* ] key.

### 6 Press the [ENTER] key.

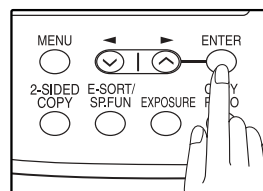

"ENTER NAME" will appear in the display.

### 7 Enter your name with the numeric keys.

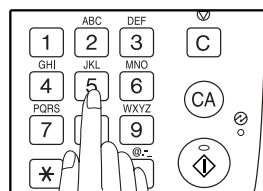

Enter your name by pressing the appropriate Numeric keys as shown on the left. Press each key repeatedly until the desired letter appears in the display (maximum of 40 characters).

To enter a space, press the [1] key twice.

**8 Press the [ENTER] key.**

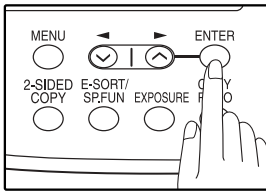

**9 Press the [MENU] key.**

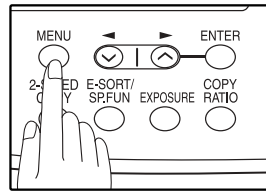

Press the [MENU] key to exit.

## SETTING THE DATE AND TIME

The date and time that appear in the display are printed at the top of each page you transmit. Set the date and time by pressing the keys on the operation panel as shown below.

If you enter an incorrect number, press the [CLEAR] key (C) and re-enter the number.

The time can be displayed in 12-hour or 24-hour format. "Month/Day/Year", "Day/Month/Year" or "Year/Month/Day" can be selected for the order of display of the date.

Use the following procedure to set the date and time:

**1 Press the [MENU] key.**

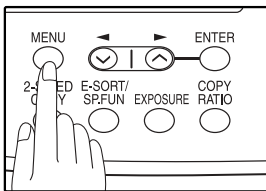

**6 Press the [◀] key (▽) or [▶] key (△) to select "AM" or "PM".**

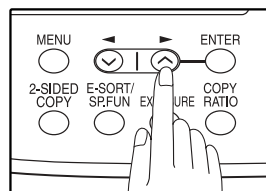

When 24-hour format is selected, do not perform this step.

**2 Press the [◀] key (▽) or [▶] key (△) until "2:ENTRY MODE" appears, and then press the [ENTER] key.**

Selection

"2:ENTRY MODE"

**7 Press the [ENTER] key.**

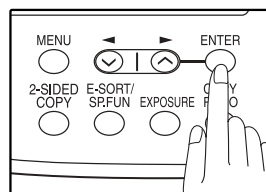

**3 Press the [◀] key (▽) or [▶] key (△) until "2:DATE&TIME SET" appears, and then press the [ENTER] key.**

Selection

"2:DATE&TIME SET"

**8 Press the [MENU] key.**

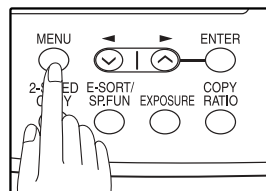

Press the [MENU] key to exit.

**4 Enter the year, month, and day with the numeric keys and then press the [ENTER] key.**

**5 Enter the time with the numeric keys.**

To change the display format to 12-hour or 24-hour format, follow the steps below:

**1** Press the [MENU] key.

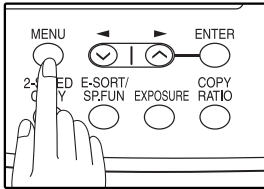

**2** Press the [◀] key (⏪) or [▶] key (⏩) until "4:USER PROGRAM" appears, and then press the [ENTER] key.

Selection

"4:USER PROGRAM"

**3** Press the [◀] key (⏪) or [▶] key (⏩) until "23:DATE&TIME FORMAT" appears, and then press the [ENTER] key.

Selection

"23:DATE&TIME FORMAT"

**4** Press the [◀] key (⏪) or [▶] key (⏩) until "1:TIME FORMAT" appears, and then press the [ENTER] key.

Selection

"1:TIME FORMAT"

**5** Press the [◀] key (⏪) or [▶] key (⏩) to select "1:12HOUR" or "2:24HOUR".

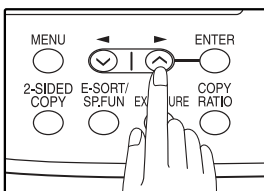

**6** Press the [ENTER] key.

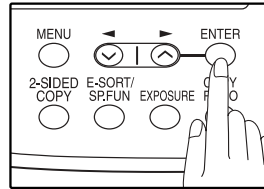

**7** Press the [MENU] key.

Press the [MENU] key to exit.

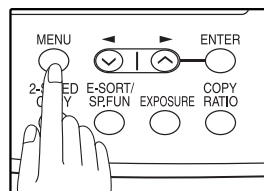

**2**

## INITIAL SETTINGS

To change the order of display of the date, follow the steps below:

### 1 Press the [MENU] key.

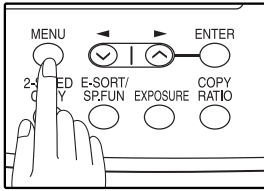

### 2 Press the [◀] key (⏪) or [▶] key (⏩) until "4:USER PROGRAM" appears, and then press the [ENTER] key.

Selection

"4:USER PROGRAM"

### 3 Press the [◀] key (⏪) or [▶] key (⏩) until "23:DATE&TIME FORMAT" appears, and then press the [ENTER] key.

Selection

"23:DATE&TIME FORMAT"

### 4 Press the [◀] key (⏪) or [▶] key (⏩) until "2:DATE FORMAT" appears, and then press the [ENTER] key.

Selection

"2:DATE FORMAT"

### 5 Press the [◀] key (⏪) or [▶] key (⏩) to select the display order.

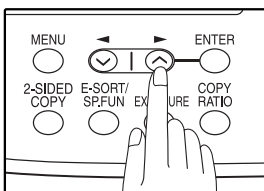

The selections are as follows:

- 1:MMDDYYYY
- 2:DDMMYYYY
- 3:YYYYMMDD

### 6 Press the [ENTER] key.

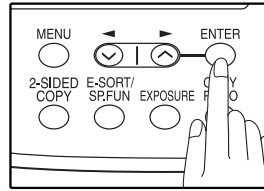

### 7 Press the [MENU] key.

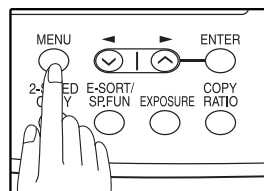

Press the [MENU] key to exit.

## Daylight Saving Time Setting

Enable this setting to have the internal clock automatically move forward and backward at the beginning and end of Daylight Saving Time. The clock will move forward and backward as follows:

The first Sunday in April: 2:00 A.M. → 3:00 A.M.

The last Sunday in October: 2:00 A.M. → 1:00 A.M.



If a transmission is in progress when the clock adjustment time for daylight savings time arrives, the clock will not be adjusted until the transmission ends.

Follow these steps to enable Daylight Saving Time.

### 1 Press the [MENU] key.

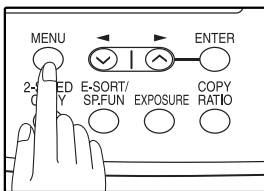

### 2 Press the [◀] key (⏪) or [▶] key (⏩) until "2:ENTRY MODE" appears, and then press the [ENTER] key.

Selection

"2:ENTRY MODE"

### 3 Press the [◀] key (⏪) or [▶] key (⏩) until "5:DAY LIGHT SAVING" appears, and then press the [ENTER] key.

Selection

"5:DAY LIGHT SAVING"

### 4 Press the [◀] key (⏪) or [▶] key (⏩) to select "1:ON" or "2:OFF".

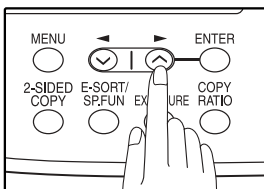

Select "1:ON" to enable the function.  
Select "2:OFF" to disable the function.

### 5 Press the [ENTER] key.

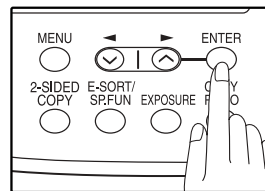

### 6 Press the [MENU] key.

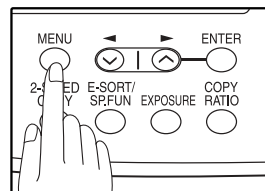

Press the [MENU] key to exit.

2

## SELECTING THE TRANSMISSION MODE

The machine has two modes for sending faxes: memory transmission and direct transmission. To change modes, press the [MEMORY] key. The MEMORY indicator lights up when memory transmission is selected, and goes off when direct transmission is selected.

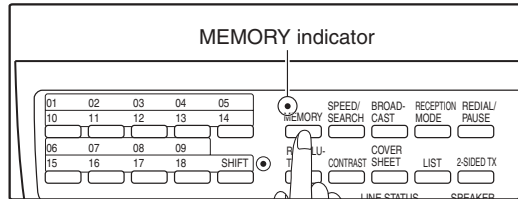

Transmission takes place as follows in each mode:

### Memory transmission (the MEMORY indicator is lit)

When a fax is sent from the RSPF and there are no previously stored fax jobs and no job in progress (the telephone line is not being used), dialing and scanning begin at the same time. Each page is transmitted after it is scanned. This transmission method is called Quick Online transmission.

If there are previously stored fax jobs or a job in progress, or the fax is being sent from the document glass, the fax is temporarily scanned into memory before transmission.



When a fax is sent by transmission reservation (p.70), broadcast transmission (p.71), broadcasting using a Group key (p.72), or timer transmission (p.79), the fax is scanned into memory before transmission.

### Direct transmission (the MEMORY indicator is off)

The fax is sent directly after the destination is dialed and the connection established.

The machine memory is not used for direct transmission, and thus direct transmission is possible even when the memory is full.



- A fax job cannot be stored while a direct transmission is in progress.
- Only one page can be sent from the document glass by direct transmission.
- A subsequent function cannot be used while a direct transmission is in progress. Transmission reservation (p.70), broadcast transmission (p.71), broadcasting using a Group key (p.72), or timer transmission (p.79)

## SELECTING THE RECEPTION MODE

Your machine has three modes for receiving incoming calls and faxes:

- **AUTO mode:**  
Select this mode when you only want to receive faxes on your telephone line. The machine will automatically answer all calls and receive incoming faxes.
- **MAN. mode:**  
This is the most convenient mode for receiving phone calls if you have an extension phone. To have true manual mode, the machine must be set to not answer while in MAN. mode (see "SETTING THE NUMBER OF RINGS FOR MANUAL RECEPTION" (p.29)). You can also receive faxes; however, all calls must first be answered by picking up the receiver on the extension phone.
- **A.M. mode:**  
Select this mode when an answering machine is connected to the machine and you want the answering machine to answer all calls. This allows you to receive both voice messages and faxes while you are out.



If you are using distinctive ringing as described in "DISTINCTIVE RINGING" on page 41, you must set the reception mode to AUTO. This is true, as well, if you are using an answering machine with distinctive ringing (in this case, the answering machine must be connected to a separate wall jack, not to your machine).

To select the reception mode, press the [RECEPTION MODE] key until the desired reception mode appears in the display.

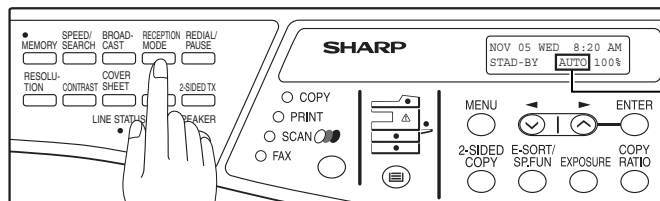

The selected reception mode appears.

For more information on reception modes, refer to "RECEIVING FAXES" (p.63).

2

## SETTING THE NUMBER OF RINGS FOR AUTO RECEPTION

You can set the number of rings before the machine answers in AUTO mode following the procedure below.

### 1 Press the [MENU] key.

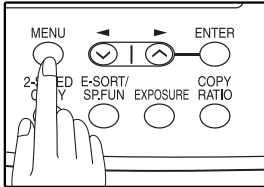

### 6 Press the [MENU] key.

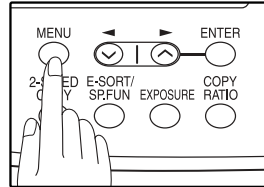

Press the [MENU] key to exit.

### 2 Press the [◀] key (⏪) or [▶] key (⏩) until "4:USER PROGRAM" appears, and then press the [ENTER] key.

Selection

"4:USER PROGRAM"



If an external telephone is connected, the external telephone will ring one time when auto reception is set to 0 rings.

### 3 Press the [◀] key (⏪) or [▶] key (⏩) until "4:# OF RINGS (AUTO)" appears, and then press the [ENTER] key.

Selection

"4:# OF RINGS (AUTO)"

### 4 Press a numeric key to select the number of rings.

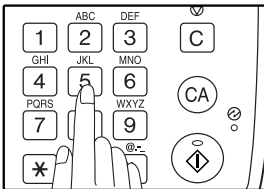

Select the number of rings you would like to use (0 to 9).

### 5 Press the [ENTER] key.

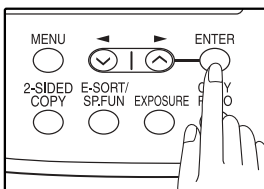



## SETTING THE NUMBER OF RINGS FOR MANUAL RECEPTION

The number of rings before the machine answers in MANUAL mode can also be set. If you do not want the machine to answer at all in MANUAL Mode, select "0" in Step 4 below.

### 1 Press the [MENU] key.

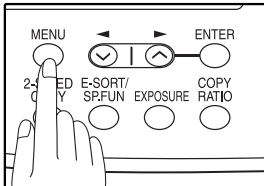

### 2 Press the [◀] key (⏪) or [▶] key (⏩) until "4:USER PROGRAM" appears, and then press the [ENTER] key.

Selection

"4:USER PROGRAM"

### 3 Press the [◀] key (⏪) or [▶] key (⏩) until "5:# OF RINGS (MANUAL)" appears, and then press the [ENTER] key.

Selection

"5:# OF RINGS (MANUAL)"

### 4 Press a numeric key to select the number of rings.

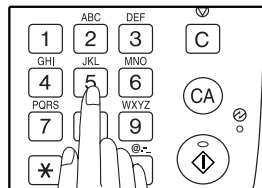

Select the number of rings you would like to use (0 to 9).

### 5 Press the [ENTER] key.

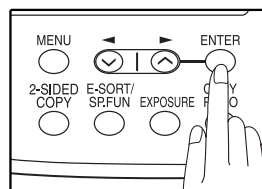

### 6 Press the [MENU] key.

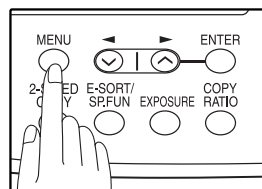

Press the [MENU] key to exit.

# 2

## SELECTING THE RECEPTION PAPER SIZE

Set the size of paper to be used to print received faxes. A size setting other than "A4", "8.5x11", or "8.5x14" is regarded as out of paper. To set the paper size, see "LOADING PAPER" in the Operation Manual (for general information).

## SETTING THE TRAY SELECTION (when the 250-sheet paper feed unit is installed)

Follow the steps below to select the paper tray for received faxes.

### 1 Press the [MENU] key.

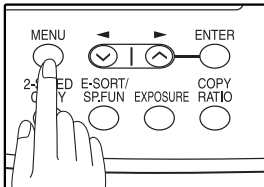

### 2 Press the [◀] key (⏪) or [▶] key (⏩) until "4:USER PROGRAM" appears, and then press the [ENTER] key.

Selection

"4:USER PROGRAM"

### 3 Press the [◀] key (⏪) or [▶] key (⏩) until "27:TRAY SELECTION" appears, and then press the [ENTER] key.

Selection

"27:TRAY SELECTION"

### 4 Press the [◀] key (⏪) or [▶] key (⏩) to select the tray selection.

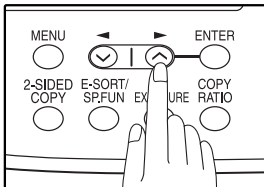

The selections are as follows:  
1:AUTO  
2:TRAY 1  
3:TRAY 2

### 5 Press the [ENTER] key.

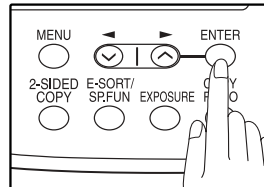

### 6 Press the [MENU] key.

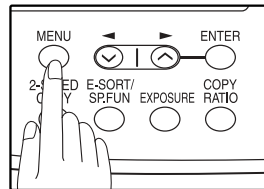

Press the [MENU] key to exit.

## SETTING THE DIAL MODE

The machine can be used with both touch-tone and pulse telephone lines. Touch-tone uses tones of different pitches for each numeric key, while pulse lines use a series of pulses. Your machine must be set to match the kind of telephone line you are using: touch-tone or pulse.

### 1 Press the [MENU] key.

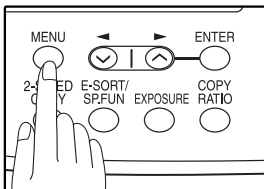

### 6 Press the [MENU] key.

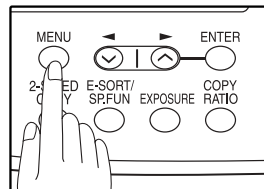

Press the [MENU] key to exit.

### 2 Press the [◀] key (⏪) or [▶] key (⏩) until "4:USER PROGRAM" appears, and then press the [ENTER] key.

Selection

"4:USER PROGRAM"

### 3 Press the [◀] key (⏪) or [▶] key (⏩) until "20:DIAL MODE" appears, and then press the [ENTER] key.

Selection

"20:DIAL MODE"

### 4 Press the [◀] key (⏪) or [▶] key (⏩) to select the dial mode.

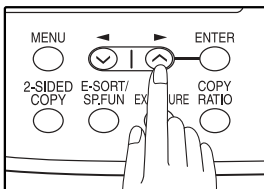

The selections are as follows:  
1:TONE  
2:PULSE

### 5 Press the [ENTER] key.

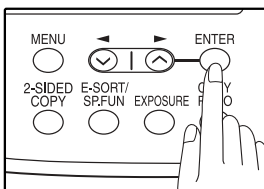

2

## SETTING THE NUMBER OF RECALL TIMES

The machine will automatically reattempt transmission when a transmission is not successful because the line is busy or a communication error occurs. This setting is used to select the number of recall attempts that will be made.



- If a transmission is still not successful after the set number of recall attempts is made, a report will print and the document will be cleared from memory.
- If a communication error occurs because the memory becomes full during transmission, no recall attempts will be made.
- Recall attempts for a direct transmission will only be made when the RSPF is used. Recall attempts will not be made when the document glass is used.
- When the machine is waiting to make a recall attempt for a direct transmission, other operations such as storing a transmission or selecting a function cannot be performed.

### When the line is busy

You can select the number of recall attempts made when the line is busy.  
If "00" is entered, the machine will not make any recall attempts.

#### 1 Press the [MENU] key.

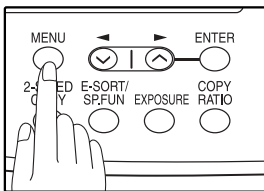

#### 2 Press the [◀] key (⏪) or [▶] key (⏩) until "4:USER PROGRAM" appears, and then press the [ENTER] key.

Selection

"4:USER PROGRAM"

#### 3 Press the [◀] key (⏪) or [▶] key (⏩) until "8:RECALL TIMES BUSY" appears, and then press the [ENTER] key.

Selection

"8:RECALL TIMES BUSY"

#### 4 Press the numeric keys to select the number of recall attempts.

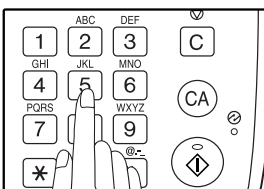

Enter the number of recall times ("00" to "14").

#### 5 Press the [ENTER] key.

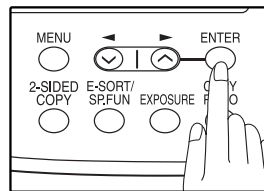

#### 6 Press the [MENU] key.

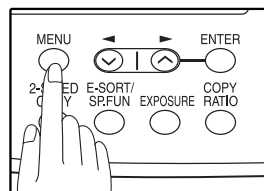

Press the [MENU] key to exit.

## When a communication error occurs

You can select the number of recall attempts made when a communication error occurs.  
If "0" is entered, the machine will not make any recall attempts.

### 1 Press the [MENU] key.

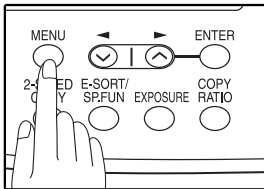

### 6 Press the [MENU] key.

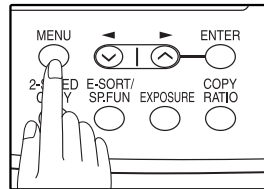

Press the [MENU] key to exit.

### 2 Press the [◀] key (⏪) or [▶] key (⏩) until "4:USER PROGRAM" appears, and then press the [ENTER] key.

Selection

"4:USER PROGRAM"

### 3 Press the [◀] key (⏪) or [▶] key (⏩) until "9:RECALL TIMES ERR" appears, and then press the [ENTER] key.

Selection

"9:RECALL TIMES ERR"

### 4 Press the numeric keys to select the number of recall attempts.

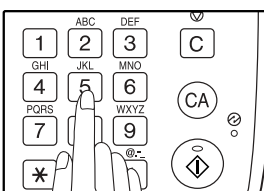

Enter the number of recall times ("0" or "1").

### 5 Press the [ENTER] key.

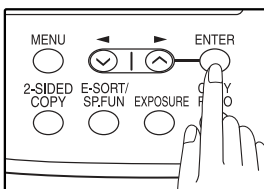

2

## SETTING THE RECALL INTERVAL

The machine will automatically reattempt transmission when a transmission is not successful because the line is busy or a communication error occurs. This setting is used to select the interval between recall attempts.



- If a transmission is still not successful after the set number of recall attempts is made, a report will print and the document will be cleared from memory.
- If a communication error occurs because the memory becomes full during transmission, no recall attempts will be made.
- Recall attempts for a direct transmission will only be made when the RSPF is used. Recall attempts will not be made when the document glass is used.
- When the machine is waiting to make a recall attempt for a direct transmission, other operations such as storing a transmission or selecting a function cannot be performed.

### When the line is busy

You can select the interval between recall attempts when the line is busy. An interval from 1 to 15 minutes can be selected.

#### 1 Press the [MENU] key.

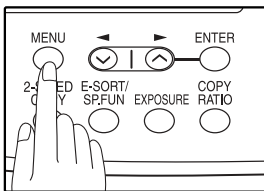

#### 5 Press the [ENTER] key.

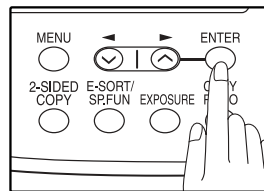

#### 2 Press the [◀] key (⏪) or [▶] key (⏩) until "4:USER PROGRAM" appears, and then press the [ENTER] key.

Selection

"4:USER PROGRAM"

#### 6 Press the [MENU] key.

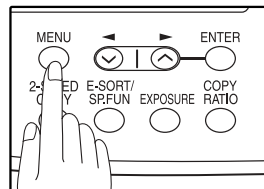

Press the [MENU] key to exit.

#### 3 Press the [◀] key (⏪) or [▶] key (⏩) until "10:RECALL INT. BUSY" appears, and then press the [ENTER] key.

Selection

"10:RECALL INT. BUSY"

#### 4 Press the numeric keys to select the recall interval.

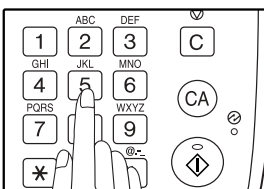

Enter the recall interval ("01" to "15").

## When a communication error occurs

You can select the interval between recall attempts when a communication error occurs. An interval from 0 to 15 minutes can be selected. If the recall interval is set to 0 minutes, the machine will immediately call again after breaking the connection due to the communication error.

### 1 Press the [MENU] key.

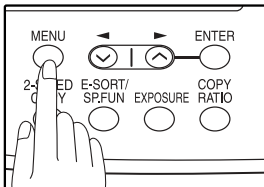

### 6 Press the [MENU] key.

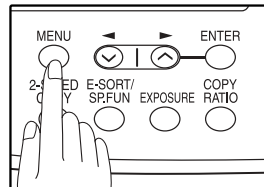

Press the [MENU] key to exit.

### 2 Press the [◀] key (⏪) or [▶] key (⏩) until "4:USER PROGRAM" appears, and then press the [ENTER] key.

Selection

"4:USER PROGRAM"

### 3 Press the [◀] key (⏪) or [▶] key (⏩) until "11:RECALL INT. ERR" appears, and then press the [ENTER] key.

Selection

"11:RECALL INT. ERR"

### 4 Press the numeric keys to select the recall interval.

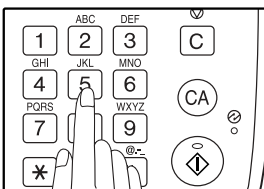

Enter the recall interval ("00" to "15").

### 5 Press the [ENTER] key.

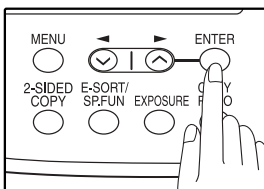

2

## SETTING THE INDEX FUNCTION

You can print an index mark along the edge of the pages in each job. This makes it easy to separate different jobs on the output tray.

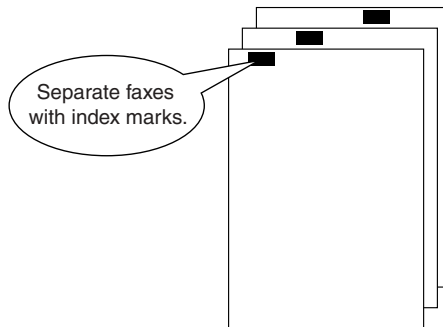

Use the following procedure to set the index function:

### 1 Press the [MENU] key.

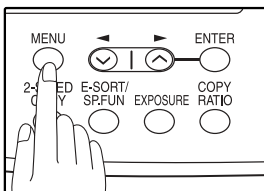

### 2 Press the [◀] key (⏪) or [▶] key (⏩) until "4:USER PROGRAM" appears, and then press the [ENTER] key.

Selection

"4:USER PROGRAM"

### 3 Press the [◀] key (⏪) or [▶] key (⏩) until "22:INDEX PRINT" appears, and then press the [ENTER] key.

Selection

"22:INDEX PRINT"

### 4 Press the [◀] key (⏪) or [▶] key (⏩) to select "1:ON" or "2:OFF".

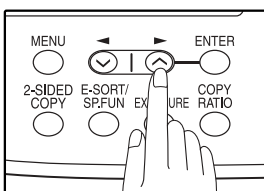

Select "1:ON" to enable the function.  
Select "2:OFF" to disable the function.

### 5 Press the [ENTER] key.

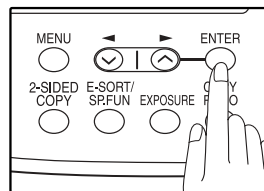

### 6 Press the [MENU] key.

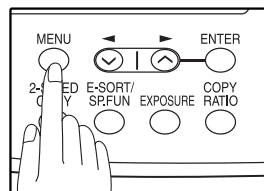

Press the [MENU] key to exit.



## SETTING RESOLUTION PRIORITY

For most faxing jobs, you will most likely want to specify the resolution. However, you can also set a default resolution when no setting is made using the [RESOLUTION] key.

To turn on this function, follow the procedure below:

### 1 Press the [MENU] key.

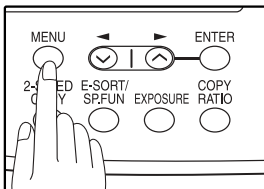

### 6 Press the [MENU] key.

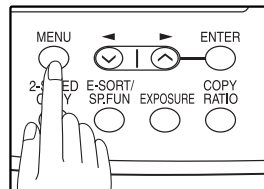

Press the [MENU] key to exit.

### 2 Press the [◀] key (⏪) or [▶] key (⏩) until "4:USER PROGRAM" appears, and then press the [ENTER] key.

Selection

"4:USER PROGRAM"

### 3 Press the [◀] key (⏪) or [▶] key (⏩) until "3:RESO. PRIORITY" appears, and then press the [ENTER] key.

Selection

"3:RESO. PRIORITY"

### 4 Press the [◀] key (⏪) or [▶] key (⏩) to select the transmission resolution.

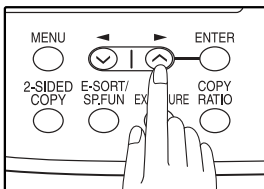

The selections are as follows:

- 1:STANDARD
- 2:FINE
- 3:SUPER FINE

### 5 Press the [ENTER] key.

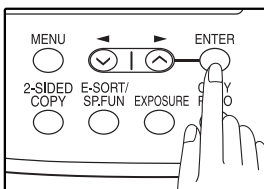

2

## SETTING UP THE MACHINE FOR USE WITH A PC MODEM

The machine is set to automatically begin reception if you pick up from an extension telephone and the machine detects a fax tone. However, if you are using a modem on the same line, you must deactivate this function: otherwise the machine will mistakenly attempt to receive the transmission from your computer. To turn off the Fax Signal Receive function, follow the procedure below.



If you turn off the Fax Signal Receive function, be sure to activate the Remote Reception function. See "USING THE REMOTE RECEPTION FUNCTION" on page 39 for details on how to do this.

### 1 Press the [MENU] key.

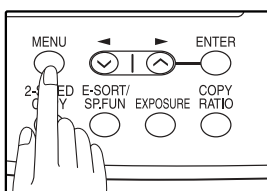

### 2 Press the [◀] key (⏪) or [▶] key (⏩) until "4:USER PROGRAM" appears, and then press the [ENTER] key.

Selection

"4:USER PROGRAM"

### 3 Press the [◀] key (⏪) or [▶] key (⏩) until "15:FAX SIGNAL RCV" appears, and then press the [ENTER] key.

Selection

"15:FAX SIGNAL RCV"

### 4 Press the [◀] key (⏪) or [▶] key (⏩) to select "1:ON" or "2:OFF".

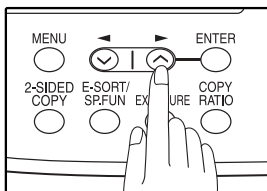

Select "1:ON" to enable the function.  
Select "2:OFF" to disable the function.

### 5 Press the [ENTER] key.

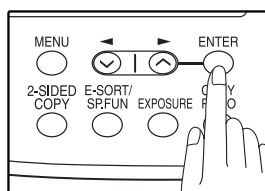

### 6 Press the [MENU] key.

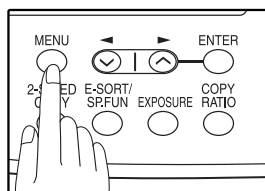

Press the [MENU] key to exit.

## USING THE REMOTE RECEPTION FUNCTION

The machine's Remote Reception feature is designed to allow you to activate fax reception from an extension telephone or a telephone directly connected to the machine. The Remote Reception function operates even when the FAX Signal Receive function is turned off. See "SETTING UP THE MACHINE FOR USE WITH A PC MODEM" on page 38. When you hear the fax tone, simply press the one-digit Fax Remote Number (Factory setting: 5) and \* \*. Follow the two procedures below to use this feature.



- If you are not using a PC modem on the same line as your machine, and have not turned off the Fax Signal Receive function, you do not need to make any changes to the Remote Reception function. Simply use the factory settings. The machine will automatically take over the line should you answer from the extension phone and a fax tone is detected.
- If you want to receive a fax while you are on an extension telephone, when you hear a fax tone, press the one-digit Fax Remote Number and \* \*. To ensure proper fax reception, hang up the extension phone only after you have confirmed that fax reception has begun. Confirm that fax reception has begun as follows:
  - If the extension telephone is connected directly to the fax there is no sound when fax reception begins.
  - If the extension telephone shares the telephone line with the fax but is not directly connected, you hear a continuous tone when fax reception begins. If you cannot hear this tone, try pressing the one-digit FAX Remote Number and \* \* again.

2

Turning on Remote Reception:

### 1 Press the [MENU] key.

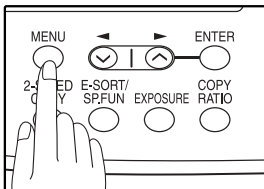

### 2 Press the [◀] key (⏪) or [▶] key (⏩) until "4:USER PROGRAM" appears, and then press the [ENTER] key.

Selection

"4:USER PROGRAM"

### 3 Press the [◀] key (⏪) or [▶] key (⏩) until "14:REMOTE RECEPTION" appears, and then press the [ENTER] key.

Selection

"14:REMOTE RECEPTION"

### 4 Press the [◀] key (⏪) or [▶] key (⏩) to select "1:ON" or "2:OFF".

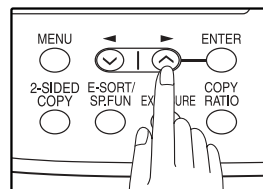

### 5 Press the [ENTER] key.

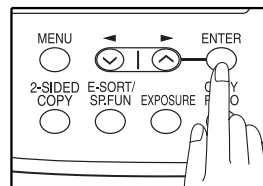

### 6 Press the [MENU] key.

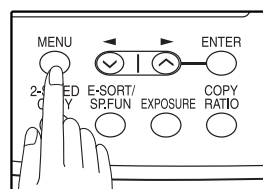

Press the [MENU] key to exit.

## INITIAL SETTINGS

Setting a Fax Remote Number:

### 1 Press the [MENU] key.

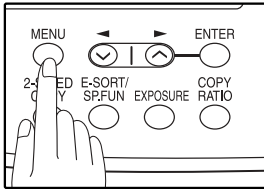

### 2 Press the [◀] key (⏪) or [▶] key (⏩) until "4:USER PROGRAM" appears, and then press the [ENTER] key.

Selection

"4:USER PROGRAM"

### 3 Press the [◀] key (⏪) or [▶] key (⏩) until "13:FAX REMOTE NUMBER" appears, and then press the [ENTER] key.

Selection

"13:FAX REMOTE NUMBER"

### 4 Press a numeric key to enter the Fax Remote Number.

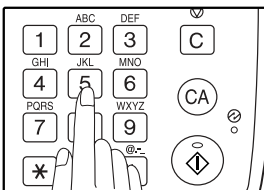

Enter the number you would like to use as the Fax Remote Number ("0" to "9").

### 5 Press the [ENTER] key.

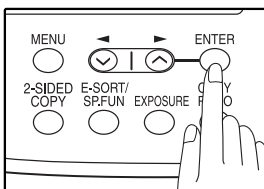

### 6 Press the [MENU] key.

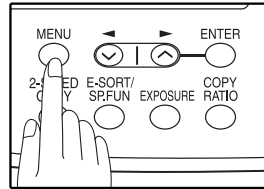

Press the [MENU] key to exit.

## DISTINCTIVE RINGING

Distinctive ringing is a service offered by some telephone companies that allows you to use up to six different telephone numbers, each with a distinctive ringing pattern, on your regular single line. If you subscribe to a distinctive ringing service, you can set your fax to automatically answer when it detects one of these ringing patterns, and use the number corresponding to that pattern as an exclusive fax number.

Important:

- To use distinctive ringing, you must subscribe to your phone company's distinctive ringing service. Do not use this setting if you do not subscribe to a distinctive ringing service.

When using this feature, you must set the reception mode of your machine to AUTO (See "SELECTING THE RECEPTION MODE" (p.27)). When your designated fax number is dialed, the machine will automatically answer and begin reception. Note that other devices you have connected on the same line will also ring until the machine answers. If one of your other numbers is dialed, the machine will neither ring nor answer.

To use distinctive ringing, select the ringing pattern to which you want your machine to answer, as shown below.

# 2

The selections for ringing are:

1. OFF: Answers all ringing patterns (This turns distinctive ringing off.)
2. STANDARD: Your machine normal ringing pattern
3. PATTERN 1: Two short rings
4. PATTERN 2: One short, one long, and one short ring
5. PATTERN 3: Three short rings
6. PATTERN 4: Three rings
7. PATTERN 5: Two rings

Use the following procedure to change the ringing pattern.

### 1 Press the [MENU] key.

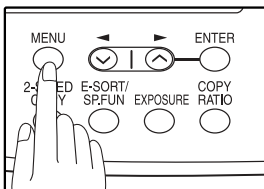

### 2 Press the [◀] key (⏪) or [▶] key (⏩) until "4:USER PROGRAM" appears, and then press the [ENTER] key.

Selection

"4:USER PROGRAM"

### 3 Press the [◀] key (⏪) or [▶] key (⏩) until "21:DISTINCTIVE RING" appears, and then press the [ENTER] key.

Selection

"21:DISTINCTIVE RING"

### 4 Press the [◀] key (⏪) or [▶] key (⏩) to select a ringing pattern.

Select a ringing pattern by scrolling through them with the arrow keys in the order of the above list.

### 5 Press the [ENTER] key.

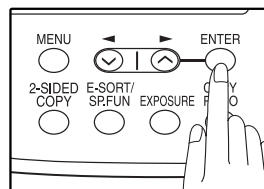

### 6 Press the [MENU] key.

Press the [MENU] key to exit.

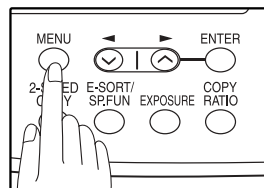

## STORING NUMBERS FOR AUTOMATIC DIALING

Automatic Dialing is a quick and convenient way to dial by using only a Rapid key (Rapid Key Dialing), or pressing the [SPEED/SEARCH] key and select the SPEED and entering a two digit number (Speed Dialing).

To use Automatic Dialing, you must first store the full number. The way you store it depends on whether you want to use it for Rapid Key Dialing or Speed Dialing:

### Storing numbers

Use the following procedure to store numbers for Rapid Key Dialing or Speed Dialing:

#### 1 Press the [MENU] key.

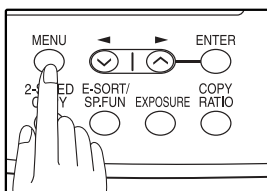

#### 2 Press the [◀] key (⏴) or [▶] key (⏵) until "2:ENTRY MODE" appears, and then press the [ENTER] key.

Selection

"2:ENTRY MODE"

#### 3 Press the [◀] key (⏴) or [▶] key (⏵) until "1:FAX NUMBER" appears, and then press the [ENTER] key.

Selection

"1:FAX NUMBER"

#### 4 Press the [◀] key (⏴) or [▶] key (⏵) to select the type of auto-dial number that you wish to program and then press the [ENTER] key.

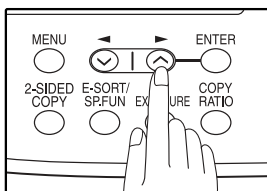

To program a Rapid Key, select "1:RAPID KEY".  
To program a Speed Dial number, select "2:SPEED #".

#### 5 Press the [◀] key (⏴) or [▶] key (⏵) to select "1:SET" and then press the [ENTER] key.

Selection

"1:SET"

#### 6 Press the Rapid Key or enter the Speed Dial number that you wish to program.

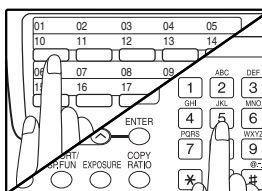

To program a Rapid Key, press a Rapid key ("01" to "18").

To program a Speed Dial number, press two numeric keys ("00" to "99") and then press the [ENTER] key.

#### 7 Enter the fax number with the numeric keys.

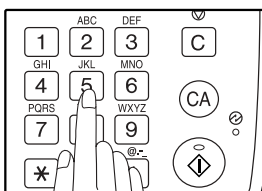

Enter the fax number (maximum of 40 digits including pauses) using the numeric keys.

#### 8 Press the [ENTER] key.

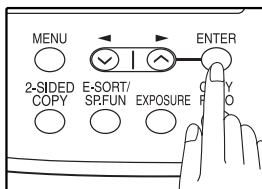

**9 Enter the name of the destination with the numeric keys.**

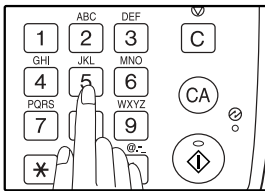

Enter the name of the location or party by pressing numeric keys as described in "HOW TO ENTER CHARACTERS" on page 20 (maximum of 20 characters). If you do not want to enter a name, skip this step.

**10 Press the [ENTER] key.**

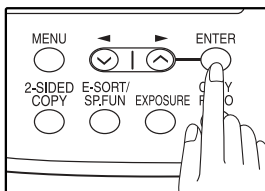

**11 Press the [◀] key (⏪) or [▶] key (⏩) to select a Chain Dial setting.**

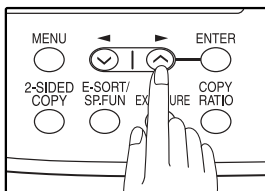

If you wish to set the number as a Chain Dial number, select "1:SET". Otherwise, select "2:CANCEL". (See "CHAIN DIALING" (p.60))

If the number is not set as a chain dial number, the communication speed and international communication mode cannot be selected. Press the [ENTER] key and go to step 17.

**12 Press the [ENTER] key.**

**13 Press the [◀] key (⏪) or [▶] key (⏩) to select the communication speed.**

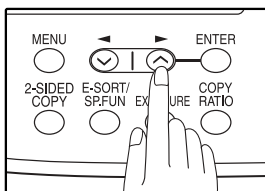

The selections are as follows:  
 1:33600bps  
 2:14400bps  
 3:9600bps  
 4:4800bps



For international dialing, if you find that line noise necessitates a slower transmission speed, set the appropriate transmission speed. If you are not sure if a slower speed is required, set the speed normally.

**14 Press the [ENTER] key.**

**15 Press the [◀] key (⏪) or [▶] key (⏩) to select the international communication mode.**

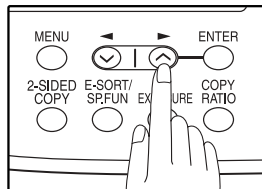

The selections are as follows:  
 1:NO  
 2:MODE 1  
 3:MODE 2  
 4:MODE 3



Sometimes when faxing internationally, line noise can cause the transmission to stop momentarily. To reduce these delays, choose the appropriate international transmission mode.

**2**

**16 Press the [ENTER] key.**

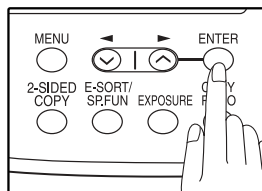

Return to Step 5 to store another number.

**17 Press the [MENU] key.**

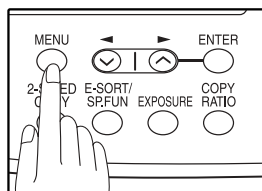

Press the [MENU] key to exit. If the number is a Rapid key number, you can write the name on the label above the appropriate Rapid key.



You may need to add a pause between certain digits in the number to allow time for connection. For example, if you are on a PBX telephone system that requires an access number, such as "9", to be dialed to access an outside line, you will need to enter a pause between the access number and the fax number of the other party. Pauses are entered by pressing the [REDIAL/PAUSE] key (2 seconds per pause). If necessary, several pauses can be entered in a row.

Use the following procedure to clear numbers:

**1 Press the [MENU] key.**

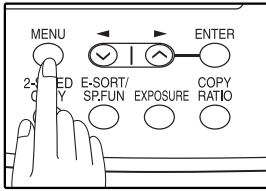

**2 Press the [◀] key (⏪) or [▶] key (⏩) until "2:ENTRY MODE" appears, and then press the [ENTER] key.**

Selection

"2:ENTRY MODE"

**3 Press the [◀] key (⏪) or [▶] key (⏩) until "1:FAX NUMBER" appears, and then press the [ENTER] key.**

Selection

"1:FAX NUMBER"

**4 Press the [◀] key (⏪) or [▶] key (⏩) to select the type of auto-dial number that you wish to delete.**

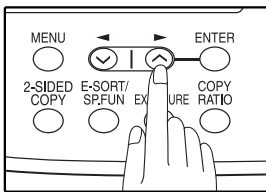

To delete a Rapid Key, select "1:RAPID KEY". To delete a Speed Dial number, select "2:SPEED #".

**5 Press the [◀] key (⏪) or [▶] key (⏩) until "2:CLEAR" appears, and then press the [ENTER] key.**

Selection

"2:CLEAR"

**6 Enter the Rapid Key or Speed Dial number that you wish to delete.**

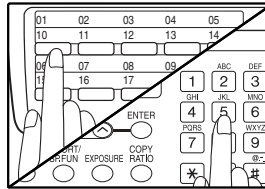

To delete a Rapid Key, press the appropriate Rapid key.

To delete a Speed Dial number, enter the 2-digit number with the numeric keys and then press the [ENTER] key.

**7 Press the [ENTER] key.**

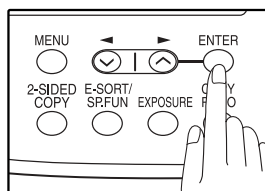

Return to Step 5 to clear another number.

**8 Press the [MENU] key.**

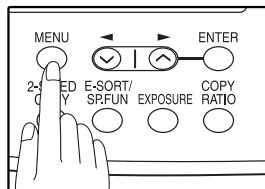

Press the [MENU] key a number of times until you exit.

**Note**

- A Rapid Key or Speed Dial number cannot be deleted if it has been stored in a Group Key.
- A Rapid Key or Speed Dial number cannot be deleted if it is being used for a transmission that has been stored or is in progress.



## STORING NUMBERS UNDER GROUP KEYS

Group keys allow you to dial a group of fax numbers by simply pressing the appropriate Group key once. They are convenient for the Broadcasting function, which is used to transmit an original to a group of fax machines.

All Rapid keys can be programmed as Group keys. To program or clear a group key, follow the steps below. Note that one key cannot be programmed as both a Rapid key and a Group key at the same time.

- Up to 100 fax numbers can be stored in one Group key.
- Rapid Keys, Speed Dial numbers, and numbers directly entered with the numeric keys can be stored in Group Keys.

Storing/adding numbers in a Group Key:

### 1 Press the [MENU] key.

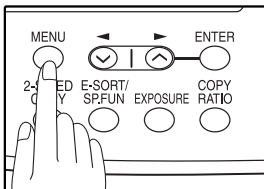

### 2 Press the [◀] key (⏪) or [▶] key (⏩) until "2:ENTRY MODE" appears, and then press the [ENTER] key.

Selection

"2:ENTRY MODE"

### 3 Press the [◀] key (⏪) or [▶] key (⏩) until "1:FAX NUMBER" appears, and then press the [ENTER] key.

Selection

"1:FAX NUMBER"

### 4 Press the [◀] key (⏪) or [▶] key (⏩) until "3:GROUP KEY" appears, and then press the [ENTER] key.

Selection

"3:GROUP KEY"

### 5 Press the [◀] key (⏪) or [▶] key (⏩) to select "1:SET" and then press the [ENTER] key.

Selection

"1:SET"

### 6 Press the Rapid key you wish to use as a Group key .

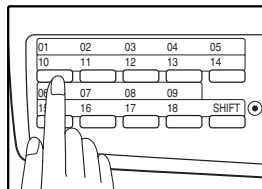

To add numbers:  
After pressing the Group Key, press the [◀] key (⏪) or [▶] key (⏩) to select "1:YES" and then press the [ENTER] key.

### 7 Enter the numbers that you wish to store in the Group Key.

Enter the fax numbers using any of the following methods:

- Press a Rapid Key and then press the [ENTER] key.
- Enter a Speed Dial number with the numeric keys and then press the [ENTER] key.
- Enter a number with the numeric keys and then press the [ENTER] key.



- One Group Key cannot be stored in another Group Key.
- A message will appear if you select a Rapid Key or Speed Dial number that is already stored in another Group Key.

### 8 Press the [ENTER] key.

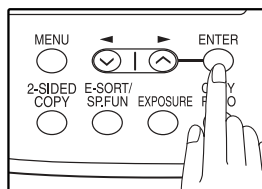

2

**9** Enter a name for the Group Key with the numeric keys.

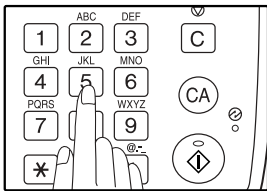

Enter the name of the group by pressing numeric keys as described in "HOW TO ENTER CHARACTERS" on page 20 (maximum of 20 characters). If you do not want to enter a name, skip this step.

To add numbers:  
The entered name appears. Edit the name if you need to make a change.

**10** Press the [ENTER] key.

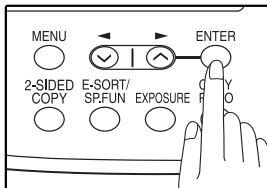

Return to Step 7 to program another Group key.

**11** Press the [MENU] key.

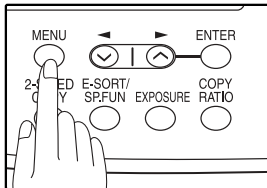

Press the [MENU] key to exit.

Deleting numbers from Group Keys:

### 1 Press the [MENU] key.

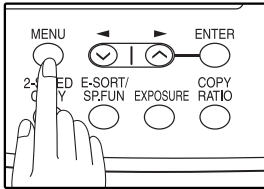

### 2 Press the [◀] key (⏪) or [▶] key (⏩) until "2:ENTRY MODE" appears, and then press the [ENTER] key.

Selection

"2:ENTRY MODE"

### 3 Press the [◀] key (⏪) or [▶] key (⏩) until "1:FAX NUMBER" appears, and then press the [ENTER] key.

Selection

"1:FAX NUMBER"

### 4 Press the [◀] key (⏪) or [▶] key (⏩) until "3:GROUP KEY" appears, and then press the [ENTER] key.

Selection

"3:GROUP KEY"

### 5 Press the [◀] key (⏪) or [▶] key (⏩) to select "2:CLEAR" and then press the [ENTER] key.

Selection

"2:CLEAR"

To delete a Group, press the appropriate Group key.

### 6 Press the [◀] key (⏪) or [▶] key (⏩) to select "1:FAX #" and then press the [ENTER] key.

Selection

"1:FAX #"

To delete all numbers from the Group Key:  
Select "2:GROUP" and press the [ENTER] key.

### 7 Enter the numbers that you wish to delete.

Enter the fax numbers using any of the following methods:

- Press a Rapid Key.
- Enter a Speed Dial number with the numeric keys.
- Enter a number with the numeric keys.

### 8 Press the [ENTER] key.

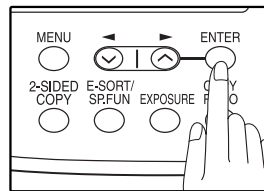

### 9 To exit, press the [◀] key (⏪) or [▶] key (⏩) to select "2:END".

Selection

"2:END"

To program another Group Key, select "1:CONTINUE", press the [ENTER] key, and return to step 7.

### 10 Press the [ENTER] key.

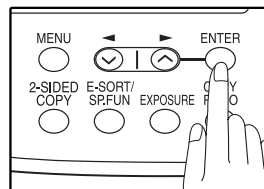

### 11 Press the [MENU] key.

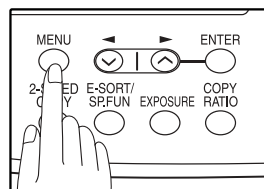

Press the [MENU] key to exit.

2

# USING THE MACHINE WITH AN ANSWERING MACHINE

## QUIET DETECT TIME

Quiet Detect Time is the function that enables the machine to be used along with an answering machine for both phone messages and faxes. After the answering machine has answered, any duration of silence longer than a certain threshold time will prompt the machine to take over the line and prepare to receive a fax. The Quiet Detect Time can be set from 00 to 10 seconds, following the procedure below.

### 1 Press the [MENU] key.

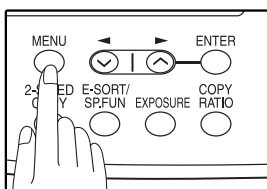

### 2 Press the [◀] key (⏪) or [▶] key (⏩) until "6:A.M. MODE" appears, and then press the [ENTER] key.

Selection

"6:A.M. MODE"

### 3 Press the [◀] key (⏪) or [▶] key (⏩) until "1:QUIET DETECT TIME" appears, and then press the [ENTER] key.

Selection

"1:QUIET DETECT TIME"

### 4 Enter the Quiet Detect Time with the numeric keys.

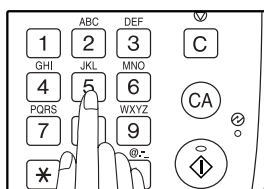

Enter the Quiet Detect Time in seconds, from 00 to 10. (setting "00" turns off Quiet Detect Time)

### 5 Press the [ENTER] key.

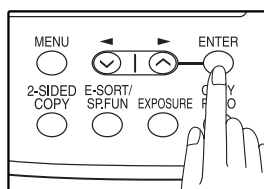

### 6 Press the [MENU] key.

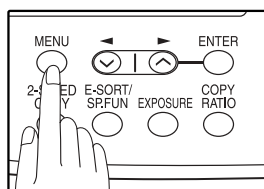

Press the [MENU] key to exit.



- The machine has been set at the factory for a Quiet Detect Time of 5 seconds, which gives the best performance for most answering machines. However, you may have to adjust the Quiet Detect Time depending on your answering machine's disconnect time, the time before the machine disconnects the line after a period of silence. If your machine has a short disconnect time, you may have to shorten the Quiet Detect Time. However, if the machine is interrupting callers in the middle of messages, you should set a longer Quiet Detect Time.
- If there is a pause at the end of your answering machine message, make sure that the Quiet Detect Time is longer than this pause.
- Setting Quiet Detect Time to 00 turns the function off. However, the machine will not be able to receive faxes sent using manual dialing (picking up the receiver, dialing the number, and pressing the [START] key (⏺) when the fax tone is heard).
- If your answering machine is set to answer calls after more rings than the machine's number of rings setting, the machine will always answer first and thereby prevent callers from leaving messages in the answering machine.

## If Quiet Detect Time is not working properly...

With some answering machines, there is simply no Quiet Detect Time that will allow both reception of faxes and uninterrupted voice messages. Even in this case, however, you can set up the machine to receive both phone and fax messages from callers on touch-tone lines. Follow this procedure:

1. Set the Quiet Detect Time to 00.
2. Alter your phone message to tell callers that they can send a fax by pressing the Remote Reception Number (factory set to 5), followed by the " \* " key twice.

## ANSWERING MACHINE BACKUP

There may be times when the tape on your answering machine becomes full, or when the answering machine itself malfunctions. It is still possible to receive faxes even under these conditions, by turning on the Auto Receive function. The machine will automatically answer all calls after five rings. To use this function, follow the procedure below.

### 1 Press the [MENU] key.

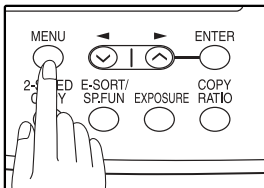

### 2 Press the [◀] key (⓪) or [▶] key (Ⓛ) until "6:A.M. MODE" appears, and then press the [ENTER] key.

Selection

"6:A.M. MODE"

### 3 Press the [◀] key (⓪) or [▶] key (Ⓛ) until "2:AUTO RECEIVE" appears, and then press the [ENTER] key.

Selection

"2:AUTO RECEIVE"

### 4 Press the [◀] key (⓪) or [▶] key (Ⓛ) to select "1:ON" or "2:OFF".

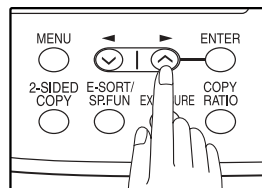

Select "1:ON" to enable the function.  
Select "2:OFF" to disable the function.

### 5 Press the [ENTER] key.

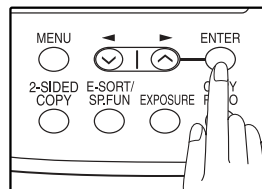

### 6 Press the [MENU] key.

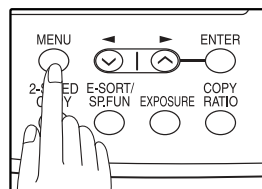

Press the [MENU] key to exit.



**Note** If you are using Auto Receive, make sure that your answering machine is set to answer on four rings or less. Otherwise, the machine will take over all calls, preventing callers from leaving voice messages.

# 2

# 3

## Chapter 3

# CHOOSING SUITABLE MEDIA

## ORIGINALS SUITABLE FOR FAXING

Make sure that the originals you want to fax meet specifications and guidelines listed in this section.

### SIZE AND WEIGHT

The size and weight of originals that you can load in the RSPF depend on whether you load one sheet at a time or several sheets at once.

#### When using the RSPF

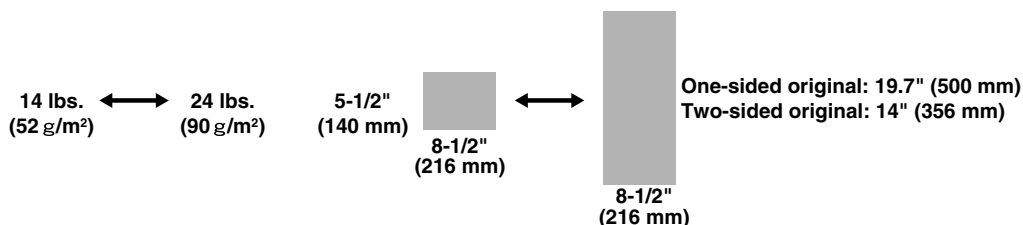

When feeding in a long original, grasp the original at the edges to guide it into the machine.

#### When using the document glass

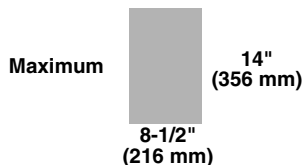

When you are using the faxing functions of the machine, your originals are, in effect, being scanned through the machine. The area of a original that is scanned by the machine while faxing is slightly smaller than the actual original size. Any text or graphics outside this area will not be scanned.

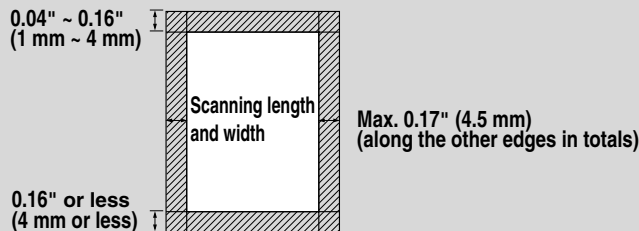

## UNSUITABLE ORIGINALS

General guidelines:

- All clips, staples, and pins should be removed from originals before they are used. If these are not removed, they may damage the machine.
- Ink, glue, and correction fluid on originals must be completely dry before using the originals with the machine.
- Originals that are in some way dangerous to the internal mechanisms of the machine should not be used.
- When faxing, any writing on the originals that is yellow, yellowish-green, or light blue cannot be transmitted.

The following kinds of originals should not be used:

- Originals with a glossy coating
- Originals with static electricity
- Originals with tears, folds, or curls
- Originals that have become stuck together and cannot be easily separated
- Originals with holes, windows, or perforations
- Transparency films, tracing paper, or other transparencies
- Originals with plastic or metallic coatings

**3**

- SHARP does not accept any responsibility for the loss or damage of originals.
- Scanning an original that is longer than 500 mm will result in a misfeed.

# 4

## Chapter 4

# HOW TO USE THE FAX FUNCTION

The machine offers a range of sophisticated features that allow you to control image quality, reception mode, broadcasting, polling, and transmission priorities. Functions such as sending original(s) from memory and substituting reception into memory are possible, due to the large memory capacity.

---

---

## SENDING ORIGINALS

### SETTING THE ORIGINAL

This section describes setting original(s) in the RSPF or on the document glass.

When Using the RSPF:

**1** Confirm that there are no original(s) on the document glass and that copying is not in progress, then gently close the RSPF.

**2** Adjust the original guides to the width of your original(s).

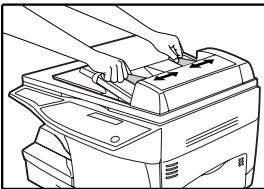

**3** Place the original(s) face up and push it gently into the document feeder tray. The top edge of the original(s) should enter the fax first.

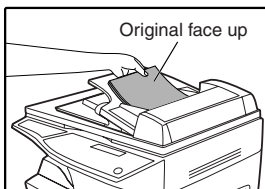

**4** There are two ways to send the fax:

- To scan the original into memory, then dial and transmit, continue with the "DIALING AND TRANSMITTING" section. (p.59)
- To dial and transmit the original directly without first scanning it into memory, press the [MEMORY] key to make the [MEMORY] key indicator go off. Continue with the "DIALING AND TRANSMITTING" section. (p.59)



When placing the Original on the document glass:

**1** Confirm that there are no original(s) in the RSPF, and open the RSPF.

**2** Place the original face down on the document glass. Align the original according to the original scale in the illustration below. (Line up the center of the edge of the original with the (▶) mark.)

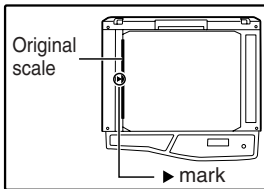

**3** Gently close the RSPF.

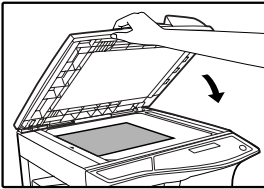

**Note** When using the document glass, do not set original(s) in the RSPF.

**4** If needed, set the original size (p.54), resolution (p.55), and contrast (p.55). Continue with the "DIALING AND TRANSMITTING" (p.59) section.

**5** Press the [START] key (Ⓢ).

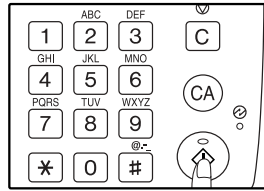

The set original size appears in the display and then scanning begins.



After the [START] key (Ⓢ) is pressed, the set original size appears in the display.

(EX.)

READING	#001
8.5x11	100%

Make sure that the displayed size is the same as the actual original size. (The factory default setting for the original size is "8.5x11".) If the displayed size is not correct, press the [CLEAR ALL] key (CA) to stop operation and then change the original size setting. (See "ORIGINAL SIZE" (p.54)) When faxing from the document glass, if the size of the original is different from the specified size, part of the image may be cut off.

**4**

**6** If you have more than one original to read into memory, place the next page, and press the [START] key (Ⓢ) to read each page.

Go to step 7 after the last page has been scanned.

**7** Press the [#] key.



Transmission begins.

# OPTIONAL TRANSMISSION SETTINGS

There are several transmission settings that you can make before dialing and transmitting an original.

## ORIGINAL SIZE

The original size can be set to "8.5x11", "8.5x14", or "A4". The setting is only effective for one transmission. If desired, you can set a fixed original size that remains in effect for all transmissions.

### 1 Press the [MENU] key.

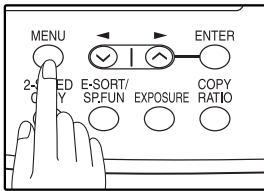

### 5 Press the [ENTER] key.

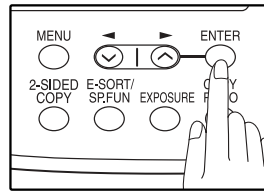

### 2 Press the [◀] key (⏪) or [▶] key (⏩) until "4:USER PROGRAM" appears, and then press the [ENTER] key.

Selection

"4:USER PROGRAM"

### 6 Press the [MENU] key.

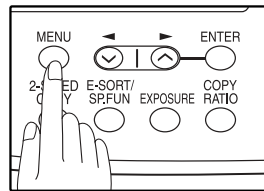

Press the [MENU] key to exit.

### 3 Press the [◀] key (⏪) or [▶] key (⏩) until "1:DOC. GLASS SIZE" appears, and then press the [ENTER] key.

Selection

"1:DOC. GLASS SIZE"

To set a fixed original size for all transmissions:  
Press the [◀] key (⏪) or [▶] key (⏩) to select "2:FIXED DOC. SIZE".



To temporarily change the original size setting when faxing from the document glass, use the "1: DOC. GLASS SIZE" setting. To change the permanent original size setting, use the "2: FIXED DOC. SIZE" setting.

### 4 Press the [◀] key (⏪) or [▶] key (⏩) to select the original size.

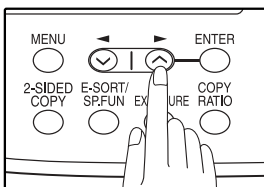

The selections are as follows:  
1:8.5x11  
2:8.5x14  
3:A4

## RESOLUTION

To do this, press the [RESOLUTION] key one or more times until the desired resolution settings appear in the display, and then press the [ENTER] key.

Your fax has five resolution settings:

- **STANDARD**  
Use STANDARD for ordinary originals. This setting gives you the fastest transmission.
- **FINE**  
Use FINE for improved reproduction, especially with originals containing small letters or fine drawings.
- **SUPER FINE**  
Use SUPER FINE when you need the highest quality of reproduction.
- **FINE (HALF TONE)**  
Use FINE (HALF TONE) if your original is a photograph or has gradations of color (such as a color original). This setting will produce a clearer image than Fine used alone.
- **S. FINE (HALF TONE)**  
Use S.FINE (HALF TONE) if your original is a photograph or has gradations of color (such as a color original). This setting will produce a clearer image than Super fine used alone.

In order to transmit with FINE or SUPER FINE resolution, the receiving fax machine must also have that resolution. If it doesn't, the next best available setting will be used.

If you do not change the setting, the resolution set using the RESOLUTION PRIORITY setting will be automatically selected.

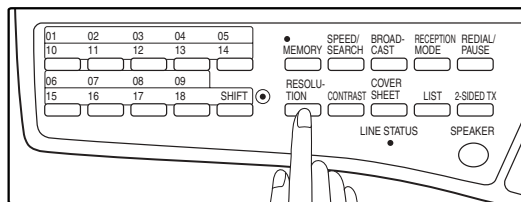

4

## CONTRAST

The fax automatically controls the contrast, but you can also control it manually. To do this, press the [CONTRAST] key one or more times until the desired contrast settings appear in the display, and then press the [ENTER] key. The three contrast levels are MEDIUM, DARK, and LIGHT.

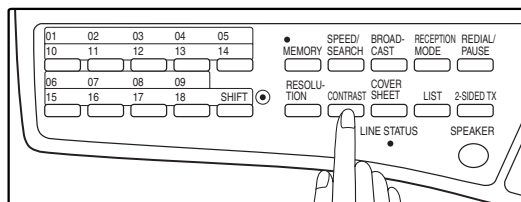

# COVER SHEET

You can have your fax generate a cover sheet and send it as the last page of the transmission. The cover sheet includes the date and time, the sender's name and number, and the receiver's name and number if an automatic dialing number is used. The total number of pages sent is indicated on the bottom.

One of five messages can also be added to the cover sheet.

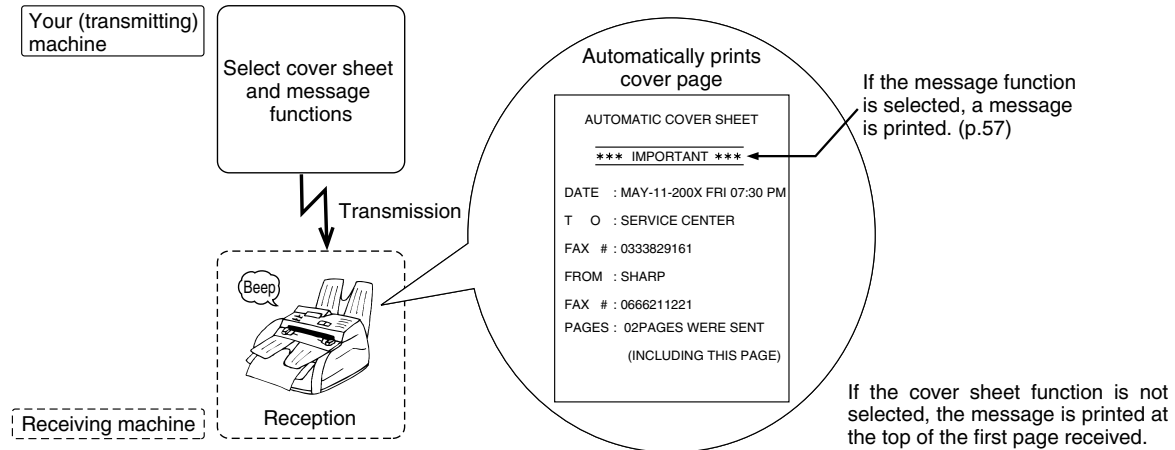

- The receiver's name must be programmed in either the Rapid Key or Speed Dial function for it to appear on the Cover Sheet.
- The cover sheet function must be selected each time you wish to add a cover sheet to a fax transmission.
- To add a message to a cover sheet, the message must be selected using the message function.

To include a cover sheet with a transmission, follow these steps:

**1** Press the [COVER SHEET] key until "1:COVER SHEET SET" appears, and then press the [ENTER] key.

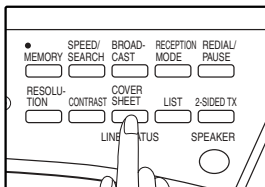

Selection

"1:COVER SHEET SET"

**3** Press the [ENTER] key.

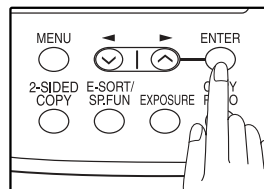

**2** Press the [←] key (☑) or [→] key (☒) to select "1:ON" or "2:OFF".

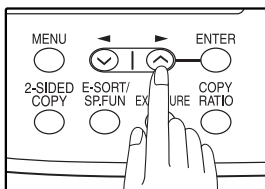

Select "1:ON" to enable the function.  
Select "2:OFF" to disable the function.

# MESSAGE FUNCTION

One of the following messages can be selected: "CONFIDENTIAL", "PLS. DISTRIBUTE", "URGENT", "PLS. CALL BACK", "IMPORTANT".



If a message is selected when the cover sheet function is not used, the message will be added to the top of the first page of the fax.

To add a message to a cover sheet, follow these steps:

## 1 Press the [COVER SHEET] key.

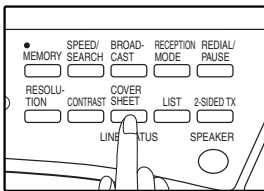

## 2 Press the [COVER SHEET] key until "2:TX MESSAGE SET" appears, and then press the [ENTER] key.

Selection

"2:TX MESSAGE SET"

4

## 3 Press the [◀] key (⏪) or [▶] key (⏩) to select a message.

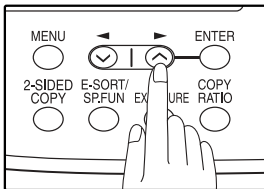

The selections are as follows:

- 1:NO MASSAGE
- 2:CONFIDENTIAL
- 3:PLS. DISTRIBUTE
- 4:URGENT
- 5:PLS. CALL BACK
- 6:IMPORTANT

If you do not wish to add a message, select "1:NO MESSAGE".

## 4 Press the [ENTER] key.

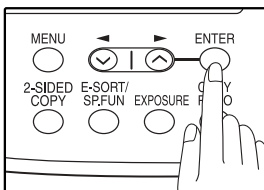

## TWO-SIDED ORIGINAL TRANSMISSION FUNCTION

The RSPF can be used to automatically fax a two-sided original. If desired, the back of the original can be rotated 180° before transmission.



- The original must be placed in the RSPF when using the two-sided original transmission function. The document glass cannot be used.
- The two-sided original transmission function cannot be selected when direct transmission mode is selected. Likewise, direct transmission mode cannot be selected when the two-sided original transmission function is selected.

Follow these steps to fax a two-sided original:

### 1 Place the original(s) in the RSPF. (p.52)

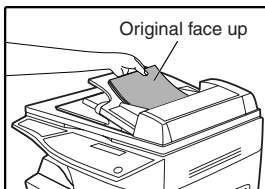

For the size and weight of two-sided originals that can be scanned using the RSPF, see page 50.

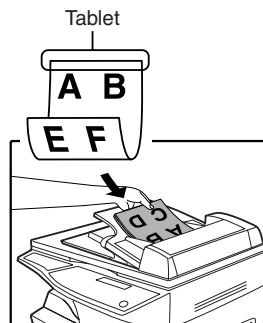

If you are faxing a two-sided tablet type original, select "ON (NON-ROTATE)".

### 2 Press the [2-SIDED TX] key until the appropriate setting appears.

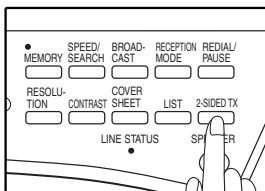

The selections are as follows:  
 OFF  
 ON (ROTATE)  
 ON (NON-ROTATE)

Select the setting according to the original type (booklet or tablet) as indicated below. If the setting is incorrect, every other page of the received fax will be inverted.

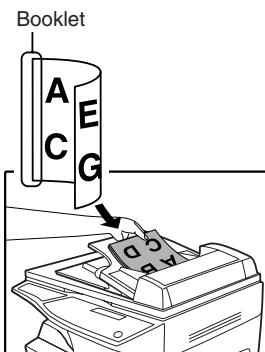

If you are faxing a two-sided booklet type original, select "ON (ROTATE)".

To cancel this function, select "OFF".

### 3 Press the [ENTER] key.

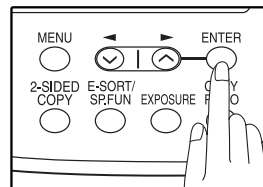

# DIALING AND TRANSMITTING

Once you have set the original (either in the RSPF or on the document glass), and have selected the desired transmission settings, you are ready to dial the number of the receiving fax machine and transmit the original. You can choose from one of the several ways of dialing that best suit your needs.

## DIRECT KEYPAD DIALING

If the number of the fax you want to reach is not a Rapid key or Speed Dial number, use Direct Keypad Dialing to manually enter it using the following procedure:

**1** Confirm that you have correctly set the original in the RSPF or on the document glass. (See "SETTING THE ORIGINAL" (p.52))

**2** Enter the number of the fax machine you want to send to by pressing the numeric keys.

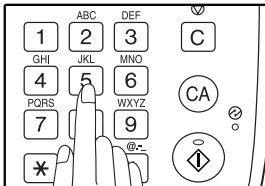

If it is not correct, press the [CLEAR] key (C) to backspace and clear one digit at a time, and then enter the correct number.

**3** Check the display. If the number of the receiving machine is shown correctly, press the [START] key (☎).

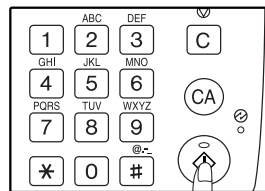

4

## RAPID KEY DIALING

If the number you want to dial has been stored as a Rapid key number (See "STORING NUMBERS FOR AUTOMATIC DIALING" (p.42)), you can dial it by pressing the appropriate Rapid key as shown:

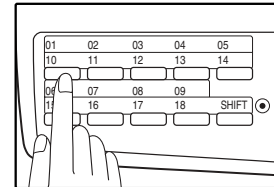

## SPEED DIALING

If the number you want to dial has been stored as a Speed Dial number, you can dial it using the following procedure:

**1** Press the [SPEED/SEARCH] key and then enter the two-digit number by pressing the numeric keys (See "STORING NUMBERS FOR AUTOMATIC DIALING" (p.42)).

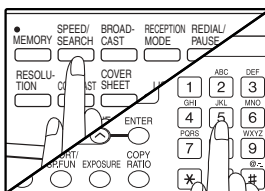

If it is not correct, press the [CLEAR] key (C) to backspace and clear two digit at a time, and then enter the correct number.

**2** Press the [START] key (☎) and check the name or number that appears in the display.

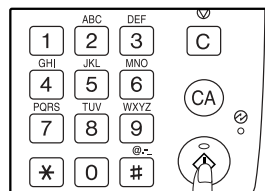

## CHAIN DIALING

The Chain Dialing function allows you to combine a Rapid Key or Speed Dial number (See "STORING NUMBERS FOR AUTOMATIC DIALING" (p.42)) set for Chain Dialing with another Rapid Key, Speed Dial number, or number dialed with the numeric keys to dial one fax number up to 50 digits long. The following are some examples of how this can be done:

- Press Rapid Keys set for Chain Dialing in the correct order for the fax number that you wish to dial. For example, press Rapid Key 01 followed by Rapid Key 02. The final Rapid Key pressed for the fax number must not be set for Chain Dialing. Transmission will begin automatically when the final Rapid Key is pressed.
- Enter Speed Dial numbers set for Chain Dialing in the correct order for the fax number that you wish to dial. For example, press the [SPEED/SEARCH] key and [2] [2], followed by the [SPEED/SEARCH] key and [2] [7]. The final Speed Dial number entered for the fax number must not be set for Chain Dialing. Transmission will begin when the [START] key (Ⓢ) is pressed after the final Speed Dial number is entered.
- Enter the fax number that you wish to dial with the numeric keys. Press the [REDIAL/PAUSE] key to enter a pause and then enter the next number. Transmission will begin when the [START] key (Ⓢ) is pressed after the final number is entered.



- To use a Rapid Key or Speed Dial number for Chain Dialing, the Rapid Key or Speed Dial number must be set for Chain Dialing when it is stored (See "STORING NUMBERS FOR AUTOMATIC DIALING" (p.42)).
- When using Chain Dialing, the international communication setting of the final number entered is effective. International communication mode cannot be used if the final number is entered using a Rapid Key or Speed Dial number that does not have the setting enabled, or if the final number is entered with the numeric keys.

## NORMAL DIALING USING THE [SPEAKER] KEY

When dialing normally with the [SPEAKER] key, press the [SPEAKER] key and dial using the numeric keys. You can hear the line and fax tones from the other machine through the speaker, allowing you to confirm the response of the other machine.

**1** Set the original in the RSPF and press the [SPEAKER] key. (See "SETTING THE ORIGINAL" (p.52))

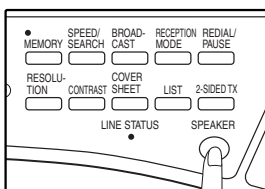

To adjust the volume, press the left and [◀] key (Ⓢ) or [▶] key (Ⓢ).

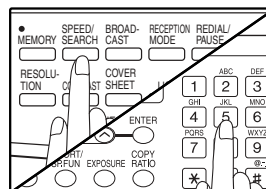

Dialing with a Speed Dial number and then press the [ENTER] key or [START] key (Ⓢ).

**2** Dial the fax number of the receiving machine.

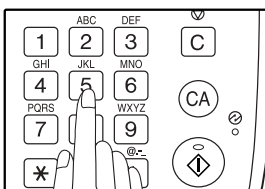

Dialing with the numeric keys.

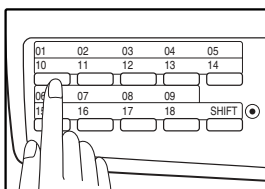

Dialing with a Rapid Key.

**3** When you hear the fax reception tone of the other machine, press the [START] key (Ⓢ).

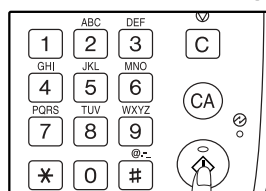

**4** Press the [◀] key (Ⓢ) or [▶] key (Ⓢ) to select "1:SEND", and then press the [ENTER] key or [START] key (Ⓢ).



## USING THE SEARCH KEY

If you do not remember the Rapid key or Speed Dial number in which you have stored a particular fax number, you can search for the number by following the steps below:

- 1 Press the [SPEED/SEARCH] key twice.

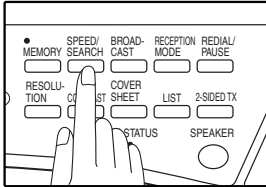

- 2 Enter the first letter of the stored name by pressing the appropriate numeric key (the key below the marked letter) until the letter appears in the display. If the name begins with a special character or number, press [1] key.

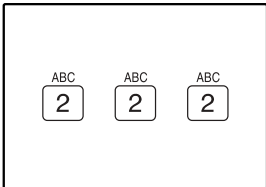

If you do not remember the first letter, go to Step 3 and scroll through the list from the beginning.

- 3 Press the [ENTER] key.

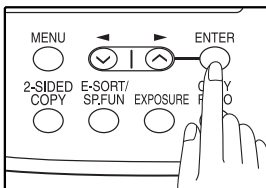

- 4 Press the [◀] key (▽) or [▶] key (△) to scroll through the names. Stop when the desired name appears in the display.

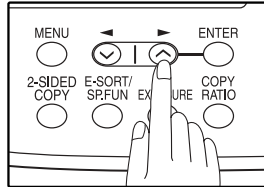

- 5 Press the [START] key (Ⓢ). The original will be automatically transmitted once the connection is made.

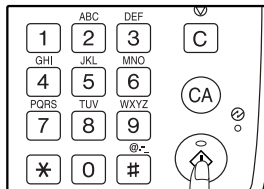

4

## REDIALING

You can send a fax to the number you last dialed, you can redialing it using the following procedure:

- 1 Press the [REDIAL/PAUSE] key.

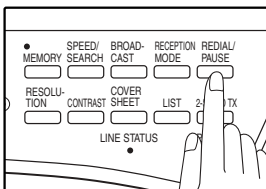

- 2 Press the [START] key (Ⓢ).

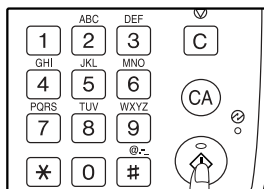

---

---

# IF THE MEMORY BECOMES FULL WHILE SCANNING AN ORIGINAL

If the memory becomes full while scanning an original, "MEMORY FULL ERROR" will appear in the display and scanning will stop.

If the memory becomes full while the first page is being scanned, scanning will stop and the transmission will be canceled.

If the memory becomes full while scanning a page after the first page, scanning will stop. You can transmit the pages that have already been scanned, or cancel the transmission and clear the pages from memory.

Follow the steps below to transmit or clear the pages that have already been scanned.

1. The memory becomes full and scanning stops. "MEMORY FULL ERROR" appears in the display.
2. To clear the pages that have already been scanned and cancel transmission, press the [◀] key (⊙) or [▶] key (⊙) to select "2:CANCEL". To transmit the pages that have already been scanned, select "1:SEND XX?".
3. Press the [ENTER] key  
The pages are cleared from memory. If you selected "1:SEND XX?" in step 2, the pages are automatically transmitted.



If you are using Quick On-line transmission (p.26), the pages that were scanned are automatically transmitted.

---

---

# CANCELING (DELETING) A STORED FAX JOB

This procedure is used to check and cancel a fax job that is waiting for transmission, such as an automatic recalling job, a stored fax job, a remote transmission job, or a timer transmission job.



A stored fax job cannot be canceled while transmission of another job is in progress. Wait until transmission is finished and then cancel the stored job.

Follow the steps below to cancel (delete) a fax job:

## 1 Press the [MENU] key.

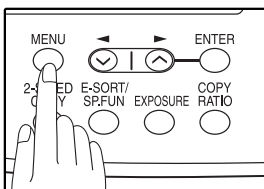

## 2 Press the [◀] key (⊙) or [▶] key (⊙) until "3:MEMORY STATUS" appears, and then press the [ENTER] key.

Selection

"3:MEMORY STATUS"

## 3 Press the [◀] key (⊙) or [▶] key (⊙) until the job that you wish to cancel appears in the display and press the [CLEAR] key (⊙).

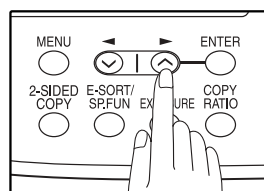

The job to be canceled is selected.

## 4 Press the [ENTER] key.

The selected job is deleted.

## 5 Press the [MENU] key.

Press the [MENU] key to exit.

---

---

# RECEIVING FAXES

You can set the machine to one of three modes of reception, **AUTO**, **MAN.**, or **A.M.** (Answering Machine). To select the reception mode, press the [RECEPTION MODE] key until the desired reception mode appears in the display.

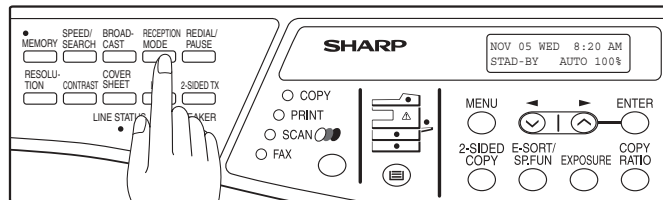

## USING AUTO MODE

Select **AUTO** mode when you only want to receive faxes on your telephone line. The machine will automatically answer all calls and receive incoming faxes.

## USING MAN. MODE

**MAN.** is the most convenient mode for receiving phone calls if you have an extension phone. To have true manual mode, the machine must be set to not answer while in MANUAL mode (See "SETTING THE NUMBER OF RINGS FOR MANUAL RECEPTION" (p.29)). You can also receive faxes; however, all calls must first be answered by picking up the receiver on the extension phone or telephone connected to the same line.

## USING A.M. MODE

Select this mode when an answering machine is connected to the machine and you want the answering machine to answer all calls. This allows you to receive both voice messages and faxes when you are out.

4

# OPTIONAL RECEPTION SETTINGS

The machine has various optional settings for the reception of faxes.

## TWO-SIDED RECEPTION

This function is used to print a received fax consisting of two or more pages of the same size on both sides of the paper. Even if the pages are in different orientations, the pages are rotated appropriately to enable printing on both sides of the paper.



The two-sided reception function cannot be used when printing a transaction report or activity report.

To use this feature, follow this procedure:

### 1 Press the [MENU] key.

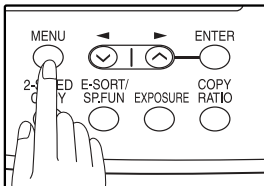

### 2 Press the [◀] key (⏪) or [▶] key (⏩) until "4:USER PROGRAM" appears, and then press the [ENTER] key.

Selection

"4:USER PROGRAM"

### 3 Press the [◀] key (⏪) or [▶] key (⏩) until "26:2-SIDED RX" appears, and then press the [ENTER] key.

Selection

"26:2-SIDED RX"

### 4 Press the [◀] key (⏪) or [▶] key (⏩) to select "1:ON" or "2:OFF".

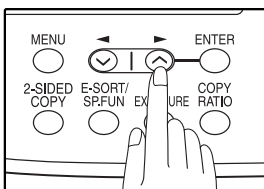

Select "1:ON" to enable the function.  
Select "2:OFF" to disable the function.

### 5 Press the [ENTER] key.

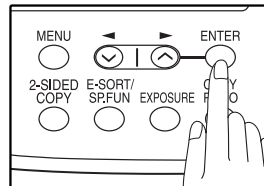

### 6 Press the [MENU] key.

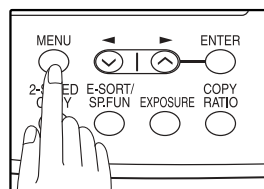

Press the [MENU] key to exit.

# RECEIVE REDUCE

You may on occasion receive faxes that are larger than the paper loaded in the machine. To ensure that you do not lose any part of the original, you should use the Receive Reduce function, which scales the fax to the printing paper size.



In some cases the size or resolution of a received fax may not permit reduction. When this happens the fax will be printed at full size and divided onto multiple sheets of paper.

To use this feature, follow this procedure:

## 1 Press the [MENU] key.

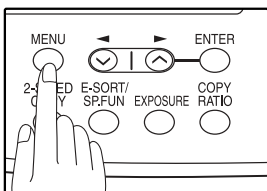

## 2 Press the [◀] key (⏪) or [▶] key (⏩) until "4:USER PROGRAM" appears, and then press the [ENTER] key.

Selection

"4:USER PROGRAM"

## 3 Press the [◀] key (⏪) or [▶] key (⏩) until "16:RCV REDUCE" appears, and then press the [ENTER] key.

Selection

"16:RCV REDUCE"

## 4 Press the [◀] key (⏪) or [▶] key (⏩) to select "1:ON" or "2:OFF".

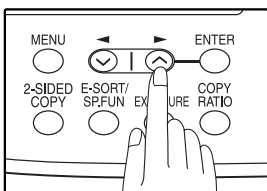

If you "2:OFF" (No reduction) large faxes will be printed on two sheets of paper.

## 5 Press the [ENTER] key.

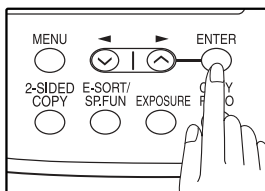

## 6 Press the [MENU] key.

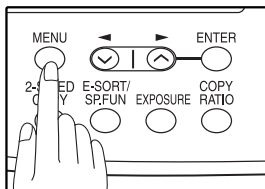

Press the [MENU] key to exit.

4

---

---

# WHEN USING MANUAL SENDING AND RECEIVING

You need to use the [SPEAKER] key or an extension telephone to perform manual sending and receiving. For information about connecting an extension telephone See "CONNECTING OTHER DEVICES" (p.12).

## 1 When the extension telephone rings, pick up the handset and converse.

If the [SPEAKER] key is used to answer a call you cannot converse.



You cannot use the [SPEAKER] key for fax transmission/reception while copying is in progress.

## 2 When the handset is off hook or the [SPEAKER] key is used, press the [START] key (Ⓢ).

MANUAL MODE 1:SEND, 2:RECEIVE
----------------------------------

Press the [◀] key (⏪) or [▶] key (⏩) to select "1:SEND" or "2:RECEIVE", and then press the [ENTER] key or [START] key (Ⓢ).

# 5

## Chapter 5 SPECIAL FUNCTIONS

---

---

### MEMORY

Your machine has a memory area that can be used to store both incoming faxes and outgoing originals.

- Approximately 120 pages of average content can be held in memory for transmission and reception. Less can be held if any of the pages were scanned using fine or superfine resolution.

#### Substitute Reception into Memory

This is a back-up function that is automatically activated if your fax runs out of paper, the TD cartridge needs replacement (See the Operation Manual for general information.), or the paper jams.

- If you received originals in memory because the fax ran out of paper, be sure to add paper which is the same size as the paper previously used. If not, the original print-out size may not match the size of the printing paper.



Take care that the remaining memory does not become 7% or less, or you cannot receive any more faxes. When the machine is idle, the LCD shows the stand-by memory available. (See "ABOUT THE LIQUID CRYSTAL DISPLAY" (p.16))

---

---

### PRINT HOLD MODE

PRINT HOLD MODE can be enabled to have received faxes held in memory instead of being automatically printed out. Received faxes cannot be printed until a previously programmed passcode is entered. This mode is used to ensure that received faxes are not misplaced or taken from the paper output tray by another person.

To enable this mode, a passcode must first be programmed. You will be prompted to enter this passcode when printing received faxes that are held in memory. PRINT HOLD MODE cannot be enabled until a passcode has been programmed. To program a passcode, see "PRINT PASSCODE" on page 68. To print out received faxes held in memory when PRINT HOLD MODE is enabled, see "HOLD DATA PRINT" on page 69.



When PRINT HOLD MODE is enabled, the following reports are held in memory instead of being printed when printing is executed.

- Reports that are printed as explained in "PRINTING OUT REPORTS" (p.85).
- Reports that are set to print as explained in "ACTIVITY REPORT AUTO LISTING" (p.88) and "PRINTING TRANSACTION REPORTS" (p.89).

To print out reports held in memory, execute HOLD DATA PRINT (p.69).

### ENABLING PRINT HOLD MODE

Follow the steps below to enable PRINT HOLD MODE.

#### 1 Press the [MENU] key.

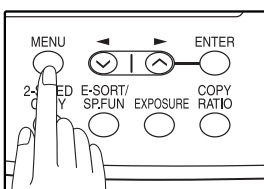

#### 2 Press the [◀] key (⊖) or [▶] key (⊕) until "4:USER PROGRAM" appears, and then press the [ENTER] key.

Selection

"4:USER PROGRAM"

**3** Press the [**◀**] key (⏪) or [**▶**] key (⏩) until "24:PRINT HOLD MODE" appears, and then press the [ENTER] key.

Selection

"24:PRINT HOLD MODE"

**4** Press the [**◀**] key (⏪) or [**▶**] key (⏩) to select "1:ON" or "2:OFF".

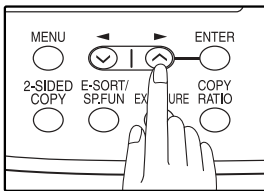

Select "1:ON" to enable the function.  
Select "2:OFF" to disable the function.

**5** Press the [ENTER] key.

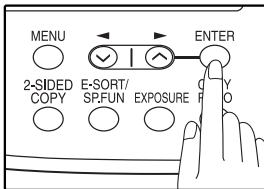

**6** Enter a four-digit number that identifies the passcode number and then press the [ENTER] key.

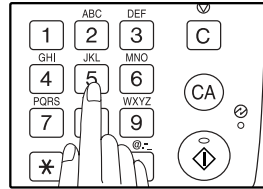

If you enter an incorrect passcode three times in a row, the machine will exit PRINT HOLD mode.

**7** Press the [MENU] key.

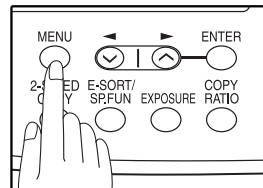

Press the [MENU] key to exit.

## PRINT PASSCODE

Follow the steps below to program the PRINT PASSCODE.



If you wish to clear a previously programmed passcode, disable PRINT HOLD MODE first and then follow the steps below. The passcode cannot be cleared if PRINT HOLD MODE is enabled.

**1** Press the [MENU] key.

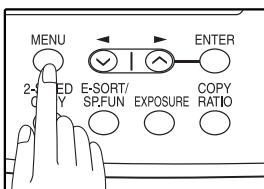

**2** Press the [**◀**] key (⏪) or [**▶**] key (⏩) until "4:USER PROGRAM" appears, and then press the [ENTER] key.

Selection

"4:USER PROGRAM"



- 3** Press the [◀] key (⏪) or [▶] key (⏩) until "25:PRINT PASSCODE" appears, and then press the [ENTER] key.

Selection

"25:PRINT PASSCODE"

- 4** Press the [◀] key (⏪) or [▶] key (⏩) to select "1:SET" and press the [ENTER] key.

Selection

"1:SET"

**To clear a passcode number:**  
Select "2:CLEAR" and press the [ENTER] key.

- 5** Enter a four-digit number that will be used to identify the passcode number and then press the [ENTER] key.

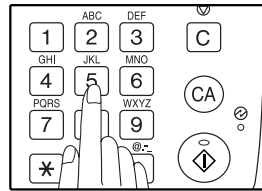

**To delete a passcode number:**

Enter the four-digit number that identifies the passcode number and press the [ENTER] key. The passcode is cleared.

- 6** Press the [MENU] key.

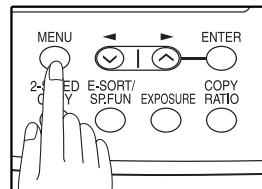

Press the [MENU] key to exit.

After the passcode is stored, the PRINT HOLD PASSCODE LIST is printed. This list provides a record of the passcode in case it is forgotten, and the administrator of the machine should store the list in a safe place where other people will not see it.

## HOLD DATA PRINT

Follow the steps below to print received faxes that are held in memory.



Received fax jobs held in memory cannot be printed during fax transmission or while printing is taking place. If a fax is received while print hold faxes are being printed, the fax will be printed without being held.

5

- 1** Press the [MENU] key.

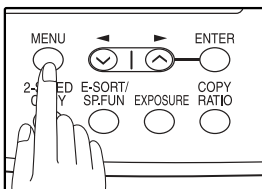

- 2** Make sure the following message appears and then press the [ENTER] key.

Selection

"0:HOLD DATA PRINT"

If the above message does not appear, press the [◀] key (⏪) or [▶] key (⏩) until the message appears and then press the [ENTER] key.

- 3** Enter a four-digit number that identifies the passcode number and then press the [ENTER] key.

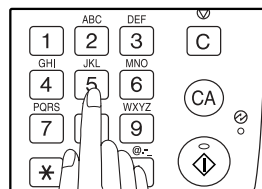

When the [ENTER] key is pressed, printing begins. If there are no received faxes held in memory, the passcode cannot be entered. If you enter an incorrect passcode three times in a row, the machine will exit HOLD DATA PRINT mode.

---

---

# TRANSMISSION RESERVATION

When your fax is busy receiving an original or transmitting an original from memory, you can "reserve" a transmission by setting the original (either in the RSPF or on the document glass), reading it into memory, and entering the fax number. Once the current operation is completed, your fax will automatically dial the number and transmit the original saving you from having to wait.

When Using the RSPF:

**1** Confirm that there are no originals on the document glass and that copying is not in progress, then gently close the RSPF.

**2** Adjust the original guides to the width of your original.

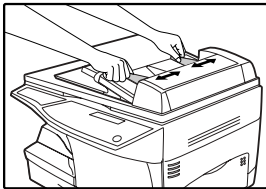

**3** Place the original face up and push it gently into the RSPF. The top edge of the original should enter the fax first.

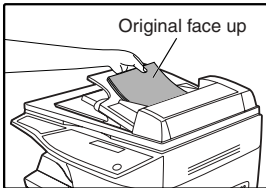

Adjust the resolution and/or contrast settings if desired.

**4** Enter the number of the receiving machine using one of the following methods:

- Press a Rapid key.  
If you press a Rapid Key, the next step is not necessary.  
The number will be dialed once the current operation is completed, and transmission will begin once the connection is made.
- Press the [SPEED/SEARCH] key and enter a Speed Dial number.
- Enter a full number with the numeric keys.

**5** Press the [START] key (Ⓜ) if you entered a Speed Dial number or a full number.

- The number will be dialed once the current operation is completed, and transmission will begin once the connection is made.

When placing the Original on the Table:

**1** Confirm that there are no original(s) in the RSPF, and open the RSPF.

**2** Place the original face down on the document glass. Align the original according to the original scale in the illustration below. (Line up the center of the edge of the original with the (▶) mark.)

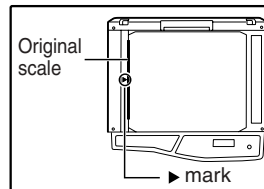

**3** Gently close the RSPF.

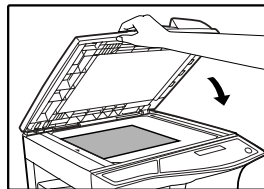

When using the document glass, do not set original(s) in the RSPF.

**4** If needed, set the original size, resolution, and contrast. (See "DIALING AND TRANSMITTING" (p.59))

**5** Press the [START] key (Ⓜ) to scan the page into memory. If you have more than one original to read into memory, place the next page, and press the [START] key (Ⓜ) to read each page.

**6** Press the [#] key.

# BROADCASTING

This function allows you to send the same original to as many as 100 different locations with just one operation. Once the original is loaded, it is scanned and stored in memory. The fax numbers you have entered are then automatically dialed in succession, and the original is transmitted to each location.

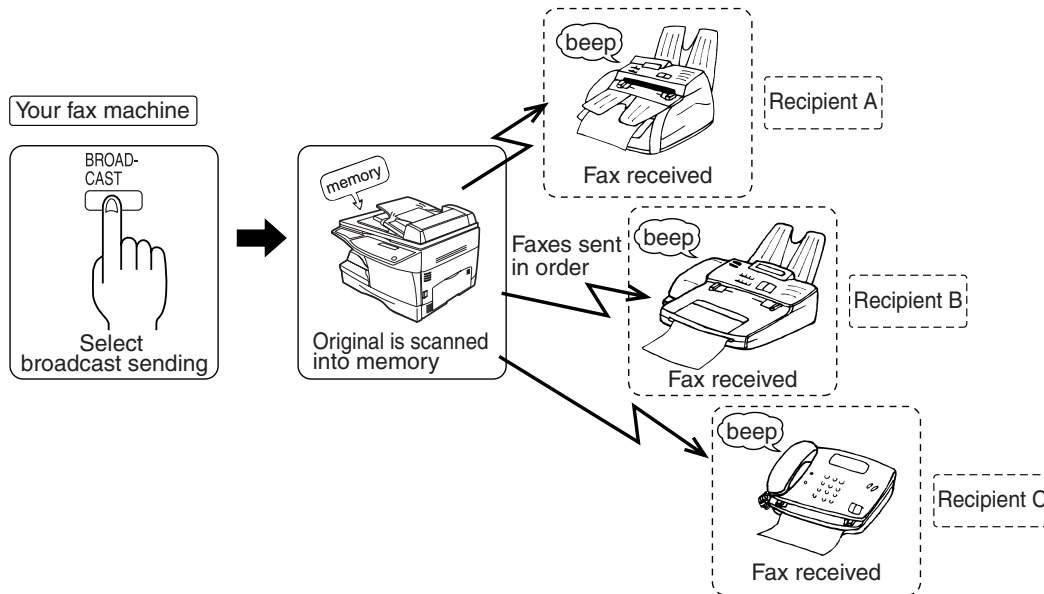

**1** Place the original face up and push it gently into the original feeder tray.

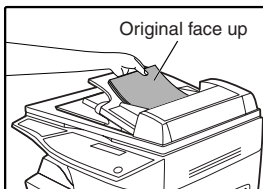

**2** Press the [BROADCAST] key.

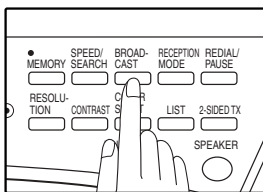

Adjust the resolution and/or contrast settings if desired.



**Note** Adjust the resolution and contrast settings after the [BROADCAST] key has been pressed.

**3** Dial the numbers of the receiving machines using one or more of the following methods:

- Press one or more Rapid keys.
- Enter Speed Dial numbers with the numeric keys.
- Press one or more Group keys.
- Enter a number with the numeric keys.

**5**

**4** Press the [ENTER] key.

To enter another fax number, return to step 3.

**5** Press the [START] key (Ⓢ).  
Transmission will begin.

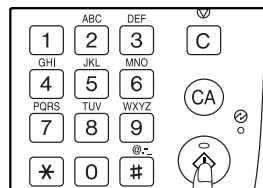

## Broadcasting using a Group key

If the fax machines to which you want to broadcast have all been programmed into one Group key, you can perform the broadcasting operation using the following simplified procedure. Refer to "STORING NUMBERS UNDER GROUP KEYS" (p.45).

- 1 Place the original face up and push it gently into the document feeder tray.**

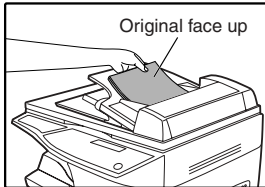

Adjust the resolution and/or contrast settings if desired.

- 2 Press the appropriate Group key. Transmission will begin.**

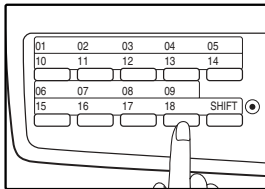

# POLLING

Polling allows you to request another fax machine to send an original to your fax machine. In other words, the receiving fax machine, not the transmitting fax machine, activates the transmission. You can use your fax to both poll and be polled by others.

Serial polling can be used to poll multiple fax machines (maximum of 100) in a single operation.

## POLLING

You can request that another fax machine send you the original that is set in that fax machine. You can perform a polling operation at a scheduled time. (See "TIMER OPERATIONS" (p.79))

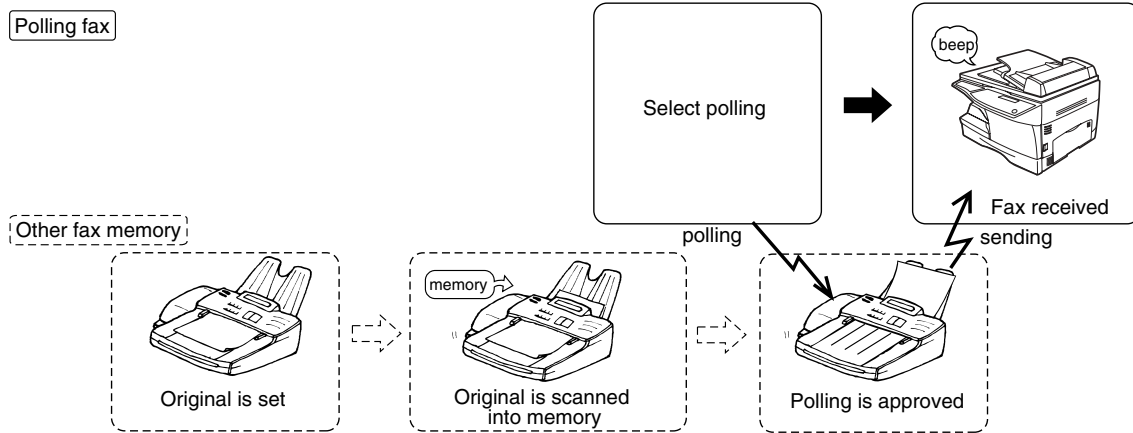

Follow these steps to use the polling function:

### 1 Press the [MENU] key.

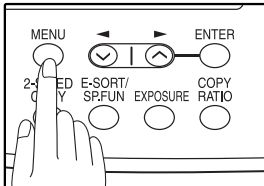

### 2 Press the [◀] key (⏪) or [▶] key (⏩) until "8:POLLING MODE" appears, and then press the [ENTER] key.

Selection

"8:POLLING MODE"

### 3 Dial the number of the fax machine you want to poll using one of the following methods:

- Press a Rapid Key. If you press a Rapid Key, the next step is not necessary.
- Press the [SPEED/SEARCH] key and enter a two-digit Speed Dial number.
- Enter the fax number with the numeric keys.



A group key can be pressed to perform serial polling. Fax reception will take place in the order that the destinations are stored in the Group Key.

### 4 Press the [START] key (⏻).

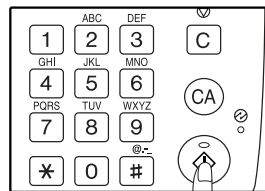

5

# SERIAL POLLING

You can poll several fax machines one at a time with a single serial polling operation. A maximum of 100 fax machines can be polled in one serial polling operation.

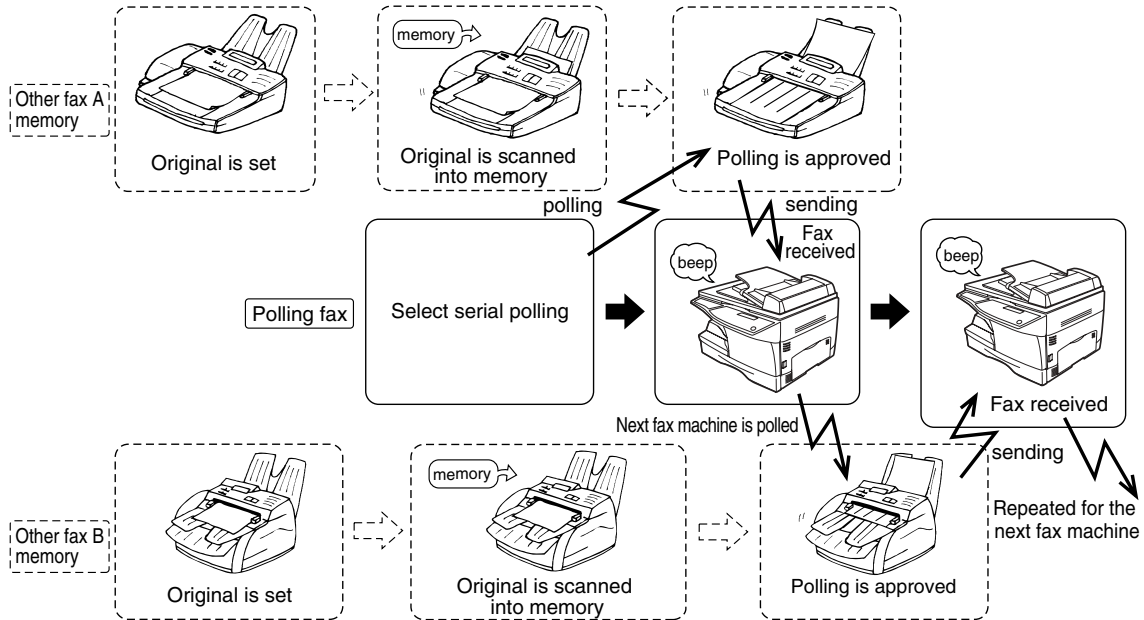

Follow these steps to use the serial polling function:

## 1 Press the [MENU] key.

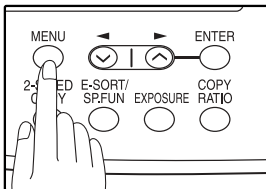

## 2 Press the [◀] key (⏪) or [▶] key (⏩) until "9:SERIAL POLL MODE" appears, and then press the [ENTER] key.

Selection

"9:SERIAL POLL MODE"

## 3 Dial the number of the fax machine you want to poll using one of the following methods:

- Press a Rapid Key or a Group Key.
- Press the [SPEED/SEARCH] key and enter a two-digit Speed Dial number.
- Enter a fax number with the numeric keys.

## 4 Press the [ENTER] key.

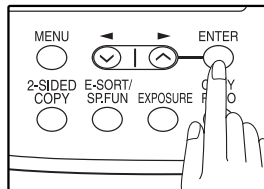

Repeat steps 3 and 4 until all numbers have been entered. After entering the last number, go to step 5.

## 5 Press the [START] key (⏻).

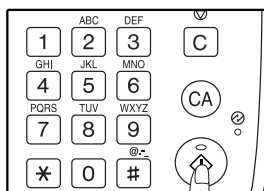

## POLLING TRANSMISSION (MEMORY POLLING)

This function is used to transmit an original that has been scanned into memory to a fax machine that polls your fax machine. If desired, polling fax machines can be restricted to machines whose fax numbers have been programmed in your machine ("RESTRICTING POLLING MACHINES (POLLING SECURITY)" on page 77).

To let other fax machines poll your fax machine, the original to be transmitted must be scanned into memory and the reception mode of your machine must be set to "Auto".

You can select whether polling transmission will take place once or repeatedly. If once is selected, the original that was scanned into memory will be automatically deleted after polling transmission takes place. If repeated polling transmission is selected, the original will remain in memory until it is deleted.

More than one original can be scanned into polling memory (all originals will be transmitted when your machine is polled).

Only one memory polling operation can be set up, and the polling machine must be capable of polling reception.

The original(s) in polling memory will be transmitted when a fax machine calls your fax machine and requests polling transmission. Automatic fax reception is possible while your machine is on polling transmission standby.

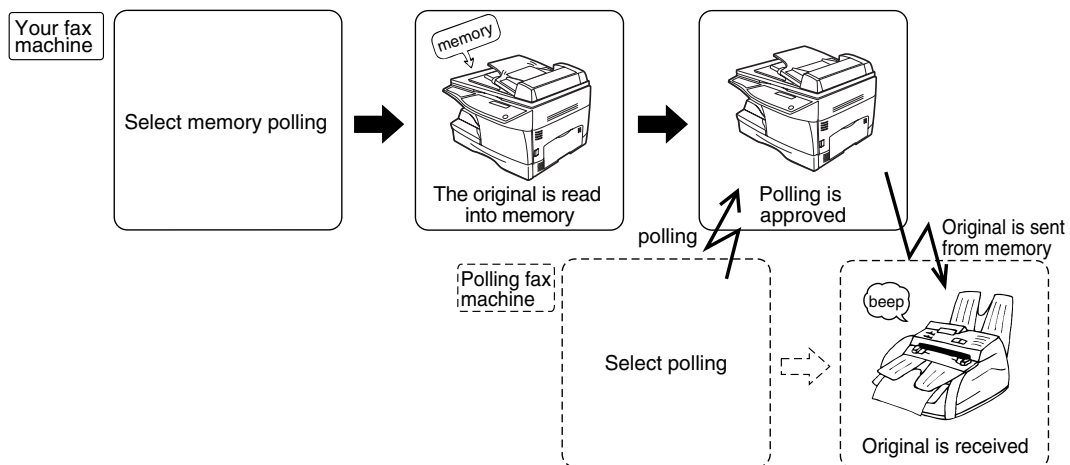

5

### Setting up polling transmission:

Place the original in the RSPF or on the document glass and perform the following steps:

#### 1 Press the [MENU] key.

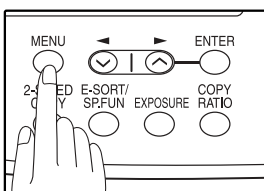

#### 2 Press the [◀] key (⏪) or [▶] key (⏩) until "7:MEMORY POLL MODE" appears, and then press the [ENTER] key.

Selection

"7:MEMORY POLL MODE"

#### 3 Press the [◀] key (⏪) or [▶] key (⏩) to select the number of times polling transmission will take place and press the [ENTER] key.

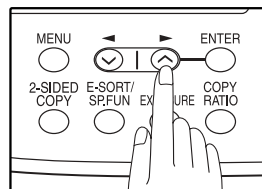

"1:1 TIME" or "2:REPEAT" can be selected as the number of polling operations allowed.

#### 4 Press the [START] key (⏻).

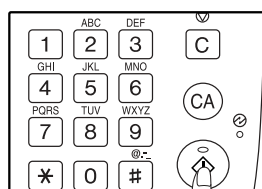

**Adding a original to polling memory:**

Use this procedure to add an original to another original that has already been scanned into polling memory. Place the original in the RSPF or on the document glass and follow the steps below.

**1 Press the [MENU] key.**

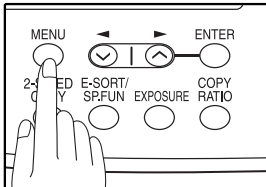

**2 Press the [◀] key (⏪) or [▶] key (⏩) until "7:MEMORY POLL MODE" appears, and then press the [ENTER] key.**

Selection



**3 Press the [◀] key (⏪) or [▶] key (⏩) until "1:SET" appears, and then press the [ENTER] key.**

Selection

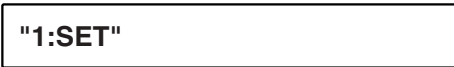

**4 Press the [◀] key (⏪) or [▶] key (⏩) to select the number of times polling transmission will take place and press the [ENTER] key.**

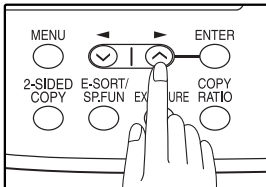

"1:1 TIME" or "2:REPEAT" can be selected as the number of polling operations allowed.

**5 Press the [START] key (⏻).**

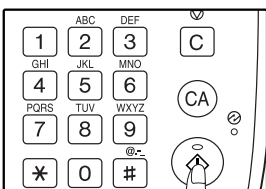

**Deleting originals from polling memory:**

Follow the steps below to delete originals that have been scanned into polling memory.

**1 Press the [MENU] key.**

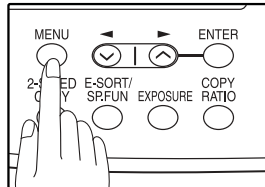

**2 Press the [◀] key (⏪) or [▶] key (⏩) until "7:MEMORY POLL MODE" appears, and then press the [ENTER] key.**

Selection



**3 Press the [◀] key (⏪) or [▶] key (⏩) until "2:CLEAR" appears, and then press the [ENTER] key.**

Selection

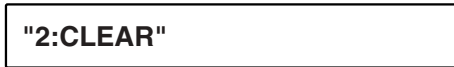

**4 Press the [START] key (⏻).**

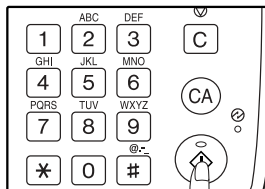



## RESTRICTING POLLING MACHINES (POLLING SECURITY)

If you wish to allow only specified fax machines to poll your fax machine, enable polling security and program the fax numbers of the machines that are to be allowed to poll your machine. When this is done, polling will take place when the fax number of the polling machine matches one of the fax numbers that have been programmed in your machine. Up to 10 passcode numbers (fax numbers of machines that are allowed to poll your machine) can be programmed. To enable polling security and program passcode numbers, see "Programming/deleting passcode numbers:" on page 78.

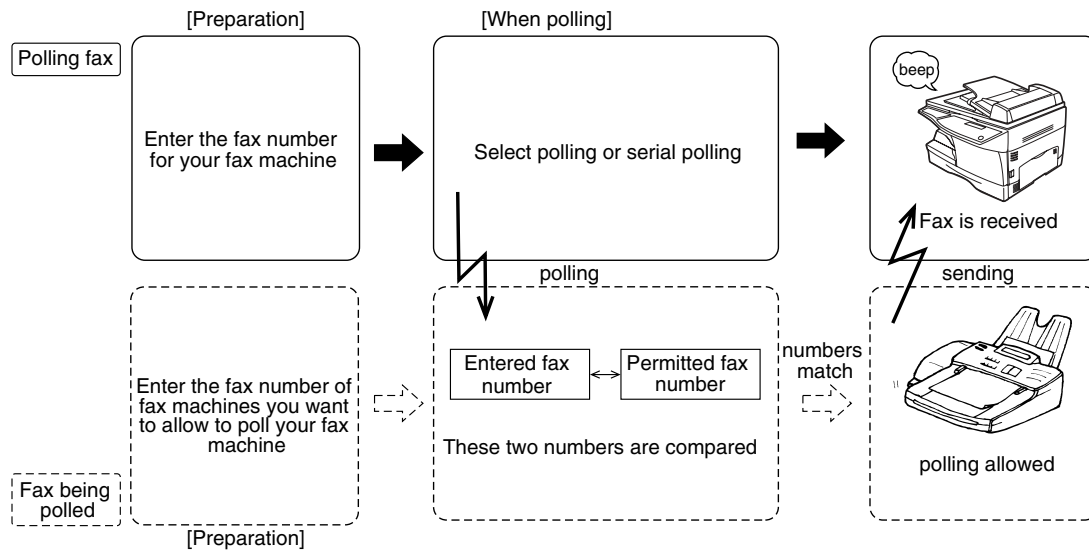

Follow these steps to enable polling security:

### 1 Press the [MENU] key.

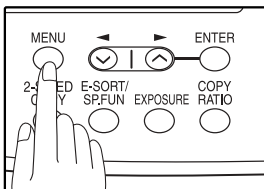

### 2 Press the [◀] key (⏪) or [▶] key (⏩) until "4:USER PROGRAM" appears, and then press the [ENTER] key.

Selection

"4:USER PROGRAM"

### 3 Press the [◀] key (⏪) or [▶] key (⏩) until "12:SECURITY SELECT" appears, and then press the [ENTER] key.

Selection

"12:SECURITY SELECT"

### 4 Press the [◀] key (⏪) or [▶] key (⏩) to select "1:ON".

Selection

"1:ON"

To turn off polling security, select "2:OFF".

### 5 Press the [ENTER] key.

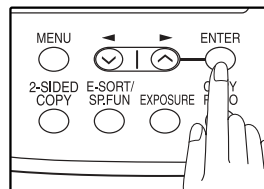

### 6 Press the [MENU] key.

Press the [MENU] key to exit.

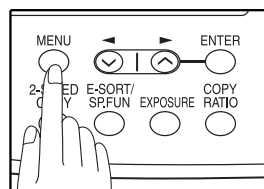

# 5

## SPECIAL FUNCTIONS

Programming/deleting passcode numbers:

### 1 Press the [MENU] key.

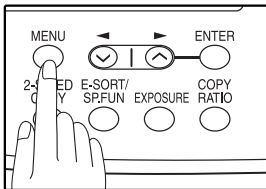

### 2 Press the [◀] key (⏪) or [▶] key (⏩) until "2:ENTRY MODE" appears, and then press the [ENTER] key.

Selection

"2:ENTRY MODE"

### 3 Press the [◀] key (⏪) or [▶] key (⏩) until "4:PASSCODE # MODE" appears, and then press the [ENTER] key.

Selection

"4:PASSCODE # MODE"

### 4 Press the [◀] key (⏪) or [▶] key (⏩) to select "1:SET" and press the [ENTER] key.

Selection

"1:SET"

**To delete a passcode number:**

Select "2:CLEAR" and press the [ENTER] key.

### 5 Enter a two-digit number that will be used to identify the passcode number and then press the [ENTER] key.

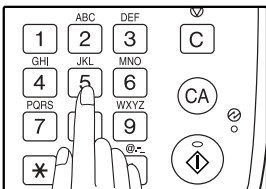

**To delete a passcode number:**

Enter the two-digit number that identifies the passcode number and press the [ENTER] key. The passcode is deleted.

### 6 Enter the passcode (fax number of the machine to be allowed to poll your machine) with the numeric keys and press the [ENTER] key.

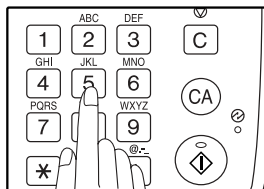

### 7 Press the [MENU] key.

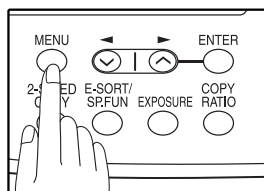

Press the [MENU] key to exit.

# TIMER OPERATIONS

The timer function allows you to set a transmission or polling operation to be performed automatically at a time you specify. Up to five transmission operations or polling operations can be set at any one time, and the times they will be performed can be specified up to a week in advance.

You can use this function, for example, to take advantage of lower night time telephone rates without having to be there when the operation is performed.

- For a timer transmission, scan the original into memory when you set the transmission. Scanning the original into memory is convenient because you do not have to worry about original mix-ups or forgetting to load the original.
- If the memory becomes full while the original is being scanned, "MEMORY FULL" will appear in the display.
  - Press the [START] key (Ⓜ) to transmit the pages that have been stored up to that point in memory.
  - Press the [CLEAR ALL] key (ⓐ) to cancel the entire transmission.

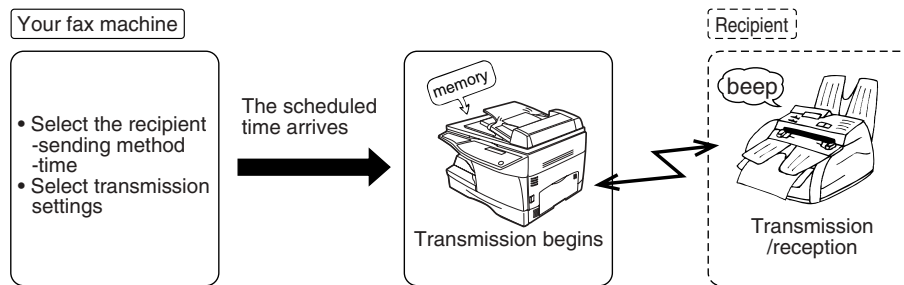

Setting up a timer transmission job:

## 1 Press the [MENU] key.

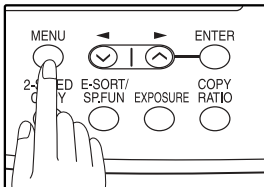

## 2 Press the [◀] key (Ⓟ) or [▶] key (Ⓠ) until "1:TIMER MODE" appears, and then press the [ENTER] key.

Selection

"1:TIMER MODE"

## 3 Press the [◀] key (Ⓟ) or [▶] key (Ⓠ) to select "1:SET".

Selection

"1:SET"

## 4 Enter the time at which transmission will take place with the numeric keys.

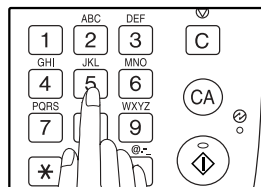

Enter two digits for the hour and two digits for the minute.

## 5 Press the [◀] key (Ⓟ) or [▶] key (Ⓠ) to select "AM" or "PM" and press the [ENTER] key.

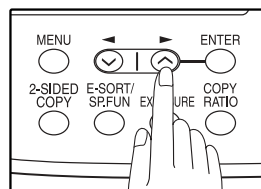

5

To cancel a timer operation, select "2:CLEAR".

- 6** Press the [**◀**] key (⏪) or [**▶**] key (⏩) to select the day of the week and press the [ENTER] key.

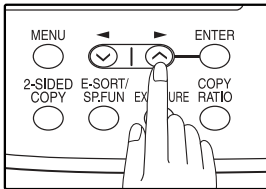

- 7** Press the [ENTER] key.

- 8** Press the [**◀**] key (⏪) or [**▶**] key (⏩) to select the transmission mode and press the [ENTER] key.

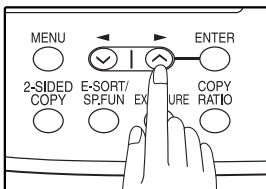

The selections are as follows:  
 1:SEND MODE  
 2:BROADCAST MODE  
 3:POLLING MODE  
 4:SERIAL POLL MODE

- 9** Enter the fax number of the other machine using one of the following methods:

- Press a Rapid key.  
If you press a Rapid Key, the next step is not necessary.
- Enter a Speed Dial number with the numeric keys.
- Enter the fax number with the numeric keys.

- 10** Press the [START] key (⏻).

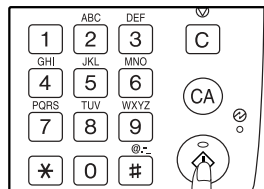

## CANCELING A TIMER TRANSMISSION JOB

After a timer transmission job is set up, the job goes on standby until the specified time of transmission. If necessary, the MEMORY STATUS function can be used to cancel a timer transmission job that is on standby ("CANCELING (DELETING) A STORED FAX JOB" on page 62).

---

---

# ANTI JUNK FAX

You can avoid wasting fax paper by using the Anti Junk Fax function. This function blocks reception of faxes from up to ten specified parties.

To turn the Anti Junk Fax feature on and off, use the following procedure:

## 1 Press the [MENU] key.

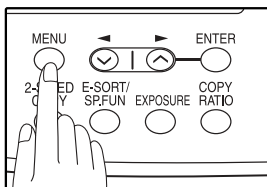

## 2 Press the [◀] key (⏪) or [▶] key (⏩) until "5:ANTI JUNK FAX" appears, and then press the [ENTER] key.

Selection

"5:ANTI JUNK FAX"

## 3 Press the [◀] key (⏪) or [▶] key (⏩) to select "1:ANTI JUNK SELECT" and press the [ENTER] key.

Selection

"1:ANTI JUNK SELECT"

## 4 Press the [◀] key (⏪) or [▶] key (⏩) to select "1:ON" or "2:OFF" and press the [ENTER] key.

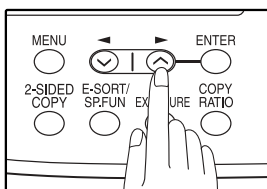

Select "1:ON" to enable the function.  
Select "2:OFF" to disable the function.

## 5 Press the [MENU] key.

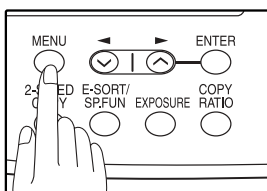

Press the [MENU] key to exit.

5

## SPECIAL FUNCTIONS

To store junk fax numbers, use the following procedure:

### 1 Press the [MENU] key.

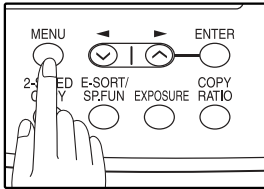

### 2 Press the [◀] key (⏪) or [▶] key (⏩) until "5:ANTI JUNK FAX" appears, and then press the [ENTER] key.

Selection

"5:ANTI JUNK FAX"

### 3 Press the [◀] key (⏪) or [▶] key (⏩) to select "2:JUNK FAX #" and press the [ENTER] key.

Selection

"2:JUNK FAX #"

### 4 Press the [◀] key (⏪) or [▶] key (⏩) to select "1:SET" and press the [ENTER] key.

Selection

"1:SET"

### 5 Enter a two-digit number from 01 to 10 that will identify the anti junk number and press the [ENTER] key.

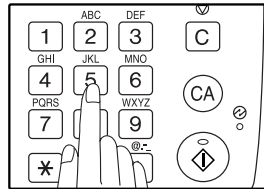

If you enter a two-digit number that already has a fax number stored, "#xx STORED:CHANGE?" will appear. To change the fax number that has been stored under that 2-digit number, press the [◀] key (⏪) or [▶] key (⏩) to select "YES", press the [ENTER] key, and enter the new fax number.

### 6 Enter the fax number with the numeric keys and press the [ENTER] key.

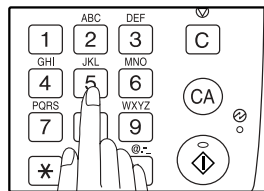

### 7 Press the [MENU] key.

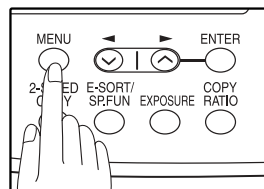

If you wish to store another fax number, return to step 5. Press the [MENU] key to exit.

To clear junk fax numbers, use the following procedure:

### 1 Press the [MENU] key.

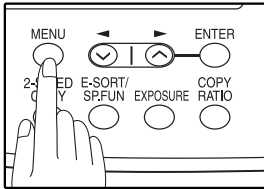

### 2 Press the [◀] key (⏪) or [▶] key (⏩) until "5:ANTI JUNK FAX" appears, and then press the [ENTER] key.

Selection

"5:ANTI JUNK FAX"

### 3 Press the [◀] key (⏪) or [▶] key (⏩) to select "2:JUNK FAX #" and press the [ENTER] key.

Selection

"2:JUNK FAX #"

### 4 Press the [◀] key (⏪) or [▶] key (⏩) to select "2:CLEAR" and press the [ENTER] key.

Selection

"2:CLEAR"

### 5 Press the numeric keys to enter the two-digit number (01 to 10) that identifies the fax number you wish to delete.

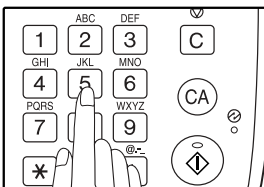

### 6 Press the [ENTER] key.

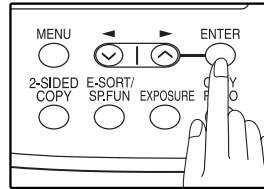

If you wish to store another fax number, return to step 5.

### 7 Press the [MENU] key.

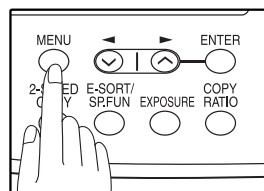

Press the [MENU] key to exit.

5

# OPERATION IN COPY, PRINTER, SCANNER, AND FAX MODES

Some operations cannot be performed simultaneously when the machine is being used in printer mode, copy mode, scanner mode, and fax mode.

Modes		Copy	Printer	Scanner		Fax		Extension phone
		Copying	Printing	Scanning from a machine	Scanning from a computer	Transmission	Reception	
Copy	Key entry	Yes	Yes	No	Yes	Yes*1	Yes	Yes
	During copying	No	No	No	No	Yes*1	Yes*2	Yes
Printer	Printing	Yes	No	Yes	Yes	Yes	Yes*2	Yes
Scanner	During scanning	No	Yes	No	No	Yes*1	Yes	Yes
Fax transmission	Key entry	No	Yes	No	Yes	Yes	Yes	Yes
	During direct transmission	No	Yes	No	No	No	No	No
	During scanning	No	Yes	No	No	Yes*1	Yes*4	Yes
	During memory transmission	Yes	Yes	Yes	Yes	No*3	No	No
Fax reception	During manual reception	Yes	No	Yes	Yes	No*3	No	No
	During printing of a received fax	Yes	No	Yes	Yes	Yes	Yes*2	Yes
	During memory reception	Yes	Yes	Yes	Yes	No*3	No	No
Extension phone		Yes	Yes	Yes	Yes	No*3	No	No

\*1 Direct transmission and scanning are not possible.

\*2 Manual reception and printing of a received fax are not possible.

\*3 Only scanning is possible.

\*4 Manual reception is not possible.



# 6

## Chapter 6 TROUBLESHOOTING

# PRINTING OUT REPORTS

The machine is capable of printing a range of reports on faxing activities as well as various settings you have made. The reports are described below.

### 1. TIMER LIST:

You can print a list of timer or dual access operations that are currently set.

P. 01

**TIMER LIST**

SEP-10-200X FRI 06:30 PM

TIMER MODE

FILE	RESERVED	TYPE	RES.	MSG	BOX	PAGES	CVR	RECEIVER
01	11:11 PM 100X	XXXXXXXXXX	XXX	X	XX	X	XXX	XXX XXX XXX
02	XX XX XX XXX	XXXXXXXXXX	XXX	X	XX	X	XXX	XXX XXX XXX
03	XX XX XX XXX	XXXXXXXXXX	XXX	X	XX	X	XXX	XXX XXX XXX
04	XX XX XX XXX	XXXXXXXXXX	XXX	X	XX	X	XXX	XXX XXX XXX
05	XX XX XX XXX	XXXXXXXXXX	XXX	X	XX	X	XXX	XXX XXX XXX
06	XX XX XX XXX	XXXXXXXXXX	XXX	X	XX	X	XXX	XXX XXX XXX
07	XX XX XX XXX	XXXXXXXXXX	XXX	X	XX	X	XXX	XXX XXX XXX

MEMORY TX

FILE	RESERVED	TYPE	RES.	MSG	BOX	PAGES	CVR	RECEIVER
XXX		XXXXXX	XXX	X	XX	X	XXX	
XXX		XXXXXX	XXX	X	XX	X	XXX	

REMOTE TX

#	TYPE	RES.	MSG	PAGES	CVR	TIMES
1	XXXX	XXXX		X XXX XX	X	XXX

### 2. ACTIVITY REPORT:

You can print out a list of faxes sent and received as well as the sender or recipient and the time of the operation, etc.

P.01

**ACTIVITY REPORT (SEND)**

SEP-10-200X FRI 06:30 PM

#	DATE	START TIME	RECEIVER	COM TIME	PAGES	TYPE/NOTE	FILE
XX	SEP-10	XX:XX PM	XX	XX:XX	XX	XXXXXXXX	XXX
TOTAL					XXXXXX	XX	
GRAND TOTAL					XXXX XX	XX	

### 3. TELEPHONE # LIST:

You can print out a list of number stored in rapid dialing and speed dialing.

P. 01

**TELEPHONE NUMBER LIST**

SEP-10-200X FRI 06:30 PM

RAPID/SPEED #	RECEIVER'S FAX #	INTL TX SET	RECEIVER'S NAME
XXX	XXXXXXXXXXXXXX	XXXX	XXXXXXXXXXXXXX
XXX	XXXXXXXXXXXXXX	XXXX	XXXXXXXXXXXXXX
XXX	XXXXXXXXXXXXXX	XXXX	XXXXXXXXXXXXXX

### 4. GROUP LIST:

You can print out a list of group dialing numbers.

P.01

**GROUP LIST**

SEP-10-200X FRI 06:30 PM

#	GROUP NAME	RECEIVER
0XX	XXXX	RAPID# XXX SPEED# XXX
0XX	XXXX	RAPID# XXX SPEED# XXX
0XX	XXXX	RAPID# XXX SPEED# XXX
0XX	XXXX	RAPID# XXX SPEED# XXX

### 5. PASSCODE LIST:

You can print a list of your fax information and polling security information.

PASSCODE LIST		
SEP-10-200X FRI 06:30 PM		
POLL SECURITY	XXXX	
SYSTEM #	XXXX	
00 #	01	XXXX
	02	XXXX
	03	
	04	
	05	
	06	
	07	
	08	
	09	
	10	
PASSCODE #	01	XXXXXXXXXX
	02	XXXXXXXXXX
	03	
	04	
	05	
	06	
	07	
	08	
	09	
	10	
NUMBER NAME	XXXXXXXXXXXXXXXXXXXX	
EXTENSION #	XXXXXXXXXXXXXXXXXXXX	
HW STA NAME	XXXXXXXXXXXXXXXXXXXX	
HW REGION #	XXXXXXXXXXXXXXXXXXXX	

### 6. JUNK FAX # LIST:

Fax numbers designated as Anti Junk Fax numbers.

JUNK FAX# LIST		
SEP-10-200X FRI 06:30 PM		
#	ANTI JUNK FAX #	
01	X	
02	XXXXXXXXXX	
10	XXXXXXXXXXXXXXXXXXXX	

## 7. USER PROGRAM LIST:

Currently activated USER PROGRAM settings.

USER PROGRAM LIST			
SEP-10-200X FRI 06:30 PM			
MENU #	ITEM	SETTING	
1	DOC. GLASS SIDE	A-FULL	
2	FIXED DOC. SIZE	A-FULL	
3	MEMORY PRIORITY	STANDARD	
4	FOR RINGS AUTO RX	OFF	
5	FOR RINGS MANUAL RX	OFF	
6	PRINT SELECT	OFF	
7	PRINT SELECTION	SD - ERROR ONLY	RD - ALWAYS PRINTS
8	PRINT SELECTION	BCV - NEVER PRINTS	IMAGE - ERROR ONLY
9	SET ALL TIMES (SET)	OFF	
10	SET ALL TIMES (JOB ERROR)	OFF	
11	SET ALL INTERNAL DELAY	MIN	
12	SET ALL INTERNAL (JOB ERROR)	MIN	
13	SECURITY SELECTION	ON	
14	PAK NUMBER NUMBER	0	
15	RENDER SELECTION	ON	
16	PAK SIGNAL AUTO RECEIVE	ON	
17	RENDER RECEIVE	ON	
18	RENDER RECEIVE	ON	
19	RENDER RECEIVE	ON	
20	RENDER RECEIVE	ON	
21	RENDER RECEIVE	ON	
22	RENDER RECEIVE	ON	
23	RENDER RECEIVE	ON	
24	RENDER RECEIVE	ON	
25	RENDER RECEIVE	ON	
26	RENDER RECEIVE	ON	
27	RENDER RECEIVE	ON	
28	RENDER RECEIVE	ON	
29	RENDER RECEIVE	ON	
30	RENDER RECEIVE	ON	
31	RENDER RECEIVE	ON	
32	RENDER RECEIVE	ON	
33	RENDER RECEIVE	ON	
34	RENDER RECEIVE	ON	
35	RENDER RECEIVE	ON	
36	RENDER RECEIVE	ON	
37	RENDER RECEIVE	ON	
38	RENDER RECEIVE	ON	
39	RENDER RECEIVE	ON	
40	RENDER RECEIVE	ON	
41	RENDER RECEIVE	ON	
42	RENDER RECEIVE	ON	
43	RENDER RECEIVE	ON	
44	RENDER RECEIVE	ON	
45	RENDER RECEIVE	ON	
46	RENDER RECEIVE	ON	
47	RENDER RECEIVE	ON	
48	RENDER RECEIVE	ON	
49	RENDER RECEIVE	ON	
50	RENDER RECEIVE	ON	
51	RENDER RECEIVE	ON	
52	RENDER RECEIVE	ON	
53	RENDER RECEIVE	ON	
54	RENDER RECEIVE	ON	
55	RENDER RECEIVE	ON	
56	RENDER RECEIVE	ON	
57	RENDER RECEIVE	ON	
58	RENDER RECEIVE	ON	
59	RENDER RECEIVE	ON	
60	RENDER RECEIVE	ON	
61	RENDER RECEIVE	ON	
62	RENDER RECEIVE	ON	
63	RENDER RECEIVE	ON	
64	RENDER RECEIVE	ON	
65	RENDER RECEIVE	ON	
66	RENDER RECEIVE	ON	
67	RENDER RECEIVE	ON	
68	RENDER RECEIVE	ON	
69	RENDER RECEIVE	ON	
70	RENDER RECEIVE	ON	
71	RENDER RECEIVE	ON	
72	RENDER RECEIVE	ON	
73	RENDER RECEIVE	ON	
74	RENDER RECEIVE	ON	
75	RENDER RECEIVE	ON	
76	RENDER RECEIVE	ON	
77	RENDER RECEIVE	ON	
78	RENDER RECEIVE	ON	
79	RENDER RECEIVE	ON	
80	RENDER RECEIVE	ON	
81	RENDER RECEIVE	ON	
82	RENDER RECEIVE	ON	
83	RENDER RECEIVE	ON	
84	RENDER RECEIVE	ON	
85	RENDER RECEIVE	ON	
86	RENDER RECEIVE	ON	
87	RENDER RECEIVE	ON	
88	RENDER RECEIVE	ON	
89	RENDER RECEIVE	ON	
90	RENDER RECEIVE	ON	
91	RENDER RECEIVE	ON	
92	RENDER RECEIVE	ON	
93	RENDER RECEIVE	ON	
94	RENDER RECEIVE	ON	
95	RENDER RECEIVE	ON	
96	RENDER RECEIVE	ON	
97	RENDER RECEIVE	ON	
98	RENDER RECEIVE	ON	
99	RENDER RECEIVE	ON	
100	RENDER RECEIVE	ON	

Use the following procedure to print out reports:



If the printing procedure for one of the reports below is performed when PRINT HOLD MODE (p.67) is enabled, the report will be held in memory instead of being printed. To print the report, perform the "HOLD DATA PRINT" procedure (p.69).

### 1 Press the [LIST] key.

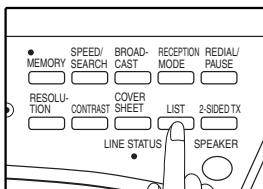

### 3 Press the [ENTER] key.

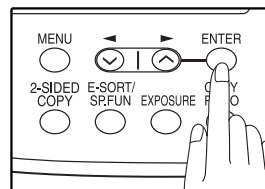

### 2 Press the [LIST] key to select the report that you wish to print.

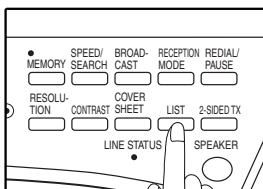

6

## ACTIVITY REPORT AUTO LISTING

This setting is used to automatically print the Activity Report for transmissions and receptions. The Activity Report will automatically print when information on a total of 50 fax transmissions and receptions accumulates. Once information on 50 transmissions/receptions accumulates, the oldest transaction is deleted each time a new transaction takes place.



If automatic printing of the Activity Report is enabled when PRINT HOLD MODE (p.67) is enabled, the Activity Report will be held in memory instead of being printed. To print the report, perform the "HOLD DATA PRINT" procedure (p.69).

### 1 Press the [MENU] key.

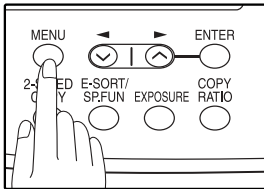

### 5 Press the [MENU] key.

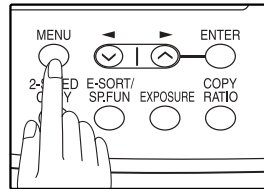

Press the [MENU] key to exit.

### 2 Press the [◀] key (⏪) or [▶] key (⏩) until "4:USER PROGRAM" appears, and then press the [ENTER] key.

Selection

"4:USER PROGRAM"

### 3 Press the [◀] key (⏪) or [▶] key (⏩) until "6:AUTO LISTING" appears, and then press the [ENTER] key.

Selection

"6:AUTO LISTING"

### 4 Press the [◀] key (⏪) or [▶] key (⏩) to select "1:ON" and press the [ENTER] key.

Selection

"1:ON"

To disable automatic printing, select "2:OFF" and press the [ENTER] key.

## PRINTING TRANSACTION REPORTS

The machine can be set to print a transaction report after each transmission, reception, and/or error. The printing condition can be selected separately for three types of transaction reports: "TRANSMISSION LIST", "BROADCAST LIST", and "RECEPTION LIST". For each type of report, select one of the following printing conditions:

- "ALWAYS PRINTS" ....After each transmission, reception, or error.
- "ERROR ONLY" .....After an error only.
- "NEVER PRINTS" .....Never prints.



- Part of the transmitted fax can be printed on the transaction report (IMAGE MEM. PRINT setting).
- If the printing condition for a transaction report is met when PRINT HOLD MODE (p.67) is enabled, the report will be held in memory instead of being printed. To print the report, perform the "HOLD DATA PRINT" procedure (p.69).

To set the machine to print transaction reports, follow these steps:

### 1 Press the [MENU] key.

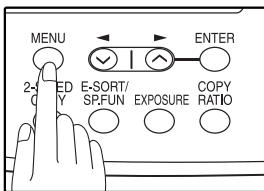

### 2 Press the [◀] key (⏪) or [▶] key (⏩) until "4:USER PROGRAM" appears, and then press the [ENTER] key.

Selection

"4:USER PROGRAM"

### 3 Press the [◀] key (⏪) or [▶] key (⏩) until "7:PRINT SELECTION" appears, and then press the [ENTER] key.

Selection

"7:PRINT SELECTION"

### 4 Press the [◀] key (⏪) or [▶] key (⏩) to select the type of transaction report and press the [ENTER] key.

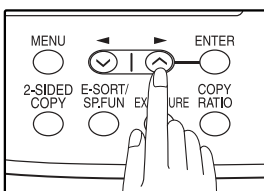

The selections are as follows:

- 1:TRANSMISSION
- 2:BROADCAST
- 3:RECEPTION
- 4:IMAGE MEM. PRINT

"4: IMAGE MEM. PRINT" can be enabled to have part of the transmitted fax printed on the transaction report.

### 5 Press the [◀] key (⏪) or [▶] key (⏩) to select the printing condition and press the [ENTER] key.

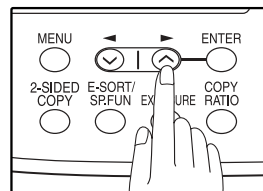

The selections are as follows:

- 1:ALWAYS PRINTS
- 2:ERROR ONLY
- 3:NEVER PRINTS

### 6 Press the [MENU] key.

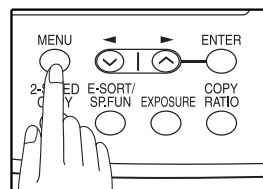

Press the [MENU] key to exit.

6

# TROUBLESHOOTING

Problem	Cause and solution	Page
Dialing cannot be done.	<b>The telephone line cord is not correctly connected to the machine and the wall telephone jack.</b> → Make sure the telephone line cord is securely connected.	11
No transmission takes place.	<b>The receiving machine is out of paper.</b> → Check with the operator of the receiving machine.	-
	<b>The receiving machine does not support the G3 standard.</b> → Check with the operator of the receiving machine.	-
	<b>An error is displayed.</b> → Check the display of the machine.	91
Nothing is printed at the receiving end.	<b>If a blank sheet of paper is output together with a normally received fax, the machine's paper size setting may be different from the size of paper actually loaded in the machine.</b> → Make sure that the paper size setting matches the size of paper loaded in the machine.	29
A distorted image is received at the other end.	<b>Noise on the line may cause a distorted image. Try sending the fax again, or make a copy on your machine and see if the copy is distorted.</b> → If the image is still distorted, consult the retailer or dealer where you bought the machine.	-
The received original is faint.	<b>The transmitting machine may be using a light contrast setting.</b> → Ask the operator of the transmitting machine to send the fax using a darker contrast setting.	-
Received images are distorted.	<b>Noise on the line may cause a distorted image.</b> → Ask the operator of the transmitting machine to send the fax again.	-
	<b>The TD cartridge may be running out of toner.</b> → Replace the TD cartridge.	Operation Manual (for general information)



If your problem cannot be solved by carrying out the instructions in the Check and Remedy column above, please contact your authorized SHARP dealer.

---

---

# MESSAGES AND SIGNALS

## DISPLAY MESSAGES

Message	Cause and remedy	Page
FRONT OR SIDE COVER OPEN. CLOSE COVERS.	The cover is open. Close the cover.	See the OPERATION MANUAL (for general information)
CLOSE THE SPF/RSPF COVER.	The RSPF cover is open. Close the RSPF cover.	
CLEAR PAPER JAM. SPF/RSPF JAM.	A paper misfeed has occurred. Remove the misfeed as explained in "MISFEED REMOVAL". (See the OPERATION MANUAL for general information.)	
MEMORY FULL	The memory is full.	62
LOAD XXX SIZE PAPER INTO TRAY1	The setting for the printing paper size is incorrect. Set it correctly. "8.5x11", "8.5x14", or "A4" will appear in "XXX" in the message.	29
CAN NOT PRINT	TD cartridge is empty. TD cartridge is not inserted.	See the OPERATION MANUAL (for general information)
NO XXX SIZE TRAY CHANGE TRAY SETTING	Paper tray is not set to the appropriate paper size. Change the paper size setting of the paper tray to the size indicated in the message, and load that size of paper in the paper tray. "8.5x11", "8.5x14", or "A4" will appear in "XXX" in the message.	-

## AUDIBLE SIGNALS

Sound Type	Duration	Meaning
Continuous tone	3 seconds	Indicates the end of transmission, reception, or line error.
Continuous tone	1 second	Warning tone

6

# 7

## Chapter 7 APPENDIX

### SPECIFICATIONS

<b>Applicable telephone line</b>	Public switched telephone network
<b>Compression method</b>	MH, MR, MMR, JBIG
<b>Transmission modes</b>	Super G3, G3 (the machine can only send faxes to and receive faxes from machines that support G3 or Super G3)
<b>Scanning method</b>	CCD flatbed scanning
<b>Scanning resolution (supports ITU-T standards)</b>	8 x 3.85 lines/mm (Standard) 8 x 7.7 lines/mm (Fine, Fine + Halftone) 8 x 15.4 lines/mm (Super Fine, Super Fine + Halftone)
<b>Recording method</b>	Laser, electrostatic charge method
<b>Transmission speed</b>	33.6 kbps → 2.4 kbps Automatic fallback
<b>Transmission time</b>	Approx. 2 seconds (Super G3 mode / 33.6 kbps, JBIG), Approx. 6 seconds (G3 ECM mode / 14.4 kbps, JBIG)
<b>Paper size</b>	8-1/2" x 11"(Letter), 8-1/2" x 14"(Legal), or A4
<b>Effective recording width</b>	8-1/2" max. (8-1/2" x 14" printing)
<b>Transmittable original size</b>	When using the RSPF Maximum One-sided original: 8-1/2" x 19.7" Two-sided original: 8-1/2" x 14" Minimum 8-1/2" x 5-1/2" When using the document glass Maximum 8-1/2" x 14"
<b>Effective scanning width</b>	8-1/2" maximum
<b>Halftone transmission</b>	256 levels
<b>Contrast (exposure) adjustment</b>	Light, Medium, Dark
<b>Extension telephone connection</b>	Possible (1 telephone)
<b>Auto dialing</b>	Combined total of 18 One-Touch Dial and Group keys; 100 Speed Dial numbers; redialing (automatic)
<b>Timer transmission</b>	Yes
<b>Automatic document feeding</b>	Yes (30 pages)
<b>Memory capacity</b>	2 MB
<b>Error Correction Mode(ECM)</b>	Yes

\* As a part of our policy of continuous improvement, SHARP reserves the right to make design and specification changes for product improvement without prior notice. The performance specification figures indicated are nominal values of production machines. There may be some deviations from these values in individual machines.



---

---

# INDEX

## A

- Alarm beeps
  - Alarm beep volume ..... 19
  - Length of alarm beeps ..... 18
- Answering machine ..... 48
  - Answering machine backup ..... 49
  - Quiet detect time ..... 48
- Arrow keys ..... 15, 16
- Automatic dialing
  - Group keys ..... 45
  - Rapid key dialing ..... 42
  - Speed dialing ..... 42

## B

- Bypass tray paper guides ..... 13

## C

- Clear numbers
  - Group keys ..... 47
  - Rapid key dialing ..... 44
  - Speed dialing ..... 44
- Connecting
  - Other devices ..... 12
  - Telephone line cord ..... 11
- Contrast ..... 55
- Cover sheet ..... 56

## D

- Dialing
  - Direct keypad dialing ..... 59
  - Rapid key dialing ..... 59
  - Redialing ..... 61
  - Search ..... 61
  - Speed dialing ..... 59
  - Using the [SPEAKER] key ..... 60
- Display ..... 14, 16
- Distinctive ringing ..... 41
- Document glass ..... 13

## E

- Entering your name and fax number ..... 21

## F

- Fax main menu ..... 6
- Fax setup
  - Date and time ..... 22
  - Daylight saving time setting ..... 25
  - Dial mode ..... 31
  - Distinctive ringing ..... 41
  - How to enter characters ..... 20
  - Index function ..... 36
  - Number of recall times ..... 32
  - Number of rings for auto reception ..... 28
  - Number of rings for manual reception ..... 29
  - Recall interval ..... 34
  - Reception mode ..... 27
  - Reception paper size ..... 29
  - Remote reception ..... 39
  - Resolution priority ..... 37
  - Transmission mode ..... 26
  - Setting the tray selection ..... 30
  - Your name and fax number ..... 21

## H

- Handles ..... 13

## I

- Index function ..... 36

## L

- Line jack ..... 13
- List of fax functions ..... 6

## M

- Memory ..... 67
- Message function ..... 57
- Messages and signals ..... 91

## O

- Operation panel ..... 13
- Optional transmission settings
  - Cover sheet ..... 56
  - Message function ..... 57
  - Two-sided original ..... 58
- Originals ..... 50
  - Original size ..... 54
  - Setting the original ..... 52
  - Size and weight ..... 50
  - Two-sided original ..... 58
  - Unsuitable originals ..... 51

## P

- Paper output tray ..... 13
- Paper output tray extension ..... 13
- Paper tray ..... 13
- PC modem ..... 38
- Power cord ..... 13
- Power switch ..... 13
- Print hold mode ..... 67

## Q

- Quick reference guide ..... 3

---

<b>R</b>	
Receiving faxes.....	63
- Receive reduce .....	65
- Two-sided reception.....	64
Reception mode	
- A.M. mode.....	27, 63
- AUTO mode .....	27, 63
- MAN. mode .....	27, 63
Remote reception.....	39
Reports	
- Group list.....	85
- Junk fax # list .....	86
- Passcode list.....	86
- Telephone # list.....	85
- Timer list .....	85
- Transaction reports .....	89
- Transmissions activity report .....	85, 88
- User program list.....	87
Resolution .....	55
Ringling volume .....	17
RSPF.....	13
- Document feeder cover.....	13
- Document feeder tray .....	13
- Exit area.....	13
- Original guides .....	13
- Reversing tray.....	13
<b>S</b>	
Specifications .....	92
Storing numbers	
- Group keys.....	45
- Rapid key dialing.....	42
- Speed dialing .....	42
<b>T</b>	
TEL jack .....	13
Transmission mode	
- Direct transmission .....	26
- Memory transmission.....	26
Troubleshooting .....	90

---

---

<b>INDEX BY PURPOSE</b>
-------------------------

**Fax setup**

Connecting the telephone line cord.....	11
Daylight saving time setting .....	25
Dial mode .....	31
Distinctive ringing .....	41
Entering your name and fax number .....	21
How to enter characters .....	20
Index function.....	36
Number of recall times .....	32
Number of rings for auto reception.....	28
Number of rings for manual reception .....	29
Recall interval .....	34
Reception mode .....	27
Reception paper size .....	29
Remote reception.....	39
Resolution priority .....	37
Setting the date and time .....	22
Transmission mode.....	26
Tray selection.....	30

**Faxes, sending and receiving**

Dialing	
- Chain dialing .....	60
- Direct keypad dialing .....	59
- Redialing .....	61
- Speed dialing .....	59
- Using the [SPEAKER] key .....	60
Receiving faxes.....	63
- Manual receiving .....	66
- Optional reception settings .....	64
Sending originals	
- Dialing and transmitting .....	59
- Manual sending.....	66
- Optional transmission settings .....	54
- Setting the original .....	52

**Special functions**

Anti junk fax.....	81
Broadcasting .....	71
Memory polling.....	75
Polling .....	73
Polling security .....	77
Reservation .....	70
Serial polling.....	74
Timer operations .....	79

**Storing/settings**

Clear numbers	
- Group keys.....	47
- Rapid key dialing.....	44
- Speed dialing .....	44
Contrast.....	55
Enter characters.....	20
Original size .....	54
Resolution .....	55
Storing numbers	
- Group key.....	45
- Rapid key dialing.....	42
- Speed dialing .....	42

**SHARP®**

**SHARP ELECTRONICS CORPORATION**  
Sharp Plaza, Mahwah, New Jersey 07430-1163.

[www.sharpsusa.com](http://www.sharpsusa.com)

**SHARP CORPORATION**

## Free Manuals Download Website

<http://myh66.com>

<http://usermanuals.us>

<http://www.somanuals.com>

<http://www.4manuals.cc>

<http://www.manual-lib.com>

<http://www.404manual.com>

<http://www.luxmanual.com>

<http://aubethermostatmanual.com>

Golf course search by state

<http://golfingnear.com>

Email search by domain

<http://emailbydomain.com>

Auto manuals search

<http://auto.somanuals.com>

TV manuals search

<http://tv.somanuals.com>