

# SHARP®

## ELECTRONIC CASH REGISTER

MODEL

# ER-A242

## INSTRUCTION MANUAL



## WARNING

FCC Regulations state that any unauthorized changes or modifications to this equipment not expressly approved by the manufacturer could void the user's authority to operate this equipment.

**Note:** This equipment has been tested and found to comply with the limits for a Class A digital device, pursuant to Part 15 of the FCC Rules. These limits are designed to provide reasonable protection against harmful interference when this equipment is operated in a commercial environment.

This equipment generates, uses, and can radiate radio frequency energy and, if not installed and used in accordance with the instruction manual, may cause harmful interference to radio communications. Operation of this equipment in a residential area is likely to cause harmful interference in which case the user will be required to correct the interference at his own expense.

## CAUTION

The AC power socket-outlet should be installed near the equipment and should be easily accessible.

## FOR YOUR RECORDS

Please record below the model number and serial number for easy reference in case of loss or theft. These numbers are located on the right side of the unit. Space is provided for further pertinent data.

Model Number \_\_\_\_\_

Serial Number \_\_\_\_\_

Date of Purchase \_\_\_\_\_

Place of Purchase \_\_\_\_\_

---

# INTRODUCTION

Thank you very much for your purchase of the SHARP Electronic Cash Register, Model ER-A242. Please read this manual carefully before operating your machine in order to gain full understanding of functions and features. Please keep this manual for future reference. It will help you if you encounter any operational problems.

## CAUTION!

**Never install the batteries into the cash register before initializing it.** Before you start operating the cash register, you must first initialize it, then install the batteries. Otherwise, distorted memory contents and malfunction of the cash register will occur. For this procedure, please refer to page 7.

---

# IMPORTANT

- **On the printer, a cutter to cut the paper roll is mounted. Always be careful not to cut yourself by the cutter.**
- **Install your register in a location that is not subject to direct radiation, unusual temperature changes, high humidity or exposed to water sources.**  
Installation in such locations could cause damage to the cabinet and the electronic components.
- **Never operate the register with wet hands.**  
The water could seep into the interior of the register and cause component failure.
- **When cleaning your register, use a dry, soft cloth. Never use solvents, such as benzine and/or thinner.**  
The use of such chemicals will lead to discoloration or deterioration of the cabinet.
- **The register plugs into any standard wall outlet (120V AC  $\pm 10\%$ ).**  
Other electrical devices on the same electrical circuit could cause the register to malfunction.
- **For protection against data loss, please install three "AA" batteries after initializing the cash register. When handling the batteries, never fail to observe the followings:**  
**Incorrectly using batteries can cause them to burst or leak, possibly damaging the interior of the cash register.**
  - **Be sure that the the positive (+) and negative (-) poles of each battery are facing in the proper direction for installation.**
  - **Never mix batteries of different types.**
  - **Never mix old batteries and new ones.**
  - **Never leave dead batteries in the battery compartment.**
  - **Remove the batteries if you do not plan to use the cash register for long periods.**
  - **Should a battery leak, clean out the battery compartment immediately, taking care to avoid letting the battery fluid come into direct contact with your skin.**
  - **For battery disposal, follow the corresponding law in your country.**
- **If the register malfunctions, call your local dealer for service - do not try to repair the register yourself.**
- **For a complete electrical disconnection, disconnect the main plug.**

**For Easy Set-up, see  
"GETTING STARTED" (page 7).**

# CONTENTS

<b>INTRODUCTION</b> .....	<b>1</b>
<b>IMPORTANT</b> .....	<b>1</b>
<b>CONTENTS</b> .....	<b>2</b>
<b>PARTS AND THEIR FUNCTIONS</b> .....	<b>4</b>
1 External View .....	4
2 Printer .....	4
3 Mode Switch and Mode Keys .....	5
4 Keyboard .....	5
5 Displays .....	6
6 Drawer Lock Key .....	6
<b>GETTING STARTED</b> .....	<b>7</b>

**FOR THE OPERATOR**

<b>OVERVIEW OF FLOW OF DAILY SALES ENTRIES</b> .....	<b>11</b>
<b>BASIC SALES ENTRY</b> .....	<b>12</b>
1 Basic Sales Entry Example .....	12
2 Error Warning .....	13
3 Item Entries .....	14
Single item entries .....	14
Repeat entries .....	15
Multiplication entries .....	15
Split pricing entries .....	16
Single item cash sale (SICS) entry .....	17
4 Displaying Subtotal .....	17
5 Finalization of Transaction .....	17
Cash or check tendering .....	17
Cash or check sale that does not require tender entry .....	18
Charge (credit) sale .....	18
Mixed-tender sale .....	18
6 Tax Calculation .....	19
Automatic tax .....	19
Manual tax .....	19
Tax delete .....	19
Tax status shift .....	20
<b>OPTIONAL FEATURES</b> .....	<b>21</b>
1 Auxiliary Entries .....	21
Discount and premium entries using the percent key .....	21
Discount and premium entries using the discount key .....	21
Refund entries .....	22
Non-add code number entries and printing .....	22
2 Auxiliary Payment Treatment .....	23
Currency conversion .....	23
Received-on Account and Paid-out Entries .....	24
No sale (exchange) .....	24
3 Automatic Sequence Key (AUTO key) Entries .....	24
<b>CORRECTION</b> .....	<b>25</b>
1 Correction of the Last Entry (direct void) .....	25
2 Correction of the Next-to-last or Earlier Entry (indirect void) .....	25
3 Subtotal Void .....	26
4 Correction of Incorrect Entries not Handled by the Direct or Indirect Void Function .....	26

**FOR THE MANAGER**

<b>PRIOR TO PROGRAMMING</b> .....	<b>27</b>
-----------------------------------	-----------

<b>BASIC FUNCTION PROGRAMMING (For Quick Start)</b> .....	<b>27</b>
1 Date and Time Programming .....	27
2 Tax Programming for Automatic Tax Calculation Function .....	28
Tax programming using a tax rate .....	28
The tax table (applicable to the add-on tax) .....	29
Quantity for doughnut tax exempt (for Canadian tax system) .....	31
<b>AUXILIARY FUNCTION PROGRAMMING</b> .....	<b>32</b>
1 Department Programming .....	32
2 PLU (Price Look-Up) and Subdepartment Programming .....	33
3 Miscellaneous Key Programming .....	35
Rate for [%1], [%2] and [CONV] .....	35
Amount for [⊖] .....	36
Percent rate limitation for [%1] and [%2] .....	36
Function parameters for [%1], [%2] and [⊖] .....	36
Function parameters for [CONV] .....	37
Entry digit limit for [RA], [RCPT/PO] and [TAX] .....	38
Function parameters for [CHK], [CH] and [CA/AT/NS] (when using as CA key) .....	38
4 Text programming .....	39
<b>ADVANCED PROGRAMMING</b> .....	<b>44</b>
1 Register Number and Consecutive Number Programming .....	44
2 Electronic Journal (EJ) Programming .....	45
3 Various Function Selection Programming 1 .....	47
Function selection for miscellaneous keys .....	47
Print format .....	48
Receipt print format .....	48
Function selection for tax .....	48
Other programming .....	49
4 Various Function Selection Programming 2 .....	51
Power save mode .....	51
Logo message print format .....	51
RS-232C interface .....	52
Thermal printer density .....	53
Language selection .....	53
Training clerk specification for training mode .....	53
AUTO key programming .....	54
5 Reading Stored Program .....	54
<b>TRAINING MODE</b> .....	<b>56</b>
<b>READING (X) AND RESETTING (Z) OF SALES TOTALS</b> .....	<b>57</b>
<b>EJ REPORT READING AND RESETTING</b> .....	<b>60</b>
<b>OVERRIDE ENTRIES</b> .....	<b>61</b>
<b>CORRECTION AFTER FINALIZING A TRANSACTION (Void mode)</b> .....	<b>61</b>
<b>OPERATOR MAINTENANCE</b> .....	<b>62</b>
1 In Case of Power Failure .....	62
2 In Case of Printer Error .....	62
3 Cautions in Handling the Printer and Recording Paper .....	62
4 Replacing the Batteries .....	63
5 Replacing the Paper Roll .....	63
6 Removing a Paper Jam .....	66
7 Cleaning the Printer (Print Head / Sensor / Roller) .....	66
8 Removing the Till and the Drawer .....	66
9 Opening the Drawer by Hand .....	66
10 Before calling for service .....	67
Error code table .....	67
<b>SPECIFICATIONS</b> .....	<b>68</b>

# PARTS AND THEIR FUNCTIONS

## 1 External View

### Front view

Operator display

Printer cover

Receipt paper

Drawer

Drawer lock

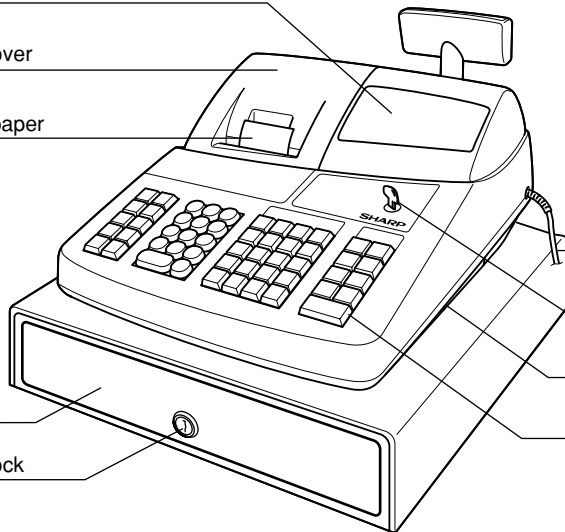

### Rear view

Customer display  
(Pop-up type)

Power cord

Mode switch

Keyboard

RS-232C connector

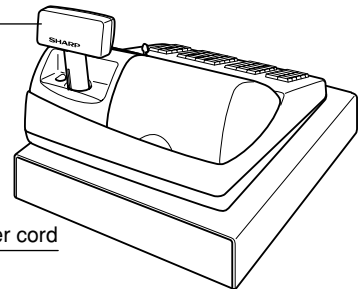

## 2 Printer

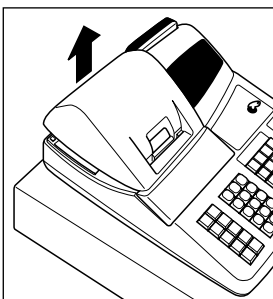

The printer is one station type thermal printer, therefore it does not require any type of ink ribbon or cartridge.

Lift the rear of the printer cover to remove. To re-install, hook the pawls on the cabinet and close.

**Caution: The paper cutter is mounted on the printer cover. Be careful not to cut yourself.**

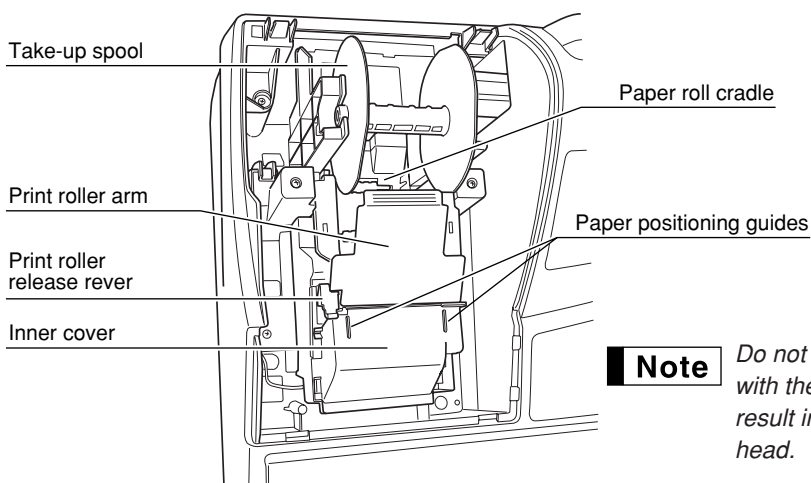

### Note

Do not attempt to remove the paper roll with the print roller arm is locked. This may result in damage to the printer and print head.

### 3 Mode Switch and Mode Keys

The mode switch can be operated by inserting one of the two supplied mode keys - manager (MA) and operator (OP) keys. These keys can be inserted or removed only in the "REG" or "OFF" position.

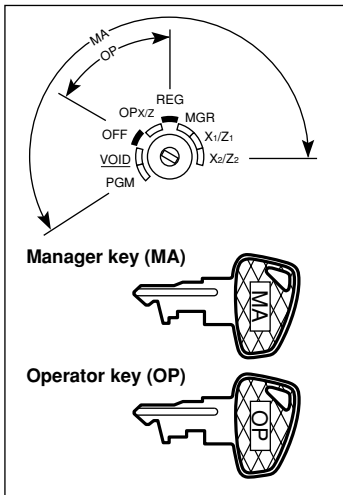

The mode switch has these settings:

- OFF:** This mode locks all register operations. (AC power turns off.) No change occurs to register data.
- OP X/Z:** To take individual clerk X or Z reports, and to take flash reports. It can be used to toggle receipt state "ON" and "OFF" by pressing the **RCPT/PO** key.
- REG:** For entering sales.
- PGM:** To program various items.
- VOID:** Enters into the void mode. This mode allows correction after finalizing a transaction.
- MGR:** For manager's entries. The manager can use this mode for an override entry.
- X1/Z1:** To take the X/Z report for various daily totals
- X2/Z2:** To take the X/Z report for periodic (weekly or monthly) consolidation

### 4 Keyboard

#### Keyboard layout

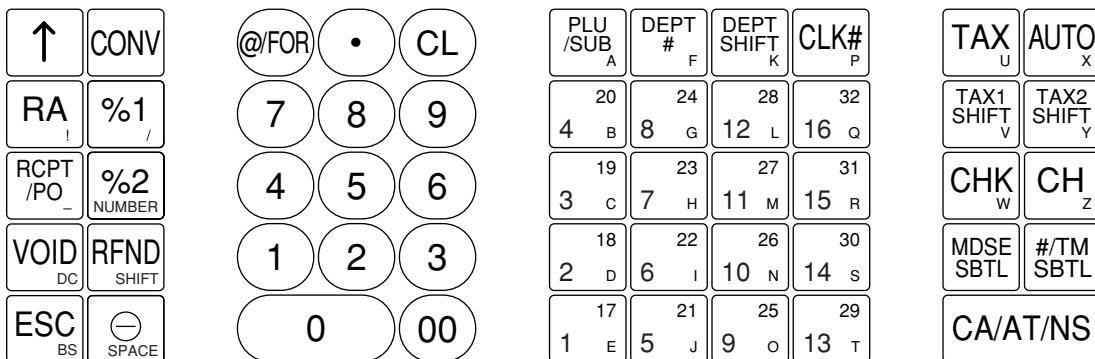

**Note** The small characters on the bottom or lower right in each key indicates functions or characters which can be used for character entries for text programming. For details, refer to page 39.

#### Key names

- ↑ Paper feed key
- RA Received-on account key
- RCPT /PO Receipt print/Paid-out key
- VOID Void key
- ESC Escape key
- CONV Conversion key
- %1 %2 Percent 1 and 2 keys
- RFND Refund key
- ⊖ Discount key
- @/FOR Multiplication key
- Decimal point key
- CL Clear key
- 00 0 ~ 9 Numeric keys
- PLU /SUB PLU/Subdepartment key
- DEPT # Department code entry key
- DEPT SHIFT Department shift key
- CLK# Clerk code entry key
- 17 32 1 ~ 16 Department keys
- TAX Tax key
- TAX1 SHIFT TAX2 SHIFT Tax 1 and 2 shift keys
- AUTO Automatic sequence key
- CHK Check key
- CH Charge key
- MDSE SBTL Merchandise subtotal key
- #/TM SBTL Non-add code/Time display /Subtotal key
- CA/AT/NS Total/Amount tender /No sale key

## 5 Displays

### Operator display

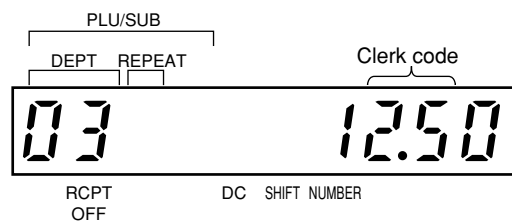

### Customer display (Pop-up type)

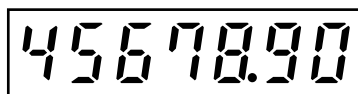

**Amount:** Appears in the far-right eight (max.) positions. When the amount is negative, the minus symbol “-” appears before the amount.

#### Number of repeats for repetitive registrations:

The number of repeats is displayed, starting at “2” and incremental with each repeat. When you have registered ten times, the display will show “0.”(2 → 3 …… 9 → 0 → 1 → 2 … )

#### Receipt function status:

The indicator “\_” appears in the RCPT OFF position when the receipt function is in the OFF status.

**Time:** Appears in the far-right six positions (hour-minute -“*H*” or hour-minute -“*P*”) in the OP X/Z, REG, or MGR mode. “*H*” is displayed in the morning (AM), and “*P*” in the afternoon (PM). In the REG or MGR mode, press the  $\boxed{\#T/M/SBTL}$  key to display the time.

### Machine state symbols

*P* : Appears during programming.

*E* : Appears when an error is detected.

*D* : Appears when the subtotal is displayed or when the amount tendered is smaller than the sales amount.

*C* : Appears when the  $\boxed{CONV}$  key is pressed to calculate a subtotal in foreign currency.

*F* : Appears when a transaction is finalized by pressing the  $\boxed{CA/AT/NS}$ ,  $\boxed{CHK}$  or  $\boxed{CH}$  key.

$\boxed{L}$  : Appears when the change due amount is displayed.

$\boxed{E-E}$  : May appear in the far-left three positions at the timing of key entry when the electronic journal (EJ) memory is full. (Depending on programming.)

$\boxed{L}$  : Appears when the voltage of the installed batteries is under the required level. You must replace with new ones within two days. Refer to page 63 for details.

$\boxed{L}$  : Appears when the batteries are not installed, or the installed batteries are dead. You must replace with new ones immediately. Refer to page 63 for details.

$\bullet$  : May appear right below the eighth and ninth places at the timing of finalization of a transaction when the electronic journal (EJ) memory is nearly full.  
Also appears right below the tenth place when power save mode is effective.

*H* : Appears when the print roller arm is not locked.

*PPPPPPPPPP* : Appears when the paper is not set or out.

## 6 Drawer Lock Key

This key locks and unlocks the drawer. To lock it, turn 90 degrees counterclockwise. To unlock it, turn 90 degrees clockwise.

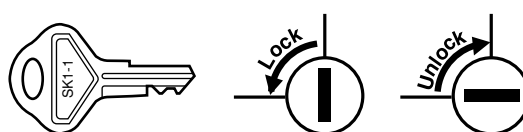



# GETTING STARTED

Please follow the procedure shown below. The batteries are not installed and the power is OFF.

## 1 Installing the cash register

Find a stable surface where the cash register is not subject to water sources or direct sunlight near an AC outlet.

Unpack the cash register and make sure all accessories are included. For details of accessories, please refer to "Specifications" section.

## 2 Initializing the cash register

In order for your cash register to operate properly, you must initialize it before programming for the first time. Follow this procedure.

1. Insert the manager (MA) key into the mode switch and turn it to the REG position.
2. Insert the plug into the AC outlet. The buzzer will sound three times.  
**IMPORTANT: This operation must be performed without batteries installed.**
3. The cash register has now been initialized. The register display will show "0.00" with "L".

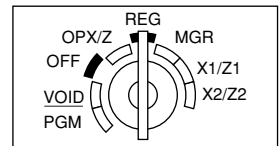

### Note

If the buzzer does not sound when the plug is inserted, the initialization has not been done successfully. (This will occur when the voltage is still high because you operated the cash register just before starting initialization.) In this case, wait at least one minute after pulling out the plug, and insert the plug again.

## 3 Installing batteries

Three new "AA" batteries must be installed in the cash register to prevent the data and user-programmed settings from being erased from the memory, when the AC cord is accidentally disconnected or in case of power failure. Once installed, the batteries will last approximately one year before needing replacement. At this time, the "L" symbol will appear on the display to indicate the batteries are low and must be replaced within two days. If the no battery symbol "L" appears, you must install the batteries at once.

Install three new "AA" batteries according to the procedure shown below with the AC cord connected and the mode switch set to the REG position:

1. Push the printer cover forward and detach it.  
**Be careful with the paper cutter, so as not to cut yourself.**
2. Open the battery compartment cover next to the paper roll cradle.

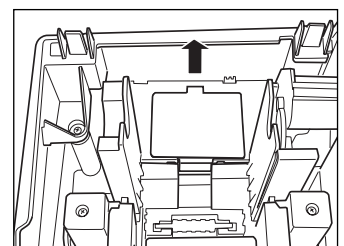

3. Insert three new "AA" batteries as illustrated at the right.  
When the batteries are properly installed "L" on the display will disappear.
4. Close the battery compartment cover.

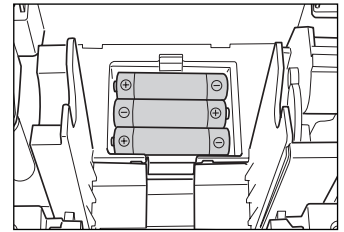

**Note** *Be sure to observe precautions shown on page 1 when handling batteries.*

## 4 Installing a paper roll

**Precaution: The paper cutter is mounted on the printer cover. Take caution when removing and installing the cover.**

The register can print receipts or journals. For the printer, you must install the paper roll provided with the register, even when you program the register for not printing receipts or journals. Install the paper roll according to the procedure shown below with the AC cord connected and the mode switch set to the REG position:

1. Lift up the print roller release lever to unlock and open the print roller arm.

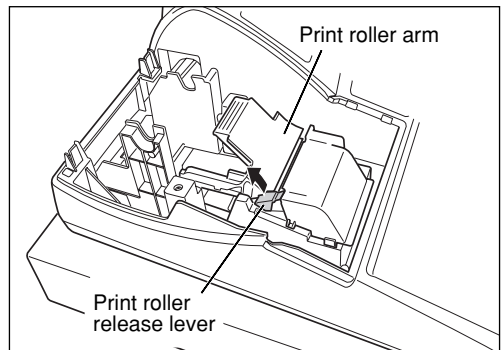

2. Set a paper roll in the paper roll cradle as illustrated at the right.

**Note** *When setting a new paper roll in the paper roll cradle, be sure to cut the paper end behind the taped (or pasted) point in advance.*

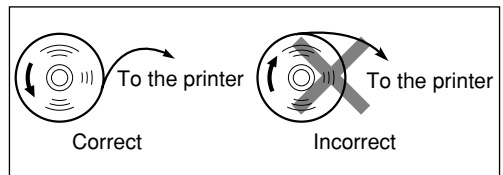

3. Feed the end of the paper along with the paper positioning guides as illustrated at the right.

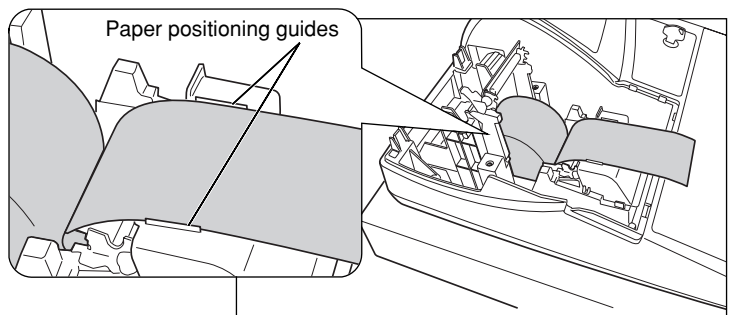

4. While holding down the paper, slowly close the print roller arm, and push down the arm until you hear a click locking the arm. Make sure securely you push down the center of the wing part of the arm as illustrated at the right. The paper will be fed automatically.

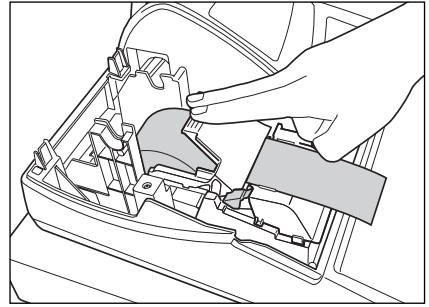

**Note** *If the print roller arm is not securely locked, printing is not done right. If this problem occurs, open the arm, and close the arm as instructed above.*

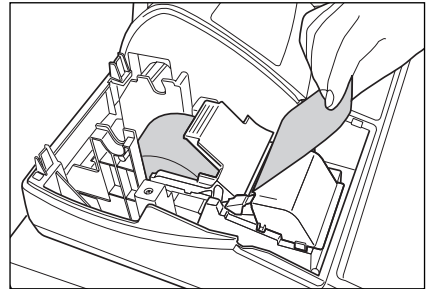

**5. When not using the take-up spool (using as receipt paper):**

- Cut off the excess paper using the edge of the inner cover, and replace the printer cover. Press the  key to make sure the paper end comes out of the printer cover and clean paper appears.



**Note** *If the paper end does not come out, open the printer cover, and pass the paper end between the paper cutter and the paper guide of the printer cover, and replace the cover.*

**When using the take-up spool (using as journal paper):**

- Insert the end of the paper into the slit in the spool. (Press the  key to feed more paper if required.)
- Wind the paper two or three turns around the spool shaft.
- Set the spool on the bearing, and press the  key to take up excess slack in the paper.
- Replace the printer cover.

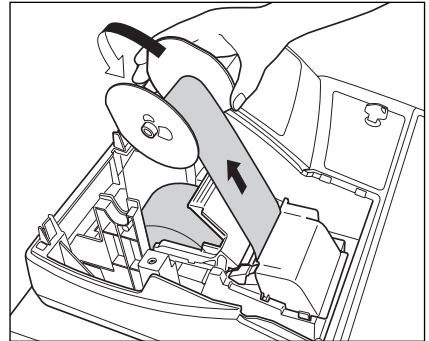

**Note** *When using a paper roll as journal paper, you must change the printing style. Refer to "Print Format" in "Various Function Selection Programming 1" section (Job code 6) for changing the printing style.*

## 5 Programming date, time and tax

**Note** *The cash register provides text languages of English, French and Spanish. It is preset to English. If you want to change the language, you must change it before programming. Refer to "Language selection" in "Various Function Selection Programming 2" section for changing the language.*

Before you can proceed with registration of sales, **you must program:**

- **date**
- **time**
- **tax**

Please refer to the BASIC FUNCTION PROGRAMMING section for details (page 27).

# 6

## Programming other necessary items

While the cash register is pre-programmed so it can be used with minimal setup, it does provide you with optional functions. Before you start programming, please read through the sales operations section to understand optional functions. The main optional functions are listed below.

- PLU (price lookup)
- Consecutive number
- Machine number
- Receipt or journal printing selection (factory setting: receipt printing)
- Power save mode (factory setting: goes into power save mode in 30 minutes)
- Electronic journal (EJ) memory size (factory setting: 2000 lines are storable. Up to 3000 lines)  
The memory for electronic journal is commonly used for PLU. If you change the setting, the maximum number of PLU code will decrease from 1200 to 200.
- Text programming for clerk name, department items, PLU/subdepartment items, logo messages printed on the top or bottom of receipts, function texts and foreign currency symbol
- Split pricing entry  
This is not factory preset. You must enable this function.
- Foreign currency conversion rate  
You must set a conversion rate to use **CONV** key.
- Preset unit price for departments and PLUs
- Preset amount for **⊖**
- Preset rates for **%1** **%2**  
You do not have to program these preset prices/amount/rates because you can enter when registration. It might be convenient to preset so you do not have to re-enter every time.
- Amount entry digit limit for PO amount, RA amount, Manual tax amount  
The factory setting makes the maximum amount you can enter. You can program to limit the amount.
- Key sequence for AUTO key
- RS-232C programming
- Specification of clerk to be trained

Department programming:

The cash register is pre-programmed for departments as follows:

Department: Allow open price entry, taxable status- taxable 1 for department 1 to 10, and non taxable for department 11 to 99

When you use department 11 or above, and/or you apply taxable status other than taxable 1 for department 1 to 10, you must change department settings. Please refer to the department programming section for programming details.

# 7

## Starting sales entries

Now you are ready for sales registration.

# OVERVIEW OF FLOW OF DAILY SALES ENTRIES

## Things to do before you start sales entries:

- Make sure the power cord is securely inserted into the AC outlet.
- Turn the mode switch to OP X/Z position, and check if time is correctly set.
- Replace the drawer, if removed for safety.
- Check if there is enough paper on roll.
- Select receipt ON/OFF function.
- Make any necessary programming for the day in PGM mode.

For details, refer to BASIC SALES ENTRY, page 12. For drawer and paper roll, refer to OPERATOR MAINTENANCE, page 62 and for programming, refer to programming sections.

## Things you can do for sales entries:

- Item entries
- Item repeat entries
- Item multiplication entries
- Single item cash sale (SICS), if programmed.
- Split pricing entries, if programmed.
- Displaying subtotals
- Cash/Check/Charge sale
- Cash tendering in a foreign currency, if the currency conversion rate is programmed.
- Manual tax entry
- Discount or premium using   and  key
- Refund entry
- No sale
- Paid-out entries
- Received on account entries
- Printing non-add code number
- Making corrections
- Checking sales report

For details of sales entry method, refer to BASIC SALES ENTRY (page 12) and OPTIONAL FEATURES (page 21). For details of correcting sales entries, refer to CORRECTION (page 25). For details on reading sales information, refer to READING (X) AND RESETTING (Z) OF SALES TOTAL (page 57).

## Things to do after you close your store:

- Print sales reports, and clear sales data for the day.
- Print Electronic Journal (EJ) reports, and clear Electronic Journal (EJ) data, if necessary.
- Account money - comparing it with the amount in cash in drawer printed on the general report.
- Remove the drawer for safety.
- Turn the mode switch to OFF position.

For details of reading sales information, refer to READING (X) AND RESETTING (Z) OF SALES TOTAL (page 57) and EJ REPORT READING AND RESETTING (page 60). For details of removing the drawer and maintenance details, refer to OPERATOR MAINTENANCE (page 62).

# BASIC SALES ENTRY

## 1 Basic Sales Entry Example

Listed below is a basic sales entry example when selling department items by cash. For operation details, please refer to each section.

### Mode switch setting

1. Turn the mode switch to the REG position.

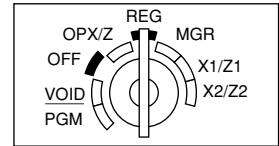

### Clerk assignment

2. Enter your clerk code. (For example, clerk code is 1. Press the **1** and **CLK#** key in this order.) The clerk code 1 is automatically selected just after initialization of the cash register.

### Item entries

3. Enter the price for the first department item. (For example, for 15.00, enter **1** **5** **00**, and press the appropriate department key.)

For department 17 to department 32, press the **DEPTSHIFT** key first before pressing the department key.

For department 33 and above, enter the department code using numeric keys, and press the **DEPT#** key, then enter the price and press the **DEPT#** key again.

4. Repeat step 3 for all the department items.

### Displaying subtotals

5. Press the **#/TMSBTL** key to display the amount due.

### Finalizing the transaction

6. Enter the amount received from the customer. (You can omit this step if the amount tendered is the same as the subtotal.)
7. Press the **CA/AT/NS** key, and the change due is displayed (when the amount received was not entered, the total amount is displayed) and the drawer is opened.
8. Tear off the receipt and give it to the customer with his or her change.
9. Close the drawer.

### Key operation example

Clerk assignment	→	<b>1</b> <b>CLK#</b>	<b>-01-</b>
Item entries	{	<b>1500</b> <b>1</b> <sup>17</sup>	<b>01 15.00</b>
		<b>2300</b> <b>2</b> <sup>18</sup>	<b>02 23.00</b>
Displaying subtotal	→	<b>#/TMSBTL</b>	<b>0 40.38</b>
		<b>5000</b>	<b>5000</b>
Finalizing the transaction	→	<b>CA/AT/NS</b>	<b>€ 9.62</b>

(In this example, the tax rate is set to 6.25%.)

### Print

<b>YOUR RECEIPT THANK YOU</b>		Graphic logo
<b>04/26/2006 2:32PM 01</b>	Date/Time/Clerk code number	
<b>123456#1027 CLERK01</b>	Register number /Consecutive number/Clerk name	
<b>DEPT. 01</b>	<b>T1 \$15.00</b>	Price
<b>DEPT. 02</b>	<b>T1 \$23.00</b>	Merchandise subtotal
<b>MDSE ST</b>	<b>\$38.00</b>	Tax amount
<b>TAX1</b>	<b>\$2.38</b>	Tax status (T1: taxable 1)
<b>ITEMS</b>	<b>20</b>	Total quantity
<b>***TOTAL</b>	<b>\$40.38</b>	Total amount
<b>CASH</b>	<b>\$50.00</b>	Cash tendering/amount received
<b>CHANGE</b>	<b>\$9.62</b>	Change

### Clerk assignment

Prior to any item entries, clerks must enter their clerk codes into the register. However, the code entry may not be necessary when the same clerk handles the next transaction.

#### ■ Sign-on (in REG, MGR, VOID mode)

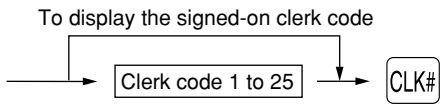

#### ■ Sign-off (in REG, MGR, VOID mode)

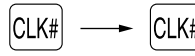

### Receipt ON/OFF function

When you use the printer to issue receipts, you can disable receipt printing in the REG mode to save paper using the receipt ON/OFF function. To disable receipt printing, press the **RCPT/PO** key in the OP X/Z position. This key toggles the receipt printing status ON and OFF.

To check the receipt printing status, turn the mode switch to the OP X/Z position or press the **CL** key in the REG mode. When the function is in the OFF status, the receipt off indicator “\_” is illuminated. Your register will print reports regardless of the receipt state, so the paper roll must be installed even when the receipt state is “OFF”.

#### **To issue a receipt when receipt ON/OFF function is set to OFF:**

If your customer wants a receipt after you finalized a transaction with the receipt ON/OFF function being OFF status, press the **RCPT/PO** key. This will produce a receipt. However, if more than 30 items were entered, the receipt will be issued in the format of summary receipt print.

### Power Save Mode

The register will enter into power save mode when no entries are performed based on the pre-programmed time limit (by default, 30 minutes).

When your register goes to the power save mode, it will light off all the display except the decimal point at the leftmost position. Your register will return to the normal operation mode when any key is pressed or a mode is changed with the mode key. Please note when your register is recovered by a key entry, its key entry is invalid. After the recovery, start the key entry from the beginning.

## 2 Error Warning

In the following examples, your register will go into an error state accompanied with a warning beep and the error symbol “E” on the display. Clear the error state by pressing the **CL** key and take proper action. Please refer to the error code table on page 67.

- You enter over a 32-digit number (entry limit overflow): Cancel the entry and re-enter the correct number.
- You make an error in key operation: Clear the error and continue operation.
- You make an entry beyond a programmed amount entry limit: Check to see if the entered amount is correct. If it is correct, it can be rung up in the MGR mode. Contact your manager.
- An including-tax subtotal exceeds eight digits: Delete the subtotal by pressing the **CL** key and press the **CA/AT/NS**, **CHK** or **CH** key to finalize the transaction.

### Error escape function

When you want to quit a transaction due to an error or an unforeseen event, use the error escape function as shown below:

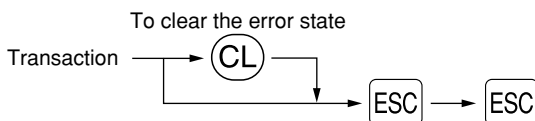

The transaction is voided (treated as a subtotal void) and the receipt is issued by this function. If you have already entered a tendered amount, the operation is finalized as a cash sale.

### 3 Item Entries

#### Single item entries

##### Department entries

The cash register provides a maximum of 99 departments for a merchandise classification. Group attributes, such as taxable status, are applied on items when they are entered to the departments.

##### • When using the department keys (for department 1 to 32)

For department 1 to 16, enter a unit price and press a department key. If you use a programmed unit price, press a department key only.

For department 17 to 32, enter a unit price, press the **DEPTSHIFT** key and press a department key. If you use a programmed unit price, press the **DEPTSHIFT** key and press a department key.

When using a programmed unit price

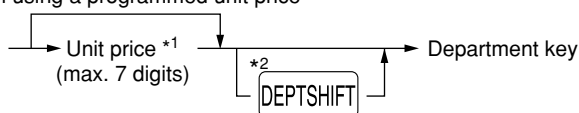

\*1 Less than the programmed upper limit amounts  
When zero is entered, only the sales quantity is added.

\*2 For the optional departments 17 through 32,  
press the **DEPTSHIFT** key.

##### • When using the department code entry key

Enter a department(dept.) code and press the **DEPT#** key, then enter a unit price and press the **DEPT#** key again. If the dept. code is programmed to preset price entry style and a unit price is preset, your cash register will finish its registration operation.

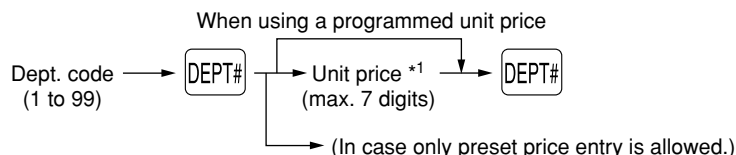

\*1 Less than the programmed upper limit amounts  
When zero is entered, only the sales quantity is added.

##### PLU/subdepartment entries

For another merchandise classification, the cash register provides a maximum of 1200 PLUs/subdepartments. PLUs are used to call up preset prices by a code entry. Subdepartments are used to classify merchandise into smaller groups under the departments. Every PLU and subdepartment has a code form 1 to 1200, and should belong to a department to obtain attributes of that department.

The cash register is pre-programmed to PLU mode and zero for unit price. To use PLU entries, their preset unit prices should be previously programmed. (Refer to page 33.)

To use subdepartment entries, change to subdepartment mode for the PLU codes.

##### • PLU entries



##### • Subdepartment (open PLU) entries

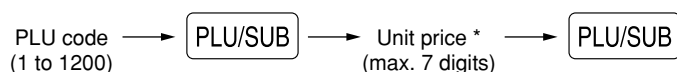

\* Less than the programmed upper limit amounts  
When zero is entered, only the sales quantity is added.



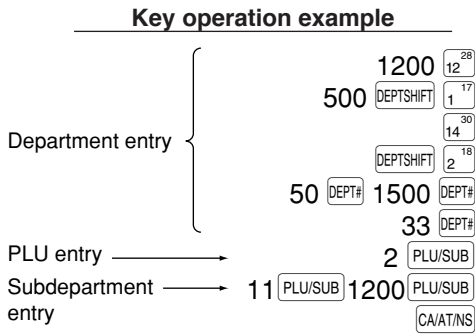

**Print**

DEPT. 12	\$12.00
DEPT. 17	\$5.00
DEPT. 14	\$8.25
DEPT. 18	\$3.25
DEPT. 50	\$15.00
DEPT. 33	\$2.50
PLU0002	\$1.50
PLU0011	\$12.00
ITEMS	8Q
CASH	\$59.50

### Repeat entries

You can use this function for entering a sale of two or more of the same items. Repeat pressing a department key, DEPT# key or PLU/SUB key as shown on key operation example.

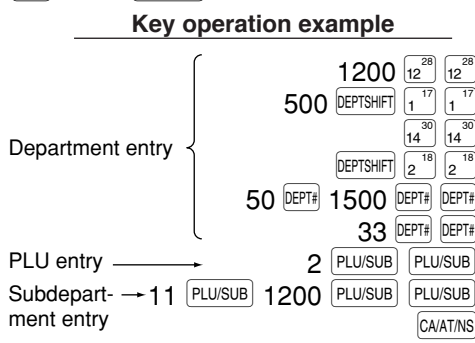

**Print**

DEPT. 12	\$12.00
DEPT. 12	\$12.00
DEPT. 17	\$5.00
DEPT. 17	\$5.00
DEPT. 14	\$8.25
DEPT. 14	\$8.25
DEPT. 18	\$3.25
DEPT. 18	\$3.25
DEPT. 50	\$15.00
DEPT. 50	\$15.00
DEPT. 33	\$2.50
DEPT. 33	\$2.50
PLU0002	\$1.50
PLU0002	\$1.50
PLU0011	\$12.00
PLU0011	\$12.00
ITEMS	16Q
CASH	\$119.00

### Multiplication entries

When you sell a large quantity of items, it is convenient to use the multiplication entry method. Enter quantity using numeric keys and press the (6/FOF) key before starting item entry as shown in the example below.

**Note** When programmed to allow fractional quantity entries, you can enter up to four integers and three digit decimal, though the quantity is counted as one for sales reports. To enter a fractional quantity, use the decimal point key between integer and decimal, as (7) (.) (5) for entering 7.5.

### Key operation example

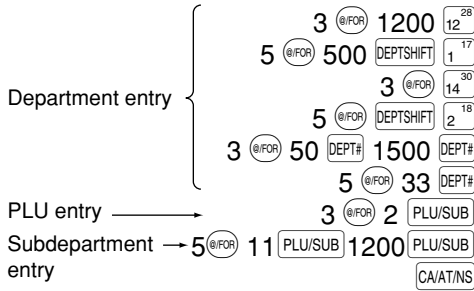

### Print

DEPT. 12	3 @	\$12.00	
		\$36.00	
DEPT. 17	5 @	\$5.00	
		\$25.00	
DEPT. 14	3 @	\$8.25	
		\$24.75	
DEPT. 18	5 @	\$3.25	
		\$16.25	
DEPT. 50	3 @	\$15.00	
		\$45.00	
DEPT. 33	5 @	\$2.50	
		\$12.50	
PLU0002	3 @	\$1.50	
		\$4.50	
PLU0011	5 @	\$12.00	
		\$60.00	
ITEMS	32Q		
<b>CASH</b>		<b>\$224.00</b>	

## Split pricing entries

This function is practical when the customer wants to purchase items normally sold in bulk. To realize this function, you must change the programmed setting. Refer to "Various Function Selection Programming 1" (job code 70) for programming details.

To make split pricing entries, follow the procedure below:

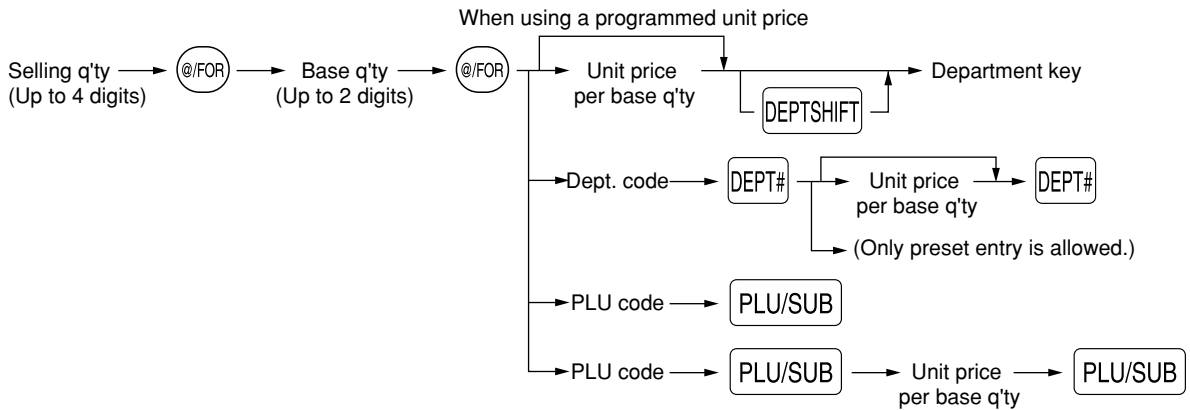

### Key operation example

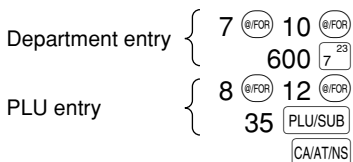

### Print

	7 @ 10/	\$6.00	
DEPT. 07		T1 \$4.20	
	8 @ 12/	\$10.00	
PLU0035		T1 \$6.67	
MOSE ST		\$10.87	
TAX1		\$0.68	
ITEMS	2Q		
<b>CASH</b>		<b>\$11.55</b>	

## ■ Single item cash sale (SICS) entry

- This function is useful when a sale is for only one item and is for cash. This function is applicable only to those departments that have been set for SICS or to their associated PLUs or subdepartments.
- The transaction is complete and the drawer opens as soon as you press the department key, **[DEPT#]** key or **[PLU/SUB]** key.

Key operation example	Print												
<p>For finishing the transaction → 250 <b>[9]</b> <sup>25</sup></p>	<table border="0" style="width: 100%;"> <tr> <td>DEPT. 09</td> <td style="text-align: right;">T1 \$2.50</td> </tr> <tr> <td>MDSE ST</td> <td style="text-align: right;">\$2.50</td> </tr> <tr> <td>TAX1</td> <td style="text-align: right;">\$0.16</td> </tr> <tr> <td colspan="2"> </td> </tr> <tr> <td>ITEMS</td> <td style="text-align: right;">1Q</td> </tr> <tr> <td><b>CASH</b></td> <td style="text-align: right;"><b>\$2.66</b></td> </tr> </table>	DEPT. 09	T1 \$2.50	MDSE ST	\$2.50	TAX1	\$0.16			ITEMS	1Q	<b>CASH</b>	<b>\$2.66</b>
DEPT. 09	T1 \$2.50												
MDSE ST	\$2.50												
TAX1	\$0.16												
ITEMS	1Q												
<b>CASH</b>	<b>\$2.66</b>												

**Note** If an entry to a department or PLU/subdepartment set for SICS follows the ones to departments or PLUs/subdepartments not set for SICS, it does not finalize and results in a normal sale.

## 4 Displaying Subtotals

The register provides three types of subtotals:

### Merchandise subtotal

Press the **[MDSESBTL]** key at any point during a transaction. The net sale subtotal - not including tax - will appear in the display.

### Taxable subtotal

Taxable 1 subtotal

Press the **[TAX1SHIFT]** and **[#/TMSBTL]** keys in this order at any point during a transaction. The sale subtotal of taxable 1 items will appear in the display.

Taxable 2 subtotal

Press the **[TAX2SHIFT]** and **[#/TMSBTL]** keys in this order at any point during a transaction. The sale subtotal of taxable 2 items will appear in the display.

### Including-tax subtotal (full subtotal)

Press the **[#/TMSBTL]** key at any point during a transaction. The sale subtotal including tax and the symbol "□" will appear in the display.

## 5 Finalization of Transaction

### ■ Cash or check tendering

Press the **[#/TMSBTL]** key to get an including tax subtotal, enter the amount tendered by your customer, then press the **[CA/AT/NS]** key if it is a cash tender or press the **[CHK]** key if it is a check tender. When the amount tendered is greater than the amount of the sale, your register will show the change due amount and the symbol "┌" will light up. Otherwise the register will show a deficit and the symbol "□" will light up. You now must make a correct tender entry.

Cash tendering

Key operation example	Print								
<p>1000 <b>[#/TMSBTL]</b> <b>[CA/AT/NS]</b></p>	<table border="0" style="width: 100%;"> <tr> <td>ITEMS</td> <td style="text-align: right;">3Q</td> </tr> <tr> <td><b>***TOTAL</b></td> <td style="text-align: right;"><b>\$7.35</b></td> </tr> <tr> <td><b>CASH</b></td> <td style="text-align: right;"><b>\$10.00</b></td> </tr> <tr> <td><b>CHANGE</b></td> <td style="text-align: right;"><b>\$2.65</b></td> </tr> </table>	ITEMS	3Q	<b>***TOTAL</b>	<b>\$7.35</b>	<b>CASH</b>	<b>\$10.00</b>	<b>CHANGE</b>	<b>\$2.65</b>
ITEMS	3Q								
<b>***TOTAL</b>	<b>\$7.35</b>								
<b>CASH</b>	<b>\$10.00</b>								
<b>CHANGE</b>	<b>\$2.65</b>								

Check tendering

**Key operation example**

}  
 #/TM/SBTL  
 1000 CHK

**Print**

ITEMS	3Q	
***TOTAL		<b>\$7.35</b>
CHECK		\$10.00
CHANGE		\$2.65

**■ Cash or check sale that does not require entry**

Enter items and press the **CA/AT/NS** key if it is a cash sale or press the **CHK** key if it is a check sale. Your register will display the total sale amount.

**Key operation example**

300 6<sup>22</sup>  
 10 PLU/SUB  
 CA/AT/NS

**Print**

DEPT. 06	T1	\$3.00
PLU0010	T1	\$7.15
MDSE ST		\$10.15
TAX1		\$0.63
ITEMS	2Q	
<b>CASH</b>		<b>\$10.78</b>

In the case of check sale

ITEMS	2Q	
<b>CHECK</b>		<b>\$10.78</b>

**■ Charge (credit) sale**

Enter items and press the charge key **(CH)**.

**Key operation example**

2500 6<sup>22</sup>  
 3250 7<sup>23</sup>  
 CH

**Print**

DEPT. 06	T1	\$25.00
DEPT. 07	T1	\$32.50
MDSE ST		\$57.50
TAX1		\$3.59
ITEMS	2Q	
<b>CHARGE</b>		<b>\$61.09</b>

**■ Mixed-tender sale**

You can perform mixed-tendering of check and cash, cash and charge, and check and charge.

Example: Your customer pays \$9.50 in cash and \$40.00 by charge for an including-tax subtotal of \$49.50.

**Key operation example**

}  
 #/TM/SBTL  
 950 CA/AT/NS  
 CH

**Print**

ITEMS	3Q	
***TOTAL		<b>\$49.50</b>
<b>CASH</b>		\$9.50
<b>CHARGE</b>		\$40.00

## 6 Tax Calculation

### Automatic tax

When the register is programmed with a tax rate (or tax table) and the tax status of an individual department is set for taxable, it computes the automatic tax on any item that is entered directly into the department or indirectly via a related PLU.

Example: Selling five \$6.70 items (dept. 1, taxable 1) and one \$7.15 item (PLU no. 85, taxable 2) for cash

<b>Key operation example</b>	<b>Print</b>																		
5 (B/FOR) 670 (1 <sup>17</sup> ) 85 (PLU/SUB) (CA/AT/NS)	<table border="0" style="width: 100%;"> <tr> <td style="width: 60%;"></td> <td style="text-align: right;">5 @ \$6.70</td> </tr> <tr> <td>DEPT. 01</td> <td style="text-align: right;">T1 \$33.50</td> </tr> <tr> <td>PLU0085</td> <td style="text-align: right;">T2 \$7.15</td> </tr> <tr> <td>MDSE ST</td> <td style="text-align: right;">\$40.65</td> </tr> <tr> <td>TAX1</td> <td style="text-align: right;">\$2.09</td> </tr> <tr> <td>TAX2</td> <td style="text-align: right;">\$0.29</td> </tr> <tr> <td colspan="2"> </td> </tr> <tr> <td>ITEMS</td> <td style="text-align: right;">6Q</td> </tr> <tr> <td><b>CASH</b></td> <td style="text-align: right;"><b>\$43.03</b></td> </tr> </table>		5 @ \$6.70	DEPT. 01	T1 \$33.50	PLU0085	T2 \$7.15	MDSE ST	\$40.65	TAX1	\$2.09	TAX2	\$0.29			ITEMS	6Q	<b>CASH</b>	<b>\$43.03</b>
	5 @ \$6.70																		
DEPT. 01	T1 \$33.50																		
PLU0085	T2 \$7.15																		
MDSE ST	\$40.65																		
TAX1	\$2.09																		
TAX2	\$0.29																		
ITEMS	6Q																		
<b>CASH</b>	<b>\$43.03</b>																		

### Manual tax

The machine allows you to enter tax manually after it finalizes an item entry.

Example: Selling an \$8.00 item (dept. 12) for cash with 50 cents as tax

<b>Key operation example</b>	<b>Print</b>										
800 (12 <sup>28</sup> ) 50 (TAX) (CA/AT/NS)	<table border="0" style="width: 100%;"> <tr> <td style="width: 60%;">DEPT. 12</td> <td style="text-align: right;">\$8.00</td> </tr> <tr> <td>M-TAX</td> <td style="text-align: right;">\$0.50</td> </tr> <tr> <td colspan="2"> </td> </tr> <tr> <td>ITEMS</td> <td style="text-align: right;">1Q</td> </tr> <tr> <td><b>CASH</b></td> <td style="text-align: right;"><b>\$8.50</b></td> </tr> </table>	DEPT. 12	\$8.00	M-TAX	\$0.50			ITEMS	1Q	<b>CASH</b>	<b>\$8.50</b>
DEPT. 12	\$8.00										
M-TAX	\$0.50										
ITEMS	1Q										
<b>CASH</b>	<b>\$8.50</b>										

### Tax delete

You can delete the automatic tax on the taxable 1 and taxable 2 subtotal of each transaction by pressing the (TAX) key after the subtotal is displayed.

To delete taxable 1 subtotal, press (TAX1SHIFT), (#/TM/SBTL) to get taxable 1 subtotal, and then press (TAX) to delete the subtotal.

To delete taxable 2 subtotal, press (TAX2SHIFT), (#/TM/SBTL) to get taxable 2 subtotal, and then press (TAX) to delete the subtotal.

To delete all taxable (1-4) subtotal, press (TAX1SHIFT), (TAX2SHIFT), (#/TM/SBTL) and (TAX) in this order.

Example: Selling a \$7.25 item (dept. 1, taxable 1) and another \$5.15 item (dept. 11, taxable 2) for cash and entering the sale as a non-taxable one

<b>Key operation example</b>	<b>Print</b>														
725 (1 <sup>17</sup> ) 515 (11 <sup>27</sup> ) (TAX1SHIFT) (#/TM/SBTL) (TAX) (TAX2SHIFT) (#/TM/SBTL) (TAX) (CA/AT/NS)	<table border="0" style="width: 100%;"> <tr> <td style="width: 60%;">DEPT. 01</td> <td style="text-align: right;">T1 \$7.25</td> </tr> <tr> <td>DEPT. 11</td> <td style="text-align: right;">T2 \$5.15</td> </tr> <tr> <td>TAX1 ST</td> <td style="text-align: right;">\$0.00</td> </tr> <tr> <td>TAX2 ST</td> <td style="text-align: right;">\$0.00</td> </tr> <tr> <td colspan="2"> </td> </tr> <tr> <td>ITEMS</td> <td style="text-align: right;">2Q</td> </tr> <tr> <td><b>CASH</b></td> <td style="text-align: right;"><b>\$12.40</b></td> </tr> </table>	DEPT. 01	T1 \$7.25	DEPT. 11	T2 \$5.15	TAX1 ST	\$0.00	TAX2 ST	\$0.00			ITEMS	2Q	<b>CASH</b>	<b>\$12.40</b>
DEPT. 01	T1 \$7.25														
DEPT. 11	T2 \$5.15														
TAX1 ST	\$0.00														
TAX2 ST	\$0.00														
ITEMS	2Q														
<b>CASH</b>	<b>\$12.40</b>														



# OPTIONAL FEATURES

## 1 Auxiliary Entries

### Discount and premium entries using the percent key

The percent key is used to apply a manually entered or preset discount or premium percent rate to individual items or to a merchandise subtotal. In the default setting, you can manually enter a discount percent rate to both individual items and merchandise subtotal. For manual entry of discount or premium percent rate, enter the rate (up to 100.00) with the numeric keys (you need a decimal point when you enter a fractional percent rate), and press a percent key. When using a preset rate (if programmed), just press a percent key.

When entry limit is programmed for a percent key, you can not enter a rate over the limit (error code 34 will occur.)

#### Percent calculation for the merchandise subtotal

##### Key operation example

4 @/FOR  
 140 5<sup>21</sup>  
 570 7<sup>23</sup>  
 MDSESBTL  
 10 %1  
 CA/AT/NS

##### Print

	4 @ \$1.40
DEPT. 05	T1 \$5.60
DEPT. 07	T1 \$5.70
MDSE ST	\$11.30
	-10%
%1	-1.13
MDSE ST	\$10.17
TAX1	\$0.71
ITEMS	5Q
<b>CASH</b>	<b>\$10.88</b>

#### Percent calculation for item entries

##### Key operation example

800 6<sup>22</sup>  
 7 5 %1  
 15 PLU/SUB  
 %2  
 CA/AT/NS

(When premium and 15% are programmed for the %2 key)

##### Print

DEPT. 06	T1 \$8.00
	-7.5%
%1	-0.60
PLU0015	T1 \$5.00
	15.00%
%2	\$0.75
MDSE ST	\$13.15
TAX1	\$0.81
ITEMS	2Q
<b>CASH</b>	<b>\$13.96</b>

### Discount and premium entries using the discount key

The discount key is used to apply a manually entered or preset discount or premium amount to individual items or to a merchandise subtotal. In the default setting, you can manually enter a discount amount to both individual items and merchandise subtotal. For manual entry of discount or premium amounts, enter the amount with the numeric keys, and press the discount key. When using a preset amount (if programmed), press the discount key.

When entry digit limit is programmed for the discount key, you can not enter an amount over the limit (error code 34 will occur.)

## Discount for the merchandise subtotal

### Key operation example

575  <sup>22</sup>  
 10   
  
 100

### Print

DEPT. 06	T1	\$5.75
PLU0010	T1	\$7.15
MDSE ST		\$12.90
(-)		-1.00
MDSE ST		\$11.90
TAX1		\$0.81
ITEMS	20	
<b>CASH</b>		<b>\$12.71</b>

## Discount for item entries

### Key operation example

675  <sup>23</sup>

(When a discount amount of \$0.75 is programmed.)

### Print

DEPT. 07	T1	\$6.75
(-)		-0.75
MDSE ST		\$6.00
TAX1		\$0.42
ITEMS	10	
<b>CASH</b>		<b>\$6.42</b>

## ■ Refund entries

For departments 1 to 16, enter the refund amount and press the  key, and then press the corresponding department key and for departments 17 to 32, enter the refund amount and press the  key, then press the  key and press the corresponding department key (when using the preset price, omit entering the amount). In case of department 33 to 99, enter the department code and press  key and the  key, then enter the refund amount and press the  key if necessary.

For a refund of a PLU item, enter the PLU code and press the  key, then press the  key.

For a refund of a subdepartment item, enter the PLU code and press the  key and  key, then enter the refund amount and press the  key.

### Key operation example

250   <sup>22</sup>  
 33   100   
 7   
 13    
 15   150

### Print

DEPT. 06	T1 R-	2.50
DEPT. 33	T1 R-	1.00
	-7 @	\$2.10
PLU0013	T1 R-	14.70
PLU0015	T1 R-	1.50
MDSE ST		-19.70
TAX1		-1.23
ITEMS	00	
<b>CHANGE</b>		<b>\$20.93</b>

## ■ Non-add code number entries and printing

You can enter a non-add code number such as a customer's code number and credit card number, a maximum of 16 digits, at any point during the entry of a sale. The cash register will print it at once.

To enter a non-add code number, enter the number and press the  key.



### Key operation example

1230   
 1500

### Print

#1230	
DEPT. 06	T1 \$15.00
MDSE ST	\$15.00
TAX1	\$0.94
ITEMS 1Q	
CHARGE	\$15.94

## 2 Auxiliary Payment Treatment

### ■ Currency conversion

The register allows payment entries in a foreign currency (only cash payment is available). Pressing the  key creates a subtotal in the foreign currency.

When using a programmed currency conversion rate, press the  key after item entries, then enter the tendered amount in foreign currency if not exact amount payment, and press the  key.

When making a manual entry of currency conversion rate, after item entries, enter the conversion rate (0.0000 to 9999.9999; you need a decimal point when you enter fractional conversion rate) and press the  key, then enter the tendered amount in foreign currency if not exact amount payment, and press the  key.

In both cases, the change due will be displayed in domestic currency, and when the amount tendered is short, the deficit is shown in domestic currency.

- Note**
- Press the  key after pressing the  key to cancel payment in a foreign currency.
  - If programmed, a foreign currency symbol is printed when you use a preset rate.

### Applying preset conversion rate

#### Key operation example

2300    
 4650    
 Currency conversion →   
 Amount → 10000   
 tendered in  
 foreign currency

(When a currency conversion rate of 0.9275 is programmed for the  key.)

#### Print

DEPT. 06	T1 \$23.00	
DEPT. 07	T1 \$46.50	
MDSE ST	\$69.50	
TAX1	\$4.34	
ITEMS 2Q		
***TOTAL	\$73.84	Domestic currency
CONV 1	0.9275	Conversion rate
	€68.49	Foreign currency
CASH	€100.00	
CHANGE	\$33.97	Domestic currency

Foreign currency symbol  
(Printed if programmed)

### Applying manual conversion rate

#### Key operation example

2300    
 4650    
 Conversion rate → 1  275   
 10000

#### Print

DEPT. 06	T1 \$23.00
DEPT. 07	T1 \$46.50
MDSE ST	\$69.50
TAX1	\$4.34
ITEMS 2Q	
***TOTAL	\$73.84
CONV 2	1.275
	94.15
CASH	100.00
CHANGE	\$4.58

## ■ Received-on Account and Paid-out Entries

When you receive on account from a customer or when you pay an amount to a vendor, it is a good idea to use the **RA** key or the **RCPT/PO** key respectively.

For the received-on-account (RA) entry, enter the amount, and press the **RA** key.

For the paid-out (PO) entry, enter the amount and press the **RCPT/PO** key.

**Note** *Cash tendering only available for RA and PO operation.*

### Key operation example

12345 **#/TM/STL**  
4800 **RA**

### Print

***RA	#12345	\$48.00
-------	--------	---------

## ■ No sale (exchange)

When you need to open the drawer with no sale, just press the **CA/AT/NS** key. The drawer will open and printer will print "NO SALE" on the receipt or journal. If you let the machine print a non-add code number before pressing the **CA/AT/NS** key, a no sale entry is achieved and a non-add code number is printed.

#45678
NO SALE

## 3 Automatic Sequence Key (**AUTO** key) Entries

You can achieve a programmed transaction simply by pressing the **AUTO** key.

### Key operation example

**AUTO**  
**AUTO** = 500 **7<sup>23</sup>** **CA/AT/NS**

### Print

DEPT. 07	T1	\$5.00
MOSE ST		\$5.00
TAX1		\$0.31
ITEMS	10	
<b>CASH</b>		<b>\$5.31</b>

# CORRECTION

## 1 Correction of the Last Entry (direct void)

If you make an incorrect entry relating to a department, PLU/subdepartment, percentage (%1 and %2), discount (⊖) or refund, you can void this entry by pressing the **VOID** key immediately after the incorrect entry.

### Key operation example

1250  <sup>22</sup>  
  
 2   
  
 600  <sup>24</sup>  
  
  
 328  <sup>25</sup>  
  
  
 250   <sup>22</sup>

### Print

DEPT. 06	T1	\$12.50
DEPT. 06	T1	V-12.50
PLU0002	T1	\$1.50
PLU0002	T1	V-1.50
DEPT. 08	T1	\$6.00
		15.00%
%2		\$0.90
%2		V-0.90
DEPT. 09	T1	\$3.28
(-)		-0.28
(-)		V\$0.28
DEPT. 06	T1	R-2.50
DEPT. 06	T1	RV\$2.50
MOSE ST		\$9.28
TAX1		\$0.58
ITEMS	20	
<b>CASH</b>		<b>\$9.86</b>

## 2 Correction of the Next-to-last or Earlier Entry (indirect void)

You can void any incorrect department entry, PLU/subdepartment entry or item refund entry made during a transaction if you find it before finalizing the transaction (e.g. pressing the **CA/AT/NS** key). This function is applicable to department, PLU/subdepartment and refund entries only.

For the operation, press the **VOID** key just before you press a department key, **DEPT#** key or **PLU/SUB** key. For the refund indirect void, press the **VOID** key after you press the **RFND** key.

### Key operation example

Correction of a department entry → 1310  <sup>22</sup>  
 1755  <sup>23</sup>  
 10   
 12   
 Correction of a PLU entry → 250   <sup>22</sup>  
 825  <sup>23</sup>  
 Correction of a refund entry → 1310   <sup>22</sup>  
 12    
 250    <sup>22</sup>

### Print

DEPT. 06	T1	\$13.10
DEPT. 07	T1	\$17.55
PLU0010	T1	\$7.15
PLU0012	T1	\$3.00
DEPT. 06	T1	R-2.50
DEPT. 07	T1	\$8.25
DEPT. 06	T1	V-13.10
PLU0012	T1	V-3.00
DEPT. 06	T1	RV\$2.50
MOSE ST		\$32.95
TAX1		\$2.06
ITEMS	30	
<b>CASH</b>		<b>\$35.01</b>

### 3 Subtotal Void

You can void an entire transaction. Once subtotal void is executed, the transaction is aborted and the register issues a receipt. This function does not work when more than 30 items have been entered.

<p><b>Key operation example</b></p> <hr/> <p>1310 <input type="button" value="2"/> <sup>18</sup>  <input type="button" value="2"/> <sup>18</sup>  1755 <input type="button" value="6"/> <sup>22</sup>  10 <input type="button" value="PLU/SUB"/>  35 <input type="button" value="PLU/SUB"/>  Subtotal void { <input type="button" value="#/TM/SBTL"/>  <input type="button" value="VOID"/>  <input type="button" value="#/TM/SBTL"/></p>	<p><b>Print</b></p> <hr/> <table border="1" style="width: 100%; border-collapse: collapse;"> <tr><td>DEPT.02</td><td>T1</td><td>\$13.10</td></tr> <tr><td>DEPT.02</td><td>T1</td><td>\$13.10</td></tr> <tr><td>DEPT.06</td><td>T1</td><td>\$17.55</td></tr> <tr><td>PLU0010</td><td>T1</td><td>\$7.15</td></tr> <tr><td>PLU0035</td><td>T1</td><td>\$3.00</td></tr> <tr><td>MDSE ST</td><td></td><td>\$53.90</td></tr> <tr><td>SBTL VD</td><td></td><td>-53.90</td></tr> <tr><td>***TOTAL</td><td></td><td>\$0.00</td></tr> </table>	DEPT.02	T1	\$13.10	DEPT.02	T1	\$13.10	DEPT.06	T1	\$17.55	PLU0010	T1	\$7.15	PLU0035	T1	\$3.00	MDSE ST		\$53.90	SBTL VD		-53.90	***TOTAL		\$0.00
DEPT.02	T1	\$13.10																							
DEPT.02	T1	\$13.10																							
DEPT.06	T1	\$17.55																							
PLU0010	T1	\$7.15																							
PLU0035	T1	\$3.00																							
MDSE ST		\$53.90																							
SBTL VD		-53.90																							
***TOTAL		\$0.00																							

### 4 Correction of Incorrect Entries not Handled by the Direct or Indirect Void Function

Any errors found after the entry of a transaction has been completed or during an amount tendered entry cannot be voided. These errors must be corrected by the manager.

The following steps should be taken:

1. If you are making the amount tendered entry, finalize the transaction.
2. Make correct entries from the beginning.
3. Hand the incorrect receipt to your manager for its cancellation.

# PRIOR TO PROGRAMMING

Before starting sales entries, you must first program necessary items so that the cash register suits your sales manner. In this manual, there are three sections, **BASIC FUNCTION PROGRAMMING** where **required items must be programmed**, **AUXILIARY FUNCTION PROGRAMMING** where you can program for more convenient use of keys on the keyboard, and **ADVANCED FUNCTION PROGRAMMING** where various optional programming features are provided. Find the appropriate features for your needs, and make the necessary programming.

**Note** You can select the language of text (English, French or Spanish) printed on receipts or journals. For the language selection, please refer to "Language Selection" described later in this section.

## ■ Procedure for programming

1. Check to see whether a paper roll is present in the machine. If there is not enough paper on the roll, replace it with a new one (refer to MAINTENANCE section for the replacement).
2. Put the manager key in the mode switch and turn it to the PGM position.
3. Program necessary items into the cash register.  
Every time you program an item, the cash register will print the setting. Please refer to print samples in each section.
4. If necessary, issue programming reports for your reference.

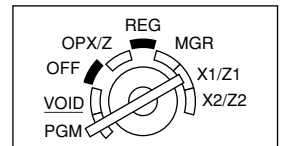

**Note**

- On the procedures and key operation examples shown in the programming details, numbers such as "04262006" indicates the parameter which must be entered using the corresponding numeric keys.
- Asterisks in the tables shown in the programming details indicate default settings.

# BASIC FUNCTION PROGRAMMING

## (For Quick Start)

### 1 Date and Time Programming

#### ■ Date

For setting the date, enter the date in 8 digits using the month-day-year (MM/DD/YYYY) format, then press the **#/TM/SBTL** key.

**Procedure**      Date(MM/DD/YYYY) → **#/TM/SBTL**

#### Key operation example

04262006 **#/TM/SBTL**  
(Apr. 26, 2006)

#### Print

**\*PGM\***      04/26/2006 — Date

**Note** You can use the date format of day-month-year (DD/MM/YYYY) or year-month-day (YYYY/MM/DD) format. To change the format, refer to "Various Function Selection Programming 1" section (Job code 61).

## ■ Time

For setting the time, enter the time in 4 digits using the 24-hour format. For example, when the time is set to 2:30 AM, enter 230; and when it is set to 2:30 PM, enter 1430.

### Procedure

Time(max. 4 digits in 24-hour format) → #/TM/SBTL

### Key operation example

1430 #/TM/SBTL

### Print

\*PGM\* 2:30PM Time

### Note

In the display, current time is displayed in 12-hour format. For AM time, "A" and for PM time "P" will appear in the rightmost position with the current time. If you want to display time in the 24-hour format, refer to "Various Function Selection Programming 1" section (Job code 61).

## 2 Tax Programming for Automatic Tax Calculation Function

### Note

The cash register can support US and Canadian tax systems. If you use the Canadian tax system, you must first change the tax system, then program the tax rate or tax table and quantity for doughnut exempt which are described in this section. For changing your cash register's tax system, please refer to "Various Function Selection Programming 1" section (job code 70).

Before you can proceed with registration of sales, you must first program the tax that is levied in accordance with the law of your state. The cash register comes with the ability to program four different tax rates. In most states, you will only need to program Tax 1. However if you live in an area that has a separate local tax (such as a Parish tax) or a hospitality tax, the register can be programmed to calculate these separate taxes.

When you program the tax status for a department, tax will be automatically added to sales of items assigned to the department according to the programmed tax status for the department. You can also enter tax manually.

There are two tax programming methods. The tax rate method uses a straight percentage rate per dollar. The tax table method requires tax break information from your states or local tax offices. Use the method which is acceptable in your state. You can obtain necessary data for tax programming from your local tax office.

## ■ Tax programming using a tax rate

The percent rate specified here is used for tax calculation on taxable subtotals.

### Procedure

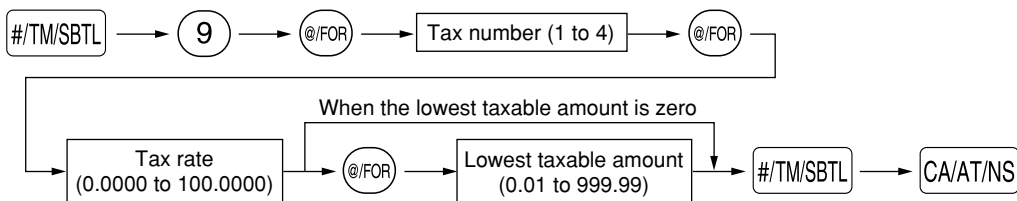

To delete a tax rate, use the following sequence:

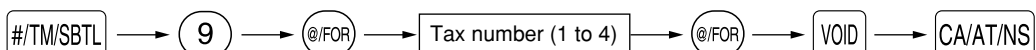

Example: Programming the tax rate 4% as tax rate 2 with tax exempt as 12¢

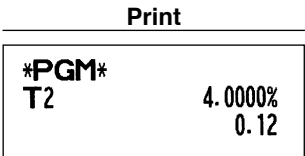
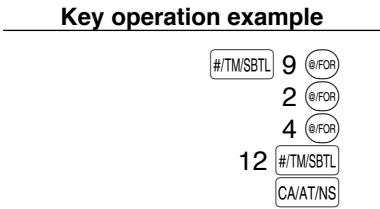

**Note**

- If you make an incorrect entry before pressing the third **@/FOR** key in programming a tax rate, cancel it with the **CL** key.
- You do not need to enter the trailing zeros of the tax rate (after the decimal point), but you do need to enter the decimal for fractions.
- The lowest taxable amount setting is ignored when you select VAT system for Canadian tax.

**The tax table (applicable to the add-on tax)**

If you are in an area that uses a tax table for tax calculation, you can program the cash register accordingly. Tax table programming can be performed for Tax 1 through Tax 4.

**Sample tax table**

New Jersey tax table: 6%

Taxes	Range of sales amount		A: Difference between the minimum breakpoint and the next one (¢)	
	Minimum breakpoint	Maximum breakpoint		
.00	.01	to .10	–	
<b>.01</b> ← T	<b>.11</b> ← Q	to .22	10 (0.11 - 0.01)	B: Non-cyclic
.02	.23	to .38	12 (0.23 - 0.11)	C: Cyclic-1
.03	.39	to .56	16 (0.39 - 0.23)	
.04	.57	to .72	18 (0.57 - 0.39)	
.05	.73	to .88	16 (0.73 - 0.57)	D: Cyclic-2
.06	.89	to 1.10	16 (0.89 - 0.73)	
.07	<b>1.11</b> ← M1	to 1.22	22 (1.11 - 0.89)	
.08	1.23	to 1.38	12 (1.23 - 1.11)	
.09	1.39	to 1.56	16 (1.39 - 1.23)	
.10	1.57	to 1.72	18 (1.57 - 1.39)	
.11	1.73	to 1.88	16 (1.73 - 1.57)	
.12	1.89	to 2.10	16 (1.89 - 1.73)	
.13	<b>2.11</b> ← M2	to 2.22	22 (2.11 - 1.89)	

To program a tax table, first make a table like the one shown above right. From the tax table, calculate the differences between a minimum break point and the next one (A). Then, from the differences, find irregular cycles (B) and regular cycles (C and D). These cycles will show you the following items necessary to program the tax table:

- T:** The tax amount collected on the minimum taxable amount (Q)
- Q:** The minimum taxable amount
- M1:** The maximum value of the minimum breakpoint on a regular cycle (C)  
We call this point "MAX point."
- M2:** The maximum value of the minimum breakpoint on a regular cycle (D)  
We call this point "MAX point."
- M:** Range of the minimum breakpoint on a regular cycle: difference between Q and M1 or between M1 and M2

## Procedure

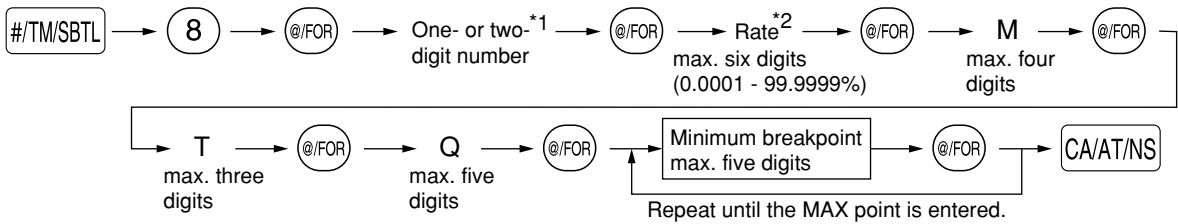

To delete a tax table, use the following sequence:

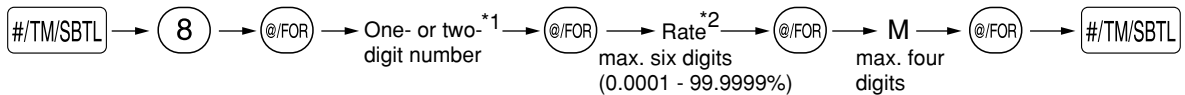

**\*1 First figure:** The first figure to be entered depends upon whether the difference between a minimum breakpoint to be entered and the preceding minimum breakpoint is not less than \$1.00 or more than 99¢. When the difference is not less than \$1.00, enter “1,” and when it is not more than 99¢, enter “0” or nothing.

**Second figure:** The second figure depends upon whether your tax table is to be programmed as tax table 1, 2, 3 or 4.

**\*2** If the rate is fractional (e.g. 4-3/8%), then the fractional portion (3/8) would be converted to its decimal equivalent (i.e. .375) and the resulting rate of 4.375 would be entered. Note that the nominal rate (R) is generally indicated on the tax table.

**Note** If you make an incorrect entry before entering the M in programming a tax table, cancel it with the **CL** key; and if you make an error after entering the M, cancel it with the **#/TM/SBTL** key. Then program again from the beginning.

### • Limitations to the entry of minimum breakpoints

The register can support a tax table consisting of no more than 72 breakpoints. (The maximum number of breakpoints is 36 when the breakpoint difference is \$1.00 or more.) If the number of breakpoints exceeds the register’s table capacity, then the manual entry approach should be used.

Example: Programming the sample tax table shown on the previous page as tax table 1

#### Key operation example

	#/TM/SBTL	8	@/FOR
		1	@/FOR
Tax rate	→	6	@/FOR
M	→	100	@/FOR
T	→	1	@/FOR
Q	→	11	@/FOR
The first cyclic portion	}	23	@/FOR
		39	@/FOR
		57	@/FOR
		73	@/FOR
M1 (MAX point)	→	89	@/FOR
		111	@/FOR
			CA/AT/NS

#### Print

#PGM*	
T1	6.0000%
	/ 1.00
1	0.11
2	0.23
3	0.39
4	0.57
5	0.73
6	0.89
7	1.11

**Note** You do not need to enter the trailing zeros of the tax rate (after the decimal point) but you do need to enter the decimal point for fractions.



- If the tax is not provided for every cent, modify the tax table by setting the tax for every cent in the following manner.

When setting the tax, consider the minimum breakpoint corresponding to unprovided tax to be the same as the one corresponding to the tax provided on a large amount.

**Sample tax table**  
**Example 8%**

**Modification of the left tax table**

Tax	Minimum breakpoint
.00	.01
.01	.11
.02	.26
.03	.47
.04	.68
.06	.89
.09	1.11
.10	1.26
.11	1.47
.12	1.68
.14	1.89
.17	2.11

Tax	Minimum breakpoint
.00	.01
.01 → T	.11 → Q
.02	.26
.03	.47
.04	.68
.05	.89
.06	.89
.07	1.11 → M1
.08	1.11
.09	1.11
.10	1.26
.11	1.47
.12	1.68
.13	1.89
.14	1.89
.15	2.11 → M2
.16	2.11
.17	2.11



Breakpoint difference (¢)	
1	
10 (0.11-0.01)	B: Non-cyclic
15 (0.26-0.11)	
21 (0.47-0.26)	
21 (0.68-0.47)	
21 (0.89-0.68)	
0 (0.89-0.89)	C: Cyclic-1
22 (1.11-0.89)	
0 (1.11-1.11)	
0 (1.11-1.11)	
15 (1.26-1.11)	
21 (1.47-1.26)	
21 (1.68-1.47)	
21 (1.89-1.68)	
0 (1.89-1.89)	D: Cyclic-2
22 (2.11-1.89)	
0 (2.11-2.11)	
0 (2.11-2.11)	

From the modified tax table above;

Rate = 8(%), T = \$0.01 = 1¢, Q = \$0.11 = 11¢, M1 = 1.11, M2 = 2.11, M = 100

**Quantity for doughnut tax exempt (for Canadian tax system)**

This option is available only when the Canadian tax system is selected.

**Procedure**

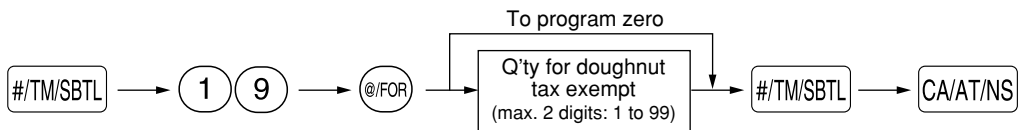

Example: To program the quantity "6"

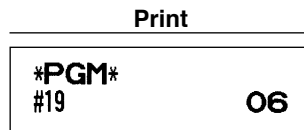
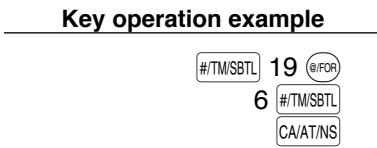

# AUXILIARY FUNCTION PROGRAMMING

## 1 Department Programming

Merchandise can be classified into a maximum of 99 departments. Items sold with use of the department keys can later be printed on a report that shows the quantities sold and sales amounts classified by department. The data is useful for making purchasing decisions and other store operations. Departments can be assigned to articles whose prices were set using PLU/subdepartment function.

When using a department key, you must set the parameters to specify the department status, such as positive or negative department. Prices can be assigned directly to departments for frequently purchased items, which enables you to enter the prices by simply pressing the department keys or dept. code entries.

### Department status

#### Procedure

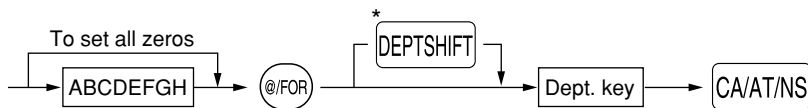

\*To program departments 17 through 32, press the department shift key at this point.

For department 33-99:

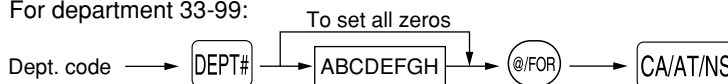

To program another department, start from the beginning without pressing the **CA/AT/NS** key.

Item:	Selection:	Entry:
A Tax 4 status	Taxable	1
	Non-taxable*	0
B Tax 3 status	Taxable	1
	Non-taxable*	0
C Tax 2 status	Taxable	1
	Non-taxable*	0
D Tax 1 status	Taxable (*for dept. 1 thru 10)	1
	Non-taxable (*for dept. 11 thru 99)	0
E SICS / Normal	SICS	1
	Normal*	0
F Sign	Negative department	1
	Positive department*	0
G Entry digit limit		0-7 (default: 7)
H Type of unit price entry	Open and preset	3
	Preset only	2
	Open only*	1
	Inhibit department key	0

#### Tax status (taxable 1 through 4 / non-taxable)

- When any entry of a taxable department is made in a transaction, tax is automatically computed according to the associated tax table or rate.

#### SICS (Single Item Cash Sale)

- If an entry of a department programmed for SICS is made first, the sale will be finalized as a cash sale as soon as the department key is pressed. If the entry is made after entering a department not programmed for SICS, the sale will not be finalized until the **CA/AT/NS** key is pressed.

#### Entry digit limit

- 32 • Set the number of allowable digits for the maximum entry amount for each department. The limit is effective for operations in the REG mode and can be overridden in the MGR mode.

Example: Programming department 2 as taxable 1, SICS, negative department, entry digit limit - 7 digits, and allowing open & preset entry. (ABCDEFGH: 00011173)



## ■ Preset unit price

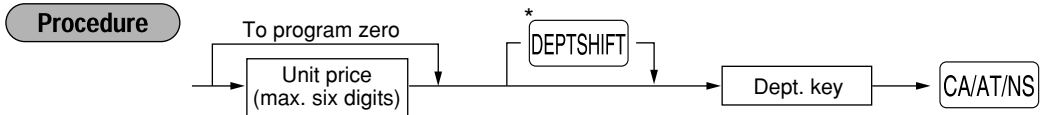

\*To program departments 17 through 32, press the department shift key at this point.

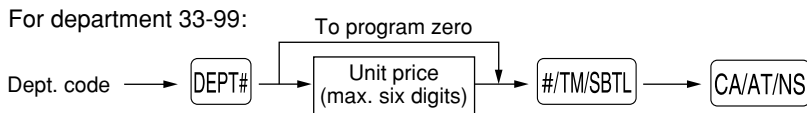

To program another department, start from the beginning without pressing the CA/AT/NS key.

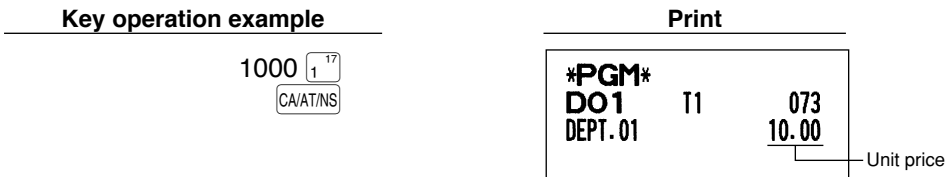

**Note** Even if a department is not programmed to allow the entry of preset unit prices in functional programming, the department is automatically changed to allow the entry of preset unit prices by this programming entry.

## 2 PLU (Price Look-Up) and Subdepartment Programming

The PLU function allows speedy key entries whereby a price is automatically called up when a code is entered. The subdepartment is a kind of “open PLU”, which requires you to enter a price after the PLU code is entered. A maximum of 1200 PLU/subdepartment settings are possible. Each one belongs to a department and acquires the department’s parameters (tax status, SICS and sign).

The cash register is preprogrammed so all 1200 codes are assigned as PLUs associated with department 1 and preset unit price “0”.

## Unit price and associated department assignment

### Procedure

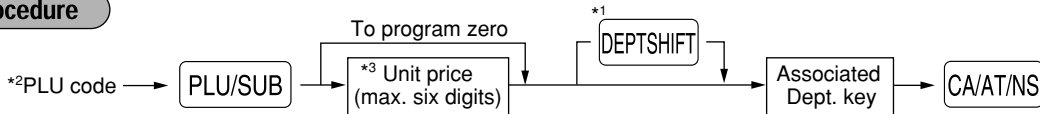

\*1: To assign departments 17 through 32, press the department shift key at this point.

When the associated department is department 33-99:

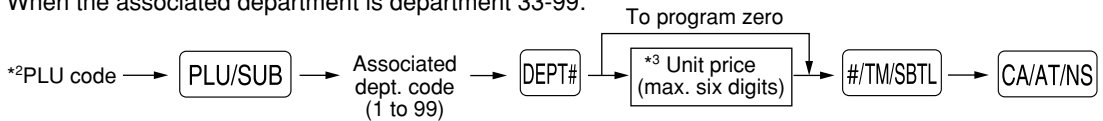

\*2: 1 through 1200 (Depending on the EJ memory size setting, up to 200)

\*3: For a subdepartment, set the limit amount of unit price entry.

To program the following PLU, start from entering a unit price or an associated department code without pressing the [CA/AT/NS] key.

To program another PLU, start from the beginning without pressing the [CA/AT/NS] key.

### Key operation example

1 [PLU/SUB]  
125 [3]<sup>19</sup>  
[CA/AT/NS]

### Print

```
*PGM*
P0001 (03)      1
PLU0001         1.25
```

Unit price  
Associated dept.

PLU code

To delete a PLU code, use the following sequence:

### Procedure

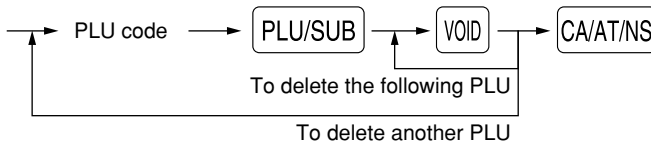

## PLU/subdepartment selection

### Procedure

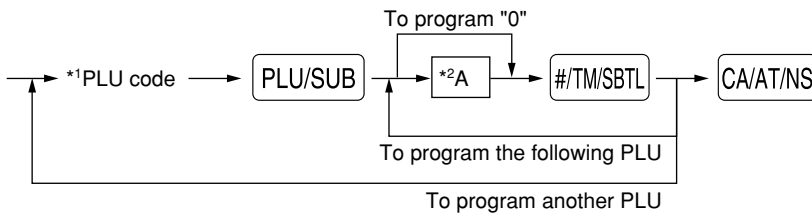

\*1: 1 through 1200 (Depending on the EJ memory size setting, up to 200)

\*2: 0 for subdepartment or 1 for PLU (default: 1)

### Key operation example

1 [PLU/SUB]  
0 [#/TM/SBTL] [CA/AT/NS]

### Print

```
*PGM*
P0001 (03)      0
PLU0001         1.25
```

PLU/subdept.

### Note

When you program the last PLU code, the programming sequence will be complete with a press of the [#/TM/SBTL] key.

### 3 Miscellaneous Key Programming

The cash register provides miscellaneous keys such as %1, %2, ⊖, RFND, RA, RCPTPO, CONV, TAX, CHK, CH and CA/AT/NS. While the cash register is pre-programmed so you can use these keys, you must set a currency conversion rate to use CONV key. You can also program these keys for more convenient use. Please refer to the data below for programming these keys. Factory setting is indicated with parentheses.

- %1, %2      Percent rate (0.00%), tax status (non-taxable), sign (minus), item % and subtotal % entry\* (both are allowed), percent rate limitation (100 %)
- ⊖            Amount (0.00), tax status (non-taxable), sign (minus), item ⊖ and subtotal ⊖ entry\* (both are allowed), entry digit limit (7 digits)
- RFND        Not necessary to program
- RA, RCPTPO      Entry digit limit (9 digits)
- CONV        Currency conversion rate (0.0000), currency conversion rate entry method - open or preset (both are enabled)
- CHK, CH and CA/AT/NS      Compulsory entry of amount tender (not compulsory), entry digit limit (8 digits), footer printing (not printed)
- TAX (Manual tax)      Entry digit limit (7 digits)

\* Item %/Item ⊖:      Percent/discount calculation is applied to individual department and PLU/subdepartment.

\* Subtotal %/Subtotal ⊖: Percent/discount calculation is applied to subtotals.

#### ■ Rate for %1, %2 and CONV

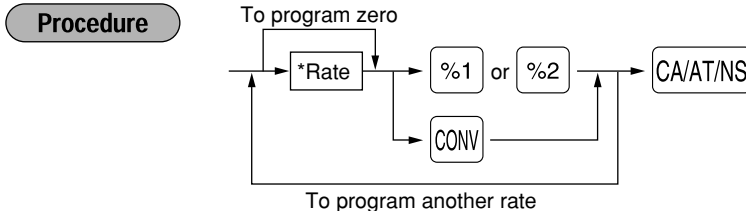

- \*: Rate
- 0.00 — 100.00 (% rate)
- 0.0000 — 9999.9999 (Currency conversion rate)

#### Key operation example

```

10 ⊙ 25 %1
0 ⊙ 9275 CONV
      CA/AT/NS
  
```

#### Print

*PGM*		
F02 %1	000	
L100.00%	-10.25%	Percent rate
F48 CONV 1	00	
	0.9275	Currency conversion rate

**Note** You must use a decimal point when setting fractional rates.

## ■ Amount for ⊖

### Procedure

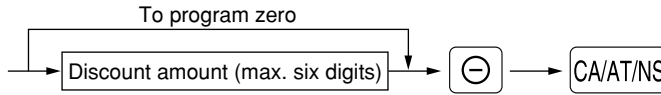

### Key operation example

200 ⊖  
CA/AT/NS

### Print

```
*PGM*
F01 (-)          007
                 -2.00
                 |
                 |----- Discount amount
```

## ■ Percent rate limitation for %1 and %2

### Procedure

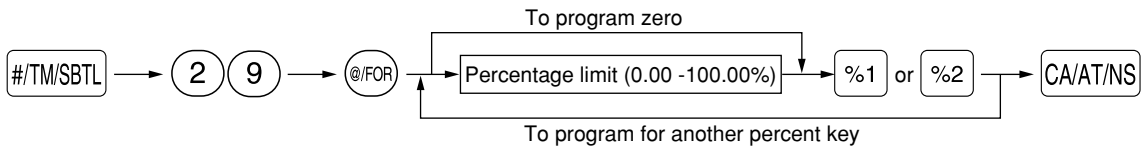

### Note

- Percent entries that exceed the upper limit may be overridden in the MGR mode.
- 10.00% can be entered as (1) (0) or (1) (0) (•) (0) (0). The (•) key is needed only for fractional entry.

### Key operation example

#/TM/SBTL 29 @/FOR  
15 (•) 00 %1  
CA/AT/NS

### Print

```
*PGM*
F02 %1          000
L 15.00%       -10.25%
                 |
                 |----- Percentage limit
```

## ■ Function parameters for %1, %2 and ⊖

### Procedure

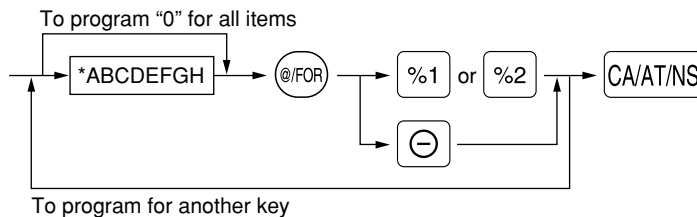

*: Item:	Selection:	Entry:
<b>A</b> Tax 4 status	Taxable	1
	Non-taxable*	0
<b>B</b> Tax 3 status	Taxable	1
	Non-taxable*	0
<b>C</b> Tax 2 status	Taxable	1
	Non-taxable*	0
<b>D</b> Tax 1 status	Taxable	1
	Non-taxable*	0
<b>E</b> +/- sign	+ (premium) sign	0
	- (discount) sign*	1
<b>F</b> Item % / Item ⊖	Allow*	0
	Disallow	1
<b>G</b> Subtotal % / Subtotal ⊖	Allow*	0
	Disallow	1
<b>H</b> Entry digit limit for discount key		0-7 (default: 7)

When programming for percent keys, always enter 0 for H.

### Tax status (taxable 1 through 4 / non-taxable)

- When taxable is selected, tax is applied to the amount obtained after premium or discount calculation.



### +/- sign

- Programming of the +/- sign assigns the premium or discount function for each key.

### Entry digit limit (For discount key only)

- The entry digit limit is in effect for the REG mode operations but can be overridden in the MGR mode. The entry digit limit is represented by the number of allowable digit for the maximum entry amount for discount key.

#### Key operation example

00011006   
 

#### Print

```

*PGM*
F01 (-)      006
              |
              T1  -2.00
              |
              Tax status
  
```

From left, FGH  
Sign(E)

### Function parameters for

#### Procedure

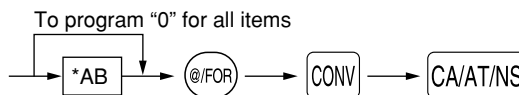

*: Item:	Selection:	Entry:
<b>A</b> Open rate entry	Allow*	0
	Disallow	1
<b>B</b> Preset rate entry	Allow*	0
	Disallow	1

#### Key operation example

00   
 

#### Print

```

*PGM*
F48 CONV 1      00
                |
                0.9275
  
```

From left, AB

## ■ Entry digit limit for RA, RCPT/PO and TAX

### Procedure

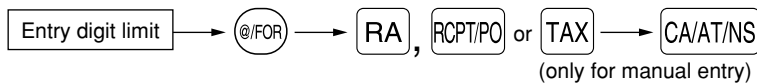

- For RA, RCPT/PO, enter 0 to 9 (digits), and for TAX (manual tax), enter 0 to 7 (digits). By default, 9 for RA and RCPT/PO and 7 for TAX are set.

Entry digit limit is in effect for REG mode operation but can be overridden in the MGR mode. The entry digit limit is represented by the number of allowable digits for maximum entry or total amount. When “0” is set, the operation of the corresponding key is prohibited.

### Key operation example



### Print

```

*PGM*
F41 ***P0      4
  
```

## ■ Function parameters for CHK, CH and CA/AT/NS (when using as CA key)

### Procedure

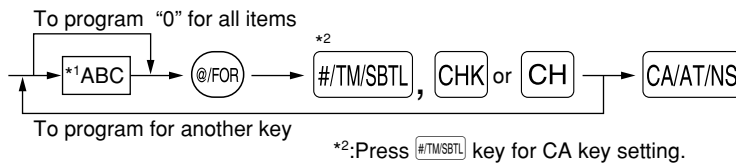

*1:Item:	Selection:	Entry:
A	Footer printing	Allow
		Disallow*
B	Amount tendered entry	Compulsory
		Non-compulsory (for the CA or CHK keys)*
		Inhibit (for the CH key)*
C	Entry digit limit	0-8 (default: 8)

### Footer printing

- This programming decides whether or not the machine should print a message at the foot of a receipt when a specified media key is used. With regard to programming method of footer logo message, refer to “Logo messages” section on page 43.

### Amount tendered entry

- You may select amount tendered, compulsory or optional, for the CA/AT/NS and CHK keys.
- You may select amount tendered, compulsory or inhibited, for the CH key.

### Entry digit limit

- For the CH and CHK keys, program upper limit entry amount for the tendered amount. For the CA/AT/NS key, program upper limit entry for total cash amount which can be handled on the register. The entry digit limit is in effect for REG mode operation but can be overridden in the MGR mode. The entry digit limit is represented by the number of allowable digits for the maximum entry or total amount. When “0” is set, the operation of the corresponding key is prohibited.

### Key operation example



### Print

```

*PGM*
F45 CHECK
00000000018
  
```

ABC (A:0, B:1, C:8)



## 4 Text Programming

The register allows you to program the text for clerk names, department item names, PLU/subdepartment item names, and so on, if necessary. There are two ways for programming text: using character keys on the keyboard or entering character codes with numeric keys on the keyboard.

### Using character keys on the keyboard

You can enter characters according to the small figures printed in the lower right position of the key tops. For the layout, please refer to "Keyboard" section on page 5.

The following are used as control keys for character entry:

- SHIFT** Toggles between upper-case and lower-case letters. By default, the upper-case letter is selected. Once the **SHIFT** key is pressed, you are locked in for entering lower-case letters. “\_” lights up at the SHIFT position of the display when lower-case letters entry is selected.
- NUMBER** Press the **NUMBER** key to enter numeric characters. For example to enter “1”, press the **NUMBER** and **1** key. If you press the **1** key without pressing the **NUMBER** key, the cash register goes to character codes entry mode. Once the **NUMBER** key is pressed, you are locked in for entering numeric characters. “\_” lights up at the NUMBER position of the display when numeric characters entry is selected.
- DC** Toggles between single-size and double-size characters. By default, the single-size character is selected. Once the **DC** key is pressed, you are locked in for entering double size characters. “\_” lights up at the DC position of the display when double-size characters entry is selected.
- BS** Backs up the cursor, erasing the character to the left.

**Example** To program the word “Clerk01” with the letter “C” being double size.

To make the letter “C” double size character	<b>DC</b> <b>C</b>
To make character size return to normal size	<b>DC</b>
To toggle the characters to lower-case letters	<b>SHIFT</b>
	<b>L</b> <b>E</b> <b>R</b> <b>K</b>
To enter numbers	<b>NUMBER</b> <b>0</b> <b>1</b>

### Entering character codes with numeric keys on the keyboard

Numerals, letters and symbols are programmable by entering the character code and the **00** key. (If numeric characters entry is selected, that is, “\_” lights up at the NUMBER position of the display, press the **NUMBER** key to release it.) Set the alphanumeric character code table on the next page. By doing this, you can program characters other than those on the key tops.

- Double-size characters can be made by entering the character code 253.
- All three digits of the character code **MUST** be entered (even if it starts with zero).

**Example** To program the word “SHARP” in double-size characters

253 **00** 083 **00** 072 **00** 065 **00** 082 **00** 080 **00**

S
H
A
R
P

When you press an appropriate number key (job code number) and press the **0** key for text entry just after you start programming with the **#/TM/SBTL** key, the cash register will be automatically ready for text entry.

Listed below is an overview of what you can program and the allowable number of single sized characters for each text entry.

- Department text 12 characters
- PLU text (item label) 12 characters
- Function text 8 characters
- Logo message 6 lines and 24 characters for each line
- Clerk name 8 characters
- Foreign currency symbol 4 characters

## Alphanumeric character code table

Code	Character	Code	Character	Code	Character	Code	Character	Code	Character
001	á	046	.	091	Ä	136	→	193	ı
002	â	047	/	092	Ö	137	ƒ	194	Ġ
003	ê	048	0	093	Ü	138	ℳ	195	Ş
004	î	049	1	094	^	139	◀	196	Ğ
005	ì	050	2	095	_	140	▶	197	ğ
006	í	051	3	096	'	141	F	198	Ƙ
007	ô	052	4	097	a	142	T	199	ƙ
008	ó	053	5	098	b	143	↓	200	ƚ
009	û	054	6	099	c	144	ç	201	ƚ
010	ú	055	7	100	d	145	°	202	ž
011	œ	056	8	101	e	146	ı	203	Đ
012	ů	057	9	102	f	147	ù	204	đ
013	ú	058	:	103	g	148	à	205	Č
014	ř	059	;	104	h	149	Æ	206	č
015	ó	060	<	105	i	150	ø	207	€
016	Λ	061	=	106	j	151	Å	208	Ɔ
017	Ψ	062	>	107	k	152	◻	209	˘
018	Γ	063	?	108	l	153	é	210	ě
019	˙	064	@	109	m	154	è	211	š
020	Ω	065	A	110	n	155	Pt	212	č
021	Δ	066	B	111	o	156	i	213	ž
022	Θ	067	C	112	p	157	Ñ	214	ý
023	Ξ	068	D	113	q	158	ò	215	ù
024	Π	069	E	114	r	159	£	216	ň
025	Σ	070	F	115	s	160	¥	217	˘
026	Υ	071	G	116	t	161	◦	218	˘
027	Φ	072	H	117	u	162	Γ	219	ř
028	Ú	073	I	118	v	163	J	224	*
029	Ú	074	J	119	w	164	˘	225	§
030	Ö	075	K	120	x	165	.	226	Ø
031	Ó	076	L	121	y	177	Á	227	˘
032	(space)	077	M	122	z	178	Í	228	↑
033	!	078	N	123	{	180	Ā	229	]
034	"	079	O	124		181	ā	230	[
035	#	080	P	125	}	182	Ē	231	"
036	\$	081	Q	126	β	183	ē	232	ä
037	%	082	R	127	¢	184	Ī	233	ö
038	&	083	S	128	!!	185	ī	234	ü
039	'	084	T	129	₁	186	Ū	235	æ
040	(	085	U	130	₂	187	ū	236	â
041	)	086	V	131	₃	188	Ŋ	237	É
042	*	087	W	132	₄	189	ŋ	238	ñ
043	+	088	X	133	1/2	190	Č	253	*(DC)
044	,	089	Y	134	Fₜ	191	Š		
045	-	090	Z	135	←	192	Č		

\*(DC): Double-size character code

 : The shaded character cannot be displayed (displayed as space).

**Note** The character "!!" (code 128) cannot be displayed (displayed as "!").

## ■ Department text

### Procedure

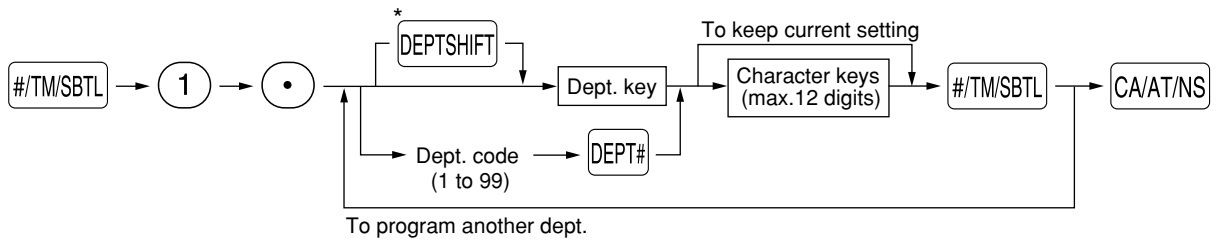

\*To program departments 17 through 32, press the department shift key.

### Key operation example

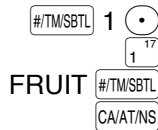

(Programming FRUIT for dept.1)

### Print

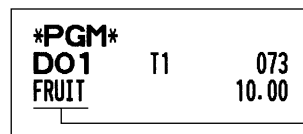

Text programmed for dept. 1

## ■ PLU text (item label)

### Procedure

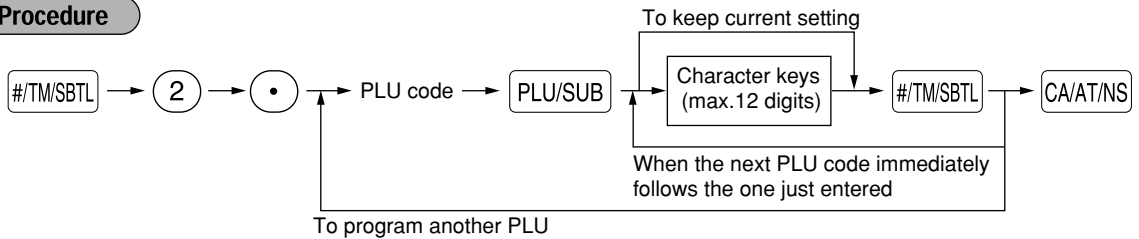

### Key operation example

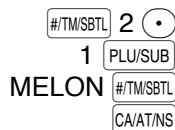

(Programming MELON to PLU1)

### Print

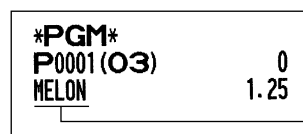

Text programmed for PLU code 1

## ■ Function text

### Procedure

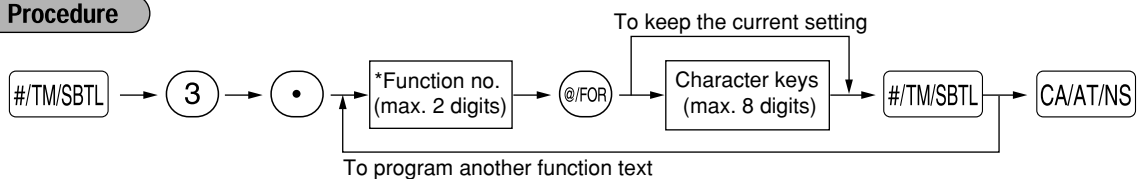

\* Function no.: See "List of function texts" shown on the following page.

### Key operation example

#/TMSBTL 3 0  
 46 @/FOR  
 CARD #/TMSBTL  
 CA/AT/NS

(Programming CARD for gross charge)

### Print

\*PGM\*  
 F46 CARD  
 000000000008

## List of function texts

Function no.	Key or function	Default setting	Function no.	Key or function	Default setting
1	⊖	(-)	36	Void mode	<b>VOID</b>
2	%1	<b>%1</b>	37	Manager void	MGR VD
3	%2	<b>%2</b>	38	Subtotal void	SBTL VD
4	Net sales total	<b>NET1</b>	39	No sale	NO SALE
5	Net taxable 1 subtotal	TAX1 ST	40	RA	<b>***RA</b>
6	Gross tax 1 total	GRS TAX1	41	PO	<b>***PO</b>
7	Tax 1 total of refund entries	RFD TAX1	42	Customer counter	TRANS CT
8	Net tax 1 total	TAX1	43	Sales total	<b>NET 3</b>
9	Exempt tax 1	TX1 EXPT	44	Cash	<b>CASH</b>
10	Net taxable 2 subtotal	TAX2 ST	45	Check	CHECK
11	Gross tax 2 total	GRS TAX2	46	Gross charge	CHARGE
12	Tax 2 total of refund entries	RFD TAX2	47	Refund charge	CHARGE-
13	Net tax 2 total	TAX2	48	Currency conversion1 (Preset)	CONV 1
14	Exempt tax 2	TX2 EXPT	49	Currency conversion2 (Open)	CONV 2
15	Net taxable 3 subtotal	TAX3 ST	50	Cash in drawer	<b>*** CID</b>
16	Gross tax 3 total	GRS TAX3	51	Cash+check in drawer	CA+CH ID
17	Tax 3 total of refund entries	RFD TAX3	52	Check change	CHK/CG
18	Net tax 3 total	TAX3	53	Exempt VAT	VAT EXPT
19	Exempt tax 3	TX3 EXPT	54	(+)Dept. total	*DEPT TL
20	Net taxable 4 subtotal	TAX4 ST	55	(-)Dept. total	DEPT(-)
21	Gross tax 4 total	GRS TAX4	56	Subtotal	SUBTOTAL
22	Tax 4 total of refund entries	RFD TAX4	57	Merchandise subtotal	MDSE ST
23	Net tax 4 total	TAX4	58	Total	<b>*** TOTAL</b>
24	Exempt tax 4	TX4 EXPT	59	Change	CHANGE
25	Gross manual tax total	GRS MTAX	60	Items	ITEMS
26	Refund manual tax total	RFD MTAX	61	Department report title	<b>DEPT</b>
27	Net manual tax total	M-TAX	62	PLU report title	<b>PLU</b>
* 28	Exempt total from GST	GST EXPT	63	Transaction report title	TRANS.
* 29	PST total	PST TTL	64	Clerk report title	CLERK
* 30	GST total	GST TTL	65	Hourly report title	HOURLY
31	Tax total	TTL TAX	66	Non add symbol	#
32	Net	<b>NET</b>	67	Copy receipt title	<b>COPY</b>
33	Sales total including tax total	<b>NET2</b>	68	EJ report title	<b>EJ</b>
34	Refund	REFUND	69	EJ report end title	<b>EJ END</b>
35	Item void	VOID			

### Note

- The items marked with “ \* ” are for Canada only.
- The function no. 53 “Exempt VAT” is only effective for the Canadian tax system (2 GST, VAT type).

## ■ Clerk names

### Procedure

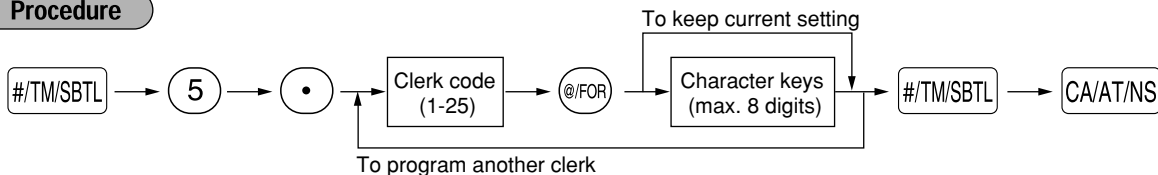

### Key operation example



### Print

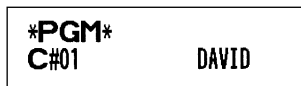

## ■ Logo messages

The register can print programmed messages on every receipt. On the standard model, the graphic logo is printed on the receipt. If you want to print logo messages, please change the logo message print format. (See page 51 for the programming details.) The options are listed below:

### Procedure

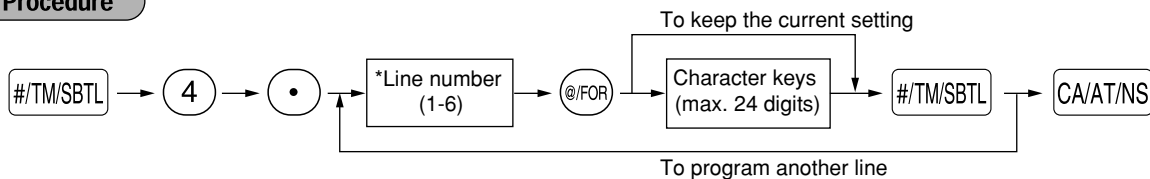

- \* "Header 3-line message" type: 1 to 3
- "Footer 3-line message" type : 4 to 6
- "Header 6-line message" type: 1 to 6
- "Header 3-line and footer 3-line message" type: 1 to 6 (1 to 3 as header, 4 to 6 as footer)

### Logo print format (6 types)

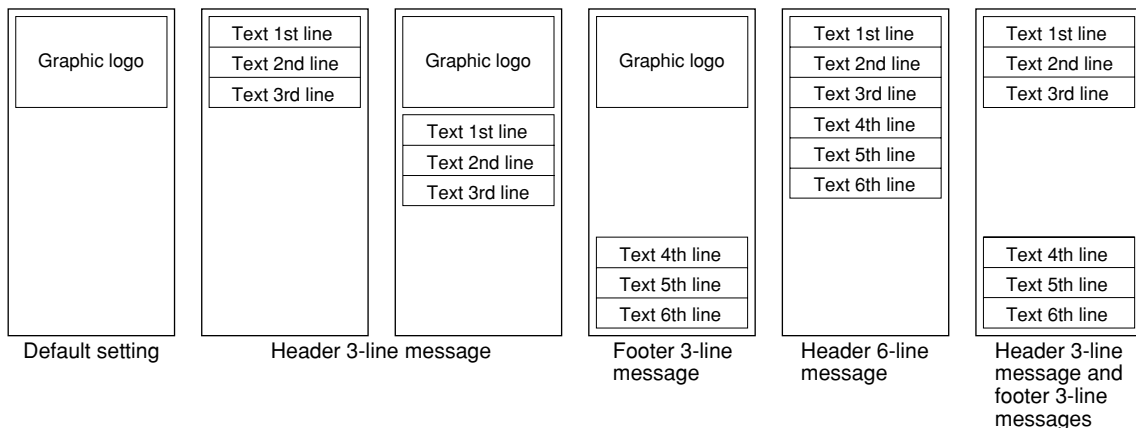

To print the logo message “THANK YOU” using double sized characters and centering on the third line.

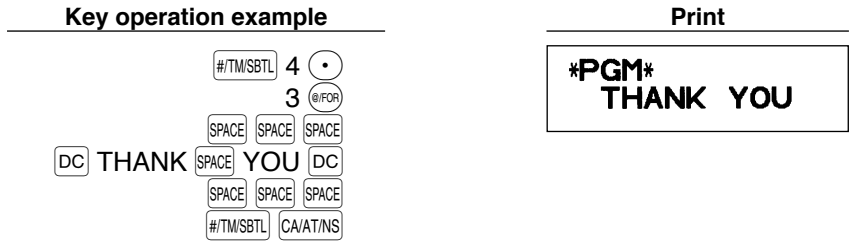

**Note** A 6-line logo message is preprogrammed when shipped. Please start entering from the first line when you first program a logo message.

## Foreign currency symbol

Foreign currency symbol for **CONV** key is printed with a foreign currency exchange amount.

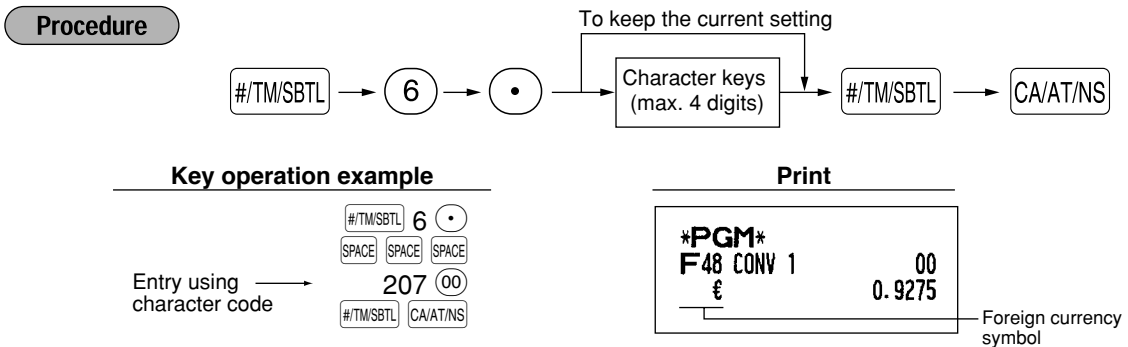

# ADVANCED PROGRAMMING

## 1 Register Number and Consecutive Number Programming

The register number and consecutive numbers are printed on every receipt or journal. When your store has two or more registers, it is practical to set separate register numbers for their identification. The consecutive number is increased by one each time a receipt is issued or when a journal print occurs. For consecutive number programming, enter a number (max. 4 digits) that is one less than the desired starting number.

### Register number

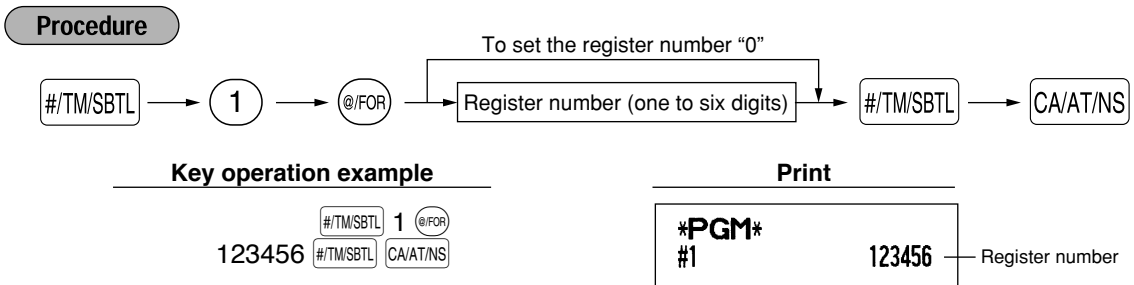

## ■ Consecutive numbers

### Procedure

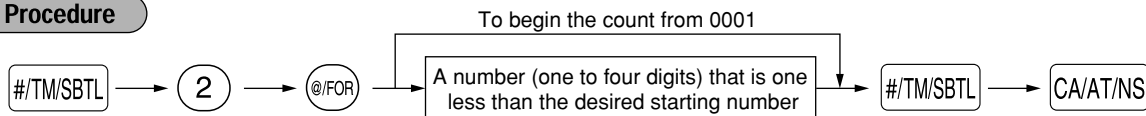

### Key operation example



### Print

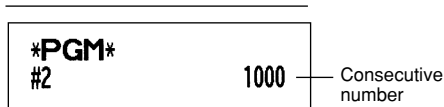

## 2 Electronic Journal (EJ) Programming

The cash register provides the electronic journal (EJ) function. By default, a maximum of 2000 lines can be stored in memory. If you want to store more journal data, you can expand to a maximum of 3000 lines, although the maximum number of PLUs is decreased to 200 codes because the memory is shared with PLU settings.

You can also program various options for EJ, such as availability of EJ memory nearly full warning, availability of printing EJ data during a transaction, data type to be stored in memory, and printing format.

For reading journal data, refer to “EJ REPORT READING AND RESETTING” (page 60).

## ■ EJ memory type

### Caution

*When this procedure is executed, EJ data is cleared, and PLU data (programming data and sales data) are reset to the default after all data is cleared even if the same memory type is selected.*

### Procedure

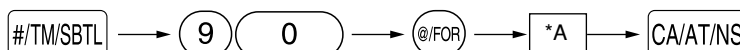

\*A: 0 for EJ 2000 lines and PLU 1200 codes (default)  
1 for EJ 3000 lines and PLU 200 codes

### Key operation example



### Print

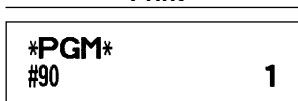

## ■ Function parameters for EJ

### Procedure

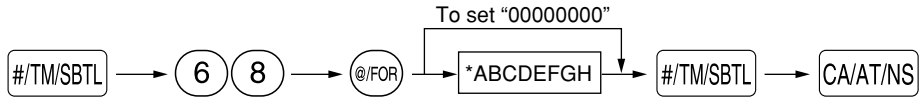

* Item:	Selection:	Entry:
<b>A</b> Always enter 0.	(Fixed position)	0
<b>B</b> Always enter 0.	(Fixed position)	0
<b>C</b> Temporary EJ printing during a transaction	Disallow	0
	Allow*	1
<b>D</b> EJ printing and clearing EJ data when issuing general Z1 report	No*	0
	Yes	1
<b>E</b> PGM mode operation records type	Details*	0
	Header information only	1
<b>F</b> REG/MGR/VOID modes operation records type	Details*	0
	Total	1
<b>G</b> Compressing printing for EJ data	No (normal size)	0
	Yes (small size)*	1
<b>H</b> Action when EJ memory area is full	Continue	0
	Warning (near full warning)*	1
	Lock (with near full warning)	2

On the default setting, an asterisk is marked.

### Temporary EJ printing during a transaction

- If selecting “yes”, you can print journal data of a current transaction recorded in EJ memory by pressing the **RCPT/PO** key during the transaction. To realize this function completely, the cash register is programmed to receipt printing and set Receipt ON/OFF function to OFF.

### PGM mode operation records type

- The header information only is printed during the program reading operation. The header information only is printed for X/Z reports. (Receipt sample for Header Information only)

```

04/26/2006  2:36PM  01
123456#1006  CLERK01
**X1**
**DEPT**
**TRANS.**
  
```

### Action when EJ memory area is full

- By default, when the memory for EJ becomes nearly full, the cash register shows decimal points at the 8th and 9th positions of the display (EJ memory nearly full message), and the cash register keeps storing new data while erasing the oldest data. When “0” is selected, the cash register will no longer show EJ memory nearly full message. When “2” is selected, the cash register shows EJ memory nearly full message and when the memory is totally full, the cash register locks the sales/data entry with a display of the memory full message “E-E”. You will only be able to issue an EJ report.

#### Key operation example

```

#/TM/SBTL 68 @/FOR
00100002 #/TM/SBTL CA/AT/NS
  
```

#### Print

```

*PGM*
#68 00100002
  
```



### 3 Various Function Selection Programming 1

The cash register provides various detailed functions listed below.

- Function selection for miscellaneous keys
- Print format
- Receipt print format
- Function selection for tax
- Others

For this programming, job code entry style is applied. You can continue programming until you press the **CA/AT/NS** key for the programming described in this section. To continue programming, repeat from a job code entry.

**Procedure**

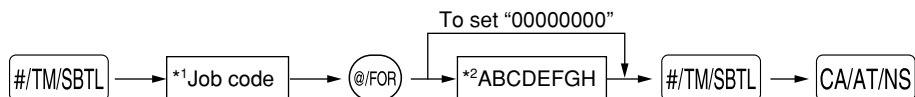

\*1 Enter job code using numeric keys specified in each section below.

\*2 Data entry details are listed on each table in each section below.

Example: When programming for job code 5 as ABCDEFGH: 00000100.

**Key operation example**



**Print**

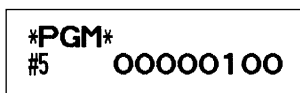

### Function selection for miscellaneous keys

Job code: 5

* Item:	Selection:	Entry:
<b>A</b> PO in REG mode	Allow the PO operation in REG mode*	0
	Disallow it	1
<b>B</b> RA in REG mode	Allow the RA operation in REG mode*	0
	Disallow it	1
<b>C</b> Subtotal void in REG mode	Allow the REG mode subtotal void*	0
	Disallow it	1
<b>D</b> Indirect void in REG mode	Allow the REG mode indirect void*	0
	Disallow it	1
<b>E</b> Direct void in REG mode	Allow the REG mode direct void*	0
	Disallow it	1
<b>F</b> Refund key availability	Allow the REG mode refund entry*	0
	Disallow it	1
<b>G</b> No sale in REG mode	Allow the no sale operation in REG mode*	0
	Disallow it	1
<b>H</b> Fractional quantity availability	Allow fractional quantity entry	0
	Disallow it*	1

## ■ Print format

Job code: 6

* Item:	Selection:	Entry:	
A	Printing style	Use the printer for journal printing	0
		Use the printer for receipt printing*	1
B	Receipt print format	Total	0
		Detailed*	1
C	Time print on all receipts/journals	Allow time printing*	0
		Disallow it	1
D	Date print on all receipts/journals	Allow date printing*	0
		Disallow it	1
E	Consecutive no. print on all receipts/journals	Allow consecutive no. printing*	0
		Disallow it	1
F	Always enter 0.	(Fixed position)	0
G	Zero skip for PLU report	Disallow zero skip	0
		Allow zero skip*	1
H	Zero skip for general, clerk and hourly reports	Disallow zero skip	0
		Allow zero skip*	1

### Printing style

- Even when receipt printing is selected, the journal rewind motor will be driven in PGM, OP X/Z, X1/Z1 and X2/Z2 modes so you can wind sales and programming reports.

## ■ Receipt print format

Job code: 7

* Item:	Selection:	Entry:	
A	Always enter 0.	(Fixed position)	0
B	Always enter 0.	(Fixed position)	0
C	Subtotal print with a press of subtotal key	Disallow subtotal printing*	0
		Allow it	1
D	Merchandise print with a press of merchandise subtotal key	Disallow merchandise subtotal printing*	0
		Allow it	1
E	Always enter 0.	(Fixed position)	0
F	Always enter 0.	(Fixed position)	0
G	Always enter 0.	(Fixed position)	0
H	Number of purchases print	Allow printing of number of purchases*	0
		Disallow it	1

## ■ Function selection for tax

Job code: 15

* Item:	Selection:	Entry:	
A to F	Always enter 0.	(Fixed position)	0
G	Tax delete in REG mode availability	Allow tax delete in REG mode*	0
		Disallow it	1
H	Manual tax entry in REG mode availability	Allow manual tax entry in REG mode*	0
		Disallow it	1

## ■ Other programming

### Job code: 61

* Item:	Selection:	Entry:
<b>A</b> Always enter 0.	(Fixed position)	0
<b>B</b> Always enter 0.	(Fixed position)	0
<b>C</b> Minus dept. and PLU/subdept. availability	Disallow to program minus dept. and PLU/subdept.	0
	Allow it*	1
<b>D</b> Fractional treatment	Round off (4 down, 5 up)*	0
	Raising to unit	1
	Disregarding fractional treatment	2
<b>E</b> Use of (00) key	Use (00) key as 00 key*	0
	Use (00) key as 000 key	1
<b>F</b> Time format	Use 12-hour format*	0
	Use 24-hour format	1
<b>G</b> Date format	Use month-day-year format*	0
	Use day-month-year format	1
	Use year-month-day format	2
<b>H</b> Position of decimal point (from right) (TAB)		0 to 3 (default 2)

### Job code: 62

* Item:	Selection:	Entry:
<b>A</b> Always enter 0.	(Fixed position)	0
<b>B</b> Error beep activation	By lock error*	0
	By misoperation	1
<b>C</b> Key touch sound availability	Allow to sound*	0
	Disallow it	1
<b>D</b> Buffered keyboard	Yes*	0
	No	1
<b>E</b> Void mode operation availability	Allow void mode operation*	0
	Disallow it	1
<b>F</b> Void mode entry data print in Z2 reports	Allow printing of void mode entry data in Z2 reports*	0
	Disallow it	1
<b>G</b> Void mode entry data print in Z1 reports	Allow printing of void mode entry data in Z1 reports*	0
	Disallow it	1
<b>H</b> Addition of hourly sales total data in void mode	No*	0
	Yes	1

### Job code: 66

* Item:	Selection:	Entry:
<b>A</b> Printing a receipt after transaction	Total only	0
	Details*	1
<b>B</b> Amount printing when PLU/subdept. unit price is zero	Disallow printing*	0
	Allow it	1
<b>C</b> Subtotal printing for conversion of deficit	Allow printing*	0
	Disallow it	1
<b>D</b> Always enter 0.	(Fixed position)	0
<b>E</b> Compression printing on journals in PGM, OP X/Z, X1/Z1 and X2/Z2 modes	Disallow compression printing (normal size)	0
	Allow compression printing (small size)*	1
<b>F</b> Compression printing on journals in REG, MGR and VOID modes	Disallow compression printing (normal size)	0
	Allow compression printing (small size)*	1
<b>G</b> Logo message printing on journals	Disallow logo message printing on journals*	0
	Allow logo message printing on journals	1
<b>H</b> Footer printing	Printing footer on all receipts*	0
	Printing footer with selected function key at the time of finalization	1

### Compression printing

- This programming is valid only when journal printing is selected. This does not affect EJ printing. (For EJ programming, please refer to page 46.)

Job code: 70

* Item:		Selection:	Entry:
A	Split pricing counting	Quantity*	0
		Package	1
B	Multiplication/split pricing entry availability	Allow multiplication entry only*	0
		Allow both of multiplication and split pricing	1
C	Always enter 0.	(Fixed position)	0
D	Always enter 0.	(Fixed position)	0
E	Tax printing when GST is VAT	Allow tax printing*	0
		Disallow it	1
F	GST exempt printing on X/Z reports	Allow printing of GST exempt*	0
		Disallow it	1
GH	Tax calculation system	Auto tax*	00
		Canadian tax (tax type number)	01 through 11

**Tax calculation system**

- For US tax system, select “auto-tax”.
- For Canadian tax, from the table below, specify a tax system suitable for your province (if necessary contact your local tax office for correct sales tax information) and for your type of retail business. In the cash register, four kinds of tax can be set and each tax is arranged to match GST or PST as follows:

Tax 1: PST                      Tax 2: PST  
 Tax 3: PST or GST          Tax 4: GST

Canadian tax type number	Tax 4 method	Tax 3 method		Tax 2 and 1 method
	GST	GST	PST	PST
01	VAT	VAT	-	Tax on tax
02	VAT	VAT	-	Tax on base
03	VAT	-	Tax on tax	Tax on tax
04	VAT	-	Tax on base	Tax on base
05	Add on Tax	-	Tax on tax	Tax on Tax
06	Add on Tax	-	Tax on base	Tax on base
07	Add on Tax	VAT	-	Tax on tax
08	Add on Tax	VAT	-	Tax on base
09	Add on Tax	Add on Tax	-	Tax on tax
10	Add on Tax	Add on Tax	-	Tax on base
11	VAT	-	VAT (Tax on base)	Tax on tax

(The most common type for Canada is type number 06.)

**Note**

- To program a GST, use Tax 4; and to program two GSTs, use Tax 3 and 4. To program a PST, use Tax 1; to program two PSTs, use Tax 1 and 2; and to program three PSTs, use Tax 1, 2 and 3.
- The entry of a multi-taxable item for PST or GST is prohibited as follows for the Canadian tax system. When programming for departments, avoid programming the prohibited multi-taxable status.

In case of; Tax 1: PST, Tax 2: PST,  
 Tax 3: PST, Tax 4: GST  
 Taxable 1 and 2 item ..... prohibited  
 Taxable 1 and 3 item ..... prohibited  
 Taxable 2 and 3 item ..... prohibited  
 Taxable 1 and 4 item ..... allowed  
 Taxable 2 and 4 item ..... allowed  
 Taxable 3 and 4 item ..... allowed

In case of; Tax 1: PST, Tax 2: PST,  
 Tax 3: GST, Tax 4: GST  
 Taxable 1 and 2 item ..... prohibited  
 Taxable 1 and 3 item ..... allowed  
 Taxable 2 and 3 item ..... allowed  
 Taxable 1 and 4 item ..... allowed  
 Taxable 2 and 4 item ..... allowed  
 Taxable 3 and 4 item ..... prohibited

## 4 Various Function Selection Programming 2

The cash register provides various options so you can use the register to suit your sales needs.

In this section, you can program the following features (parameters within parentheses indicates default setting):

- Power save mode (entering the power save mode in 30 minutes)
- Logo message print format (graphic logo only)
- Thermal printer density (standard density)
- RS-232C interface
- Language selection (English)
- Training clerk specification (none) - If you specify a clerk code who is trained for use on this cash register, the cash register will go into training mode when the clerk code is registered for sales entries. The sales operations done by the trained clerk does not affect sales total. For details, refer to TRAINING MODE section.

### ■ Power save mode

#### Procedure

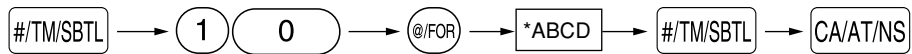

* Item:	Selection:	Entry:
<b>A</b> Entering power save mode when time is displayed	Yes*	0
	No	1
<b>B-D</b> Time(min.) to entering power save mode since no operation is made		001-254 or 999 (Default 030)

#### Note

When 999 is set for B to D, entering into power save mode is inhibited.

#### Key operation example



#### Print

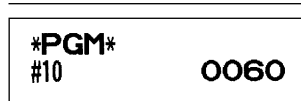

### ■ Logo message print format

You can select the number of lines for your logo message, and the position to print it on receipt or journal.

#### Procedure

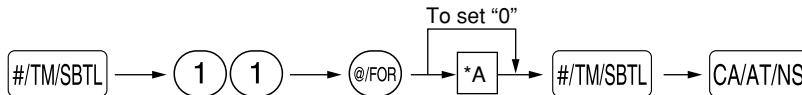

- \*A: Logo message type
- 0: Header 3-line message without graphic logo
  - 1: Graphic logo only (default)
  - 2: Footer 3-line message with graphic logo
  - 3: Header 6-line message
  - 4: Header 3-line message with graphic logo
  - 5: Header 3-line message and footer 3-line message

#### Key operation example



#### Print

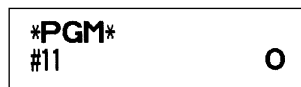

## ■ RS-232C interface

### (1) RS-232C terminal number

#### Procedure

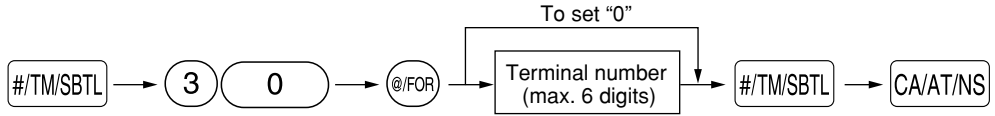

Default: 1

### (2) RS-232C transmission form

#### Procedure

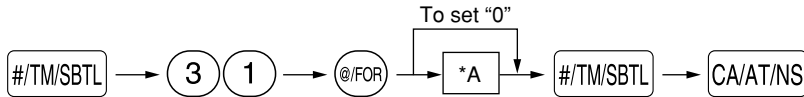

* Item:	Selection:	Entry:
A Transmission line form	Half duplex system	1
	Full duplex system*	0

### (3) RS-232C baud rate

#### Procedure

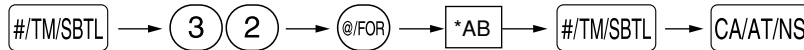

* Item:	Selection:	Entry:
A Always enter 0.		0
B Baud rate (bps)	2400	3
	4800	4
	9600*	5
	19200	6

### (4) RS-232C start code and end code

#### Procedure

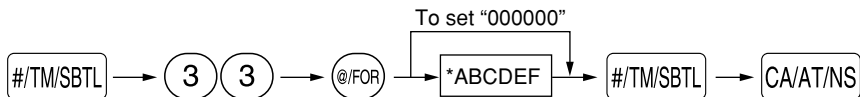

\*A-C: Start code 000-127 (default: 002)

D-F: End code 000-127 (default: 013)

### (5) RS-232C time out setting

#### Procedure

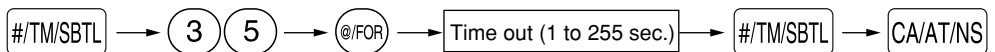

Default: 007

#### Key operation example



#### Print

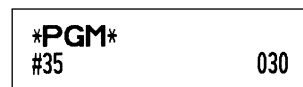

## Thermal printer density

### Procedure

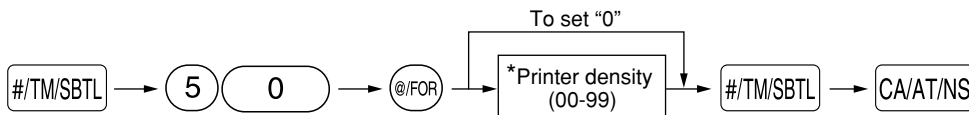

\* 50 is the default setting. To make the print darker, set a larger number, and to make the print lighter, set a smaller number.

### Key operation example

#/TM/SBTL 50 @/FOR  
00 #/TM/SBTL CA/AT/NS

### Print

```
*PGM*
#50      00
```

## Language selection

### Procedure

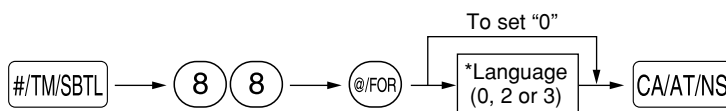

\*Language: 0: English    2: French    3: Spanish (default: English)

### Key operation example

#/TM/SBTL 88 @/FOR  
2 CA/AT/NS

### Print

```
*PGM*
#88      2
```

### Caution

When you change the language, the texts such as clerk names, logo messages and function texts (refer to page 42), which you programmed, will be reset to the default settings. The language selection must be made before programming clerk names, logo messages and function texts.

## Training clerk specification for training mode

For the details of clerk training, please refer to "TRAINING MODE" on page 56.

### Procedure

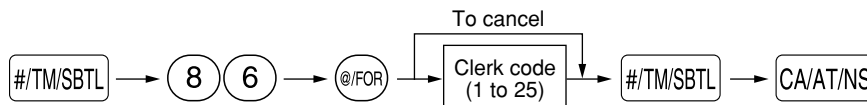

### Key operation example

#/TM/SBTL 86 @/FOR  
25 #/TM/SBTL CA/AT/NS

### Print

```
*PGM*
#86      25
```

## ■ AUTO key programming — Automatic sequence key —

If you program frequently performed transactions or report sequences for the **AUTO** key, you can recall those transactions and/or reports simply by pressing the **AUTO** key in key operations.

### Procedure

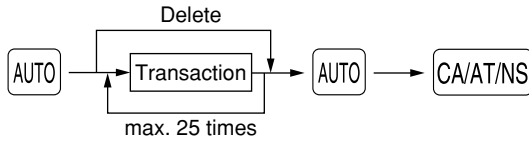

Programming for **AUTO**; entering a PLU 2 item (programmed unit price: 1.50) and a dept. 6 item (unit price: 1.00)

### Key operation example

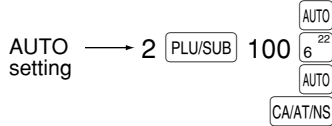

### Print

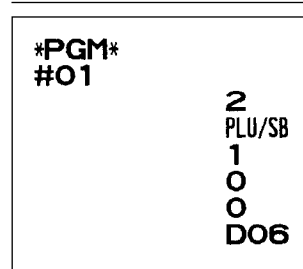

### Note

When the **AUTO** key has been programmed to execute a report job function, the mode switch must be in the appropriate position (OPX/Z for individual clerk reports, X1/Z1 for daily reports or X2/Z2 for weekly or monthly reports).

## 5 Reading Stored Programs

The machine allows you to read every program stored in the PGM mode.

### ■ Key sequence for reading stored program

Report name	Key sequence
Programming report 1	CA/AT/NS
Programming report 2	2 → CA/AT/NS
Auto key programming report	1 → CA/AT/NS
Printer density programming report	3 → CA/AT/NS
PLU programming report	Start PLU code → @/FOR → End PLU code → PLU/SUB

### Note

- To stop reading programming report 1 or PLU programming report, turn the mode switch to the MGR position.
- When printing is performed continuously, the printing may be intermitted several seconds. After the intermission, the printing will be restarted.



# Sample printouts

## 1 Programming report 1

*PGM*			Mode <input type="checkbox"/>
D01	T1	073	Dept. code <input type="checkbox"/>
FRUIT		10.00	Dept. text
D02	T1	173	Dept. unit price w/sign
DEPT. 02		-13.10	Dept. function
D03	T1	071	Minus department
DEPT. 03		0.00	Tax status
D99		071	Function no. & its text
DEPT. 99		0.00	Tax status
F01 (-)		006	Function paramtrs (F-H)
	T1	-2.00	Discount amt. w/sign
F02 %1		000	Function paramtrs (F-H)
L 15.00%		-15.25%	Percent rate with sign
F03 %2		000	<input type="checkbox"/>
L 100.00%		-0.00%	Percent limit
F04 NET 1			
F05 TAX1 ST			
F26 RFD MTAX			
F27 M-TAX	7		Entry digit limit
F28 GST EXPT			
F39 NO SALE			
F40 ***RA	9		Entry digit limit
F41 ***PO	4		Entry digit limit
F42 TRANS CT			
F43 NET 3			
F44 CASH			
F45 CHECK	000000000008		
F46 CHARGE	000000000018		Function parameters (A-C)
F47 CHARGE-	000000000008		
F48 CONV 1	00		Function parameters
€	0.9275		Foreign currency <input type="checkbox"/> symbol/Rate
F49 CONV 2			
F50 ***CID			

F68 EJ			
F69 EJ END			
SHARP			Logo Message
PRESENTS THE			
SHARP			
IS			
THE BEST			
#5	00000100		Function selection for <input type="checkbox"/> miscellaneous keys (A-H)
#6	11000011		Print format (A-H) <input type="checkbox"/>
#7	00000000		Receipt print format(A-H) <input type="checkbox"/>
#10	0060		Power save mode(A-D) <input type="checkbox"/>
#11	0		Logo message print format <input type="checkbox"/>
#15	00000000		Function selection for tax (A-H)
#19	00		Doughnut tax exempt
#30	000002		RS-232C terminal no.
#31	0		RS-232C transmission form (A) <input type="checkbox"/>
#32	05		RS-232C baud rate(AB) <input type="checkbox"/>
#33	002 013		RS-232C Start-End code <input type="checkbox"/>
#35	007		RS-232C timeout
#40	0		
#41	00000000		
#42	000000		
#43	030		
#44	099		
#45	0099		
#50	99		Thermal printer density
T1	6.0000%		Tax table
	/ 1.00		
1	0.11		
2	0.23		
3	0.39		
4	0.57		
5	0.73		
6	0.89		
7	1.11		
T2	4.0000%		Tax rate
T3	0.12		Min. taxable amount
T4	-----		
C#01	DAVID		Clerk code/name
C#02	CLERK02		
C#24	CLERK24		
C#25	CLERK25		

## 2 Programming report 2

<b>*PGM*</b>	
#61	00100002
#62	00000000
#63	01000001
#64	00000000
#65	00000000
#66	10001100
#67	00000000
#68	00100002
#69	00100000
#70	00000000
#71	
GT2	\$000000000000.00
#72	
GT3	\$000000000000.00
#76	21 0000
#77	22 0000
#85	\$
#86	25
#87	TRAINING
#88	0
#90	1
#95	99

Job code

A to H from the left

\* Job code #63, 64, 65, 67, 69, 71, 72, 76, 77, 85, 87 and 95 are fixed settings, for which you cannot change the settings.

Training clerk specification

Language selection

EJ memory type

## 3 Auto key programming report

<b>*PGM*</b>	
<b>#01</b>	
	2
	PLU/SB
	1
	0
	0
	DO6

## 4 Printer density programming report

<b>*PGM*</b>	
#50	50
10	: 0123456789AB
20	: 0123456789AB
30	: 0123456789AB
40	: 0123456789AB
50	: 0123456789AB
60	: 0123456789AB
70	: 0123456789AB
80	: 0123456789AB
90	: 0123456789AB

Entered Value

Printer density

Printing density example

## 5 PLU programming report

<b>*PGM*</b>	
	0001-0015
PLU code	P0001(O3)
PLU text	MELON
	1.25
	P0002(O1)
	PLU0002
	1.25
	P0003(32)
	PLU0003
	-0.15
	PLU0014
	0.00
	P0015(O1)
	PLU0015
	0.00

Range

Mode parameter

Unit price

Associated dept. code

# TRAINING MODE





The training mode is used when the operator or the manager practices register operations.

When a clerk in training is selected, the machine automatically enters the training mode. To specify a clerk to be trained, refer to "Training clerk specification for training mode" in "ADVANCED PROGRAMMING" in page 53.

The training operation is valid only in REG, MGR and VOID mode.

The corresponding clerk memory is only updated in the training mode.

### Key operation example

A clerk set in training → 25   
 1000   
 3   
  

### Print

04/26/2006	3:51PM	25
123456#1050	CLERK25	
<b>TRAINING</b>		
DEPT.05	T1	\$10.00
	3 @	\$24.00
DEPT.03	T1	\$72.00
MDSE ST		\$82.00
TAX1		\$5.13
ITEMS	40	
<b>CASH</b>		<b>\$87.13</b>

# READING (X) AND RESETTING (Z) OF SALES TOTALS

- Use the reading function (X) when you need to take a reading of sales information entered since the last reset. You can take this reading any number of times. It does not affect the register's memory.
- Use the resetting function (Z) when you need to clear the register's memory. Resetting prints all sales information and clears the entire memory except for the GT1 through GT3, Training GT, reset count, and consecutive number.

## 1 Summary of Reading (X) and Resetting (Z) Reports

X1 and Z1 reports: Daily sales reports

X2 and Z2 reports: Periodic (monthly) consolidation reports

When you take a X or Z report, turn the mode switch to the appropriate position referring to the column of "Mode switch position" shown on the table below, and use the following corresponding key sequence.

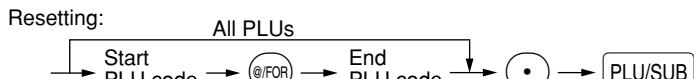
Item	Mode switch position			Key operation
	OPX/Z	X1/Z1	X2/Z2	
Flash report: (Only display) To clear the display, press the <b>CL</b> key or turn the mode switch to another position.	X	—	—	Dept. code → <b>DEPT#</b> : Department sales total [ For dept. 1 to 16; Dept. key ( <b>1</b> <sup>17</sup> to <b>16</b> <sup>32</sup> ) For dept. 17 to 32; <b>DEPTSHIFT</b> → Dept. key ( <b>1</b> <sup>17</sup> to <b>16</b> <sup>32</sup> ) ] <b>@/FOR</b> key: Amount of cash in drawer <b>CA/AT/NS</b> key: Sales total
Full sales report	—	X1, Z1	X2, Z2	Reading: <b>CA/AT/NS</b> Resetting: <b>•</b> → <b>CA/AT/NS</b>
Individual clerk report	X, Z	—	—	Reading: <b>CLK#</b> Resetting: <b>•</b> → <b>CLK#</b> (The report of the current clerk)
Full clerk report	—	X1, Z1	—	Reading: <b>CLK#</b> Resetting: <b>•</b> → <b>CLK#</b>
PLU sales report	—	X1, Z1	—	Reading:  Resetting: 
Hourly report	—	X1, Z1	—	Reading: <b>#/TM/SBTL</b> Resetting: <b>•</b> → <b>#/TM/SBTL</b>

- Note**
- When both sales quantities and sales amounts are zero, printing is skipped. If you do not want to skip, change the programming. (Refer to "Print format" of "Various Function Selection Programming 1".)
  - "X" represents read symbol and "Z" represents reset symbol in the reports.
  - To stop reading and resetting the PLU sales report, turn the mode switch to the MGR position. The data will not be erased when you reset.
  - When printing is performed continuously, the printing may be intermitted several seconds. After the intermission, the printing will be restarted.

## 2 Daily Sales Totals

### Full sales report

#### Sample report

*Z1*		Mode title*1
	Z1 0001	Reset counter
GT1	\$00000002489.99	Net grand total(GT2-GT3)
GT2	\$00000002644.05	Grand total of plus registration
GT3	-00000000154.06	Grand total of minus registration
TR	\$00000000076.50	Grand total of training mode registration
*DEPT*		Dept. code
DO1	70Q	Sales q'ty
FRUIT	\$317.17	Sales amount
DO3	14Q	
DEPT.03	\$221.00	
DO5	11Q	
DEPT.05	\$36.20	
DEPT.50	\$150.00	
D99	1Q	
DEPT.99	\$12.50	
*DEPT TL	276Q	"+" dept. counter and total
	\$2273.67	
DO2	7Q	
DEPT.02	\$164.00	
DEPT (-)	7Q	"-" dept. counter and total
	\$164.00	
* TRANS. *		
(-)	3Q	Subtotal⊖ counter and total
	-3.00	
%1	4Q	Subtotal percent 1 counter and total
	-4.72	
%2	1Q	
	\$1.88	
NET 1	\$2431.83	Next sales total
TAX1 ST	\$1536.20	Taxable 1 total
GRS TAX1	\$57.61	Gross tax 1 total
RFD TAX1	-1.86	Refund tax 1 total
TAX1	\$55.75	Net tax 1 total
TX1 EXPT	\$7.25	
TAX2 ST	\$35.15	
GRS TAX2	\$1.41	
TAX2	\$1.41	
M-TAX	\$1.00	Manual tax total
		--*3
TTL TAX	\$58.16	Tax total
NET	\$2431.83	Net total without tax
NET2	\$2489.99	Net total with tax
(-)	4Q	Item⊖ counter and total
	-6.50	
%1	6Q	Item percent 1 counter and total
	-1.80	
%2	5Q	
	\$2.62	
VOID	9Q	REG-mode void counter and total
	\$48.78	
SBTL VD	4Q	Subtotal void counter and total
	\$157.05	
NGR VD	2Q	Manager item void counter and total
	\$12.22	
VOID	1Q	Void-mode transaction counter and total
	\$12.22	
REFUND	17Q	Refund counter and total
	\$73.60	
***RA	1Q	Received on account counter and total
	\$48.00	
***PO	1Q	Paid out counter and total
	\$15.00	
NO SALE	5Q	No-sales counter
TRANS CT	88Q	Customer counter
NET3	\$2489.99	Sales total
CASH	79Q	Cash counter and total
	\$2223.59	
CHECK	2Q	Check sales counter and total
	\$20.15	
CHARGE	7Q	Charge sales counter and total
	\$259.53	
CHARGE-	1Q	Charge refund counter and total
	-10.63	
CONV 1	500.00	Foreign currency total (preset)
CONV 2	200.00	Foreign currency total (open)
****CID	\$1719.77	Cash in drawer
CA+CH ID	\$1739.92	Cash + check in drawer
CHK/CG	\$2.65	Change total for check tendering

\*1: When you take X1 report, "X1" is printed.

\*2: Printed in the Z1 report only.

\*3: When the Canadian tax system is selected, the following is printed here.

GST EXPT	\$292.11	Exempt total from GST
PST TTL	\$26.60	PST total
GST TTL	\$8.86	GST total

## ■ Clerk reports

### Individual clerk report

#### • Sample report

<b>*OPX*</b>		Mode title*
<b>* CLERK *</b>		Report title
<b>O1#</b>	<b>CLERK01</b>	Clerk code
<b>TRANS CT</b>	<b>87Q</b>	Clerk name
<b>NET3</b>	<b>\$2402.86</b>	Customer counter
<b>***CID</b>	<b>\$1632.64</b>	
<b>CA+CH ID</b>	<b>\$1652.79</b>	
<b>CHK/CG</b>	<b>\$2.65</b>	

### Full clerk report

The printout occurs in the same format as in the sample report of individual clerk, but all clerk's sales data are printed in the order of clerk's sales data (from #1 to #25).

## ■ Hourly report

#### • Sample report

<b>*X1*</b>		Mode title*
<b>* HOURLY *</b>		Report title
<b>10:00AM</b>	<b>12Q</b>	Customer counter
	<b>\$116.89</b>	Sales total
<b>11:00AM</b>	<b>18Q</b>	
	<b>\$183.75</b>	
<b>12:00PM</b>	<b>25Q</b>	
	<b>\$199.91</b>	
<b>5:00PM</b>	<b>18Q</b>	
	<b>\$134.63</b>	
<b>6:00PM</b>	<b>16Q</b>	
	<b>\$92.27</b>	

\*: When you take Z1 report, "Z1" is printed.

## ■ PLU sales report

#### • Sample report

<b>*X1*</b>		Mode title*
<b>* PLU *</b>		Report title
	<b>0001-0015</b>	Range
PLU code	<b>P0001</b>	<b>35Q</b>
Item label	<b>PLU0001</b>	<b>\$52.50</b>
	<b>P0002</b>	<b>24Q</b>
	<b>PLU0002</b>	<b>\$35.00</b>
	<b>P0010</b>	<b>9Q</b>
	<b>PLU0010</b>	<b>\$64.35</b>
	<b>P0011</b>	<b>10Q</b>
	<b>PLU0011</b>	<b>\$120.00</b>
	<b>P0012</b>	<b>1Q</b>
	<b>PLU0012</b>	<b>\$0.00</b>
	<b>P0013</b>	<b>-21Q</b>
	<b>PLU0013</b>	<b>-44.10</b>
	<b>P0015</b>	<b>1Q</b>
	<b>PLU0015</b>	<b>\$22.12</b>
	<b>***TOTAL</b>	<b>59Q</b>
		<b>\$249.87</b>

\*: When you take Z1 report, "Z1" is printed.

## 3 Periodic Consolidation

### ■ Full sales report

#### • Sample report

<b>*Z2*</b>		Mode title*1
	<b>Z1 0001</b>	Reset counter of daily total
	<b>Z2 0001</b>	Reset counter of periodic
<b>GT1</b>	<b>\$00000003457.54</b>	Grand total
<b>GT2</b>	<b>\$00000003621.60</b>	
<b>GT3</b>	<b>-00000000164.06</b>	
<b>TR</b>	<b>\$00000000076.50</b>	

The subsequent printouts are the same in format as in the X1/Z1 full sales report.

\*1: When you take X2 report, "X2" is printed.

\*2: Printed in the Z2 report only

↓

# EJ REPORT READING AND RESETTING

The cash register provides an electronic journal (EJ) function. This function is intended to record the journal data in a memory instead of journal paper, and print the data as an EJ report. The register records the journal data in REG, PGM, VOID, X1/Z1 and X2/Z2 modes. By default, a maximum of 2000 lines are stored in the memory, but you can expand it to 3000 lines. For details of EJ programming, please refer to "Electronic Journal Programming" section (page 45).

## ■ Printing journal data on the way of a transaction

You can print journal data of a current transaction recorded in EJ memory by pressing the **RCPT/PO** key during the transaction.

**Note** This function is valid when the printing style is programmed to receipt, and the receipt ON/OFF function is set to OFF.

### • Sample print

*EJ *	EJ report title
04/26/2006 2:31PM 01	
123456#1004 CLERK01	
DEPT. 03 T1 \$10.00	
DEPT. 04 T1 \$45.00	
*EJ END*	EJ report end title

## ■ Reading and resetting the electronic journal data (Issuing EJ report)

You can read the journal data stored in the EJ memory in the journal format by executing the following procedure in the X1/Z1 or OP X/Z mode.

To read all of the data:



To reset all of the data:

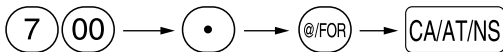

To read the last 10 records:

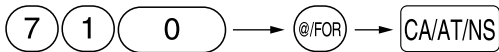

### ■ Note

- On the EJ memory, a maximum of 2000 (or 3000, if programmed) lines of data can be stored. When executing all data reading, all of the data stored in the EJ memory will be printed. To save paper, compression print is available.
- To stop reading or resetting the data, turn the mode switch to "MGR" position. The data will not be erased when resetting.
- When printing is performed continuously, the printing may be intermitted several seconds. After the intermission, the printing will be restarted.

### • Sample EJ report

*OPX*	
*EJ *	
04/26/2006 2:34PM 01	
123456#1006 CLERK01	
***P0	\$15.00
04/26/2006 2:35PM 01	
123456#1007 CLERK01	
DEPT. 99	\$12.50
ITEMS 10	
CHARGE	\$12.50
04/26/2006 2:36PM 01	
123456#1006 CLERK01	
*X1*	
*DEPT*	
* TRANS. *	
04/26/2006 2:39PM 01	
123456#1009 CLERK01	

} Header information print

MDSE ST	\$50.00
TAX1	\$3.13
ITEMS 40	
CASH	\$53.13
04/26/2006 2:41PM 01	
123456#1014 CLERK01	
DEPT. 03	T1 \$10.00
DEPT. 04	T1 \$45.00
MDSE ST	\$55.00
TAX1	\$3.44
ITEMS 20	
CASH	\$58.44
04/26/2006 2:41PM 01	
123456#1015 CLERK01	
NO SALE	
*EJ END*	

# OVERRIDE ENTRIES

Programmed limit for functions (such as for maximum amounts) can be overridden by making an entry in the MGR mode.

**Procedure**

1. Turn the mode switch to the MGR position.
2. Make an override entry.

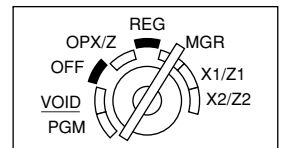

**Example**

On this example, the register has been programmed not to allow discounts entries over \$1.00.

**Key operation example**

REG-mode 1500 <sup>19</sup>  
 entries 250  ...Error  
 (CL)

Turn the mode switch to the MGR position.

250

Return the mode switch to the REG position.

**Print**

DEPT. 03	T1	\$15.00
(-)		-2.50
MDSE ST		\$12.50
TAX1		\$0.94
ITEMS	1Q	
<b>CASH</b>		<b>\$13.44</b>

# CORRECTION AFTER FINALIZING A TRANSACTION (Void mode)

When you need to void incorrect entries that clerks cannot correct (incorrect entries found after finalizing a transaction or cannot be corrected by direct or indirect void), follow this procedure:

1. Turn the mode switch to the VOID position using the manager key (MA), to enter into the void mode.
2. Repeat the entries that are recorded on an incorrect receipt. (All data for the incorrect receipt are removed from register memory; the voided amounts are added to the void-mode transaction totalizer.)

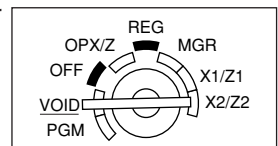

**Incorrect receipt**

DEPT. 04	T1	\$10.00
DEPT. 03	T1	\$1.50
MDSE ST		\$11.50
TAX1		\$0.72
ITEMS	2Q	
<b>CASH</b>		<b>\$12.22</b>



**Cancellation receipt**

<b>*VOID*</b>		
DEPT. 04	T1	\$10.00
DEPT. 03	T1	\$1.50
MDSE ST		\$11.50
TAX1		\$0.72
ITEMS	2Q	
<b>CASH</b>		<b>\$12.22</b>

# OPERATOR MAINTENANCE

## 1 In case of Power Failure

When power is lost, the machine retains its memory contents and all information on sales entries.

- When power failure is encountered in register idle state or during an entry, the machine returns to normal operation after power recovery.
- When power failure is encountered during a printing cycle, the register prints "======" and then carries out the correct printing procedure after power recovery. (See the sample print.)

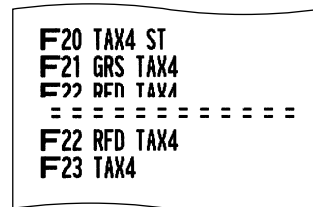

## 2 In Case of Printer Error

If the printer runs out of paper, the printer will stall, and "PPPPPPPPPP" will appear on the display. Key entries will not be accepted. Refer to section 5 in this chapter, install a new roll, then press the (CL) key. The printer will print the power failure symbol and resume printing.

If the print roller arm is not locked, the printer stalls, "H" will appear on the extreme left of the display. Key entries will not be accepted. Push down the arm until it is securely locked, then press the (CL) key. The printer will print the power failure symbol and resume printing.

## 3 Cautions in Handling the Printer and Recording Paper

### ■ Cautions in handling the printer

- Avoid dusty and humid environments, direct sunlight and iron powder. (A permanent magnet and electromagnet are used in this machine.)
- Never pull the paper when the print roller arm is locked. First lift up the arm, and then remove the paper.
- Never touch the surface of the print head and print roller.

### ■ Cautions in handling the recording paper (thermal paper)

- Use only the paper specified by SHARP.
- Do not unpack the thermal paper until you are ready to use it.
- Avoid heat. The paper will color at around 70°C.
- Avoid dusty and humid storage places. Avoid direct sunlight.
- The printed text on the paper can discolor under conditions of high humidity and temperature, exposure to the direct sunlight, contact with glue, thinner or a freshly copied blueprint, and heat caused by friction from scratching or other such means.
- Be very careful when handling the thermal paper. If you want to keep a permanent record, copy the printed text with a photocopier.



## 4 Replacing the Batteries

This cash register displays a low battery symbol (  $\text{L}$  ) when the batteries are low, and displays a no battery symbol (  $\text{L}$  ) when batteries are extremely low or batteries are not installed.

When the low battery symbol is displayed, replace the batteries with new ones as soon as possible. The existing batteries will be dead in about two days.

When the no battery symbol is displayed, replace the batteries immediately. Otherwise, if the AC power cord is disconnected or a power failure occurs, all the programmed settings will be reset to the default settings and any data stored in memory will be cleared.

**Note** *Be sure to observe precautions shown on page 1 when handling batteries.*

To replace the batteries:

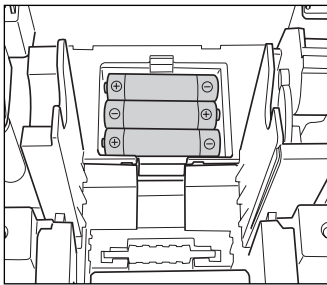

1. Make sure that the cash register is plugged in.
2. Turn the mode switch to the REG position.
3. Remove the printer cover.
4. Open the battery compartment cover next to the paper roll cradle and remove the old batteries.
5. Install three new "AA" batteries in the battery compartment. Be sure the positive and negative poles of each battery are facing in the proper direction. When they are installed correctly, the "  $\text{L}$  " or "  $\text{L}$  " symbol will disappear.
6. Close the battery compartment cover.
7. Replace the printer cover.

## 5 Replacing the Paper Roll

Be sure to use paper rolls specified by SHARP.

The use of any other paper rolls other than those specified could cause paper jamming, resulting in register malfunction.

### Paper specification

Paper width:  $2.25 \pm 0.02$  in ( $57.5 \pm 0.5$  mm)

Max. outside diameter: 3.15 in (80 mm)

Quality: Thermal paper

- Be sure to set the paper roll prior to using your machine, otherwise it may cause a malfunction.

Install the paper roll in the printer. Be careful to set the roll correctly.

(How to set the paper roll)

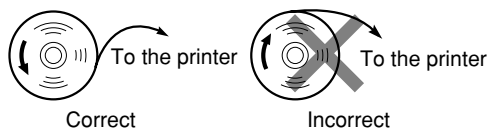

## ■ Removing the paper roll

When a red dye appears on the paper roll, it is time to replace it. Replace the paper roll with a new one. If you plan on not using the register for an extended period of time, remove the paper roll, and store it in an appropriate place.

**Caution: The paper cutter is mounted on the printer cover. Be careful not to cut yourself.**

### When not using the take-up spool (using as receipt paper):

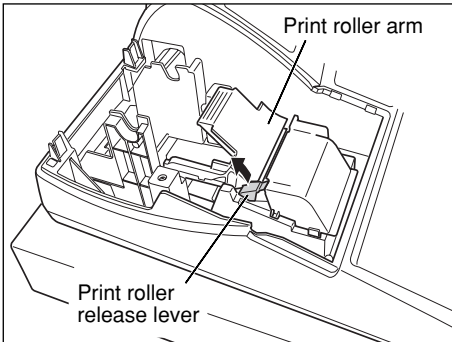

1. Remove the printer cover.
2. Lift up the print roller release lever to unlock and open the print roller arm.
3. Remove the paper roll from the paper roll cradle.

**Note** Do not pull the paper through the printer.

### When using the take-up spool (using as journal paper):

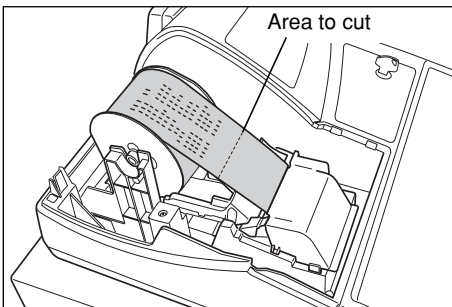

1. Turn the mode switch to a position other than OFF with the power cord connected.
2. Remove the printer cover.
3. Press the  key to advance the journal paper until its printed part is out of the way.
4. Cut the paper and remove the take-up spool.
5. Lift up the print roller release lever to unlock and open the print roller arm.
6. Remove the paper roll from the paper roll cradle.

**Note** Do not pull the paper through the printer.

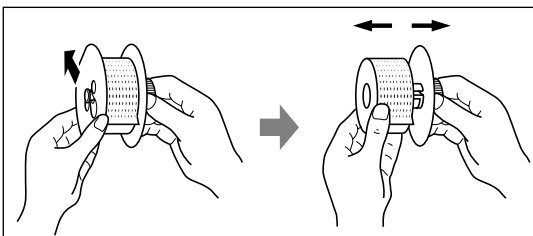

7. Remove the outer side of the take-up spool as shown on the left.
8. Remove the printed journal roll from the take-up spool.

## ■ Installing the paper roll

**Caution: The paper cutter is mounted on the printer cover. Be careful not to cut yourself.**

### Installing the receipt paper roll:

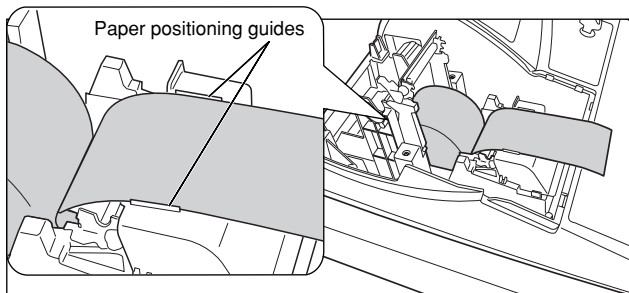

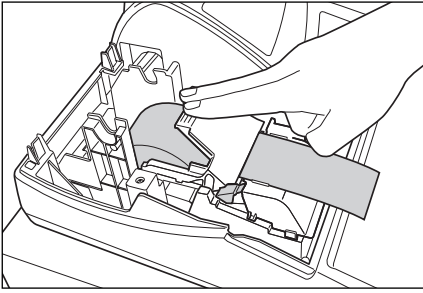

1. Turn the mode switch to a position other than OFF with the power cord connected.
2. Remove the printer cover.
3. Lift up the print roller release lever to unlock and open the print roller arm.
4. Set the paper correctly in the paper roll cradle.
5. Feed the end of the paper along with the paper positioning guides.

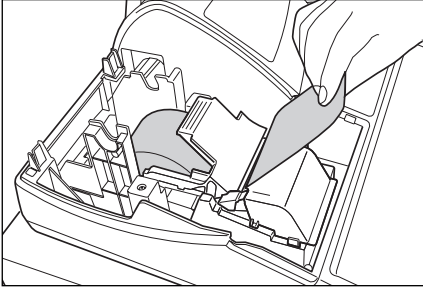

- 6.** While holding down the paper, slowly close the print roller arm, and push down the arm until you hear a click locking the arm. Make sure securely you push down the center of the wing part of the arm as illustrated at the left. The paper will be fed automatically.

**Note** *If the print roller arm is not securely locked, printing is not done right. If this problem occurs, open the arm, and close the arm as instructed above.*





- 7.** Cut off the excess paper using the edge of the inner cover, and replace the printer cover. Press the  key to make sure the paper end comes out of the printer cover and clean paper appears.

**Note** *If the paper end does not come out, open the printer cover, and pass the paper end between the paper cutter and the paper guide of the printer cover, and replace the cover.*

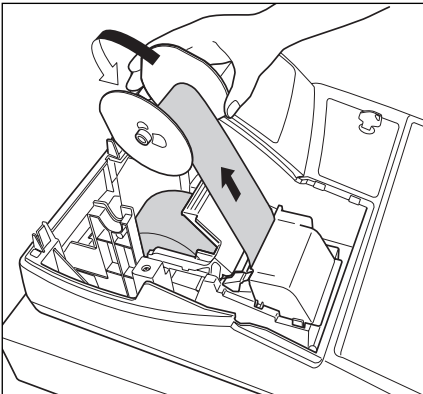
#### Installing the journal paper roll:



- 1.** Turn the mode switch to a position other than OFF with the power cord connected.
- 2.** Remove the printer cover.
- 3.** Lift up the print roller release lever to unlock and open the print roller arm.
- 4.** Set the paper correctly in the paper roll cradle.
- 5.** Feed the end of the paper along with the paper positioning guides.
- 6.** While holding down the paper, slowly close the print roller arm, and push down the arm until you hear a click locking the arm. Make sure securely you push down the center of the wing part of the arm as illustrated at the left. The paper will be fed automatically.
- 7.** Insert the end of the paper into the slit in the spool. (Press the  key to feed more paper if required.)
- 8.** Wind the paper two or three turns around the spool shaft.
- 9.** Set the spool on the bearing, and press the  key to take up excess slack in the paper.
- 10.** Replace the printer cover.

**Note**

*You can wind the roll paper in OP X/Z, X1/Z1, and X2/Z2 modes even if you programmed so that the printer is used for issuance of receipts. This may be convenient to wind reports. In this case, set the roll paper to the take-up spool.*

## 6 Removing a Paper Jam

**Caution:** The paper cutter is mounted on the printer cover. Be careful not to cut yourself. Never touch the print head immediately after printing, as the head may still be hot.

1. Remove the printer cover.
2. Lift up the print roller release lever to unlock the print roller arm, and open the print roller arm.
3. Remove the paper jam. Check for and remove any shreds of paper that may remain in the printer.
4. Reset the paper roll correctly by following the steps in "Installing the paper roll".

## 7 Cleaning the Printer (Print Head / Sensor / Roller)

When the printed text is getting dark or faint, paper dust may be stuck to the print head, sensor and/or roller. Clean them as follows:

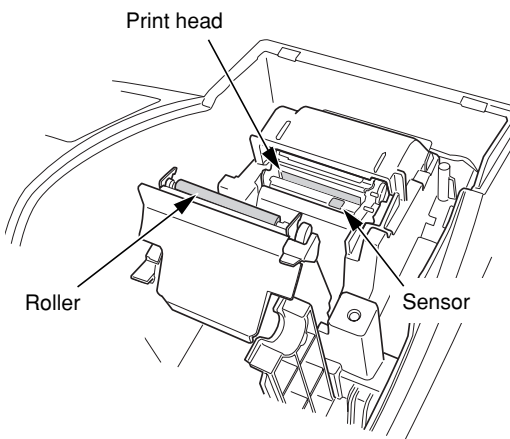

### Caution:

- Never touch the print head with a tool or anything hard as it may damage the head.
- The paper cutter is mounted on the printer cover. Be careful not to cut yourself.

1. Turn the mode switch to the OFF position.
2. Remove the printer cover.
3. Lift up the print roller release lever to unlock and open the print roller arm.
4. Remove the paper roll referring to the "Removing the paper roll" section.
5. Clean the print head with a cotton swab or soft rag moistened with ethyl alcohol or isopropyl alcohol. Clean the roller and the sensor in the same manner.
6. Reset the paper roll correctly by following the steps in "Installing the paper roll".

## 8 Removing the Till and the Drawer

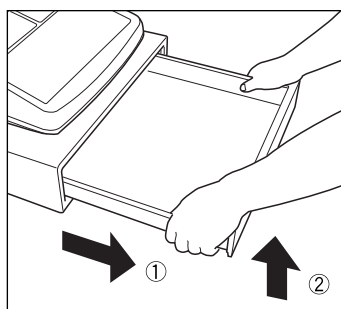
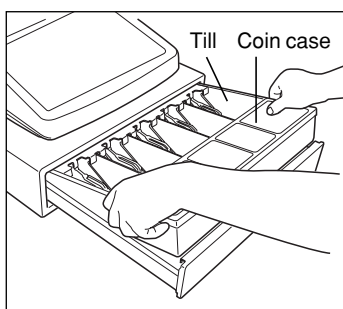

The till in the register is detachable. After closing your business for the day, remove the till from the drawer and keep the drawer open. To detach the drawer, pull it forward fully with the till removed, and remove it by lifting it up.

## 9 Opening the Drawer by Hand

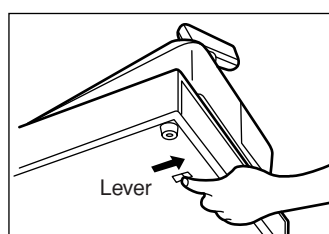

The drawer automatically opens. However, when a power failure occurs or the machine becomes out of order, slide the lever located on the bottom of the machine in the direction of the arrow. (See the figure at the left.)

The drawer will not open if it is locked with the key.

## 10 Before Calling for Service

The malfunctions shown in the left-hand column below, labelled "Fault," do not necessarily indicate functional faults of the machine. It is therefore advisable to refer to "Checking" shown in the right-hand column before calling for service.

Fault	Checking
(1) The display shows symbols that do not make sense.	<ul style="list-style-type: none"> <li>Has the machine been initialized properly as shown "GETTING STARTED"?</li> <li>(Note that initialization clears all the data and programmed settings stored in memory.)</li> </ul>
(2) The display won't be illuminated even when the mode switch is turned to any other position than "OFF".	<ul style="list-style-type: none"> <li>Is power supplied to the electrical outlet?</li> <li>Is the power cord plug out or loosely connected to the electrical outlet?</li> </ul>
(3) The display is illuminated, but the whole machine refuses registrations.	<ul style="list-style-type: none"> <li>Is a clerk code assigned to the register?</li> <li>Is the mode switch set properly at the "REG" position?</li> </ul>
(4) No receipt is issued.	<ul style="list-style-type: none"> <li>Is the paper roll properly installed?</li> <li>Is there a paper jam?</li> <li>Is the receipt function in the "OFF" status?</li> <li>Is the print roller arm securely locked?</li> </ul>
(5) No journal paper is taken up.	<ul style="list-style-type: none"> <li>Is the take-up spool installed on the bearing properly?</li> <li>Is there a paper jam?</li> <li>Is the journal printing selected in the printing style programming? (If the receipt printing is selected, the paper is not wound around the take-up spool.)</li> </ul>
(6) Printing is unusual.	<ul style="list-style-type: none"> <li>Is the print roller arm securely locked?</li> <li>Is the paper roll properly installed?</li> <li>Are the print head/sensor/roller clean?</li> </ul>

## ■ Error code table

When the following error codes are displayed, press the (CL) key and take a proper action according to the table below.

Error code	Error status	Action
E01	Registration error	Make a correct key entry.
E02	Misoperation error	Make a correct key entry.
E03	Undefined code is entered.	Enter a correct code
E07	Memory is full (in the (AUTO) key programming).	Program the (AUTO) key within 25 steps.
E11	Compulsory depression of the (#/TM/SBTL) key for direct finalization	Press the (#/TM/SBTL) key and continue the operation.
E12	Compulsory tendering	Make a tendering operation.
E32	No entry of a clerk code	Make a clerk code entry.
E34	Overflow limitation error	Make a registration within a limit of entry.
E35	The open price entry is inhibited.	Make a preset price entry.
E36	The preset price entry is inhibited.	Make an open price entry.
E37	The direct finalization is inhibited.	Make a tendering operation.
E67	Subtotal void is not allowed.	Finalize the transaction, and correct the wrong entries in the void mode.

# SPECIFICATIONS

Model:	ER-A242		
Dimensions:	16.6 (W) x 16.9 (D) x 11.7 (H) in. (421 (W) x 429 (D) x 297 (H) mm)		
Weight:	28.0 lb (12.7 kg)		
Power source:	120V AC $\pm$ 10%, 60 Hz		
Power consumption:	Stand-by 7.7 W Operating 30 W (max.)		
Working temperature:	32 °F to 104 °F (0 °C to 40 °C)		
Electronics:	LSI (CPU) etc.		
Display:			
Operator display:	7-segment display (10 positions)		
Customer display:	7-segment display (7 positions)		
Printer:			
Type:	One-station thermal printer		
Printing speed:	Approx. 12 lines/second		
Printing capacity:	24 digits each for receipt and journal paper		
Other functions:	<ul style="list-style-type: none"> <li>• Graphic logo printing function</li> <li>• Logo message function</li> <li>• Receipt (ON-OFF) function, compression printing function</li> </ul>		
Paper roll:	Width: 2.25 $\pm$ 0.02 in (57.5 $\pm$ 0.5 mm) Max. diam.: 3.15 in (80 mm) Quality: High quality (0.06 to 0.08 mm thickness)		
Cash drawer:	5 slots for bill and 5 for coin denominations		
Accessories:	Manager key	2	
	Operator key	2	
	Drawer lock key	2	
	Paper roll	1	
	Take-up spool	1	
	RS-232C cable (QCNWG3190RCPZ)	1	
	Customer support tool	1 disk	
	Instruction manual	1 copy	

\* Specifications and appearance subject to change without notice for improvement.

Use these labels with the department keys. Write department names on the labels and attach them to the department keys by first removing the transparent key covers. (Please make a copy of this page.)

Example:



18	22	26	30	20	24	28	32
2 D	6 I	10 N	14 S	4 B	8 G	12 L	16 Q
17	21	25	29	19	23	27	31
1 E	5 J	9 O	13 T	3 C	7 H	11 M	15 R

## NOTICE

BE SURE TO ASK YOUR AUTHORIZED SHARP DEALER ABOUT THE WARRANTY THAT YOUR SELLING DEALER EXTENDS TO YOU. In order to assure you, the end-user, of warranty protection, Sharp extends a limited warranty to each of its authorized dealers, and in turn requires each of its authorized dealers to extend its own warranty to you on terms that are no less favorable than those given to the dealer by Sharp. You should be aware, however, that Sharp does not itself extend any warranties, either express or implied, directly to you, the end-user, and no one is authorized to make any representations or warranties on behalf of Sharp. Specifically, SHARP DOES NOT EXTEND TO YOU, THE END-USER, ANY EXPRESS WARRANTY OR ANY IMPLIED WARRANTY OF MERCHANTABILITY, FITNESS FOR USE OR FITNESS FOR ANY PARTICULAR PURPOSE IN CONNECTION WITH THE HARDWARE, SOFTWARE, OR FIRMWARE EMBODIED IN OR USED IN CONJUNCTION WITH THIS PRODUCT. Sharp is not responsible for any damages or loss, either direct, incidental or consequential, which you, the end-user, may experience as a result of your purchase or use of the hardware, software or firmware embodied in or used in conjunction with this product. Your sole remedy in the event that you encounter any difficulties with the product is against the authorized dealer from which you purchased the product. In the event that this authorized dealer does not honor its warranty commitments, please contact the General Manager of Sales, Retail and Financial System Division, ISG, Sharp Electronics Corporation, Sharp Plaza, P.O. Box 650, Mahwah, NJ 07430-2135 so that Sharp can try to help you to assure complete satisfaction of all the warranty rights to which you are entitled from the authorized dealer.

# **SHARP**®

## **SHARP ELECTRONICS CORPORATION**

Sharp Plaza, Mahwah, New Jersey 07430-2135

1-800-BE-SHARP

<http://www.sharpusa.com>

## **SHARP CORPORATION**



## Free Manuals Download Website

<http://myh66.com>

<http://usermanuals.us>

<http://www.somanuals.com>

<http://www.4manuals.cc>

<http://www.manual-lib.com>

<http://www.404manual.com>

<http://www.luxmanual.com>

<http://aubethermostatmanual.com>

Golf course search by state

<http://golfingnear.com>

Email search by domain

<http://emailbydomain.com>

Auto manuals search

<http://auto.somanuals.com>

TV manuals search

<http://tv.somanuals.com>