

# SHARP®

# LC-30HV4M

ENGLISH

中文

中文

## LCD COLOUR TELEVISION

液晶彩色電視機

液晶彩色电视机

## OPERATION MANUAL

使用說明書

使用说明书

# AQUOS

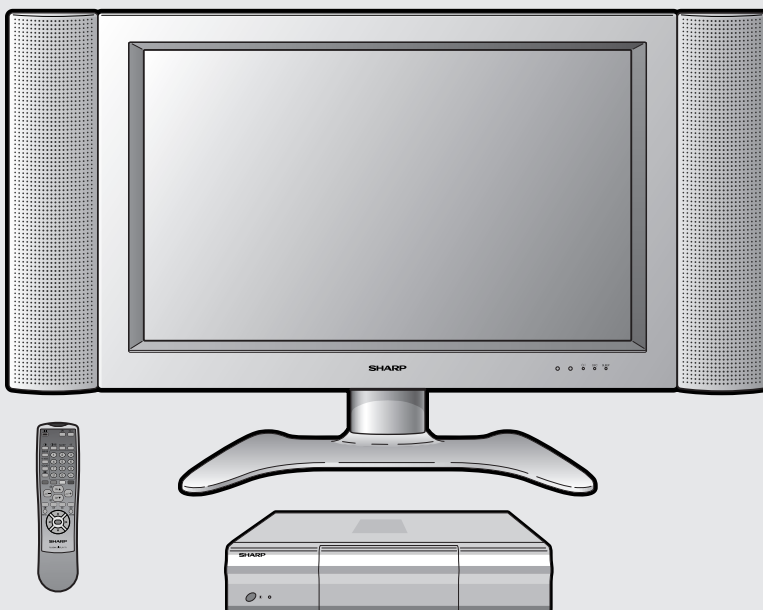

Printed in Japan  
日本印刷  
日本印刷  
TINS-A692WJZZ

Printed on post-consumer recycled paper.

本說明用紙使用的是再生紙。

本說明用紙使用的是再生紙。

Download from [www.somanuals.com](http://www.somanuals.com). All Manuals Search And Download.

# LC-30HV4M

## LCD COLOUR TELEVISION ENGLISH

### OPERATION MANUAL

## Contents

<b>Contents</b> .....	1	Power Control .....	35
<b>Dear SHARP customer</b> .....	2	Power Control for AV source .....	35
<b>Important Safety Precautions</b> .....	2	Power Control for PC source .....	37
<b>Supplied accessories</b> .....	4	<b>Using external equipment</b> .....	<b>38</b>
<b>Preparation</b> .....	<b>5</b>	Watching a DVD image .....	39
Where to place the System .....	5	Connecting a DVD player .....	39
Setting the System .....	6	Displaying a DVD image .....	39
Setting the Display on the wall .....	8	Watching a VCR image .....	40
Setting the AVC System with the stand .....	8	Connecting a VCR .....	40
Inserting the batteries .....	9	Displaying a VCR image .....	40
Using the remote control unit .....	9	Watching broadcasts via an HDTV tuner .....	41
Cautions regarding remote control unit .....	9	Connecting an HDTV tuner .....	41
<b>Part names</b> .....	<b>10</b>	Displaying broadcasts via an HDTV tuner .....	41
Display .....	10	Enjoying a game console and viewing camcorder	
AVC System .....	11	images .....	42
Remote control unit .....	12	Connecting a game console or camcorder .....	42
<b>Watching TV</b> .....	<b>13</b>	Displaying an image of the game console or	
Basic connection .....	13	camcorder .....	42
Connecting to an antenna .....	13	Viewing an image from a PC .....	43
Connecting to the power outlet .....	13	Connecting a PC .....	43
Turning on the power .....	14	Displaying an image from a PC .....	43
Turning off the power .....	14	Removing the speakers .....	44
Simple button operations for changing channels ..	15	<b>Useful adjustment settings</b> .....	<b>45</b>
Using Flashback (\$) on the remote control unit ..	15	Image position (AV input mode only) .....	45
Simple button operation for changing		Moving the picture on the screen .....	46
volume/sound .....	16	Auto Sync. adjustment (PC input mode only) .....	47
<b>Basic adjustment settings</b> .....	<b>19</b>	Fine Sync. adjustment (PC input mode only) .....	47
AV input mode menu items .....	19	Input signal source .....	48
PC input mode menu items .....	19	Colour system setting (AV input mode only) .....	49
Auto installation .....	20	AV mode selection .....	49
Programme setup .....	22	WIDE mode (for AV input mode) .....	50
Auto search .....	22	WIDE mode (for PC input mode) .....	51
Manual setting for each channel .....	23	Input signal (PC input mode only) .....	52
Search tuning .....	24	Wide screen signalling (WSS)	
Fine tuning .....	24	(AV input mode only) .....	53
Colour system .....	25	Picture aspect ratio (AV input mode only) .....	53
Sound system (Broadcasting system) .....	25	Selecting Full Mode display (AV input mode only) ..	54
Labelling channels .....	25	Rotate .....	55
Skipping channels .....	26	Audio out .....	56
Setting the child lock .....	26	Sleep timer .....	56
Sort .....	27	Cool climate .....	57
Language setting for on-screen display .....	28	Password setting for child lock (TV mode only) .....	58
Picture adjustments .....	29	<b>Useful features</b> .....	<b>59</b>
C.M.S. (Colour Management System) .....	30	Dual screen functions .....	59
Colour temperature .....	31	Teletext language setting .....	60
Black .....	31	Teletext function .....	61
Monochrome .....	32	<b>Appendix</b> .....	<b>64</b>
Film mode .....	32	Troubleshooting .....	64
I/P setting .....	33	PC compatibility chart .....	65
DNR (Digital Noise Reduction) .....	33	RS-232C port specifications .....	66
Audio adjustment .....	34	Specifications .....	68
Sound adjustment .....	34	Optional accessory .....	68
Surround .....	34	<b>Dimensional drawings</b> .....	<b>69</b>

# Dear SHARP customer

Thank you for your purchase of the SHARP LCD colour TV product. To ensure safety and many years of trouble-free operation of your product, please read the Important Safety Precautions carefully before using this product.

## Important Safety Precautions

Electricity is used to perform many useful functions, but it can also cause personal injuries and property damage if improperly handled. This product has been engineered and manufactured with the highest priority on safety. However, improper use can result in electric shock and/or fire. In order to prevent potential danger, please observe the following instructions when installing, operating and cleaning the product. To ensure your safety and prolong the service life of your LCD colour TV product, please read the following precautions carefully before using the product.

1. Read instructions—All operating instructions must be read and understood before the product is operated.
2. Keep this manual in a safe place—These safety and operating instructions must be kept in a safe place for future reference.
3. Observe warnings—All warnings on the product and in the instructions must be observed closely.
4. Follow instructions—All operating instructions must be followed.
5. Attachments—Do not use attachments not recommended by the manufacturer. Use of inadequate attachments can result in accidents.
6. Power source—This product must operate on a power source specified on the specification label. If you are not sure of the type of power supply used in your home, consult your dealer or local power company.
7. AC cord protection—The AC cords must be routed properly to prevent people from stepping on them or objects from resting on them. Check the cords at the plugs and product.
8. Overloading—Do not overload AC outlets or extension cords. Overloading can cause fire or electric shock.
9. Entering of objects and liquids—Never insert an object into the product through vents or openings. High voltage flows in the product, and inserting an object can cause electric shock and/or short internal parts. For the same reason, do not spill water or liquid on the product.
10. Servicing—Do not attempt to service the product yourself. Removing covers can expose you to high voltage and other dangerous conditions. Request a qualified service person to perform servicing.
11. Repair—If any of the following conditions occurs, unplug the AC cord from the AC outlet, and request a qualified service person to perform repairs.
  - a. When the AC cord or plug is damaged.
  - b. When a liquid was spilled on the product or when objects have fallen into the product.
  - c. When the product has been exposed to rain or water.
  - d. When the product does not operate properly as described in the operating instructions.  
Do not touch the controls other than those described in the operating instructions. Improper adjustment of controls not described in the instructions can cause damage, which often requires extensive adjustment work by a qualified technician.
  - e. When the product has been dropped or damaged.
  - f. When the product displays an abnormal condition. Any noticeable abnormality in the product indicates that the product needs servicing.
12. Replacement parts—In case the product needs replacement parts, make sure that the service person uses replacement parts specified by the manufacturer, or those with the same characteristics and performance as the original parts. Use of unauthorized parts can result in fire, electric shock and/or other danger.
13. Safety checks—Upon completion of service or repair work, request the service technician to perform safety checks to ensure that the product is in proper operating condition.
14. Wall or ceiling mounting—When mounting the product on a wall or ceiling, be sure to install the product according to the method recommended by the manufacturer.
15. Unplug the AC cord from the AC outlet before installing the speakers.

## Important Safety Precautions

- **Cleaning**—Unplug the AC cord from the AC outlet before cleaning the product. Use a damp cloth to clean the product. Do not use liquid cleaners or aerosol cleaners.

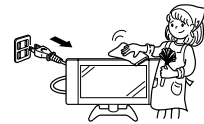

- **Water and moisture**—Do not use the product near water, such as bathtub, washbasin, kitchen sink, laundry tub, swimming pool and in a wet basement.



- **Do not place vases or any other water-filled containers on this product.** The water may spill onto the product causing fire or electric shock.



- **Stand**—Do not place the product on an unstable cart, stand, tripod or table. Doing so can cause the product to fall, resulting in serious personal injuries as well as damage to the product. Use only a cart, stand, tripod, bracket or table recommended by the manufacturer or sold with the product. When mounting the product on a wall, be sure to follow the manufacturer's instructions. Use only the mounting hardware recommended by the manufacturer.



- **When relocating the product placed on a cart, it must be moved with utmost care.** Sudden stops, excessive force and uneven floor surface can cause the product to fall from the cart.



- **Ventilation**—The vents and other openings in the cabinet are designed for ventilation. Do not cover or block these vents and openings since insufficient ventilation can cause overheating and/or shorten the life of the product. Do not place the product on a bed, sofa, rug or other similar surface, since they can block ventilation openings. This product is not designed for built-in installation; do not place the product in an enclosed place such as a bookcase or rack, unless proper ventilation is provided or the manufacturer's instructions are followed.

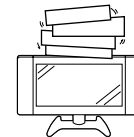

- **The LCD panel used in this product is made of glass.** Therefore, it can break when the product is dropped or applied with impact. Be careful not to be injured by broken glass pieces in case the LCD panel breaks.



- **Heat sources**—Keep the product away from heat sources such as radiators, heaters, stoves and other heat-generating products (including amplifiers).

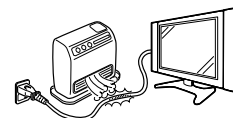

The LCD panel is a very high technology product with 2,949,120 thin film transistors, giving you fine picture details.

Occasionally, a few non-active pixels may appear on the screen as a fixed point of blue, green or red. Please note that this does not affect the performance of your product.

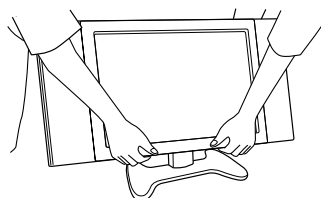

### Precautions when transporting the Display

When transporting the Display, never carry it by holding onto the speakers. It is recommended to always carry the Display by two people holding it with two hands—one hand on each side of the Display.

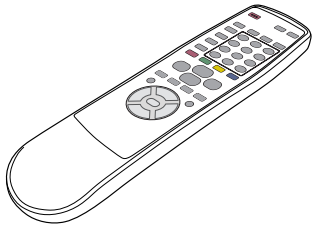

# Supplied accessories

Make sure the following accessories are provided with the product.

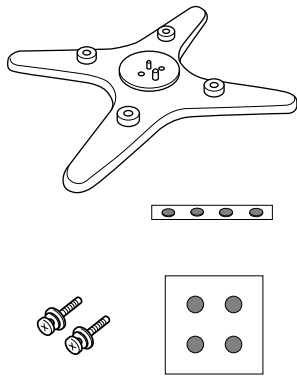
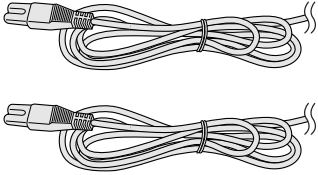
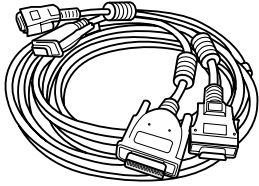
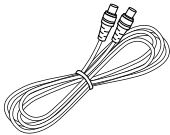
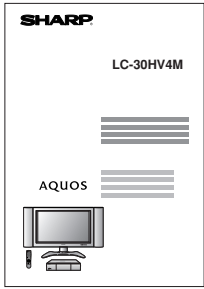
Remote control unit (× 1)	LR6 ("AA" size) Alkaline battery (× 2)	Cable clamp (× 1)
 <p>Page 9</p>	 <p>Page 9</p>	 <p>Page 7</p>
Stand unit (for AVC System) (× 1)	AC cord (× 2)	System cable (× 1)
 <p>Stand (× 1) Stand cushion (× 4) Stand spacer (× 4) Stand screw (× 2)</p> <p>Page 8</p>	 <p>Page 6</p>	 <p>Page 6</p>
	Antenna cable (× 1)	Operation manual
	 <p>Page 13</p>	

# Preparation

## Where to place the System

"System" means the Display and AVC System. First select the location where to place the System.

1

### Selecting the location of the System

- Select a place with no direct sunlight and good ventilation.
- The Display and the AVC System are connected by the system cable.  
(See page 6 for details.)

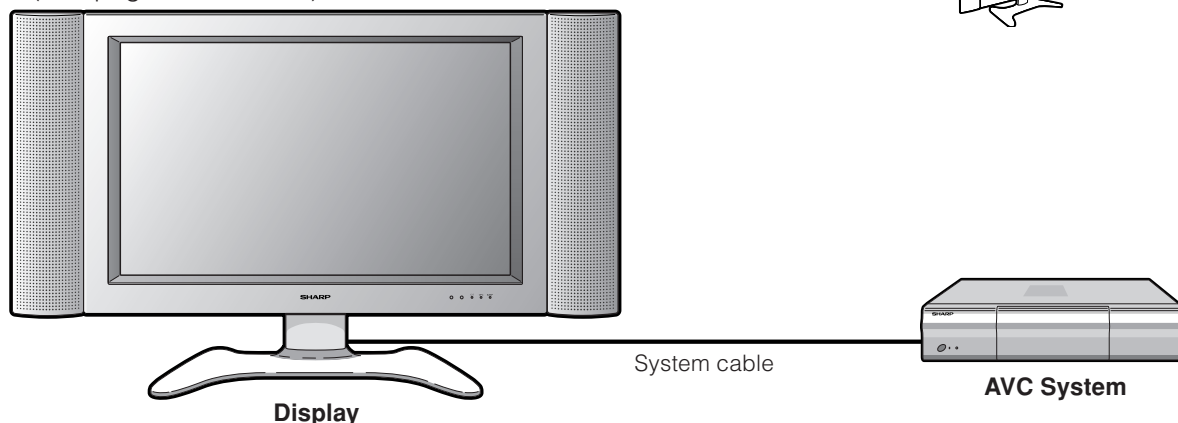
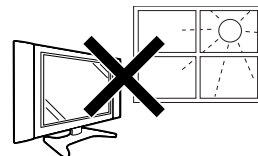

2

### Setting the System in place

#### Handling the Display



- Do not remove the stand from the Display unless using an optional bracket to mount it.
- When moving, put your hands on the Display, but never on the Display speakers.
- Keep enough space above and behind the Display.

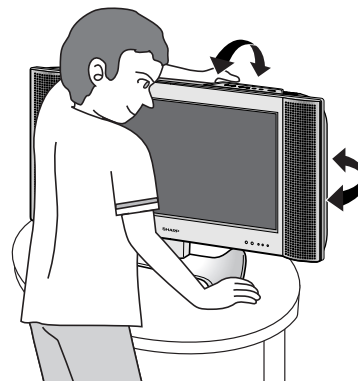

#### Handling the AVC System



- Do not put a VCR or other device on the AVC System.
- Keep enough space above and on the sides of the AVC System.
- Do not block the ventilation openings on the top and left side, and the exhaust fan on the right side.
- Do not spread a thick cloth beneath the AVC System, or cover it with one, as this can cause overheating and result in malfunction.



**Adjust the screen with both hands. Put one hand on the Display and tilt the screen while steadying the stand with your other hand.**

You can adjust the screen vertically up to 10 degrees forward or 8 degrees backward, or rotate 10 degrees horizontally.

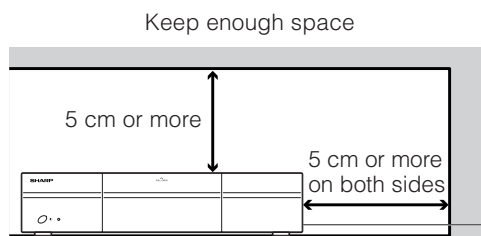
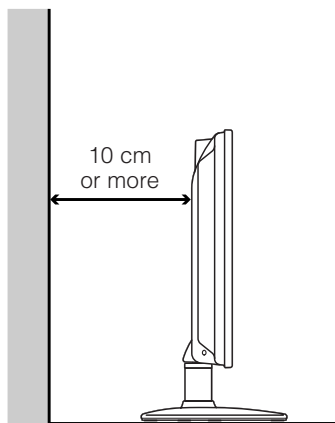

## Setting the System

After putting the Display and the AVC System in place, connect the system cables and AC cords. Use the cable clamp for bundling the cables.

### 1 Removing the terminal cover

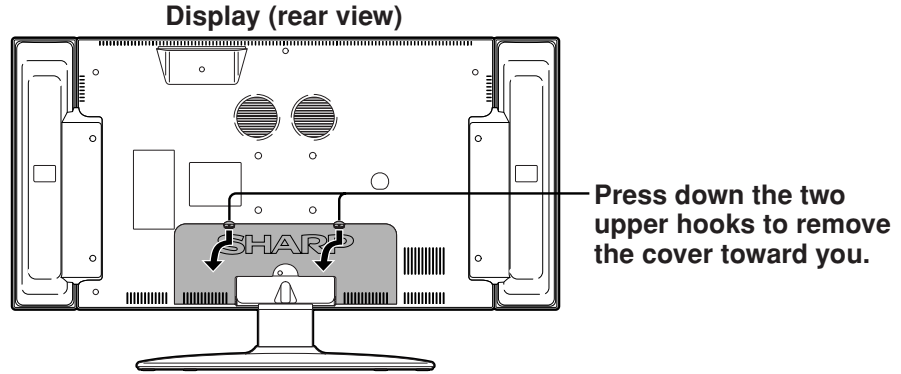

### 2 Connecting the system cable and the AC cord to the Display

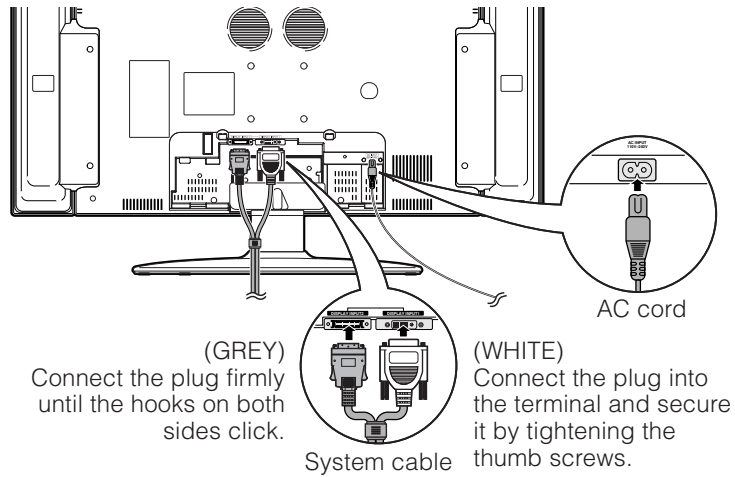

### 3 Connecting the system cable and the AC cord to the AVC System

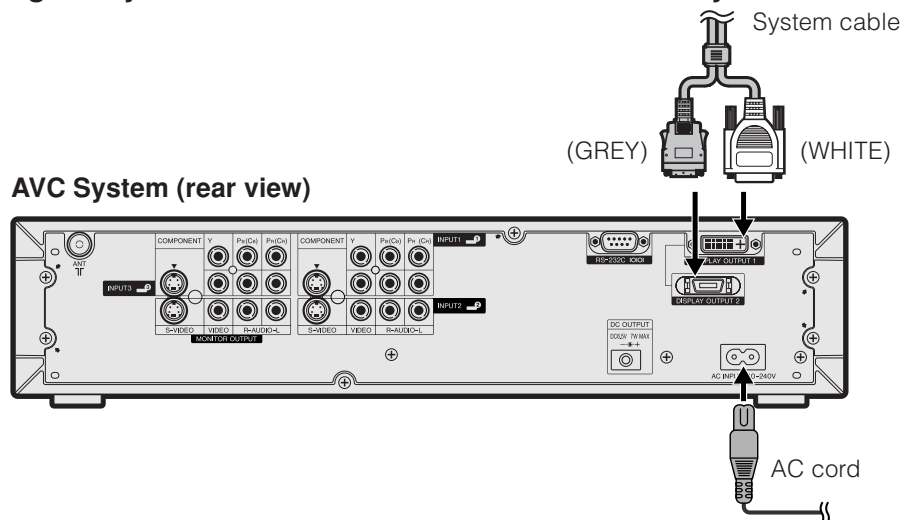

#### CAUTION

- TO PREVENT RISK OF ELECTRIC SHOCK, DO NOT TOUCH UN-INSULATED PARTS OF ANY CABLES WITH THE AC CORD CONNECTED.

4

Attaching the clamp to the leg of the Display

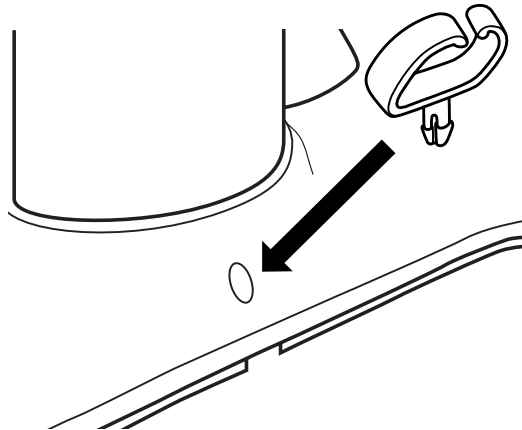

5

Bundling the cables with the clamp

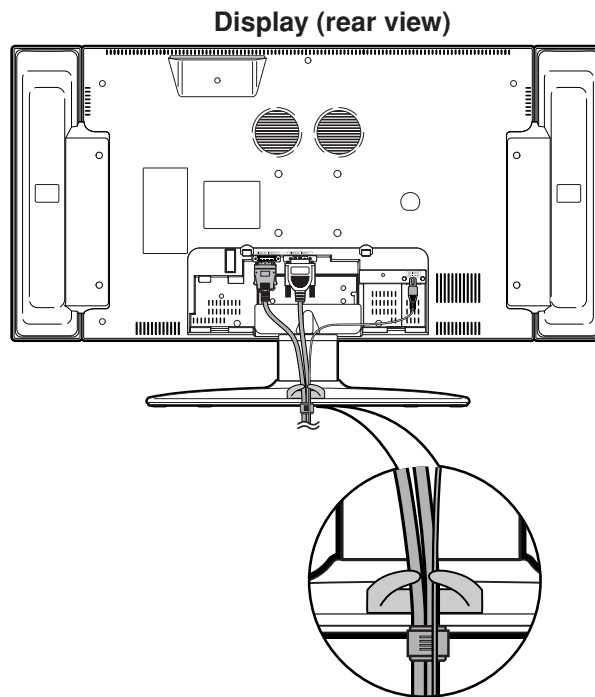

6

Closing the terminal cover

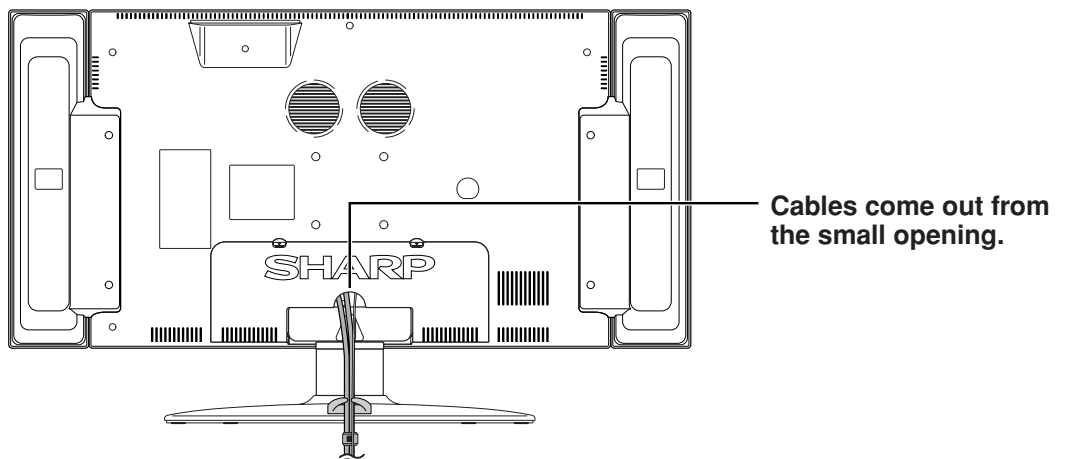



## Preparation

### Setting the Display on the wall

#### Using an optional bracket to mount the Display

- You can ask a qualified service personnel about using an optional AN-37AG1 bracket to mount the Display to the wall.
- Carefully read the instructions that come with the bracket before beginning work.

#### Hanging on the wall

AN-37AG1 wall mount bracket. (See the bracket instructions for details.)

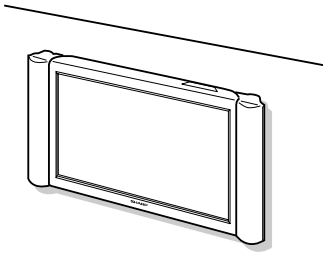

Vertical mounting

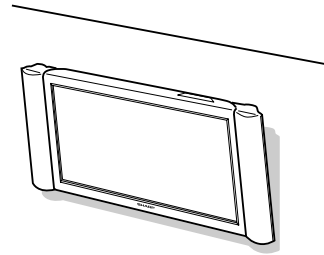

Angular mounting

#### CAUTION

- Installing the LCD Colour TV requires special skill that should only be performed by qualified service personnel. Customers should not attempt to do the work themselves. SHARP bears no responsibility for improper mounting or mounting that results in accident or injury.

### Setting the AVC System with the stand

#### How to install the AVC System vertically using the stand unit.

- Use the supplied stand unit for installing the AVC System vertically in an upright position.

#### 1 Stick each spacer to the stand as shown.

Peel each spacer away from the paper and attach to the four bulging areas on the stand.

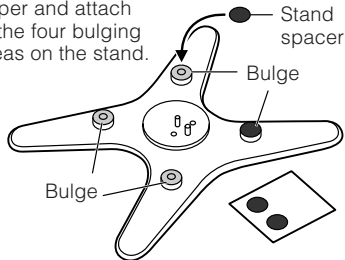

#### 2 Attach each cushion to the stand as shown.

Peel each cushion away from the paper and attach to the four areas at the bottom.

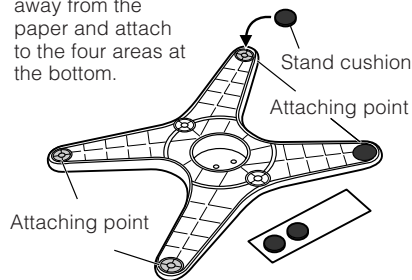

#### 3 Fit the stand to the AVC System.

Insert the stand into the AVC System, making sure that the thick and thin bulges of the stand align with the big and small holes on the AVC System.

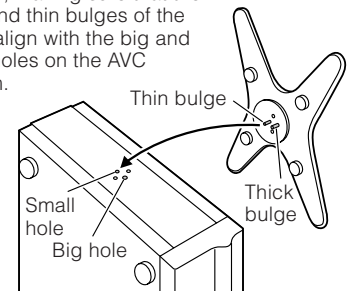

#### 4 Attach the stand using the stand screws as shown.

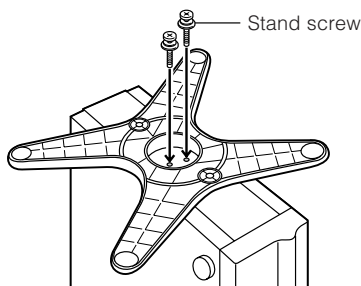

#### The AVC System installed vertically with the stand.

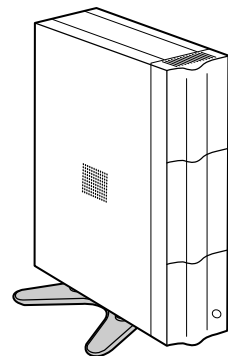

#### NOTE

- When mounting the AVC System vertically, always use the supplied stand. Be careful not to block vent holes when standing up directly on the floor or a flat surface as this can result in equipment failure.

## Preparation

### Inserting the batteries

Before using the System for the first time, insert two LR6 ("AA" size) Alkaline batteries (supplied). When the batteries become depleted and the remote control fails to operate, replace the batteries with new LR6 ("AA" size) Alkaline batteries.

- 1 Open the battery cover.
- 2 Insert two supplied LR6 ("AA" size) Alkaline batteries.
- 3 Close the battery cover.

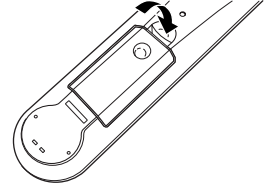
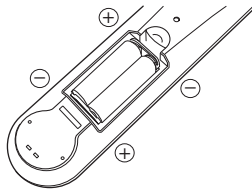
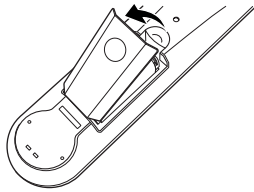

- Place batteries with their terminals corresponding to the (+) and (-) indications in the battery compartment.

### CAUTION

Improper use of batteries can result in chemical leakage or explosion. Be sure to follow the instructions below.

- Do not use manganese batteries. When you replace the batteries, use alkaline ones.
- Place the batteries with their terminals corresponding to the (+) and (-) indications.
- Do not mix batteries of different types. Different types of batteries have different characteristics.
- Do not mix old and new batteries. Mixing old and new batteries can shorten the life of new batteries or cause chemical leakage in old batteries.
- Remove batteries as soon as they have worn out. Chemicals that leak from batteries can cause a rash. If you find any chemical leakage, wipe thoroughly with a cloth.
- The batteries supplied with this product may have a shorter life expectancy due to storage conditions.
- If you will not be using the remote control unit for an extended period of time, remove the batteries from it.

### Using the remote control unit

Use the remote control unit by pointing it towards the remote sensor window. Objects between the remote control unit and sensor window may prevent proper operation.

### Cautions regarding remote control unit

- Do not expose the remote control unit to shock. In addition, do not expose the remote control unit to liquids, and do not place in an area with high humidity.
- Do not install or place the remote control unit under direct sunlight. The heat may cause deformation of the unit.
- The remote control unit may not work properly if the remote sensor window of the Display is under direct sunlight or strong lighting. In such case, change the angle of the lighting or Display, or operate the remote control unit closer to the remote sensor window.

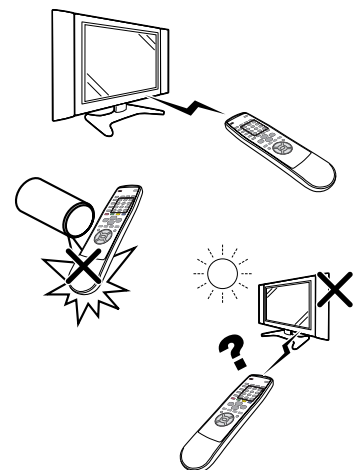

# Part names

## Display

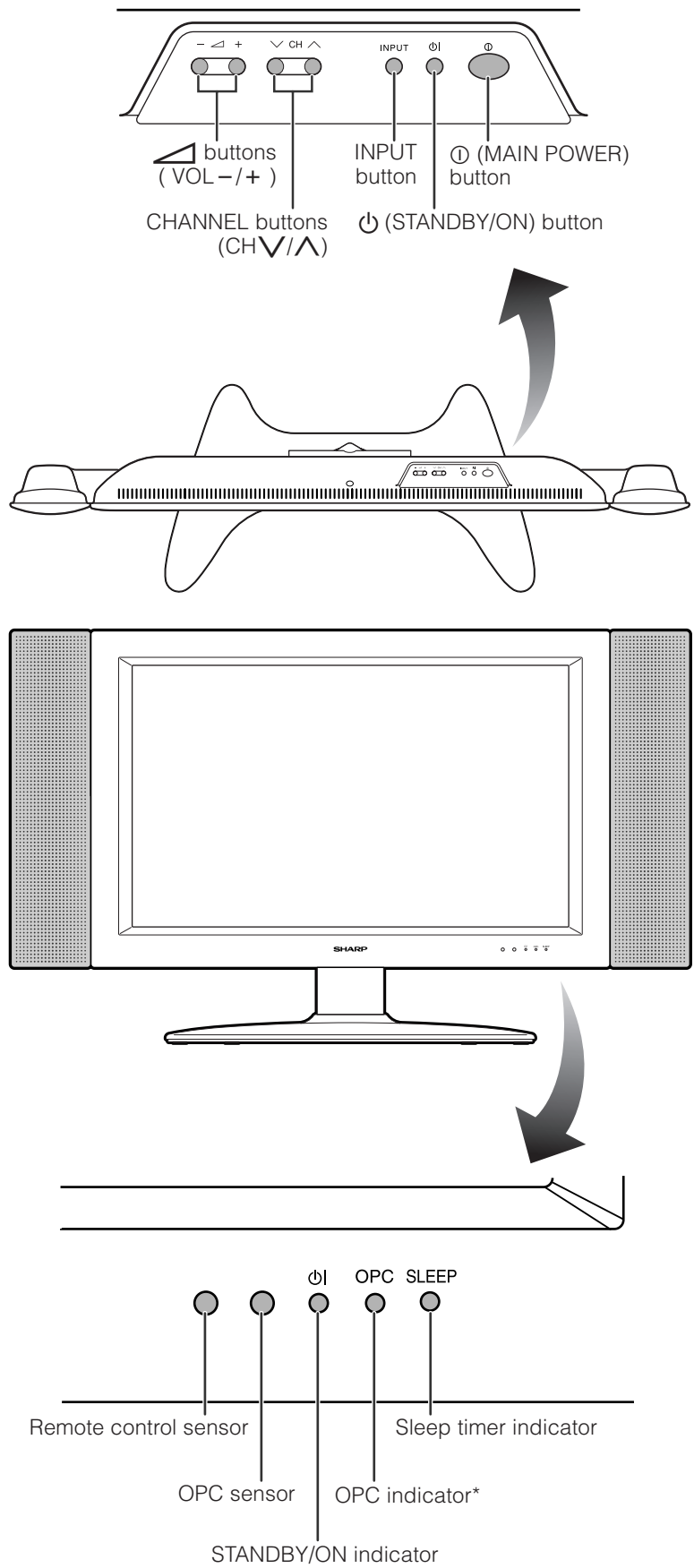

\*OPC: Optical Picture Control  
(See Pages 35 and 37.)

## Part names

### AVC System

#### Front view

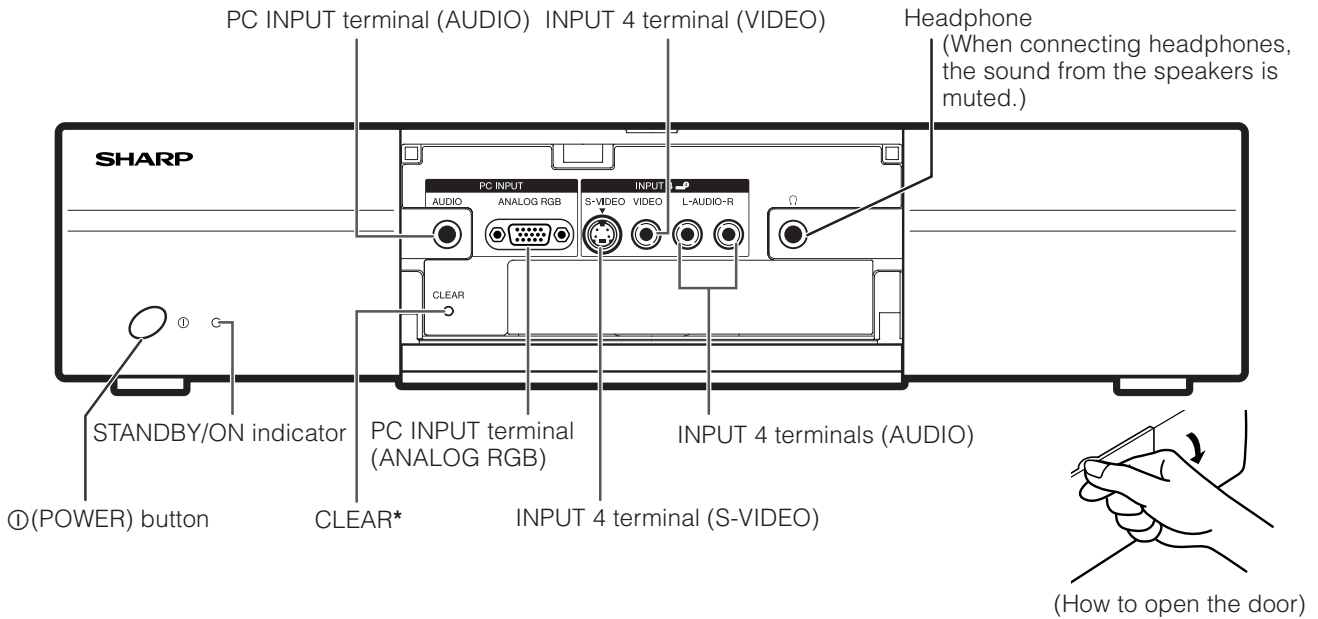

\* If the AVC System is switched on but it does not appear to be operating correctly, it may need resetting. In this case, press **CLEAR**, shown in the diagram, lightly with the end of a ballpoint pen or other pointed object. This will reset the System as shown below.

- AV MODE resets to USER.
- TV channel resets to channel 1.
- Dual screen resets to normal.
- Audio setting initialises.
- SRS resets to OFF.
- Image position is initialised.

#### NOTE

- Pressing **CLEAR** will not work if the System is in standby mode (indicator lights red).
- Pressing **CLEAR** will not delete channel preset or password. See page 58 for clearing the password when you know it. See page 71 for initialising to the factory preset values when you forget your password.

#### Rear view

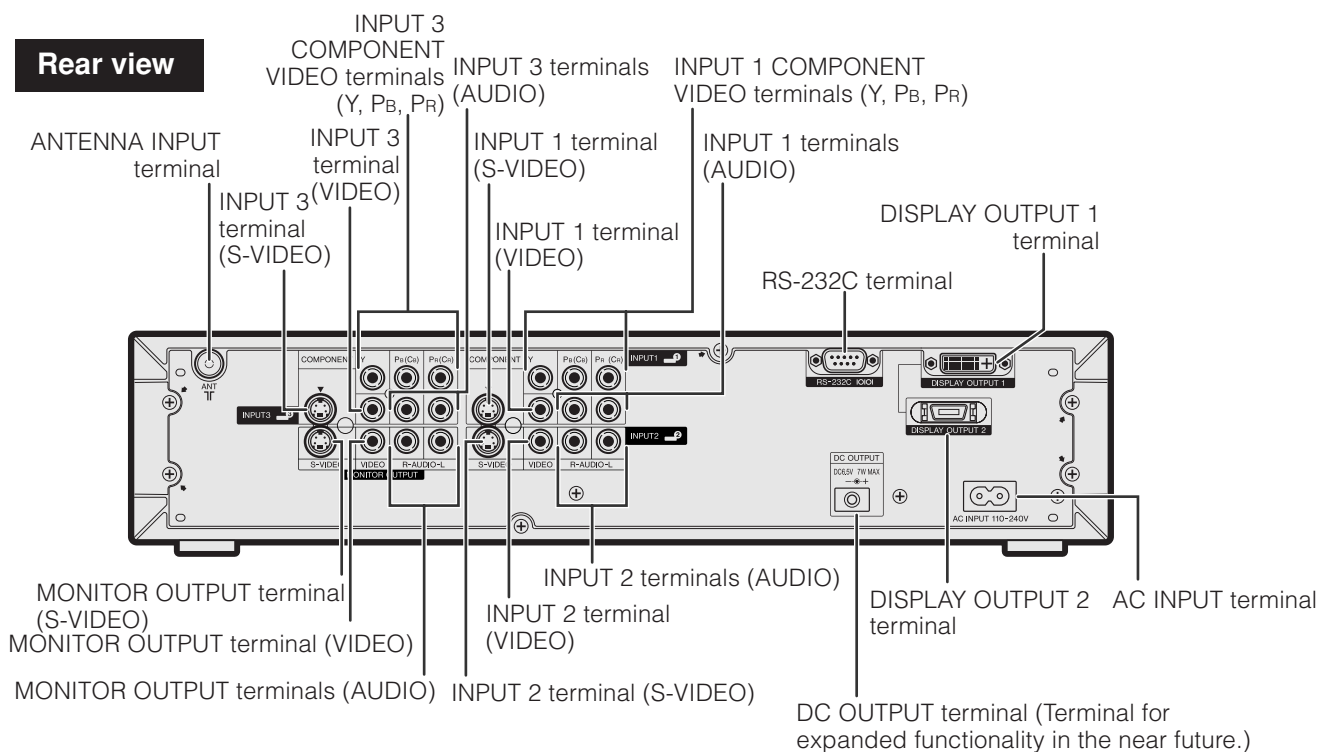

Remote control unit

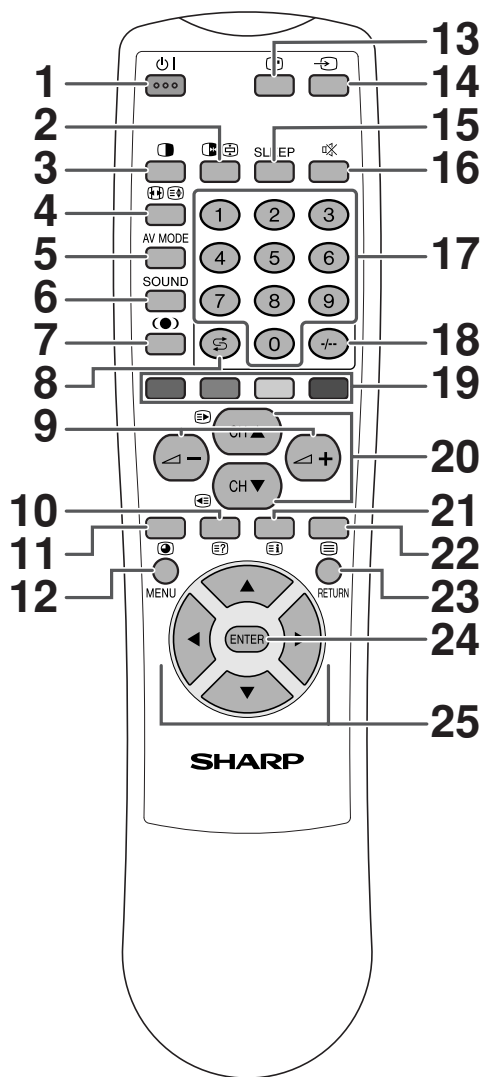

NOTE

- When using the remote control unit, point it at the Display.
- \* **SRS (SRS and FOCUS)** is a trademark of SRS Labs, Inc. FOCUS technology is incorporated under license from SRS Labs, Inc.

- 1** **(STANDBY/ON)**  
To switch the power on and off. (See page 14.)
- 2** **(FREEZE/HOLD for TELETEXT)**  
TV/External input mode: Change the still image mode.  
TELETEXT mode: Freeze a multi-page on screen while other pages are automatically updated. Press again to return to the normal image. (See pages 60 and 61.)
- 3** **(DUAL screen)**  
Set the dual picture mode. Press again to return to normal view. (See page 59.)
- 4** **(WIDE MODE/ T/B/F)**  
TV/External input mode: Change the wide image mode. (See pages 50 and 51.)  
TELETEXT mode: Set the area of magnification. (full/upper half/ lower half) (See page 61.)
- 5** **AV MODE**  
Select a video setting: AV MODE (STANDARD, DYNAMIC, MOVIE, GAME, USER), PC MODE (STANDARD, USER) (See page 49.)
- 6** **SOUND**  
Select the sound multiplex mode. (See page 18.)
- 7** **(SRS and FOCUS)\***  
Select SRS and FOCUS sound system. (See page 17.)
- 8** **(Flashback)**  
Press to return to the previous channel in normal viewing mode.  
Press to return to the previous page in TELETEXT mode. (See page 15.)
- 9** **(VOLUME)**  
Set the volume. (See page 16.)
- 10** **(Reveal hidden for TELETEXT)**  
TELETEXT mode: Display hidden characters. (See page 61.)
- 11** **(SUBPAGE for TELETEXT)**  
TELETEXT mode: Change the picture mode for sub-page selecting. (See page 62.)
- 12** **MENU**  
Display the MENU screen.
- 13** **(CHANNEL INFORMATION)**  
Display the channel information and time. (See page 63 for details on the time display.)
- 14** **(INPUT SOURCE)**  
Select an input source. (TV, INPUT 1, INPUT 2, INPUT 3, INPUT 4, PC) (See pages 39-43 and 48.)
- 15** **SLEEP**  
Set the Sleep timer. (See page 56.)
- 16** **(MUTE)**  
Mute the sound. (See page 16.)
- 17** **0 - 9**  
TV/External input mode: Set the channel.  
TELETEXT mode: Set the page.
- 18** **-/-- (Digit for channel select)**  
Change the digits of the selected TV channel. (See page 15.)
- 19** **Colour (RED/GREEN/YELLOW/BLUE)**  
TELETEXT mode: Select a page. (See page 61.)
- 20** **(CH▲/CH▼)**  
TV/External input mode: Select the channel.  
TELETEXT mode: Set the page. (See page 61.)
- 21** **(TOP Overview for TELETEXT)**  
TELETEXT mode: Display an index page for CEEFAX/FLOF information. TOP Overview for TOP programme. (See page 62.)
- 22** **(TELETEXT)**  
Select the TELETEXT mode. (all TV image, all TEXT image, TV/TEXT image) (See pages 61 and 62.)
- 23** **RETURN**  
MENU mode: Return to the previous menu screen.
- 24** **ENTER**  
Execute a command.  
Return to the initial image position after moving with .
- 25** **(Cursor)**  
Select a desired item on the setting screen.  
Move the picture on the screen.

# Watching TV

Simple operations for watching a TV programme

## Basic connection

### Connecting to an antenna

To enjoy a clearer picture, use an outdoor antenna. The following is a brief explanation of the types of connections that are used for coaxial cable.

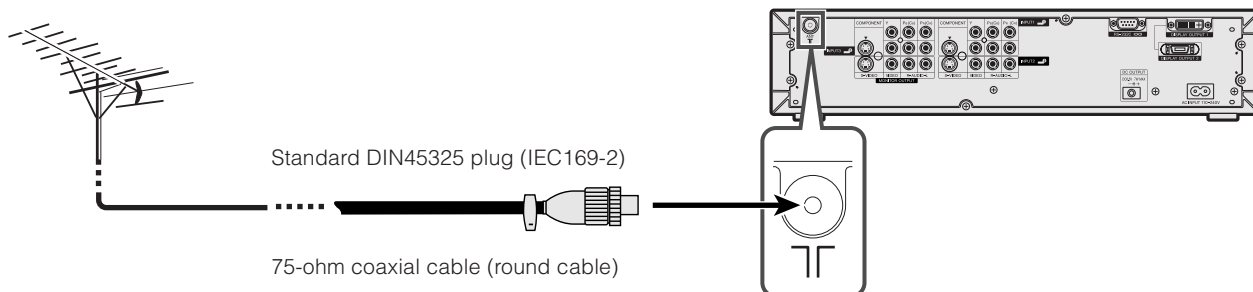

### Antenna cable



If your outdoor antenna uses a 75-ohm coaxial cable with a standard DIN45325 plug (IEC 169-2), plug it into the ANTENNA INPUT terminal at the rear of the AVC System.

### Connecting to the power outlet

#### Display (rear view)

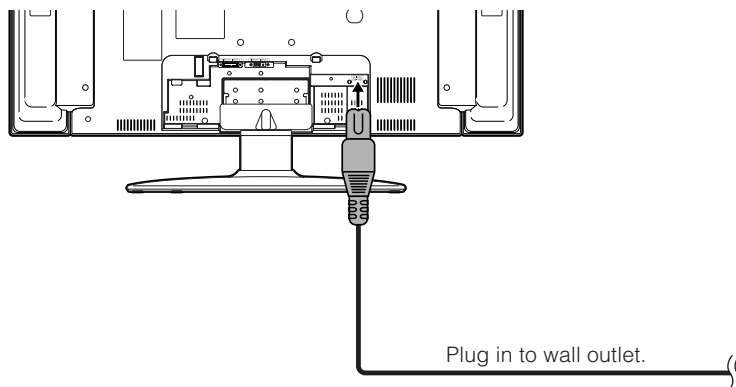

#### AVC System (rear view)

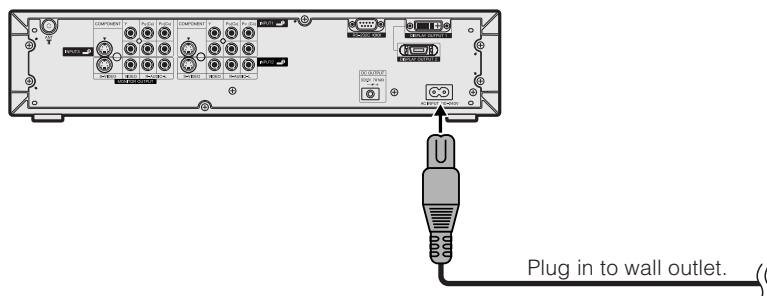

#### NOTE

- Always turn off the main power of Display and AVC System when connecting the AC cords.
- Disconnect the AC cords from the AC outlet, Display and AVC System if the System will not be used for a long period of time.

## Display

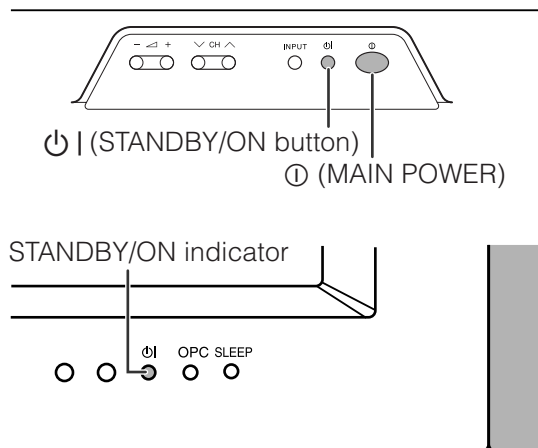

## AVC System

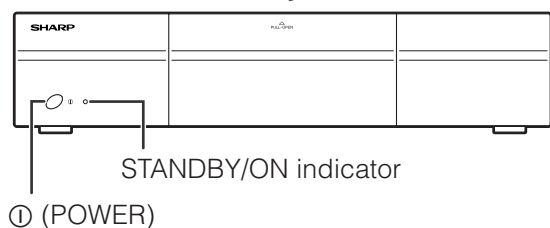

## Turning on the power

1

- Press ① (MAIN POWER) on the Display.
- The STANDBY/ON indicator on the Display flashes red.

2

- Press ① (POWER) on the AVC System.
- The System turns the power on.
  - The STANDBY/ON indicator on the Display lights up green and the one on the AVC System lights up green.
  - If the STANDBY/ON indicators still light up red, press ① on the remote control unit or ① (STANDBY/ON) button on the Display to turn the System on.

## When turning the AVC System on first

1

- Press ① (POWER) on the AVC System.
- The STANDBY/ON indicator on the AVC System lights up red.

2

- Press ① (MAIN POWER) on the Display.
- The System turns the power on.
  - The STANDBY/ON indicator on the Display lights up green and the one on the AVC System lights up green.
  - If the STANDBY/ON indicators still light up red, press ① on the remote control unit or ① (STANDBY/ON) button on the Display to turn the System on.

## Turning off the power

1

- Press ① on the remote control unit or ① (STANDBY/ON) button on the Display.
- The System enters standby mode and the image on the screen disappears.
  - Both STANDBY/ON indicators change from green to red.

2

- Press ① (POWER) on the AVC System.
- The STANDBY/ON indicator on the AVC System turns off and the one on the Display flashes red.

3

- Press ① (MAIN POWER) on the Display.
- The STANDBY/ON indicator on the Display gradually turns off.

### NOTE

- If you are not going to use this System for a long period of time, be sure to remove the AC cords from the power outlet.
- Weak electric power is still consumed even when both ① (MAIN POWER) and ① (POWER) are turned off.
- When the STANDBY/ON indicator lights up red, it takes about 10 to 15 seconds for the indicator to turn off if ① (POWER) on the AVC System is turned "Off" or the AC cord is unplugged from the AC outlet.

## Display status indicator

Off	Power off
Flashing red	AVC System does not turn on or its AC cord is disconnected.
Red	The System is in standby mode.
Green	The System is on.

## AVC System status indicator

Off	Power off
Red	Only the AVC System is in standby mode or the System is in standby mode.
Green	The System is on.

## Watching TV

### Simple button operations for changing channels

You can change channels in several ways.

#### Using CH▲/▼ on the remote control unit

- Press **CH▲** to increase channel number.
- Press **CH▼** to decrease channel number.

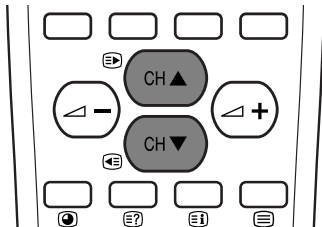

#### NOTE

- **CH▼/▲** on the Display operates the same as **CH▼/▲** on the remote control unit.

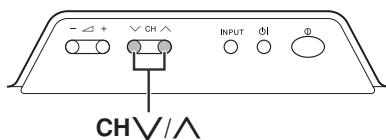

#### Using 0 – 9 on the remote control unit

Select the channels directly by pressing buttons **0** to **9**.

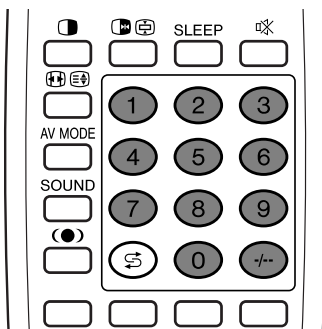

#### EXAMPLE

To select a 1-digit channel (e.g. channel 2):

- Press **2**. If "2" is indicated and the picture does not change, press **-/-** to switch over to the 1-digit select mode and press **2** again.

To select a 2-digit channel (e.g. channel 12):

- Press **-/-** to set the 2-digit select mode. Press **1**, followed by **2**.

#### NOTE

- Complete this procedure within 3 seconds, otherwise the selection will not be made on the 2-digit channel mode.

#### When viewing Teletext information

View a page directly which is 3-digit page number from 100 to 899 by pressing buttons **0** to **9**. With Teletext, you do not use **-/-**. (See page 62).

#### Channel display

Channel display changes approximately after 3 seconds as shown below.

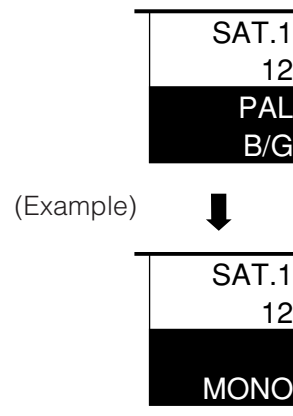

#### Using Flashback (↶) on the remote control unit

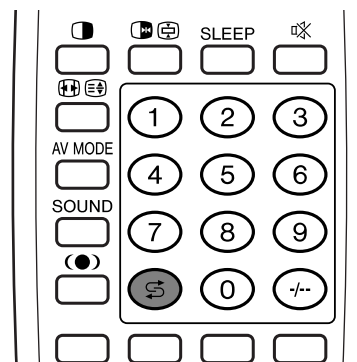

Press **↶** to switch the currently tuned channel to the previously tuned channel.

Press **↶** again to switch back to the currently tuned channel.



## Watching TV

### Simple button operation for changing volume/sound

#### Changing the volume

You can change the volume on the Display or on the remote control unit.

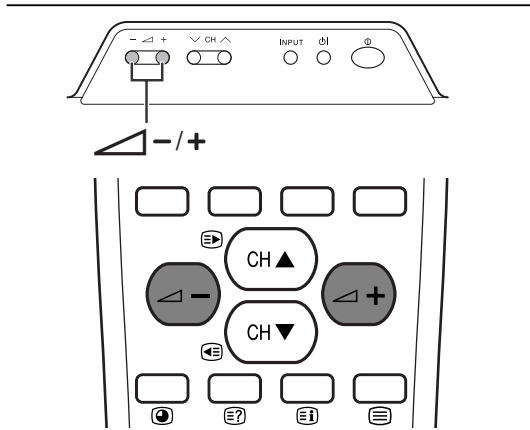

- To increase the volume, press +.
- To decrease the volume, press -.



#### NOTE

- "TV", "INPUT1", "INPUT2", "INPUT3", "INPUT4" and "PC" modes can each store volume adjustment values separately.

When "Audio Out" is set to "Variable", the indicator on the screen changes as shown below.



#### Audio status

Output device	Audio out	
	Fixed	Variable
Speaker	Variable sound	Mute
MONITOR OUTPUT	Constant as specified	Variable sound

#### NOTE

- See page 56 for details on the Audio out function.

#### Using on the remote control unit

mutes the current sound output.

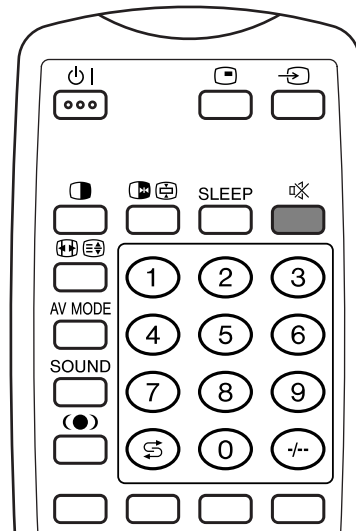

#### 1

Press .

- "" has been displayed on the screen for 30 minutes, and the sound is silenced.

#### Mute



#### NOTE

- Within 30 minutes of pressing , mute can be cancelled by using one of the two methods below.
  - Pressing - / +, **SOUND**, **CH▲/CH▼**, **0 - 9**, or can also cancel the mute.
  - Changing channels can also cancel the mute.
- **Mute will be cancelled after 30 minutes have elapsed. However, the System will not suddenly output a loud sound as the volume level is set to 0 automatically.**

#### 2

Within 30 minutes, Press again to cancel the mute.

- Before 30 minutes, the volume level returns to the previous setting.
- After 30 minutes, increase the volume level by pressing +.

## Watching TV

### Using (●) on the remote control unit

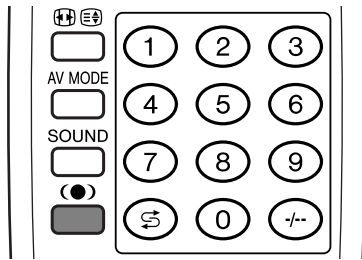

(●) produces SRS and FOCUS effect from the speakers.

Each time you press (●), the mode changes among SRS, FOCUS, FOCUS+SRS and OFF.

#### SRS sound options

- SRS (Sound Retrieval System): Creates more a natural sound retrieving the spatial information from any stereo recording and restoring the original three-dimensional sound field.
- FOCUS: Repositions a sound image from two speakers to a more optimal listening position or height without moving them.
- FOCUS+SRS: Produces both SRS and FOCUS effects.
- OFF: Outputs the normal sound.

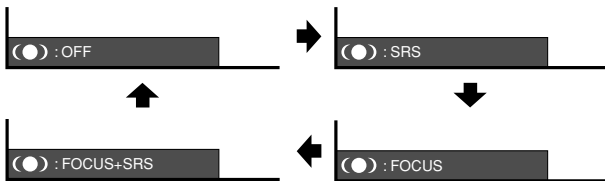

#### NOTE

- You can have the same settings by choosing "Surround" on the menu items. (See page 34.)

## Watching TV

### Using SOUND on the remote control unit

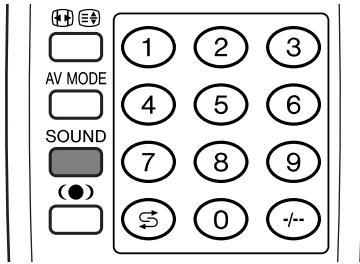

### In the NICAM TV broadcasts

#### When receiving a stereo signal

Each time you press **SOUND**, the mode switches between NICAM STEREO and MONO.

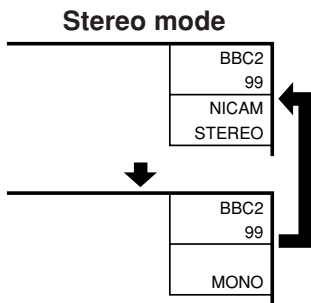

#### When receiving a bilingual signal

Each time you press **SOUND**, the mode switches among NICAM CH A, NICAM CH B, NICAM CH AB and MONO.

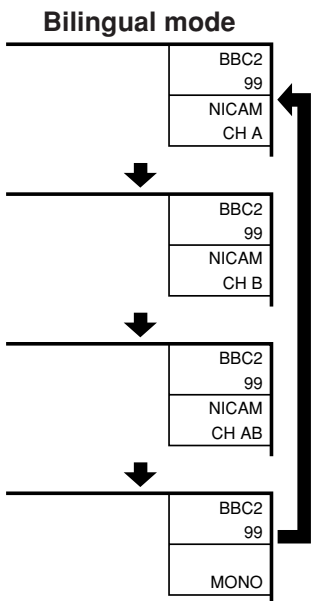

#### When receiving a monaural signal

Each time you press **SOUND**, the mode switches between NICAM MONO and MONO.

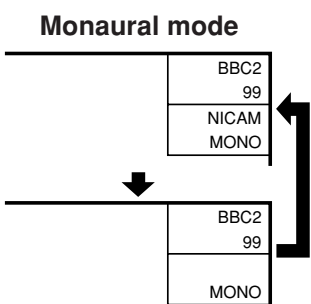

### In the TV mode of IGR TV broadcasts

#### When receiving a stereo signal

Each time you press **SOUND**, the mode switches between STEREO and MONO.

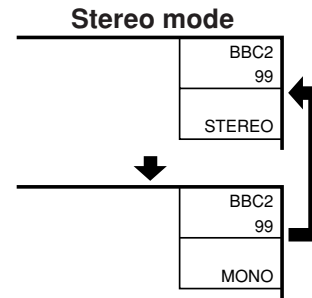

#### When receiving a bilingual signal

Each time you press **SOUND**, the mode switches among CH A, CH B and CH AB.

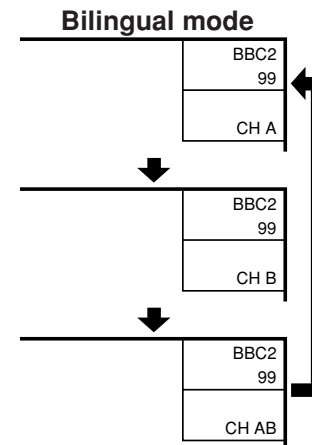

#### When receiving a monaural signal

When you press **SOUND**, "MONO" displays.

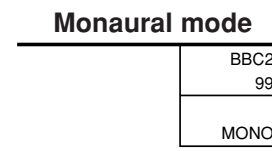

#### NOTE

- When no signal is input, the sound mode will display "MONO".
- "BBC2" and "99" are tentative network name and channel.

# Basic adjustment settings

## AV input mode menu items

List of AV menu items to help you with operations



Contrast .....	Page 29
Brightness .....	Page 29
Colour .....	Page 29
Tint .....	Page 29
Sharpness .....	Page 29
<b>Advanced</b>	
C.M.S. ....	Page 30
Colour Temp .....	Page 31
Black .....	Page 31
Monochrome .....	Page 32
Film Mode .....	Page 32
I/P Setting .....	Page 33
DNR .....	Page 33



Treble .....	Page 34
Bass .....	Page 34
Balance .....	Page 34
Surround .....	Page 34



Power Save .....	Page 35
No Signal Off .....	Page 36
No Operation Off .....	Page 36

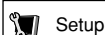

Auto Installation .....	Pages 20-21
Programme Setup .....	Pages 22-27
Child Lock .....	Page 58
Position .....	Page 45
WSS .....	Page 53
4:3 Mode .....	Page 53
Full Mode .....	Page 54
Rotate .....	Page 55
Language .....	Page 28
Text Lang. ....	Page 60

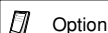

Input Select .....	Page 48
Audio Out .....	Page 56
Cool Climate .....	Page 57
Colour System .....	Page 49

## PC input mode menu items

List of PC menu items to help you with operations



Contrast .....	Page 29
Brightness .....	Page 29
Red .....	Page 29
Green .....	Page 29
Blue .....	Page 29
C.M.S. ....	Page 30



Treble .....	Page 34
Bass .....	Page 34
Balance .....	Page 34
Surround .....	Page 34



Power Save .....	Page 37
Power Management .....	Page 37

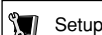

Input Signal .....	Page 52
Auto Sync. ....	Page 47
Fine Sync. ....	Page 47
Rotate .....	Page 55
Language .....	Page 28



Audio Out .....	Page 56
Cool Climate .....	Page 57

## Basic adjustment settings

### Auto installation

You can run auto installation, even after setting up the preset channels.

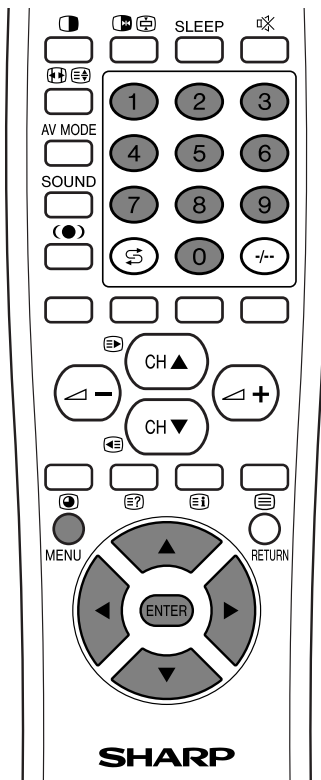

**1** Press **MENU** and the TV MENU screen displays.

**2** Press **◀/▶** to select "Setup".  
If you already set the password for child lock, go to step 3. If not, skip to step 4.  
• See page 58 for setting password.

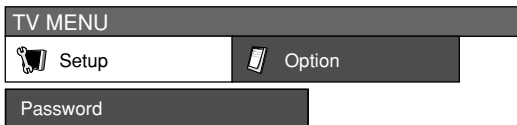

**3** Press **▲/▼** to select "Password", and then press **ENTER**.

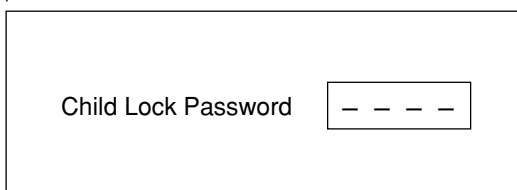

Enter your 4-digit password with **0 - 9** on the remote control unit.

**4**

Press **▲/▼** to select "Auto Installation", and then press **ENTER**.

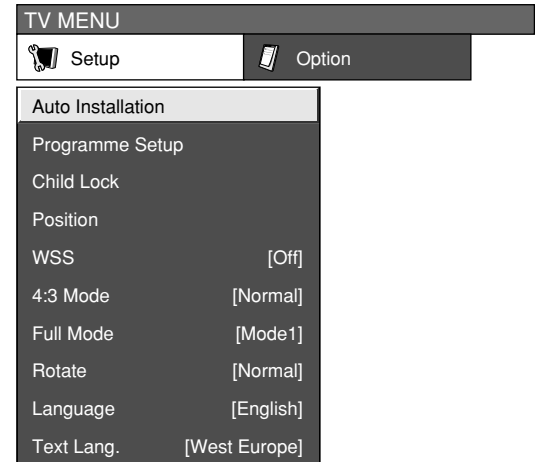

**5**

Press **◀/▶** to select "Yes", and then press **ENTER**.

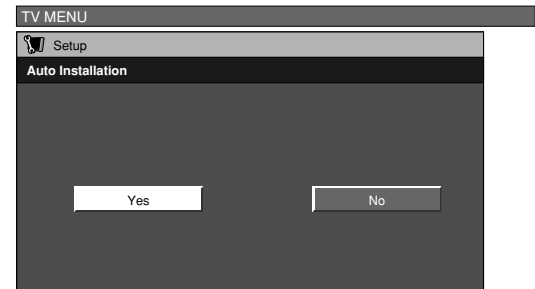

**6**

Press **▲/▼** to select the desired language listed on the screen, and then press **ENTER**.

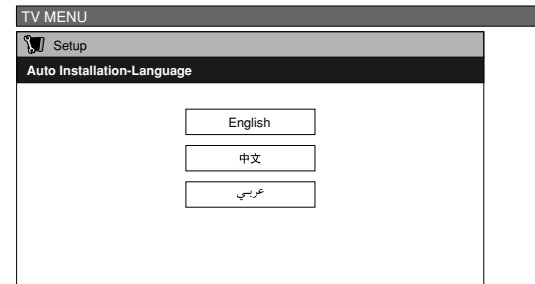

After this setting, auto search starts with the following order.

- ① Automatic channel searching
- ② Automatic channel labelling
- ③ Automatic channel sorting

You do not need to do anything during the auto search. (Go to the next page.)

#### NOTE

- The illustrations and on-screen displays in this manual are for explanation purposes and may vary slightly from the actual operations.

## Basic adjustment settings

### Automatic channel searching

Channel auto search finds all channels viewable in your area.

TV MENU

Setup

Auto Installation-Programme Setup "Auto"

01 55.25	02 85.25	03 102.25		

#### NOTE

- If no channel is found, "No programme found." displays. And the auto installation finishes.



### Automatic channel labelling

After finding TV channels, the System starts naming each TV channel found.

TV MENU

Setup

Auto Installation-Programme Setup "Auto"

01 SAT.1	02 PR07	03 KABEL		

#### NOTE

- The System can only name channels where the channel labelling information is provided. If channel information is not provided, the System displays "----".



### Automatic channel sorting

When channel auto labelling finishes, the System starts sorting the labelled channels.

TV MENU

Setup

Auto Installation-Programme Setup "Auto"

01 SAT.1	02 PR07	03 KABEL		

## Basic adjustment settings

### Programme setup

You can run the auto installation procedure again at any time, by accessing the Setup menu, then Programme Setup. Channels can be tuned automatically or manually.

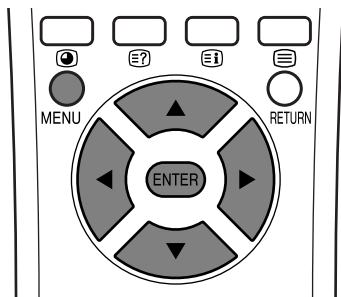

5

Press **◀/▶** to select “Yes”, and then press **ENTER**.

- Auto Search starts with the following order.
  - ① Automatic channel searching
  - ② Automatic channel labelling
  - ③ Automatic channel sorting

#### NOTE

- See page 21 for details.

### Auto search

You can also automatically search TV channels by performing the procedure below. This is the same function as from “Automatic channel searching” to “Automatic channel sorting” in auto installation on page 21.

1

Press **MENU** and the TV MENU screen displays.

2

Press **◀/▶** to select “Setup”.

- If password is already set, you are asked to enter it. Follow the same steps as explained in “Auto installation”. (See steps 2 and 3 on page 20.)

3

Press **▲/▼** to select “Programme Setup”, and then press **ENTER**.

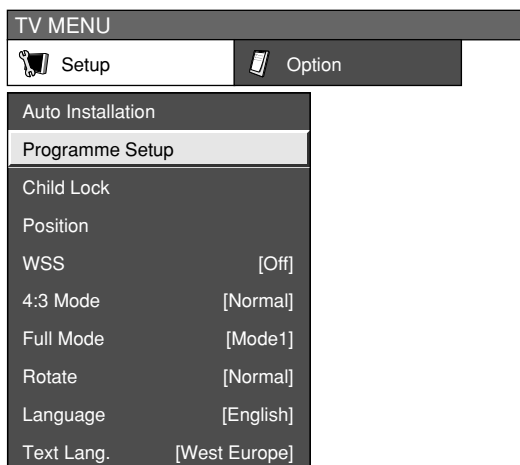

4

Press **▲/▼** to select “Auto Search”, and then press **ENTER**.

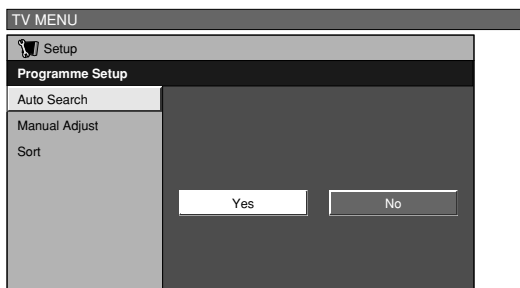

## Basic adjustment settings

### Manual setting for each channel

You can set some channel items manually. They are Search, Fine (TV frequency), Colour sys., Sound sys., Label (Network name), Skip and Lock (Child Lock).

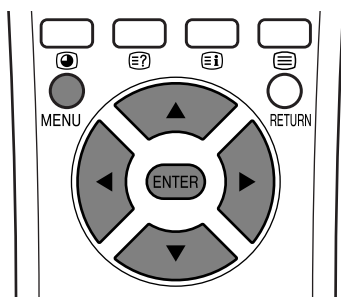

### Programme Setup "Manual" menu

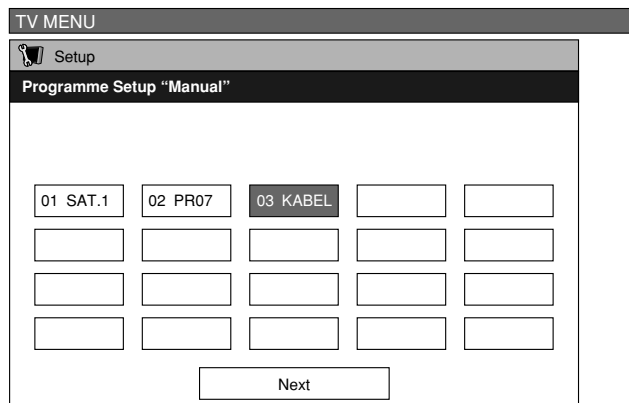

You can select one of the following settings.

1

Press **MENU** and the TV MENU screen displays.

2

Press **◀/▶** to select "Setup".

- If password is already set, you are asked to enter it. Follow the same steps as explained in "Auto installation". (See steps 2 and 3 on page 20.)

3

Press **▲/▼** to select "Programme Setup", and then press **ENTER**.

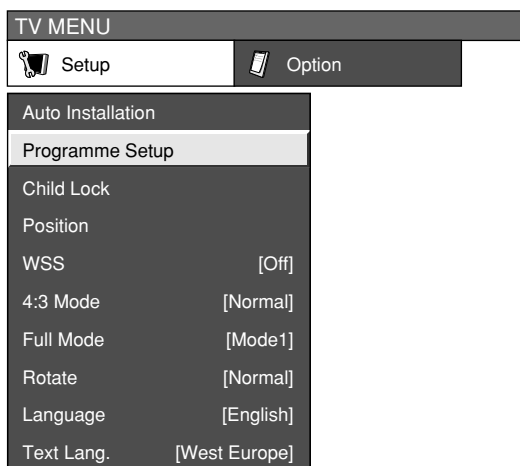

4

Press **▲/▼** to select "Manual Adjust", and then press **ENTER**.

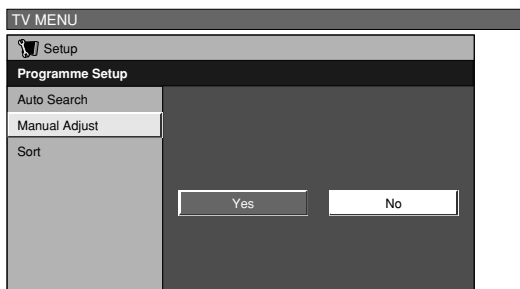

5

Press **◀/▶** to select "Yes", and then press **ENTER**.

- ① Search (See page 24.)
- ② Fine (See page 24.)
- ③ Colour system (See page 25.)
- ④ Sound system (See page 25.)
- ⑤ Label (See page 25.)
- ⑥ Skip (See page 26.)
- ⑦ Lock (See page 26.)



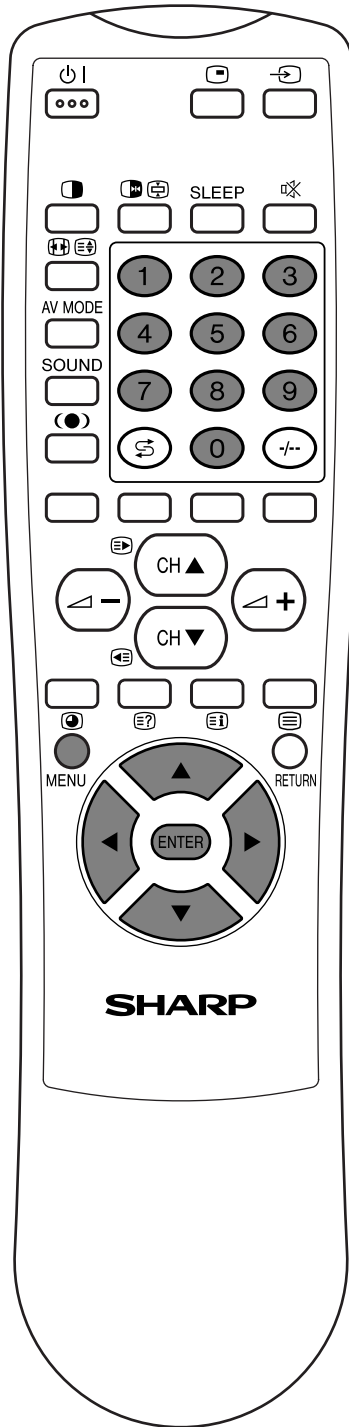

## Manual setting for each channel (continued)

### Search tuning

**1** Press **▲/▼/◀/▶** to select the channel you want to edit, and then press **ENTER**.

- The selected channel information displays.

**2** Press **▲/▼** to select "Search", and then press **ENTER**.

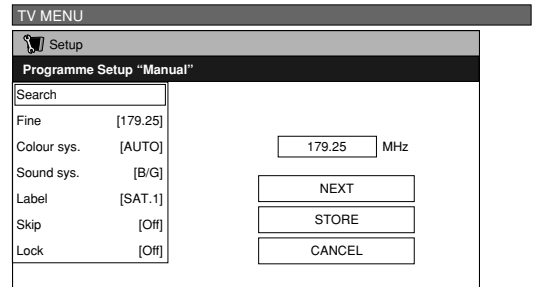

**3** Press **▲/▼** to select item and press **ENTER**.

- NEXT:** Search the next channel.
- STORE:** Memorise the current display channel.
- CANCEL:** Returns to the previous screen. (The search result is not stored.)

### Fine tuning

**1** Press **▲/▼/◀/▶** to select the channel you want to edit, and then press **ENTER**.

- The selected channel information displays.

**2** Press **▲/▼** to select "Fine", and then press **ENTER**.

**3** Press **◀/▶** to adjust the frequency, and then press **ENTER**.

- Adjust while checking the background picture as a reference.

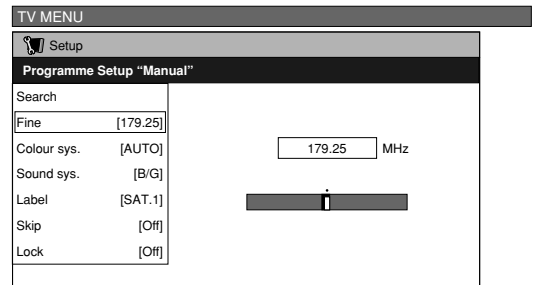

- Instead of the above, you can also set by directly entering the frequency number of the channel with **0 - 9**.

#### EXAMPLE

- 179.25 MHz: Press **1** → **7** → **9** → **2** → **5** → **ENTER**.
- 49.25 MHz: Press **4** → **9** → **2** → **5** → **ENTER**.

## Basic adjustment settings

### Manual setting for each channel (continued)

#### Colour system

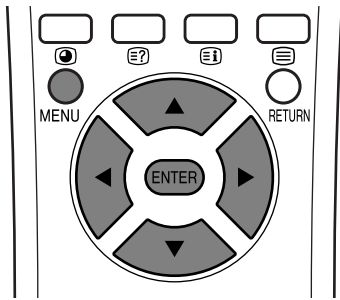

- 1 Press **▲/▼/◀/▶** to select the channel you want to edit, and then press **ENTER**.
  - The selected channel information displays.

- 2 Press **▲/▼** to select "Colour sys.", and then press **ENTER**.
  - Receivable colour systems are listed.

#### Colour system menu

TV MENU						
Setup						
Programme Setup "Manual"						
Search						
Fine	[179.25]					
Colour sys.	[AUTO] <table border="1" style="margin-left: 20px;"> <tr><td>AUTO</td></tr> <tr><td>PAL</td></tr> <tr><td>SECAM</td></tr> <tr><td>NTSC 3.58</td></tr> <tr><td>NTSC 4.43</td></tr> </table>	AUTO	PAL	SECAM	NTSC 3.58	NTSC 4.43
AUTO						
PAL						
SECAM						
NTSC 3.58						
NTSC 4.43						
Sound sys.	[B/G]					
Label	[SAT.1]					
Skip	[Off]					
Lock	[Off]					

- 3 Press **▲/▼** to select the optimum colour system, and then press **ENTER**.

#### Sound system (Broadcasting system)

- 1 Press **▲/▼/◀/▶** to select the channel you want to edit, and then press **ENTER**.
  - The selected channel information displays.

- 2 Press **▲/▼** to select "Sound sys.", and then press **ENTER**.
  - Receivable sound systems (Broadcasting systems) are listed.

#### Sound menu

TV MENU					
Setup					
Programme Setup "Manual"					
Search					
Fine	[179.25]				
Colour sys.	[AUTO]				
Sound sys.	[B/G] <table border="1" style="margin-left: 20px;"> <tr><td>B/G</td></tr> <tr><td>D/K</td></tr> <tr><td>I</td></tr> <tr><td>M</td></tr> </table>	B/G	D/K	I	M
B/G					
D/K					
I					
M					
Label	[SAT.1]				
Skip	[Off]				
Lock	[Off]				

- 3 Press **▲/▼** to select the optimum sound system, and then press **ENTER**.

#### NOTE

- If you adjust this setting, please check the colour system information. (See left column.)

#### Labelling channels

When a TV channel sends its Network Name, the auto installation detects the information and assigns a name to it. However, you can change individual channel names.

- 1 Press **▲/▼/◀/▶** to select the channel you want to edit, and then press **ENTER**.
  - The selected channel information displays.

- 2 Press **▲/▼** to select "Label", and then press **ENTER**.
  - Alphabets and numbers are listed.

#### Labelling menu

TV MENU						
Setup						
Programme Setup "Manual"						
Search						
Fine	[179.25]					
Colour sys.	[AUTO]					
Sound sys.	[B/G]					
Label	[SAT.1] <table border="1" style="margin-left: 20px;"> <tr><td> </td></tr> <tr><td>A B C D E F G H I J CLEAR</td></tr> <tr><td>K L M N O P Q R S T BACK</td></tr> <tr><td>U V W X Y Z + - . _</td></tr> <tr><td>0 1 2 3 4 5 6 7 8 9 END</td></tr> </table>		A B C D E F G H I J CLEAR	K L M N O P Q R S T BACK	U V W X Y Z + - . _	0 1 2 3 4 5 6 7 8 9 END
A B C D E F G H I J CLEAR						
K L M N O P Q R S T BACK						
U V W X Y Z + - . _						
0 1 2 3 4 5 6 7 8 9 END						
Skip	[Off]					
Lock	[Off]					

- 3 Press **▲/▼/◀/▶** to select each character of the new name for the channel, and then press **ENTER**.

- 4 Repeat the above until the name is fully spelt out.
  - The name can be 5 characters or less.

## Basic adjustment settings

### Manual setting for each channel (continued)

#### Skipping channels

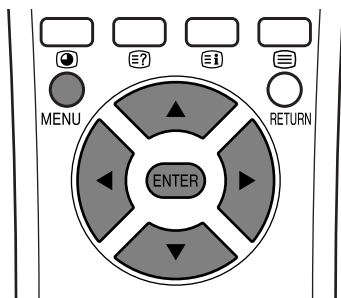

Channels with “Skip” set to “On” are passed over when using **CH▲/CH▼** even if selected while watching the image from the TV.

- 1 Press **▲/▼/◀/▶** to select the channel you want to edit, and then press **ENTER**.
  - The selected channel information displays.

- 2 Press **▲/▼** to select “Skip”, and then press **ENTER**.
  - Skip menu displays.

#### Skip menu

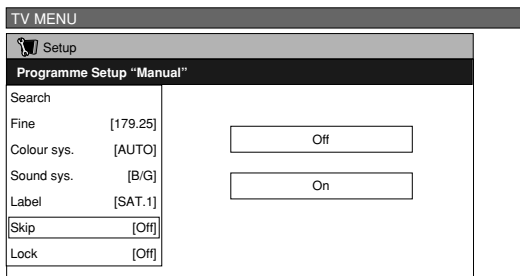

- 3 Press **▲/▼** to set “Skip” to “On”, and then press **ENTER**.

#### Setting the child lock

You can block the viewing of any channel.

- 1 Press **▲/▼/◀/▶** to select the channel you want to edit, and then press **ENTER**.
  - The selected channel information displays.
- 2 Press **▲/▼** to select “Lock”, and then press **ENTER**.
  - Child lock menu displays.

#### Lock menu

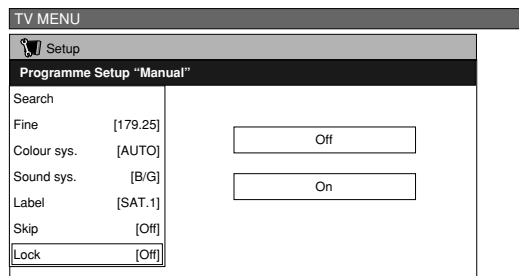

- 3 Press **▲/▼** to set “Lock” to “On”, and then press **ENTER**.

#### NOTE

- Even when this function is switched “On”, it will not work if a password has not been set. See page 58 for details on password setting.
- When “Lock” is set to “On” for a channel, “Child Lock Has Been Activated.” displays, and the image and sound of the channel is blocked.
- When pressing **ENTER** while “Child Lock Has Been Activated.” displays, password input menu will display. Inputting the correct password lifts the child lock temporarily until the power is turned off.

## Basic adjustment settings

### Sort

Channel positions can be sorted freely.

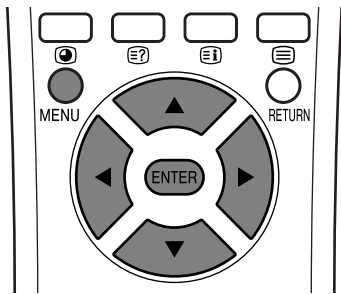

**1** Press **MENU** and the TV MENU screen displays.

**2** Press **◀/▶** to select "Setup".

- If password is already set, you are asked to enter it. Follow the same steps as explained in "Auto installation". (See steps 2 and 3 on page 20.)

**3** Press **▲/▼** to select "Programme Setup", and then press **ENTER**.

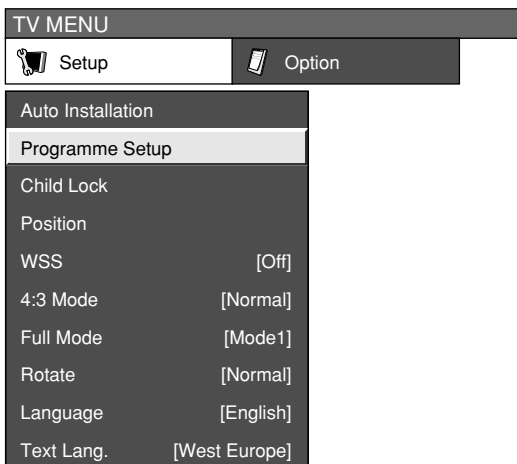

**4** Press **▲/▼** to select "Sort", and then press **ENTER**.

- The channels are listed. Black ones are set "Skip" to "Off" and blue are set "Skip" to "On".

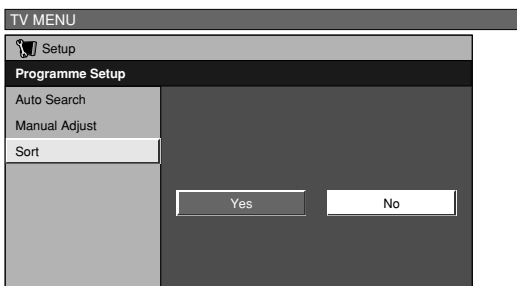

**5** Press **◀/▶** to select "Yes", and then press **ENTER**.

**6** Press **▲/▼/◀/▶** to select the channel you want to move, and then press **ENTER**.

**7** Move it to the desired position by pressing **▲/▼/◀/▶**, and then press **ENTER**.

**8** Repeat the steps 6 and 7 until all desired channels are sorted.

### Sort menus

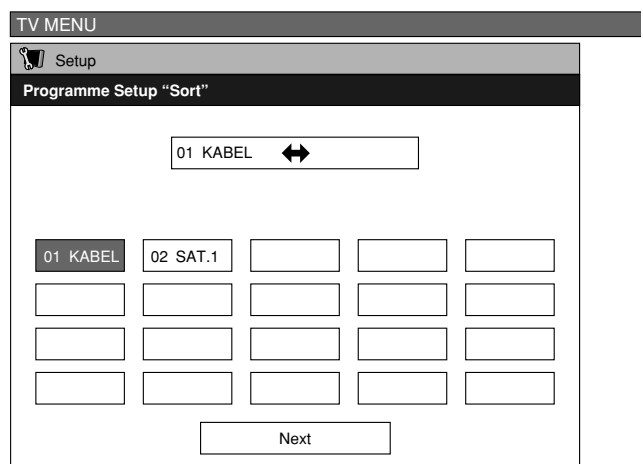
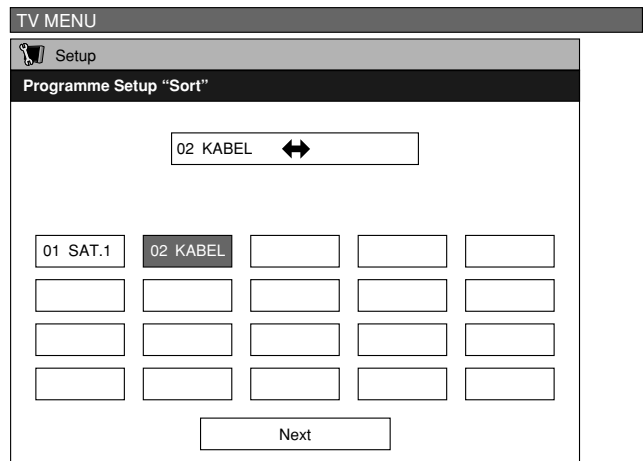
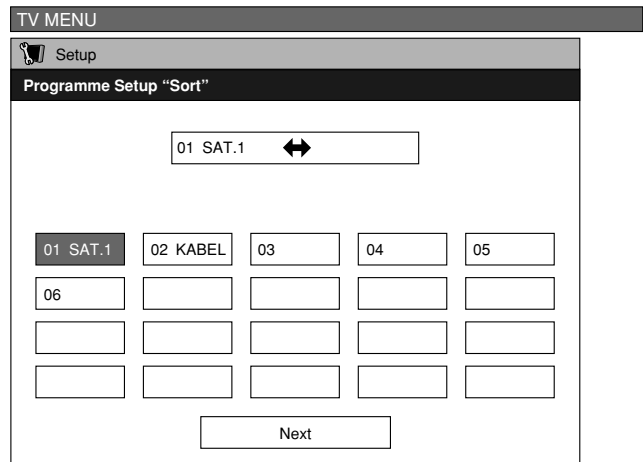

## Basic adjustment settings

### Language setting for on-screen display

You can also select a language from setup menu. Select from among 3 languages: English, Chinese and Arabic.

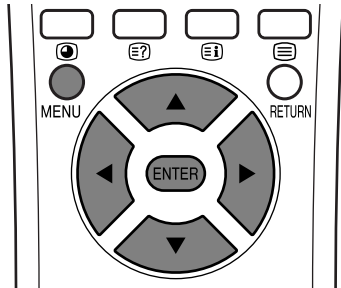

#### AV Input mode

**1** Press **MENU** and the TV MENU screen displays.

**2** Press **◀/▶** to select "Setup".

- If password is already set, you are asked to enter it. Follow the same steps as explained in "Auto installation". (See steps 2 and 3 on page 20.)

**3** Press **▲/▼** to select "Language", and then press **ENTER**.

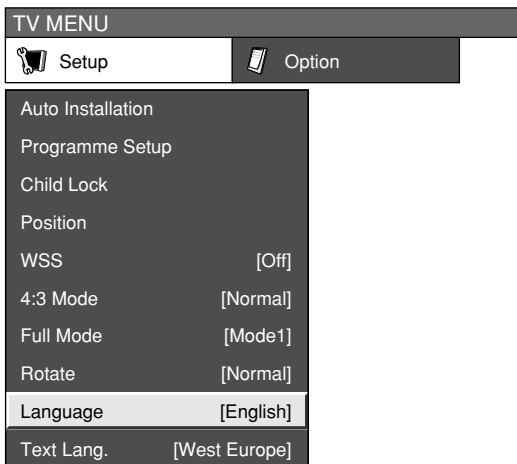

**4** Press **▲/▼** to select the desired language listed on the screen, and then press **ENTER**.

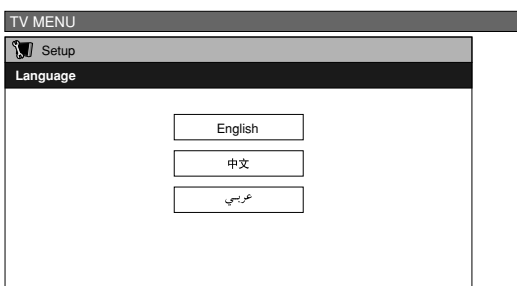

#### PC Input mode

**1** Press **MENU** and the PC MENU screen displays.

**2** Press **◀/▶** to select "Setup". Then you are asked to enter the password for child lock. (If you have not set the password yet, skip to step 3.)

- See page 58 for setting password.



Press **▲/▼** to select "Password", and then press **ENTER**.

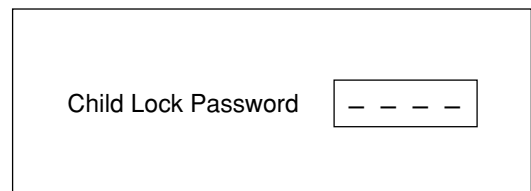

Enter your 4-digit password with **0-9** on the remote control unit.

**3** Press **▲/▼** to select "Language", and then press **ENTER**.



**4** Press **▲/▼** to select the desired language listed on the screen, and then press **ENTER**.

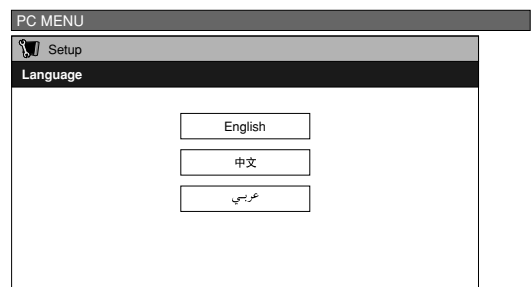

## Basic adjustment settings

### Picture adjustments

Adjust the picture to your preference with the following picture settings.

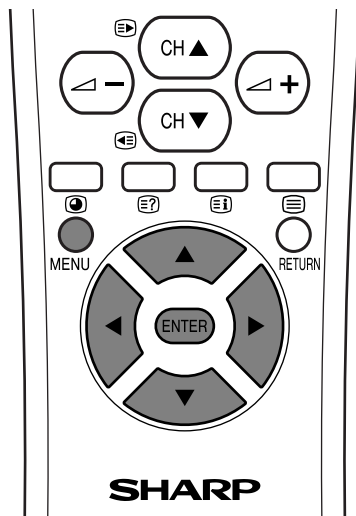

**1** Press **MENU** and the TV MENU (PC MENU) screen displays.

**2** Press **◀/▶** to select "Picture".  
• Picture menu displays.

**3** Press **▲/▼** to select a specific adjustment item.

**4** Press **◀/▶** to adjust the item to your desired position.

#### NOTE

- When all adjustments set to factory preset values,
  - Press **▲/▼** to select "Reset", and then press **ENTER**.
  - Press **◀/▶** to select "Yes", and then press **ENTER**.

#### Adjustments items for AV source

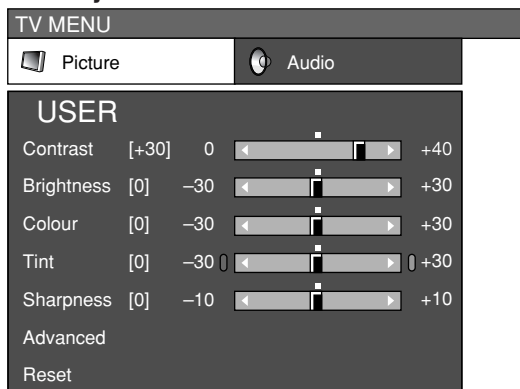

#### Adjustments items for PC source

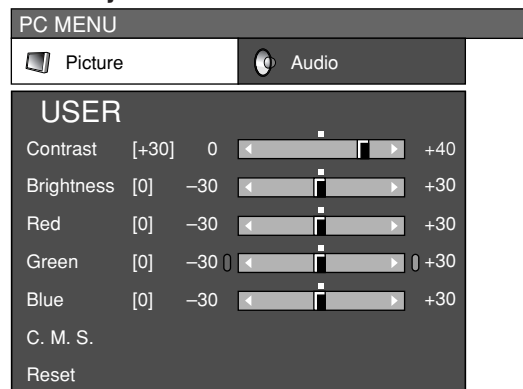

Selected item	◀button	▶button
<b>Contrast</b>	For less contrast	For more contrast
<b>Brightness</b>	For less brightness	For more brightness
<b>Colour</b>	For less colour intensity	For more colour intensity
<b>Tint</b>	Skin tones become purplish	Skin tones become greenish
<b>Sharpness</b>	For less sharpness	For more sharpness

Selected item	◀button	▶button
<b>Contrast</b>	For less contrast	For more contrast
<b>Brightness</b>	For less brightness	For more brightness
<b>Red</b>	For weaker red	For stronger red
<b>Green</b>	For weaker green	For stronger green
<b>Blue</b>	For weaker blue	For stronger blue

#### NOTE

- Select "Advanced" and then press **ENTER** to set "C.M.S.", "Colour Temp", "Black", "Monochrome", "Film Mode", "I/P Setting" or "DNR". See pages 30 to 33.

## Basic adjustment settings

### C.M.S. (Colour Management System)

Colour tone is managed using the six-colour adjustment setting.

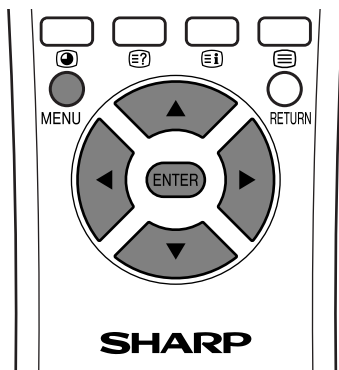

#### AV input mode

**1** Press **MENU** and the TV MENU screen displays.

**2** Press **◀/▶** to select "Picture".  
• Picture menu displays.

**3** Press **▲/▼** to select "Advanced", and then press **ENTER**.



**4** Press **▲/▼** to select "C.M.S.", and then press **ENTER**.

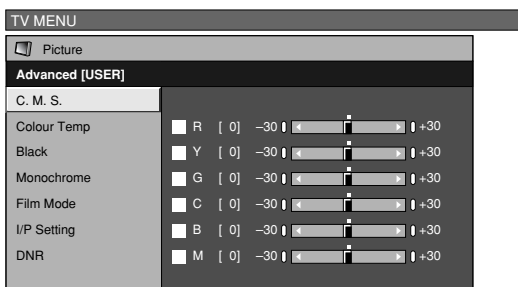

**5** Press **▲/▼** to select a specific adjustment item.

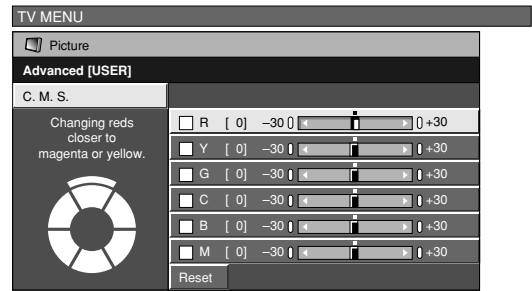

**6** Press **◀/▶** to adjust the item to your desired position.

#### NOTE

- For resetting all adjustment items to the factory preset values, press **▲/▼** to select "Reset", and then press **ENTER**.

#### PC input mode

**1** Press **MENU** and the PC MENU screen displays.

**2** Press **◀/▶** to select "Picture".  
• Picture menu displays.

**3** Press **▲/▼** to select "C.M.S.", and then press **ENTER**.

**4** Press **▲/▼** to select a specific adjustment item.

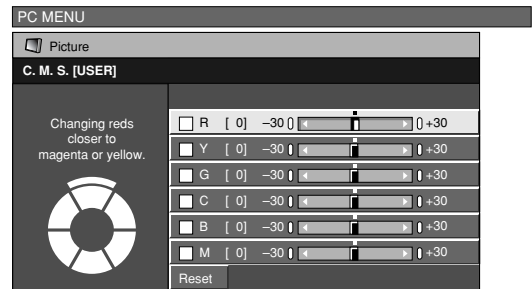

**5** Press **◀/▶** to adjust the item to your desired position.

#### NOTE

- For resetting all adjustment items to the factory preset values, press **▲/▼** to select "Reset", and then press **ENTER**.

## Basic adjustment settings

### Colour temperature

Adjusts the colour temperature to give the best white image.

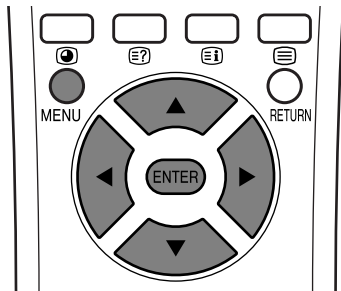

**1** Press **MENU** and the TV MENU screen displays.

**2** Press **◀/▶** to select "Picture".  
• Picture menu displays.

**3** Press **▲/▼** to select "Advanced", and then press **ENTER**.



**4** Press **▲/▼** to select "Colour Temp", and then press **ENTER**.

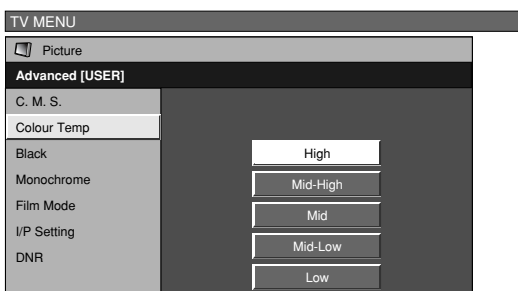

**5** Press **▲/▼** to select the desired level, and then press **ENTER**.

Selected item	Description
High	White with Bluish tone ↑ ↓ White with Reddish tone
Mid-High	
Mid	
Mid-Low	
Low	

### Black

Allows you to select a level for automatic adjustment of a black areas of the image to suit viewing conditions.

**1** Press **MENU** and the TV MENU screen displays.

**2** Press **◀/▶** to select "Picture".  
• Picture menu displays.

**3** Press **▲/▼** to select "Advanced", and then press **ENTER**.



**4** Press **▲/▼** to select "Black", and then press **ENTER**.

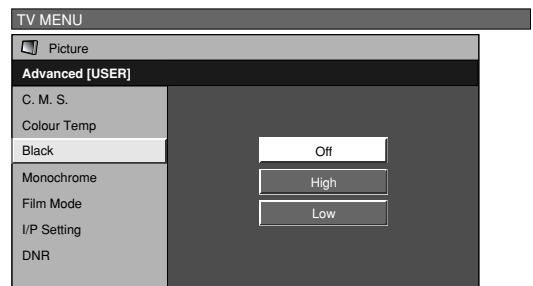

**5** Press **▲/▼** to select the desired level, and then press **ENTER**.



## Basic adjustment settings

### Monochrome

For viewing a video in monochrome.

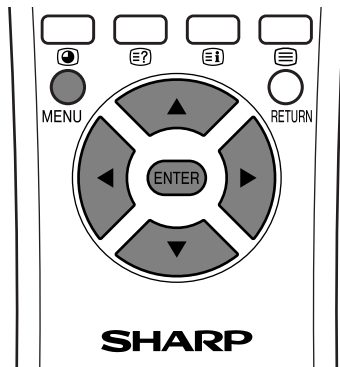

**1** Press **MENU** and the TV MENU screen displays.

**2** Press **◀/▶** to select "Picture".  
• Picture menu displays.

**3** Press **▲/▼** to select "Advanced", and then press **ENTER**.



**4** Press **▲/▼** to select "Monochrome", and then press **ENTER**.

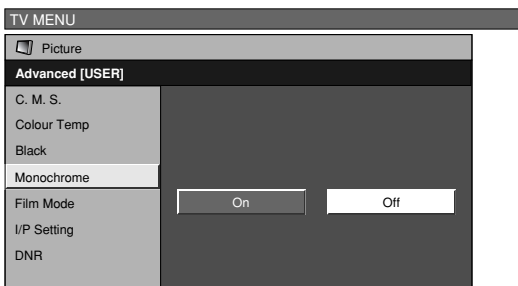

**5** Press **◀/▶** to select "On", and then press **ENTER**.

### Film mode

Automatically detects a film-based source (originally encoded at 24 frames/second), analyses it then recreates each still film frame for high-definition picture quality.

**1** Press **MENU** and the TV MENU screen displays.

**2** Press **◀/▶** to select "Picture".  
• Picture menu displays.

**3** Press **▲/▼** to select "Advanced", and then press **ENTER**.



**4** Press **▲/▼** to select "Film Mode", and then press **ENTER**.

• Some items may be greyed out. They are not selectable.

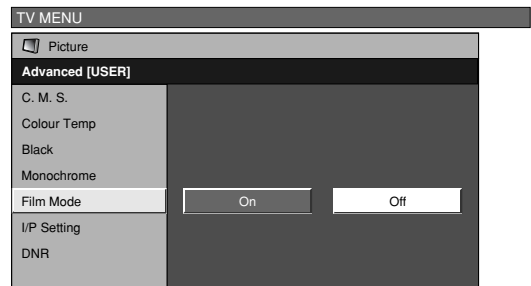

**5** Press **◀/▶** to select "On", and then press **ENTER**.

#### NOTE

• Set the Film Mode to "On" manually to detect a film-based source (originally encoded 24 frames/second) when input source has vertical frequency of 50 Hz (e.g. PAL, SECAM etc.) .

## Basic adjustment settings

### I/P setting

Adjusting the image and input signal can give you a more beautiful picture.

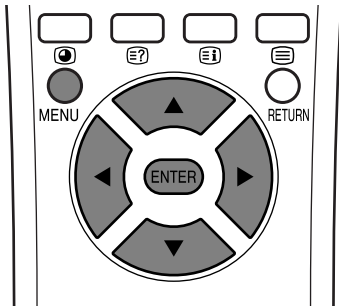

**1** Press **MENU** and the TV MENU screen displays.

**2** Press **◀/▶** to select "Picture".  
• Picture menu displays.

**3** Press **▲/▼** to select "Advanced", and then press **ENTER**.

**4** Press **▲/▼** to select "I/P Setting", and then press **ENTER**.  
• Some items may be greyed out. They are not selectable.

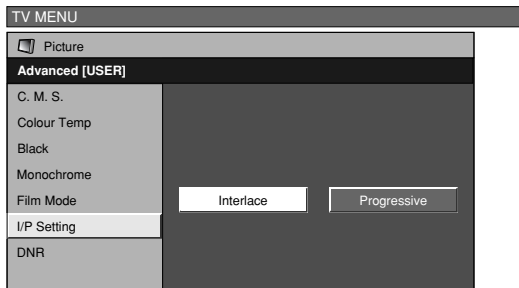

**5** Press **◀/▶** to select "Interlace" or "Progressive", and then press **ENTER**.

#### NOTE

- The I/P Setting is set to Progressive when Film Mode is "On".

### DNR (Digital Noise Reduction)

Produces a clearer video image.

**1** Press **MENU** and the TV MENU screen displays.

**2** Press **◀/▶** to select "Picture".  
• Picture menu displays.

**3** Press **▲/▼** to select "Advanced", and then press **ENTER**.



**4** Press **▲/▼** to select "DNR", and then press **ENTER**.  
• Some items may be greyed out. They are not selectable.

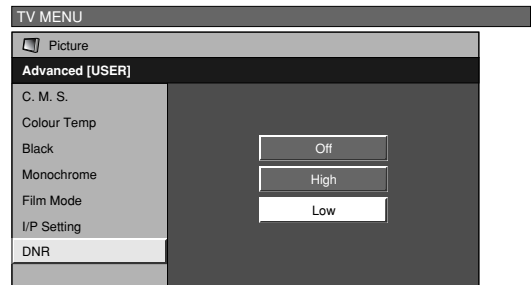

**5** Press **▲/▼** to select the desired level, and then press **ENTER**.

## Basic adjustment settings

### Audio adjustment

#### Sound adjustment

You can adjust the sound quality to your preference with the following settings.

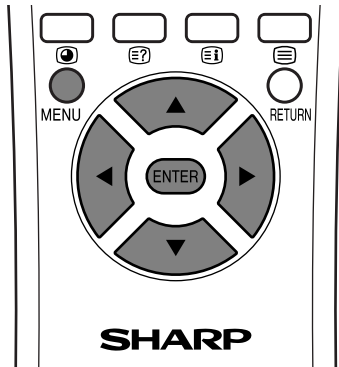

**1** Press **MENU** and the TV MENU (PC MENU) screen displays.

**2** Press **◀/▶** to select "Audio".  
• Audio menu displays.

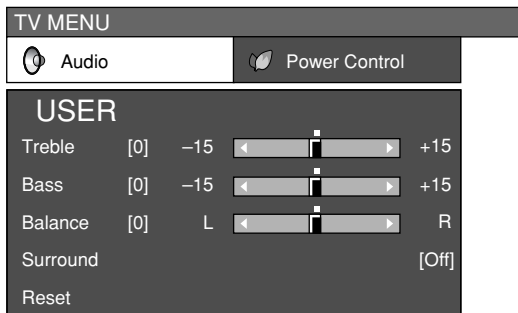

**3** Press **▲/▼** to select a specific adjustment item.

**4** Press **◀/▶** to adjust the item to your desired position.

Selected item	◀ button	▶ button
<b>Treble</b>	For weaker treble	For stronger treble
<b>Bass</b>	For weaker bass	For stronger bass
<b>Balance</b>	Decrease audio from the right speaker	Decrease audio from the left speaker

#### NOTE

- For resetting all adjustment items to factory preset values, press **▲/▼** to select "Reset", press **ENTER**, press **◀/▶** to select "Yes", and then press **ENTER**.

### Surround

You can also produce SRS and FOCUS effects from the "Audio" setting.

**1** Press **MENU** and the TV MENU (PC MENU) screen displays.

**2** Press **◀/▶** to select "Audio".  
• Audio menu displays.

**3** Press **▲/▼** to select "Surround", and then press **ENTER**.

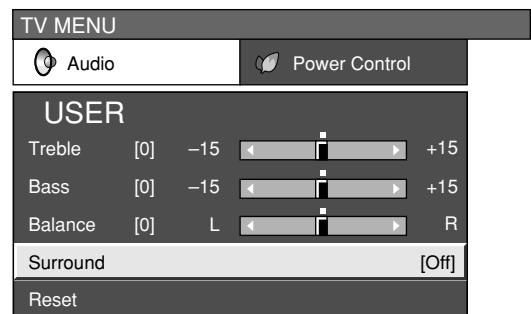

**4** Press **▲/▼** to select the desired level, and then press **ENTER**.

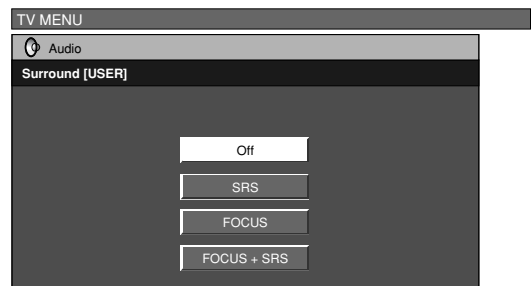

#### NOTE

- You can choose SRS and FOCUS by pressing **●** on the remote control unit. See page 17 for SRS and FOCUS.

## Basic adjustment settings

### Power Control

Power Control setting allows you to reduce the display brightness to save energy.

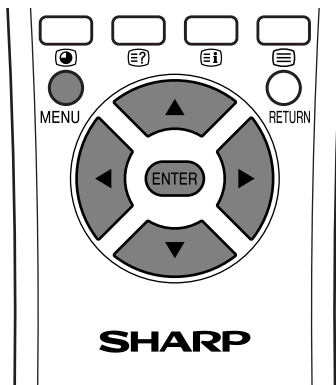

Selected item	Description
<b>Save1</b>	The screen darkens slightly to conserve power consumption.
<b>Save2</b>	The screen darkens more significantly to conserve power consumption.
<b>Auto</b>	Backlight brightness adjusts according to the ambient light of the room to conserve power consumption.

#### NOTE

- When setting to "Auto", the OPC indicator lights up green, senses the surrounding light and automatically adjusts the backlight brightness. Make sure no object obstructs the OPC sensor, which could affect its ability to sense surrounding light.
- Power Save can be set differently for AV input mode and PC input mode.

### Power Control for AV source

#### Power save

When set to "Save1", "Save2", or "Auto", power consumption is reduced by decreasing backlight brightness.

**1** Press **MENU** and the TV MENU screen displays.

**2** Press **◀/▶** to select "Power Control".

- Power Control menu displays.

**3** Press **▲/▼** to select "Power Save", and then press **ENTER**.

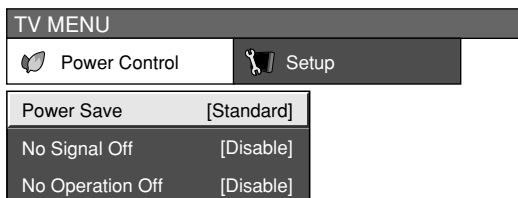

**4** Press **▲/▼** to select the desired backlight brightness, and then press **ENTER**.

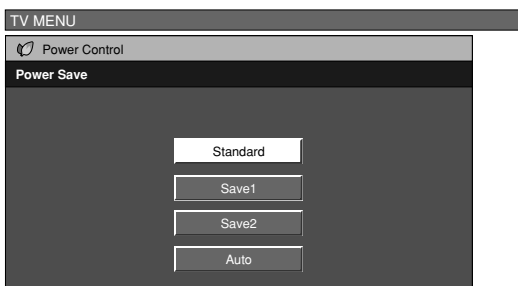

## Basic adjustment settings

### No Signal Off

When set to "Enable", the power will automatically shut down if no signal inputs for 15 minutes.

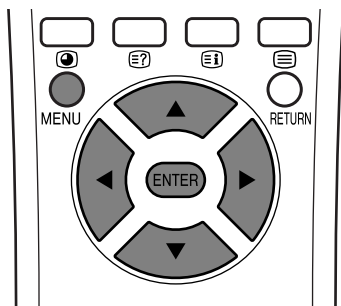

**1** Press **MENU** and the TV MENU screen displays.

**2** Press **◀/▶** to select "Power Control".

- Power Control menu displays.

**3** Press **▲/▼** to select "No Signal Off", and then press **ENTER**.

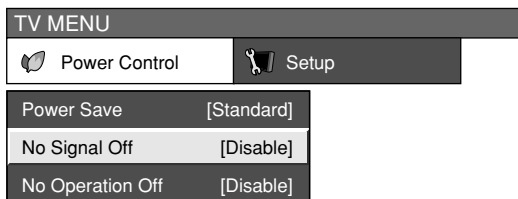

**4** Press **◀/▶** to select "Enable", and then press **ENTER**.



- Five minutes before the power shuts down, remaining time displays every minute.

#### NOTE

- "Disable" is factory preset value.
- When a TV programme finishes, and the AVC System receives signal input, this function may not operate.

### No Operation Off

When set to "Enable", the power will automatically shut down if there is no operation for 3 hours.

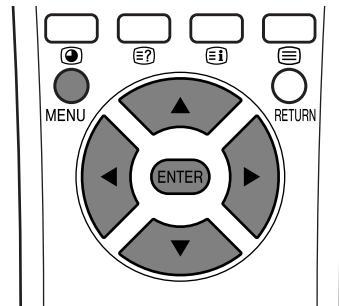

**1** Press **MENU** and the TV MENU screen displays.

**2** Press **◀/▶** to select "Power Control".

- Power Control menu displays.

**3** Press **▲/▼** to select "No Operation Off", and then press **ENTER**.

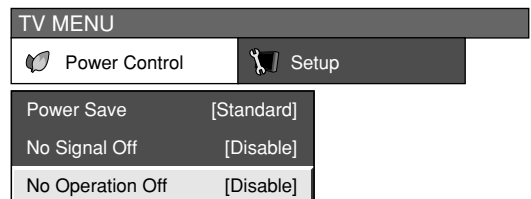

**4** Press **◀/▶** to select "Enable", and then press **ENTER**.

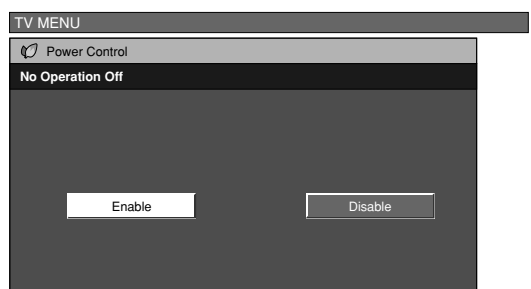

- Five minutes before the power shuts down, remaining time displays every minute.

#### NOTE

- "Disable" is factory preset value.

## Basic adjustment settings

### Power Control for PC source

Power Control allows you to reduce display brightness and save energy.

#### Power save

When set to "Save1", "Save2", or "Auto", power consumption is reduced by decreasing backlight brightness.

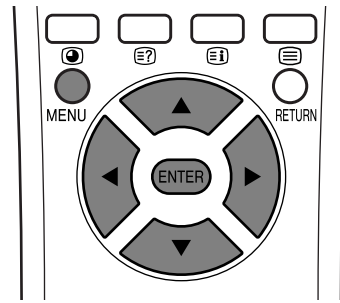

**1** Press **MENU** and the PC MENU screen displays.

**2** Press **◀/▶** to select "Power Control".

- Power Control menu displays.

**3** Press **▲/▼** to select "Power Save", and then press **ENTER**.

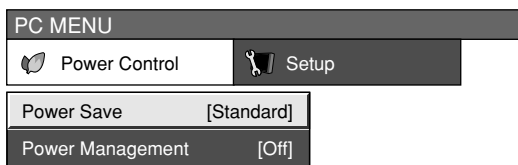

**4** Press **▲/▼** to select the desired backlight brightness, and then press **ENTER**.

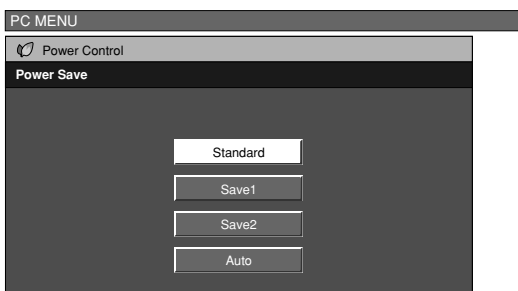

Selected item	Description
<b>Save1</b>	The screen darkens slightly to conserve power consumption.
<b>Save2</b>	The screen darkens more significantly to conserve power consumption.
<b>Auto</b>	Backlight brightness adjusts according to the ambient light of the room to conserve power consumption.

#### NOTE

- When setting to "Auto", the OPC indicator lights up green, senses the surrounding light and automatically adjusts the backlight brightness. Make sure no object obstructs the OPC sensor, which could affect its ability to sense surrounding light.
- Power Save can be set differently for AV input mode and PC input mode.

### Power management

When set, the power will automatically shut down.

**1** Press **MENU** and the PC MENU screen displays.

**2** Press **◀/▶** to select "Power Control".

- Power Control menu displays.

**3** Press **▲/▼** to select "Power Management", and then press **ENTER**.

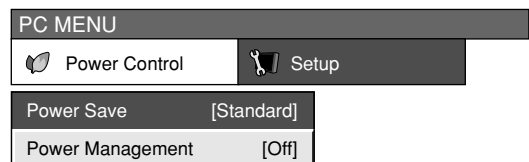

**4** Press **▲/▼** to select "Mode1" or "Mode2", and then press **ENTER**.

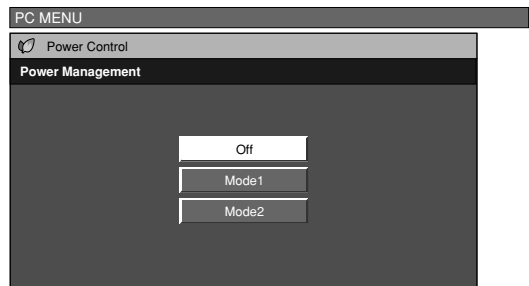

Selected item	Description
<b>Off</b>	<ul style="list-style-type: none"> <li>• No power management</li> <li>• Factory preset value.</li> </ul>
<b>Mode1</b>	<ul style="list-style-type: none"> <li>• If no signal inputs for 8 minutes, the power shuts down.</li> <li>• Even if you start using the PC and the signal inputs again, the System stays off.</li> <li>• The System turns on again by pressing <b>⏻</b> (STANDBY/ON) button on the Display or <b>⏻</b> on the remote control unit. (See page 14.)</li> </ul>
<b>Mode2</b>	<ul style="list-style-type: none"> <li>• If no signal inputs for 8 seconds, the power shuts down.</li> <li>• When you start using the PC and the signal inputs again, the System turns on.</li> </ul>

# Using external equipment

You can connect many types of external equipment to your System, like a VCR, DVD player, HDTV tuner, PC, game console and camcorder. To view external source images, select the input source from  on the remote control unit or **INPUT** on the Display.

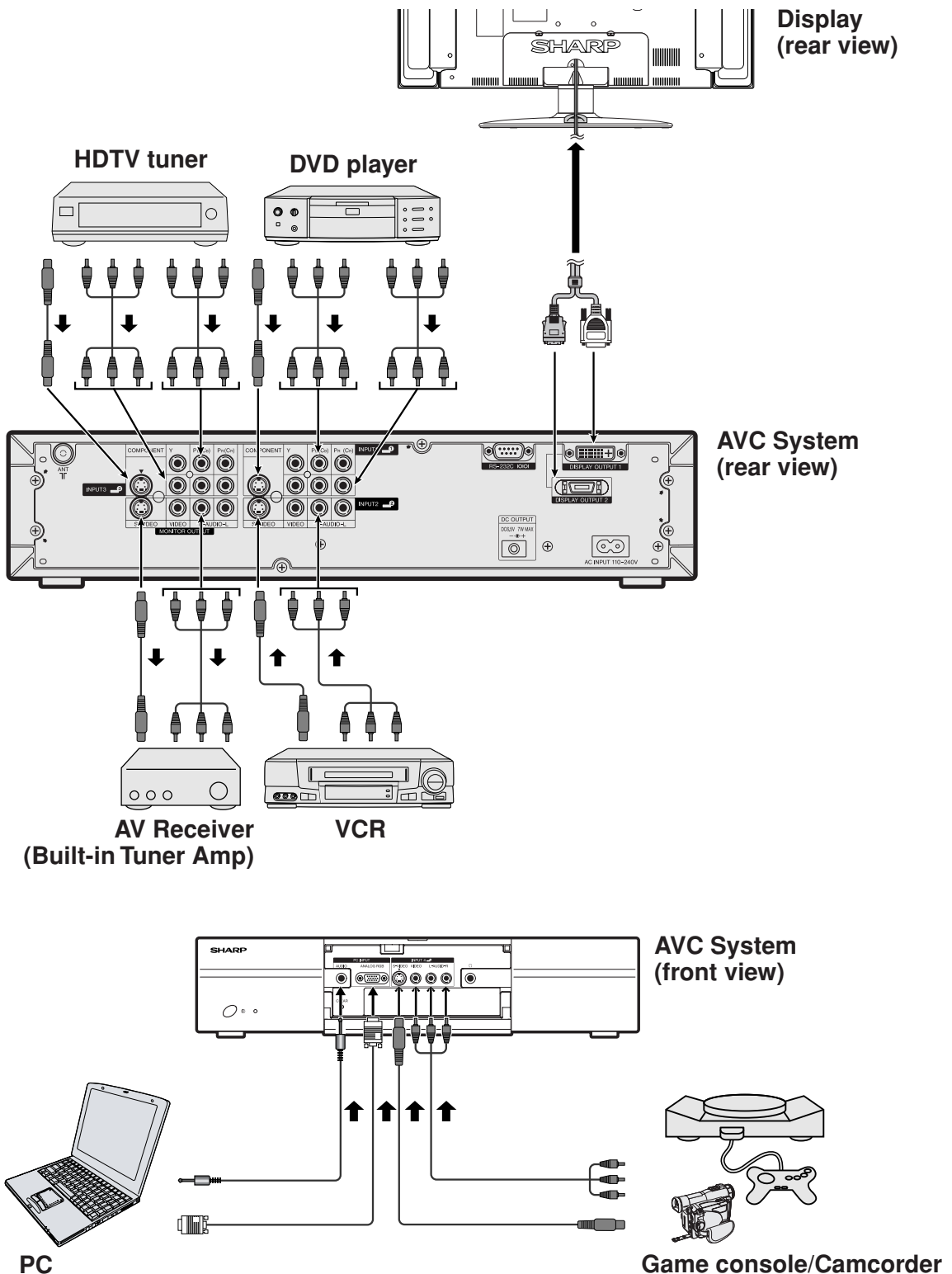

## CAUTION

- To protect all equipment, always turn off the AVC System before connecting to a VCR, DVD player, HDTV tuner, PC, game console, camcorder or other external equipment.

## NOTE

- Please refer to the relevant operation manual (DVD player, PC, etc.) carefully before making connections.

## Using external equipment

### Watching a DVD image

#### Connecting a DVD player

You can use the INPUT 1 terminal when connecting to a DVD player and other audiovisual equipment.

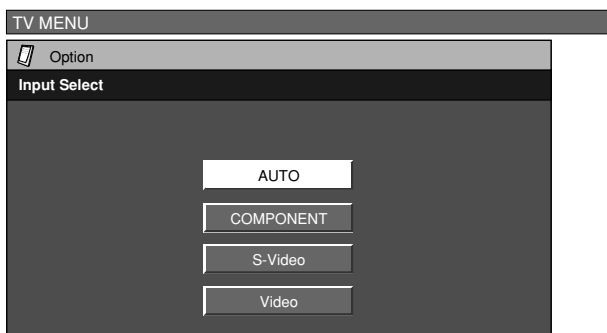
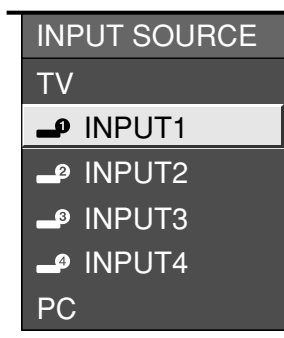
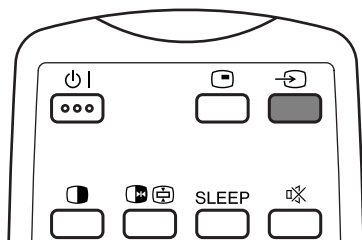
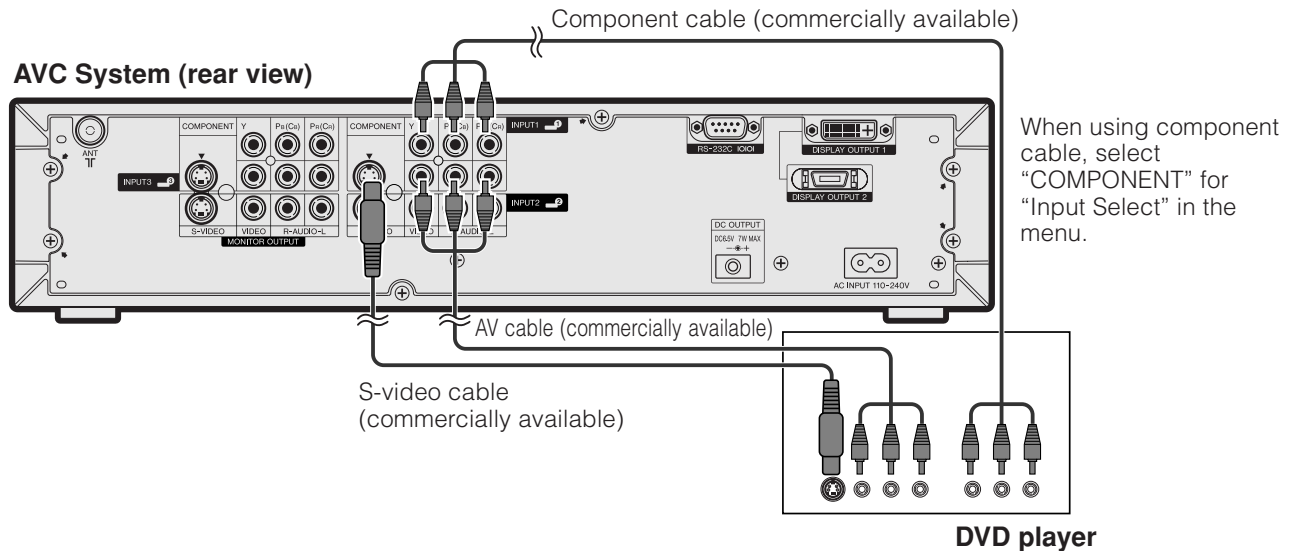

(For INPUT1 signal)

### Displaying a DVD image

To watch a DVD image, select "INPUT1" from "INPUT SOURCE" menu using  $\rightarrow$  on the remote control unit or **INPUT** on the Display.

Then select "INPUT1" on "Input Select" in the menu to set the correct input signal type. (See page 48.)

The setting is stored and can be selected in the "INPUT SOURCE" menu.

#### NOTE

- Each time  $\rightarrow$  is pressed, the input source toggles.
- If the DVD image does not come in clearly, you may need to change the input signal type setting on the "Input Select" menu.
- Refer to your DVD player operation manual for the signal type.



## Using external equipment

### Watching a VCR image

#### Connecting a VCR

You can use the INPUT 2 terminal when connecting a VCR and other audiovisual equipment.

#### AVC System (rear view)

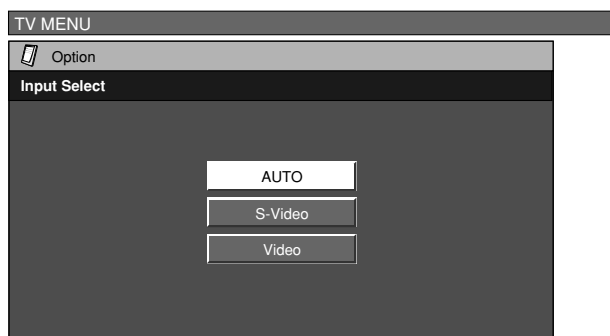
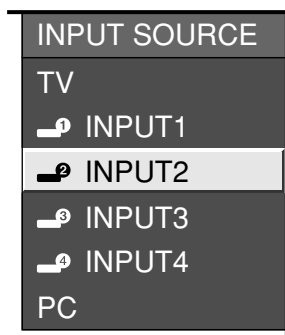
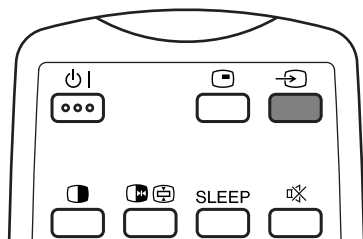
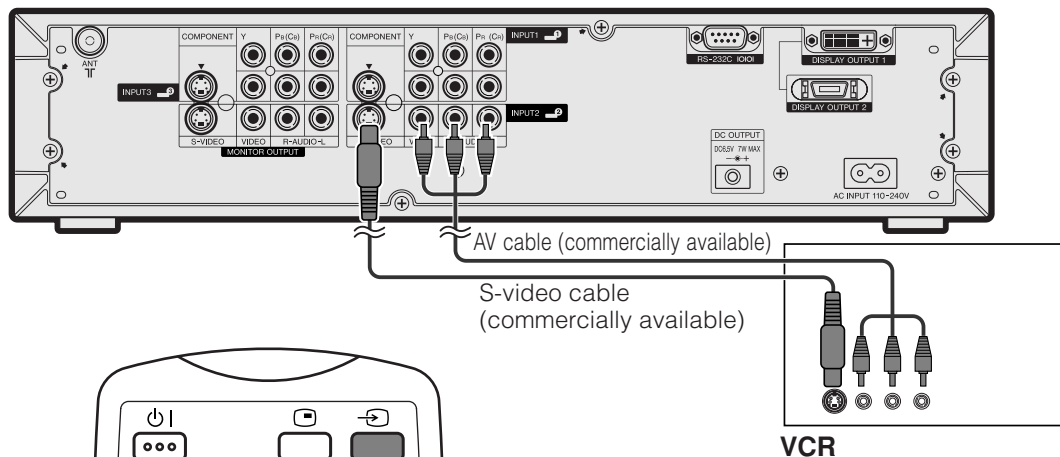

(For INPUT2 signal)

#### Displaying a VCR image

To watch a VCR image, select "INPUT2" from the "INPUT SOURCE" menu using on the remote control unit or **INPUT** on the Display.

Then select "INPUT2" on "Input Select" in the menu to set the correct input signal type. (See page 48.)

The setting is stored and can be selected in the "INPUT SOURCE" menu.

#### NOTE

- Each time is pressed, the input source toggles.
- If the VCR image does not come in clearly, you may need to change the input signal type setting on the "Input Select" menu.
- Refer to your VCR operation manual for the signal type.

## Using external equipment

### Watching broadcasts via an HDTV tuner

#### Connecting an HDTV tuner

You can use the INPUT 3 terminal when connecting an HDTV tuner and other audiovisual equipment.

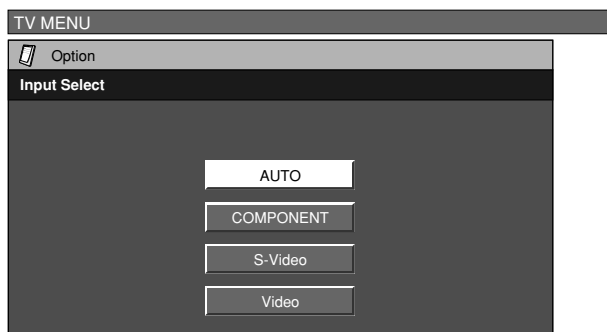
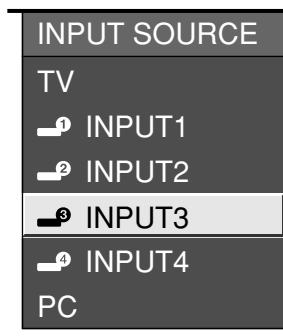
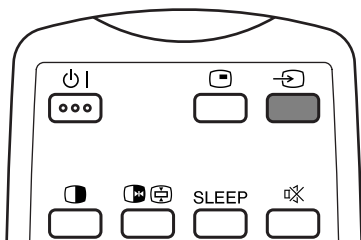
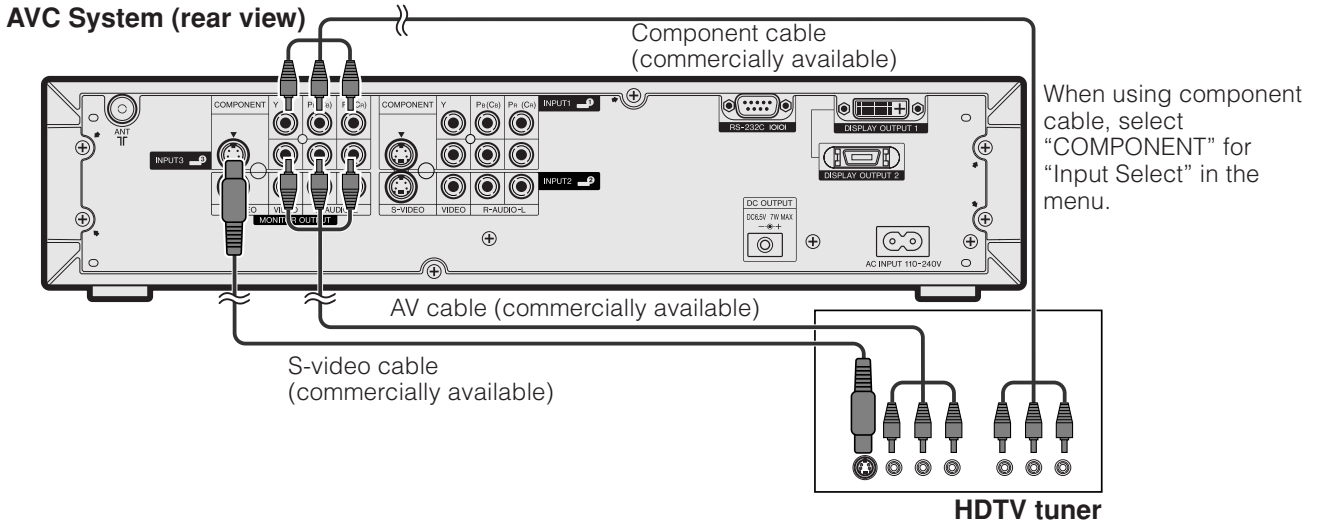

(For INPUT3 signal)

#### Displaying broadcasts via an HDTV tuner

To watch an HDTV tuner image, select "INPUT3" from "INPUT SOURCE" menu using on the remote control unit or **INPUT** on the Display.

Then select "INPUT3" on "Input Select" in the menu to set the correct input signal type. (See page 48.)

The setting is stored and can be selected in the "INPUT SOURCE" menu.

#### NOTE

- Each time is pressed, the input source toggles.
- If the HDTV tuner image does not come in clearly, you may need to change the input signal type setting on the "Input Select" menu.

## Using external equipment

### Enjoying a game console and viewing camcorder images

#### Connecting a game console or camcorder

A game console, camcorder and some other audiovisual equipment are conveniently connected using the INPUT 4 terminals.

#### NOTE

- The S-video terminal has priority over the video terminals.

#### AVC System (front view)

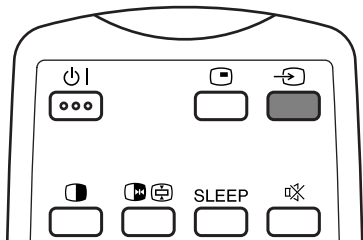
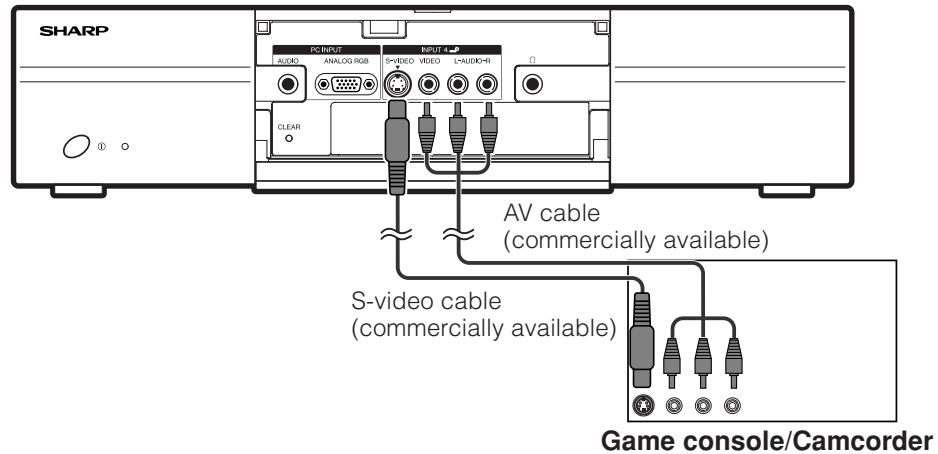

#### Displaying an image of the game console or camcorder

To connect a game console or view a camcorder, select "INPUT4" from the "INPUT SOURCE" menu using  on the remote control unit or **INPUT** on the Display.

Then select "INPUT4" on "Input Select" in the menu to set the correct input signal type. (See page 48.)

The setting is stored and can be selected on the "INPUT SOURCE" menu.

#### NOTE

- Each time  is pressed, the input source toggles.

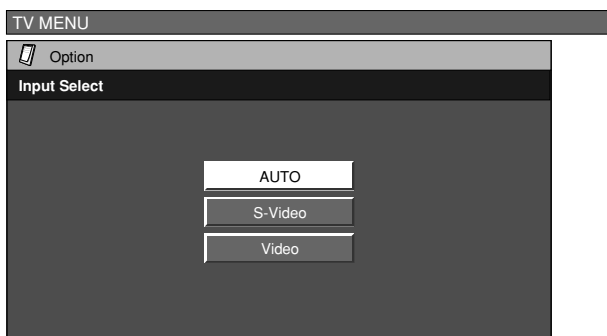
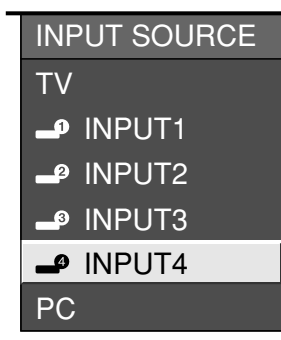

(For INPUT4 signal)

## Using external equipment

### Viewing an image from a PC

#### Connecting a PC

Use the PC terminals to connect a PC.

#### NOTE

- The PC input terminals are DDC1/2B-compatible.
- Refer to page 65 for a list of PC signals compatible with the System.

#### AVC System (front view)

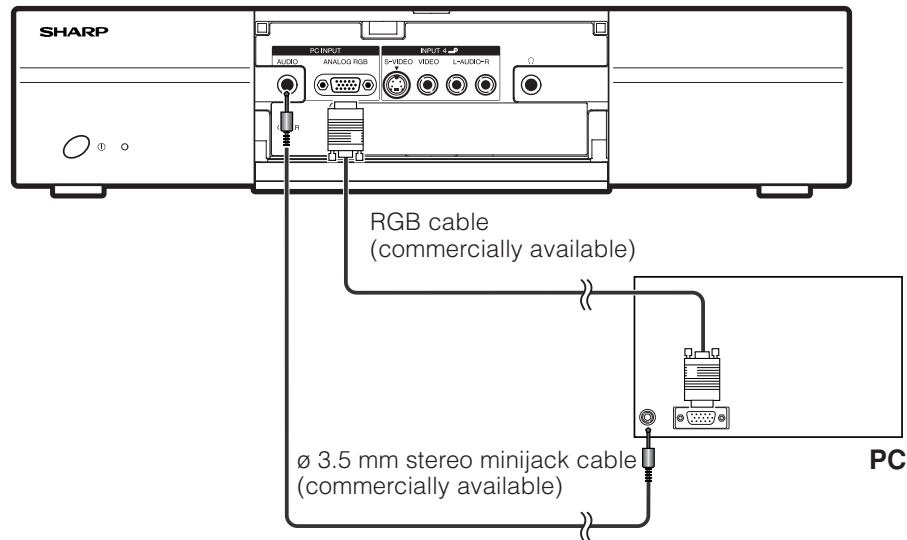

#### Signal names for 15-pin mini D-sub connector

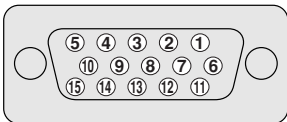

Pin No.	Signal name	Pin No.	Signal name	Pin No.	Signal name
①	R	⑥	GND (Ground)	⑪	Not connected
②	G	⑦	GND (Ground)	⑫	SDA
③	B	⑧	GND (Ground)	⑬	HD
④	Not connected	⑨	+5V	⑭	VD
⑤	CSYNC	⑩	GND (Ground)	⑮	SCL

#### NOTE

- Macintosh adaptor may be required for use for some Macintosh computers.

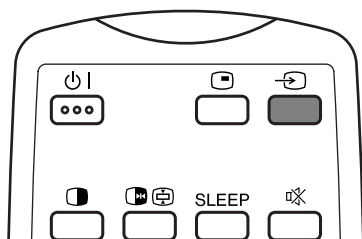

#### Displaying an image from a PC

To view an image from a PC, select "PC" from the "INPUT SOURCE" menu using on the remote control unit or **INPUT** on the Display.

When connecting to a PC, the correct input signal type is automatically detected. (See page 52.) If the PC image does not come in clearly, you may need to set the Auto Sync. adjustment in the "Setup" menu. (See page 47.)

#### NOTE

- Each time is pressed, the input source toggles.

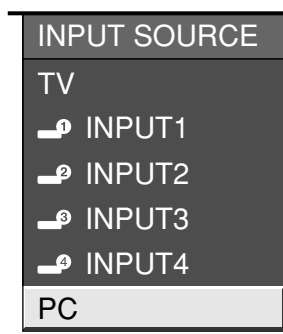

## Using external equipment

### Removing the speakers

#### This unit has detachable type speakers.

You can detach the system speakers when using external amplifier/speakers.

Before detaching (or attaching) speakers, unplug the AC cord from the AC outlet.

#### Before attaching/detaching speakers

- Before performing work, make sure to turn off the System.
- Before performing work, spread cushioning over a flat surface to lay the Display on. This will prevent it from being damaged.

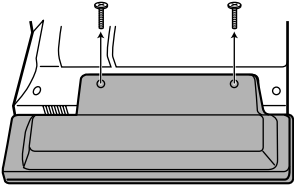
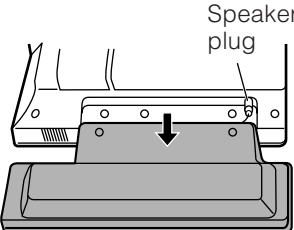
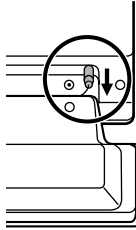
<p><b>1</b></p>  <p>Unfasten the screws used to secure the speakers in place.</p>	<p><b>2</b></p>  <p>Take hold of the speaker and slowly slide it sideways. (The speaker plug is still inserted, so make sure not to pull the speaker too far.)</p>	<p><b>3</b></p>  <p>Remove the speaker plug from the terminal on the Display. (Do not remove the plug by pulling the cord.) Now the speaker can be detached from the Display.</p>
--	---	--

#### CAUTION

- The speaker terminals on the Display is only for the attached speakers. Do not connect any third party plug or speaker to the terminal.
- Insert the speaker plug completely into the terminal.
- Do not handle or move the Display by the speakers.

#### NOTE

- Perform the same steps for both left and right speakers.
- To attach the speakers, perform the above steps in reverse order.

# Useful adjustment settings

## Image position (AV input mode only)

For adjusting a picture's horizontal and vertical position.

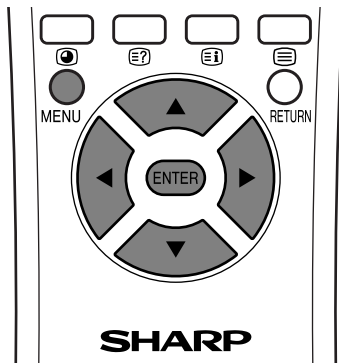

### NOTE

- For resetting all adjustment items to the factory preset values, press ▲/▼ to select "Reset", and then press **ENTER**.
- **Adjustments are stored separately according to input source.**
- You can easily move the image position as shown on page 46, but when the power is switched off the image will return to the previously memorised position.

Selected item	Description
<b>H-Pos.</b>	Centres the image by moving it to the left or right.
<b>V-Pos.</b>	Centres the image by moving it up or down.

**1** Press **MENU** and the TV MENU screen displays.

**2** Press ◀/▶ to select "Setup".

- If password is already set, you are asked to enter it. Follow the same steps as explained in "Auto installation". (See steps 2 and 3 on page 20.)

**3** Press ▲/▼ to select "Position", and then press **ENTER**.

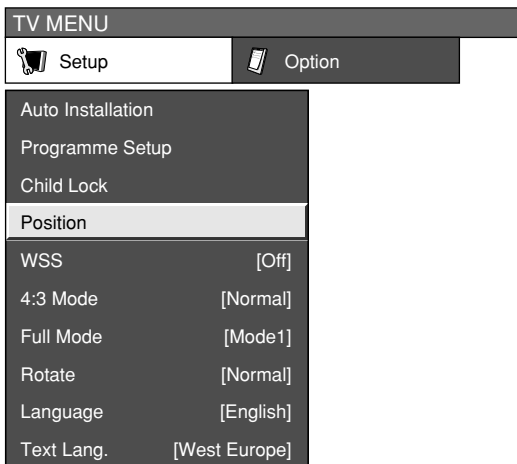

**4** Press ▲/▼ to select "H-Pos." or "V-Pos.".



**5** Press ◀/▶ to adjust the item to your desired position.

### Moving the picture on the screen

You can move the picture around on the screen.

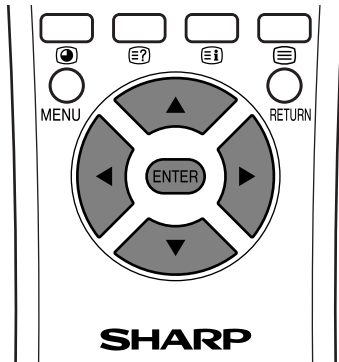

Press ▲/▼/◀/▶ to move an image on the screen to the desired position. Press **ENTER** to return to the initial image position.

#### NOTE

- While pressing ▲/▼/◀/▶, an on-screen image, "Adjusting Position" displays to the desired position.
- This setting cannot be stored. Once the System shuts down or enters standby mode, the setting is erased. To move the picture around the screen again, you must perform the above procedure again.
- The image position setting using the steps on page 45 can be stored. Select either according to your objectives.
- "TV", "INPUT1", "INPUT2", "INPUT3" and "INPUT4" can each adjust the image position setting on this page. The same for WIDE modes.
- An on-screen image from a PC source cannot be moved around.
- Even when the image fills the screen, its position can be adjusted with this function.

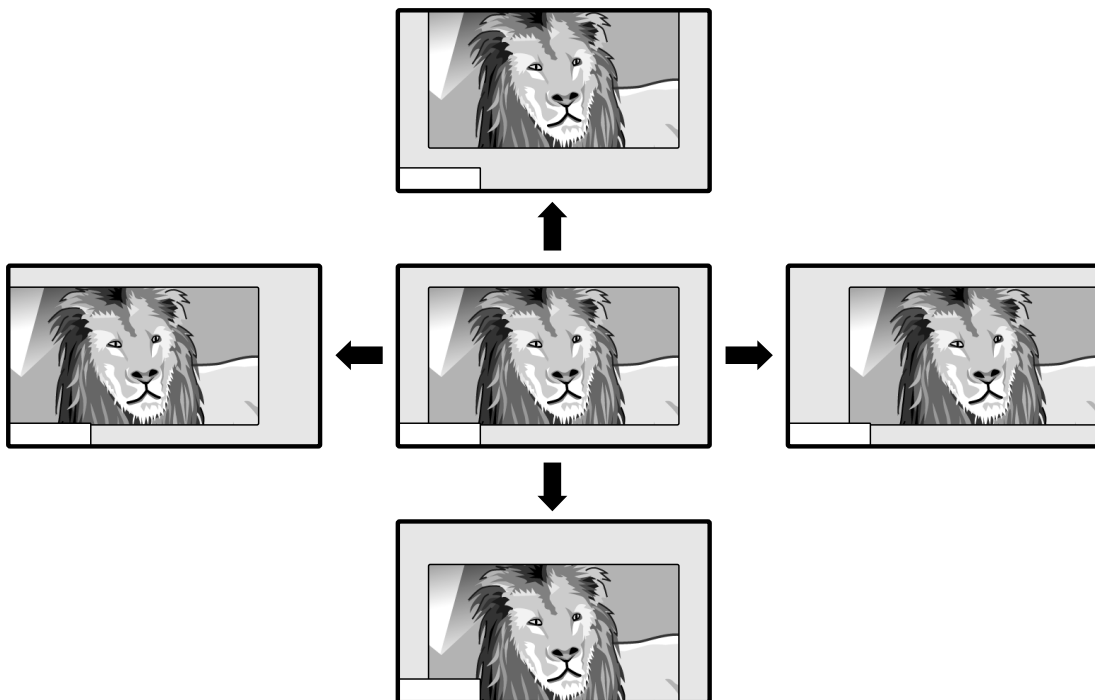

## Useful adjustment settings

### Auto Sync. adjustment (PC input mode only)

For automatically adjusting the PC image.

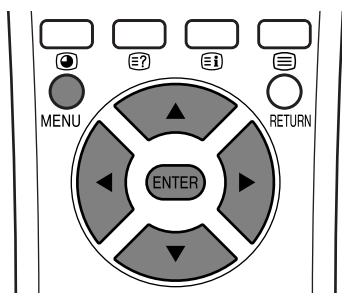

**1** Press **MENU** and the PC MENU screen displays.

**2** Press **◀/▶** to select "Setup".  
• Setup menu displays.

**3** Press **▲/▼** to select "Auto Sync.", and then press **ENTER**.

**4** Press **◀/▶** to select "Yes", and then press **ENTER**.  
• Auto Sync. starts and "Adjusting the image" displays.

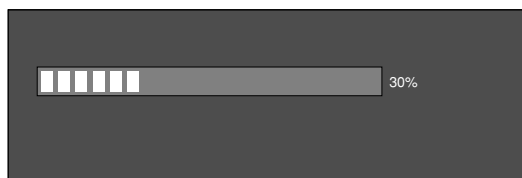
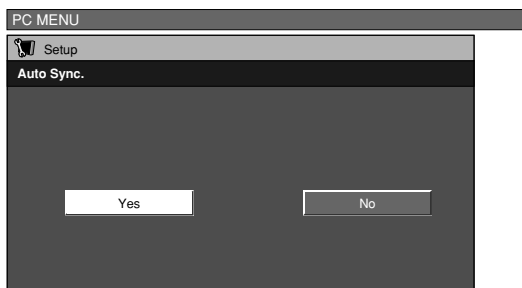

#### NOTE

- When Auto Sync. is successful, "Auto Sync. completed successfully" displays. If not, Auto Sync. failed.
- Auto Sync. may fail even if "Auto Sync. completed successfully" displays.
- Auto Sync. is likely to succeed when an input PC image has wide vertical stripes (ex. pattern with high contrast stripes, or cross-hatched). It may fail when an input PC image is solid (low contrast).
- Be sure to connect the PC to the AVC System and switch it on before starting Auto Sync.

### Fine Sync. adjustment (PC input mode only)

Ordinarily you can easily adjust the picture as necessary to change image position using Auto Sync. In some cases, however, manual adjustment is needed to optimise the image.

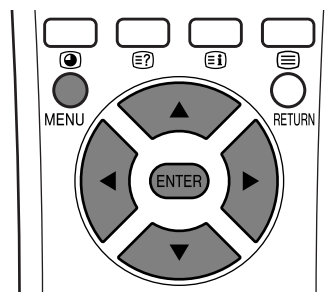

**1** Press **MENU** and the PC MENU screen displays.

**2** Press **◀/▶** to select "Setup".  
• If password is already set, you are asked to enter it. Follow the same step as explained in "Language setting for on-screen display (PC input mode)". (See step 2 on page 28.)

**3** Press **▲/▼** to select "Fine Sync.", and then press **ENTER**.

**4** Press **▲/▼** to select the specific adjustment item.

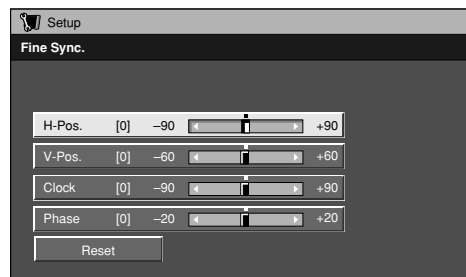

**5** Press **◀/▶** to adjust the item to your desired position.

#### NOTE

- For resetting all adjustment items to the factory preset values, press **▲/▼** to select "Reset", and then press **ENTER**.

Selected item	Description
<b>H-Pos.</b>	Centres the image by moving it to the left or right.
<b>V-Pos.</b>	Centres the image by moving it to up or down.
<b>Clock</b>	Adjusts the clock frequency.
<b>Phase</b>	Adjusts the clock phase.



## Useful adjustment settings

### Input signal source

#### Input selection

Can use for selecting the input source.

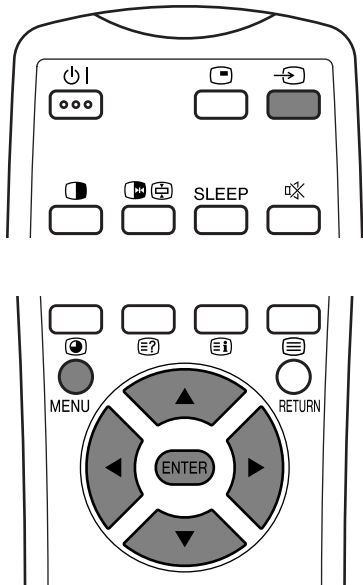

- 1 Press on the remote control unit or **INPUT** on the Display.
  - INPUT SOURCE menu displays.

- 2 Press on the remote control unit or **INPUT** on the Display to select the input source.
  - An image from the selected source automatically displays.
  - You can also select the input source by pressing **▲/▼**.

#### NOTE

- Some items may be greyed out. They are not selectable.

#### Input signal setting

For setting the signal type of external equipment.

- 1 Press **MENU** and the TV MENU screen displays.

- 2 Press **◀/▶** to select "Option".
  - Option menu displays.

- 3 Press **▲/▼** to select "Input Select", and then press **ENTER**.

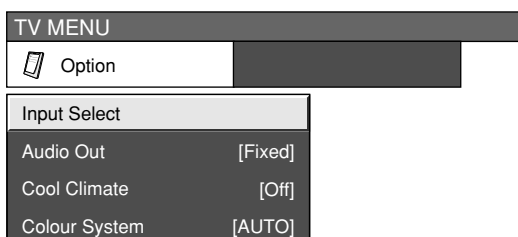

4

Press **▲/▼** to select a signal type you want to set, and then press **ENTER**.

- If the selected signal type is incorrect, an image does not display or no colour image displays.

#### For INPUT 1 signal

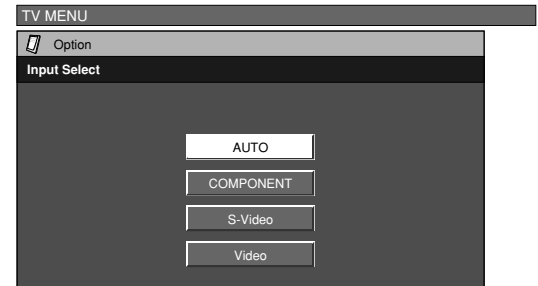

#### For INPUT 2 signal

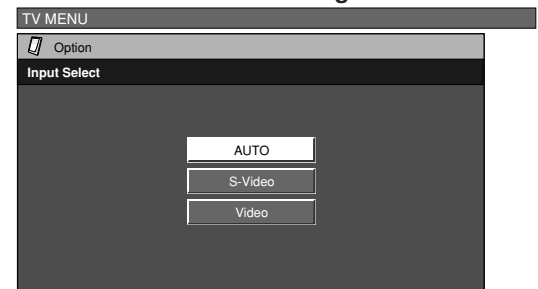

#### For INPUT 3 signal

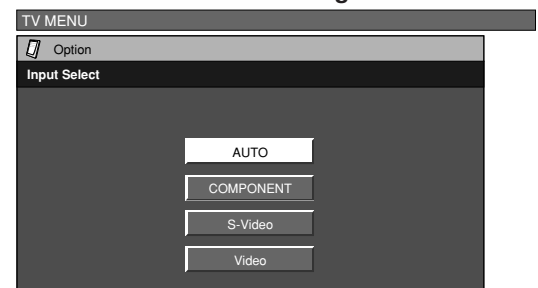

#### For INPUT 4 signal

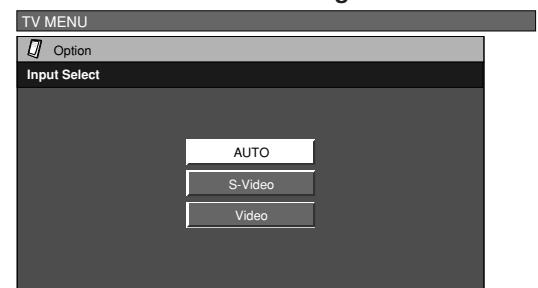

#### NOTE

- If no (colour) image displays, try to change the other signal type.
- Check the operation manual of the external equipment for the signal type.

## Useful adjustment settings

### Colour system setting (AV input mode only)

You can change the colour system to one that is compatible with the image on the screen.

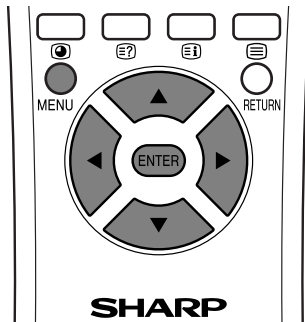

**1** Press **MENU** and the TV MENU screen displays.

**2** Press **◀/▶** to select "Option".  
• Option menu displays.

**3** Press **▲/▼** to select "Colour System", and then press **ENTER**.

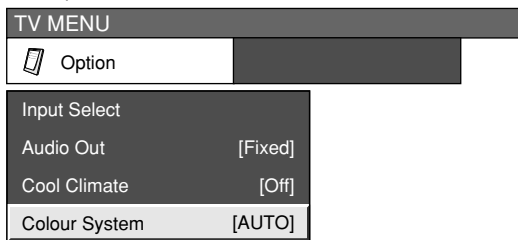

**4** Press **▲/▼** to select a compatible video signal system of your equipment, and then press **ENTER**.  
• Some items may be greyed out. They are not selectable.

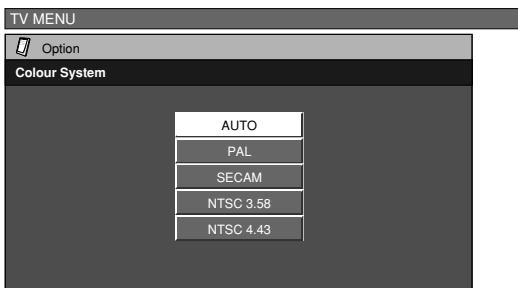

#### NOTE

- Factory preset value is "AUTO".
- If "AUTO" is selected, colour system for each channel is automatically set. If an image does not display clearly, select another colour system (e.g. PAL, NTSC 4.43).

### AV mode selection

AV mode gives you five viewing options to choose from to best match the system environment, which can vary due to factors like room-brightness, type of programme watched or the type of image input from external equipment.

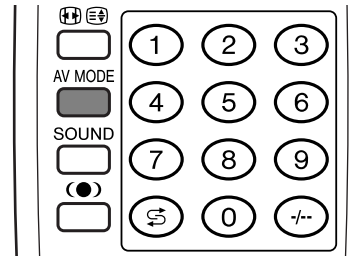

**1** Press **AV MODE**.  
• Present AV mode displays.

**2** Press **AV MODE** again before the mode displayed on the screen disappears.  
• The mode changes as shown below.

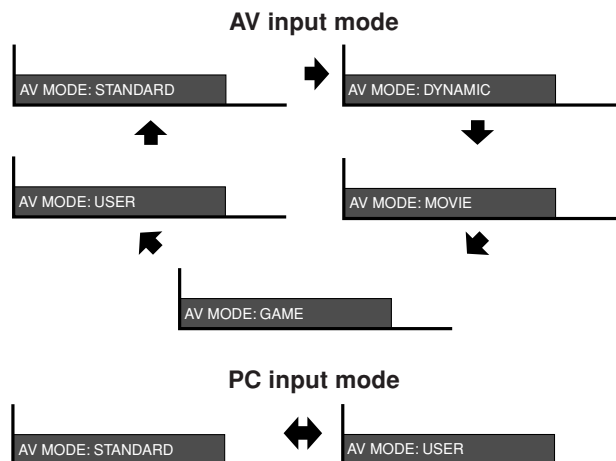

Selected item	Description
<b>STANDARD</b>	For a highly defined image in a normally bright room
<b>DYNAMIC</b>	For a clear-cut image emphasising high contrast for sports viewing
<b>MOVIE</b>	For a movie
<b>GAME</b>	Lowers image brightness for easier viewing.
<b>USER</b>	Allows the user to customise settings as desired. You can set the mode for each input source.

## Useful adjustment settings

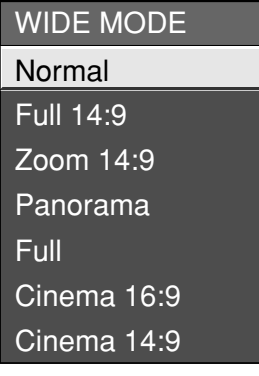
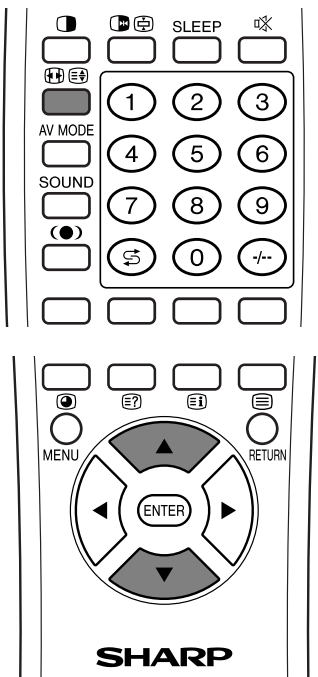

### WIDE mode (for AV input mode)



#### Manual Selection

1

Press .

- The WIDE MODE menu displays.
- The menu lists the wide mode options selectable for the type of video signal currently received.

2

Press  or  while the WIDE MODE menu displays on the screen.

- As you toggle down the options, each is immediately reflected on the Display. No need to press **ENTER**.

#### Auto Selection

If you set "WSS" and "4:3 Mode" in the Setup menu on page 53, the optimum WIDE mode is automatically chosen for every broadcast containing the WSS information.

#### "WSS" menu

To enable Auto Selection, set "WSS" in the Setup menu to "On". (See page 53.)

#### "4:3 Mode" menu

To set the type of the wide screen, select "Normal" or "Panorama" in the 4:3 Mode menu. (See page 53.)

#### NOTE

- If the broadcast signal contains no WSS information, Auto Selection will not function even when the WSS option is enabled.

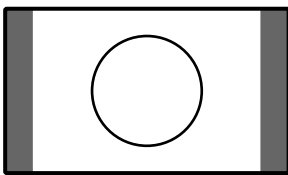

4:3 Mode set to "Normal"

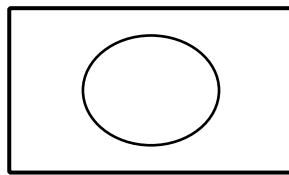

4:3 Mode set to "Panorama"

Selected item	Description
<b>Normal</b>	For 4:3 "standard" pictures. A side bar appears on each side.
<b>Full 14:9</b>	For 14:9 squeeze pictures. A thin side bar appears on each side.
<b>Zoom 14:9</b>	For 14:9 letterbox pictures. A thin side bar appears on each side, and you may also see bars on the top and bottom with some programmes.
<b>Panorama</b>	In this mode the picture is progressively stretched toward each side of the screen.
<b>Full</b>	For 16:9 squeeze pictures. There are two display settings to choose from. (See page 54.)
<b>Cinema 16:9</b>	For 16:9 letterbox pictures. Bars may appear on the top and bottom with some programmes.
<b>Cinema 14:9</b>	For 14:9 letterbox pictures. Bars may appear on the top and bottom with some programmes.

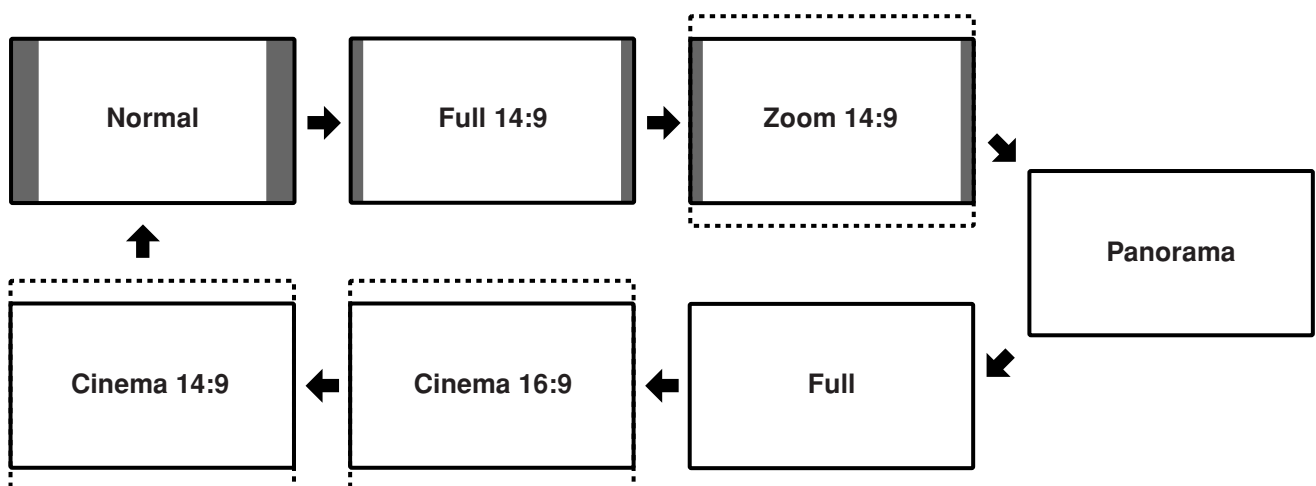

## Useful adjustment settings

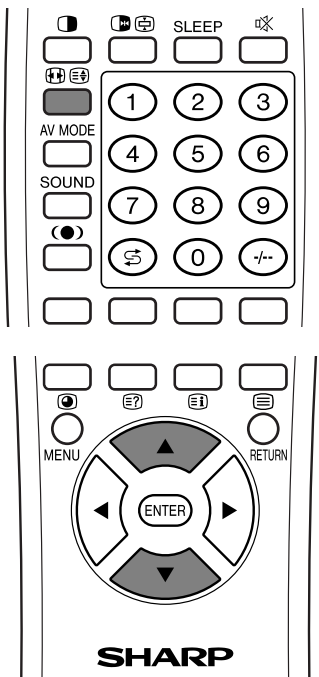

### EXAMPLE

Input signal  
(640 × 480)

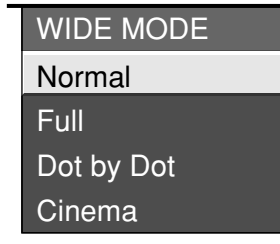

Input signal  
(1024 × 768)

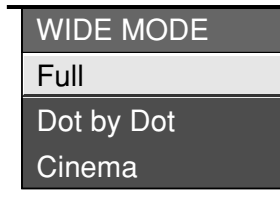

## WIDE mode (for PC input mode)

You can select the screen size.

### NOTE

- Connect the PC before making adjustments. (See page 43.)
- Selectable screen size may vary with input signal type.

1

Press .

- The WIDE MODE menu displays.

2

Press or to select a desired item on the menu.

### EXAMPLE

Screen size images.

Input Signal	Normal	Full	Dot by Dot	Cinema
 640 × 480	 Keeps the original aspect ratio in a full screen display.	 An image fully fills the screen.	 Detects the resolution of the signal and displays an image with the same number of pixels on the screen.	 Keeps the original aspect ratio in a full screen display. The top and bottom of the image is slightly cropped.

Input Signal	Normal	Full	Dot by Dot	Cinema
 1024 × 768	 (This mode is not available for 1024x768)	 An image fully fills the screen.	 Detects the resolution of the signal and displays an image with the same number of pixels on the screen.	 Keeps the original aspect ratio in a full screen display. The top and bottom of the image is slightly cropped.

## Useful adjustment settings

### Input signal (PC input mode only)

- Some input signals may have to be registered manually to display properly.
- The pairs of input signals (resolutions) in the list below are not distinguishable when received. In such case, you have to set the correct signal manually. After setting once, it will display when the same signal (resolution) is input again.

640 × 400	720 × 400
640 × 480	848 × 480
1024 × 768	1280 × 768

#### NOTE

- You can only select the "Input Signal" on the Setup menu when receiving one of the 6 input signals listed above.

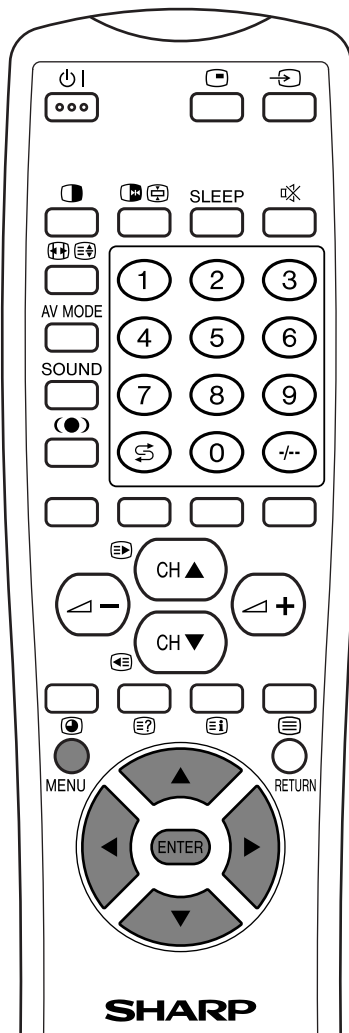

1

Press **MENU** and the PC MENU screen displays.

2

Press ◀▶ to select "Setup".

- Setup menu displays.

3

Press ▲▼ to select "Input Signal" and then press **ENTER**.



4

Press ▲▼ to select the desired input signal on the display.

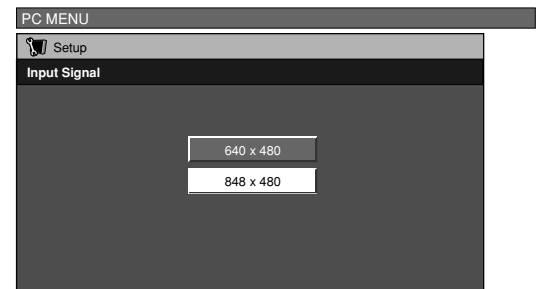

(Example)

## Useful adjustment settings

### Wide screen signalling (WSS) (AV input mode only)

WSS allows a television to switch automatically among the different screen formats.

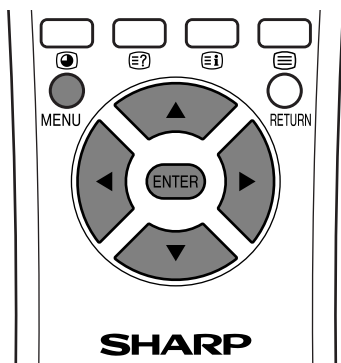

**1** Press **MENU** and the TV MENU screen displays.

**2** Press **◀▶** to select "Setup".

- If password is already set, you are asked to enter it. Follow the same steps as explained in "Auto installation". (See steps 2 and 3 on page 20.)

**3** Press **▲▼** to select "WSS", and then press **ENTER**.

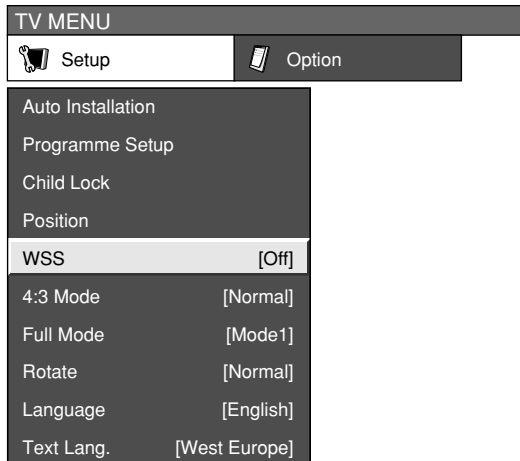

**4** Press **◀▶** to select "On" or "Off", and then press **ENTER**.

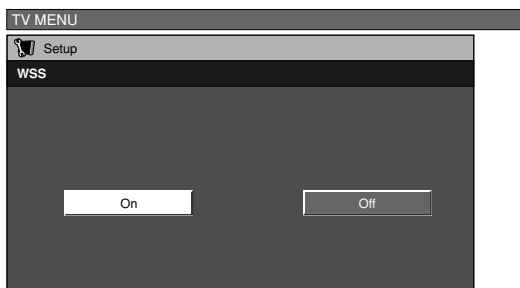

### Picture aspect ratio (AV input mode only)

The WSS signal has 4:3 auto-switching that allows you to select between Normal and Panorama.

**1** Press **MENU** and the TV MENU screen displays.

**2** Press **◀▶** to select "Setup".

- If password is already set, you are asked to enter it. Follow the same steps as explained in "Auto installation". (See steps 2 and 3 on page 20.)

**3** Press **▲▼** to select "4:3 Mode", and then press **ENTER**.

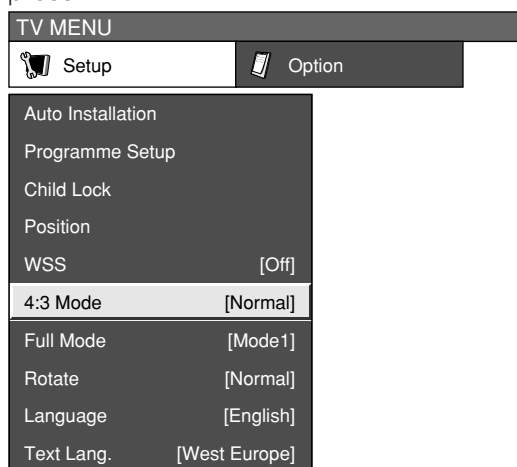

**4** Press **◀▶** to select "Normal" or "Panorama", and then press **ENTER**.

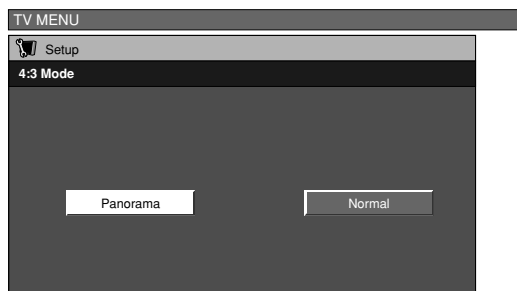

#### WSS signal 4:3 screen

##### 4:3 mode "Normal"



##### 4:3 mode "Panorama"



Selected item	Description
<b>Normal</b>	Normal range keeping 4:3 or 16:9 aspect ratio
<b>Panorama</b>	Wide image without side bars

#### NOTE

- Try to set WIDE mode if an image does not switch to the correct screen format. When the broadcast signal contains no WSS information, the function will not work even if enabled. See page 50.

## Useful adjustment settings

### Selecting Full Mode display (AV input mode only)

Select the display type in Full Mode.

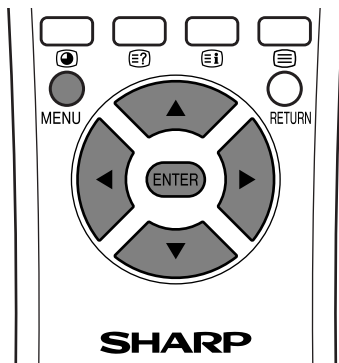

#### Full Mode screen

Full mode "Mode1"



Full mode "Mode2"



Selected item	Description
<b>Mode1</b>	Projects 16:9 squeeze image evenly over entire screen.
<b>Mode2</b>	Displays a 16:9 squeeze image without distortion. However, black bands appear at the top and bottom.

**1** Press **MENU** and the TV MENU screen displays.

**2** Press **◀/▶** to select "Setup".

- If password is already set, you are asked to enter it. Follow the same steps as explained in "Auto installation". (See steps 2 and 3 on page 20.)

**3** Press **▲/▼** to select "Full Mode", and then press **ENTER**.

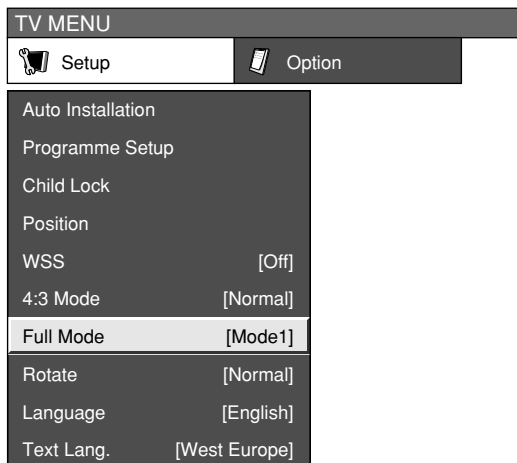

**4** Press **◀/▶** to select "Mode1" or "Mode2", and then press **ENTER**.

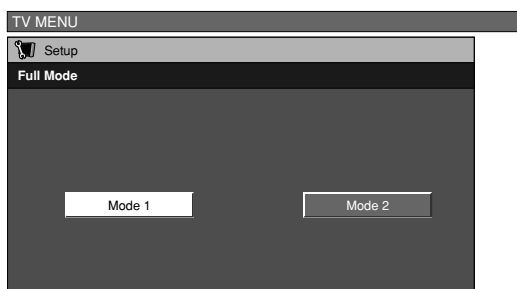

## Useful adjustment settings

### Rotate

You can set the orientation of the picture.

#### AV input mode

**1** Press **MENU** and the TV MENU screen displays.

**2** Press **◀/▶** to select "Setup".

- If password is already set, you are asked to enter it. Follow the same steps as explained in "Auto installation". (See steps 2 and 3 on page 20.)

**3** Press **▲/▼** to select "Rotate", and then press **ENTER**.

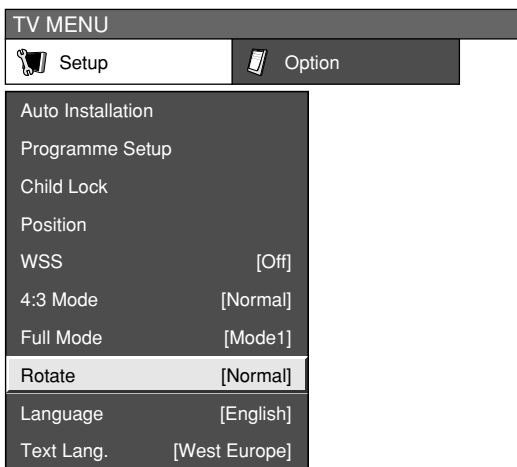

**4** Press **▲/▼** to select the desired mode, and then press **ENTER**.

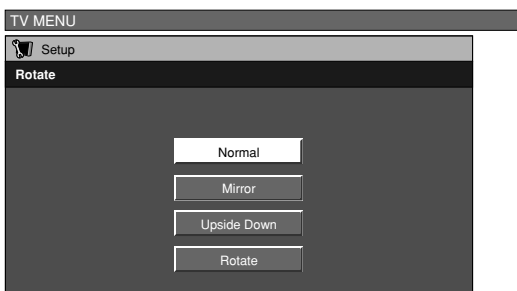

[Normal]: normal image.

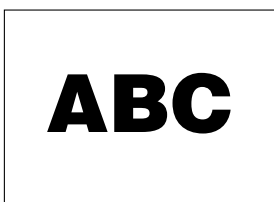

[Mirror]: mirror image.



**1** Press **MENU** and the PC MENU screen displays.

**2** Press **◀/▶** to select "Setup".

- If password is already set, you are asked to enter it. Follow the same step as explained in "Language setting for on-screen display (PC input mode)". (See step 2 on page 28.)

**3** Press **▲/▼** to select "Rotate", and then press **ENTER**.



**4** Press **▲/▼** to select the desired mode, and then press **ENTER**.

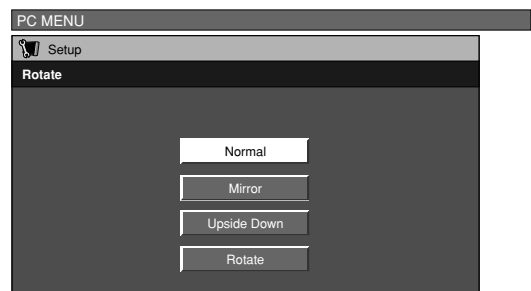

[Upside Down]: upside down image.



[Rotate]: rotated image.

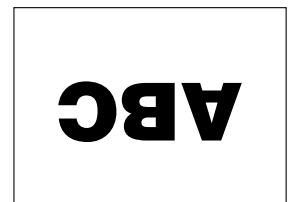

#### NOTE

- If you choose "Mirror" or "Rotate", the sound orientation also changes.

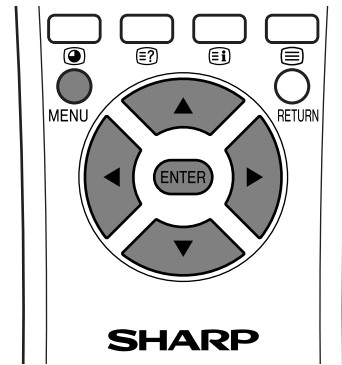

#### PC input mode



## Useful adjustment settings

### Audio out

Allows you to select what controls the audio output.

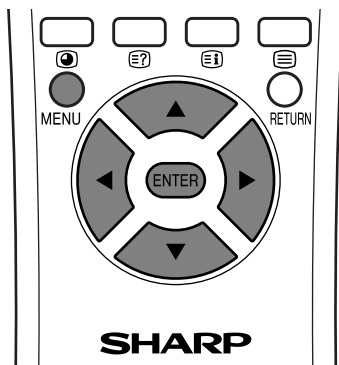

Selected item	Description
<b>Fixed</b>	<ul style="list-style-type: none"> <li>Sound via speakers is adjusted with <math>\triangle</math> -/+ on the remote control unit or the Display.</li> <li>Sound via the MONITOR OUTPUT terminal is not adjustable and constantly outputs.</li> </ul>
<b>Variable</b>	<ul style="list-style-type: none"> <li>Sound via the MONITOR OUTPUT terminal is adjusted with <math>\triangle</math> -/+ on the remote control unit or the Display.</li> <li>Sound via speakers is muted.</li> </ul>

### Sleep timer

Allows you to set a time when the TV automatically switches to standby.

**1** Press **MENU** and the TV MENU (PC MENU) screen displays.

**2** Press  $\triangle$ / $\nabla$  to select "Option".

- Option menu displays.

**3** Press  $\triangle$ / $\nabla$  to select "Audio Out", and then press **ENTER**.

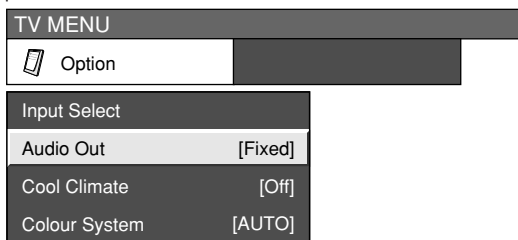

(On-screen display for AV input mode.)

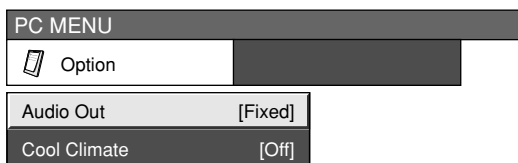

(On-screen display for PC input mode.)

**4** Press  $\triangle$ / $\nabla$  to select "Fixed" or "Variable", and then press **ENTER**.

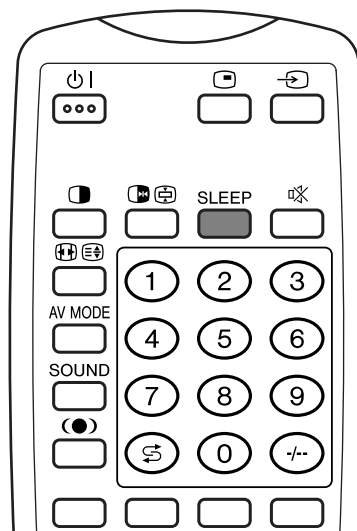
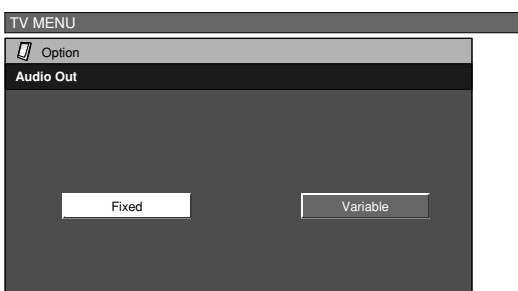

**1** Press **SLEEP**.

- Remaining time displays when sleep timer has been set.

Sleep Timer: Remain 120

**2** Each time you press **SLEEP**, the remaining time switches as shown below.

- When the time has been set, countdown automatically starts.
- Five minutes before the preset of time expires, the remaining time displays each minute.

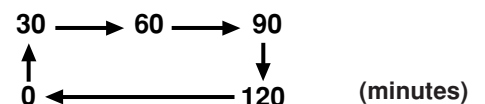

### NOTE

- Select "0" by pressing **SLEEP** to cancel the sleep timer.
- When the sleep timer is working, its indicator on the Display lights red.

## Useful adjustment settings

### Cool climate

Improves LCD response when viewing fast-moving images. The effect is greater at low room temperatures (at or below 15°C/59°F).

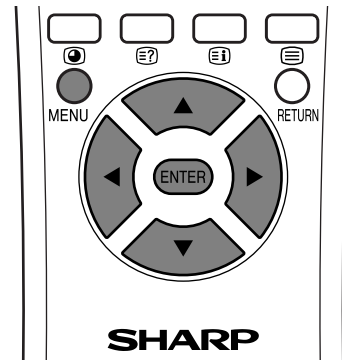

#### AV input mode

**1** Press **MENU** and the TV MENU screen displays.

**2** Press **◀/▶** to select "Option".  
• Option menu displays.

**3** Press **▲/▼** to select "Cool Climate", and then press **ENTER**.

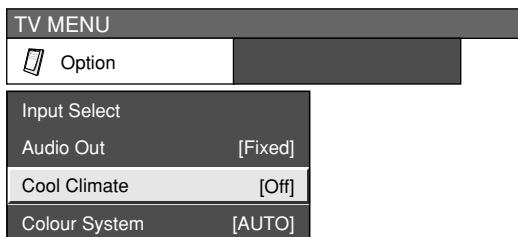

**4** Press **◀/▶** to select "On", and then press **ENTER**.

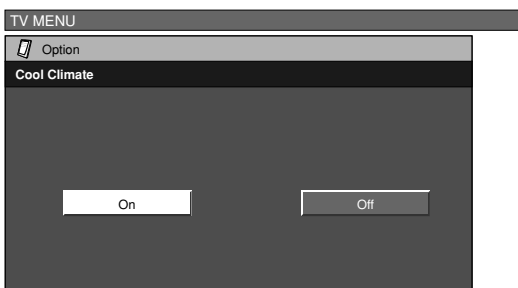

#### NOTE

- Cool climate may cause image noise. If this occurs turn the function "Off".
- Cool Climate can be set differently for AV input mode and PC input mode.

#### PC input mode

**1** Press **MENU** and the PC MENU screen displays.

**2** Press **◀/▶** to select "Option".  
• Option menu displays.

**3** Press **▲/▼** to select "Cool Climate", and then press **ENTER**.

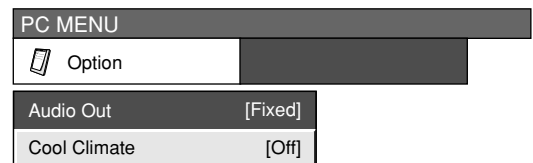

**4** Press **◀/▶** to select "On", and then press **ENTER**.

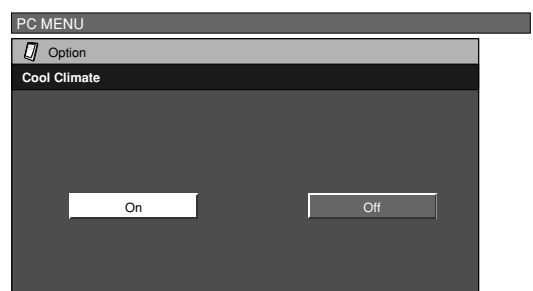

#### NOTE

- Cool climate may cause image noise. If this occurs turn the function "Off".
- Cool Climate can be set differently for AV input mode and PC input mode.

## Useful adjustment settings

### Password setting for child lock (TV mode only)

Allows you to use a password to protect certain settings from being accidentally changed.

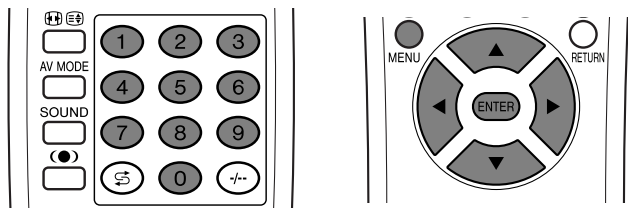

#### Setting a password

**1** Press **MENU** and the TV MENU screen displays.

**2** Press **◀/▶** to select "Setup".  
• Setup menu displays.

**3** Press **▲/▼** to select "Child Lock", and then press **ENTER**.

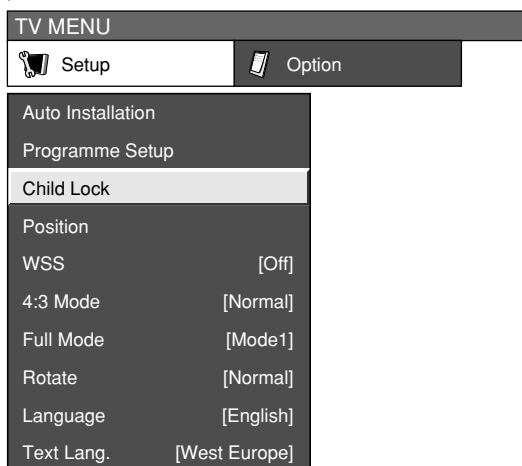

**4** Press **▲/▼** to select "Password", and then press **ENTER**.

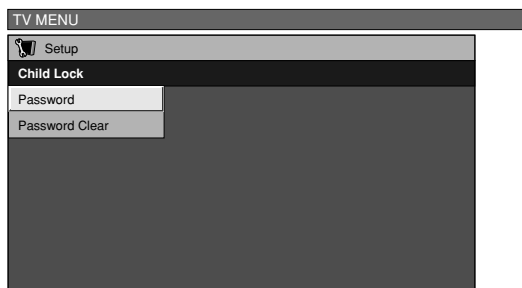

**5** Enter the 4-digit number as a password using **0 – 9**.

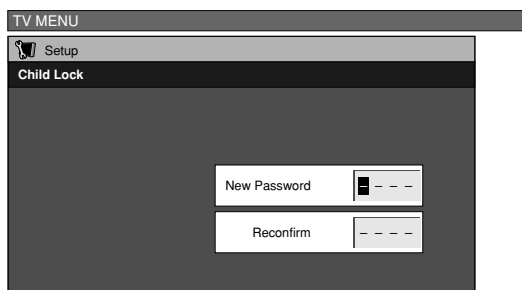

**6**

Enter the same 4-digit number as in step 5 to confirm.

- "The new password is registered." displays.

#### NOTE

- To view a locked channel (Lock setting in Programme Setup "Manual" is set to "On"), you must enter a password. (See page 26.) When you select a locked channel, a password prompt message pops up. Press **ENTER** to display the password input window.

#### Clearing the password

Allows you to clear your password.

**1**

Press **MENU** and the TV MENU screen displays.

**2**

Press **◀/▶** to select "Setup".  
• You are asked to enter the password. Follow the same steps as explained in "Auto installation" (See steps 2 and 3 on page 20.)

**3**

Press **▲/▼** to select "Child Lock", and then press **ENTER**.

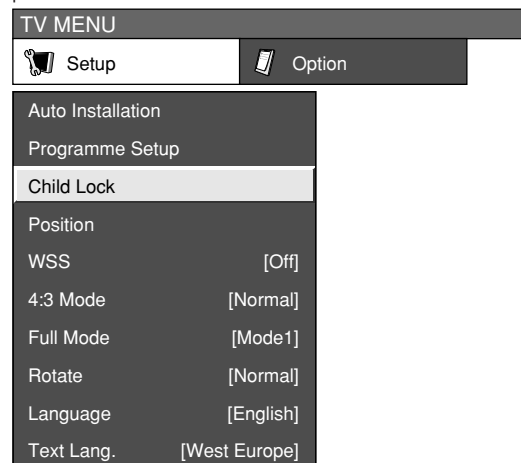

**4**

Press **▲/▼** to select "Password Clear", and then press **ENTER**.

**5**

Press **◀/▶** to select "Yes", and then press **ENTER**.

- Your password is cleared.

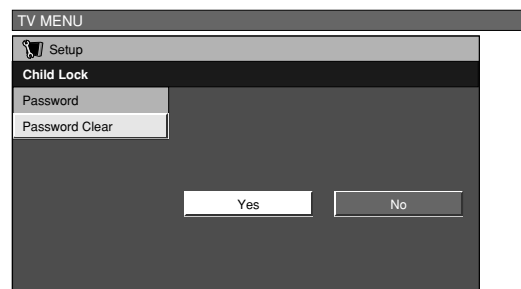

#### NOTE

- As a precautionary measure, make a note of your password and keep it in a familiar place. If you lose or forget your password, initialise the System to return all settings except for the TV channel settings to factory preset values. (See page 71.)

# Useful features

## Dual screen functions

Allows you to display two pictures on the screen at one time.

### Dual screen

You can display two same-sized pictures except when inputting from a PC INPUT terminal.

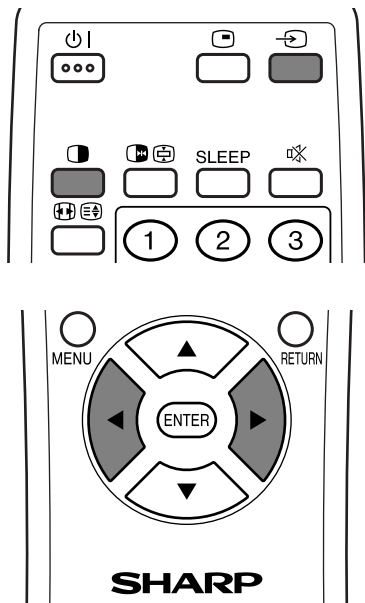

3

Press  to select another input source on the active screen.

- A selected image displays.

4

Press  to exit dual screen.

### NOTE

- This function does not work under the following input conditions:
  - ① PC INPUT mode,
  - ② Two pictures from the same source (e.g. INPUT 1 and INPUT 1),
  - ③ Two pictures with different vertical frequency (e.g. PAL and PAL-60).
- When this function is not available, "No dual screen display available." will display.

1

Press .

- Dual screen displays and a selected input source image displays.

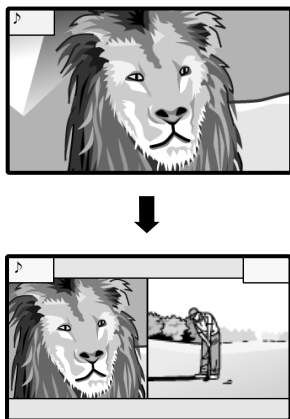

2

Press  to set either screen to be active.

- "♪" displays on the active screen, which has sound output.

## Useful features

### Picture and still image

You can display two same-sized pictures – one moving and one still – when inputting from an AV source.

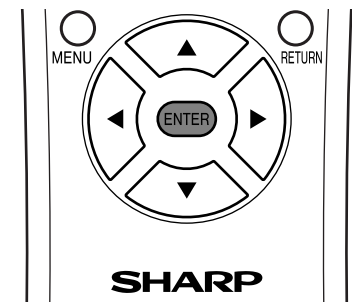
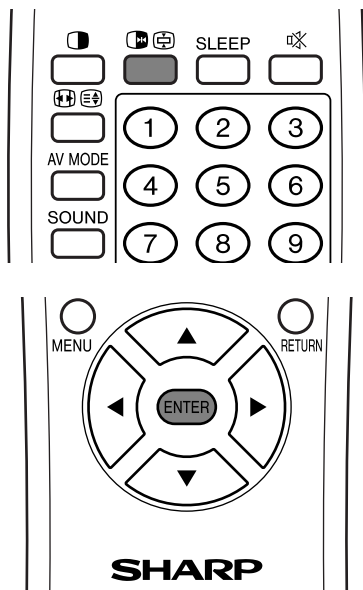

1

Press .

- A moving image displays on the left screen and a still image displays on the right screen. The still image is one frame captured from a moving image at the moment you press .

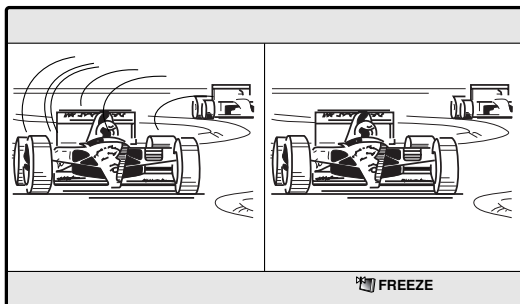

2

Update the still image by pressing **ENTER**.

- Each time you press **ENTER**, the image on the right screen updates.

3

Press  to exit still image.

#### NOTE

- This function does not work in PC input mode.
- When this function is not available, "No still image display available." will display.
- The still image automatically goes out after 30 minutes.

### Teletext language setting

If Teletext information does not display correctly, perform the setting procedure below.

Select from among 4 kinds of language tables: West Europe, East Europe, Greek/Turkish, Cyrillic.

Each table is compatible with the Teletext languages listed below.

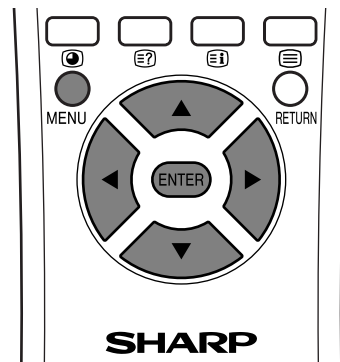

1

Press **MENU** and the TV MENU screen displays.

2



Press   to select "Setup".

- If password is already set, you are asked to enter it. Follow the same steps as explained in "Auto installation". (See steps 2 and 3 on page 20.)

3

Press   to select "Text Lang.", and then press **ENTER**.

4

Press   to select the receivable teletext broadcasting language in your country.

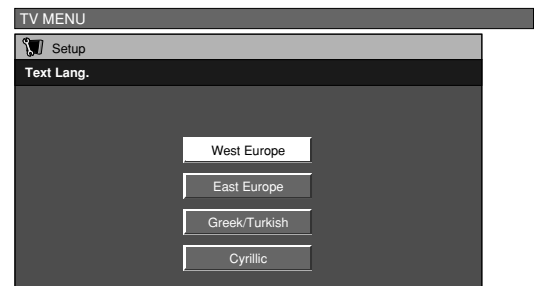

- West Europe - English, French, Scandinavian, Czech, German, Spanish, Italian
- East Europe - Polish, French, Scandinavian, Czech, German, Slovenian/Croatian, Italian, Rumanian
- Greek/Turkish - English, French, Scandinavian, Turkish, German, Spanish, Italian, Greek
- Cyrillic - English, Russian, Estonian, Czech, German, Spanish, Ukrainian, Lettish

#### NOTE

- Teletext can display only when it is sent by a network. Not used to convert between languages.

## Useful features

### Teletext function

#### What is Teletext?

Teletext broadcasts pages of information and entertainment to specially equipped television sets. Your System receives Teletext signals broadcast by a TV network, and decodes them into graphical format for viewing. News, weather and sports information, stock exchange prices and programme previews are among the many services available.

#### NOTE



- Teletext is broadcast in Europe and Asia, excluding regions that use Arabic characters.

#### Teletext mode

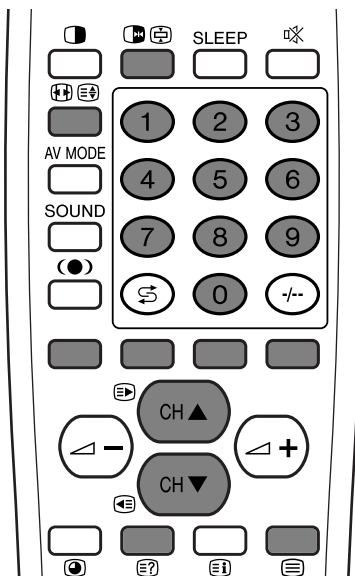
Teletext is turned on/off with  on the remote control unit. You can operate your System in Teletext mode directly by inputting commands with the remote control unit.



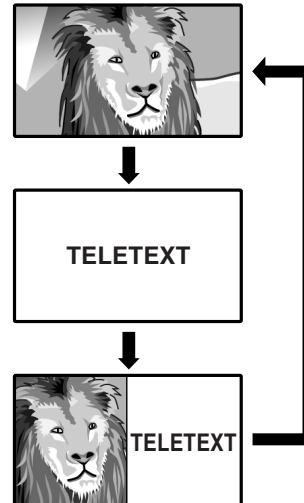

#### Turning on and off Teletext

- 1 Select a TV channel or external input source providing the Teletext programme.
- 2 Press  to display the Teletext.
- 3 Press  again to display the Teletext on the right screen and normal image on the left screen.
  - Each time you press , the screen switches as shown upper right.
  - If you select a programme with no Teletext signal, "No Teletext available." displays.
  - The same message displays during dual screen or other modes if no Teletext signal is available.



#### When viewing the Teletext information

- Press **CH▲** () to increase the page number.
- Press **CH▼** () to decrease the page number.

#### Button functions

##### Colour (RED/GREEN/YELLOW/BLUE):

You can select a group or block of pages displayed in the coloured brackets at the bottom of the screen by pressing the corresponding **Colour (RED/GREEN/YELLOW/BLUE)** on the remote control unit.

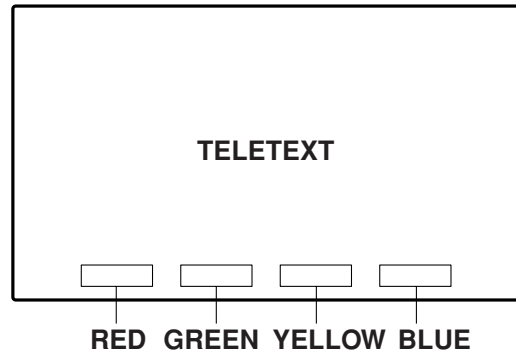

##### 0 - 9:

Directly select any page from 100 to 899 by using **0 - 9**.

##### :

Each time you press , the TELETEXT image switches as shown below.

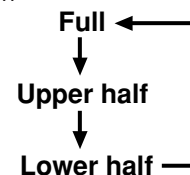

##### :

To reveal hidden information such as an answer to a quiz, press .

- Press  again to hide the information.

##### :

To stop updating Teletext pages automatically, press .

- Press  again to release the hold mode.

## Useful features

### Displaying Subpages

You can display several subpages as they are transmitted.

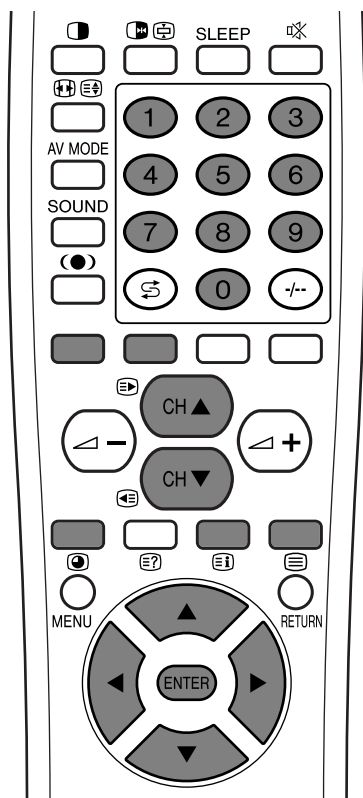

**1** Press to display Teletext.

**2** Press to display the subpage as shown below.

#### Subpage screen

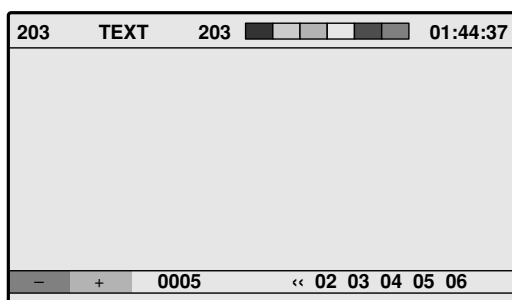

**3** Select the desired subpage by using / **RED/GREEN**.

- **0 – 9** directly selects the desired subpage.

**4** Press to exit the subpage screen.

- If you press (**CH▲/CH▼**), the present page will change to the next/previous page and simultaneously exit the subpage screen.

### Displaying TOP Overview

When receiving TOP Teletext, you can read a TOP text overview.

**1** Press to display Teletext.

**2** Press to display the TOP Overview as shown below.

#### TOP Overview screen

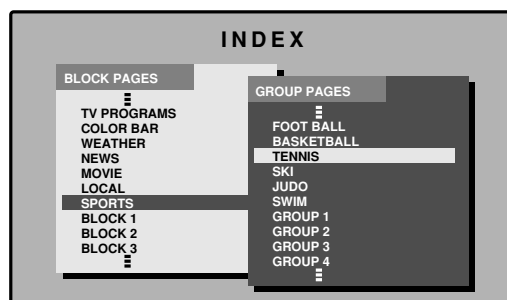

**3** Select the desired block or group by using / .

**4** Press **ENTER** to display the selected block or group pages.

**5** Press to exit the TOP Overview screen.

## Useful features

---

### Time display

You can display the time information included in the Teletext. Follow the steps below to display the time.

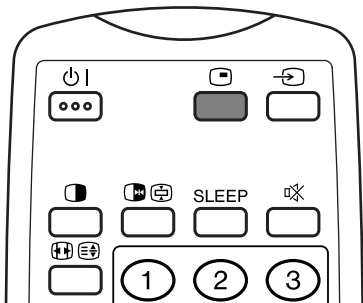

- 1** Select a TV channel providing Teletext information.  
(The time information is automatically captured.)

#### NOTE

- The time is not captured when a selected channel has no Teletext information.

- 2** Press . The channel display will appear on the Display.

- 3** Press  again within the three-second interval the channel display is on the screen. Time information will display on the lower left of the screen for about three seconds.

- 4** Even when you change the TV channel, you can display the time information with steps 2 – 3 above.



#### NOTE

- The time display cannot be stored once the power is turned off. When you turn on the power, perform steps 1 – 4 again.



# Appendix

## Troubleshooting

Problem	Possible Solution
<ul style="list-style-type: none"> <li>No power.</li> </ul>	<ul style="list-style-type: none"> <li>Make sure the Display and the AVC System are connected correctly. (See page 6.)</li> <li>Check if you pressed  on the remote control unit. (See page 14.) If the indicator on the Display lights up red, press  (STANDBY/ON) button.</li> <li>Is the AC cord disconnected? (See page 13.)</li> <li>Has the main power been turned on? (See page 14.)</li> </ul>
<ul style="list-style-type: none"> <li>Unit cannot be operated.</li> </ul>	<ul style="list-style-type: none"> <li>External influences such as lightning, static electricity, etc., may cause improper operation. In this case, operate the unit after first turning the power of the Display and the AVC System, or unplugging the AC cord and re-plugging it in after 1 or 2 minutes.</li> </ul>
<ul style="list-style-type: none"> <li>Remote control unit does not operate.</li> </ul>	<ul style="list-style-type: none"> <li>Are batteries inserted with polarity (+, -) aligned? (See page 9.)</li> <li>Are batteries worn out? (Replace with new batteries.)</li> <li>Are you using it under strong or fluorescent lighting?</li> <li>Is a fluorescent light illuminated to remote control sensor?</li> </ul>
<ul style="list-style-type: none"> <li>Picture is cut off.</li> </ul>	<ul style="list-style-type: none"> <li>Is the image position correct? (See pages 45 and 46.)</li> <li>Are screen mode adjustments such as picture size made correctly? (See pages 50 to 54.)</li> </ul>
<ul style="list-style-type: none"> <li>Strange colour, light colour, or dark, or colour misalignment.</li> </ul>	<ul style="list-style-type: none"> <li>Adjust the picture tone. (See pages 29 to 33 and 57.)</li> <li>Is the room too bright? The picture may look dark in a room that is too bright.</li> <li>Check the colour system setting. (See pages 25 and 49.)</li> <li>Check the input signal setting. (See page 48.)</li> </ul>
<ul style="list-style-type: none"> <li>Power is suddenly turned off.</li> </ul>	<ul style="list-style-type: none"> <li>The unit's internal temperature has increased. Remove any objects blocking vent or clean.</li> <li>Check the power control setting. (See pages 35 to 37.)</li> <li>Check the sleep timer setting. (See page 56.)</li> </ul>
<ul style="list-style-type: none"> <li>No picture.</li> </ul>	<ul style="list-style-type: none"> <li>Is connection to other components correct? (See pages 38 to 43.)</li> <li>Is correct input signal source selected after connection? (See page 48.)</li> <li>Is the correct input selected? (See page 48.)</li> <li>Is a non-compatible signal being input? (See page 65.)</li> <li>Is picture adjustment correct? (See pages 29 to 33.)</li> </ul>
<ul style="list-style-type: none"> <li>No sound.</li> </ul>	<ul style="list-style-type: none"> <li>Is the volume too low? (See page 16.)</li> <li>Is "Variable" selected in "Audio Out"? (See page 56.)</li> <li>During Auto search, the sound system should automatically be detected. However, auto-detect may not find some signals, in which case choose Manual. (See page 25.)</li> </ul>
<ul style="list-style-type: none"> <li>Picture is not clear.</li> <li>No sound. (Even though the System is receiving bilingual and stereo signals, there is no sound and the mode menu does not display.)</li> </ul>	<ul style="list-style-type: none"> <li>The Auto search (or Auto Installation) automatically searches for compatible sound systems, but may not detect them depending on electric field conditions. In that case, adjust to optimum sound system position by following directions on page 25.</li> </ul>

### Cautions regarding use in high and low temperature environments

- When the unit is used in a low temperature space (e.g. room, office), the picture may leave trails or appear slightly delayed. This is not a malfunction, and the unit will recover when the temperature returns to normal.
- Do not leave the unit in a hot or cold location. Also, do not leave the unit in a location exposed to direct sunlight or near a heater, as this may cause the cabinet to deform and the LCD panel to malfunction. Storage temperature: -20°C to +60°C (-4°F to +140°F).

## Appendix

---

### PC compatibility chart

Resolution	Frequency	Remarks
640 × 400	85 Hz	
720 × 400	70 Hz	
	85 Hz	
640 × 480	60 Hz	
	65 Hz	Macintosh 13" (67 Hz)
	72 Hz	
	75 Hz	
	85 Hz	
800 × 600	56 Hz	
	60 Hz	
	72 Hz	
	75 Hz	
	85 Hz	
832 × 624	74.5 Hz	Macintosh 16"
1024 × 768	60 Hz	
	70 Hz	
	75 Hz	Macintosh 19"
	85 Hz	
1280 × 768	60 Hz	
1280 × 1024	60 Hz	

Apple and Macintosh are registered trademarks of Apple Computer, Inc.  
DDC is a registered trademark of Video Electronics Standards Association.  
Power Management is a registered trademark of Sun Microsystems, Inc.  
VGA and XGA are registered trademarks of International Business Machines Co., Inc.

**RS-232C port specifications**

**PC Control of the System**

- When a program is set, the display can be controlled from the PC using the RS-232C terminal. The input signal (PC/AV) can be selected, the volume can be adjusted and various other adjustments and settings can be made, enabling automatic programmed playing.
- Attach an RS-232C cable cross-type (commercially available) to the supplied Din/D-Sub RS-232C for the connections.

**NOTE**

- This operation system should be used by a person who is accustomed to using PCs.

**Communication conditions**

Set the RS-232C communications settings on the PC to match the display's communications conditions. The display's communications settings are as follows:

<b>Baud rate:</b>	9,600 bps
<b>Data length:</b>	8 bits
<b>Parity bit:</b>	None
<b>Stop bit:</b>	1 bit
<b>Flow control:</b>	None

**Communication procedure**

Send the control commands from the PC via the RS-232C connector. The Display operates according to the received command and sends a response message to the PC. Do not send multiple commands at the same time. Wait until the PC receives the OK response before sending the next command.

**Command format**

Eight ASCII codes + CR



**Parameter**

Input the parameter values, aligning left, and fill with blank(s) for the remainder. (Be sure that four values are input for the parameter.)  
 When the input parameter is not within an adjustable range, "ERR" returns. (Refer to "Response code format".)  
 No problem to input any numerical value for "x" on the table.

0			
0	0	0	9
-	3	0	
1	0	0	
0	0	5	5

When "?" is input for some commands, the present setting value responds.

?			
?	?	?	?

## Appendix

### Response code format

Normal response

O	K	↵
---	---	---

Return code (0DH)

Problem response (communication error or incorrect command)

E	R	R	↵
---	---	---	---

Return code (0DH)

### Commands

CONTROL ITEM	COMMAND	PARAMETER	CONTROL CONTENTS
POWER SETTING	P O W R	0 _ _ _	POWER OFF (STANDBY)
INPUT SELECTION A	I T G D	x _ _ _	INPUT SWITCHING (TOGGLE)
	I T V D	0 _ _ _	TV (CHANNEL FIXED)
	I T V D	* * _ _	TV (CHANNEL SELECTION) (1 - 99)
	I A V D	* _ _ _	INPUT1 - 4 (1 - 4)
	I P C D	x _ _ _	PC
INPUT SELECTION B	I N P 1	0 _ _ _	INPUT1 (AUTO)
	I N P 1	1 _ _ _	INPUT1 (COMPONENT)
	I N P 1	2 _ _ _	INPUT1 (S-VIDEO)
	I N P 1	3 _ _ _	INPUT1 (VIDEO)
	I N P 2	0 _ _ _	INPUT2 (AUTO)
	I N P 2	1 _ _ _	INPUT2 (S-VIDEO)
	I N P 2	2 _ _ _	INPUT2 (VIDEO)
	I N P 3	0 _ _ _	INPUT3 (AUTO)
	I N P 3	1 _ _ _	INPUT3 (COMPONENT)
	I N P 3	2 _ _ _	INPUT3 (S-VIDEO)
	I N P 3	3 _ _ _	INPUT3 (VIDEO)
	I N P 4	0 _ _ _	INPUT4 (AUTO)
	I N P 4	1 _ _ _	INPUT4 (S-VIDEO)
	I N P 4	2 _ _ _	INPUT4 (VIDEO)
AV MODE SELECTION	A V M D	0 _ _ _	TOGGLE
	A V M D	1 _ _ _	STANDARD
	A V M D	2 _ _ _	DYNAMIC
	A V M D	3 _ _ _	MOVIE
	A V M D	4 _ _ _	GAME
	A V M D	5 _ _ _	USER
VOLUME	V O L M	* * _ _	VOLUME (0 - 60)
POSITION	H P O S	* * * _	H-POSITION (AV) (-10 - +10)
	H P O S	* * * _	H-POSITION (PC) (-90 - +90)
	V P O S	* * * _	V-POSITION (AV) (-30 - +30)
	V P O S	* * * _	V-POSITION (PC) (-60 - +60)
	C L C K	* * * _	CLOCK (-90 - +90)
	P H S E	* * * _	PHASE (-20 - +20)

CONTROL ITEM	COMMAND	PARAMETER	CONTROL CONTENTS
WIDE MODE	W I D E	0 _ _ _	TOGGLE
	W I D E	1 _ _ _	NORMAL
	W I D E	2 _ _ _	FULL 14:9
	W I D E	3 _ _ _	ZOOM 14:9
	W I D E	4 _ _ _	PANORAMA
	W I D E	5 _ _ _	FULL
	W I D E	6 _ _ _	CINEMA 16:9
	W I D E	7 _ _ _	CINEMA 14:9
	W I D E	8 _ _ _	NORMAL
	W I D E	9 _ _ _	FULL
SRS	S R S S	0 _ _ _	TOGGLE
	S R S S	1 _ _ _	OFF
	S R S S	2 _ _ _	SRS
	S R S S	3 _ _ _	FOCUS
	S R S S	4 _ _ _	SRS + FOCUS
DUAL SCREEN	T W I N	0 _ _ _	DUAL SCREEN OFF
	T W I N	1 _ _ _	DUAL SCREEN ON
CHANNEL	D C H * *	* _ _ _	DIRECT CHANNEL (1 - 99)
	C H U P	x _ _ _	CHANNEL UP
	C H D W	x _ _ _	CHANNEL DOWN
TEXT	T E X T	0 _ _ _	TEXT OFF
	T E X T	1 _ _ _	TEXT ON (TOGGLE)
	D C P G	* * * _	DIRECT PAGE JUMP (100 - 899)

#### NOTE

- If an underbar (\_) appears in the parameter column, enter a space.
- If an asterisk (\*) appears, enter a value in the range indicated in brackets under CONTROL CONTENTS.

## Appendix

### Specifications

Item		30" LCD COLOUR TV, Model:LC-30HV4M		
LCD panel		30" Advanced Super View & BLACK TFT LCD		
Number of dots		2,949,120 dots (1280 × 768 × 3 dots)		
Video Colour System		PAL/SECAM/NTSC 3.58/NTSC 4.43/PAL 60		
TV Function	TV-standard (CCIR)	PAL: B/G, D/K, I SECAM: B/G, D/K NTSC: M		
	Receiving Channel	VHF/UHF	44.25-863.25 MHz	
		CATV	Hyper-band, S1-S41ch	
	TV-Tuning System	Auto Preset 99 ch, Auto Label, Auto Sort		
STEREO/BILINGUAL		NICAM/IGR		
Brightness		430 cd/m <sup>2</sup>		
Backlight		60,000 hours (at Save 1)		
Viewing angles		H : 170° V : 170°		
Audio amplifier		10W × 2		
Speakers		Ø 8 cm 2pcs		
Terminals	AVC System	Rear	INPUT 1	AV in, S-VIDEO in, COMPONENT VIDEO in
			INPUT 2	AV in, S-VIDEO in
			INPUT 3	AV in, S-VIDEO in, COMPONENT VIDEO in
		ANTENNA	75 Ω Din Type	
		MONITOR OUTPUT	Audio (Variable, Fixed), S-VIDEO out, VIDEO out	
		DC OUTPUT	DC 6.5V 7W MAX	
	Front	INPUT 4	AV in, S-VIDEO	
		PC	15 Pin mini D-Sub, Audio in (Ø 3.5mm jack)	
		Headphones	Ø 3.5mm jack	
OSD language		English/Chinese/Arabic		
Power Requirement		AC 110-240 V, 50/60 Hz		
Power Consumption	AVC System	31 W (0.8W Standby)		
	Display	105 W (0.7W Standby)		
Weight	AVC System	5.4 kg (w/o stand), 5.5 kg (with stand)		
	Display	15.8 kg (w/o stand), 19.7 kg (with stand)		
Accessories		Operation manual, Remote control unit (× 1), System cable (× 1), AC cord (× 2), LR6 ("AA" size) Alkaline battery (× 2), Stand unit (× 1), Cable clamp (× 1), Antenna cable (× 1)		

- As a part of policy of continuous improvement, SHARP reserves the right to make design and specification changes for product improvement without prior notice. The performance specification figures indicated are nominal values of production units. There may be some deviations from these values in individual units.

### Optional accessory

The listed optional accessory is available for the LCD colour TV. Please purchase it at your nearest shop.

- Additional optional accessories may be available in near future. When purchasing, please read the newest catalogue for compatibility and check the availability.

No.	Part name	Part number
1	Wall mount bracket	AN-37AG1

# Dimensional drawings

## Display

Unit: mm

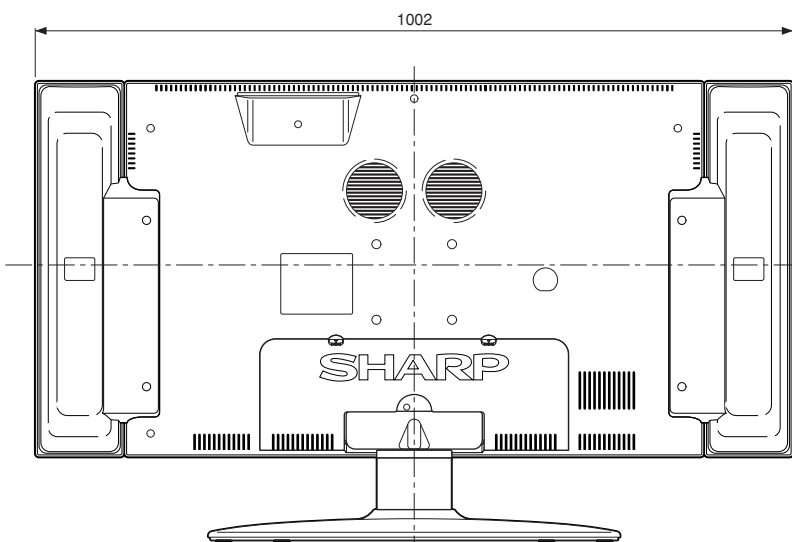
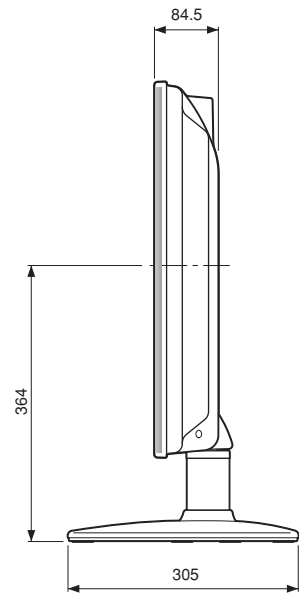
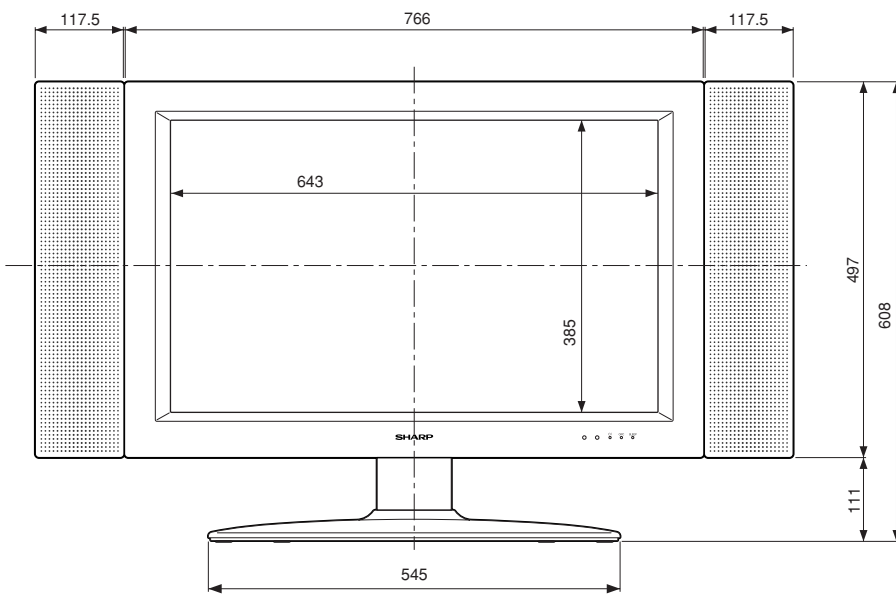
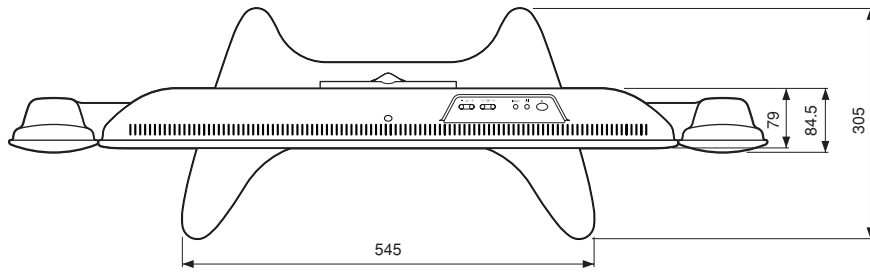



# Dimensional drawings

## AVC System

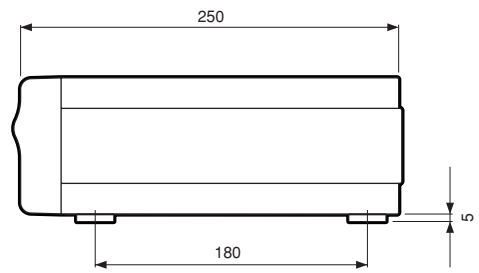
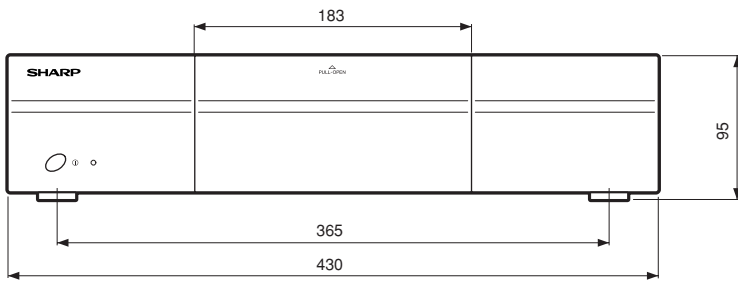
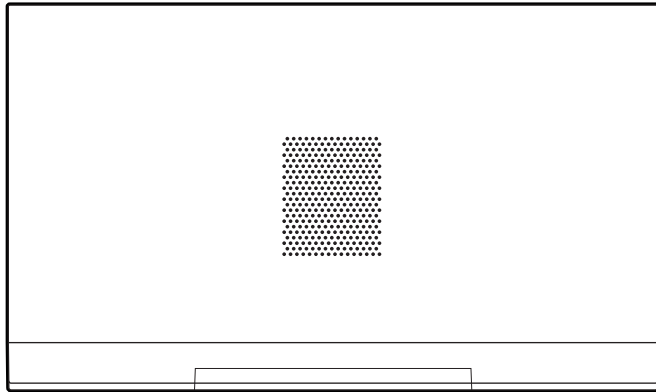
Unit: mm





## HOW TO SET THE FACTORY PRESETS

Press and hold down **CLEAR** on the AVC System while it is in standby mode. Then press  (STANDBY/ON) button on the Display or  on the remote control unit to turn the System on. All setting items (except TV channel) return to the factory presetting.

### NOTE



- Running the factory presetting operation also clears the password.

You can run the Auto Installation again by using the following steps.

- 1 Turn on the power of the Display and the AVC System.
- 2 Press **MENU**. (Make sure the menu screen displays.)
- 3 Press /  to select "Setup".
- 4 Press **ENTER**.

### NOTE

- If the password setting screen displays, you need to enter your password.
- If you forget your password, refer to HOW TO SET THE FACTORY PRESETS above.

- 5 Press /  to select "Auto Installation".
- 6 Press **ENTER**.

The password is

--	--	--	--

 .

### NOTE

- As a precautionary measure, make a note of your password above, scissor it from this manual, and keep it in a familiar place.





**SHARP®**  
**SHARP CORPORATION**

## Free Manuals Download Website

<http://myh66.com>

<http://usermanuals.us>

<http://www.somanuals.com>

<http://www.4manuals.cc>

<http://www.manual-lib.com>

<http://www.404manual.com>

<http://www.luxmanual.com>

<http://aubethermostatmanual.com>

Golf course search by state

<http://golfingnear.com>

Email search by domain

<http://emailbydomain.com>

Auto manuals search

<http://auto.somanuals.com>

TV manuals search

<http://tv.somanuals.com>