

# SHARP®

MODEL

# AR-235

# AR-275

## DIGITAL COPYING MACHINE

### OPERATION MANUAL

|                                   | Page      |
|-----------------------------------|-----------|
| • <b>GETTING STARTED</b> .....    | <b>5</b>  |
| • <b>MAKING COPIES</b> .....      | <b>23</b> |
| • <b>SPECIAL FUNCTIONS</b> .....  | <b>41</b> |
| • <b>COPIER TROUBLE?</b> .....    | <b>65</b> |
| • <b>GENERAL INFORMATION</b> ..   | <b>77</b> |
| • <b>OPTIONAL EQUIPMENT</b> ..... | <b>91</b> |

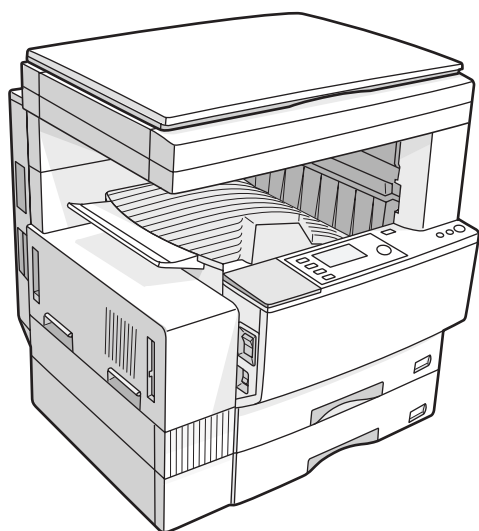

**FOR YOUR RECORDS ...**

To protect against loss or theft, record and retain for reference the copier's serial number located on the back of the unit.

Model Number \_\_\_\_\_

Serial Number \_\_\_\_\_

Date of Purchase \_\_\_\_\_

Place of Purchase \_\_\_\_\_

Authorized Sharp Copier

Service Department Number \_\_\_\_\_

# OUTLINE OF THIS MANUAL

---

## 1. GETTING STARTED

This chapter describes the basic information on the use of this copier.

1

## 2. MAKING COPIES

This chapter describes the basic copying functions such as normal copying, reduction or enlargement, and exposure adjustments.

2

## 3. SPECIAL FUNCTIONS

This chapter describes special copying functions including various image editing functions.

3

## 4. COPIER TROUBLE?

This chapter describes how to remove misfed paper and how to remedy minor problems.

4

## 5. GENERAL INFORMATION

This chapter describes general information about the use of the copier and the loading of paper and toner.

5

## 6. OPTIONAL EQUIPMENT

This chapter describes operating instructions for the Single Pass Feeder (AR-SP4), the Reversing Single Pass Feeder (AR-RP3), the Finisher (AR-FN5), the 500-Sheet Paper Feed Unit (AR-D11), and the 2 x 500-Sheet Paper Feed Unit (AR-D12).

6

# CONTENTS

---

Page

## CHAPTER 1 GETTING STARTED

|   |    |
|---|----|
| INTRODUCTION . . . . .                                | 6  |
| CAUTIONS . . . . .                                    | 7  |
| COPIER INSTALLATION . . . . .                         | 8  |
| MAIN FEATURES . . . . .                               | 10 |
| PART NAMES AND FUNCTIONS . . . . .                    | 12 |
| ● Exterior . . . . .                                  | 12 |
| ● Interior . . . . .                                  | 13 |
| ● Operation panel . . . . .                           | 14 |
| POWER ON AND OFF . . . . .                            | 16 |
| ● Power on . . . . .                                  | 16 |
| ● Power off . . . . .                                 | 16 |
| ● Dehumidification heater switch (DH POWER) . . . . . | 16 |
| ● Initial settings . . . . .                          | 17 |
| ● Power save modes . . . . .                          | 17 |
| FUNCTION ICONS . . . . .                              | 18 |
| FUNCTION REVIEW . . . . .                             | 19 |
| AUDITING ACCOUNTS . . . . .                           | 20 |
| ● How to copy in the auditing mode . . . . .          | 20 |

## CHAPTER 2 MAKING COPIES

|   |    |
|---|----|
| NORMAL COPYING . . . . .                                      | 24 |
| TWO-SIDED COPYING . . . . .                                   | 26 |
| ● Two-sided copying from the platen glass . . . . .           | 26 |
| EXPOSURE ADJUSTMENT . . . . .                                 | 29 |
| REDUCTION/ENLARGEMENT/ZOOM . . . . .                          | 31 |
| ● Automatic selection . . . . .                               | 31 |
| ● Manual selection . . . . .                                  | 33 |
| ROTATION COPYING . . . . .                                    | 35 |
| BYPASS FEED (special paper) . . . . .                         | 36 |
| ● Acceptable paper for copying from the bypass tray . . . . . | 36 |
| ● Copying from the bypass tray . . . . .                      | 36 |
| INTERRUPTING A COPY RUN . . . . .                             | 39 |

## CHAPTER 3 SPECIAL FUNCTIONS

|   |    |
|---|----|
| SORT/GROUP . . . . .                          | 42 |
| ● Copying in the sort or group mode . . . . . | 42 |
| MARGIN SHIFT . . . . .                        | 45 |
| ERASE . . . . .                               | 47 |
| DUAL PAGE COPY . . . . .                      | 49 |
| 2 IN 1 OR 4 IN 1 . . . . .                    | 51 |
| B/W REVERSE . . . . .                         | 54 |
| XY ZOOM . . . . .                             | 56 |
| TRANSPARENCY . . . . .                        | 59 |
| JOB MEMORY . . . . .                          | 61 |
| ● Storing a job program . . . . .             | 61 |
| ● Deleting a job program . . . . .            | 62 |
| ● Recalling a job program . . . . .           | 63 |

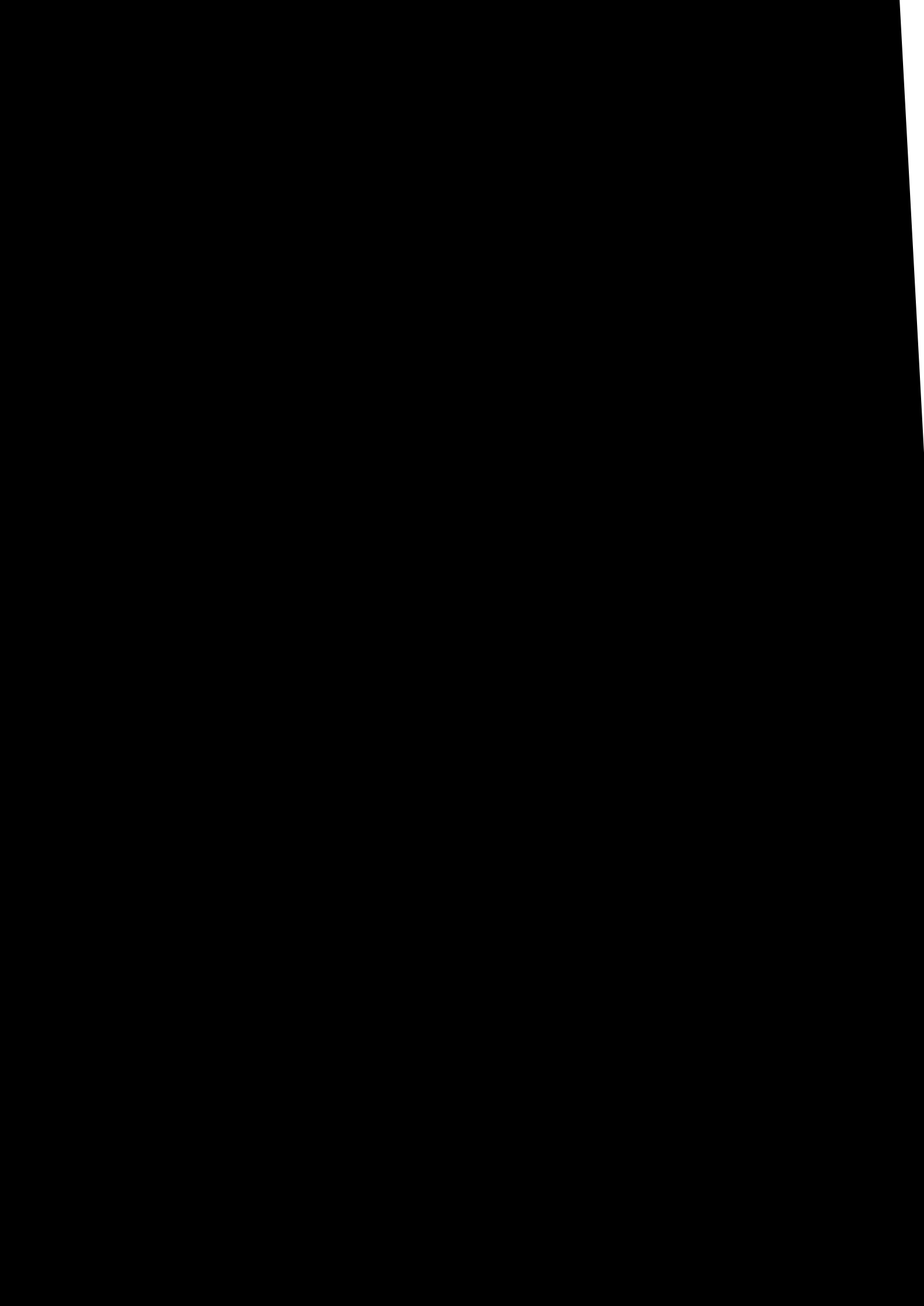



# CHAPTER 1

## GETTING STARTED

This chapter describes the basic information on the use of this copier.

|   | Page |
|---|------|
| ● <b>INTRODUCTION</b> .....                     | 6    |
| ● <b>CAUTIONS</b> .....                         | 7    |
| ● <b>COPIER INSTALLATION</b> .....              | 8    |
| ● <b>MAIN FEATURES</b> .....                    | 10   |
| ● <b>PART NAMES AND FUNCTIONS</b> .....         | 12   |
| Exterior .....                                  | 12   |
| Interior .....                                  | 13   |
| Operation panel .....                           | 14   |
| ● <b>POWER ON AND OFF</b> .....                 | 16   |
| Power on .....                                  | 16   |
| Power off .....                                 | 16   |
| Dehumidification heater switch (DH POWER) ..... | 16   |
| Initial settings .....                          | 17   |
| Power save modes .....                          | 17   |
| ● <b>FUNCTION ICONS</b> .....                   | 18   |
| ● <b>FUNCTION REVIEW</b> .....                  | 19   |
| ● <b>AUDITING ACCOUNTS</b> .....                | 20   |
| How to copy in the auditing mode .....          | 20   |

# INTRODUCTION

This copier has been designed to provide convenient copying features in a minimum amount of office space and with maximum operational ease. To get full use of all copier features, be sure to familiarize yourself with this manual and the copier. For quick reference during copier use, keep this manual in a handy location.

## NOTES:

- This copier can be used as a laser printer, a facsimile machine, and a scanner by installing optional components. However, this manual describes only the copier features. For description of the other features, see the separate relevant manuals.
- All descriptions in this manual are based on the assumption that the COPY mode has been selected (the COPY indicator is on).
- A separate KEY OPERATOR'S GUIDE is written especially for key operators. It contains the programs and programming information that will enable the key operators to tailor functions for maximum benefit.
- The operation procedures and the display on the operation panel vary with installation of optional devices. The descriptions and the illustrations in this manual are mainly for the copier without any option installed.

## Conventions used in this manual



### WARNING:

Warns the user that injury to the user or damage to the copier may result if the contents of the warning are not properly followed.



### CAUTION:

Cautions the user that damage to the copier or one of its components may result if the contents of the caution are not properly followed.

### NOTE:

Notes provide information relevant to the copier regarding specifications, functions, performance, operation and such, that may be useful to the user.

### ★KEY OPERATOR

Information which is relevant to key operator functions is described. The key operator must pay close attention to these notes.



# CAUTIONS

Follow the cautions below when using this copier.



## **WARNING:**

- The fusing area is hot. Exercise care in this area when removing misfed paper.
- Do not look directly at the light source. Doing so may damage your eyes.



## **CAUTION:**

- The socket-outlet should be installed near the equipment and shall be easily accessible.
- Place the copier on a firm, level surface.
- Do not install the copier in a humid or dusty location.
- When the copier is not used for a long time, for example, during prolonged holidays, turn the power switch off and remove the power cord from the outlet.
- When moving the copier, be sure to turn the power switch off and remove the power cord from the outlet.
- Do not cover the copier with a dust cover, cloth or plastic film while the power is on. Doing so may prevent heat dissipation, damaging the copier.
- Do not drop the copier, subject it to shock or strike it against any object.
- Store spare toner cartridges in a cool dry place without removing from the package before use. If they are exposed to direct sunlight or excessive heat, poor copies may result.
- Do not touch the photoconductive drum (green portion). Scratches or smudges on the drum will cause dirty copies.
- Use of controls or adjustments or performance of procedures other than those specified herein may result in hazardous laser radiation exposure.

## **SAFETY PRECAUTIONS**

- This Digital Copier is rated Class 1 and complies with 21 CFR 1040.10 and 1040.11 of the CDRH standards. This means that the copier does not produce hazardous laser radiation. For your safety, observe the precautions below.
- Do not remove the cabinet, operation panel or any other covers.
- The copier's exterior covers contain several safety interlock switches. Do not bypass any safety interlock by inserting wedges or other items into switch slots.

### **"BATTERY DISPOSAL"**

THIS MACHINE CONTAINS MANGANESE DIOXIDE BATTERY WHICH MUST BE DISPOSED OF PROPERLY. CONTACT YOUR SHARP DEALER OR SERVICER FOR INSTRUCTIONS.

This product utilizes tin-lead solder, and a fluorescent lamp containing a small amount of mercury. Disposal of these materials may be regulated due to environmental considerations.

For disposal or recycling information, please contact your local authorities or the Electronics Industries Alliance: [www.eia.org](http://www.eia.org)

# COPIER INSTALLATION

Improper installation may damage the copier. Please note the following during initial installation and whenever the copier is moved.



## CAUTION:

If the copier is moved from a cool place to a warm place, condensation may form inside the copier. Operation in this condition will cause poor copy quality and malfunctions. Leave the copier at room temperature for at least 2 hours before use.

## Do not install your copier in areas that are:

- damp, humid, or very dusty

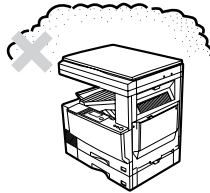

- exposed to direct sunlight

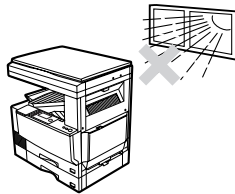

- poorly ventilated

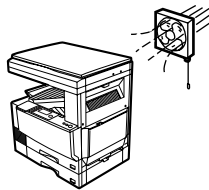

- subject to extreme temperature or humidity changes, e.g., near an air conditioner or heater.

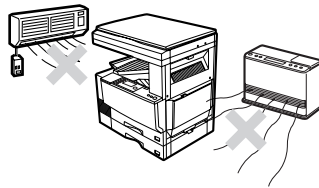

The copier should be installed near an accessible power outlet for easy connection and disconnection.

**Be sure to connect the power cord only to a power outlet that meets the specified voltage and current requirements (See page 89.). Also make certain the outlet is properly grounded.**

**NOTE:**

Connect the copier to a power outlet which is not used for other electric appliances. If a lighting fixture is connected to the same outlet, the light may flicker.

**Be sure to allow the required space around the machine for servicing and proper ventilation.**

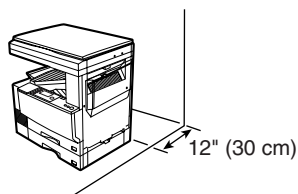

A small amount of ozone is produced within the copier during operation. The emission level is insufficient to cause any health hazard.

**NOTE:**

The present recommended long term exposure limit for ozone is 0.1 ppm (0.2 mg/m<sup>3</sup>) calculated as an 8 hr. time-weighted average concentration. However, since the small amount that is emitted may have an objectionable odor, it is advisable to place the copier in a ventilated area.

# MAIN FEATURES

## 1 High-speed laser copying

- First-copy time at 600 dpi (not in the super photo mode) is only 4.8 seconds (except when recovering from a power save mode or immediately after power on).
- Copying speed is 23 copies/min. (AR-235) or 27 copies/min. (AR-275) at 600 dpi (not in the super photo mode), which lends itself for business use, providing improvement in working efficiency.

## 2 High-quality digital image

- High-quality copying at 600 dpi or 1200 dpi (super photo mode) is performed.
- In addition to the automatic exposure mode, the text, text/photo, photo, and super photo exposure modes can be adjusted in five steps.
- The photo mode and super photo mode copying functions allow clear copying of delicate halftone original images such as monochrome photos and color photos. These modes are adjustable in five steps. The super photo mode allows high resolution copying at 1200 dpi.

## 3 Substantial copying features

- Zoom copies can be made from 25% to 400% in 1% increments at 600 dpi. (At 1200 dpi (super photo mode), the zoom copy ratio range is 50% to 200%.)
- Up to 999 copies can be made in a single run.
- Automatic two-sided copying can be performed.
- Multiple sets of copies can be sorted without the aid of a sorter and each set can be offset from the previous set.
- Useful special features such as erase, margin shift, 2 in 1 and 4 in 1, XY zoom, black and white reverse, and dual page copy are available.

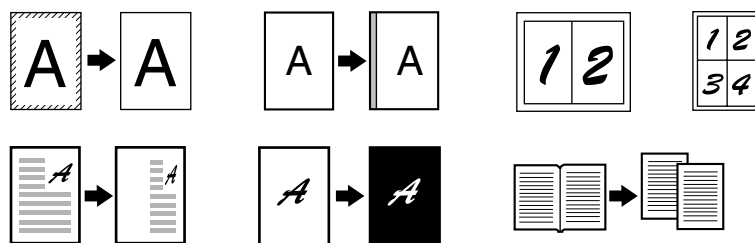

- Key operator programs allow the setting or modification of functions to meet your specific needs. Also the key operator programs allow the internal auditor to be controlled.

## 4 Scan once/ Print many

- The copier is equipped with a memory buffer allowing the copier to scan an original once and make up to 999 copies of the scanned image. This improves workflow, reduces operating noise from the copier and reduces wear and tear on the scanning mechanism, which provides for a higher reliability.

## 5 Optional features

- An optional single pass feeder (SPF) allows automatic document feeding of up to 30 sheets of single-sided originals.
- An optional reversing single pass feeder (RSPF) allows automatic document feeding of up to 30 two-sided originals.
- An optional finisher allows automatic stapling of up to 30 sheets.
- This copier can be used as a laser printer if an optional printer expansion kit is installed.
- This copier can be used as a facsimile machine if an optional facsimile expansion kit is installed.
- This copier can be used as a network scanner if an optional network scanner expansion kit is installed.

## 6 Environmentally friendly design

- Center tray is housed in the copier for saving space.
- Preheat and auto power shut-off modes are provided to reduce power consumption when the machine is not in active use, and meet the ENERGY STAR guidelines.

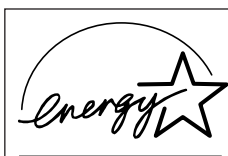

As an ENERGY STAR® Partner, SHARP has determined that this product meets the ENERGY STAR® guidelines for energy efficiency.

# PART NAMES AND FUNCTIONS

## Exterior

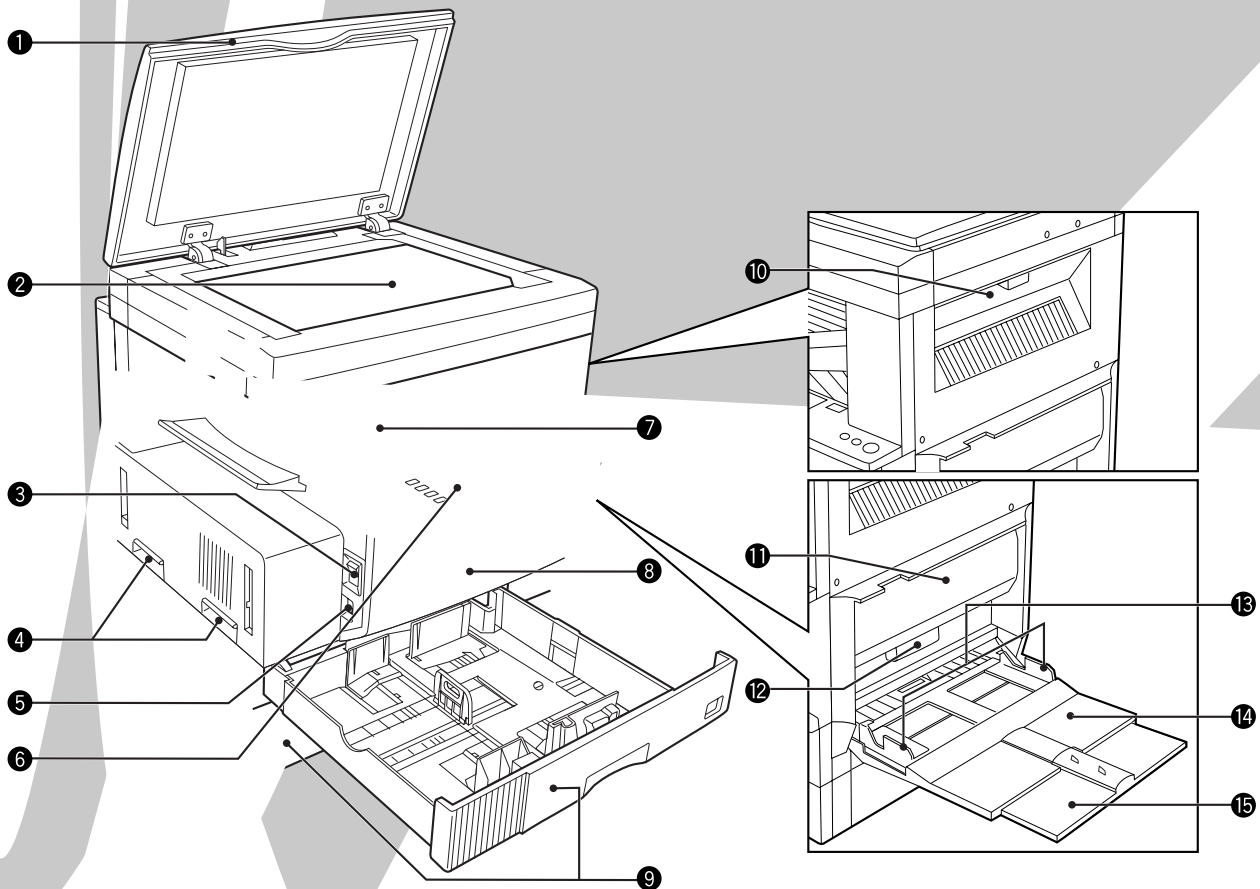

**1 Platen cover (optional) (p. 24)**

Place an original on the platen glass and close the platen cover before copying starts.

**2 Platen glass (p. 24)**

Place an original to be copied here.

**3 Power switch (p. 16)**

Press to turn copier power on and off.

**4 Handles**

Use to move the copier.

**5 Dehumidification heater switch (p. 16)**

Press to turn on the heater to prevent dew condensation inside the copier and moisture absorption of paper.

**6 Operation panel (p. 14)**

All copier controls are located here for easy operation.

**7 Center tray**

Finished copies are deposited in the center tray.

**8 Front cover (p. 68)**

Open to remove misfeeds and for copier servicing.

**9 Paper trays (p. 78)**

Each tray holds 500 sheets of copy paper.

**10 Upper exit area cover (p. 73)**

Open to remove misfeeds when an optional job separator tray kit or finisher is installed.

**11 Side cover (p. 67)**

Open to remove misfeeds.

**12 Side cover handle (p. 67)**

Pull to open the side cover.

**13 Bypass tray paper guides (p. 37)**

Adjust to the width of the copy paper.

**14 Bypass tray (p. 36)**

Paper including special paper (such as transparency film) can be fed from the bypass tray.

**15 Bypass tray extension (p. 36)**

Pull out when feeding large paper such as 8-1/2" x 11"R, 8-1/2" x 14" and 11" x 17".



# Operation panel

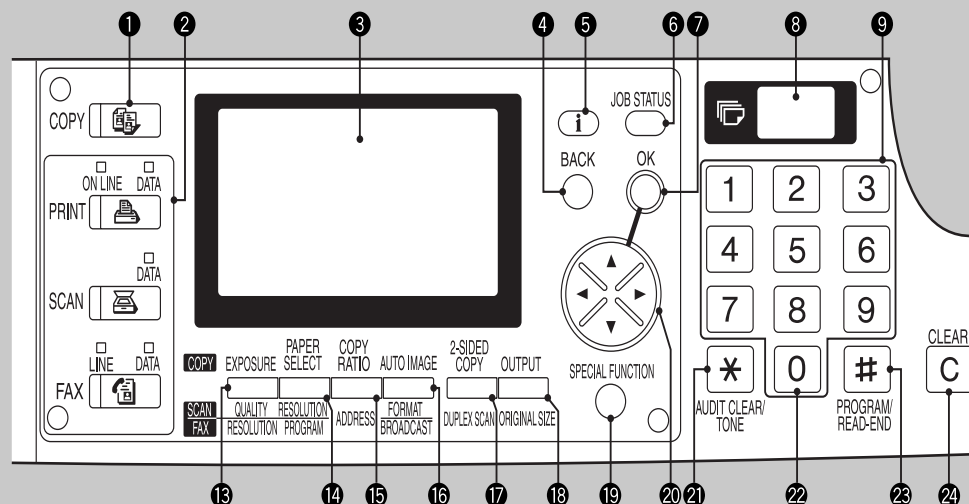

## 1 COPY key and indicator (p. 76, 84)

Press to select the COPY mode.

Press and hold during standby or during warm-up to display the total output count and the quantity of toner remaining.

## 2 Mode keys and indicators

Use these keys when relevant optional components are installed.

## 3 Display

Displays information to assist the operator.

## 4 BACK key

Press to return the display to the previous screen.

## 5 Information (i) key (p. 66)

Press to display the detailed description when **i** is displayed in the upper right-hand corner of the display.

## 6 JOB STATUS key (p. 19)

Press to check the settings of selected functions or the status of reserved output jobs.

## 7 OK key

Press to confirm the selected setting or entered data.

## 8 Copy quantity display

Displays the specified copy quantity during standby and displays the copy countdown as copies are made.

## 9 Numeric keys

Use to select the desired copy quantity.

## 10 INTERRUPT key and indicator (p. 39)

Interrupts a copy run.

## 11 CLEAR ALL key (p. 17)

Clears all selected settings and returns the copier to the initial settings.

## 12 START key and indicator

Copying is possible when the indicator is on. Press to start copying.

## 13 EXPOSURE key (p. 29)

Use to select the exposure modes: AUTO, TEXT, TEXT/PHOTO, PHOTO or SUPER PHOTO.

## 14 PAPER SELECT key (p. 24)

Use to manually select a paper tray.

## 15 COPY RATIO key (p. 33)

Press to select a reduction or enlargement copy ratio.





# POWER ON AND OFF

The power switch is located on the left side of the copier.

## Power on

To turn the copier on, turn the power switch to the "ON" position.

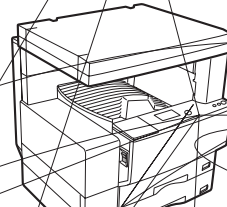
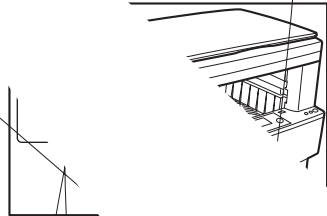

- When the power switch is turned to the "ON" position, the message display will show "System check." and then "Ready to copy." Once the copier has finished warming up, the message display will change to "Ready to copy.", and the START key will be lit, indicating that copying is possible.
- If the copier has been programmed with an account number, the message "Enter your account number." will appear after warming up. After the account number has been entered, the message display will change to "Ready to copy." See page 20.

When the power switch is turned to the "ON" position, the message "System check." will appear in the message display. During warm-up, you can select your desired job settings. Copying will commence when the copier comes to "Ready to copy." After the copier has finished warming up, the message display will change to "Ready to copy.", and the START key will be lit, indicating that copying is possible. If the copier has been programmed with an account number, the message "Enter your account number." will appear after warming up. After the account number has been entered, the message display will change to "Ready to copy." See page 20.

## Power off

When the copier is not used for a long time, ensure that the machine is not operating and the power switch is turned off while the machine is in progress will be totally canceled.

When the power switch is turned to the "OFF" position, the copier will stop operating. Also the job that was in progress will be totally canceled.

## Dehumidification heaters

This copier is equipped with a dehumidification heater, which prevents moisture absorption of paper in the paper trays. In a low temperature season such as winter, moisture absorption of paper, image quality may be deteriorated frequently. It is recommended that the dehumidification heater switch be turned on in the following cases even after the power switch is turned off.

- In a low temperature season such as winter (When a sudden temperature drop occurs, for example, immediately after room heating is turned on, dew condensation may occur.)
- In a high temperature and high humidity season such as summer or rainy season
- In regions at a high temperature and a high humidity

### NOTES:

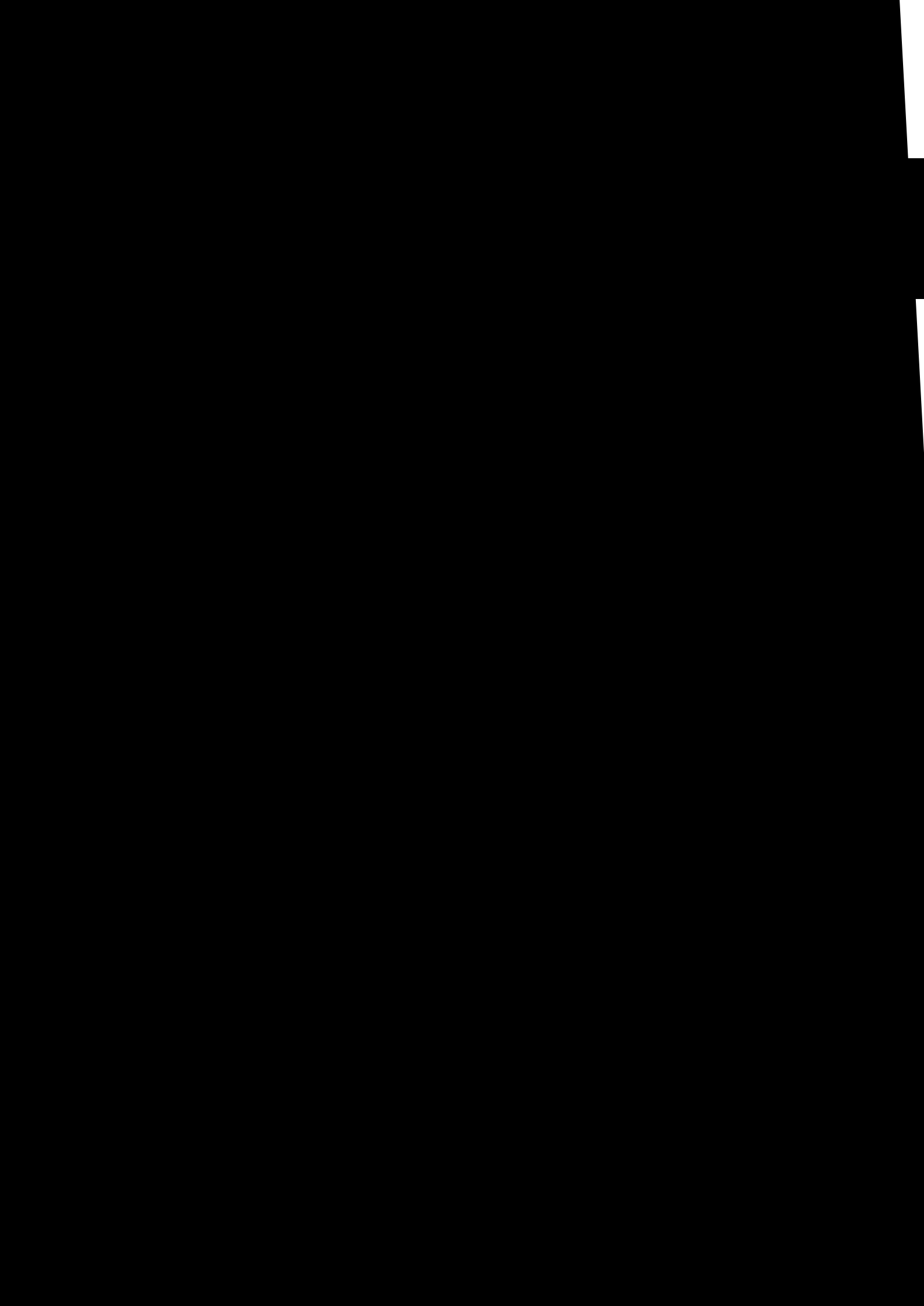

- When using the dehumidification heater, do not remove the power cord from the outlet. If the power cord is removed, the heater will stop operating.
- If an optional 500-sheet paper feed unit or 2x500-sheet paper feed unit is installed, the heater in the unit will also be turned on when the dehumidification heater switch of the copier is turned on.





# FUNCTION ICONS

The following function icons will be indicated on the setting screen of each copier function.



## 2-sided copy mode:

|   |                                |
|---|--------------------------------|
|  | One-sided to two-sided copying |
|  | Two-sided to two-sided copying |
|  | Two-sided to one-sided copying |

## Erase:

|   |                     |
|---|---------------------|
|  | Edge erase          |
|  | Center erase        |
|  | Edge + Center erase |

## Output mode:

|   |                  |
|---|------------------|
|    | Sort mode        |
|   | Staple sort mode |
|  | Group mode       |



## Dual page copy:





## B/W reverse:



## Margin shift:

|   |       |
|---|-------|
|  | Right |
|  | Down  |
|  | Left  |

## 2 in 1 / 4 in 1:

|   |        |
|---|--------|
|  | 2 in 1 |
|  | 4 in 1 |

# FUNCTION REVIEW

The current settings of copier functions that have been selected can be viewed in the display.

- The XY ZOOM and TRANSPARENCY functions cannot be viewed on the function review screen.

## 1 Press the JOB STATUS key.

- The review screen will appear.

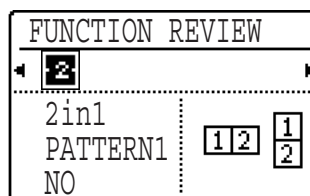
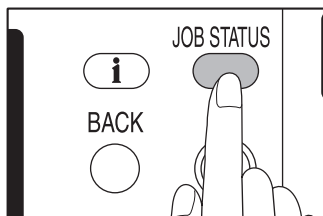

## 2 Use the ◀ and ▶ keys to select a function.

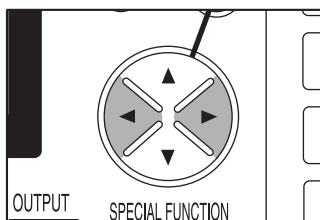

- The setting for the selected function will appear in the display.
- The settings of the duplex copy mode (1-sided to 1-sided, etc.), sort/group mode, and special functions can be displayed. Exposure, paper size, and copy ratio settings which are normally displayed on the basic screen cannot be displayed on the review screen.

## 3 To exit the review screen, press the BACK key.

- The display will return to the basic screen.

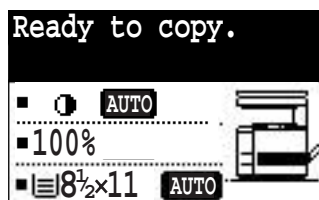



## 2 When copying is completed, press the AUDIT CLEAR key.

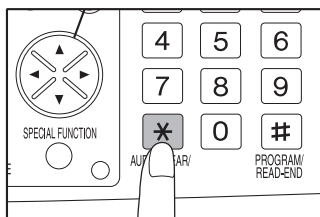

### NOTE:

If an unassigned number is entered, "Enter your account number." will appear again in the display, indicating that the number was not accepted.

When the key operator program for account number security has been set and unassigned numbers are entered three successive times, the copier will not accept another number for one minute, and the following message will appear.

⚠ Please see your  
key operator for  
assistance.

★ **KEY OPERATOR** See page 24 of the KEY OPERATOR'S GUIDE for account number security.





# CHAPTER 2

## MAKING COPIES

This chapter describes the basic copying functions such as normal copying, reduction or enlargement, and exposure adjustments.

|   | Page |
|---|------|
| ● <b>NORMAL COPYING</b> .....                           | 24   |
| ● <b>TWO-SIDED COPYING</b> .....                        | 26   |
| Two-sided copying from the platen glass .....           | 26   |
| ● <b>EXPOSURE ADJUSTMENT</b> .....                      | 29   |
| ● <b>REDUCTION/ENLARGEMENT/ZOOM</b> .....               | 31   |
| Automatic selection .....                               | 31   |
| Manual selection .....                                  | 33   |
| ● <b>ROTATION COPYING</b> .....                         | 35   |
| ● <b>BYPASS FEED (special paper)</b> .....              | 36   |
| Acceptable paper for copying from the bypass tray ..... | 36   |
| Copying from the bypass tray .....                      | 36   |
| ● <b>INTERRUPTING A COPY RUN</b> .....                  | 39   |

# NORMAL COPYING

The basic copying procedure is described below.

- Image loss (max. 5/32" (4 mm)) can occur at the leading and trailing edges of the copies. Also image loss (max. 1/8" (3 mm)) can occur along the other edges of the copies.

**NOTE:**

If the copier has been programmed in the auditing mode, enter a 5-digit account number. See page 20.

- 1 Place an original face down on the platen glass and align it with the original size scale.**

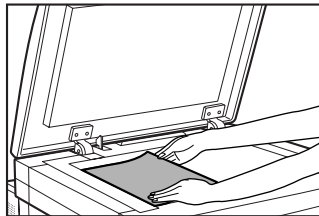

- The detected original size will be indicated in the display.

**NOTE:**

If the original size cannot be detected, the original size can be entered as follows. Press the SPECIAL FUNCTION key. Use the ▲ and ▼ keys to select "ORIG. SIZE ENTER" and then press the OK key. Use the ◀ and ▶ key to select "AB" or "INCH" and use the ▲ and ▼ keys to select the desired original size. Press the OK key.

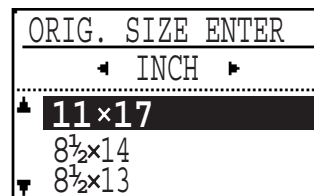

- 2 Close the platen cover.**

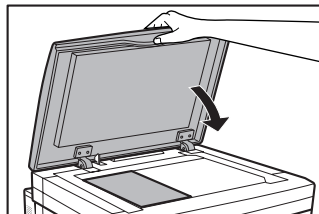

- Paper matching the size of the original will be automatically selected when the auto paper select function has been enabled. To copy onto paper of a different size, press the PAPER SELECT key.
- Paper of the different orientation may be selected if the auto paper select or auto image function has been selected. In this case, the image of the original will be rotated and copied. See page 35.
- ★ **KEY OPERATOR** The auto paper select function can be disabled using a key operator program. If this function is disabled, use the PAPER SELECT key to select the desired paper tray. See page 18 of the KEY OPERATOR'S GUIDE.

... by 1 ea  
... original, sin

... middle of a ru

... been folded o  
... shadow lines c

... allow copying of b  
... backward angle. To r

... city of the center tray is 500 sheets (400 sheets  
... number of copies output reaches this limit, copy  
... move the copies from the center tray and pres

... sizes).  
... indicator will  
... g.

COPY MODE

\_\_\_\_\_

\_\_\_\_\_

\_\_\_\_\_

- 7** Place the second original face down on the platen glass and press the **START** key again.

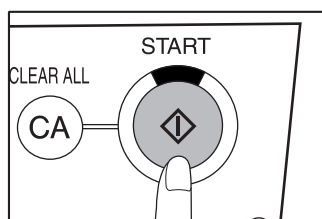

- To stop a copy run during duplex copying, press the CLEAR key.
- To cancel the duplex copy mode, press the 2-SIDED COPY key, select the one-sided to one-sided mode, and press the OK key.
- If an uneven number of originals are being copied, press the READ-END key after the last original is scanned. The last copy will be output single-sided.

# EXPOSURE ADJUSTMENT

This copier has five exposure modes to choose from: AUTO, TEXT, TEXT/PHOTO, PHOTO, and SUPER PHOTO.

## Auto

This is the standard initial setting for this copier. In this mode, the characteristics of an original being copied are "read" by the exposure system, and exposure adjustments are made automatically. This optimizes the contrast of the copied images by reducing the effect of colored or shaded background areas.

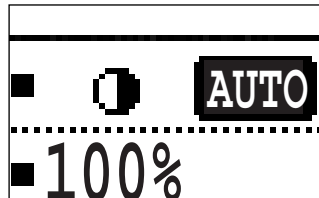

## Text, text/photo, photo, and super photo

**Text mode:** This mode is useful for enhancing very low density areas of an original or suppressing unusually high-density background areas.

**Text/photo mode:** This mode provides the best balance for copying an original which contains both text and photos. This mode is also useful for copying printed photographs.

**Photo mode:** This mode is good for copying photographs with fine details.

**Super photo mode:** This is a high resolution mode (1200 dpi) for providing the best copies of photographs.

### 1 Press the EXPOSURE key.

- The exposure adjustment screen will appear.

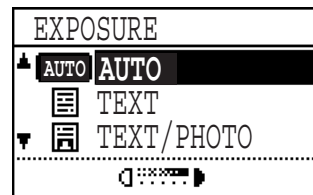
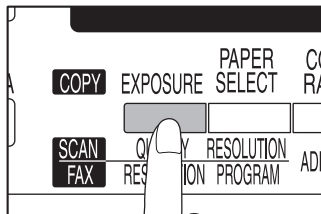

### 2 Use the ▲ and ▼ keys to select "TEXT", "TEXT/PHOTO", "PHOTO" or "SUPER PHOTO" depending on the type of original to be copied.

- Also the EXPOSURE key can be used to select an exposure mode.

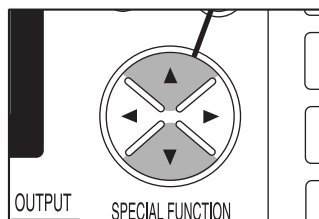

## EXPOSURE ADJUSTMENT

### 3 Use the ◀ and ▶ keys to adjust the copy density as desired.

- Copy density cannot be adjusted manually in the AUTO exposure mode.

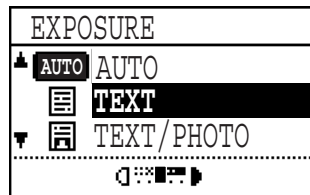
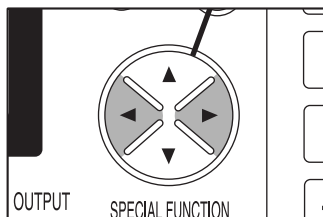

### 4 Press the OK key.

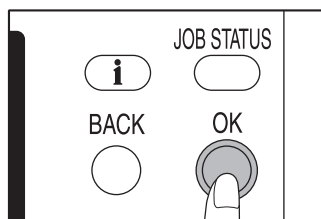

- To return to the AUTO mode, press the EXPOSURE key, use the ▲ and ▼ key to select "AUTO", and press the OK key.

#### NOTE:

When the SUPER PHOTO mode is selected, the copy ratio is limited to be within the 50% to 200% range when copying from the platen glass and within the 50% to 141% range when using an optional SPF or RSPF.



# REDUCTION/ ENLARGEMENT/ZOOM

Reduction and enlargement ratios can be selected either automatically with the AUTO IMAGE key or manually with the COPY RATIO key. The zoom function enables precise copy ratio selection from 25% to 400% in 1% increments.

- The allowable copy ratio range is limited to the following conditions:

| Exposure mode          | Location of original | Copy ratio range |
|------------------------|----------------------|------------------|
| Other than SUPER PHOTO | SPF/RSPF (optional)  | 50% to 200%      |
| SUPER PHOTO            | Platen glass         | 50% to 200%      |
| SUPER PHOTO            | SPF/RSPF (optional)  | 50% to 141%      |

## Automatic selection

- When the auto image function is enabled, the reduction or enlargement ratio cannot be selected manually.

### 1 Place an original on the platen glass and close the platen cover.

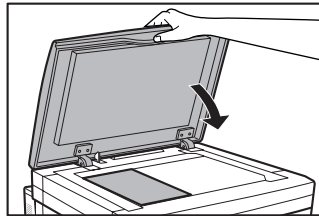

- The original size will be automatically detected and indicated in the display. If the original is a non-standard size, it cannot be detected. In this case, press the SPECIAL FUNCTION key to enter the original size. See page 24.

### 2 Use the PAPER SELECT key to select the paper tray with the desired paper size.

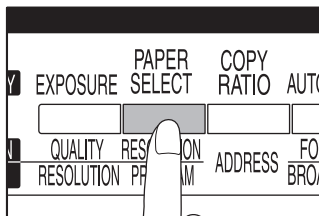

- This feature will not work when copy paper of non-standard size is used.

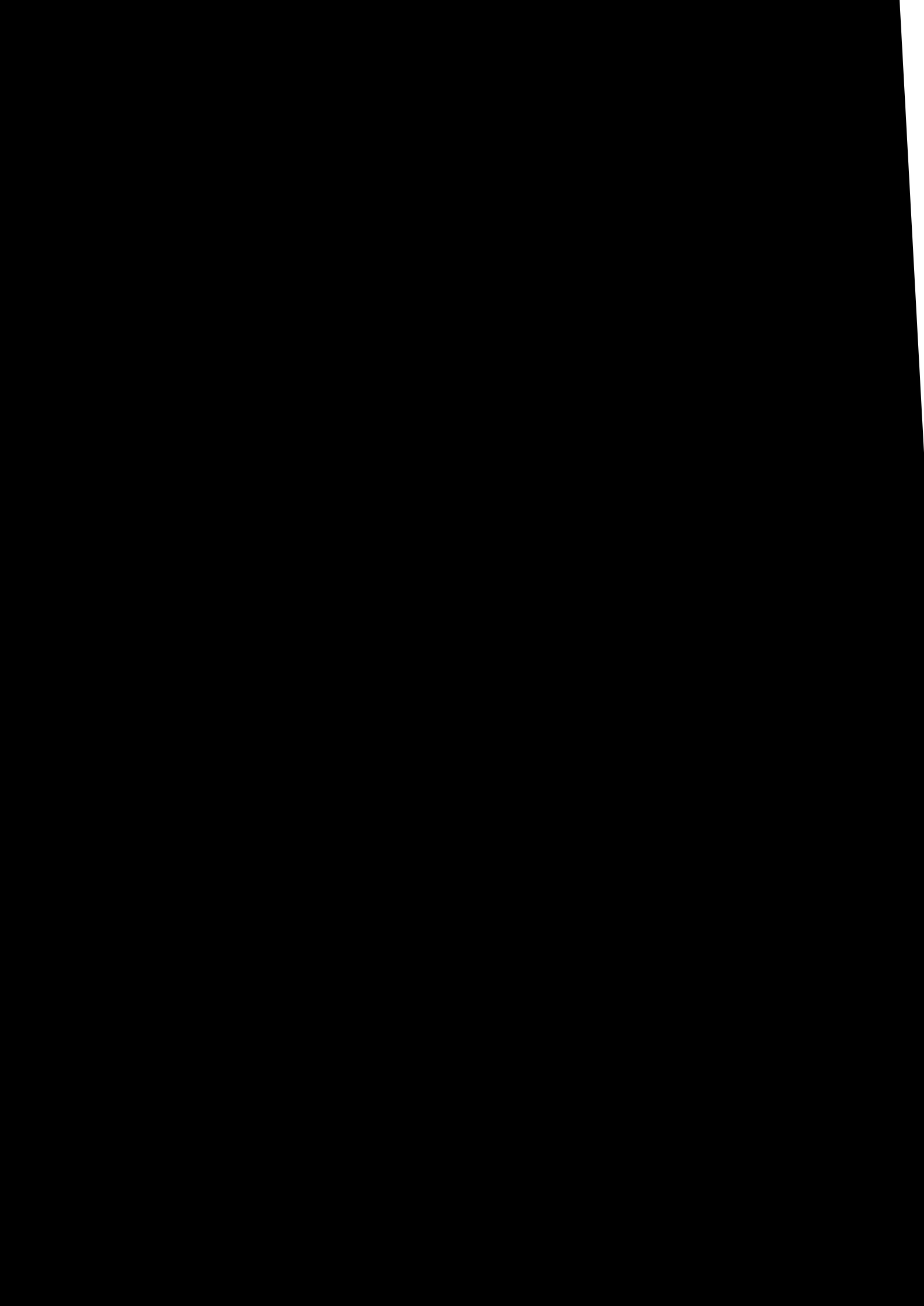

## Manual selection

- 1 Place an original on the platen glass and close the platen cover.

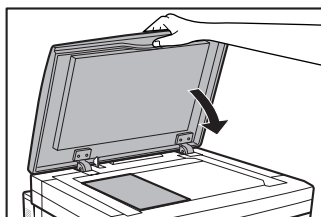

- 2 Press the COPY RATIO key.

- The copy ratio adjustment screen will appear.

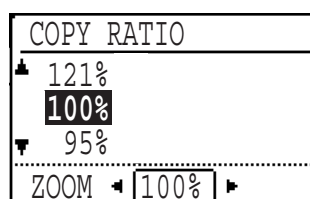
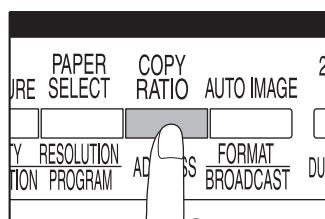

- 3 Use the ▲ and ▼ keys to select a preset copy ratio or use the ◀ and ▶ keys to select a zoom ratio.

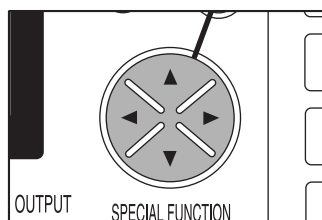

- A. Preset reduction ratios are: 95%, 77%, 64%, 50%, and 25%.
- B. Preset enlargement ratios are: 121%, 129%, 141%, 200%, and 400%.
- C. Zoom ratios: Any ratio from 25% to 400% can be set, in 1% increments. Use the ▲ and ▼ keys to set the approximate ratio, then press the ◀ key to decrease the ratio or the ▶ key to increase the ratio.
  - To decrease or increase the zoom ratio rapidly, press and hold down the ◀ or ▶ key. However the value will stop at the preset reduction or enlargement ratios. To move beyond these ratios, release the key and then press and hold it down again.
- D. Same-size reset: Press the ▲ or ▼ key repeatedly until the copy ratio returns to 100%.

**NOTE:**

If the COPY RATIO key is pressed, the copy ratio will be reset to 100%.

**4** Press the OK key.

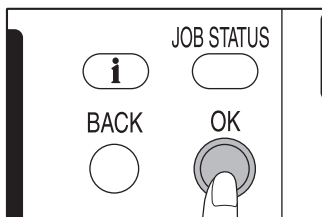

- The display will return to the basic screen.

**5** Ensure that the desired paper tray is selected.

- If the auto paper select function has been enabled, the appropriate copy paper size will have been automatically selected based on the original size and the selected copy ratio.
- If the auto paper select function has been disabled or if copying onto a different size paper, use the PAPER SELECT key to select the paper feed station with the desired paper size.

**6** Set the number of copies and press the START key.

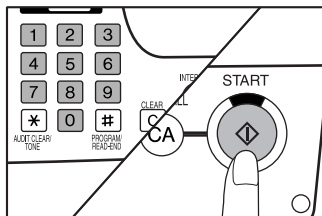

# ROTATION COPYING

If rotation of original image is enabled using a key operator program, the image of the original will rotate when the orientation of the original does not match that of the copy paper. Rotation copying will function only if the auto paper select mode or the auto image mode has been selected. Even if rotation of original image is disabled using a key operator program, rotation copying will function when the 2 in 1 or 4 in 1 function is selected. However, if enlargement copying onto a paper size larger than 8-1/2" x 11" (A4) is performed, the image cannot be rotated. In this case, the original must be rotated 90°. If the margin shift feature is set, rotation copying will not function.

★**KEY OPERATOR** See page 12 of the KEY OPERATOR'S GUIDE for enabling/disabling rotation copying.

Example: Copying from an 11" x 17" original onto 8-1/2" x 11" paper

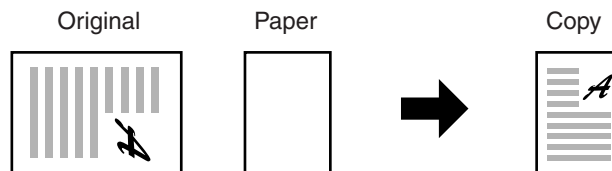

**1** Place an original on the platen glass and close the platen cover.

**2** Use the PAPER SELECT key to select the desired tray.

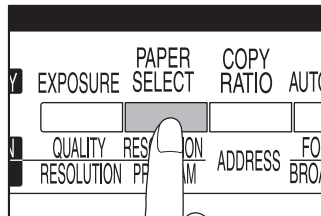

**3** Press the AUTO IMAGE key.

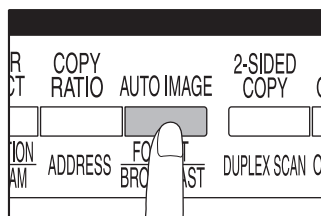

- The appropriate copy ratio will be automatically selected for rotation copying.

**4** Set the number of copies and press the START key.

**NOTE:**

Images of originals may also be rotated in the auto paper select mode.

# BYPASS FEED (special paper)

The bypass tray must be used to feed special papers such as transparency film and labels but can also be used to feed standard copy paper.

## Acceptable paper for copying from the bypass tray

| Size   | Weight                                  | Capacity (21 lb. bond paper) | Special paper                          |
|--|---|------------------------------|--|
| Ordinary paper: 5-1/2" x 8-1/2" to 11" x 17"   | 14 lbs. to 34 lbs.*<br>(Ordinary paper) | 100 sheets                   | Transparency film, labels, envelopes** |
| Envelopes: Commercial 10 (4-1/8" x 9-1/2"), International DL (110 x 220 mm), International C5 (162 x 229 mm) |   |                              |  |

\* For paper weighing from 28 to 34 lbs., 8-1/2" x 11" is the maximum size that can be fed through the bypass tray.

\*\*Do not use envelopes that have metal clasps, plastic snappers, string closures, windows, linings, self-adhesive patches or synthetic materials. These will cause physical damage to the copier.

- For best results, use only paper recommended by SHARP.
- Special papers except SHARP recommended transparency film, labels, and envelopes must be fed one sheet at a time through the bypass tray. Up to 40 sheets of SHARP recommended transparency film and labels can be set at one time. Up to 5 envelopes can be set at one time.
- When feeding two or three hole prepunched paper, load the paper so that the punched edge is not positioned in the feed slot.

## Copying from the bypass tray

### 1 Unfold the bypass tray.

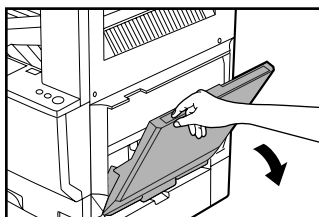

- When feeding 8-1/2" x 11"R, 8-1/2" x 14" or 11" x 17" sized paper, extend the bypass tray to support the paper.

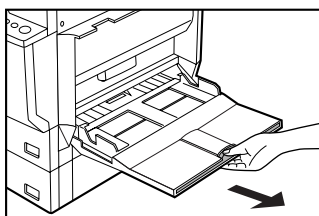

2 Set the paper guides to the copy paper width.

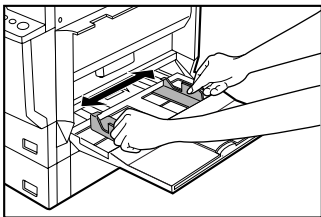

3 Insert the copy paper (print face down) all the way into the bypass tray.

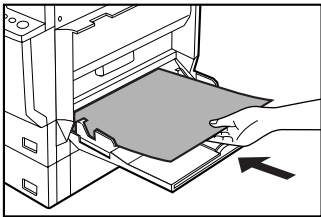

- For the number of sheets which can be loaded into the tray, see the previous page.
- When adding paper, first remove any paper remaining in the tray, combine it with the paper to be added and then reload as a single stack. The paper to be added must be the same size and type as the paper already in the tray.
- When loading envelopes, make sure that they are straight and flat and do not have loosely glued construction flaps (not the closure flap).

4 Press the PAPER SELECT key to select the bypass tray.

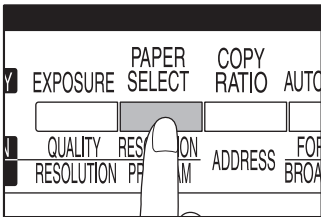

**NOTE:**  
 When copying onto paper that is fed from the bypass tray, the print start position in the vertical direction can be adjusted as follows. Press the SPECIAL FUNCTION key. Use the ▲ and ▼ key to select "EXTRA IMAGE ADJ." and then press the OK key. Use the ▲ and ▼ key to adjust the print start position to the front (+) or to the rear (-). Press the OK key. The position can be adjusted from -0.5 inch to +0.5 inch in 0.02 inch increments.  
 This feature can be used only for extra size paper (indicated as "EXTRA" in the display) placed in the bypass tray and cannot be used for standard size paper.

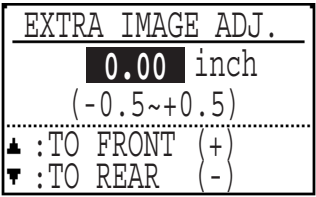

## BYPASS FEED (special paper)

---

### 5 Set the number of copies and press the START key.

**NOTE:**

The bypass tray can be used to copy onto the two sides of paper manually.

When copying the second original, be sure to turn over the copy of the first original left to right and place it into the bypass tray as shown in the illustration.

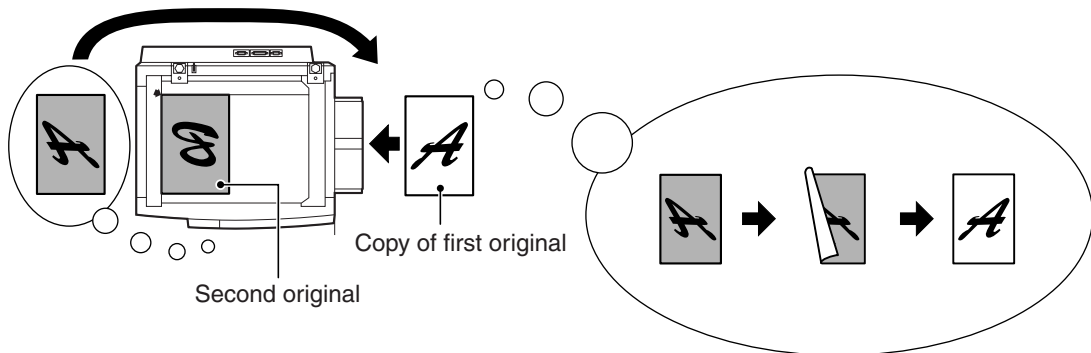



# INTERRUPTING A COPY RUN

INTERRUPT is used to interrupt a long copy run so that another job can be done.

- Two-sided and 2 in 1/ 4 in 1 copying jobs cannot be interrupted.
- Two-sided copying, sort, group, staple sort, job programs and 2 in 1/ 4 in 1 cannot be selected for interrupt copying. Key operator programs cannot be used in the interrupt mode.

## 1 Press the INTERRUPT key.

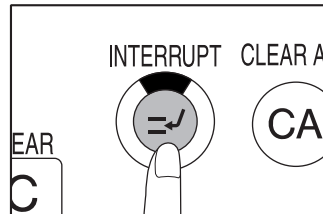

- If INTERRUPT is pressed during copying from the platen glass, the copier will stop and return to the initial settings after the copy in progress has been completed.
- If INTERRUPT is pressed during copying when an optional SPF or RSPF is being used, the copier will stop after completing copying of any original which has been fed by the SPF or RSPF.
- If this copier has been programmed in the auditing mode, the account number entry message will appear. Enter your account number using the numeric keys. The number of copies of the interrupt copying will be accumulated against this account number. See page 20.

## 2 When the copier stops, remove the original(s) of the current job and set an original for interrupt copying.

## 3 Select the desired available copier functions.

## 4 Set the number of copies and press the START key.

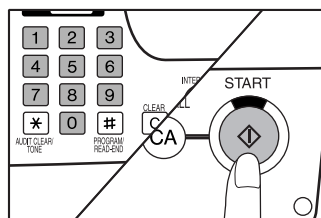

- The interrupt copies will be offset from the previous copies unless the offset function is disabled.
- ★ **KEY OPERATOR** See page 13 of the KEY OPERATOR'S GUIDE for the offset function.

## INTERRUPTING A COPY RUN

---

- 5** When all INTERRUPT copies are finished, press the INTERRUPT key again to cancel the INTERRUPT mode, and remove the original used for interrupt copying.

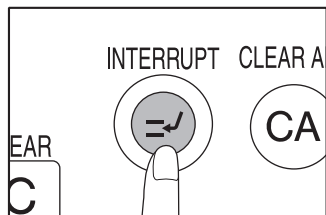

- All settings for the interrupted job will be automatically restored.

- 6** Replace the original(s) for the interrupted job and press the START key to resume copying.

# CHAPTER 3

## SPECIAL FUNCTIONS

This chapter describes special copying functions including various image editing functions.

|   | Page |
|---|------|
| ● <b>SORT/GROUP</b> .....               | 42   |
| Copying in the sort or group mode. .... | 42   |
| ● <b>MARGIN SHIFT</b> .....             | 45   |
| ● <b>ERASE</b> .....                    | 47   |
| ● <b>DUAL PAGE COPY</b> .....           | 49   |
| ● <b>2 IN 1 OR 4 IN 1</b> .....         | 51   |
| ● <b>B/W REVERSE</b> .....              | 54   |
| ● <b>XY ZOOM</b> .....                  | 56   |
| ● <b>TRANSPARENCY</b> .....             | 59   |
| ● <b>JOB MEMORY</b> .....               | 61   |
| Storing a job program .....             | 61   |
| Deleting a job program .....            | 62   |
| Recalling a job program .....           | 63   |

# SORT/GROUP

The copier has two sorter modes for different copying jobs: one sorts copies into sets matching the sequence of the originals and the second groups copies by originals.

## Sort mode

Sets of copies will be sequentially delivered to the center tray.

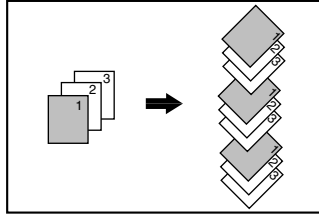

## Group mode

Multiple copies of each original will be grouped in the center tray.

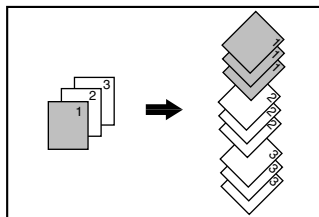

## Copying in the sort or group mode

When copying from the platen glass in the sort or group mode or from the document feeder tray in the group mode, original images will be stored in the copier memory each time an original is scanned and copying will start after all originals have been scanned. However, if originals are set in the document feeder tray and the sort mode is selected, copying will start immediately after the first original is scanned.

### 1 Place an original on the platen glass or in the document feeder tray.

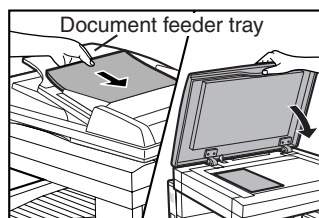

- If originals are placed in the document feeder tray, the sort mode will be automatically selected. This setting, however, can be canceled using a key operator program.
- ★ **KEY OPERATOR** See page 13 of the KEY OPERATOR'S GUIDE for sort auto select.

**2 Press the OUTPUT key.**

- The output mode selection screen will appear.

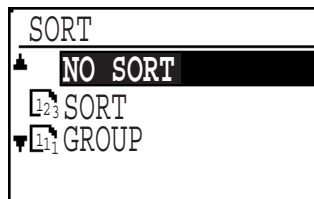
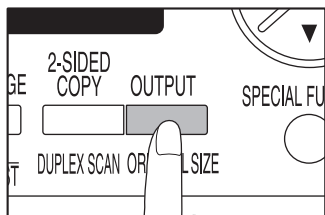

**3 Use the ▲ and ▼ keys to select the desired output mode and press the OK key.**

- Also the OUTPUT key can be used to select an output mode.

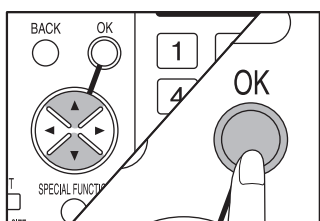

**4 Make all other desired copier selections and press the START key.**

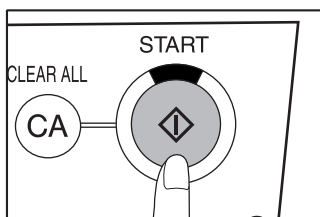

- If originals have been set in an optional SPF or RSPF in step 1, copying will start. If an original has been set on the platen glass, proceed to the next step.

**5 Replace the finished original with the next original and press the START key after it lights up. Repeat this step until all originals have been scanned.**

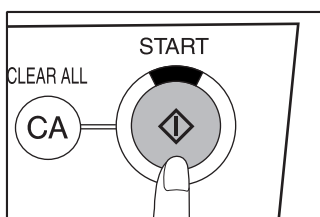

- If the non-sort mode has been selected in step 3, copying will start each time the START key is pressed.



### 6 After all originals have been scanned, press the READ-END key.

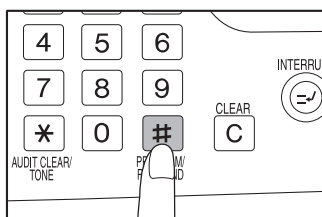

- Copying will start.
- If the memory becomes full of scanned original image data, a warning message will appear. Press the START key to start copying the data in memory or the CLEAR ALL key to cancel copying.
- The memory can be extended to a maximum of 272 MB to increase the capacity for storing image data by adding commercially available memory modules. Please contact your service center for details.

### Offset stack

If the offset stack mode is enabled using a key operator program, each copy set will be offset by approximately 1 inch (25 mm) from the previous set. When copying in the sort mode, collated sets of copies will be made and each collated set of copies produced will be stacked offset from the previous set in the center tray. When copying in the group mode, groups of multiple copies from the same original will be made and each group produced will be stacked offset from the previous group in the center tray.

If the offset stack mode is disabled, copies will not be offset.

The offset stack mode is enabled in the factory default setting.

★ **KEY OPERATOR** See page 13 of the KEY OPERATOR'S GUIDE for the offset function.



## MARGIN SHIFT

### 3 Press the OK key.

- The setting screen for MARGIN SHIFT will appear.

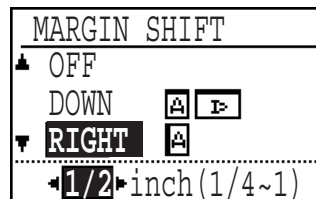
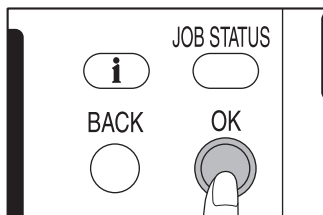

### 4 Use the ▲ and ▼ keys to select the shift direction and the ◀ and ▶ keys to select the shift amount.

- Select the shift direction from DOWN, RIGHT, and LEFT.
- Select the shift amount from 1/4", 1/2", 3/4", and 1".

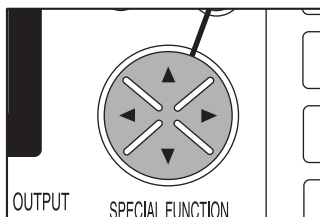

### 5 Press the OK key.

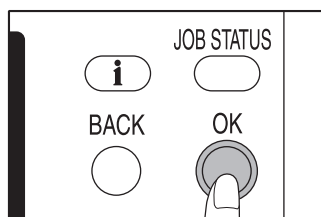

- The display will return to the basic screen.

### 6 Make all other desired copier selections and press the START key .

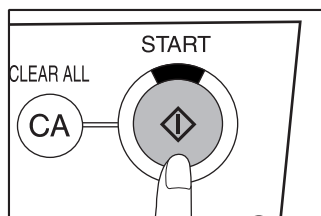

- To cancel the margin shift feature, select the margin shift feature again and select "OFF".



# ERASE

This copier has an edge erase mode and a center erase mode.

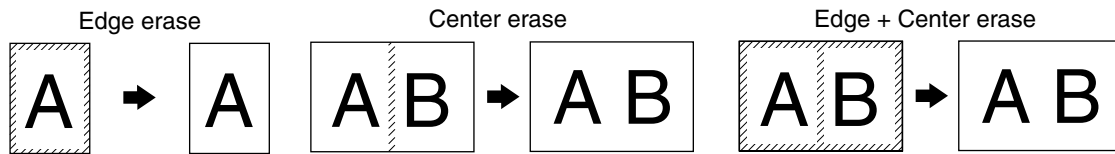

- Edge erase can be used to eliminate shadow lines around the edges of copies which appear when thick paper or a book is used as an original.
- Center erase can be used to eliminate the shadow produced by the bindings of bound documents.
- Edge + center erase can be used together to eliminate both types of shadow lines.
- The standard erase width is 1/2", but can be changed from 1/4" to 1" in 1/4" increments.
- ★ **KEY OPERATOR** The initial setting of the width for edge erase and center erase can be changed. See page 11 of the KEY OPERATOR'S GUIDE.
- This feature cannot be used with the 2 in 1 or 4 in 1 feature.
- If the dual page copy feature has been set, center erase and edge + center erase cannot be set.
- This feature cannot be used with non-standard size originals.

## 1 Place an original on the platen glass or in the document feeder tray.

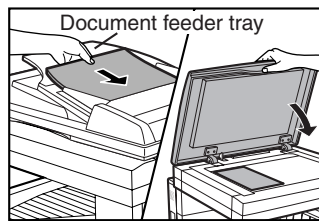

## 2 Press the SPECIAL FUNCTION key. Then press the OK key.

- The SPECIAL MODES screen will appear.

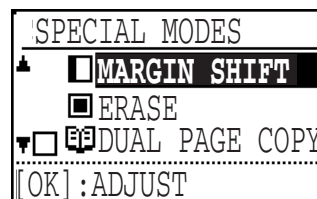
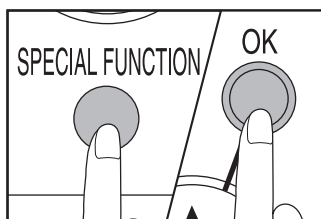

## 3 Use the ▲ and ▼ keys to select "ERASE" and press the OK key.

- The setting screen for ERASE will appear.

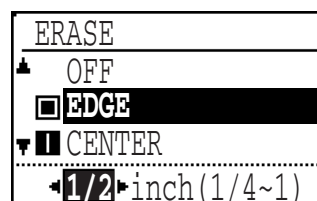
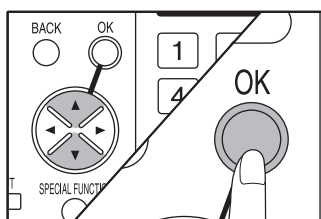

## ERASE

---

---

### **4** Use the and keys to select the desired erase mode.

- Select "EDGE", "CENTER" or "EDGE + CENTER".

---

### **5** Use the and keys to adjust the amount of erase if needed.

---

### **6** Press the OK key.

- The display will return to the basic screen.

---

### **7** Make all other desired copier selections and press the START key .

-

# DUAL PAGE COPY

The DUAL PAGE COPY feature produces individual copies of two documents placed side by side on the platen glass. It is especially useful when copying books and other bound documents.

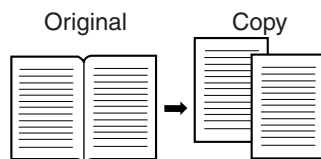

- This feature can be used in the one-sided to two-sided copying mode.
- This feature cannot be used with the 2 in 1 / 4 in 1, center erase, edge + center erase, enlargement or staple sort features.
- If this feature is selected when the auto image feature has been selected, the auto image feature will be canceled.
- When originals are set in an optional SPF or RSPF, this feature cannot be selected.

- 1 Place the originals on the platen glass with the center of the two pages aligned with the paper size index (  8½ ). Close the platen cover.**

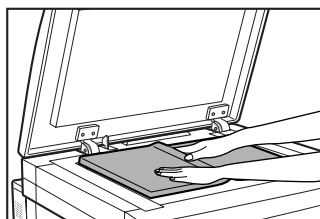

- Set the page to be copied first to the right of the paper size index mark.

- 2 Press the SPECIAL FUNCTION key. Then press the OK key.**

- The SPECIAL MODES screen will appear.

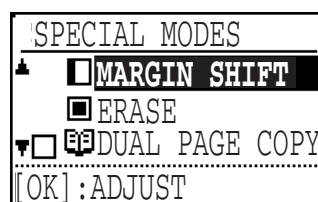
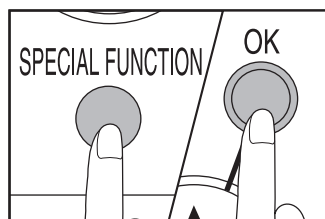

---

---

**"DUAL PAGE COPY" and press the OK**

"DUAL PAGE C

---

1

# 2 IN 1 OR 4 IN 1

The 2 in 1 or 4 in 1 feature is used to copy 2 or 4 originals, collectively in a specified order, onto one sheet.

2 in 1 copying

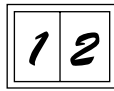

Pattern ①

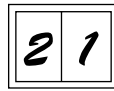

Pattern ②



Pattern ①



Pattern ②

4 in 1 copying

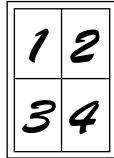

Pattern ①

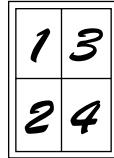

Pattern ②



Pattern ③



Pattern ④

- These features cannot be used with the dual page copying, XY zoom, erase or margin shift features.
- Copies can be made with or without the border lines.
- The order of originals which will be arranged on the copies can be selected. There are two patterns of layout for 2 in 1 copying and four patterns of layout for 4 in 1 copying.
- Non-standard size paper cannot be used with the 2 in 1 or 4 in 1 feature.
- If this feature is set, the copy ratio will be automatically set and cannot be changed manually.
- The 2 in 1 or 4 in 1 feature cannot be set for interrupt copying. While 2 in 1 or 4 in 1 is being set, interrupt will not function.

## 1 Place an original on the platen glass or in the document feeder tray.

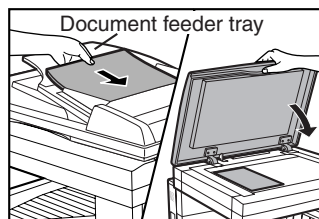

## 2 Use the PAPER SELECT key to select the paper tray with the desired paper size.

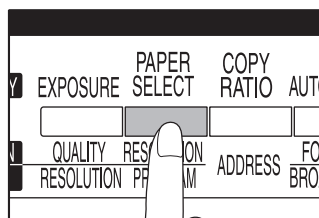



**7 Use the ◀ and ▶ keys to select a type of border line.**

- Select the solid line, broken line or no border line.

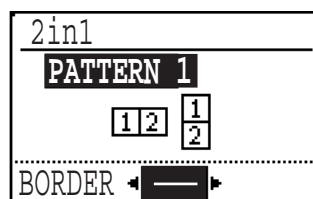
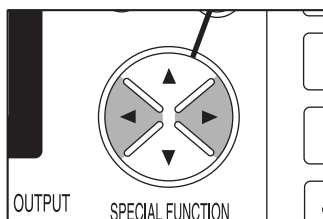
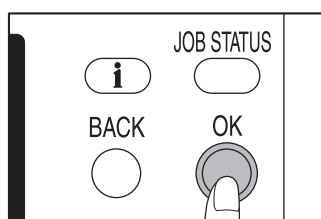
**8 Press the OK key.**

- The display will return to the basic screen.

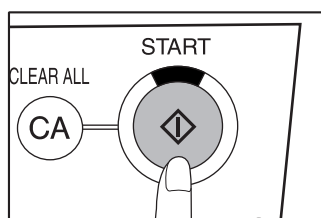
**9 Make all other desired copier selections and press the START key .**

- The copy ratio will be calculated automatically.
- If an optional SPF or RSPF is used, copying will start after originals are scanned.
- If the platen glass is used, proceed to the next step.

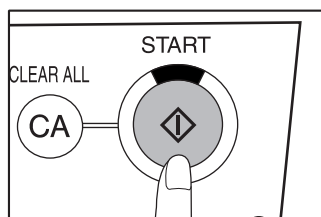
**10 Replace the finished original with the next original and press the START key after it lights up. Repeat this step until all originals have been scanned.**

- Copies will be output each time two originals for 2 in 1 copy or four originals for 4 in 1 copy have been scanned.
- To start copying before scanning all originals for a copy (after only one original for 2 in 1 or three originals or less for 4 in 1 have been scanned), press the READ-END key.
- Portions of original images may not be copied depending on the original and copy paper sizes and the number of images to be copied onto a page.
- Depending on the number of originals and the orientation of the originals and copy paper, the image of originals may be rotated.
- To cancel the 2 in 1 / 4 in 1 feature, select the 2 in 1 / 4 in 1 feature again and select "OFF".

# B/W REVERSE

The B/W REVERSE feature is used to reverse black and white areas.

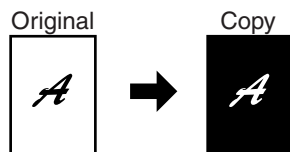

- When the B/W REVERSE feature is selected, the exposure mode will be automatically set to the TEXT mode. Other exposure modes cannot be selected. Even if this feature is canceled, the TEXT mode will not automatically be canceled.

## 1 Place an original on the platen glass or in the document feeder tray.

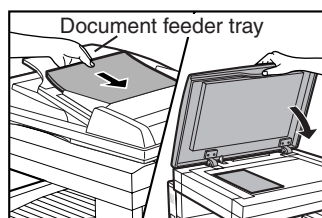

## 2 Press the SPECIAL FUNCTION key. Then press the OK key.

- The SPECIAL MODES screen will appear.

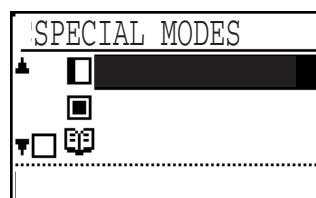
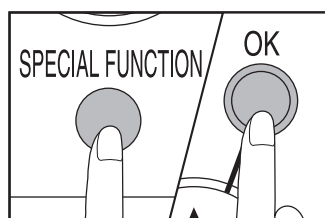

## 3 Use the and keys to select "B/W REVERSE" and press the OK key.

- A check mark will appear to the left of "B/W REVERSE", and the display will return to the basic screen.



**4** Make all other desired copier selections and press the **START** key .

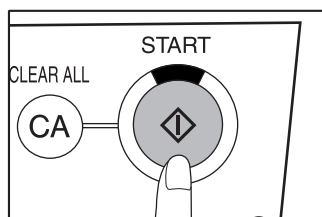

- To cancel the B/W reverse feature, highlight "B/W REVERSE" with a check mark on the SPECIAL MODES screen and press the OK key.

# XY ZOOM

The XY ZOOM feature allows the horizontal and vertical copy ratios to be changed independently.

Example: Reduction only in the horizontal direction

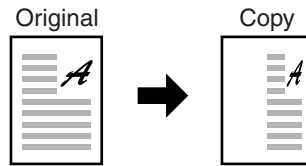

- This feature cannot be used with the 2 in 1 or 4 in 1 feature.
- To use the XY ZOOM feature with the DUAL PAGE COPY feature, set the DUAL PAGE COPY feature first and then the XY ZOOM feature. (Enlargement cannot be set.)
- The copy ratios can be set from 25% to 400%. However, the allowable copy ratio range is limited to the following conditions:

| Exposure mode          | Location of original | Copy ratio range |
|------------------------|----------------------|------------------|
| Other than SUPER PHOTO | SPF/RSPF (optional)  | 50% to 200%      |
| SUPER PHOTO            | Platen glass         | 50% to 200%      |
| SUPER PHOTO            | SPF/RSPF (optional)  | 50% to 141%      |

- If the auto image function has been set, the XY ZOOM feature cannot be set. If the XY ZOOM feature is set, the auto image function cannot be set.

## 1 Place an original on the platen glass or in the document feeder tray.

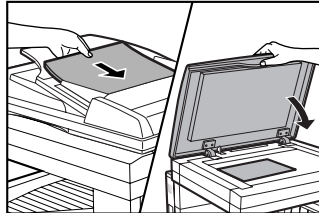

## 2 Press the SPECIAL FUNCTION key. Then press the OK key.

- The SPECIAL MODES screen will appear.

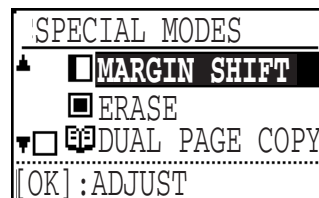
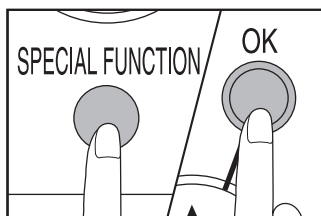

**3 Use the ▲ and ▼ keys to select "XY ZOOM" and press the OK key.**

- The setting screen for XY ZOOM will appear. The copy ratio in the horizontal direction will be highlighted.

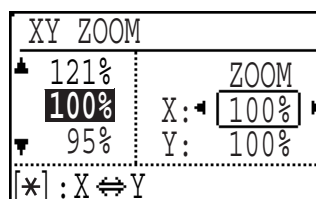
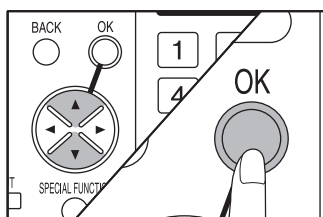

**4 Use the ▲, ▼, ◀, and ▶ keys to change the copy ratio in the horizontal direction.**

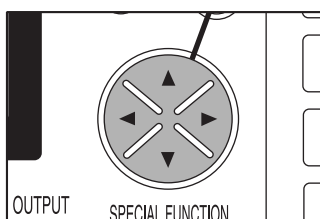

- Use the ▲ and ▼ keys to set the approximate ratio, then press the ◀ key to decrease the ratio or ▶ key to increase the ratio.

**5 Press the [\*] key.**

- The copy ratio in the vertical direction will be highlighted.

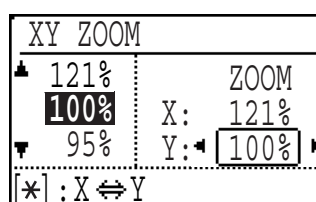
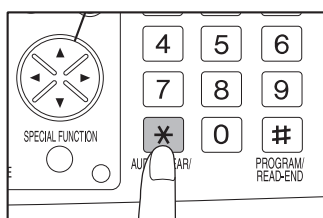

**6 Use the ▲, ▼, ◀, and ▶ keys to change the copy ratio in the vertical direction.**

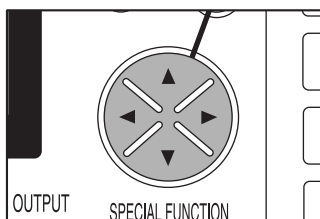

- To change the copy ratio in the horizontal direction again, press the [\*] key.

3

SPECIAL FUNCTIONS

**7 Press the OK key.**

- The display will return to the basic screen.

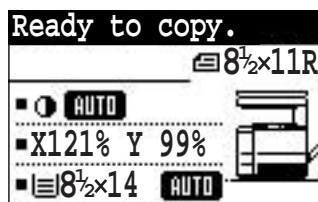
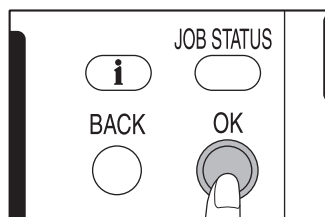

**8 Ensure that the desired paper tray is selected.**

- If the auto paper select function has been enabled, the appropriate copy paper size will have been automatically selected based on the original size and the selected copy ratios. Image rotation may occur.

**9 Make all other desired copier selections and press the START key .**

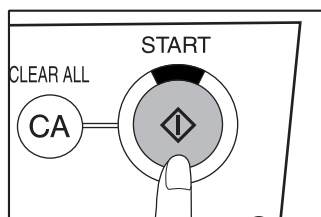

- To cancel the XY zoom feature, press the COPY RATIO key. A confirmation display will appear. Select "OFF" and press the OK key. Set the copy ratio again if needed. If you select "ADJUST" and press the OK key, the copy ratio for XY ZOOM can be set.

# TRANSPARENCY

The TRANSPARENCY feature is used to copy onto transparency film.

- When copying onto transparency film, use this feature to obtain better copy quality. When this feature is selected, the bypass tray will be automatically selected and "TRANSPARENCY" will appear in the paper size display.
- This feature cannot be used with duplex copying or staple sort copying.
- Recommended transparency film is SF-85A.

## 1 Place an original on the platen glass or in the document feeder tray.

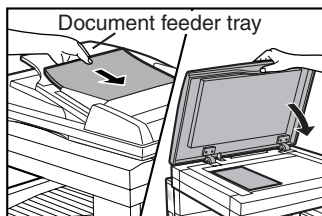

## 2 Press the SPECIAL FUNCTION key. Then press the OK key.

- The SPECIAL MODES screen will appear.

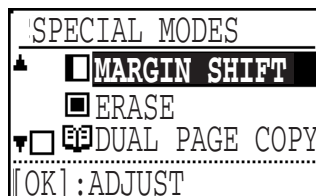
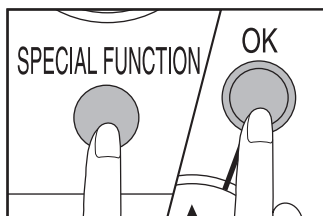

## 3 Use the ▲ and ▼ keys to select "TRANSPARENCY" and press the OK key.

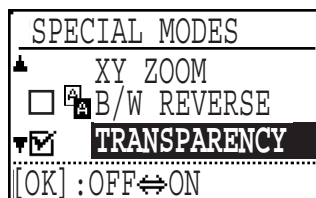
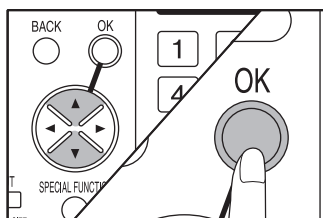

- A check mark will appear to the left of "TRANSPARENCY", and the display will return to the basic screen.

## TRANSPARENCY

---

---

### 4 Load transparency film into the bypass tray.

- Load transparency film one sheet at a time in the portrait orientation.
- 

### 5 Make all other desired copier selections and press the **START** key .

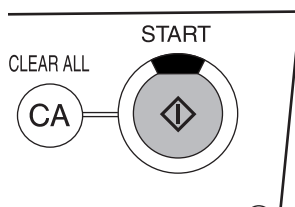

- To cancel the transparency feature, highlight "TRANSPARENCY" with a check mark on the SPECIAL MODES screen and press the OK key.

# JOB MEMORY

Nine frequently used job programs can be stored in each of nine storage registers. This is convenient for quick job recall without losing time manually reprogramming each aspect of a job.

- The following functions cannot be stored in the job memory: copy quantity, original size, document station (platen glass or document feeder tray), paper size, interrupt, extra image adjustment.
- If any function which has been stored in a job program is modified by a key operator program, the key operator settings will supercede the previous setting.
- The job memory feature cannot be used in the interrupt copy mode.
- ★ **KEY OPERATOR** Job memory replacement/deletion can be prohibited. See page 18 of the KEY OPERATOR'S GUIDE.

## Storing a job program

**1 Make all copier selections to be stored.**

**2 Press the PROGRAM key.**

- The JOB PROGRAMS screen will appear.

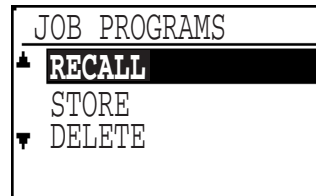
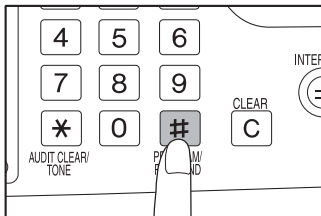

**3 Use the ▲ and ▼ keys to select "STORE" and press the OK key.**

- The STORE JOB PROGRAM screen will appear.

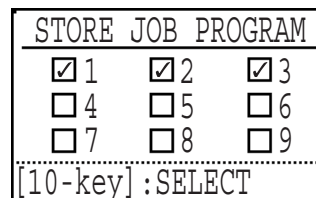
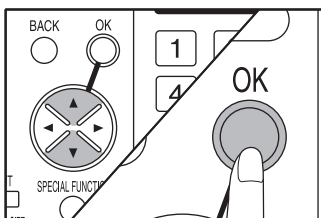

- To cancel the job memory mode, press the BACK key or the CLEAR ALL key.





**3** Select a program number from 1 to 9 using the numeric keys.



- The numbers with a check mark are program numbers which contain job programs. If a checked number is entered, the message "Delete job program?" will appear to confirm the selection to delete the program. To delete the program, select "YES" with the ▲ and ▼ keys and press the OK key.
- If "NO" is selected, the previous screen will reappear.

## Recalling a job program

**1** Press the PROGRAM key.

- The JOB PROGRAMS screen will appear with RECALL highlighted.

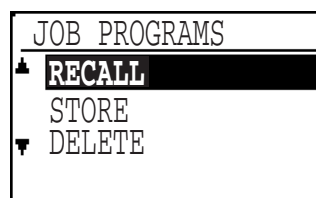
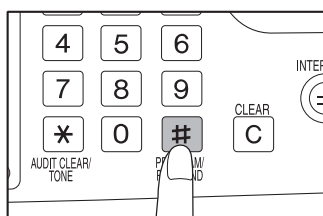

**2** Press the OK key.

- The RECALL JOB PROGRAM screen will appear.

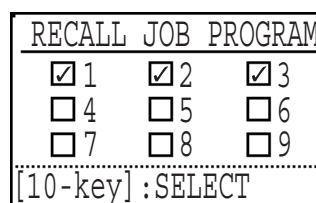
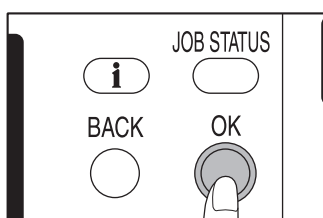

### 3 Select a program number from 1 to 9 using the numeric keys.

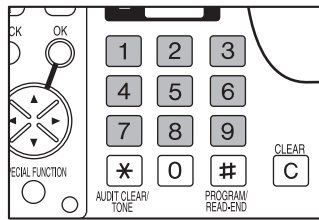

- The numbers with a check mark are program numbers which contain job programs. If a checked number is entered, the settings for that job program will be recalled and the display will return to the basic screen.
- The recalled settings may be modified for a particular job run, but any changes made will not be stored in the job memory. To store the new settings, follow the "Storing a job program" procedure.

# CHAPTER 4

## COPIER TROUBLE?

This chapter describes how to remove misfed paper and how to remedy minor problems.

|                                       | Page |
|---------------------------------------|------|
| ● <b>STATUS MESSAGES</b> .....        | 66   |
| ● <b>MISFEED REMOVAL</b> .....        | 67   |
| Misfeed in the bypass tray .....      | 67   |
| Misfeed in the copier .....           | 68   |
| Misfeed in the center tray .....      | 71   |
| Misfeed in the upper paper tray ..... | 72   |
| Misfeed in the lower paper tray ..... | 72   |
| Misfeed in the upper exit area .....  | 73   |
| ● <b>TROUBLESHOOTING</b> .....        | 75   |

# STATUS MESSAGES

If any of the following messages appears in the display, carry out the prescribed remedy.

| Message  | Remedy   |
|--|--|
| ✎ (Maintenance icon) ⓘ<br>-----<br>⚠ Maintenance required soon.                  | Service by an authorized SHARP service technician will be required soon. Contact your service center as soon as possible. (This message will be displayed if the information key is pressed when the information ( ⓘ ) icon is displayed.)   |
| ⚠ Maintenance required. Call for service.  | Normal maintenance service by an authorized SHARP service technician is needed. Contact your service center.   |
| ⚠ Call for service. **-*   | A malfunction has occurred which cannot be corrected by the key operator. Contact your authorized SHARP service center for service.  |
| ⚠ (Toner cartridge replacement required icon) ⓘ<br>-----<br>⚠ Toner is low.      | Replacement of the toner cartridge will be needed soon. (This message will be displayed if the information key is pressed when the information ( ⓘ ) icon is displayed.) See page 82.  |
| ⚠ Check the toner cartridge.   | Check to see if the toner cartridge has been installed properly.   |
| Can not continue.<br>⚠ Remove paper from the center tray.                        | The number of copies on the center tray has reached the limit. Remove the copies from the center tray.   |
| Please check paper in paper tray<*>.   | Check to see if copy paper has been loaded properly.   |
| ⚠ Load <*> paper into tray <*>. Or cancel job and change the paper size setting. | The paper size specified for the tray is different from the actual size. See page 78.  |
| Selected paper tray is out of service.   | Contact your authorized SHARP service center for service.  |
| Check stapler or staple jam.   | Staples become jammed or the staple box is not installed properly (when an optional finisher is installed). Check the staple box. See page 110 for staple jam removal. If the trouble cannot be easily remedied, use key operator program "DISABLE STAPLER" to prevent the use of the stapler until it can be repaired. Contact your authorized SHARP service center for service.<br><b>★ KEY OPERATOR</b> See page 19 of the KEY OPERATOR'S GUIDE for enabling/disabling stapler. |
| ⚠ Please remove paper from the stapler compiler.                                 | Paper is left in the stapler compiler. Remove it. See page 112.  |

<\*>: paper tray number  
 <\*\*\*>: paper size to be set

# MISFEED REMOVAL

When a misfeed occurs, the copier will stop. The message "Clear paper path." will appear in the display along with an illustration showing paper misfeed locations.

- If paper becomes accidentally torn during removal, be sure to remove all pieces. Be careful not to damage the photoconductive drum.
- For misfeeds in optional equipment, see their respective sections of the operation manual.
- ★ **KEY OPERATOR** If the backlight change of the display is enabled using a key operator program, the color of the backlighting will change to orange when a misfeed occurs. See page 20 of the KEY OPERATOR'S GUIDE.

First confirm the misfeed locations.

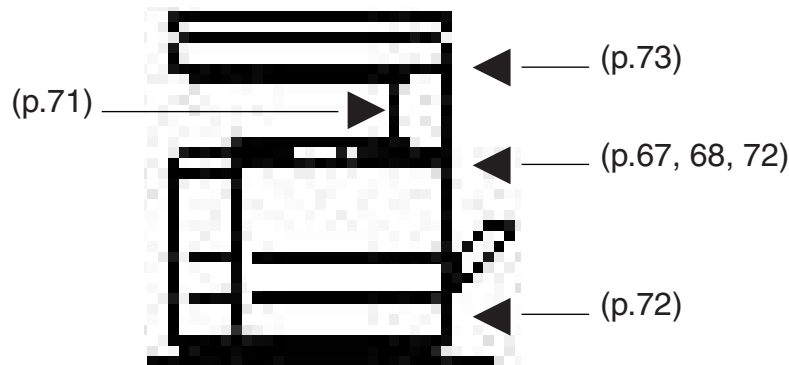

## Misfeed in the bypass tray

- 1 Gently pull the misfed paper out from the bypass tray.

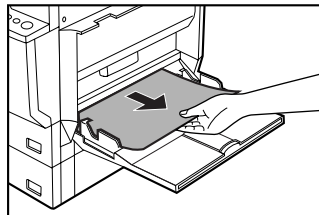

- 2 Open and close the side cover to cancel the misfeed display.

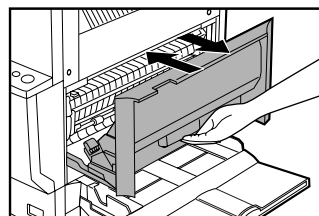

- You can also cancel the misfeed display by opening and closing the front cover.
- Confirm that the misfeed display has been cleared. If the misfeed display is not cleared, remove the misfed paper referring to "A. Misfeed in the paper feed area".

## Misfeed in the copier

Check the misfeed location. Remove the misfed paper following the instructions for each location in the illustration below.

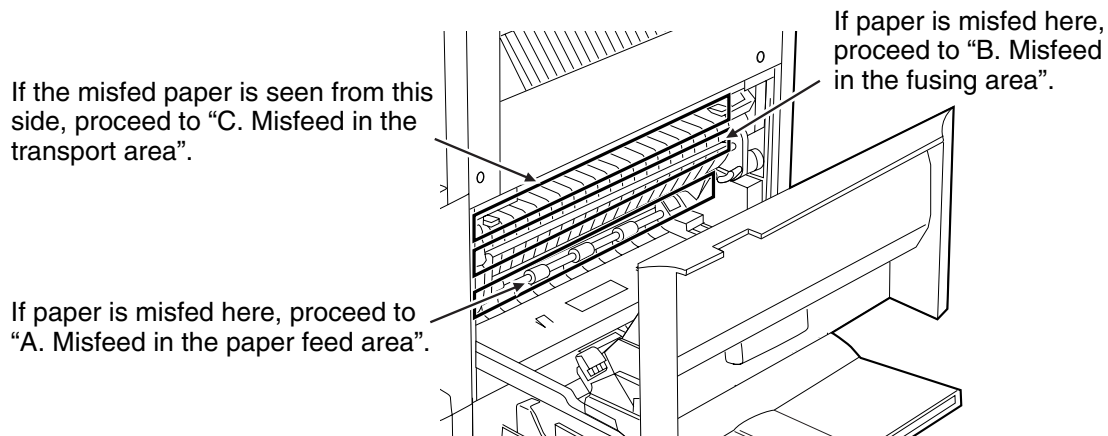

### A. Misfeed in the paper feed area

- 1 Open the bypass tray and the side cover.

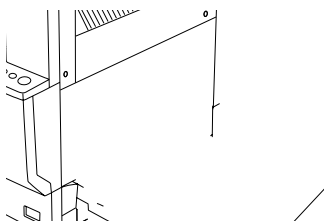

- 2 Gently open the front cover.



## MISFEED REMOVAL

---

- 3** Turn the roller rotating knob in the direction of the arrow.

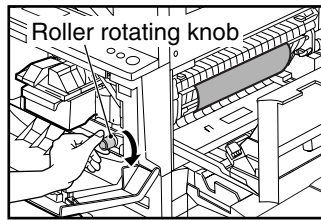

- 4** Carefully remove the misfed paper. Lower the fusing unit release levers to allow easier removal. After removal, return the release levers to their operating positions.

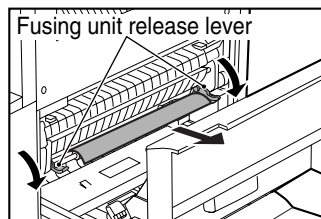

**WARNING:**

The fusing unit is hot. Take care in removing paper.



**CAUTION:**

- Do not touch the photoconductive drum (green portion) when removing the misfed paper. Doing so may damage the drum and cause smudges on copies.
- Be careful, there may be unfused toner on the misfed paper which could soil your hands or clothes.

- 5** Close the front cover and the side cover.

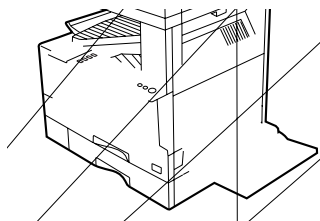

- Confirm that the misfeed display has been cleared.





## Misfeed in the upper paper tray

Before opening the upper paper tray, be sure to open the bypass tray and the side cover and then perform steps 1 to 3 described in the "A. Misfeed in the paper feed area" section.

- 1 Pull out the upper paper tray and remove the misfed paper.**

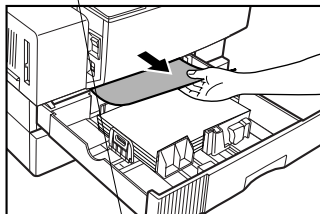

- 2 Close the paper tray.**

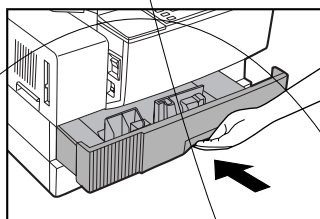

- 3 Open and close the side cover to cancel the misfeed display.**

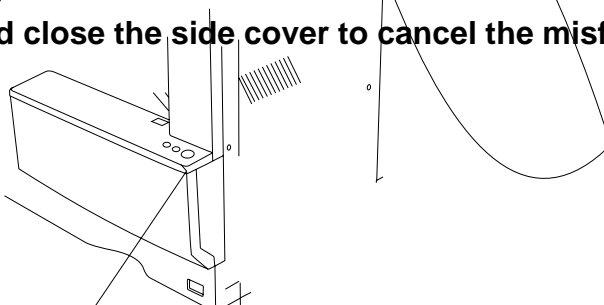

- You can also cancel the misfeed display by opening and closing the front cover.
- Confirm that the misfeed display has been cleared.

## Misfeed in the lower paper tray

- 1 Grasp the handle of the lower side cover and gently open the cover.**

**2 Remove the misfed paper.**

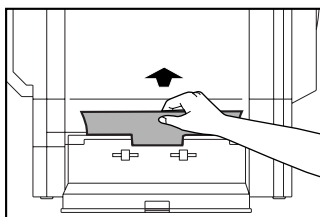

- Be careful not to tear the misfed paper during removal.

**3 If the misfed paper is not seen in step 2, pull out the lower paper tray and remove the misfed paper.**

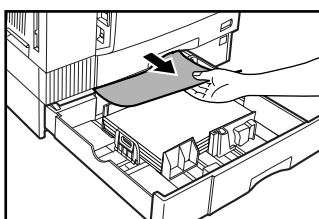

- Be careful not to tear the misfed paper during removal.

**4 Close the paper tray.**

**5 Close the lower side cover.**

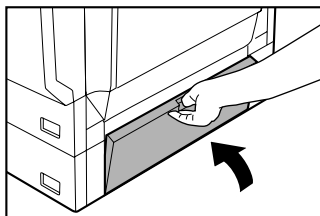

- Confirm that the misfeed display has been cleared.

## Misfeed in the upper exit area

If an optional job separator tray kit or an optional finisher is installed, a misfeed may occur in the upper exit area.

**1 Open the upper exit area cover.**

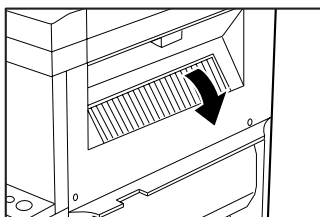

## MISFEED REMOVAL

---

- 2 Gently pull the misfed paper out.**

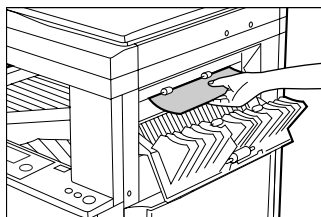

- 3 Close the upper exit area cover.**
  - Confirm that the misfeed display has been cleared.

# TROUBLESHOOTING

Always check the message display whenever the copier stops during an operation or operation is not possible. Messages in the display will give you easy-to-follow directions. For other troubles not described by messages, check the chart below.

| Problem                                   | Solution   |  |
|---|--|--|
| Copier does not operate.                  | ● Copier plugged in?   | Plug the copier into a grounded outlet as specified. See page 89.  |
|   | ● Power switch ON?   | Turn the power switch ON. See page 16.   |
| Copies are too dark or too light.         | ● Copy density properly adjusted?  | Adjust the exposure. See page 29.  |
| Blank copies                              | ● Is the original placed face down?  | Place the original face down on the platen glass.  |
| Copies smear if rubbed.                   | ● Paper too heavy?   | Use copy paper within the specified range. See page 78.  |
|   | ● Paper damp?  | Replace with dry copy paper. Be sure to store copy paper in a dry location. See page 88.   |
| Paper misfeeds frequently.                | ● Non-standard paper used?   | Use standard paper. If using special paper, feed the paper through the bypass tray. See pages 36 and 78.   |
|   | ● Paper properly installed?  | Make sure the paper is properly installed. See pages 36 and 78.  |
|   | ● Pieces of paper inside copier?   | Remove all pieces of misfed paper. See page 67.  |
|   | ● Paper curled or damp?  | Store copy paper flat in the wrapper in a dry location. See page 88.   |
| Original size not selected automatically. | ● Has the platen cover been completely opened when the original is placed on the platen glass? | Open the platen cover completely and then place the original on the platen glass. Close the platen cover.  |
|   | ● Does the original include any large black solid areas?                                       | If the original includes any large black solid areas, the original size may not be detected. Press the SPECIAL FUNCTION key and select "ORIG. SIZE ENTER" to specify the original size. See page 24. |

## TROUBLESHOOTING

| Problem                                    | Solution   |  |
|--|--|--|
| Copies are smudged or dirty.               | ● Platen glass or platen cover dirty?                                    | Clean regularly. See page 84.  |
|  | ● Original smudged or blotchy?   | Use a clean original.  |
| Black or white stripes appear on copies.   | ● Is the scanning window of an optional SPF or RSPF dirty?               | Clean the scanning window.   |
| Paper size for a paper tray cannot be set. | ● Is the COPY indicator off?   | Press the COPY key to select the COPY mode. See page 14.   |
|  | ● Is copying, printing or facsimile printing being performed?            | Set the paper size after copying, printing or facsimile printing is complete.                      |
| Power is on but copying is not possible.   | ● Are only the mode indicators on?                                       | The copier is in the auto power shut-off mode. Press the COPY key or another mode key that is lit. |
|  | ● Is the COPY indicator off?   | Press the COPY key to select the COPY mode.  |
|  | ● Is two-sided printing being performed?                                 | Wait until the printing job finishes.  |
| Lighting fixture flickers.                 | ● Is the same power outlet used for the lighting fixture and the copier? | Connect the copier to a power outlet which is not used for other electric appliances.              |



**CAUTION:**

Be sure to use only genuine SHARP parts and supplies.

Please contact your SHARP service center immediately if a problem persists after checking the above.



# PAPER

## Types and sizes of copy paper

Types and sizes of copy paper which can be fed from the paper trays are shown below.  
For paper acceptable for feeding from the bypass tray, see page 36.

| Size                                     | Weight             | Capacity (21 lb. bond paper) |
|--|--------------------|------------------------------|
| 5-1/2" x 8-1/2" to 11" x 17"<br>A5 to A3 | 15 lbs. to 21 lbs. | 500 sheets                   |

- 5-1/2" x 8-1/2" and A5 copy papers cannot be fed from any tray except the uppermost tray. (including trays in optional paper feed units)
- B5 paper cannot be set for paper tray 2.
- Special papers including transparency film must be fed through the bypass tray.

## Loading copy paper

To save space, this copier has been designed with adjustable front-loading trays, which are easily opened for paper loading. For best results, use only SHARP recommended paper.

The message "TRAY<\*>: Add paper." will be displayed when there is no copy paper in the selected paper feed station.

When the selected paper tray is not installed or is improperly installed, "Push paper tray <\*> into the machine until it latches." will be displayed. Install it or push it back firmly into place.

### NOTE:

When the paper size is changed in a paper tray, the size of the paper must be entered as described on page 80. If not, the machine will stop copying and the message "Load <\*\*\*> paper into tray <\*>. Or cancel job and change the paper size setting." will appear in the display. In this case, either load the paper requested in the message or enter the paper size that is already installed in the paper tray.

<\*> : paper tray number

<\*\*\*>: paper size to be set

### 1 Pull out the paper tray until it stops.

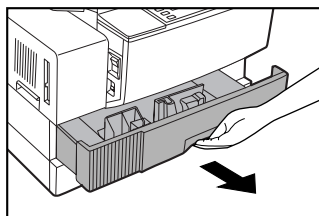

### 2 Squeeze the lock lever of the front guide and slide the front guide to match the width of the paper.

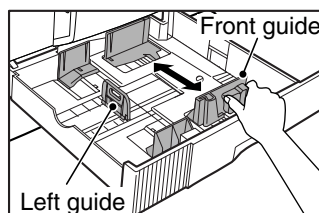



---

---

### 3 Move the

- When  
pap

# Changing the copy paper size in the tray

Paper size setting can only be done while the machine is not operating and the COPY mode has been selected.

- B5 paper cannot be set for paper tray 2.

## 1 Press the SPECIAL FUNCTION key.

- The SPECIAL FUNCTION screen will appear.

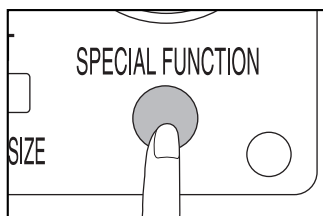

## 2 Use the ▲ and ▼ keys to select "PAPER SIZE SET" and press the OK key.

- The paper size setting screen will appear.

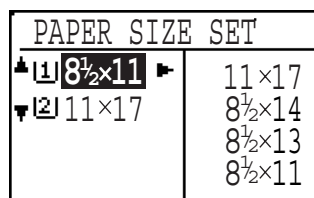
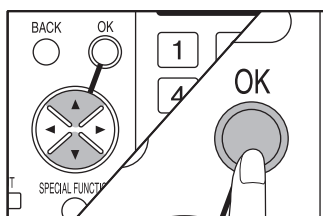

## 3 Use the ▲ and ▼ keys to select the paper tray for which the paper size is being changed.

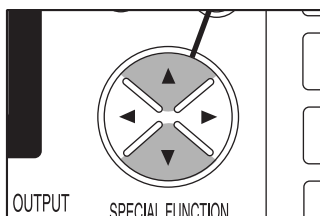

## 4 Press the ► key.

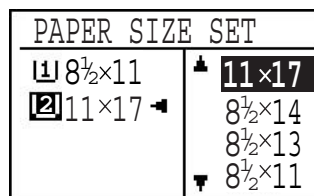
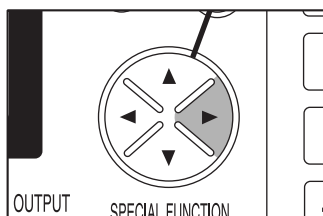

---

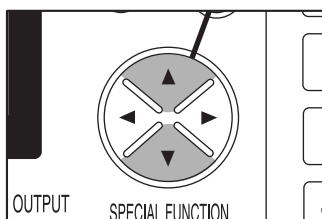
**5** Use the ▲ and ▼ keys to select the paper size that has been set.

- To change the size of another paper tray, press the ◀ key and then repeat steps 3 to 5.

---

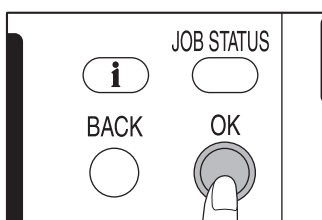
**6** Press the OK key.

- A confirmation message for paper size setting will appear.

---

**7** Press the OK key.

- The specified paper size will be registered and the display will return to the basic screen.

enuine  
ize the  
Genuine

Push the release lever and pull the toner cartridge  
out of the cartridge while supporting it with the left hand  
from the bottom.

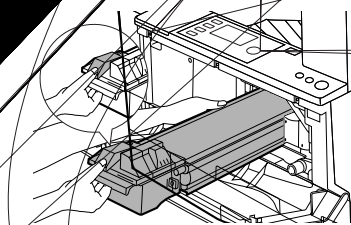

For the disposal of the old toner cartridge, contact your dealer.

When removing the toner cartridge, do not shake it or tap on it. Doing so may cause toner to leak  
out of the cartridge. Put the old cartridge immediately in the bag contained in the box of the new  
cartridge.



# CHECKING THE TONER QUANTITY AND TOTAL OUTPUT COUNT

The approximate quantity of toner remaining and the total output count can be displayed by the procedure below. The total count value displayed is the output count in the copy, print, and fax modes including the output count by the self-print function of the printer and facsimile features.

## 1 Press and hold the COPY key during standby or warm-up.

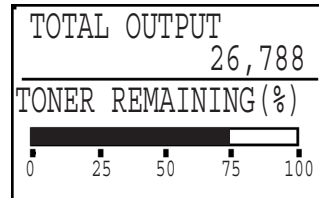
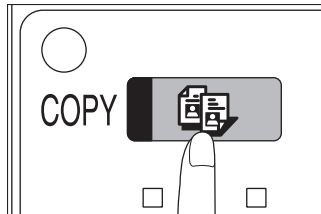

- The toner quantity and the total output count will be displayed in the display while the key is pressed.

**NOTE:**

An 11" x 17" or A3 sheet is counted as two sheets. A two-sided copy is also counted as two sheets.

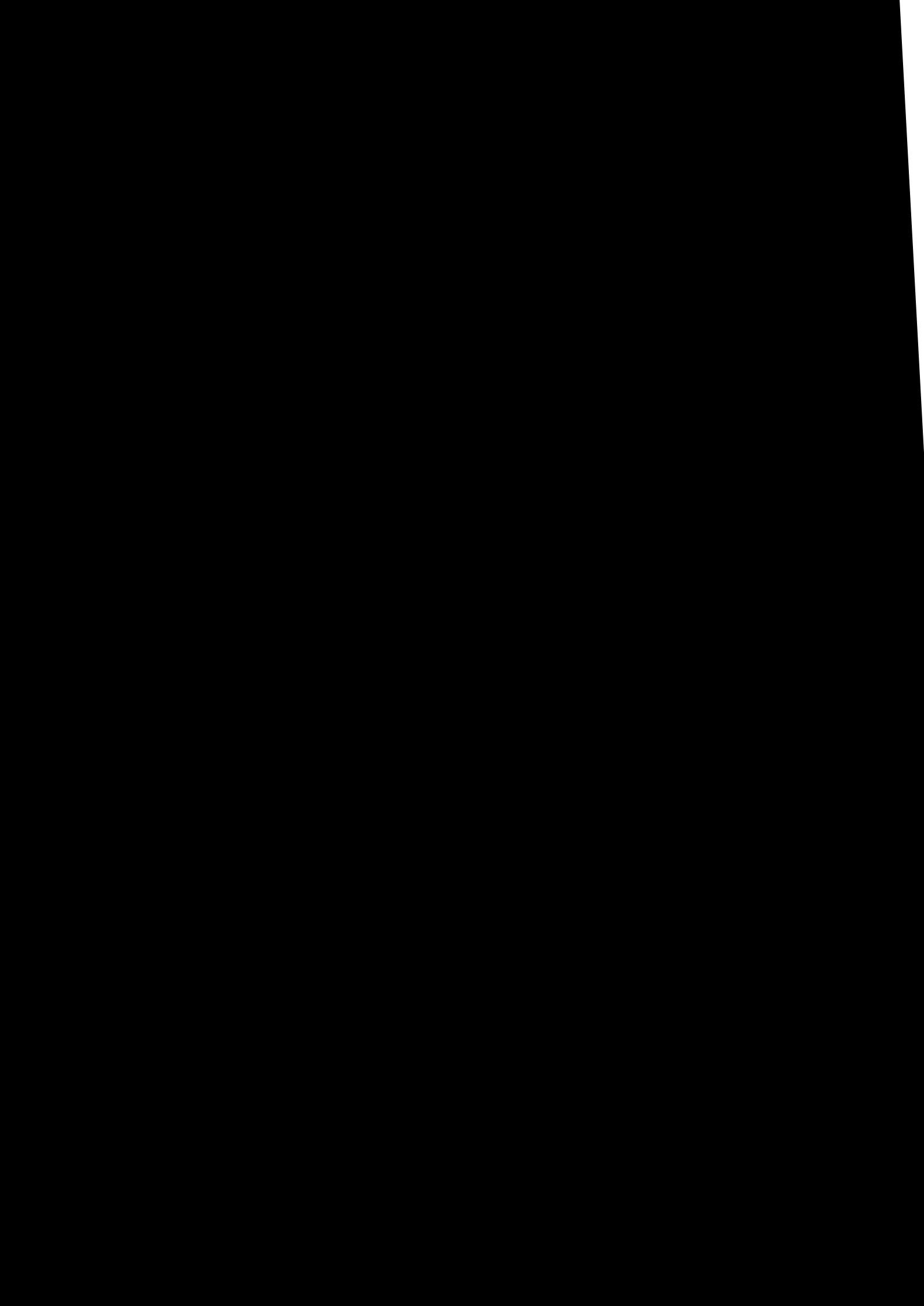

# CLEANING THE BYPASS TRAY PAPER FEED ROLLER

---

If misfeeds occur frequently when feeding postcards, envelopes, thick paper, etc. through the bypass tray, wipe the paper feed roller at the feed slot of the bypass tray with a soft, clean cloth dampened with alcohol or water.

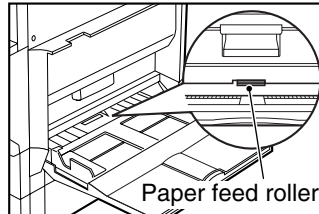





# STORAGE OF SUPPLIES

---

Standard supplies for this copier that are to be replaced by the user are copy paper, toner cartridge, and staple cartridge for the optional finisher (AR-FN5).

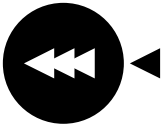
|  |   |
|--|---|
| <p><b>SHARP</b></p>  <p><b>GENUINE SUPPLIES</b></p> | <p>For best copying results, be sure to use only SHARP Genuine Supplies which are designed, engineered, and tested to maximize the life and performance of SHARP copiers. Look for the Genuine Supplies label on the toner package.</p> |
|--|---|

## Proper storage

---

### **1 Store the supplies in a location that is:**

- clean and dry,
- at a stable temperature,
- not exposed to direct sunlight.

---

### **2 Store copy paper in the wrapper and lying flat.**

- Paper stored in packages standing up or out of the wrapper may curl or become damp, resulting in paper misfeeds.

# SPECIFICATIONS

|   |          | AR-235   | AR-275   |
|---|----------|--|--|
| Type  |          | Digital copying machine, desktop   |  |
| Copy system   |          | Dry, electrostatic transfer  |  |
| Originals   |          | Sheets, bound documents  |  |
| Original sizes  |          | Max. 11" x 17"   |  |
| Copy sizes  |          | Max. 11" x 17", Min. 5-1/2" x 8-1/2"<br>Image loss: Max. 5/32" (4 mm) (leading and trailing edges), Max. 1/8" (3 mm) (along other edges)   |  |
| Copying speed<br>(one-sided copying at 100% copy ratio) | 600 dpi  | 23 copies/min. (8-1/2" x 11")<br>16 copies/min. (8-1/2" x 11"R)<br>13 copies/min. (8-1/2" x 14")<br>12 copies/min. (11" x 17")   | 27 copies/min. (8-1/2" x 11")<br>18 copies/min. (8-1/2" x 11"R)<br>16 copies/min. (8-1/2" x 14")<br>15 copies/min. (11" x 17") |
|   | 1200 dpi | 13.5 copies/min. (8-1/2" x 11")<br>9 copies/min. (8-1/2" x 11"R)<br>8 copies/min. (8-1/2" x 14")<br>7.5 copies/min. (11" x 17")  |  |
| Continuous copy   |          | Max. 999 copies; subtractive counter   |  |
| First-copy time   |          | 4.8 s (600 dpi, except in a power save mode)*  |  |
| Warm-up time  |          | Approx. 40 s   |  |
| Copy ratio  |          | Variable: 25% to 400%, in 1% increments (total 376 steps)<br>Fixed preset: 25%, 50%, 64%, 77%, 95%, 100%, 121%, 129%, 141%, 200%, 400%<br>At 1200 dpi, the copy ratio range is limited within 50% to 200%. |  |
| Exposure system   |          | Moving optical source, slit exposure (stationary platen) with automatic exposure function  |  |
| Copy paper feed   |          | Two paper trays with automatic feed (500 sheets each), one bypass tray with automatic feed (100 sheets)  |  |
| Fusing system   |          | Heat rollers   |  |
| Developer system  |          | Magnetic brush development   |  |
| Light source  |          | Xenon lamp   |  |
| Resolution  |          | Scan: 400 dpi<br>Output: 600 dpi (1200 dpi in the super photo mode)  |  |
| Gradation   |          | Scan: 256 levels<br>Output: 2 levels   |  |
| Power supply  |          | AC 120 - 127V, 60 Hz, 10 amperes   |  |

## SPECIFICATIONS

|   |   |
|---|---|
| Power consumption   | Max. 1.2 kW   |
| Overall dimensions (with bypass tray folded)                | 24-13/16" (W) x 23-3/64" (D) (628 mm (W) x 585.5 mm (D))  |
| Weight  | Approx. 105.2 lbs. (47.8 kg), toner cartridge included  |
| Copier dimensions (without platen cover)                    | 24-13/16" (W) x 23-3/64" (D) x 25-21/64" (H)<br>(628 mm (W) x 585.5 mm (D) x 643 mm (H))  |
| Operating conditions  | Temperature: 59°F to 86°F (15°C to 30°C)<br>Humidity: 20% to 85%  |
| Noise level   | Sound Power Level L <sub>WA</sub><br>Copying: 6.3 [B], Standby: 3.9 [B]<br>Sound Pressure Level L <sub>PA</sub> (bystander positions)<br>Copying: 49 [dB (A)], Standby: 24 [dB (A)]<br>Noise emission measurement in accordance with ISO 7779.  |
| Emission concentration (measurement according to RAL-UZ 62) | Ozone: 0.02 mg/m <sup>3</sup> or less<br>Dust: 0.075 mg/m <sup>3</sup> or less<br>Styrene: 0.07 mg/m <sup>3</sup> or less   |
| Optional equipment  | Single pass feeder (AR-SP4)<br>Reversing single pass feeder (AR-RP3)<br>Finisher (AR-FN5)<br>500-sheet paper feed unit (AR-D11)<br>2x500-sheet paper feed unit (AR-D12)<br>Platen cover (AR-VR3)<br>Printer expansion kit (AR-P11)<br>PS3 expansion kit (AR-PK1)<br>Barcode font kit (AR-PF1)<br>Job separator tray kit (AR-TR3)<br>Print server card (AR-NC5J)<br>Facsimile expansion kit (AR-FX4)<br>Network scanner expansion kit (AR-NS2) |

\*First-copy time may differ depending on operating conditions, such as power-supply voltage and room temperature.

**NOTE:**

As a part of our policy of continuous improvement, SHARP reserves the right to make design and specification changes for product improvement without prior notice. The performance specification figures indicated are nominal values of production units and there may be some deviations from these values in individual units.

# CHAPTER 6

## OPTIONAL EQUIPMENT

This chapter describes operating instructions for the Single Pass Feeder (AR-SP4), the Reversing Single Pass Feeder (AR-RP3), the Finisher (AR-FN5), the 500-Sheet Paper Feed Unit (AR-D11), and the 2 x 500-Sheet Paper Feed Unit (AR-D12).

|   | Page |
|---|------|
| ● <b>SYSTEM CONFIGURATION</b> .....   | 92   |
| ● <b>SINGLE PASS FEEDER (AR-SP4)/<br/>REVERSING SINGLE PASS FEEDER (AR-RP3)</b> .....       | 93   |
| Part names .....  | 93   |
| Specifications .....  | 94   |
| Acceptable originals .....  | 94   |
| Unacceptable originals .....  | 94   |
| Using the SPF or the RSPF .....   | 95   |
| Misfeed removal .....   | 101  |
| ● <b>FINISHER (AR-FN5)</b> .....  | 103  |
| Part names .....  | 103  |
| Specifications .....  | 104  |
| Supplies .....  | 104  |
| Finisher functions .....  | 105  |
| Staple sort .....   | 106  |
| Staple cartridge replacement .....  | 109  |
| Staple jam removal .....  | 110  |
| Misfeed removal .....   | 112  |
| ● <b>500-SHEET PAPER FEED UNIT (AR-D11)/<br/>2x500-SHEET PAPER FEED UNIT (AR-D12)</b> ..... | 114  |
| Part names .....  | 114  |
| Specifications .....  | 114  |
| Loading copy paper .....  | 115  |
| Changing the copy paper size in the tray .....  | 115  |
| Misfeed removal .....   | 115  |



# SINGLE PASS FEEDER (AR-SP4)/REVERSING SINGLE PASS FEEDER (AR-RP3)

The single pass feeder (SPF) and the reversing single pass feeder (RSPF) hold up to 30 originals each for automatic document feeding.

If the RSPF is installed, two-sided originals can be copied automatically without having to manually turn them over.

## Part names

AR-SP4

AR-RP3

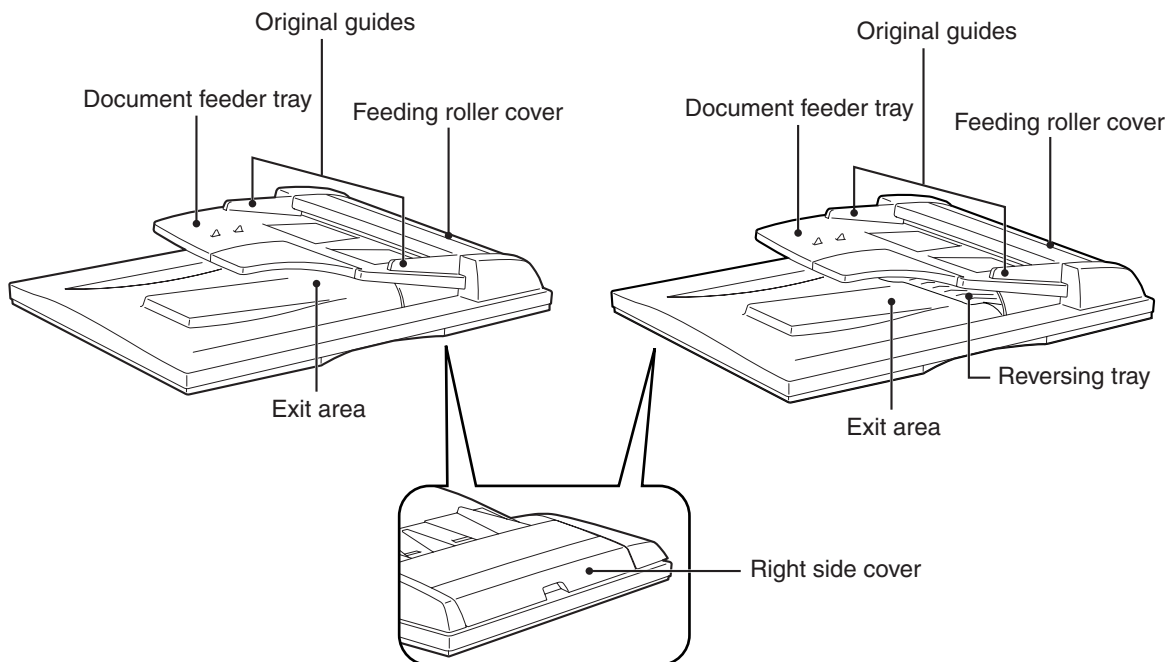

## Specifications

|                           |  |   |
|---------------------------|--|---|
| Acceptable originals      | Weight   | 15 to 23 lbs.   |
|                           | Size   | 5-1/2" x 8-1/2"* to 11" x 17"<br>* 5-1/2" x 8-1/2" size originals cannot be used in the duplex copy mode. |
|                           | Capacity   | Up to 30 sheets provided the total aggregate thickness does not exceed 5/32"                              |
| Power supply              | Drawn from the copier  |   |
| Detectable original sizes | 5-1/2" x 8-1/2", 8-1/2" x 11", 8-1/2" x 11"R, 8-1/2" x 14", 11" x 17"              |   |
| Weight                    | SPF  | Approx. 11.1 lbs. (5.0 kg)  |
|                           | RSPF   | Approx. 11.9 lbs. (5.4 kg)  |
| Dimensions                | 22-61/64" (W) x 17-1/8" (D) x 5-1/4" (H)<br>(583 mm (W) x 435 mm (D) x 133 mm (H)) |   |

**NOTE:**

As a part of our policy of continuous improvement, SHARP reserves the right to make design and specification changes for product improvement without prior notice. The performance specification figures indicated are nominal values of production units and there may be some deviations from these values in individual units.

## Acceptable originals

Up to 30 originals ranging from 5-1/2" x 8-1/2" to 11" x 17" and from 15 lbs. to 23 lbs. can be used. The total aggregate thickness must not exceed 5/32".

**NOTES:**

- Be sure to remove any staples or paper clips from the originals.
- Before placing curled or wavy originals into the document feeder tray, be sure to flatten them. If not, original misfeeds may result.
- For best feeding of originals which have binding holes punched into them, insert them so that the holes are positioned to the right or along the original guides. In this case the settings for margin shift may need to be changed. See page 45.

## Unacceptable originals

The following types of paper cannot be used as originals:

- Special papers including transparency film, photographs, and tracing paper
- Damaged or crumpled originals
- Paper with multiple punched holes (paper with two or three holes can be used)
- 5-1/2" x 8-1/2" size originals cannot be used in the 2-sided to 1-sided or 2-sided to 2-sided mode.



**Stream feeding mode**

If the stream feeding mode has been enabled using a key operator program, the message "Set originals for stream feeding." will appear for approximately 5 seconds after feeding of all originals is completed. While this message is displayed, any new originals placed in the SPF or RSPF will be fed and copied automatically.

★ **KEY OPERATOR** See page 12 of the KEY OPERATOR'S GUIDE for information on setting the stream feeding mode.

## Using the SPF or the RSPF

★ **KEY OPERATOR** If SPF/RSPF is disabled using a key operator program, the SPF or the RSPF cannot be used. See page 19 of the KEY OPERATOR'S GUIDE.

### One-sided copies from one-sided originals

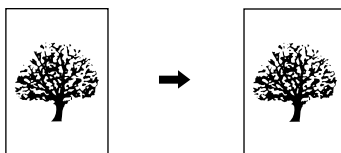

**1** Ensure that no original is left on the platen glass.

**2** Adjust the original guides to the size of the originals.

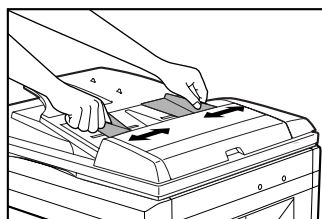

**3** Set the originals face up in the document feeder tray.

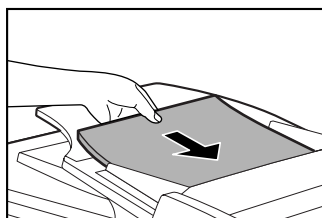

- The original size will be indicated in the display, and the paper tray with the corresponding paper size will be automatically selected.
- ★ **KEY OPERATOR** The auto paper select function can be disabled using a key operator program. If this function has been disabled, use the PAPER SELECT key to select the desired paper tray. See page 18 of the KEY OPERATOR'S GUIDE.
- To copy onto a different size paper, use the PAPER SELECT key to make the selection.

**4** Ensure that the one-sided to one-sided copying mode is selected.

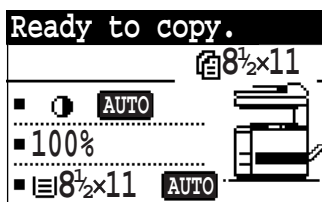

- When no icon indicating a duplex copy mode is displayed, the one-sided to one-sided copying mode is selected.

**5** Set the number of copies and press the START key.

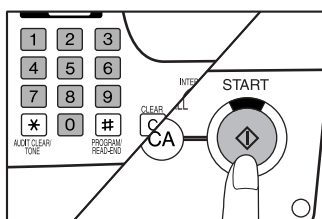

- Press the CLEAR key to stop copying in the middle of a run.

**Two-sided copies from one-sided originals**

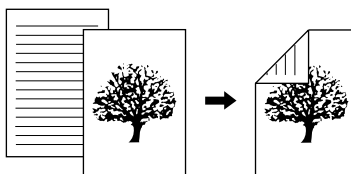

- Paper sizes that can be used in the duplex copy mode are 8-1/2" x 11", 8-1/2" x 11"R, 8-1/2" x 13", 8-1/2" x 14", 11" x 17", A5, B5, B5R, A4, A4R, B4, and A3.

**1** Ensure that no original is left on the platen glass. Adjust the original guides to the size of the originals and set the originals face up in the document feeder tray.

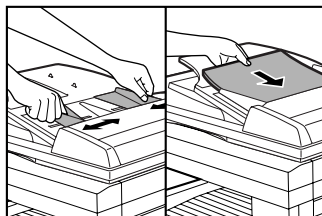

- If an uneven number of originals are set, the last copy will be one-sided.

**2 Press the 2-SIDED COPY key.**

- The duplex copy mode selection screen will appear.

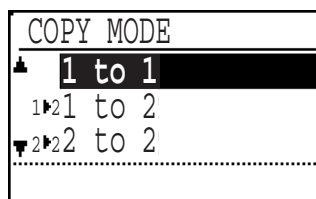
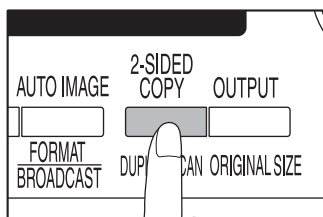

**3 Use the ▲ and ▼ keys to select one-sided to two-sided copying.**

- Also the 2-SIDED COPY key can be used to select a duplex copy mode.

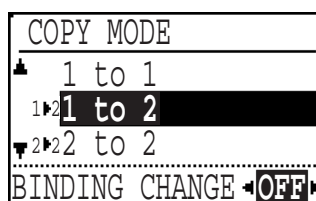
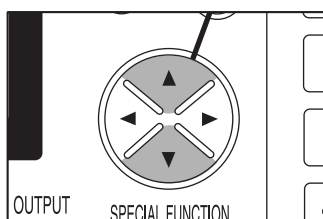

**4 Use the ◀ or ▶ key to select binding change if desired. Then, press the OK key.**

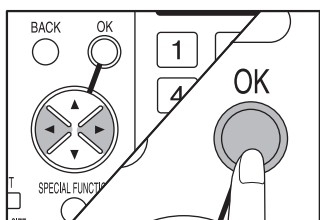

- The image of one side can be rotated 180° using the image rotation feature. This feature can be useful depending on the orientation of the original image and the desired binding position.

**5 Set the number of copies and press the START key.**

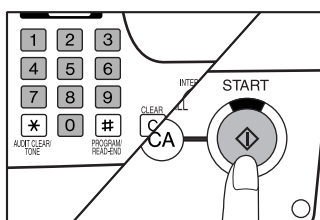

- Press the CLEAR key to stop copying in the middle of a run.

**6**

OPTIONAL EQUIPMENT

## Two-sided copies from two-sided originals

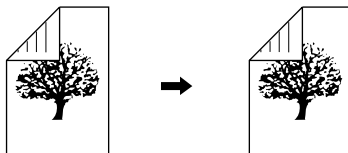

To copy in the two-sided to two-sided copy mode, an RSPF must be installed.

- Paper sizes that can be used in the duplex copy mode are 8-1/2" x 11", 8-1/2" x 11"R, 8-1/2" x 13", 8-1/2" x 14", 11" x 17", A5, B5, B5R, A4, A4R, B4, and A3.

- 1 Ensure that no original is left on the platen glass. Adjust the original guides to the size of the originals and set the originals face up in the document feeder tray.**

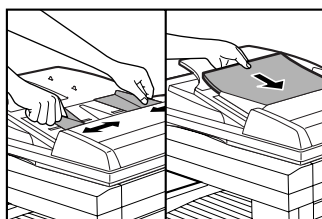

- 5-1/2" x 8-1/2" size originals cannot be used.

- 2 Press the 2-SIDED COPY key.**

- The duplex copy mode selection screen will appear.

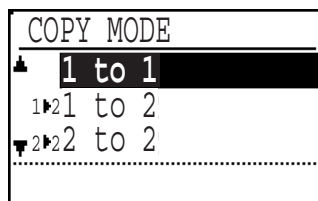
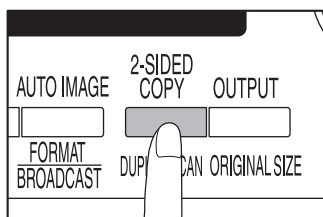

- 3 Use the ▲ and ▼ keys to select two-sided to two-sided copying and press the OK key.**

- Also the 2-SIDED COPY key can be used to select a duplex copy mode.

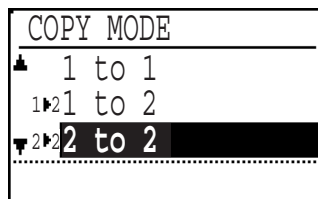
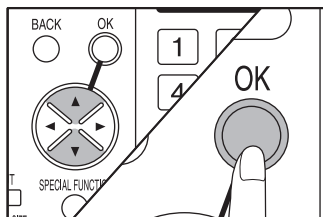

**4 Set the number of copies and press the START key.**

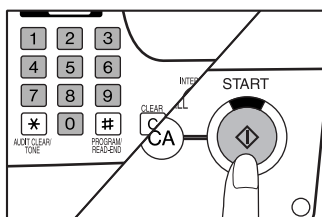

- Be sure not to touch the originals as they move on the reversing tray. This may cause misfeeds.

**One-sided copies from two-sided originals**

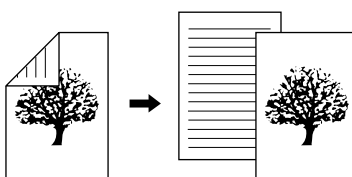

To copy in the two-sided to one-sided copy mode, an RSPF must be installed.

**1 Ensure that no original is left on the platen glass. Adjust the original guides to the size of the originals and set the originals face up in the document feeder tray.**

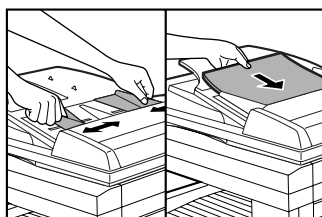

- 5-1/2" x 8-1/2" size originals cannot be used.

**2 Press the 2-SIDED COPY key.**

- The duplex copy mode selection screen will appear.

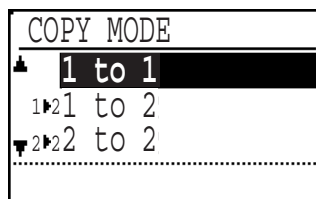
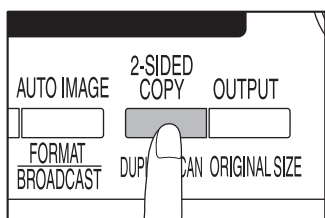

**3** Use the ▲ and ▼ keys to select two-sided to one-sided copying.



**4** Use the ◀ or ▶ key to select binding change if desired. Then, press the OK key.

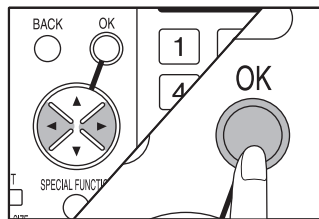

- The image of one side can be rotated 180° using the image rotation feature. This feature can be useful depending on the orientation of the original image and the desired binding position.

**5** Set the number of copies and press the START key.

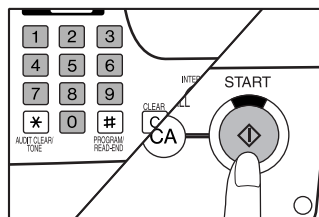

- Press the CLEAR key to stop copying in the middle of a run.
- Be sure not to touch the originals as they move on the reversing tray. This may cause misfeeds.

## Misfeed removal

If an original misfeed occurs in the SPF or RSPF, the copier will stop and the message "Clear paper path." will appear.

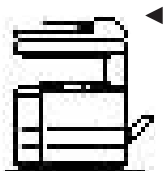

### 1 Remove the misfed originals.

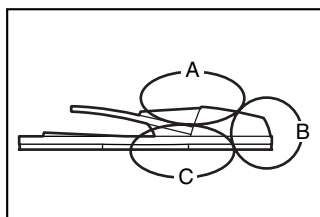

#### Location A

Open the feeding roller cover and pull the misfed original gently to the left and out from the document feeder tray. Close the feeding roller cover.

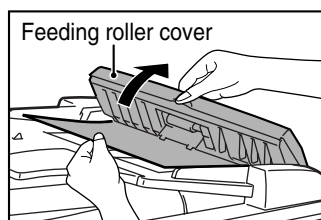

#### Location B

Open the document feeder cover, rotate the rollers in the direction indicated by the arrow to feed the misfed paper, and then gently remove the misfed original after closing the document feeder cover.

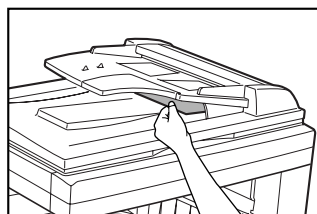
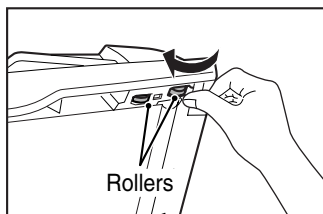





# FINISHER (AR-FN5)

The copier has two different finisher modes: one sorts copies into sets matching the sequence of the originals and the second groups copies by original. When an optional finisher (AR-FN5) is installed, the copier can automatically staple the sorted copies. Each collated set of copies or group of copies can be stacked offset from the previous set.

## Part names

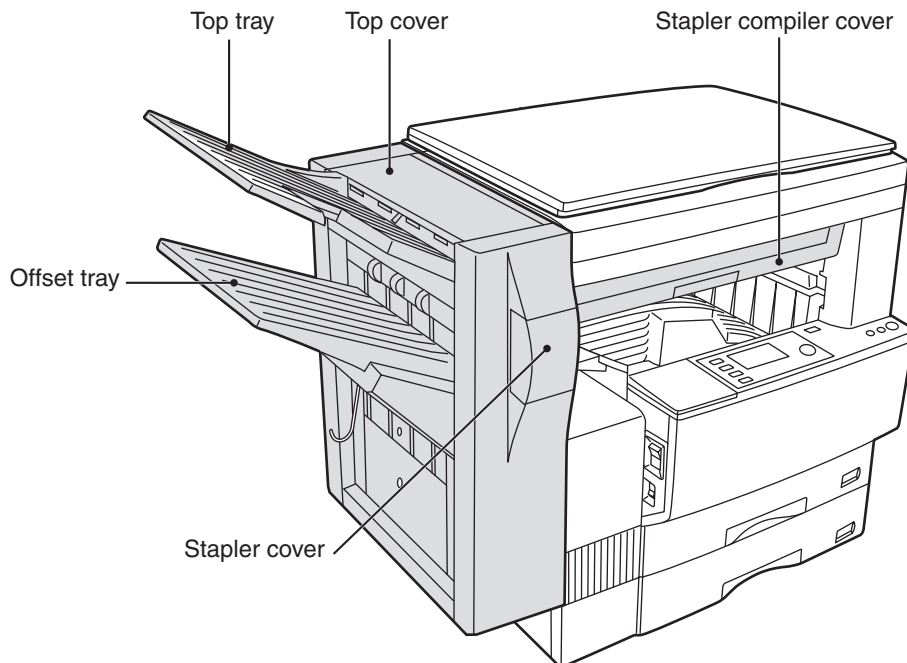

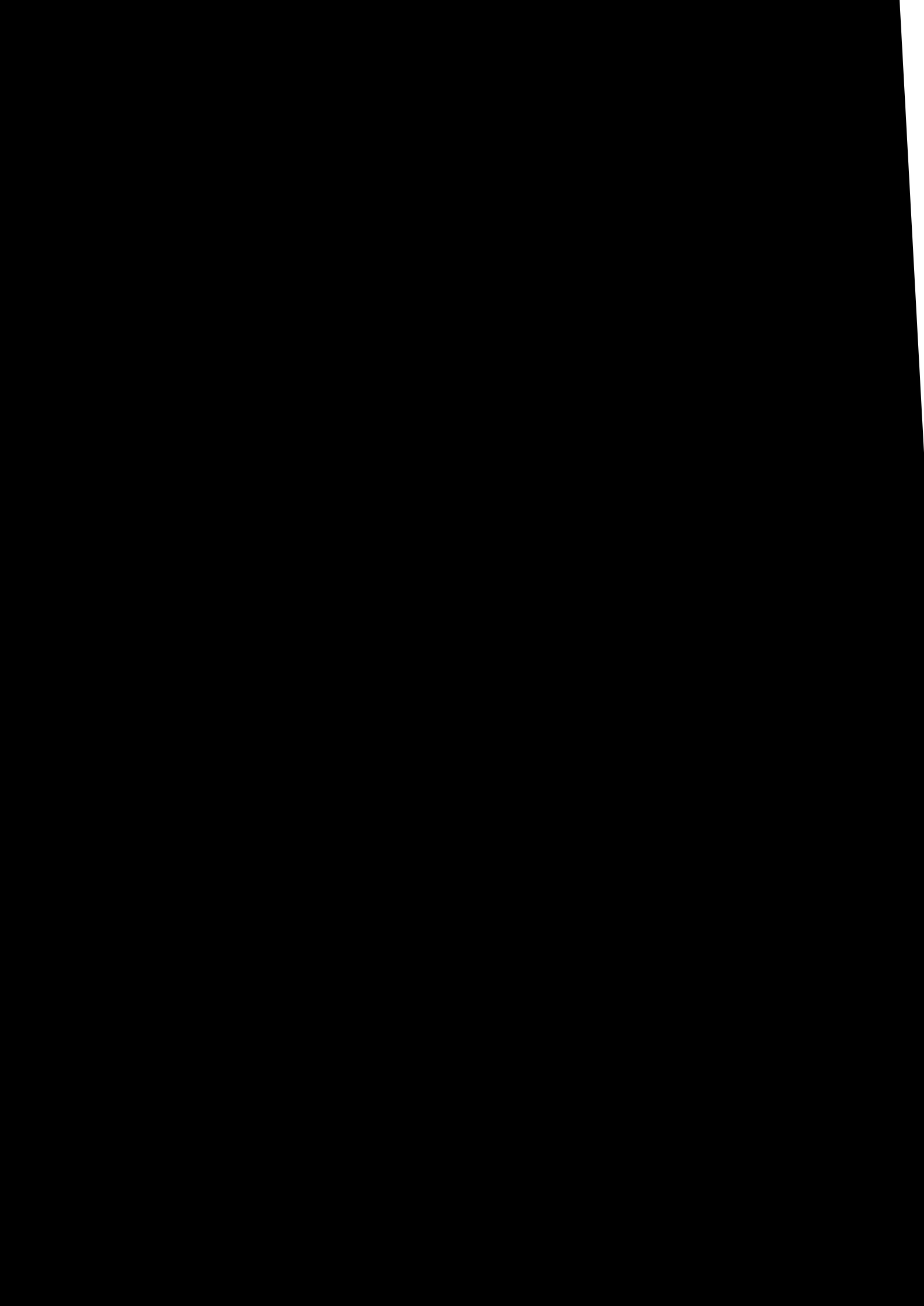

## Finisher functions

When the finisher is installed, the following four output modes can be selected: sort, staple sort, group, and non-sort.

Press the OUTPUT key, use the ▲ and ▼ keys (or the OUTPUT key) to select the desired output mode, and then press the OK key. When copying in the sort or group mode, the output tray can be selected using the ◀ and ▶ keys and pressing the OK key.

- When an SPF or RSPF is used for copying, the sort mode will be selected as the default setting. When the platen glass is used for copying, the non-sort mode will be selected as the default setting.

### Sort mode

Each set of copies will be sequentially delivered. Each collated set of copies will be stacked offset from the previous set unless the offset stack function is disabled.

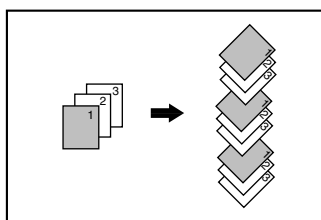

### Group mode

All copies of the same original will be grouped. Copies will be offset and stacked in groups of multiple copies from the same original unless the offset stack function is disabled.

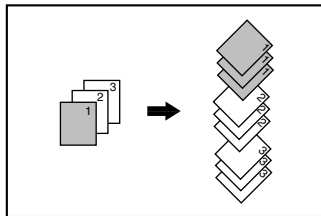

### Staple sort mode

Collated sets of copies will be stapled and delivered to the offset tray but will not be offset.

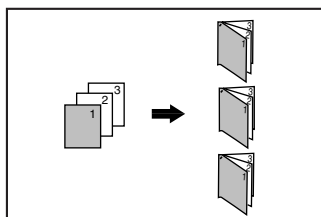

- See the next page for details.
- The bypass tray cannot be used in the staple sort mode.

### Non-sort mode

All copies will be delivered without any of the finishing described above and without being offset.

## Staple sort

In the staple sort mode, 8-1/2" x 11", 8-1/2" x 11"R, 8-1/2" x 13", 8-1/2" x 14", 11" x 17", B5, A4, A4R, B4, and A3 size copies can be stapled.

**NOTE:**

Different size originals cannot be copied onto copy paper of their respective sizes in the staple sort mode.

★**KEY OPERATOR** If stapler is disabled using a key operator program, the staple sort mode cannot be used. See page 19 of the KEY OPERATOR'S GUIDE.

### Using the platen glass

- 1 Set an original face down on the platen glass with the corner to be stapled to the upper right position.

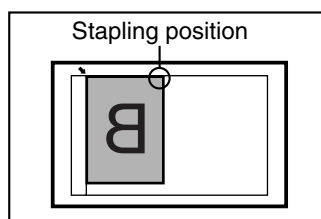

- If the number of copies in one set is more than 30, the copies will not be stapled.
- If the orientation of the original does not match that of the copy paper, the image of the original will be rotated. The stapling position varies with the orientation of the original.
- When copying 8-1/2" x 14" or 11" x 17" size originals with portrait orientation images, copies will be stapled at the position shown below.

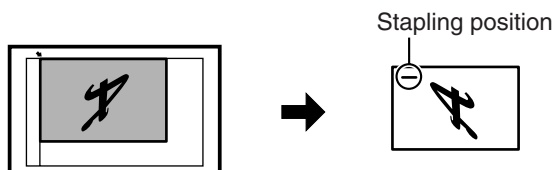

- 2 Press the **OUTPUT** key.

- The output mode selection screen will appear.

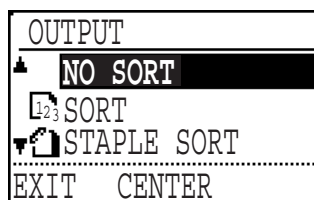
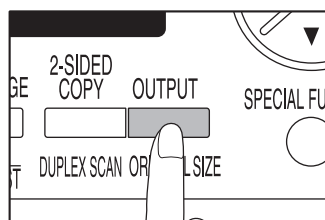

- 3 Use the ▲ and ▼ keys to select "STAPLE SORT" and press the OK key.**
- Also the OUTPUT key can be used to select an output mode.

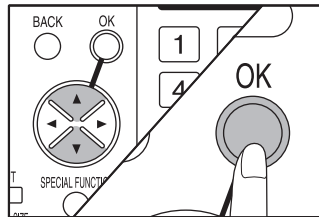

- 4 Set the number of copies and press the START key.**

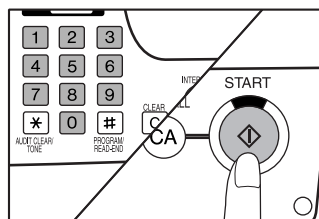

- 5 Replace the scanned original with the next original and press the START key after it lights up. Repeat this step until all originals have been scanned.**

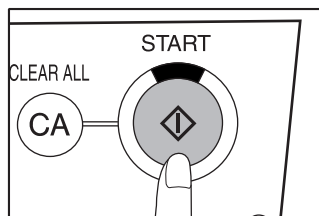

- 6 After all originals have been scanned, press the READ-END key.**

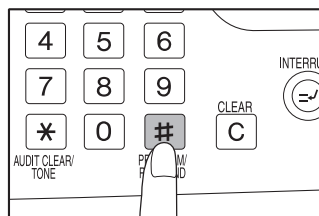

- Copying will start and each set of completed copies will be automatically stapled and delivered to the offset tray.
- If the message "Can not continue. Remove paper from the offset tray." appears in the display, remove the copies from the offset tray.

## Using the SPF or the RSPF

### 1 Set the originals in the document feeder tray.

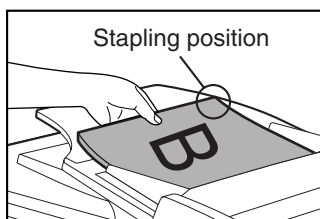

- If the number of copies in one set is more than 30, the copies will not be stapled.
- If the orientation of the originals does not match that of the copy paper, the images of the originals will be rotated. The stapling position varies with the orientation of the original.
- When copying 8-1/2" x 14" or 11" x 17" size originals with portrait orientation images, copies will be stapled at the position shown below.

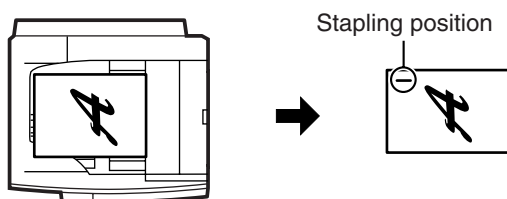

### 2 Press the OUTPUT key.

- The output mode selection screen will appear.

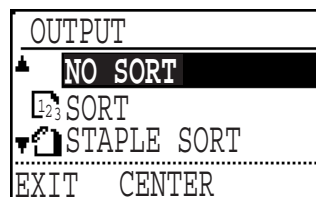
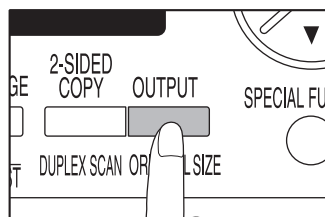

### 3 Use the ▲ and ▼ keys to select "STAPLE SORT" and press the OK key.

- Also the OUTPUT key can be used to select an output mode.

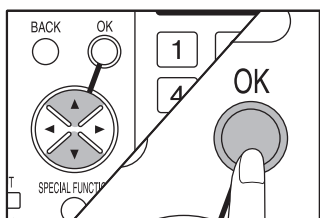

#### 4 Set the number of copies and press the START key.

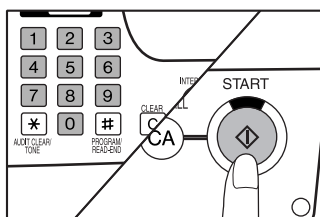

- When copying of a set is completed, the copies will be automatically stapled and delivered to the offset tray.

## Staple cartridge replacement

When the message "Add staples." appears, replace the staple cartridge as follows:

#### 1 Open the stapler cover.

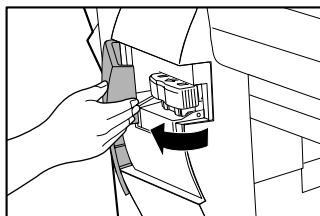

#### 2 Grasp the green portion of the staple box and remove the staple box from the stapler.

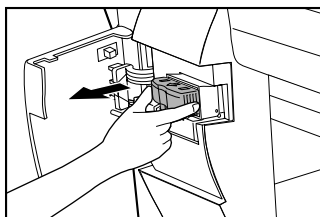

#### 3 Remove the staple cartridge from inside the staple box.

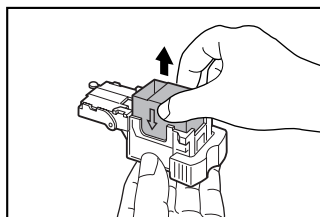

**4 Insert the new staple cartridge into the box until it clicks into place.**

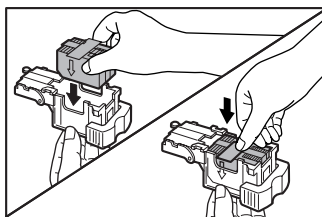

- Insert the new cartridge by aligning the arrows on the cartridge with those on the box. Check that the cartridge locks in place by pulling it slightly.
- A cartridge holds 3,000 staples.

**5 Remove the tape from the cartridge.**

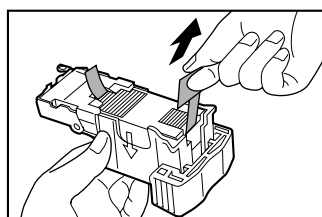

**6 Insert the staple box into the stapler unit until it clicks into place.**

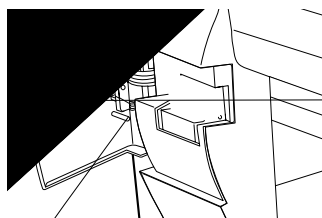

**7 Close the stapler cover.**

## Staple jam removal

If staples become jammed in the stapler, the message "Check stapler or staple jam." will appear. Remove the jammed staples in the manner described below.

**1 Open the stapler cover.**



**3** Raise the lever at the end of the staple box and staples.

**4** Return the lever to its original

**5** Insert the staples until they click into place.

**6**

**6**

OPTIONAL EQUIPMENT

## Misfeed removal

The copier will stop when a misfeed occurs. The message "Clear paper path." will appear along with a display of paper misfeed locations. When a misfeed is indicated for the finisher, follow the procedure below.

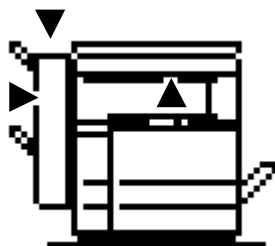

- 1** Pull the handle of the stapler compiler cover and open the cover.

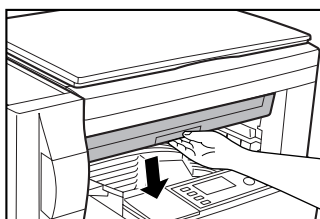

- 2** Remove any misfed paper from the transport area.

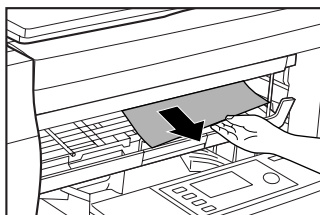

- 3** If staple sort copying is being done, open the paper guide and remove any misfed paper from the stapler compiler.

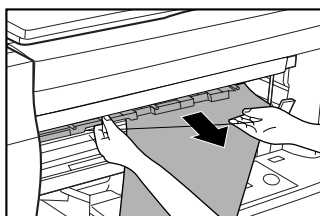

---

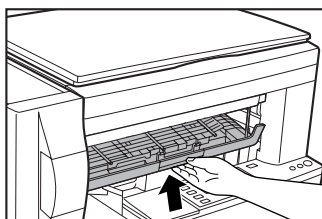
**4** Close the stapler compiler cover.

---

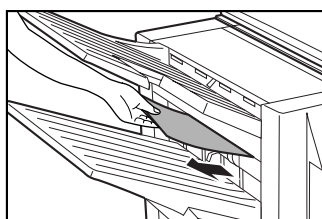
**5** If the offset tray is being used, remove any misfed paper from the offset tray.

---

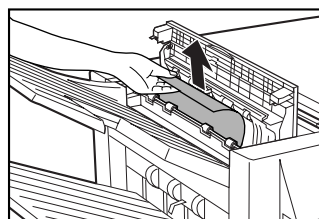
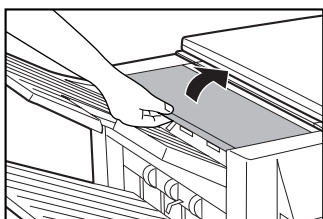
**6** If the top tray is being used, open the top cover, remove any misfed paper, and close the top cover.

- Confirm that the misfeed display has been cleared.

These parts are for  
greater change  
The AR-D11

## Part names

AR-D11

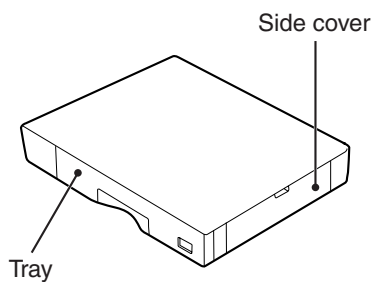

## Specifications

|                 | AR-D11   | AR-D12  |
|-----------------|--|---|
| Copy paper size | 8-1/2" x 11" to 11" x 17"  |   |
| Paper weight    | 15 lbs. to 21 lbs.   |   |
| Paper capacity  | One paper tray with capacity for 500 sheets of 21 lb. bond paper                   | Two paper trays with capacity for 500 sheets of 21 lb. bond paper                   |
| Weight          | Approx. 13.5 lbs. (6.1 kg)   | Approx. 26.1 lbs. (11.8 kg)   |
| Dimensions      | 23-15/32" (W) x 18-35/64" (D) x 3-53/64" (H) (596 mm (W) x 471 mm (D) x 97 mm (H)) | 23-15/32" (W) x 18-35/64" (D) x 7-41/64" (H) (596 mm (W) x 471 mm (D) x 194 mm (H)) |
| Power supply    | Drawn from the copier  |   |

**NOTE:**

As a part of our policy of continuous improvement, SHARP reserves the right to make design and specification changes for product improvement without prior notice. The performance specification figures indicated are nominal values of production units and there may be some deviations from these values in individual units.

- Two units of AR-D11 cannot be stacked for use with the copier.

## Loading copy paper

The method of loading copy paper for these paper feed units is the same as for the paper trays in the copier. See page 78.

## Changing the copy paper size in the tray

The method of changing the copy paper size is the same as for the paper trays in the copier. See page 80.

## Misfeed removal

The copier will stop when a misfeed occurs. The message "Clear paper path." will appear along with a display of paper misfeed locations.



- 1 Open the side cover of the paper tray which was in use and remove the misfed paper.

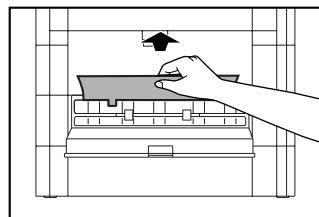
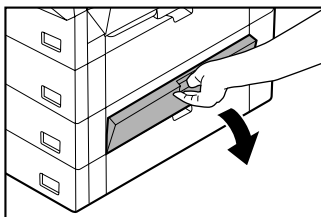

- Be sure to perform this step before pulling out the paper trays. If not, the paper may be torn as the trays are opened.

**2** Pull out the paper tray which was in use.

---

**3** Remove any misfed paper.

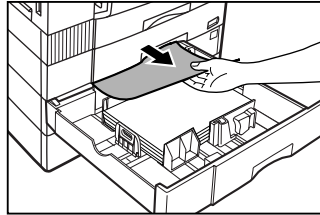

**4** Close the paper tray.

---

**5** Close the side cover.

- Confirm that the misfeed display has been cleared.

# INDEX

|                                       |        |                                    |         |
|---------------------------------------|--------|------------------------------------|---------|
| <b>2</b>                              |        | <b>E</b>                           |         |
| 2 in 1 .....                          | 51     | Edge erase .....                   | 47      |
| 2x500-sheet paper feed unit .....     | 114    | Enlargement .....                  | 31      |
| <b>4</b>                              |        | Erase .....                        | 47      |
| 4 in 1 .....                          | 51     | Exposure adjustment .....          | 29      |
| <b>5</b>                              |        | Exterior .....                     | 12      |
| 500-sheet paper feed unit .....       | 114    | <b>F</b>                           |         |
| <b>A</b>                              |        | Features .....                     | 10      |
| Auditing accounts .....               | 20     | Finisher .....                     | 103     |
| Auto clear .....                      | 17     | Function icons .....               | 18      |
| Auto image .....                      | 15, 31 | Function review .....              | 19      |
| Automatic exposure adjustment .....   | 29     | Fusing unit release lever .....    | 70      |
| Automatic reduction/enlargement ..... | 31     | <b>G</b>                           |         |
| Automatic two-sided copying .....     | 26     | Group .....                        |         |
| Auto power shut-off mode .....        | 17     | <b>I</b>                           |         |
| <b>B</b>                              |        | Initial settings .....             |         |
| Basic screen .....                    | 15     | Interior .....                     |         |
| B/W reverse .....                     | 54     | Interrupt .....                    |         |
| Bypass tray .....                     | 36     | <b>J</b>                           |         |
| <b>C</b>                              |        | Job memory .....                   |         |
| Center tray .....                     | 7      | Job program .....                  |         |
| Change paper size .....               | 47     | <b>K</b>                           |         |
| Center tray .....                     | 12     | Key operation .....                |         |
| Changing copy settings .....          | 80     | <b>L</b>                           |         |
| Copier installation .....             |        | Loading copy paper .....           | 78      |
| Copier trouble? .....                 |        | <b>M</b>                           |         |
| Copying                               |        | Maintenance                        |         |
| – normal .....                        | 24     | – maintenance required .....       | 66      |
| – reduction/enlargement .....         | 31     | – user maintenance .....           | 85      |
| – through bypass tray .....           | 36     | Manual feeding .....               | 36      |
| – two-sided .....                     | 26     | Manual reduction/enlargement ..... | 33      |
| Copy paper .....                      | 36, 78 | Margin shift .....                 | 45      |
| Copy quantity .....                   | 25     | Misfeed removal                    |         |
| Copy ratio .....                      | 31     | – bypass tray .....                | 67      |
| <b>D</b>                              |        | – center tray .....                | 71      |
| Display .....                         | 15     | – finisher .....                   | 112     |
| Display contrast adjustment .....     | 87     | – in the copier .....              | 68      |
| Dual page copy .....                  | 49     | – in the upper exit area .....     | 73      |
|                                       |        | – paper tray .....                 | 72, 115 |
|                                       |        | – SPF/RSPF .....                   | 101     |

**N**

Names  
 – operation panel . . . . . 14  
 – part . . . . . 12  
 Non-sort . . . . . 43, 105

**O**

Offset . . . . . 44  
 Operation panel . . . . . 14  
 Options . . . . . 91  
 Original . . . . . 94

**P**

Paper  
 – loading . . . . . 78  
 – special . . . . . 36  
 – specifications . . . . . 36, 78  
 Paper size . . . . . 78  
 Paper tray . . . . . 78  
 Part names  
 – 500-sheet paper feed unit/2x500-sheet  
   paper feed unit . . . . . 114  
 – copier . . . . . 12  
 – finisher . . . . . 103  
 – SPF/RSPF . . . . . 93  
 Photo mode . . . . . 29  
 Platen cover . . . . . 12  
 Platen glass . . . . . 12  
 Power off . . . . . 16  
 Power on . . . . . 16  
 Power save modes . . . . . 17  
 Power switch . . . . . 16  
 Preheat mode . . . . . 17  
 Preset copy ratio . . . . . 33

**R**

Reduction . . . . . 31  
 Replacement  
 – staple cartridge . . . . . 109  
 – toner cartridge . . . . . 82  
 Reversing single pass feeder (RSPF) . . . . . 93  
 Rotation copying . . . . . 35  
 RSPF . . . . . 93

**S**

Single pass feeder (SPF) . . . . . 93  
 Sort . . . . . 42, 105  
 Special paper . . . . . 36  
 Specifications  
 – 500-sheet paper feed unit/2x500-sheet  
   paper feed unit . . . . . 114  
 – copier . . . . . 89  
 – finisher . . . . . 104  
 – paper . . . . . 36, 78  
 – SPF/RSPF . . . . . 94  
 SPF . . . . . 93  
 Staple cartridge replacement . . . . . 109  
 Staple jam removal . . . . . 110  
 Staple sort . . . . . 106  
 Status messages . . . . . 66  
 Storage of supplies . . . . . 88  
 Stream feeding mode . . . . . 95  
 Super photo mode . . . . . 29  
 Supplies . . . . . 88  
 System configuration . . . . . 92

**T**

Text mode . . . . . 29  
 Text/photo mode . . . . . 29  
 Toner cartridge life . . . . . 84  
 Toner cartridge replacement . . . . . 82  
 Total output count . . . . . 84  
 Transparency . . . . . 59  
 Troubleshooting . . . . . 75  
 Two-sided copying . . . . . 26

**U**

User maintenance  
 – bypass tray paper feed roller . . . . . 86  
 – platen cover . . . . . 85  
 – platen glass . . . . . 85

**X**

XY zoom . . . . . 56

**Z**

Zoom . . . . . 31



**MATERIAL SAFETY DATA SHEET**Date Issued : Apr. 2. 2001  
MSDS NO. F-00981**1. PRODUCT AND COMPANY IDENTIFICATION**

**Product Name** : AR-270NT/270T/270ST/270FT/270NT-J/270ST-C/270FT-T (Black Toner)  
**Supplier Identification** : Sharp Corporation  
 22-22 Nagaike-cho, Abeno-ku, Osaka, Japan

Local suppliers are listed below. Please contact the nearest supplier for additional information.

| (Country)      | (Name and Telephone Number)  |
|----------------|--|
| U.S.A.         | Sharp Electronics Corporation<br>Telephone number for information : 1-800-237-4277<br>Emergency telephone number : 1-800-255-3924  |
| Canada         | Sharp Electronics of Canada Ltd.<br>Telephone number for information : 905-890-2100<br>Emergency telephone number : 1-800-255-3924 |
| United Kingdom | Sharp Electronics (U.K.) Ltd.<br>Telephone number for information : 01923-47-4013  |
| Australia      | Sharp Corporation of Australia PTY. Ltd.:<br>Telephone number for information: 1300-13-50-22                                       |
| Germany        | Sharp Electronics (Europe) GMBH<br>Telephone number for information: 40-2376-2737  |

**2. COMPOSITION/INFORMATION ON INGREDIENTS**

| Substance[ ]               | Preparation[X]                           |            |                      |                      |            |                    |
|----------------------------|--|------------|----------------------|----------------------|------------|--------------------|
| Ingredient                 | CAS No.                                  | Proportion | OSHA PEL             | ACGIH TLV            | MAK-TWA    | NOHSC-TWA          |
| Styrene-Acrylate copolymer | 29497-14-1                               | >88.0%     | Not listed           | Not listed           | Not listed | Not listed         |
| Carbon black               | 1333-86-4                                | <6.0%      | 3.5mg/m <sup>3</sup> | 3.5mg/m <sup>3</sup> | Not listed | 3mg/m <sup>3</sup> |
| Iron oxide                 | 1309-38-2                                | <4.5%      | Not listed           | Not listed           | Not listed | Not listed         |
| Metal Complex dye          | 109125-51-1<br>109125-50-0<br>84179-66-8 | <1.5%      | 0.5mg/m <sup>3</sup> | 0.5mg/m <sup>3</sup> | Not listed | Not listed         |

**3. HAZARDS IDENTIFICATION**

Most Important Hazards and Effects of the Products

**Human Health Effects** : There are no anticipated carcinogenic effects from exposure based on animal tests performed using toner. When used as intended according to instructions, studies do not indicate any symptoms of fibrosis will occur.

**Environmental Effects** : No data are available.

**Specific hazards** : Dust explosion (like most finely divided organic powders)

**4. FIRST-AID MEASURES**

| Route(s) of Entry: | <u>Inhalation?</u> | <u>Skin?</u> | <u>Ingestion?</u>          |
|--------------------|--------------------|--------------|----------------------------|
|                    | Yes                | No           | Possible but very unusual. |

**Inhalation** : Remove to fresh air. If symptoms occur, consult medical personnel.

**Skin Contact** : Wash with soap and water for 15 minutes or until particle is removed.  
If irritation does occur, consult medical personnel.

**Eye Contact** : flush eyes immediately with water for 15 minutes. If irritation does occur, consult medical personnel.

**Ingestion** : Rinse with water and drink several glasses of water . If irritation or discomfort does occur, consult medical personnel.

---

## 5. FIRE -FIGHTING MEASURES

---

**Extinguishing Media** : water, CO<sub>2</sub>, foam and dry chemicals  
**Special Fire fighting Procedures** : None  
**Fire and Explosion Hazards** : Toner material, like most finely divided organic powders, may form an explosive mixture.

---

## 6. ACCIDENTAL RELEASE MEASURES

---

**Personal Precautions** : None  
**Environmental Precautions** : None  
**Methods for Cleaning Up** : Wipe off with paper or cloth. Do not use vacuum cleaner when a large amount is released. It, like most finely divided organic powders, is capable of creating a dust explosion.

---

## 7. HANDLING AND STORAGE

---

### Handling

**Technical Measures** : None  
**Precautions** : None  
**Safe Handling Advice** : Use of a dust mask is recommended when handling a large quantity of toner or during long term exposure, as with any non-toxic dust. Try not to disperse the particles.

### Storage

**Technical Measures** : None  
**Storage Conditions** : Keep container closed and Store in a cool and dry place.  
Keep out of the reach of children.  
**Incompatible Products** : None

---

## 8. EXPOSURE CONTROL/PERSONAL PROTECTION

---

### Engineering Measures

**Ventilation** : None required with intended use.

### Exposure limit values

**OSHA-PEL (USA)** : 15mg/m<sup>3</sup> (Total Dust) , 5mg/m<sup>3</sup> (Respirable Dust)  
**ACGIH-TLV (USA)** : 10mg/m<sup>3</sup> (Total Dust) , 3mg/m<sup>3</sup> (Respirable Dust)

### Personal Protective Equipment

**Respiratory Protection** : None required when used as intended in Sharp equipment.  
**Hand Protection** : None required when used as intended in Sharp equipment.  
**Eye Protection** : None required when used as intended in Sharp equipment.  
**Skin Protection** : None required when used as intended in Sharp equipment.  
**Other Protective equipment** : Use of a dust mask and goggles are recommended when handling a large quantity of toner or during long term exposure, as with any non-toxic dust.

---

## 9. PHYSICAL AND CHEMICAL PROPERTIES

---

### Appearance

|                                     |                           |                     |                       |
|-------------------------------------|---------------------------|---------------------|-----------------------|
| <b>Physical State:</b> Solid        | <b>Form:</b> Powder       | <b>Color:</b> Black | <b>Odor:</b> odorless |
| <b>Ph</b> :                         | Not applicable            |                     |                       |
| <b>Boiling/Melting Point</b> :      | Not applicable            |                     |                       |
| <b>Softening Point (°C)</b> :       | 100-130                   |                     |                       |
| <b>Flash Point (°C)</b> :           | Not applicable            |                     |                       |
| <b>Ignition Point (°C)</b> :        | >350                      |                     |                       |
| <b>Explosion Properties</b> :       | No data                   |                     |                       |
| <b>Density (g/cm<sup>3</sup>)</b> : | 1.1 (bulk density : 0.35) |                     |                       |
| <b>Solubility in water</b> :        | Negligible                |                     |                       |

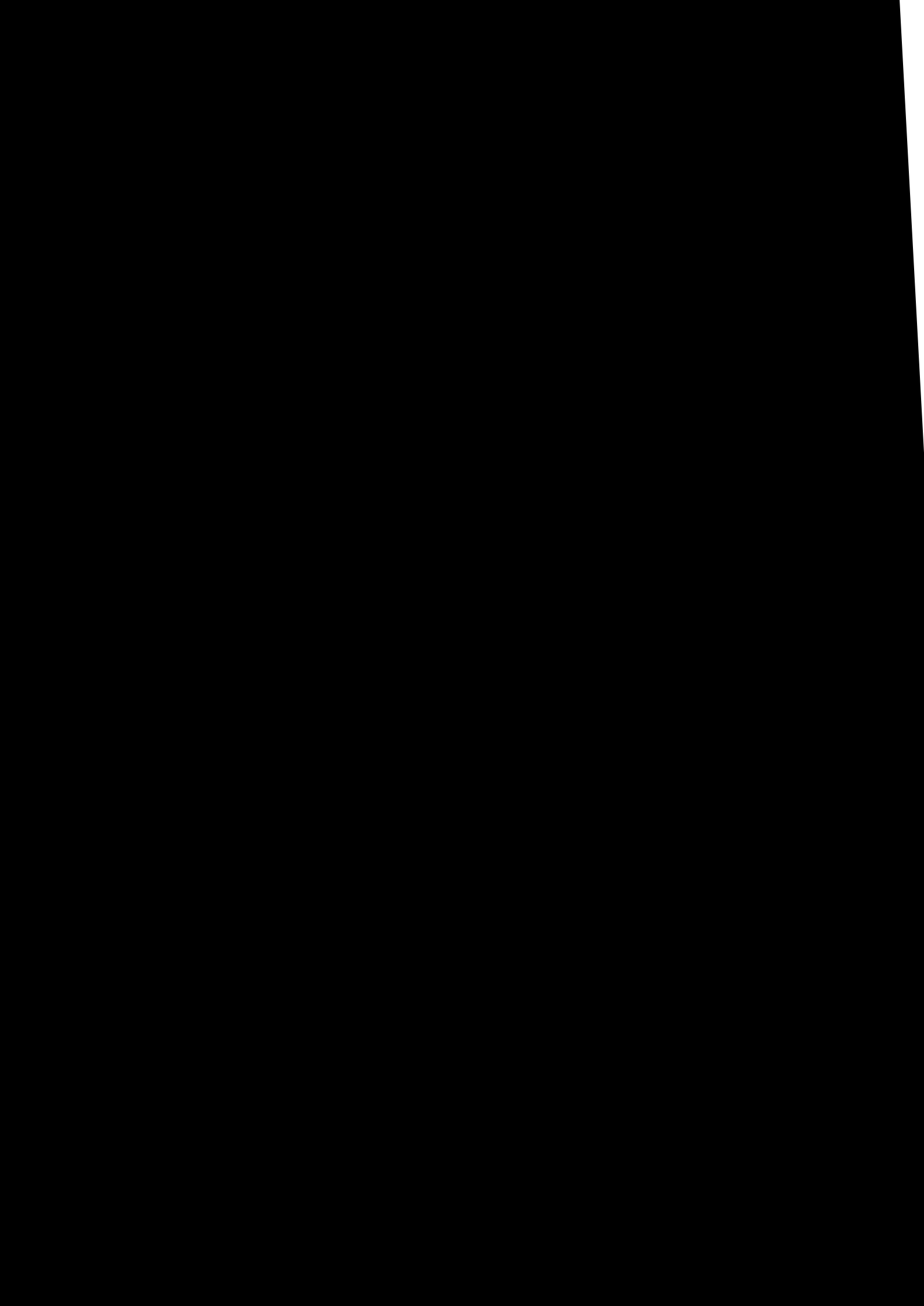

---

## 15. REGULATORY INFORMATION

---

### US Information

#### TSCA (Toxic Substances Control Act):

All chemical substances in this product comply with all applicable rules or order under TSCA.

#### SARA (Superfund Amendments and Reauthorization Act) Title III

302 Extreme Hazardous Substance: None

311/312 Hazard Classification : None

### EU Information

1999/45/EC and 67/548/EEC

Symbol & Indication : Not required

R-Phrase : Not required

76/769/EEC : All chemical substances in this product comply with all applicable rules or order under 76/769/EEC.

---

## 16. OTHER INFORMATION

---

NFPA Rating (USA) : Health=1 Flammability=1 Reactivity=0

WHMIS Legislation (Canada): This product is not a controlled product.

### References

IARC(1996) : IARC monographs on the Evaluation of the Carcinogenic Risk of Chemicals to Humans, Vol. 65, Printing Process And Printing Inks, Carbon Black and Some Nitro Compounds, Lyon, pp.149-261

H.Muhle, B.Bellmann, O.Creutzenberg, C.Dasenbrock, H.Ernst, R.Kilpper, J.C.MacKenzie, P.Morrow, U.Mohr, S.Takenaka, and R.Mermelstein(1991) Pulmonary Response to Toner upon Chronic Inhalation Exposure in Rats. Fundamental and Applied Toxicology 17, pp.280-299.

The information on this data sheet represents our current data and best opinion as to the proper use in handling of this product under normal conditions. However, all materials may present unknown hazards and should be used with caution. Although certain hazards are described herein, we do not guarantee that these are the only hazards which exist.

## 1. PRODUCT AND COMPANY IDENTIFICATION

**Product Name** : AR-270ND/270DV/270SD/270SD-C (Black Developer)  
**Supplier Identification**: Sharp Corporation  
22-22 Nagaike-cho, Abeno-ku, Osaka, Japan

Local suppliers are listed below. Please contact the nearest supplier for additional information.

| (Country)      | (Name and Telephone Number)  |
|----------------|--|
| U.S.A.         | Sharp Electronics Corporation<br>Telephone number for information : 1-800-237-4277<br>Emergency telephone number : 1-800-255-3924  |
| Canada         | Sharp Electronics of Canada Ltd.<br>Telephone number for information : 905-890-2100<br>Emergency telephone number : 1-800-255-3924 |
| United Kingdom | Sharp Electronics (U.K.) Ltd.<br>Telephone number for information : 01923-47-4013  |
| Australia      | Sharp Corporation of Australia PTY. Ltd.:<br>Telephone number for information: 1300-13-50-22                                       |
| Germany        | Sharp Electronics (Europe) GMBH<br>Telephone number for information: 40-2376-2737  |

## 2. COMPOSITION/INFORMATION ON INGREDIENTS

| Substance[ ]               | Preparation[X] |                   |                      |                      |                |                    |
|----------------------------|----------------|-------------------|----------------------|----------------------|----------------|--------------------|
| <u>Ingredient</u>          | <u>CAS No.</u> | <u>Proportion</u> | <u>OSHA PEL</u>      | <u>ACGIH TLV</u>     | <u>DFG-MAK</u> | <u>NOHSC-TWA</u>   |
| Iron powder                | 7439-89-6      | >92.5%            | Not listed           | Not listed           | Not listed     | Not listed         |
| Styrene-Acrylate copolymer | 29497-14-1     | <7%               | Not listed           | Not listed           | Not listed     | Not listed         |
| Carbon black               | 1333-86-4      | <1%               | 3.5mg/m <sup>3</sup> | 3.5mg/m <sup>3</sup> | Not listed     | 3mg/m <sup>3</sup> |

## 3. HAZARDS IDENTIFICATION

Most Important Hazards and Effects of the Products

Human Health Effects : There are no anticipated carcinogenic effects from exposure based on animal tests performed using toner. When used as intended according to instructions, studies do not indicate any symptoms of fibrosis will occur.

Environmental Effects : No data are available.

Specific hazards : None

## 4. FIRST-AID MEASURES

**Route(s) of Entry:**

|                    |              |                            |
|--------------------|--------------|----------------------------|
| <u>Inhalation?</u> | <u>Skin?</u> | <u>Ingestion?</u>          |
| No                 | No           | Possible but very unusual. |

**Inhalation** : Remove to fresh air. If symptoms occur, consult medical personnel.

**Skin Contact** : Wash with soap and water for 15 minutes or until particle is removed.  
If irritation does occur, consult medical personnel.

**Eye Contact** : flush eyes immediately with water for 15 minutes. If irritation does occur, consult medical personnel.

**Ingestion** : Rinse with water and drink several glasses of water . If irritation or discomfort does occur, consult medical personnel.

---

## 5. FIRE -FIGHTING MEASURES

---

**Extinguishing Media** : water, CO<sub>2</sub>, foam and dry chemicals  
**Special Fire fighting Procedures** : None  
**Fire and Explosion Hazards** : Like most finely divided organic powders, it may form an explosive mixture.

---

## 6. ACCIDENTAL RELEASE MEASURES

---

**Personal Precautions** : None  
**Environmental Precautions** : None  
**Methods for Cleaning Up** : Wipe off with paper or cloth. Do not use vacuum cleaner when a large amount is released. It, like most finely divided organic powders, is capable of creating a dust explosion.

---

## 7. HANDLING AND STORAGE

---

### Handling

**Technical Measures** : None  
**Precautions** : None  
**Safe Handling Advice** : Use of a dust mask is recommended when handling a large quantity of toner or during long term exposure, as with any non-toxic dust. Try not to disperse the particles.

### Storage

**Technical Measures** : None  
**Storage Conditions** : Keep container closed and Store in a cool and dry place.  
Keep out of the reach of children.  
**Incompatible Products** : None

---

## 8. EXPOSURE CONTROL/PERSONAL PROTECTION

---

### Engineering Measures

**Ventilation** : None required with intended use.

### Exposure limit values

**OSHA-PEL (USA)** : 15mg/m<sup>3</sup> (Total Dust) , 5mg/m<sup>3</sup> (Respirable Dust)  
**ACGIH-TLV (USA)** : 10mg/m<sup>3</sup> (Total Dust) , 3mg/m<sup>3</sup> (Respirable Dust)

### Personal Protective Equipment

**Respiratory Protection** : None required when used as intended in Sharp equipment.  
**Hand Protection** : None required when used as intended in Sharp equipment.  
**Eye Protection** : None required when used as intended in Sharp equipment.  
**Skin Protection** : None required when used as intended in Sharp equipment.  
**Other Protective equipment** : Use of a dust mask and goggles are recommended when handling a large quantity of toner or during long term exposure, as with any non-toxic dust.

---

## 9. PHYSICAL AND CHEMICAL PROPERTIES

---

### Appearance

|                                     |                          |                     |                       |
|-------------------------------------|--------------------------|---------------------|-----------------------|
| <b>Physical State:</b> Solid        | <b>Form:</b> Powder      | <b>Color:</b> Black | <b>Odor:</b> odorless |
| <b>Ph</b> :                         | Not applicable           |                     |                       |
| <b>Boiling/Melting Point</b> :      | Not applicable           |                     |                       |
| <b>Flash Point (°C)</b> :           | Not applicable           |                     |                       |
| <b>Explosion Properties</b> :       | No data                  |                     |                       |
| <b>Density (g/cm<sup>3</sup>)</b> : | 7.3 (bulk density : 2.0) |                     |                       |
| <b>Solubility in water</b> :        | Negligible               |                     |                       |

---

## 10. STABILITY AND REACTIVITY

---

|   |   |
|---|---|
| <b>Stability</b>                        | : Stable  |
| <b>Hazardous Reactions</b>              | : Dust explosion, like most finely divided organic powders. |
| <b>Conditions to avoid</b>              | : Electric discharge, throwing into fire.                   |
| <b>Materials to avoid</b>               | : Oxidizing Materials                                       |
| <b>Hazardous Decomposition Products</b> | : CO, CO <sub>2</sub> and NO <sub>x</sub>                   |
| <b>Further Information</b>              | : None  |

---

## 11. TOXICOLOGICAL INFORMATION

---

### Acute Toxicity

|                 |                               |
|-----------------|-------------------------------|
| Ingestion(oral) | : LD <sub>50</sub> >2000mg/kg |
| Dermal          | : No Data                     |
| Inhalation      | : LC <sub>50</sub> >4.97mg/L  |
| Eye irritation  | : Not an irritant             |
| Skin irritation | : Not an irritant             |
| Skin sensitizer | : None                        |

**Mutagenicity** : Negative (Ames Test)

**Carcinogenicity** : In 1996 the IARC reevaluated carbon black as a Group 2B carcinogen (possible human carcinogen). This classification is given to chemicals for which there is inadequate human evidence, but sufficient animal evidence on which to base an opinion of carcinogenicity. The classification is based upon the development of lung tumors in rats receiving chronic inhalation exposures to free carbon black at levels that induce particle overload of the lung. Studies performed in animal models other than rats did not show any association between carbon black and lung tumors. Moreover, a two-year cancer bioassay using a typical toner preparation containing carbon black demonstrated no association between toner exposure and tumor development in rats.

**Chronic Effect** : In a study in rats of chronic inhalation exposure to a typical toner, a mild to moderate degree of lung fibrosis was observed in 92% of the rats in the high concentration (16mg/m<sup>3</sup>) exposure group, and a minimal to mild degree of fibrosis was noted in 22% of the animals in the middle (4mg/m<sup>3</sup>) exposure group, but no pulmonary change was reported in the lowest (1mg/m<sup>3</sup>) exposure group, the most relevant level to potential human exposures.

---

## 12. ECOLOGICAL INFORMATION

---

No data are available.

---

## 13. DISPOSAL CONSIDERATION

---

|                               |   |
|-------------------------------|---|
| <b>Waste from residues</b>    | : Waste material may be dumped or incinerated under conditions which meet all federal, state and local environmental regulations. |
| <b>Contaminated Packaging</b> | : Waste may be disposed or incinerated under conditions which meet all federal, state and local environmental regulations.        |

---

## 14. TRANSPORT INFORMATION

---

|                   |        |
|-------------------|--------|
| UN Classification | : None |
| Land DOT (USA)    | : None |
| Sea IMDG          | : None |
| Air ICAO-TI       | : None |

---

## 15. REGULATORY INFORMATION

---

### US Information

TSCA (Toxic Substances Control Act):

All chemical substances in this product comply with all applicable rules or order under TSCA.

SARA (Superfund Amendments and Reauthorization Act) Title III

302 Extreme Hazardous Substance : None

311/312 Hazard Classification : None

### EU Information

1999/45/EC and 67/548/EEC

Symbol & Indication : Not required

R-Phrase : Not required

76/769/EEC : All chemical substances in this product comply with all applicable rules or order under 76/769/EEC.

---

## 16. OTHER INFORMATION

---

NFPA Rating (USA) : Health=1 Flammability=1 Reactivity=0

WHMIS Legislation (Canada): This product is not a controlled product.

### References

IARC(1996) : IARC monographs on the Evaluation of the Carcinogenic Risk of Chemicals to Humans, Vol. 65, Printing Process And Printing Inks, Carbon Black and Some Nitro Compounds, Lyon, pp.149-261

H.Muhle, B.Bellmann, O.Creutzenberg, C.Dasenbrock, H.Ernst, R.Kilpper, J.C.MacKenzie, P.Morrow, U.Mohr, S.Takenaka, and R.Mermelstein(1991) Pulmonary Response to Toner upon Chronic Inhalation Exposure in Rats. Fundamental and Applied Toxicology 17, pp.280-299.

The information on this data sheet represents our current data and best opinion as to the proper use in handling of this product under normal conditions. However, all materials may present unknown hazards and should be used with caution. Although certain hazards are described herein, we do not guarantee that these are the only hazards which exist.





**SHARP**<sup>®</sup>

**SHARP ELECTRONICS CORPORATION**

Sharp Plaza, Mahwah, New Jersey 07430-2135.

[www.sharp-usa.com](http://www.sharp-usa.com)

**SHARP CORPORATION**

## Free Manuals Download Website

<http://myh66.com>

<http://usermanuals.us>

<http://www.somanuals.com>

<http://www.4manuals.cc>

<http://www.manual-lib.com>

<http://www.404manual.com>

<http://www.luxmanual.com>

<http://aubethermostatmanual.com>

Golf course search by state

<http://golfingnear.com>

Email search by domain

<http://emailbydomain.com>

Auto manuals search

<http://auto.somanuals.com>

TV manuals search

<http://tv.somanuals.com>