

# **SHARP®**

## **Digital Laser Copier/Printer**

### **Operation Manual**

**MODEL**

# **AL-1340**



## FOR YOUR PROTECTION...

To aid in reporting this compact copier in case of loss or theft, please record below the model number and serial number located on the back of the unit. We also suggest you record all the information listed and retain for future reference.

MODEL NUMBER \_\_\_\_\_ SERIAL NUMBER \_\_\_\_\_

DATE OF PURCHASE \_\_\_\_\_

Dealer \_\_\_\_\_

Address \_\_\_\_\_ City \_\_\_\_\_

State \_\_\_\_\_ Zip \_\_\_\_\_ Telephone \_\_\_\_\_

Service Station \_\_\_\_\_

Address \_\_\_\_\_ City \_\_\_\_\_

State \_\_\_\_\_ Zip \_\_\_\_\_ Telephone \_\_\_\_\_

To obtain service, or to obtain product literature, accessories, or supplies,

please call **1-(630)378-3590** in the USA

or **1-877-SHARP-CC** (toll free)/**905-568-7140** in Canada.

For customer assistance, please visit **<http://www.sharp-usa.com>** (for USA) or **<http://www.sharp.ca>** (for Canada) on the World Wide Web or call **1-(630)378-3590** (for USA).



---

# CONTENTS

## 1 GETTING STARTED

- INTRODUCTION 3
- CAUTIONS 3
- MAIN FEATURES 4
- PART NAMES 6
- OPERATION PANEL 7

## 2 INSTALLATION

- COPIER INSTALLATION 8
- CAUTIONS ON HANDLING 9
- CHECKING PACKED COMPONENTS AND ACCESSORIES 10
- UNPACKING 10
- REMOVING PROTECTIVE PACKING MATERIALS 11
- INSTALLING THE TD CARTRIDGE 11
- LOADING COPY PAPER (installing the paper tray) 13
- POWER TO COPIER 15
- POWER ON 16
  - Initial settings of operation panel 16

## 3 MAKING COPIES

- PAPER 17
- NORMAL COPYING 18
  - Setting a large original 19
- EXPOSURE ADJUSTMENT/PHOTO COPYING 20
- REDUCTION/ENLARGEMENT/ZOOM 20
- BYPASS FEED (special paper) 21
- TWO-SIDED COPYING 22

## 4 SPECIAL FUNCTIONS

- DESCRIPTION OF SPECIAL FUNCTIONS 23
- TONER SAVE MODE 23
- USER PROGRAMS (power save modes, auto clear time) 24
  - Setting the power save modes and auto clear time 24

## **5 SUPPLIES AND USER MAINTENANCE**

- TD CARTRIDGE REPLACEMENT 26
- DRUM CARTRIDGE REPLACEMENT 27
- USER MAINTENANCE 28
  - Cabinet 28
  - Original table and original cover 29
  - Transfer charger 29
  - When copier is not in use 30

## **6 COPIER TROUBLE?**

- MISFEED REMOVAL 31
  - A Misfeed in the paper feed area 31
  - B Misfeed in the fusing area 32
  - C Misfeed in the transport area 33
- TROUBLESHOOTING 34
- STATUS INDICATORS 35
- DISPLAYING TOTAL NUMBER OF COPIES 35
- AUTOMATIC EXPOSURE ADJUSTMENT 36

## **7 APPENDIX**

- SPECIFICATIONS 37
- SUPPLY PART NUMBERS AND STORAGE 38
- MOVING INSTRUCTIONS 39

## **INDEX**

# 1

# GETTING STARTED

This chapter provides basic information for using the copier.

## INTRODUCTION

This copier has been designed to provide intuitive operating ease while requiring a minimum amount of space. To get full use of all copier features, be sure to familiarize yourself with this manual and the copier.

For quick reference during copier use, keep this manual in a handy location.



Note

This copier can be used as a laser printer. This manual describes only the copier features. For description of the printer features, see the printer operation manual.

### Conventions used in this manual

In this manual, the following icons are used to provide the user with information pertinent to the use of the copier.



Warning

Warns the user that injury to the user or damage to the copier may result if the contents of the warning are not properly followed.



Caution

Cautions the user that damage to the copier or one of its components may result if the contents of the caution are not properly followed.



Note

Notes provide information relevant to the copier regarding specifications, functions, performance, operation and such, that may be useful to the user.



Indicates a letter displayed in the display.

## CAUTIONS

Follow the cautions below when using this copier.



Warning

- The fusing area is hot. Exercise care in this area when removing misfed paper.
- Do not look directly at the light source. Doing so may damage your eyes.
- Do not switch the copier rapidly on and off. After turning the copier off, wait 10 to 15 seconds before turning it back on.
- Copier power must be turned off before installing any supplies.

## CAUTIONS



Caution

- Place the copier on a firm, level surface.
- Do not install the copier in a humid or dusty location.
- When the copier is not used for long time, for example for consecutive holidays, turn the power switch off and remove the power cord from the outlet.
- When moving the copier, be sure to turn the power switch off and remove the power cord from the outlet.
- Do not cover the copier with a dust cover, cloth or plastic film while the power is on. Doing so may prevent heat radiation, damaging the copier.
- Use of controls or adjustments or performance of procedures other than those specified herein may result in hazardous radiation exposure.

## SAFETY PRECAUTIONS

This Digital Copier is rated Class 1 and complies with 21 CFR 1040.10 and 1040.11 of the CDRH standards. This means that the copier does not produce hazardous laser radiation. For your safety, observe the precautions below.

- Do not remove the cabinet, operation panel or any other covers.
- The copier's exterior covers contain several safety interlock switches. Do not bypass any safety interlock by inserting wedges or other items into switch slots.

## MAIN FEATURES

### ① High-speed laser copying

- Since warm-up time is zero, copying can be started immediately after the power switch is turned on.
- First-copy time is only 9.6 seconds (normal mode).
- Copying speed is 13 copies/min., which adapts to business use, allowing improvement of working efficiency.

### ② High-quality digital image

- High-quality image copying at 600 dpi can be performed.
- In addition to the automatic exposure mode, the manual exposure can be adjusted in five steps.
- The photo mode copying function allows clear copying of delicate halftone original images such as monochrome photos and color photos.

### ③ Substantial copying functions

- Zoom copying from 50% to 200% in 1% increments can be performed.
- Continuous copying of maximum 99 sheets can also be performed.
- Toner save mode reduces toner consumption by approximately 10%.
- User programs allow setting/modification of functions for customer's needs.

### ④ Scan once/ Print many

- This copier is equipped with a 1-page memory buffer. This memory allows the copier to scan an original 1 time only and make up to 99 copies. This feature allows for improved workflow, reduced operating noise from the copier and reduced wear and tear on the scanning mechanism. This feature provides for a higher reliability.

### ⑤ Printer feature

- This copier can be used as a laser printer.

### ⑥ Environmentally friendly design

- Paper output tray is housed in the copier for space saving.
- Preheat mode and auto power shut-off mode are provided to reduce power consumption in standby mode.

# PART NAMES

1

Getting started

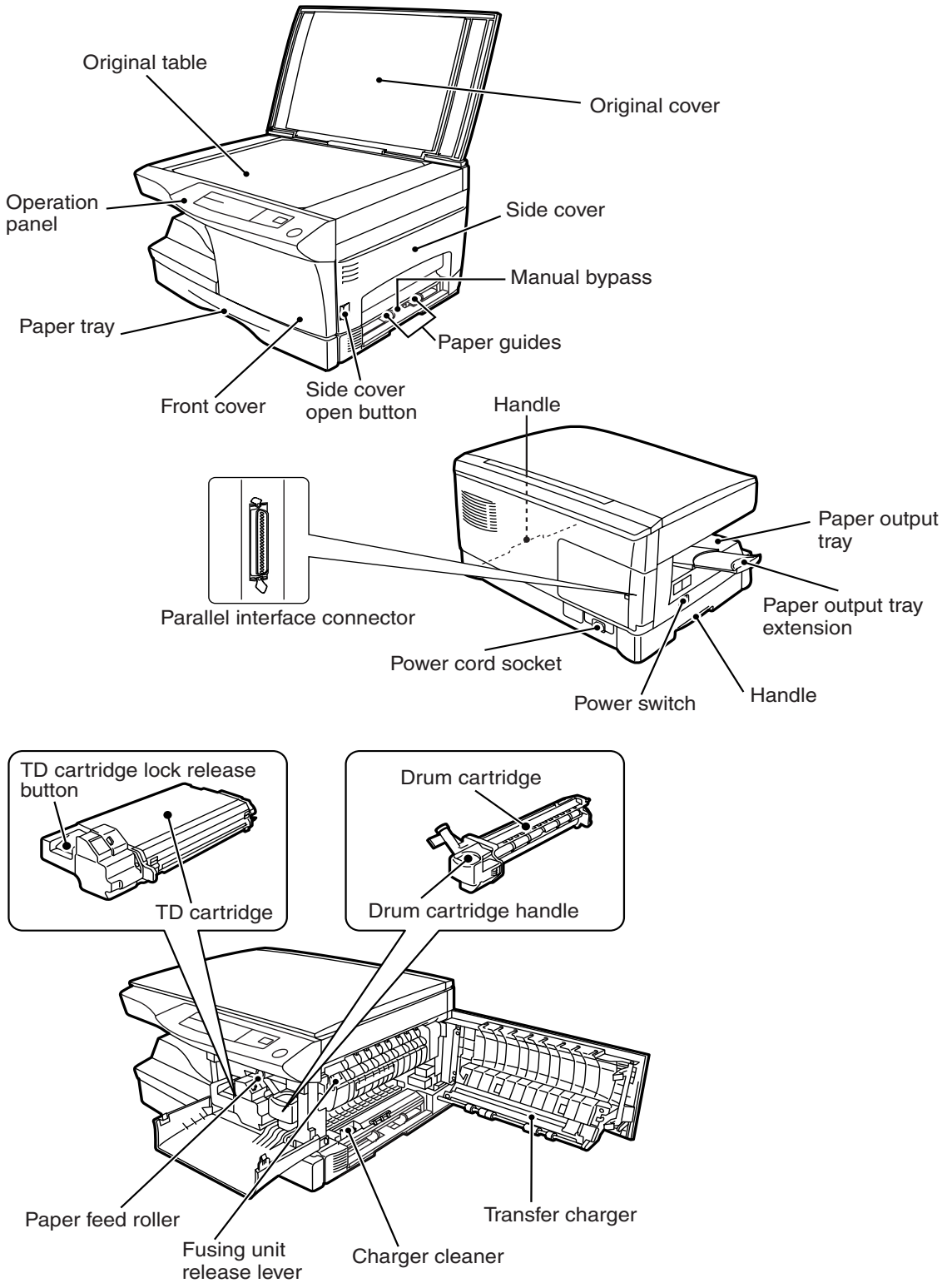



# OPERATION PANEL

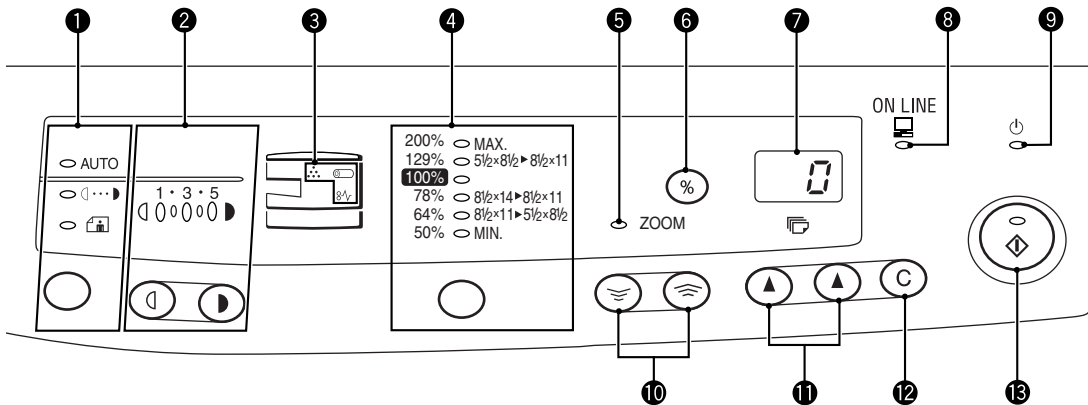

## 1 Exposure mode selector key and indicators

Use to sequentially select the exposure modes: AUTO, MANUAL or PHOTO. Selected mode is shown by a lit indicator. (p. 20)

## 2 Light and dark keys and exposure level indicators

Use to adjust the MANUAL or PHOTO exposure level. Selected exposure level is shown by a lit indicator. (p. 20)  
Use to start and terminate user program setting. (p. 24)

## 3 Alarm indicators

: Drum replacement required indicator (p. 27)  
 : Misfeed indicator (p. 31)  
 : TD cartridge replacement required indicator (p. 26)

## 4 Copy ratio selector key and copy ratio indicators

Use to sequentially select preset reduction/enlargement copy ratios. Selected copy ratio is shown by a lit indicator. (p. 20)

## 5 Zoom indicator (p. 20)

## 6 Copy ratio display (%) key (p. 20)

## 7 Display

Displays the specified copy quantity, zoom copy ratio, user program code, and error code.

## 8 ON LINE indicator

Lights up when the machine is used as a printer. For description of the ON LINE indicator, see the printer operation manual.

## 9 Power save indicator

Lights up when the copier is in a power save mode. (p. 23, 24)

## 10 Zoom keys

Use to select any reduction or enlargement copy ratio from 50 to 200% in 1% increments. (p. 20)

## 11 Copy quantity keys

- Use to select the desired copy quantity (1 to 99). (p. 18)
- Use to make user program entries. (p. 24)

## 12 Clear key

- Press to clear the display, or press during a copy run to terminate copying. (p. 18)
- Press and hold down during standby to display the total number of copies made to date. (p. 35)

## 13 Print key and ready indicator

- Copying is possible when the indicator is on.
- Use to set a user program.

# 2

# INSTALLATION

Follow the installation procedure below to use the copier properly.

## COPIER INSTALLATION

Improper installation may damage the copier. Please note the following during initial installation and whenever the copier is moved.



Caution

If the copier is moved from a cool place to a warm place, condensation may form inside the copier. Operation in this condition will cause poor copy quality and malfunctions. Leave the copier at room temperature for at least 2 hours before use.

**Do not install your copier in areas that are:**

- damp, humid, or very dusty

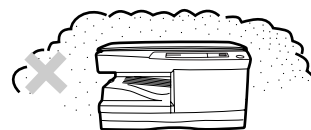

- exposed to direct sunlight

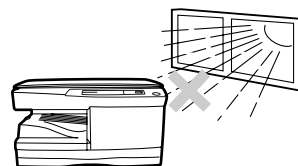

- poorly ventilated

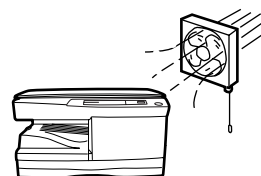

- subject to extreme temperature or humidity changes, e.g., near an air conditioner or heater.

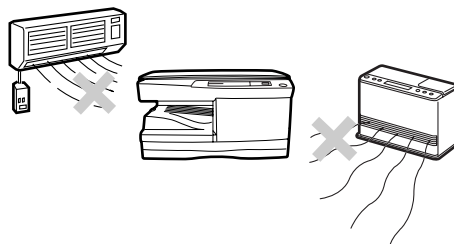

**Be sure to allow the required space around the machine for servicing and proper ventilation.**

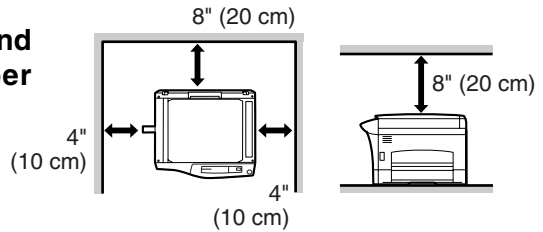

A small amount of ozone is produced within the copier during operation. The emission level is insufficient to cause any health hazard.

**NOTE:**

The present recommended long term exposure limit for ozone is 0.1 ppm (0.2 mg/m<sup>3</sup>) calculated as an 8 hr. time-weighted average concentration.

However, since the small amount that is emitted may have an objectionable odor, it is advisable to place the copier in a ventilated area.

## CAUTIONS ON HANDLING

Be careful in handling the copier as follows to maintain the performance of this copier.

**Do not drop the copier, subject it to shock or strike it against any object.**

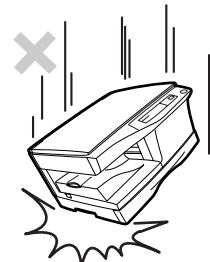

**Do not expose the drum cartridge to direct sunlight.**

Doing so will damage the surface (green portion) of the drum cartridge, causing smudges on copies.

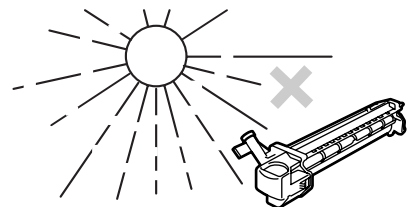

**Store spare supplies such as drum cartridges and TD cartridges in a dark place without removing from the package before use.**

If they are exposed to direct sunlight, smudges on copies may result.

**Do not touch the surface (green portion) of the drum cartridge.**

Doing so will damage the surface of the cartridge, causing smudges on copies.

# CHECKING PACKED COMPONENTS AND ACCESSORIES

Open the carton and check if the following components and accessories are included.

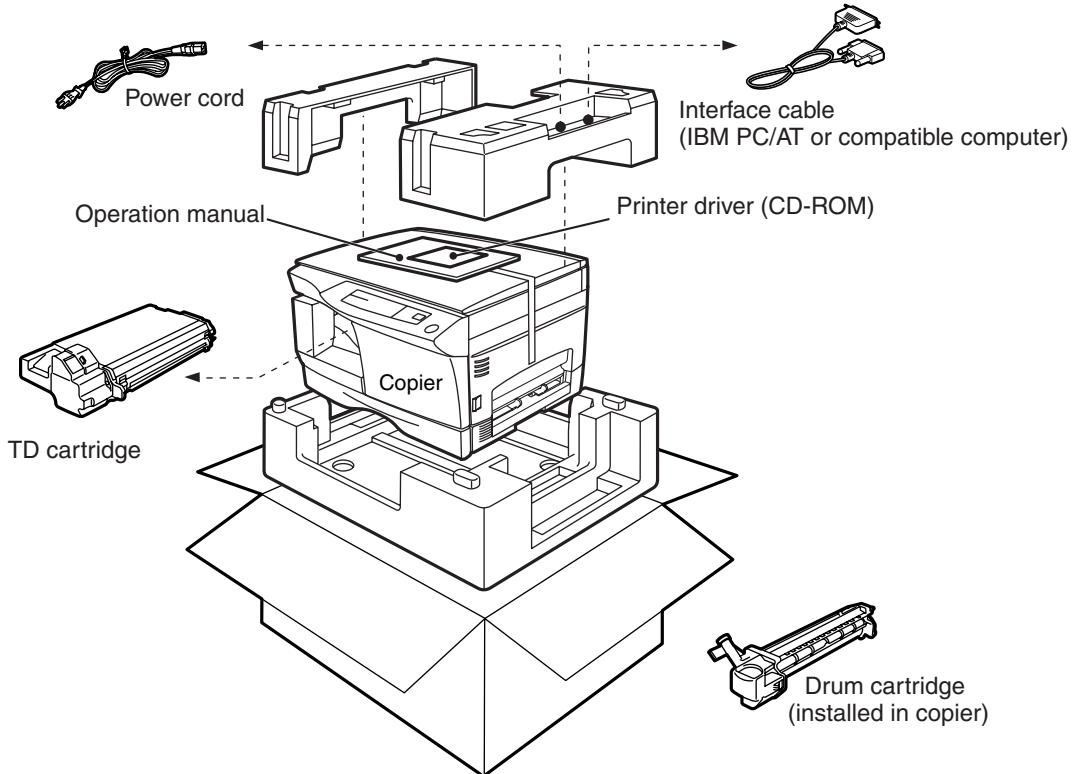

Note

- If anything is not included or is damaged, contact our Technical Assistance Department at 1-(630)378-3590 in the USA or 1-877-SHARP-CC (toll free)/ 905-568-7140 in Canada.
- Save the carton and packing materials. These can be re-used for transporting the machine, should it be necessary.

## UNPACKING

Be sure to hold the handles on both sides of the copier to unpack the copier and carry it to the installation location.

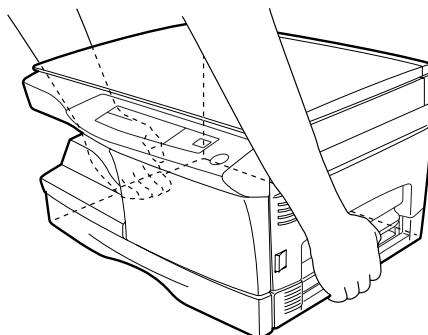

# REMOVING PROTECTIVE PACKING MATERIALS

- 1 Remove pieces of tape (a), (b), (c), (d), and (e) and protective cover (f). Then open the original cover and remove protective materials (g) and (h).

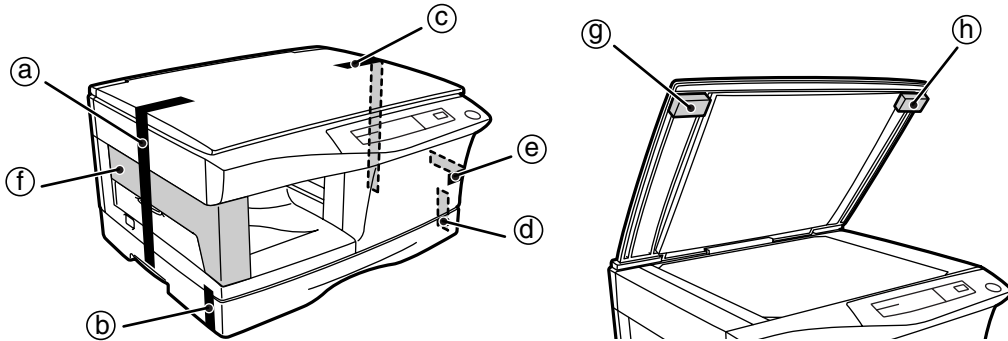

- 2 Use a coin (or suitable object) to remove the screw.



Caution

Store the screw in the paper tray because it will be used if the copier has to be moved. (p. 14)

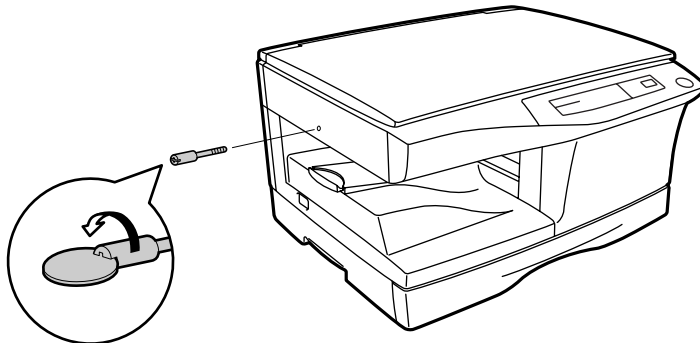

# INSTALLING THE TD CARTRIDGE

- 1 Open the side cover while pressing the side cover open button.

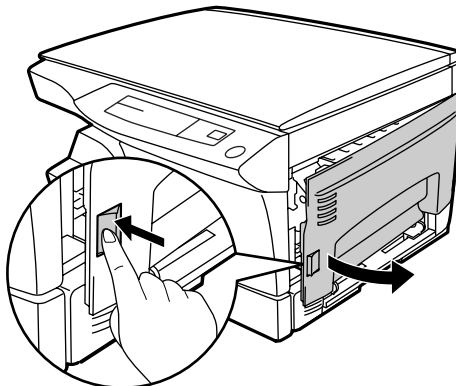

## INSTALLING THE TD CARTRIDGE

- 2** Remove the CAUTION tape from the front cover and remove the two protective pins from the fusing unit by pulling the strings upward one at a time.

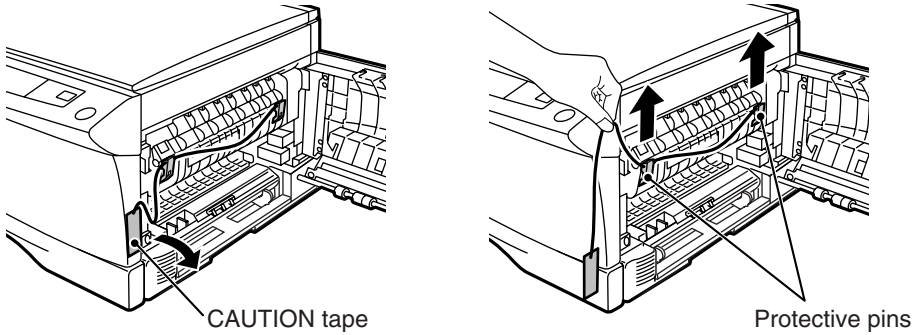

- 3** Push gently on both sides of the front cover to open the cover.

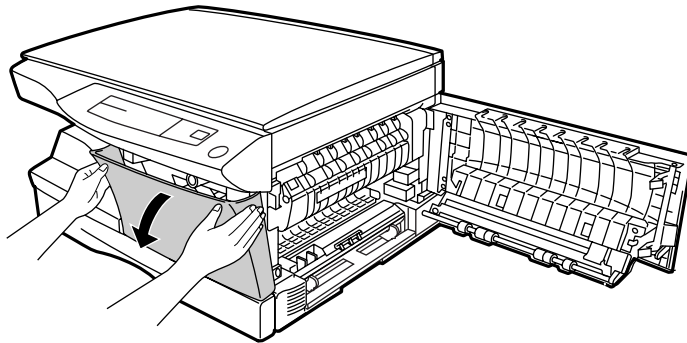

- 4** Remove the TD cartridge from the bag. Remove the protective paper. Hold the cartridge on both sides and shake it horizontally four or five times.

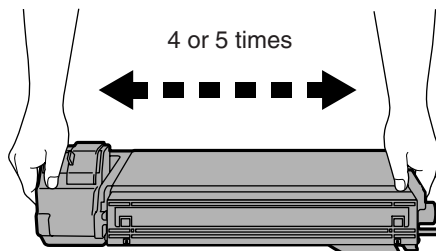

- 5** Hold the tab of the protective cover and pull the tab to your side to remove the cover.

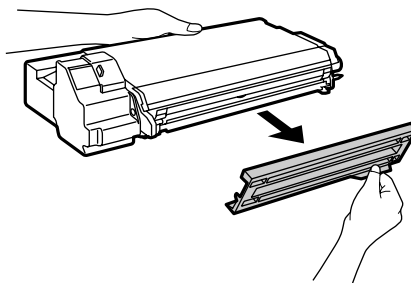

- 6** Gently insert the TD cartridge until it locks in place.

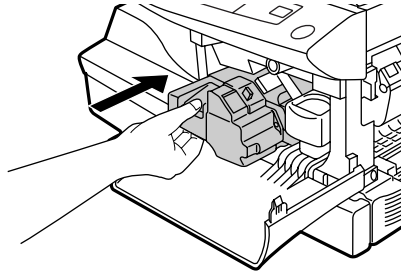

- 7** Close the front cover and then the side cover by pressing the round projections near the side cover open button.



Caution

When closing the covers, be sure to close the front cover securely and then close the side cover. If the covers are closed in the wrong order, the covers may be damaged.

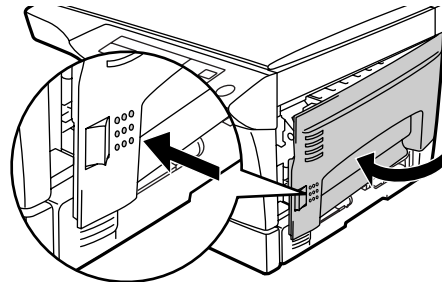
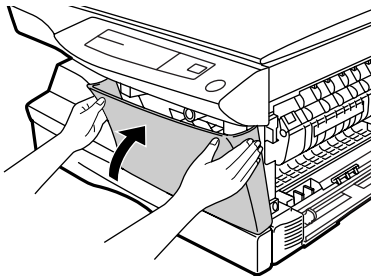

## LOADING COPY PAPER (installing the paper tray)

- 1** Raise the handle of the paper tray and pull the paper tray out until it stops.

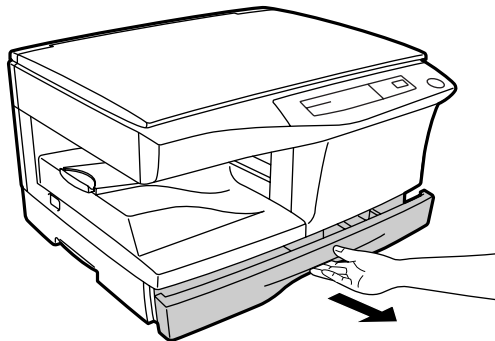

## LOADING COPY PAPER

- 2** Remove the pressure plate lock. Rotate the pressure plate lock in the direction of the arrow to remove it while pressing down the pressure plate of the paper tray.

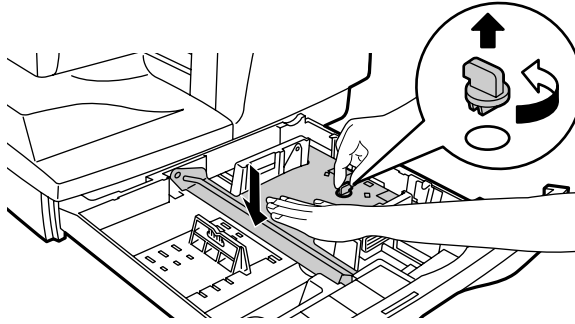

- 3** Store the pressure plate lock which has been removed in step 2 and the screw which has been removed when unpacking (see page 11, step 2 of **REMOVING PROTECTIVE PACKING MATERIALS**) in the front of the paper tray. To store the pressure plate lock, rotate the lock to fix it on the relevant location.

Pressure plate lock

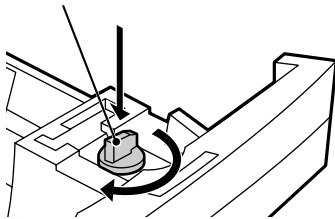

Screw

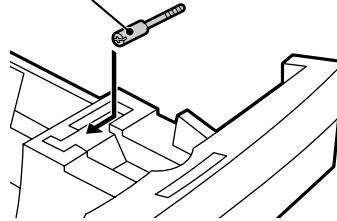

- 4** Adjust the paper guides on the paper tray to the copy paper width and length. Squeeze the lever of paper guide (A) and slide the guide to match with the width of the paper. Move paper guide (B) to the appropriate slot as marked on the tray.

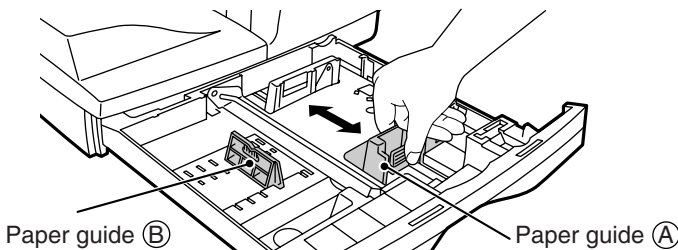

- 5** Fan the copy paper and insert it into the tray. Make sure the edges go under the corner hooks.



Note

Do not load paper above the maximum height line (  ). Exceeding the line will cause a paper misfeed.

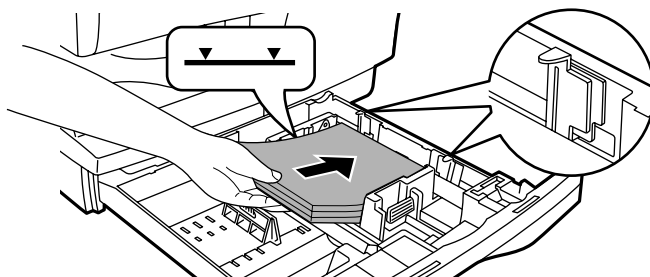



- 6** Gently push the paper tray back into the copier.



Note

After loading copy paper, to cancel the blinking "P" without restarting copying, press the clear (C) key. The "P" in the display will go out and the ready (R) indicator will light up.

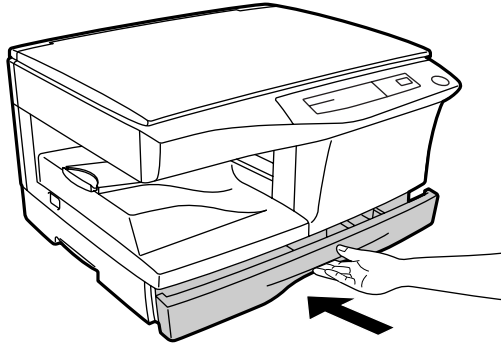

## POWER TO COPIER

- 1** Ensure that the power switch of the copier is in the OFF position. Insert the attached power cord into the power cord socket at the rear of the copier.



Warning

If you use the copier in a country other than the country where the copier was purchased, you will need to make sure that your local power supply is compatible with your model. If you plug the copier into an incompatible power supply, irreparable damage to the copier will result.

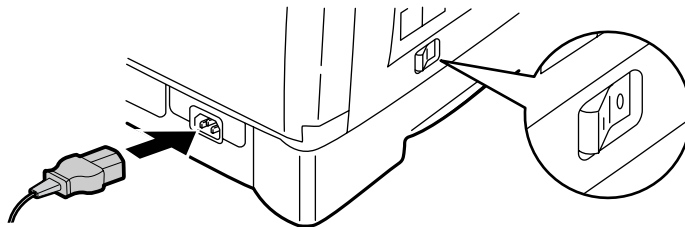

- 2** Plug the other end of the power cord into the nearest outlet.



Caution

Only insert the power cord into a properly grounded wall socket. Do not use extension cords or power strips.

# POWER ON

Turn the power switch on the left side of the copier to the "ON" position. The ready (Ⓞ) indicator will light up and other indicators which show the initial settings of the operation panel will also light up to indicate the ready condition. For the initial settings, see the "Initial settings of operation panel" described below.



Note

- The copier will enter a power save mode once the set time has elapsed without any copier operation after the last copy of a run is made or power is turned on. The settings of the power save modes can be modified. See page 24, **USER PROGRAMS**.
- The copier will return to the initial settings a preset amount of time after the last copy is made. The preset amount of time (auto clear time) can be changed. See page 24, **USER PROGRAMS**.

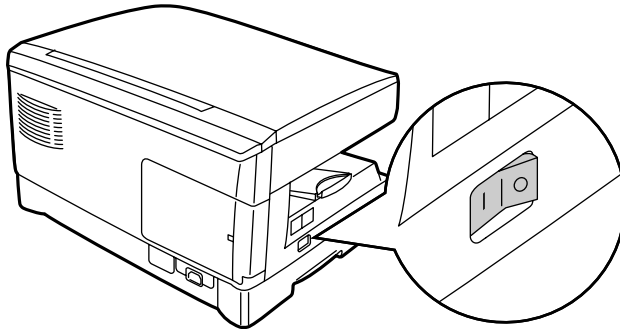

## Initial settings of operation panel

The copier assumes the initial settings when the copier is turned on or a preset time (auto clear time) elapses after the last copy is made. The initial settings of the operation panel are shown below.

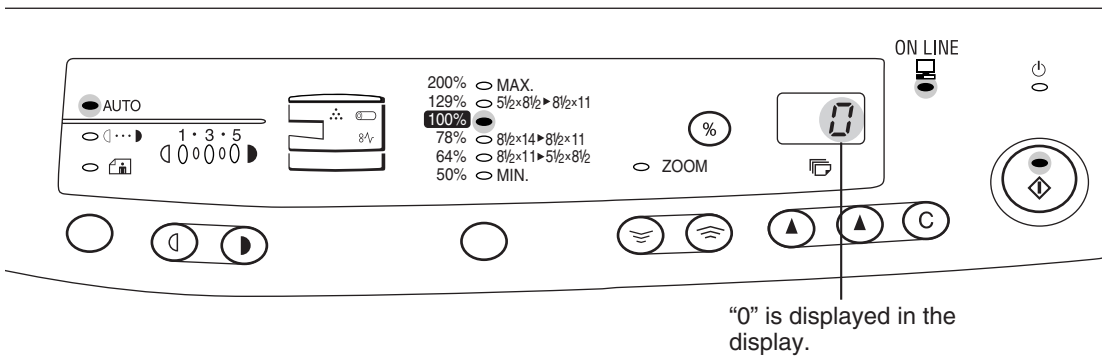

# 3

# MAKING COPIES

This chapter describes basic copying functions and some other copying functions using the manual bypass.

## PAPER

For best results, use only paper recommended by SHARP.

Type of paper feeding	Type of media		Size	Weight
Paper tray	Standard paper		Letter (8-1/2" x 11") Legal (8-1/2" x 14") Invoice (5-1/2" x 8-1/2") A4 (210mm x 297mm) B5 (182mm x 257mm) A5 (148.5mm x 210mm)	15 lbs. to 21 lbs.
Manual bypass	Standard paper and thick paper		Letter (8-1/2" x 11") Legal (8-1/2" x 14") Invoice (5-1/2" x 8-1/2") A4 (210mm x 297mm) B5 (182mm x 257mm) A5 (148.5mm x 210mm) A6 (105mm x 148.5mm)	14 lbs. to 34.5 lbs.**
	Special media	Transparency film	Letter (8-1/2" x 11") A4 (210mm x 297mm)	
		Envelope*	Commercial 10 (4-1/8" x 9-1/2") Monarch (3-7/8" x 7-1/2") International DL (110mm x 279.4mm) International C5 (162mm x 229mm)	

\* Do not use envelopes that have metal clasps, plastic snappers, string closures, windows, linings, self-adhesive, patches or synthetic materials. These will cause physical damage to the copier.

\*\* For paper weighing from 28 to 34.5 lbs., 8-1/2" x 11" is the maximum size that can be fed through the manual bypass.

- Special papers such as transparency film and labels must be fed one sheet at a time through the manual bypass.

# NORMAL COPYING

- 1 Ensure that paper of the desired size is set in the paper tray. See page 13, **LOADING COPY PAPER**. When copying onto 8-1/2" x 11" paper or a larger size, pull out the paper output tray extension.

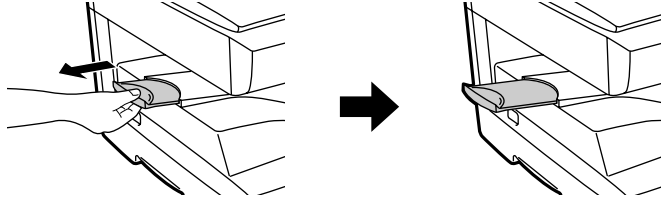

- 2 Turn the power switch on.

- 3 Open the original cover.

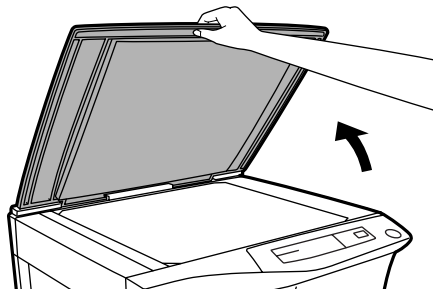

- 4 Place the original face down on the original table. Align it with the original scale and the centering (▶) mark.

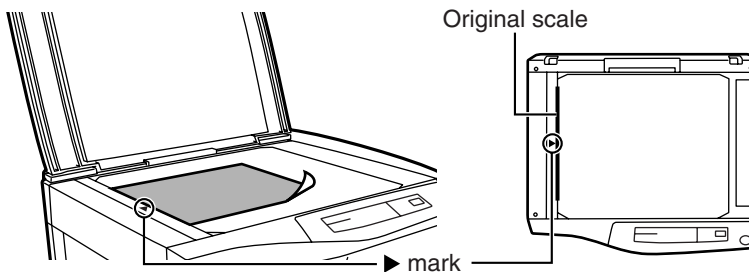

- 5 Gently close the original cover. When copying a book or an original which has been folded or a crumpled original, press down the original cover lightly. If the original cover is not securely closed, the copies may be striped or blurred.

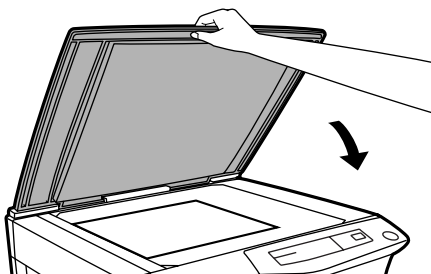

A book, an original which has been folded, a crumpled original

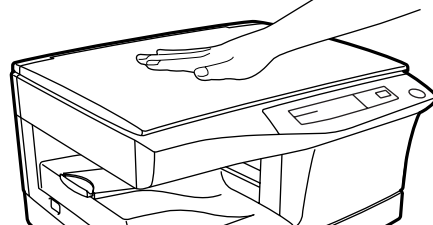

**6** Set the number of copies using the two copy quantity ( $\uparrow$ ,  $\uparrow$ ) keys.



Note

- Press the clear (C) key to clear an entry if a mistake is made.
- A single copy can be made with the initial setting, i.e., when “0” is displayed.

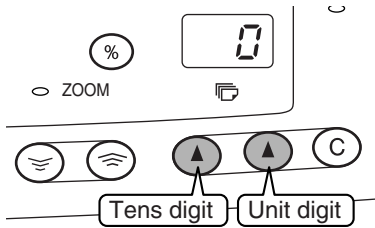

- Press the right copy quantity key to set the unit digit from 0 to 9. This key will not change the tens digit.
- Press the left copy quantity key to set the tens digit from 1 to 9.

**7** Press the print ( $\uparrow$ ) key.



Note

- To display the number of copies made in a continuous run, press the left copy quantity key.
- To stop copying in the middle of a run, press the clear (C) key. Copying will stop and the number in the display will be reset to “0”.

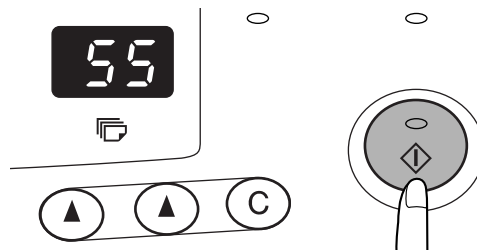

### Setting a large original

The original cover can be removed to allow copying of bulky objects.

**1** Simply lift the original cover straight up.

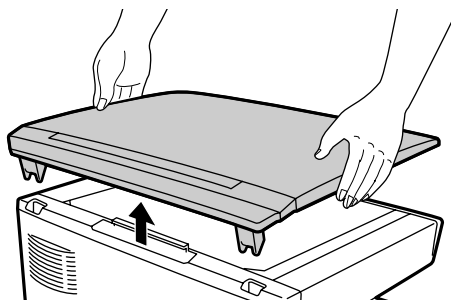

**2** To reattach the original cover, reverse the above procedure.

# EXPOSURE ADJUSTMENT/PHOTO COPYING

Copy density adjustment is not required for most originals in the automatic exposure mode. To adjust the copy density manually or to copy photographs, the exposure level can be adjusted in five steps manually.

- 1 Set the original and check the copy paper size.
- 2 Press the exposure mode selector key to select the manual (☐⋯☐) mode or photo (📷) mode.

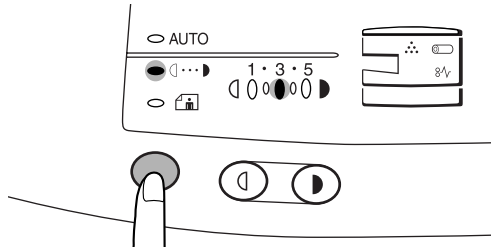

- 3 Use the light (☐) and dark (◐) keys to adjust the exposure level. If exposure level 2 is selected, the two left-handmost indicators for that level will light up simultaneously. Also, if level 4 is selected, the two right-handmost indicators for that level will light up simultaneously.

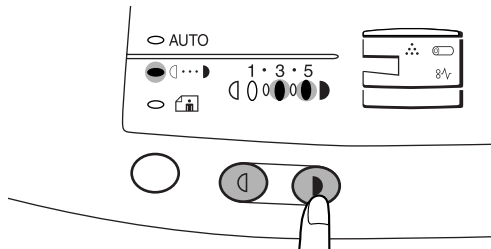

- 4 Set the number of copies using the copy quantity (▲, ▲) keys and press the print (Ⓢ) key.

# REDUCTION/ENLARGEMENT/ZOOM

Three preset reduction ratios and two enlargement ratios can be selected. The zoom function enables copy ratio selection from 50% to 200% in 1% increments.

- 1 Set the original and check the copy paper size.
- 2 Use the copy ratio selector key and/or zoom (⊖, ⊕) keys to select the desired copy ratio.



Note

- To verify a zoom setting without changing the zoom ratio, press and hold down the copy ratio display (%) key. When the key is released, the display will return to the copy quantity display.
- To reset the ratio to 100%, press the copy ratio selector key repeatedly until the 100% indicator lights up.

**To select a preset copy ratio:**



Preset reduction and enlargement ratios are: 50%, 64%, 78%, 129%, and 200%

**To select a zoom ratio:**



When a zoom ( or ) key is pressed, the ZOOM indicator will light up and the zoom ratio will be displayed in the display.

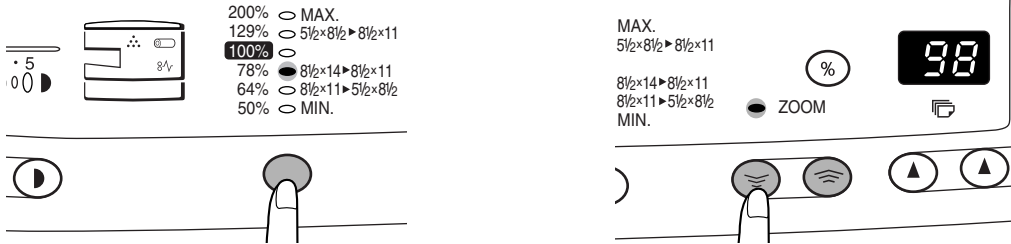

Note

To decrease or increase the zoom ratio rapidly, press and hold down the  or  key. However the value will stop at the preset reduction or enlargement ratios. To move beyond these ratios, release the key and then press and hold it down again.

**3**

Set the number of copies using the copy quantity (, ) keys and press the print () key.

**BYPASS FEED (special paper)**

The single-sheet manual bypass can be used to feed standard paper, transparency film, labels, and other special purpose papers measuring from 3-1/2" x 5-1/2" to 8-1/2" x 14" and in the weight range of 14 to 34.5 lbs. can be used in this tray. (For paper weighing from 28 to 34.5 lbs., 8-1/2" x 11" is the maximum size.)

**1**

Place the original face down on the original table. Align it with the original scale and close the original cover.



Note

The original image must be smaller than the paper or media for copying. If the original image is bigger than the paper or media, this may cause smudges on the edges of the copies.

**2**

Set the paper guides to the copy paper width. Insert a single sheet of copy paper (print face down) into the feed slot of the manual bypass. Copying will begin automatically.



Note

- Paper must be fed narrow side into the feed slot.
- When copying onto transparency film, remove each copy promptly. Do not let copies stack up.

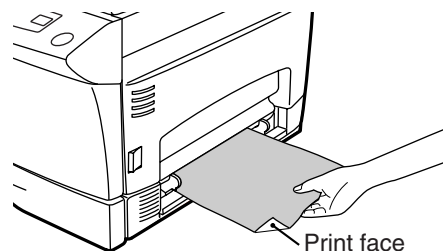
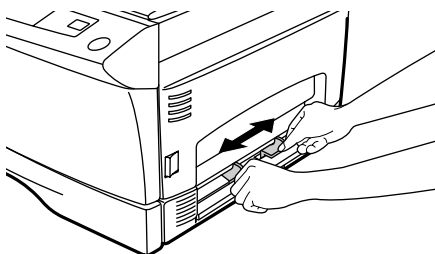
**3**

Making copies

# TWO-SIDED COPYING

Two-sided copying can be made on this copier using the manual bypass.

Example: The following two originals will be copied onto two sides of copy paper.

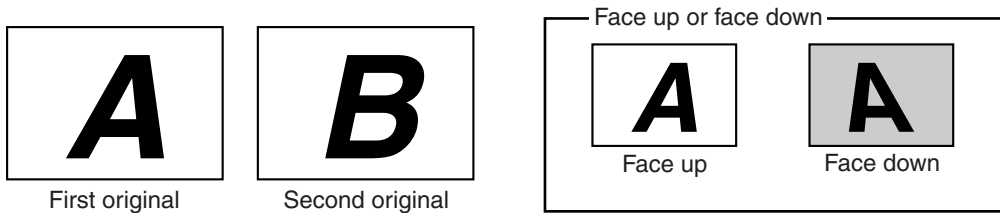

3

Making copies

- 1 Place the first original on the original table and make a copy. The first copy can be made using either the paper tray or the manual bypass.

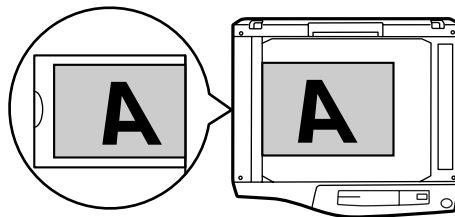

- 2 Replace the first original with the second original on the original table and close the original cover. Make sure that the first and second originals are oriented in the same way on the original table.

- 3 For tablet binding, turn the first copy over left to right as shown below. For booklet binding, turn the first copy over top to bottom (not shown). Feed the first copy into the manual bypass. Copying will begin automatically.

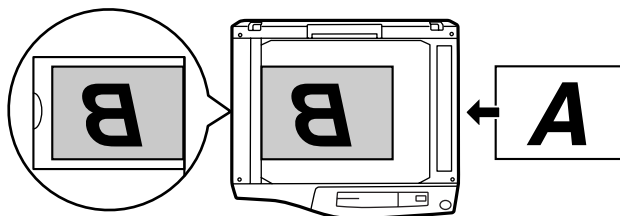



# 4

## SPECIAL FUNCTIONS

### DESCRIPTION OF SPECIAL FUNCTIONS

This chapter describes the special functions of this copier. Use these functions as needed.

#### **Toner save mode** (page 23)

Reduces toner consumption by approximately 10%.

#### **Power save modes** (page 24)

The copier has two power save modes of operation: preheat mode and auto power shut-off mode.

- **Preheat mode**

When the copier enters the preheat mode, the power save (⏻) indicator will light up and other indicators will remain on or off as before. In this condition, the fuser in the copier is maintained at a lower heat level, thereby saving power. To copy from the preheat mode, make desired copier selections and press the print (Ⓞ) key using the normal copying procedure.

- **Auto power shut-off mode**

When the copier enters the auto power shut-off mode, the power save (⏻) indicator will light up and other indicators will go out. The auto power shut-off mode saves more power than the preheat mode but requires a longer time before starting copying. To copy from the auto power shut-off mode, press the print (Ⓞ) key. Then make desired copier selections and press the print (Ⓞ) key using the normal copying procedure.

#### **Auto clear** (page 24)

The copier returns to the initial settings a preset amount of time after the last copy is made. This preset amount of time (auto clear time) can be changed.

### TONER SAVE MODE

1

Press the exposure mode selector key to select the manual (⏮⋮⏭) mode.

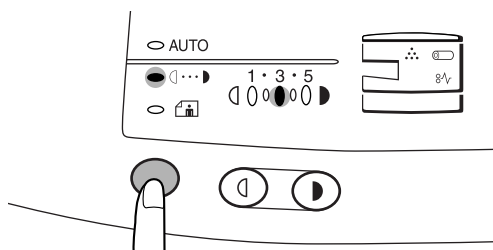

- 2 Press and hold down the exposure mode selector key for approximately 5 seconds. The manual (☐⋯☐) indicator will go out and the photo (📷) indicator will begin to blink. The exposure indicator marked “5” will light up, indicating the standard toner mode is active.

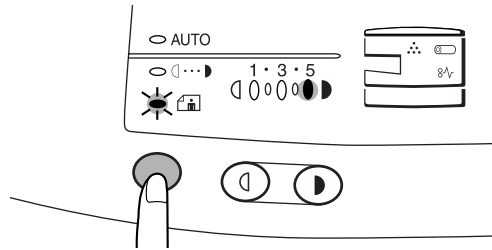

- 3 To enter the toner save mode, press the light (Ⓛ) key. The exposure indicator marked “1” will light up, indicating the toner save mode is selected.

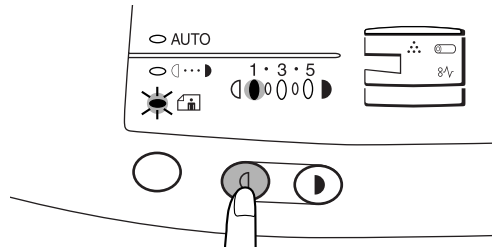

- 4 Press the exposure mode selector key twice. The photo (📷) indicator will stop blinking and the AUTO indicator will light up steadily. The toner save mode is now active.



Note



To return to the standard mode, repeat the procedure but use the dark (Ⓧ) key to select exposure level “5” in step 3.

## USER PROGRAMS (power save modes, auto clear time)

The user programs allow the parameters of certain functions to be set, changed, or canceled as desired.

### Setting the power save modes and auto clear time

- 1 Press and hold down the light (Ⓛ) and dark (Ⓧ) keys simultaneously for more than 5 seconds until all the alarm indicators (☐, Ⓜ, ⋮) blink and “— —” appears in the display.
- 2 Use the left copy quantity (Ⓛ) key to select a user program number (1: auto clear time, 2: preheat mode, 3: auto power shut-off timer, 5: auto power shut-off mode). The selected number will blink in the left side of the display.

- 3** Press the print () key. The entered program number will be steadily lit and the currently selected parameter number for the program will blink on the right side of the display.
- 4** Select the desired parameter using the right copy quantity () key. The entered parameter number will blink on the right of the display.

Program No.	Mode	Parameters					
1	Auto clear time	0 ⇨ OFF	1 ⇨ 30 sec.	* 2 ⇨ 60 sec.	3 ⇨ 90 sec.	4 ⇨ 120 sec.	5 ⇨ 10 sec.
2	Preheat mode	0 ⇨ 30 sec.	1 ⇨ 60 sec.	* 2 ⇨ 90 sec.			
3	Auto power shut-off timer	0 ⇨ 2 min.	* 1 ⇨ 5 min.	2 ⇨ 15 min.	3 ⇨ 30 min.	4 ⇨ 60 min.	5 ⇨ 120 min.
5	Auto power shut-off mode	0 ⇨ OFF	* 1 ⇨ ON				

Factory default settings are indicated with an asterisk (\*).

- 5** Press the print () key. The right-hand number in the display will be steadily lit and the entered value will be stored.



To change the setting or to set another mode, press the clear () key. The copier will return to step 2.

Note

- 6** Press the light () or dark () key to return to the normal copy mode.

# 5

## SUPPLIES AND USER MAINTENANCE

This chapter describes how to replace the TD cartridge and the drum cartridge and how to check the total number of copies.



Caution

Be sure to use only genuine SHARP parts and supplies.

### TD CARTRIDGE REPLACEMENT

The TD cartridge replacement required (∴) indicator will light up when toner is needed. For more information on purchasing the TD cartridge, see **SUPPLY PART NUMBERS AND STORAGE** on page 38. If copying is continued while the ∴ indicator is lit, copies will gradually become lighter until the copier stops and the indicator begins blinking. Replace the old TD cartridge by following the procedure given below.



Note

- After the copier stops, it may be possible to make a few more copies by taking the TD cartridge out of the copier, shaking it horizontally, then reinstalling it. If copying is not possible after this operation, replace the TD cartridge.
- During long copy run of a dark original, the ready (⊙) indicator may blink, the ∴ indicator light up, and the copier stop, even though toner is left. The copier will feed toner up to 2 minutes and then the ready (⊙) indicator will light up. Press the print (⊙) key to restart copying.

1

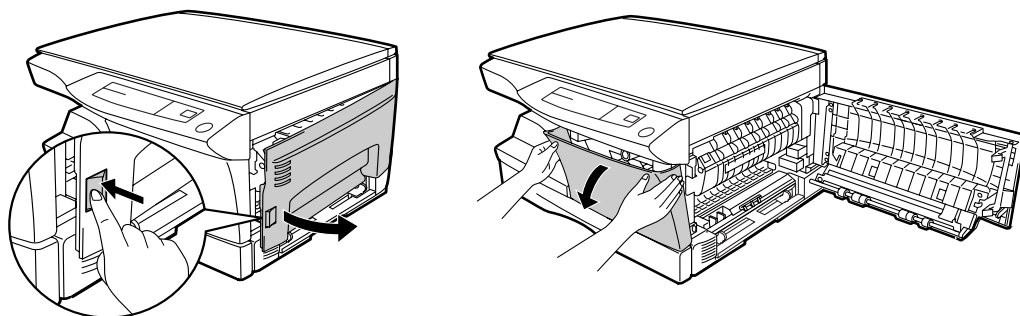

Open the side cover while pressing the side cover open button. Then, push gently on both sides of the front cover to open the cover.

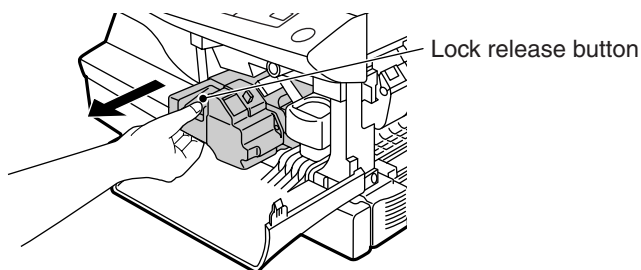

2

Gently pull the TD cartridge out while pressing the lock release button. Dispose of the old TD cartridge in accordance with local regulations.



- 3 Install a new TD cartridge. To install the new cartridge, see page 11, **INSTALLING THE TD CARTRIDGE**.
- 4 Close the front cover and then the side cover by pressing the round projections near the side cover open button. The  indicator will go out and the ready () indicator will light up.

 **Caution** When closing the covers, be sure to close the front cover securely and then close the side cover. If the covers are closed in the wrong order, the covers may be damaged.

## DRUM CARTRIDGE REPLACEMENT

The useful life of the drum cartridge is approximately 18,000 copies. When the internal counter reaches approximately 17,000 copies, the drum replacement required () indicator will light up indicating that replacement of the drum cartridge will be needed soon. For more information on purchasing the drum cartridge, see **SUPPLY PART NUMBERS AND STORAGE** on page 38. When the indicator begins to blink, the copier will stop operating until the cartridge is replaced. Replace the drum cartridge at this time.

 **Caution** Do not remove the protective cover on the drum portion (black paper) of a new drum cartridge before use. The cover protects the drum against external light.

- 1 Open the side cover while pressing the side cover open button. Then, push gently on both sides of the front cover to open the cover.

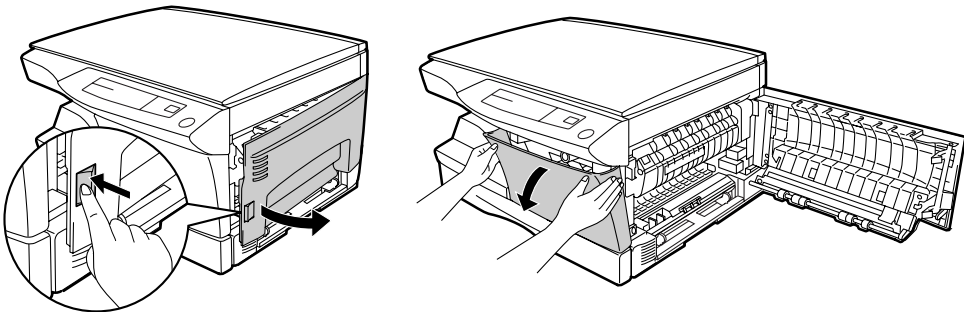

- 2 Gently pull the TD cartridge out while pressing the lock release button. To remove the TD cartridge, see page 26, step 2.
- 3 Hold the handle of the drum cartridge and gently pull the cartridge out. Dispose of the old drum cartridge in accordance with local regulations.

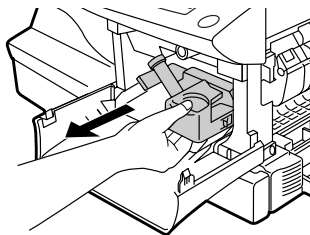

## DRUM CARTRIDGE REPLACEMENT

- 4** Remove the new drum cartridge from the protective bag and remove the protective cover from the cartridge. Then gently install the new drum cartridge.



Note

Do not touch the surface of the drum (green portion) of the cartridge. Doing so may cause smudges on the copies.

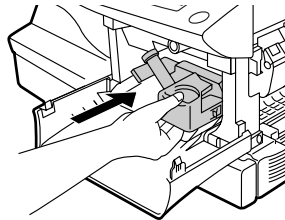
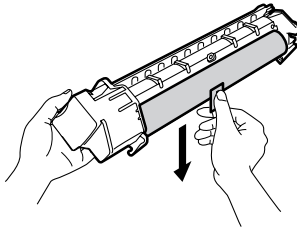

- 5** Gently install the TD cartridge. To install the TD cartridge, see page 11, **INSTALLING THE TD CARTRIDGE**.

- 6** Close the front cover and then the side cover by pressing the round projections near the side cover open button. The drum replacement required (⊖) indicator will go out and the ready (⊕) indicator will light up.



Caution

When closing the covers, be sure to close the front cover securely and then close the side cover. If the covers are closed in the wrong order, the covers may be damaged.

## USER MAINTENANCE

Proper care is essential in order to get clean, sharp copies. Be sure to take a few minutes to regularly clean the copier.



Warning

Before cleaning, be sure to turn the power switch off and remove the power cord from the outlet.



Caution

Do not use thinner, benzene or other volatile cleaning agents. Doing so may cause deformation, discoloration, deterioration or malfunction.

### Cabinet

Wipe the cabinet with a soft, clean cloth.

## Original table and original cover

Stains on the glass or cover will also be copied. Wipe the glass and the cover with a soft, clean cloth. If necessary, dampen the cloth with water or a glass cleaner.

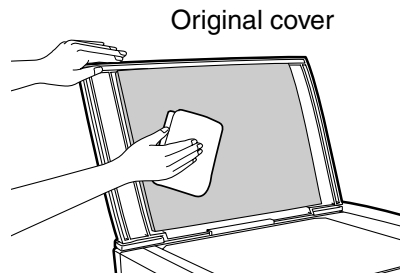
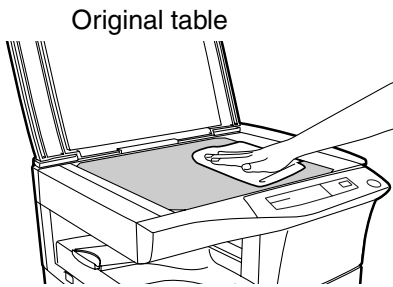

## Transfer charger

If copies start becoming streaky or blotchy, the transfer charger may be dirty. Clean the charger using the following procedure.

- 1** Turn the power switch off.
- 2** Open the side cover while pressing the side cover open button.
- 3** Take the charger cleaner out by holding the tab. Set the charger cleaner onto the right end of transfer charger, gently slide the cleaner to the left end, and then remove it. Repeat this operation two or three times.



Caution

Slide the charger cleaner from the right end to the left end along the groove of the transfer charger. If the cleaner is stopped on the way, smudges on copies may occur.

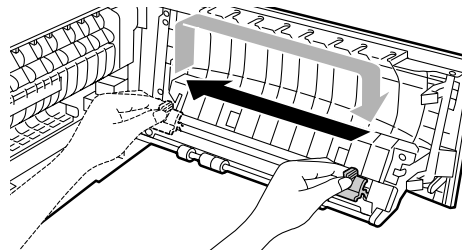
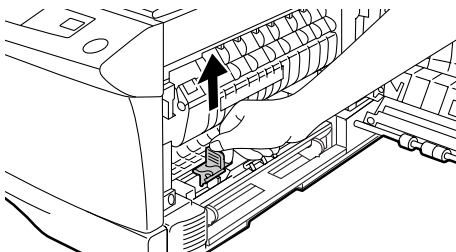

- 4 Return the charger cleaner to its original position. Close the side cover by pressing the round projections near the side cover open button.

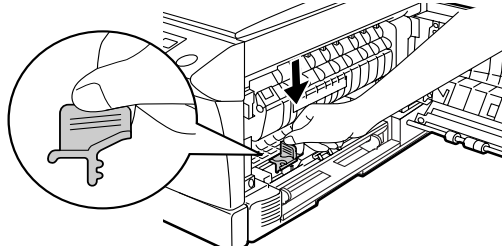

- 5 Turn the power switch on.

### When copier is not in use

To prevent entry of dust and foreign matter, store the copier as follows.

- 1 Remove the power cord and secure the copier using tape (two locations).

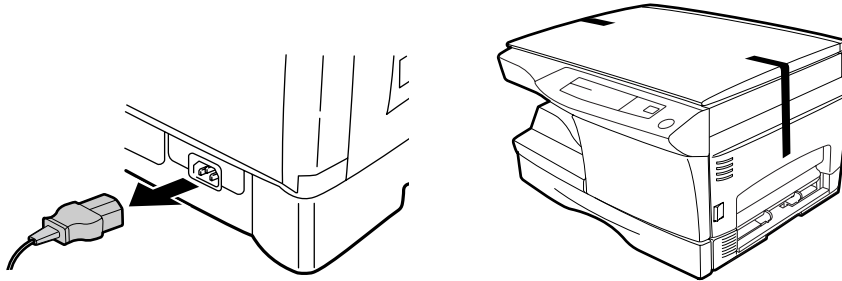



# 6

# COPIER TROUBLE?

This chapter describes misfeed removal and troubleshooting.

## MISFEED REMOVAL

When the misfeed (P) indicator blinks or  blinks in the display, the copier will stop because of a misfeed.

- 1 Open the side cover while pressing the side cover open button.

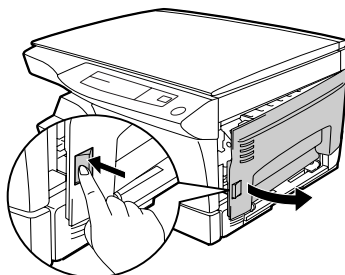

- 2 Check the misfeed location. Remove the misfed paper following the instructions for each location in the illustration below.  
If  blinks in the display, proceed to “**A Misfeed in the paper feed area**”. (p. 31)

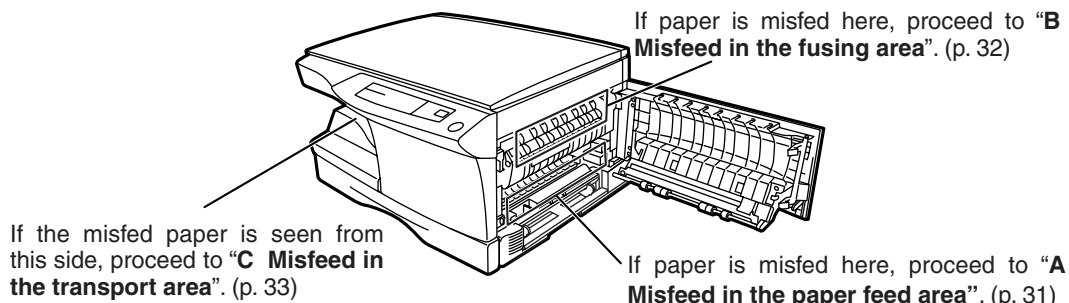

### A Misfeed in the paper feed area

- 1 Gently remove the misfed paper from the paper feed area as shown in the illustration. When  blinks in the display and the misfed paper is not seen from the paper feed area, pull out the paper tray and remove the misfed paper. If the paper cannot be removed, proceed to “**B Misfeed in the fusing area**”.



Warning

The fusing unit is hot. Do not touch the fusing unit when removing misfed paper. Doing so may cause a burn or other injury.



Caution

- Do not touch the surface of the drum (green portion) of the drum cartridge when removing the misfed paper. Doing so may damage the drum and cause smudges on copies.
- If the paper has been fed through the manual bypass, do not remove the misfed paper through the manual bypass. Toner on the paper may stain the paper transport area, resulting in smudges on copies.

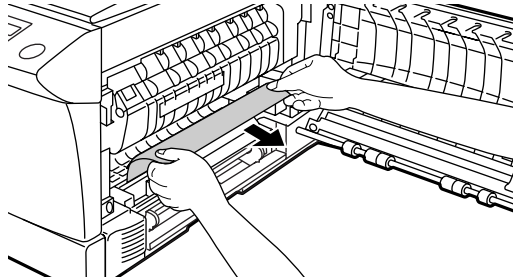

- 2 Close the side cover by pressing the round projections near the side cover open button. The misfeed (⚠) indicator will go out and the ready (Ⓞ) indicator will light up.

## B Misfeed in the fusing area

- 1 Lower the fusing unit release lever.

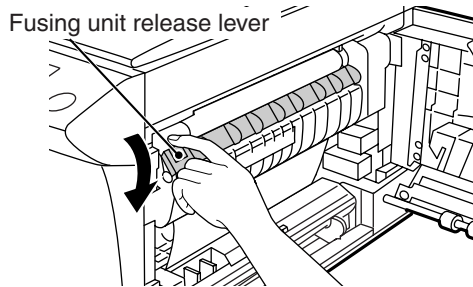

- 2 Gently remove the misfed paper from under the fusing unit as shown in the illustration. If the paper cannot be removed, proceed to “C Misfeed in the transport area”.



Warning

The fusing unit is hot. Do not touch the fusing unit when removing misfed paper. Doing so may cause a burn or other injury.



Caution

- Do not touch the surface of the drum (green portion) of the drum cartridge when removing the misfed paper. Doing so may cause smudges on copies.
- Do not remove the misfed paper from above the fusing unit. Unfixed toner on the paper may stain the paper transport area, resulting in smudges on copies.

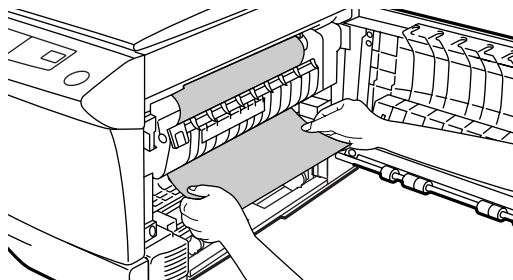

- 3** Raise the fusing unit release lever and then close the side cover by pressing the round projections near the side cover open button. The misfeed (⊗) indicator will go out and the ready (⊕) indicator will light up.

### C Misfeed in the transport area

- 1** Lower the fusing unit release lever.

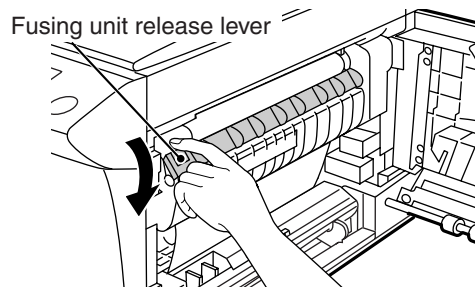

- 2** Push gently on both sides of the front cover to open the cover.

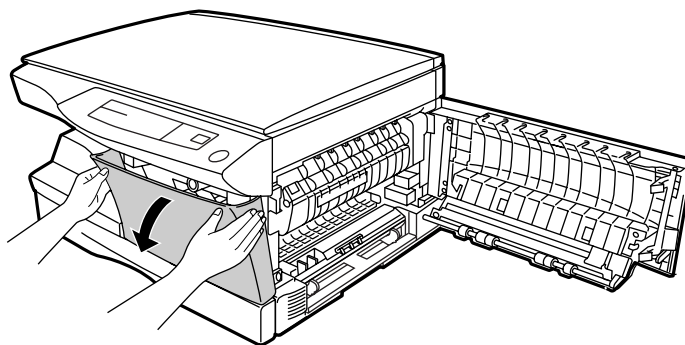

- 3** Rotate the feeding roller in the direction of the arrow and gently remove the misfed paper from the exit area.

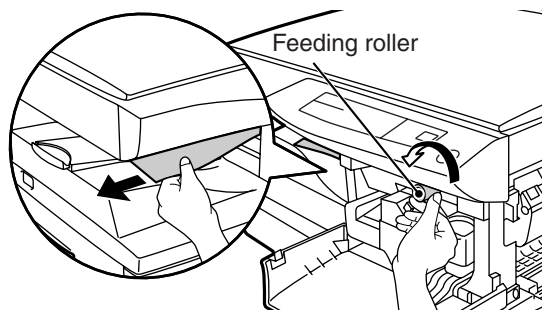

- 4** Raise the fusing unit release lever, close the front cover and then close the side cover by pressing the round projections near the side cover open button. The misfeed (⊗) indicator will go out and the ready (⊕) indicator will light up.



When closing the covers, be sure to close the front cover securely and then close the side cover. If the covers are closed in the wrong order, the covers may be damaged.

# TROUBLESHOOTING

If any problem occurs, check the list below before contacting our Technical Assistance Department.







Problem	Possible cause	Solution	See page:
Copier does not operate.	Copier plugged in?	Plug the copier into a grounded outlet.	15
	Power switch on?	Turn the power switch on.	16
	Side cover closed securely?	Gently close the side cover.	—
	Front cover closed?	Gently close the front cover and then close the side cover.	—
Blank copies	Is the original placed face down on the original table?	Place the original face down on the original table.	18
Power save (⏻) indicator on.	Is the copier in the preheat mode?	Press any key to cancel the preheat mode.	23
	Is the copier in the auto power shut-off mode?	Press the print (⏻) key to cancel the auto power shut-off mode.	23
Copies are too dark or too light.	Is original image too dark or too light?	Adjust the exposure manually.	20
	Is the copier in the automatic exposure mode?	Adjust the automatic exposure level.	36
	Is the copier in the photo exposure mode?	Cancel the photo exposure mode.	20
Dust, dirt, smudges appear on copies.	Original table or original cover dirty?	Clean regularly.	28
	Original smudged or blotchy?	Use a clean original.	—
Striped copies	Is transfer charger clean?	Clean the transfer charger.	29
Paper misfeeds frequently.	Non-standard paper used?	Use standard paper. If using special papers, feed the paper through the manual bypass.	17
	Paper curled or damp?	Store copy paper flat in the wrapper in a dry location.	—
	Pieces of paper inside copier?	Remove all pieces of misfed paper.	31
	Paper guides in the paper tray not set properly?	Set the guides properly depending on the paper size.	13
	Too much paper in the paper tray or bypass tray?	Remove excessive paper from the tray.	14
Images rub off the copy easily.	Is the copy paper too heavy?	Use copy paper within the specified range.	17
	Paper damp?	Replace with dry copy paper. If the copier is not used for long time, remove the paper from the paper tray and store it in its wrapper in a dry location.	38

# STATUS INDICATORS

When the following indicators light up or blink on the operation panel or the following alphanumeric codes appear in the display, solve the problem immediately referring to both the table below and the relevant page.



**Caution** Be sure to use only genuine SHARP parts and supplies.

Indication		Cause and remedy		See page:
	Drum replacement required indicator	Steadily lit	Replacement of drum cartridge will be needed soon. Prepare a new cartridge.	38
		Blinking	Drum cartridge must be replaced. Replace it with a new one.	27
	TD cartridge replacement required indicator	Steadily lit	Replacement of TD cartridge will be needed soon. Prepare a new cartridge.	38
		Blinking	TD cartridge must be replaced. Replace it with a new one.	26
	Misfeed indicator	Blinking	A misfeed has occurred. Remove the misfed paper referring to the description of "Misfeed removal."	31
	"CH" is blinking in the display.		The TD cartridge is not installed. Check if the cartridge is installed.	26
	"CH" is steadily lit in the display.		Side cover is open. Close the side cover securely by pressing the round projections near the side cover open button.	—
	"P" is blinking in the display.		Paper tray or bypass tray is empty. Load copy paper.	13
			A misfeed has occurred in the paper tray or bypass tray. Remove the misfed paper.	31
			Paper tray is not securely installed. Push the tray in securely.	—
	A letter and a number appear alternately.		The copier will not function. Turn the power switch off, remove the power cord from the outlet, and contact our Technical Assistance Department at 1-(630)378-3590 in the USA or 1-877-SHARP-CC (toll free)/905-568-7140 in Canada.	—

## DISPLAYING TOTAL NUMBER OF COPIES

Use the following procedure to display the total number of copies.

- 1** Press the clear (Ⓢ) key to reset the display to zero.
- 2** Press and hold down the clear (Ⓢ) key for approximately 5 seconds. The total number of copies will appear in two steps, each with three digits.  
Example: Total number of copies is 1,234.



# AUTOMATIC EXPOSURE ADJUSTMENT

The automatic exposure level can be adjusted to suit your copying needs.

1

Press the exposure mode selector key to select the photo (📷) mode.

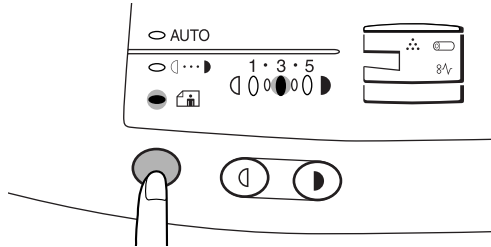

2

Press and hold down the exposure mode selector key for approximately 5 seconds. The photo (📷) indicator will go out and the AUTO indicator will begin to blink. One or two exposure indicators corresponding to the automatic exposure level which has been selected will light up.

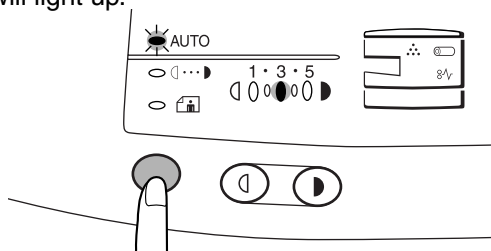

3

Press the light (☉) or dark (☾) key to lighten or darken the automatic exposure level as desired.

If exposure level 2 is selected, the two left-handmost indicators for that level will light up simultaneously. Also, if level 4 is selected, the two right-handmost indicators for that level will light up simultaneously.

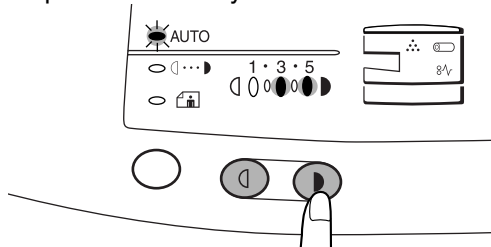

4

Press the exposure selector key. The AUTO indicator will stop blinking and light up steadily.



Note

This automatic exposure level will remain in effect until you change it again by this procedure.

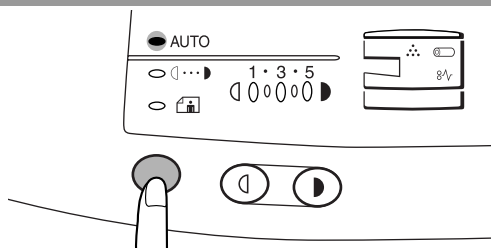

# 7

# APPENDIX

## SPECIFICATIONS

Type	Digital laser copier/printer, desk-top type
Copy system	Dry, electrostatic transfer
Originals	Sheets, bound documents
Original size	Max. 10" x 14"
Copy sizes	8-1/2" x 14" to 3-1/2" x 5-1/2" (Feed copy paper lengthwise only.) Image loss: Max. 5/32" (4 mm) (leading and trailing edges) Max. 11/64" (4.5 mm) (along the other edges in totals)
Copy speed	13 copies/min.
Continuous copying	Max. 99 copies; subtractive counter
First-copy time (Approximately)	9.6 seconds (normal copying mode)
Copy ratio	Variable: 50% to 200% in 1% increments (total 151 steps) Fixed: 50%, 64%, 78%, 100%, 129%, 200%
Exposure system	Moving optical source, slit exposure (stationary platen) with automatic exposure
Copy paper feed	One paper tray with automatic feed (250 sheets); one single-sheet manual bypass
Fusing system	Heat rollers
Development system	Magnetic brush development
Light source	Xenon lamp
Resolution	Scan: 400 dpi Output: 600 dpi
Gradation	Scan: 256 levels Output: 2 levels
Memory	6MB
Power supply	AC 120V (±10%), 60 Hz (±2%)
Power consumption	1,000 W
Overall dimensions	23.9" (W) x 17.5" (D) (607 mm (W) x 445 mm (D))
Weight	Approx. 39.7 lbs. (18 kg), TD and drum cartridges included
Copier dimensions	20.4" (W) x 17.5" (D) x 11.5" (H) (518 mm (W) x 445 mm (D) x 293 mm (H))
Operating conditions	Temperature: 50°F to 86°F (10°C to 30°C) Humidity: 20% to 85%
Noise level	Sound Power Level L <sub>WA</sub> (1B=10dB) Copying: 6.6 [B (A)], Standby: Background noise level Sound Pressure Level L <sub>PA</sub> (bystander positions) Copying: 40 [dB (A)], Standby: Background noise level Noise emission measurement in accordance with ISO 7779.

First-copy time may differ depending on operating conditions, such as power-supply voltage and room temperature.



Note

As a part of our policy of continuous improvement, SHARP reserves the right to make design and specification changes for product improvement without prior notice. The performance specification figures indicated are nominal values of production units. There may be some deviations from these values in individual units.

# SUPPLY PART NUMBERS AND STORAGE

When ordering supplies, please use the correct part numbers as listed below.



Caution

Be sure to use only genuine SHARP parts and supplies.



For best copying results, be sure to use only SHARP Genuine Supplies which are designed, engineered, and tested to maximize the life and performance of SHARP copiers. Look for the Genuine Supplies label on the toner package.

## Supply list

Supply	Part number	Usable life
TD cartridge	AL-100TD	Approx. 6,000 sheets*
	AL-110TD	Approx. 4,000 sheets
Drum cartridge	AL-100DR	Approx. 18,000 sheets

\* Based on copying onto letter-type paper at 5% toned area  
(The life of the TD cartridge which has been included in the copier at the factory is approximately 2,000 sheets.)

## Proper storage

1. Store the supplies in a location that is:
  - clean and dry,
  - at a stable temperature,
  - not exposed to direct sunlight.
2. Store copy paper in the wrapper and lying flat.
  - Paper stored out of the wrapper or in packages standing on end may curl or get damp, resulting in paper misfeeds.



# MOVING INSTRUCTIONS

When moving this copier, follow the procedure below.



Note

When moving this copier, be sure to remove the TD cartridge in advance.

1

Turn the power switch off and disconnect the power cord.

2

① Open the side cover while pressing the side cover open button. ② Push gently on both sides of the front cover to open the cover.

3

Gently pull the TD cartridge out while pressing the lock release button. See page 27, **TD CARTRIDGE REPLACEMENT**.

4

Close the front cover and then the side cover by pressing the round projections near the side cover open button.



Caution

When closing the covers, be sure to close the front cover securely and then close the side cover. If the covers are closed in the wrong order, the covers may be damaged.

5

Raise the handle of the paper tray and pull the paper tray out until it stops.

6

Push the center of the pressure plate down until it locks in place and lock the plate using the pressure plate lock which has been stored in the front of the paper tray.

7

Use a coin (or suitable object) to attach to the left side of the copier the screw that has been stored in the front of the paper tray.



Caution

When shipping the copier, the screw must be reinstalled to prevent shipping damage.

8

Push the paper tray back into the copier.

9

Close the paper output tray extension, and attach the packing materials and tape which were removed during installation of the copier. See page 11, **REMOVING PROTECTIVE PACKING MATERIALS**.

10

Pack the copier into the carton. See page 10, **CHECKING PACKED COMPONENTS AND ACCESSORIES**.

# INDEX

## A

- Auto clear . . . . . 23, 24
- Automatic exposure adjustment . . . . . 36
- Auto power shut-off mode . . . . . 23, 24

## C

- Cautions . . . . . 3
- Cautions on handling . . . . . 9
- Charger cleaner . . . . . 29
- Copier trouble? . . . . . 31
- Copying
  - large original . . . . . 19
  - normal . . . . . 18
  - reduction/enlargement . . . . . 20
  - through bypass . . . . . 21
  - two-sided . . . . . 22
- Copy paper . . . . . 17
- Copy quantity . . . . . 18
- Copy ratio . . . . . 20

## D

- Dark key . . . . . 20
- Drum cartridge
  - indicator . . . . . 7, 35
  - replacement . . . . . 27

## E

- Enlargement . . . . . 20
- Exposure adjustment . . . . . 20

## F

- Features . . . . . 4
- Fixed copy ratio . . . . . 21
- Fusing unit release lever . . . . . 6, 32

## I

- Initial settings . . . . . 16
- Installation
  - location . . . . . 8
  - TD cartridge . . . . . 11

## L

- Light key . . . . . 20
- Loading copy paper . . . . . 13

## M

- Maintenance . . . . . 28
- Manual bypass . . . . . 21
- Manual exposure . . . . . 20
- Manual feeding . . . . . 21
- Misfeed removal
  - fusing area . . . . . 32
  - paper feed area . . . . . 31
  - transport area . . . . . 33
- Moving instructions . . . . . 39

## N

- Names
  - operation panel . . . . . 7
  - part . . . . . 6

## O

- ON LINE indicator . . . . . 7
- Operation panel
  - initial settings . . . . . 16
  - part names . . . . . 7
- Original cover . . . . . 6
- Original table . . . . . 6

- P**
- Packed components . . . . . 10
  - Paper
    - loading . . . . . 13
    - special . . . . . 17
    - specifications . . . . . 17
  - Paper feed area . . . . . 31
  - Paper output tray . . . . . 6
  - Paper output tray extension . . . . . 6, 18
  - Paper size . . . . . 17
  - Paper transport area . . . . . 33
  - Paper tray . . . . . 6
  - Part names . . . . . 6
  - Photo mode . . . . . 7, 20
  - Power cord . . . . . 10, 15
  - Power on . . . . . 16
  - Power save modes . . . . . 23, 24
  - Power switch . . . . . 6, 16
  - Preheat mode . . . . . 23, 24
  - Print key . . . . . 18
  - Protective packing materials . . . . . 11
- R**
- Ready indicator . . . . . 7
  - Reduction . . . . . 20
  - Replacement
    - drum cartridge . . . . . 27
    - TD cartridge . . . . . 26
- S**
- Screw . . . . . 11, 14
  - Special paper . . . . . 17
  - Specifications
    - copier . . . . . 37
    - paper . . . . . 17
  - Status indicators . . . . . 35
  - Supply
    - life . . . . . 38
    - part number . . . . . 38
    - storage . . . . . 38
- T**
- TD cartridge
    - indicator . . . . . 7, 35
    - installation . . . . . 11
    - replacement . . . . . 26
  - Toner save mode . . . . . 23
  - Total number of copies . . . . . 35
  - Transfer charger . . . . . 6, 29
  - Troubleshooting . . . . . 34
  - Two-sided copying . . . . . 22
- U**
- User maintenance
    - cabinet . . . . . 28
    - original cover . . . . . 29
    - original table . . . . . 29
    - transfer charger . . . . . 29
- Z**
- Zoom . . . . . 20

# MEMO

## For users in the USA

This device complies with Part 15 of the FCC rules. Operation is subject to the following two conditions: (1) This device may not cause harmful interference, and (2) this device must accept any interference received, including interference that may cause undesired operation.

### **WARNING:**

FCC Regulations state that any unauthorized changes or modifications to this equipment not expressly approved by the manufacturer could void the user's authority to operate this equipment.

### Note:

This equipment has been tested and found to comply with the limits for a Class B digital device, pursuant to Part 15 of the FCC Rules. These limits are designed to provide reasonable protection against harmful interference in a residential installation. This equipment generates, uses and can radiate radio frequency energy and, if not installed and used in accordance with the instructions, may cause harmful interference to radio communications.

However, there is no guarantee that interference will not occur in a particular installation. If this equipment does cause harmful interference to radio or television reception, which can be determined by turning the equipment off and on, the user is encouraged to try to correct the interference by one or more of the following measures:

- Reorient or relocate the receiving antenna.
- Increase the separation between the equipment and receiver.
- Connect the equipment into an outlet on a circuit different from that to which the receiver is connected.
- Consult the dealer or an experienced radio/TV technician for help.

Shielded cables must be used with this equipment to maintain compliance with FCC regulations.

**SHARP®**

**SHARP ELECTRONICS CORPORATION**

Sharp Plaza, Mahwah, New Jersey 07430-2135.

[www.sharp-usa.com](http://www.sharp-usa.com)

**SHARP ELECTRONICS OF CANADA LTD.**

335 Britannia Road East, Mississauga, Ontario, L4Z 1W9

**SHARP CORPORATION**

PRINTED IN CHINA  
2001J KS①  
TINSE0675QSZZ

## Free Manuals Download Website

<http://myh66.com>

<http://usermanuals.us>

<http://www.somanuals.com>

<http://www.4manuals.cc>

<http://www.manual-lib.com>

<http://www.404manual.com>

<http://www.luxmanual.com>

<http://aubethermostatmanual.com>

Golf course search by state

<http://golfingnear.com>

Email search by domain

<http://emailbydomain.com>

Auto manuals search

<http://auto.somanuals.com>

TV manuals search

<http://tv.somanuals.com>