

SHARP®

MODELS

INDOOR UNIT

AY-A184J

AY-A244J

OUTDOOR UNIT

AE-A184J

AE-A244J

SPLIT TYPE ROOM AIR CONDITIONER OPERATION MANUAL

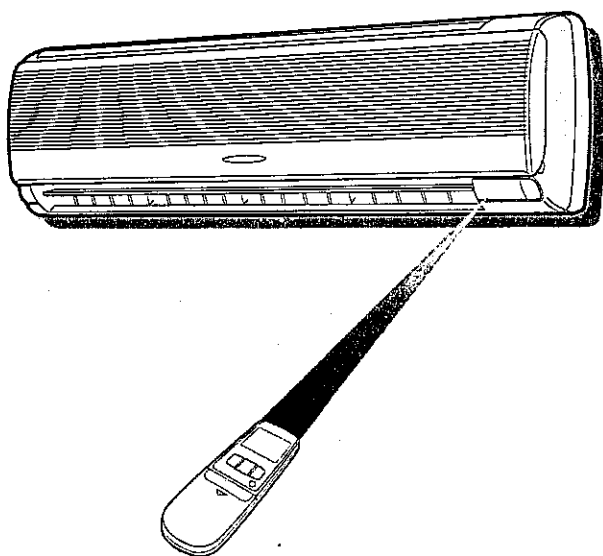

Thank you for purchasing a Sharp Split Type Room Air Conditioner. Please read this manual carefully before operating the air conditioner, and keep this manual and the Installation Manual as handy references.

• MAIN FEATURES	2
• PRECAUTIONS FOR USE	3
• TIPS ON SAVING ENERGY	3
• PART NAMES	4
• USING THE REMOTE CONTROL	8
• BASIC OPERATION	
AUTO MODE	10
HEAT MODE	12
COOL MODE	13
DRY MODE	14
FAN ONLY MODE	15
• ADJUSTING THE AIR FLOW DIRECTION	16
• SAVE MODE	17
• TIMER OPERATION	
TIMER ON	18
TIMER OFF	19
• ONE-HOUR TIMER	21
• USING THE AUXILIARY MODE	22
• USING TEST RUN MODE	22
• IMPORTANT OPERATIONAL POINTS	23
• MAINTENANCE	24
• ADDITIONAL NOTES ON OPERATION	26
• BEFORE CALLING FOR SERVICE	27
• SPECIFICATIONS	28

MAIN FEATURES

AUTOMATIC OPERATION

(When the mode is set to AUTO.)

When using the AUTO mode, the temperature setting and mode (HEAT, COOL or DRY) are automatically selected based on the room temperature when the unit is turned on.

AUTO SLEEP FUNCTION (TIMER OFF)

When this feature is selected, the air conditioner will automatically vary the room temperature while you sleep to prevent you from becoming too hot or too cold.

WAKE UP FUNCTION (TIMER ON)

When this feature is selected, the unit will automatically turn on up to 30 mins before the pre-programmed time so that the room temperature reaches the desired level by the time you wake up.

ONE-HOUR TIMER

At the press of one button, the unit can be programmed to turn off after one hour.

WARNING:

For your safety ensure that your new air conditioner is installed by a licenced electrical contractor in accordance with the SAA WIRING RULES.

CAUTION:

To ensure that your warranty is not cancelled, both the indoor/outdoor units and supply/interconnecting cables must be installed with the application of GOOD WORKMANSHIP.

PRECAUTIONS FOR USE

USE A 230-240 VOLT POWER CIRCUIT ONLY.

Using a power circuit with improper voltage and frequency can result in damage to the unit and possibly fire. Use a circuit with a 230-240 volt ($\pm 10\%$) rating.

VENTILATE THE ROOM OCCASIONALLY DURING USE.

Open the window or door periodically to ventilate the room, especially when using gas appliances.

DO NOT INSERT OBJECTS INTO THE INLET OR OUTLET.

Inserting objects into the unit could result in injury due to rotation of the high-speed fans.

DO NOT PULL, HANG ON, OR OTHERWISE MISUSE THE POWER CORD.

Pulling the power cord may result in damage or electrical shock. Do not misuse the power cord.

WHEN USING THE AIR CONDITIONER FOR INFANTS, CHILDREN, OR ELDERLY, BEDRIDDEN, OR DISABLED PEOPLE

Make sure the room temperature is suitable for those in the room.

ALWAYS USE A FUSE WITH THE CORRECT CURRENT RATING.



This unit is designed for human comfort. Do not use for applications such as a kennel or nursery to raise animals or plants.

TIPS ON SAVING ENERGY

Below are some simple ways to save energy when you use your air conditioner.

SET THE CORRECT TEMPERATURE

- Setting the thermostat 1°C higher in COOL mode, and 2°C lower in HEAT mode than the desired temperature will result in a 10% saving in electricity.
- Setting the temperature colder than necessary during cooling will result in excess power consumption.
- Make an effective use of the SAVE MODE. (Refer to page 17)

KEEP OUT DIRECT SUNLIGHT AND DRAFTS

- Keeping out direct sunlight when cooling will aid in reducing the power consumption.
- Close the windows and doors when heating and cooling the room.

SET PROPER AIR FLOW DIRECTION

- Set the louvres to obtain the best air circulation.

KEEP FILTER CLEAN

- Keep the filter clean to ensure the most efficient operation.

MAKE MOST OF TIMER

- Make the most of the AUTO SLEEP (TIMER OFF) function.

UNPLUG THE POWER CORD WHEN THE UNIT IS NOT TO BE USED FOR AN EXTENDED PERIOD

- Unplug the power cord when the unit is not to be used for a long period of time. The indoor unit still consumes a small amount of power when it is not operating.

PART NAMES

INDOOR UNIT

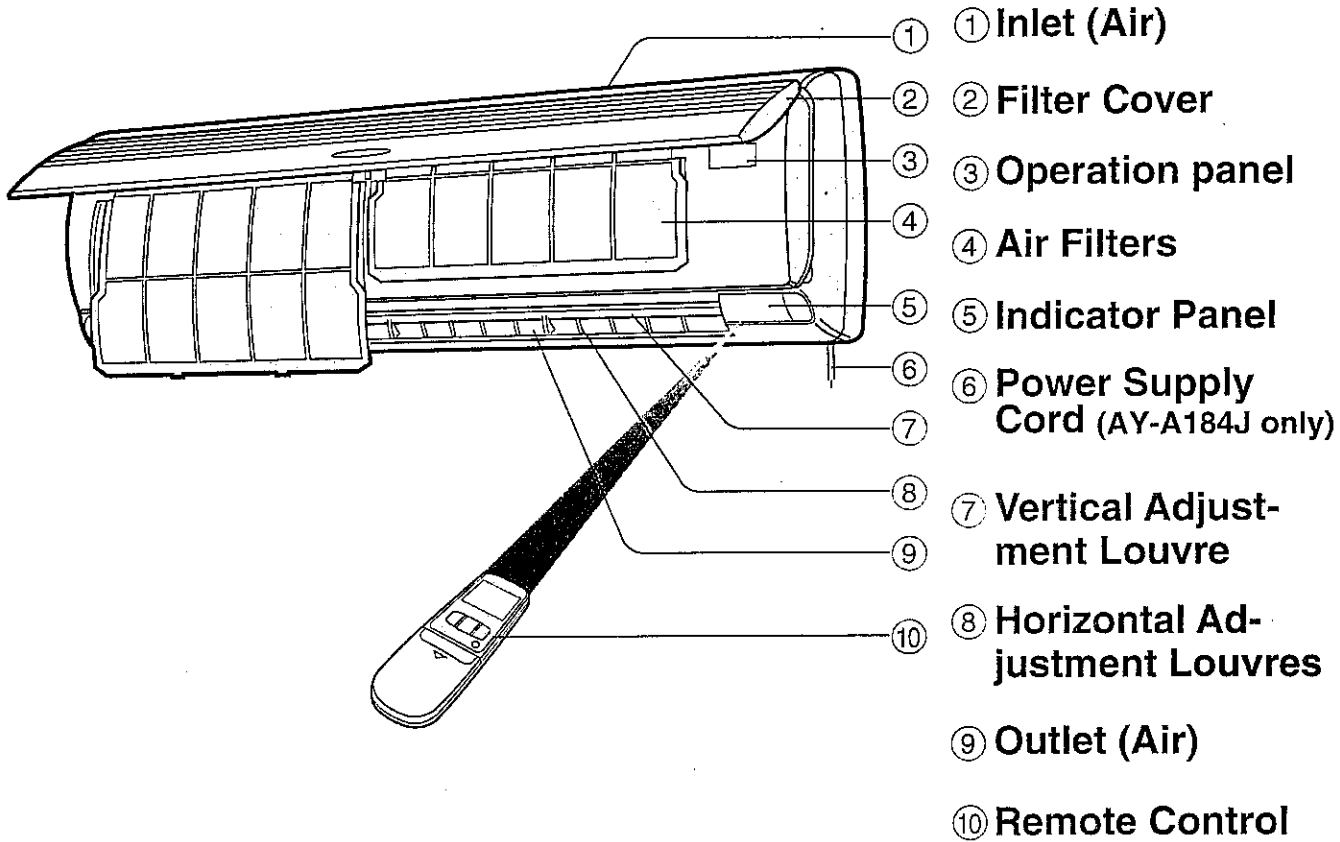

OUTDOOR UNIT

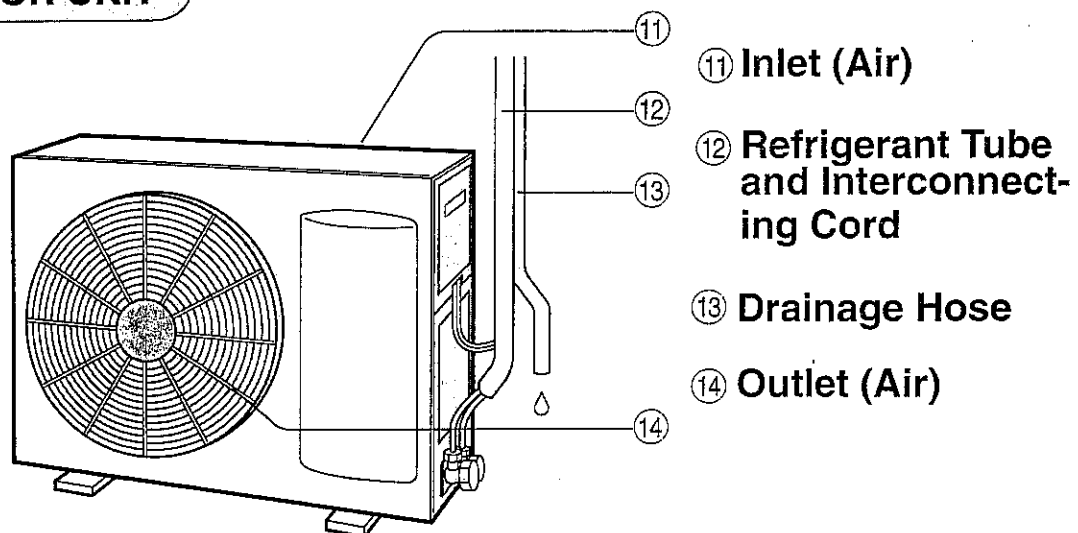

NOTE: Actual units may vary slightly from those shown above.



OPERATION AND INDICATOR PANELS

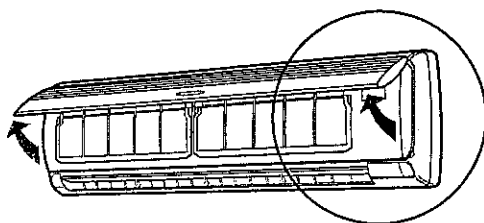

Hold the bottom corner of the filter cover on both sides and gently pull outwards.

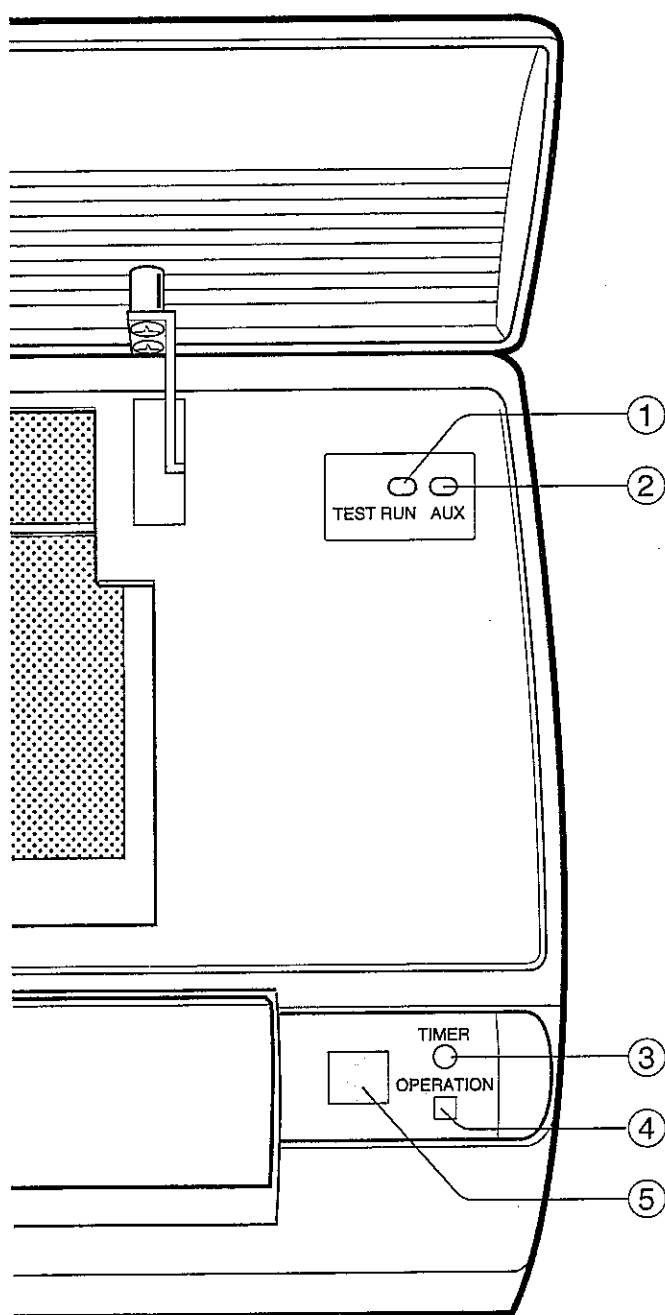

- ① **TEST RUN Button**
Used only for checking the operation of the unit. Do not use this feature during normal operation. (See p. 22)
- ② **AUX. Button**
Used to operate the unit when the remote control is not available. (See p. 22)
- ③ **TIMER Lamp (yellow)**
Lights up when the timer is set.
- ④ **OPERATION Lamp (red)**
Lights up while the unit is operating.
- ⑤ **RECEIVER Window**
Receives the signal from the remote control.

PART NAMES (Continued)

REMOTE CONTROL

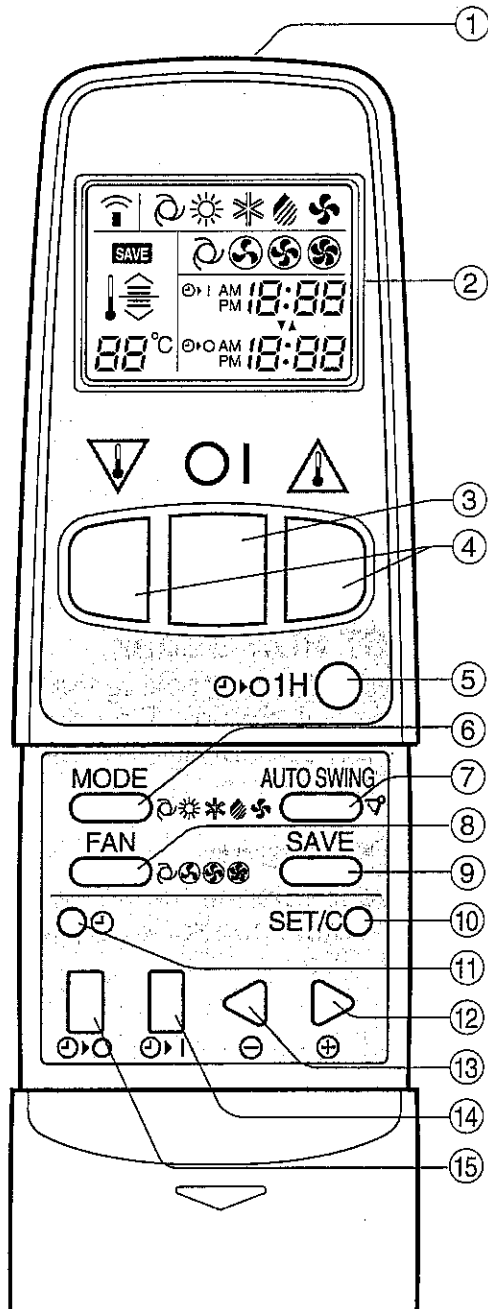

- ① **TRANSMITTER**
Sends the control signal to the unit.
- ② **DISPLAY (Liquid Crystal Display)**
Indicates the operation modes, set temperature, fan speed and time. (See p. 7)
- ③ **ON/OFF Button**
Press to start or stop the unit.
- ④ **THERMO. (Thermostat) Button**
Used to select the desired room temperature.
- ⑤ **ONE-HOUR TIMER Button**
Used to operate the unit for just one hour or to turn the unit off after one hour.
- ⑥ **MODE Button**
Used to select the desired mode: AUTO, HEAT, COOL, DRY, or FAN ONLY.
- ⑦ **AUTO-SWING Button**
Press once to make the vertical adjustment louvre move up and down continuously. Press the button again to make the louvre stop.
- ⑧ **FAN Button**
Used to select the fan speed mode: AUTO, HIGH, LOW, or SOFT.
- ⑨ **SAVE OPERATION Button**
Press to select the SAVE MODE and press it again to cancel.
- ⑩ **TIMER SET/CANCEL Button**
Used to set or cancel the timer operation mode.
- ⑪ **CLOCK Button**
Used to set the current clock time.
- ⑫ **TIME ADVANCE Button**
Used to set the timer, or the clock. Press to advance time.
- ⑬ **TIME REVERSE Button**
Used to set the timer, or the clock. Press to reverse time.
- ⑭ **TIMER ON Button (for setting the timer)**
Used to set the time for the unit to switch on. (1–24 hours)
- ⑮ **TIMER OFF Button (for setting the timer)**
Used to set the time for the unit to switch off. (1–24 hours)

L.C.D. REMOTE CONTROL DISPLAY

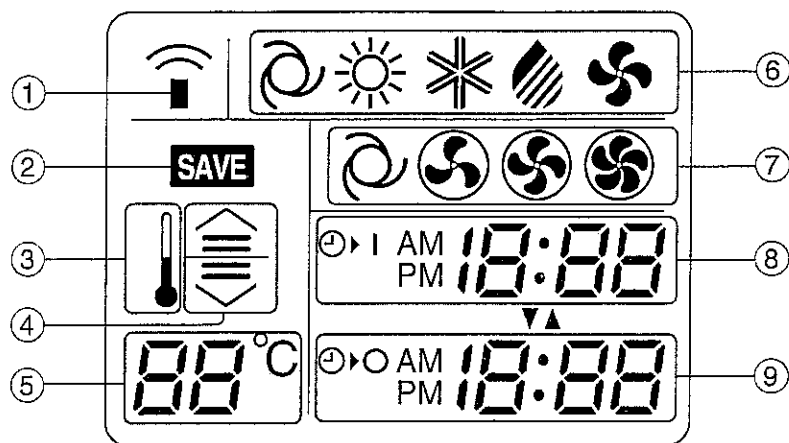

① TRANSMITTING SYMBOL

Appears when a control signal is being transmitted by the remote control.

② SAVE OPERATION MODE SYMBOL

Indicates that the unit is in the save (energy-saving) mode.

③ TEMPERATURE SYMBOL

Appears in the AUTO, COOL, HEAT and DRY modes.

④ THERMOSTAT SETTING IN AUTO MODE

When the thermostat setting is changed in the AUTO mode and DRY mode, a bar appears above or below the base line.

⑤ TEMPERATURE INDICATOR

Temperature is displayed in the HEAT and COOL modes.

⑥ MODE SYMBOL

Indicates the set mode.

☉ : AUTO

The operation mode is selected based on the room temperature when the unit is turned on. (See p. 11)

☀ : HEAT

❄ : COOL

☂ : DRY

☪ : FAN ONLY

⑦ FAN SPEED SYMBOL

Indicates the fan speed setting.

☉ : AUTO

The fan slows down automatically when the room temperature gets close to the set temperature.

☪ : SOFT

☪ : LOW

☪ : HIGH

⑧ TIMER ON INDICATOR/CLOCK

Indicates the timer-on time or current time.

⑨ TIMER OFF INDICATOR

Indicates the timer-off time or one hour timer setting.

USING THE REMOTE CONTROL

LOADING BATTERIES

Use two high-quality size-AAA (R03) batteries.

- 1 Open the remote control cover by sliding it in the direction of the arrow. Remove the cover by pressing the mark "  " and carefully pulling it in the direction of the arrow.
- 2 Insert the batteries in the compartment, making sure the \oplus and \ominus polarities are properly aligned.
 - The remote control automatically resets when the batteries are loaded.
 - AM 6:00 will appear on the display when the batteries are properly loaded.
- 3 Replace the cover.

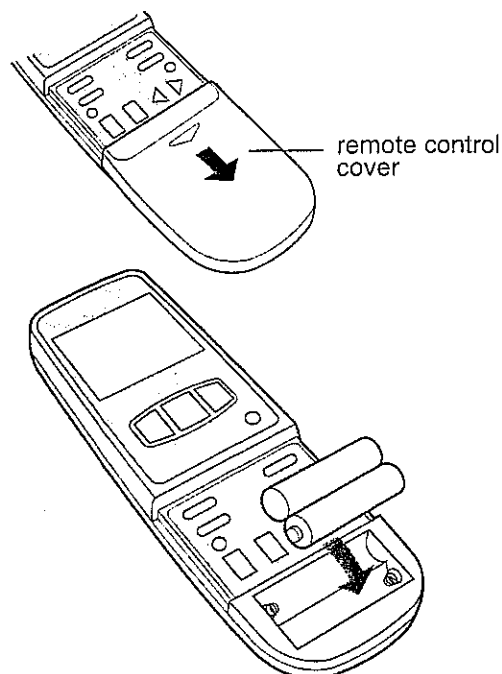

NOTES:

- The battery life is approximately one year with normal use.
- When you replace the batteries, always use two new ones of the same type.
- When the batteries are replaced, AM 6:00 will appear on the display.
- If the remote control does not operate normally after replacing the batteries, take off the batteries and replace them again after 20 seconds.

HOW TO USE THE REMOTE CONTROL

Point the remote control towards the unit's receiver window and press the desired button. A beep will sound when the unit receives the signal.

- Make sure no objects, such as a curtain, are between the remote control and the unit.
- The remote control operates from up to 7 meters away.

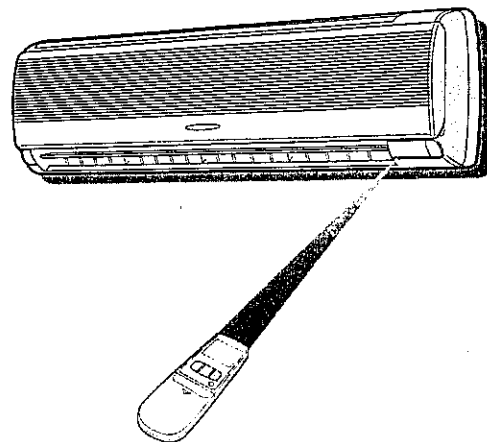



CAUTION

- Do not expose the receiver to strong, direct sunlight, which can adversely affect its operation. In such case, close the curtains to block the sunlight.
- Use of a fluorescent lamp with a quick starter in the same room may interfere with transmission of the signal.
- The unit may be affected by signals emitted from the remote control of a television, VCR or other equipment used in the same room.
- Do not leave the remote control in direct sunlight or near a heater. Also, protect the unit and remote control from moisture and shock which can discolour or damage them.
- If you will not be using the unit for a long time, remove the batteries from the remote control.

SET CURRENT CLOCK TIME

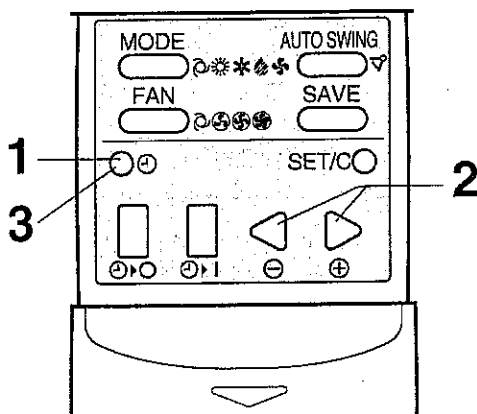

1 Press the CLOCK button.

2 Press the TIME ADVANCE or REVERSE buttons to set the current clock time. Keep pressing each button to fast-forward or reverse the time display. Make sure "a.m." or "p.m." is set correct.

3 Press the CLOCK button.

- The colon (:) blinks to indicate that the clock is functioning.

Example:

If the current time is 7 o'clock in the afternoon.

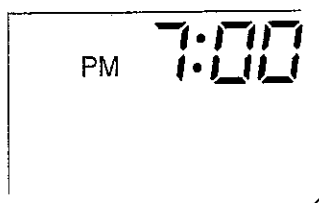

NOTES:

- The current time cannot be set, when the timer mode is programmed.
- At midday/midnight the clock will display 0:00.AM/PM similar to a 24 hour clock.

BASIC OPERATION

AUTOMATIC OPERATION MODE

In this mode, the temperature setting and mode (HEAT, COOL or DRY) are automatically selected depending on the room temperature when the unit is turned on.

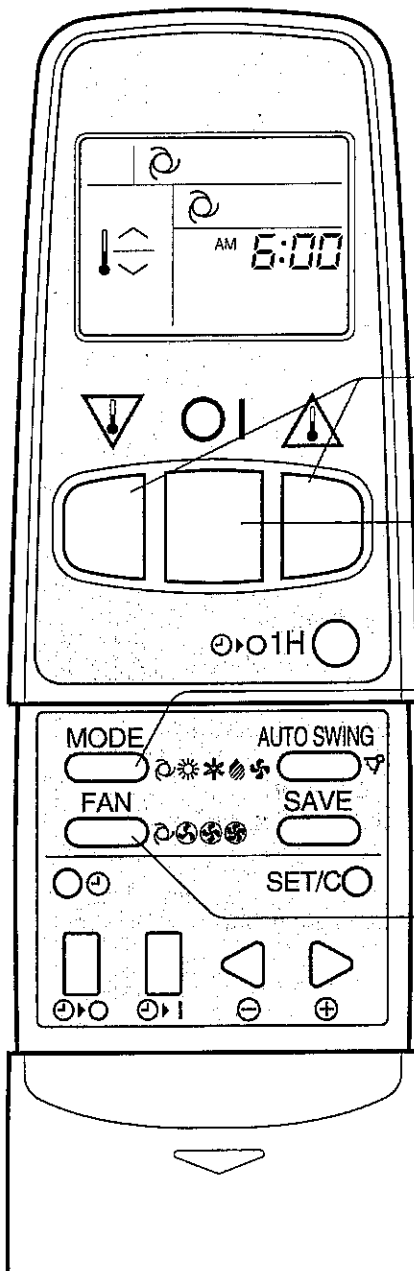

1 Press the MODE button to select the AUTO mode. (🌀)

2 Press the ON/OFF button to start operation.
 • The red OPERATION lamp of the unit will light up.

3 Press the FAN button to set the desired fan speed.

4 Adjust the thermostat setting, if desired, by pressing the THERMO buttons.
 The indicator bars represent changes in temperature as follows:

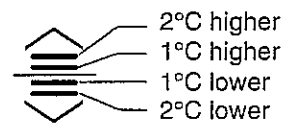

The AIR SWING mode can be selected, or AIR FLOW direction adjusted by pressing the "AUTO SWING" button. (See p. 16 for detail)

5 To turn off the unit, press the ON/OFF button again.
 • The red OPERATION lamp of the unit will go out.

NOTES:

- The temperature indicator does not appear on the display in the AUTO mode.
- In the DRY mode, the fan speed cannot be changed.



HOW THE AUTOMATIC OPERATION MODE WORKS

In AUTO MODE, the HEAT, COOL, or DRY mode is selected based on the room temperature when the unit is turned on.

Room temp. when the unit turned on	Automatic Operation	
	Mode Selected	Thermostat Setting
Below 21°C	HEAT	23°C
21°–24°C	DRY	Room Temp. at start-up
24°–26°C	COOL	24°C
26°–28°C	COOL	25°C
Above 28°C	COOL	26°C

BASIC OPERATION (Continued)

HEAT MODE

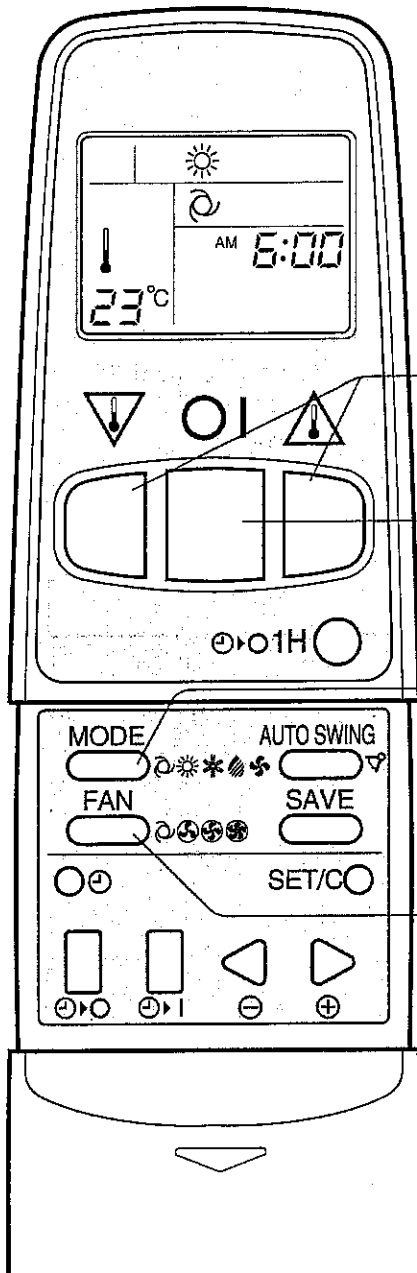

- 1 Press the MODE button to select the HEAT mode. (☀)
- 2 Press the ON/OFF button to start operation.
 - The red OPERATION lamp of the unit will light up.
- 3 Press the THERMO button to set the desired temperature.
 - The recommended temperature range is from 20 to 23°C.
- 4 Press the FAN button to set the desired fan speed.

The AIR SWING mode can be selected, or AIR FLOW direction adjusted by pressing the "AUTO SWING" button. (See p. 16 for detail)
- 5 To turn off the unit, press the ON/OFF button again.
 - The red OPERATION lamp of the unit will go out.

NOTES:

- The indoor fan will not rotate until the unit has pre-heated.



COOL MODE

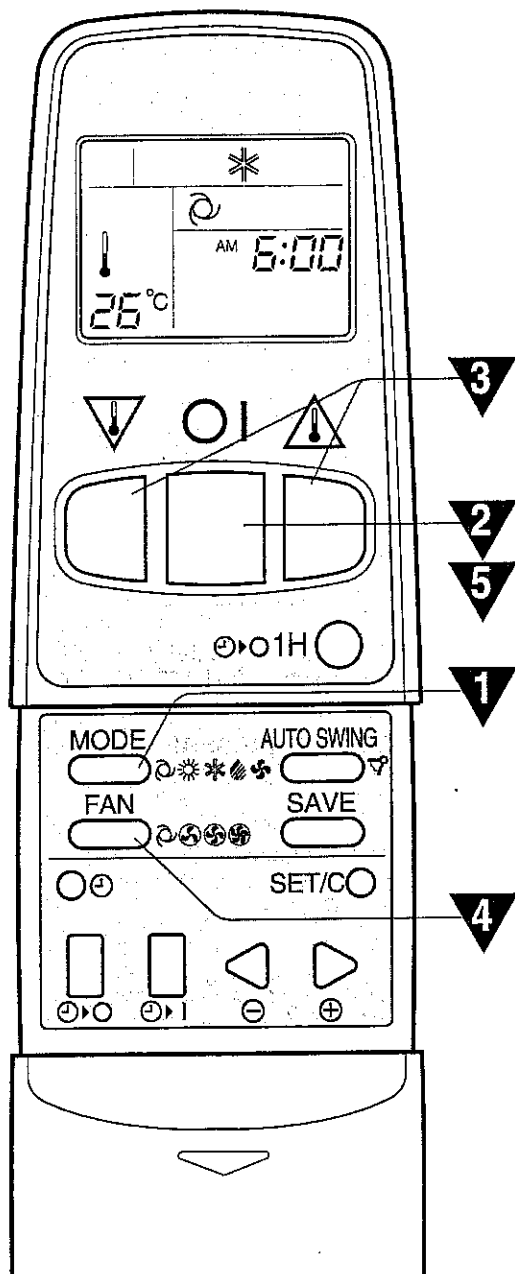

1 Press the MODE button to select the COOL mode. (✱)

2 Press the ON/OFF button to start operation.
• The red OPERATION lamp of the unit will light up.

3 Press the THERMO button to set the desired temperature.
• The recommended temperature range is from 26 to 28°C. If the temperature is set below 21°C in the COOL mode, a protective mechanism may interrupt operation.

4 Press the FAN button to set the desired fan speed.

The AIR SWING mode can be selected, or AIR FLOW direction adjusted by pressing the "AUTO SWING" button. (See p. 16 for detail)

5 To turn off the unit, press the ON/OFF button again.
• The red OPERATION lamp of the unit will go out.

BASIC OPERATION (Continued)

DRY MODE

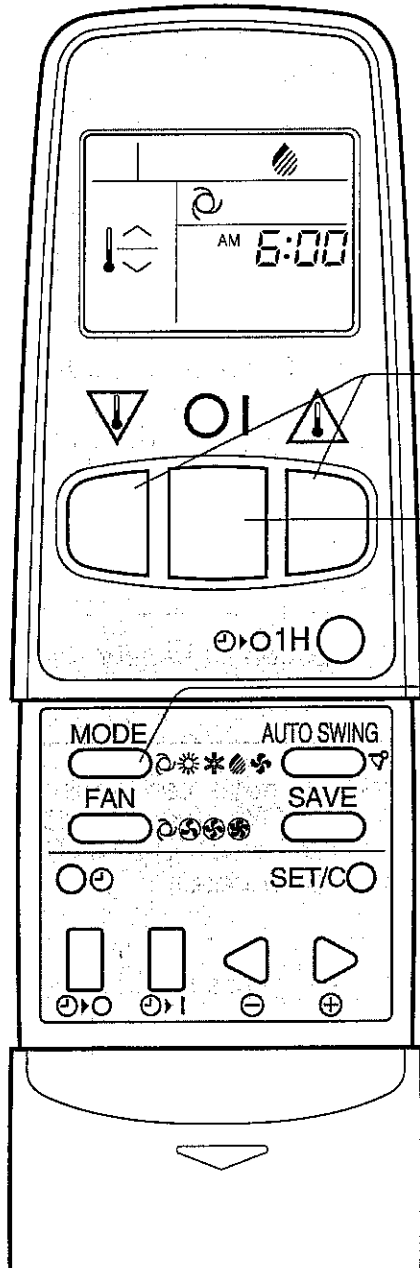

In the DRY mode, the air conditioner reduces the humidity in the room without lowering the room temperature.

1

Press the MODE button to select the DRY mode. ()

- The fan speed and temperature settings are set automatically.

2

Press the ON/OFF button to start operation.

- The red OPERATION lamp of the unit will light up.

3

Adjust the thermostat setting, if desired, by pressing the THERMO buttons.

The indicator bars represent changes in temperature as follows.

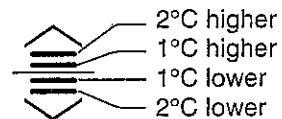

The AIR SWING mode can be selected, or AIR FLOW direction adjusted by pressing the "AUTO SWING" button. (See p. 16 for detail)

4

To turn off the unit, press the ON/OFF button again.

- The red OPERATION lamp of the unit will go out.

NOTES:

Since operation is automatically controlled in the DRY mode, you cannot change the fan speed setting.

FAN ONLY MODE

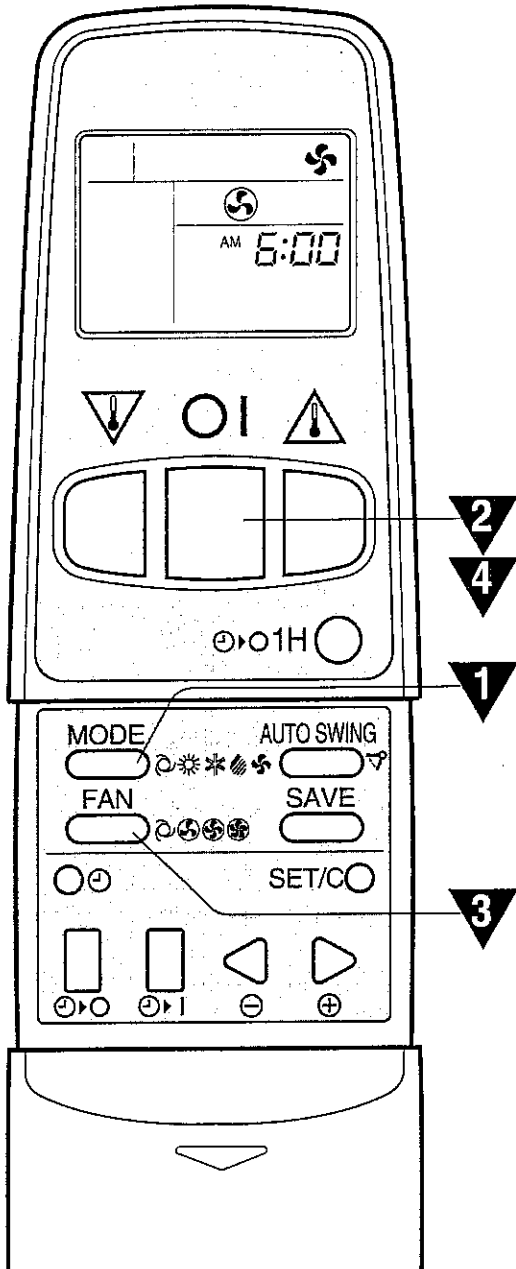

1 Press the MODE button to select the FAN ONLY mode. ()

2 Press the ON/OFF button to start operation.
 • The red OPERATION lamp of the unit will light up.

3 Press the FAN button to set the desired fan speed.
 • Fan speed AUTO () cannot be set.

The AIR SWING mode can be selected, or AIR FLOW direction adjusted by pressing the "AUTO SWING" button. (See p. 16 for detail)

4 To turn off the unit, press the ON/OFF button again.
 • The red OPERATION lamp of the unit will go out.

ADJUSTING THE AIR FLOW DIRECTION

VERTICAL AIR FLOW

The direction of the air flow is automatically preset for the optimum effect in each mode as follows;

COOL and DRY mode	Horizontal air flow
HEAT and FAN ONLY mode	Diagonal air flow (45°)

The air flow direction can be changed as desired.

AIR SWING MODE

Press the AUTO SWING button once. The vertical adjustment louvre will swing continuously within the range shown.

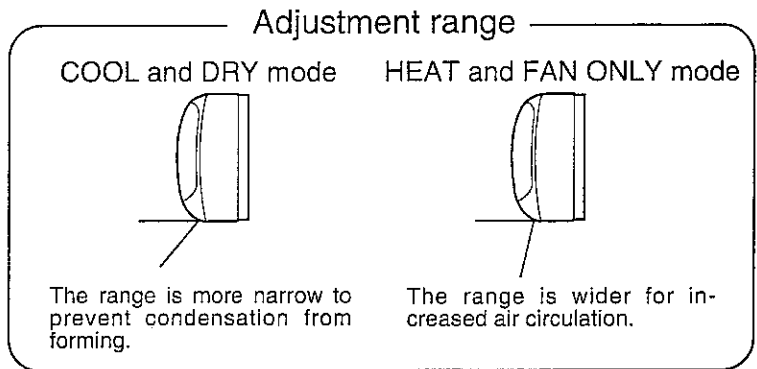

HOW TO ADJUST THE AIR FLOW DIRECTION

Press the AUTO SWING button once. The vertical adjustment louvre will move up and down. Press the AUTO SWING button again when the desired position is reached and the louvre will stop.

HORIZONTAL AIR FLOW

Hold the horizontal adjustment louvre levers as shown and adjust the air flow direction. There are four louvre levers.

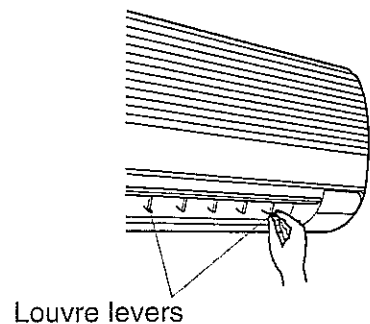

! CAUTION

Never attempt to adjust the vertical adjustment louvre manually.

- Manual adjustment of this louvre can cause the unit to malfunction when remote-controlled later.
- When the COOL or DRY modes are used for an extended period of time with the vertical adjustment louvre manually adjusted so that the air flows downward, condensation may form.

SAVE MODE

Designed for greater energy efficiency, use of this mode reduces power consumption and offers energy savings by up to 10% compared with the normal operation.

1 To activate the SAVE mode, press the SAVE button during operation.

- SAVE is displayed on the remote control.
- The temperature display disappears.

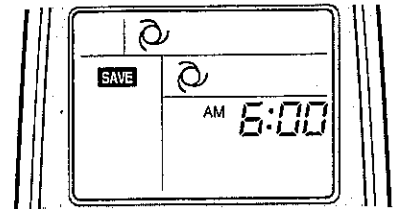

2 To cancel the save mode, press the SAVE button again.

*The SAVE display disappears and the unit returns to the former mode.

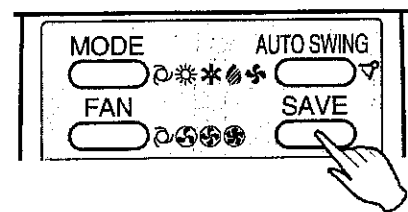

ADVANTAGE OF USING SAVE MODE

The save mode reduces power consumption by approximately 10% compared with the normal operation.

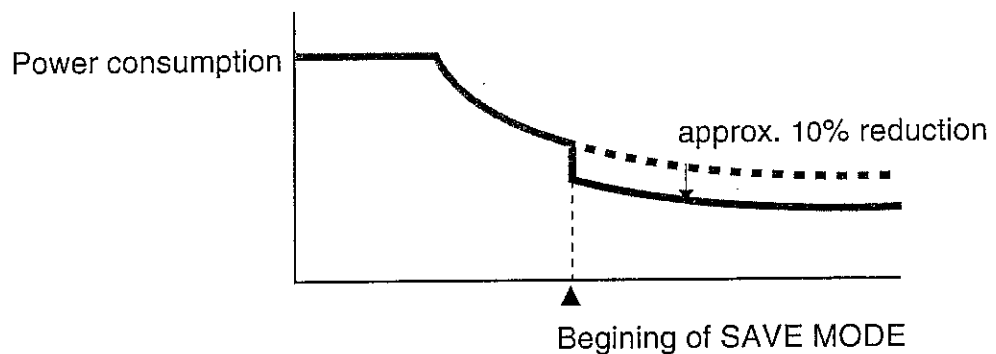

NOTES:

- You cannot use the SAVE mode during the DRY and FAN ONLY mode.
- You cannot set the temperature during the SAVE operation.

TIMER OPERATION

NOTE:

Before setting the timer, check to see if the current clock time is properly set.

"WAKE UP" FUNCTION (TIMER ON MODE)

Use the "WAKE UP" function to turn the unit on at a programmed time.

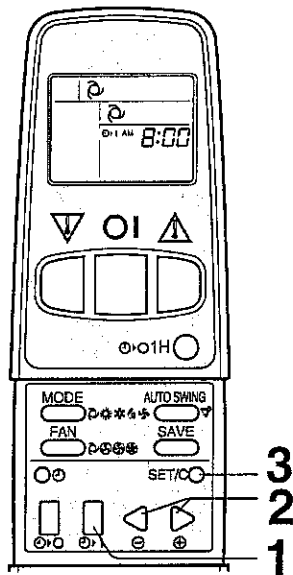

- 1 Press the TIMER ON () button.
- 2 The TIMER ON indicator will blink; press the TIME ADVANCE or REVERSE buttons to set the desired time. (The time can be set by 10 minutes.)
- 3 Point the remote control at the receiver window of the unit and press the TIMER SET (SET/C) button.
- 4 Select the operation you wish to program.
 Operation mode setting → MODE BUTTON
 Fan speed setting → FAN BUTTON
 Temperature setting (The temperature is set automatically in AUTO MODE.) → THERMO BUTTON
 - The yellow TIMER lamp on the unit lights up.
 - An audible sound indicates that the unit has received the signal.
 - The unit will turn on prior to the time set to allow the room to reach the desired temperature by the programmed time.

TO CANCEL TIMER MODE

Press the TIMER CANCEL button "SET/C". The yellow TIMER lamp of the unit will go out. The current clock time will be displayed on the remote control.

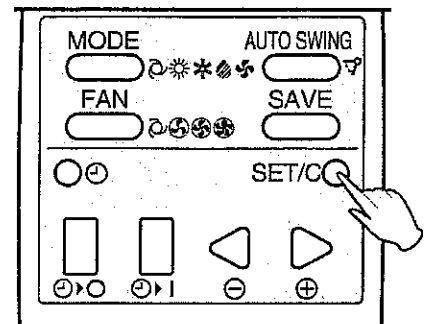

TO CHANGE TIME SETTING

First, cancel the TIMER, and then set it again.

TO CHANGE FAN SPEED, MODE, AND/OR THERMOSTAT SETTING AFTER SETTING TIMER

Press each button to change the settings as desired.

“AUTO SLEEP” FUNCTION (TIMER OFF MODE)

Use the "AUTO SLEEP" function to turn the unit off at a programmed time. During this mode, the room temperature is automatically adjusted slightly to prevent the room from becoming too hot or too cold while you sleep. (See explanation below)

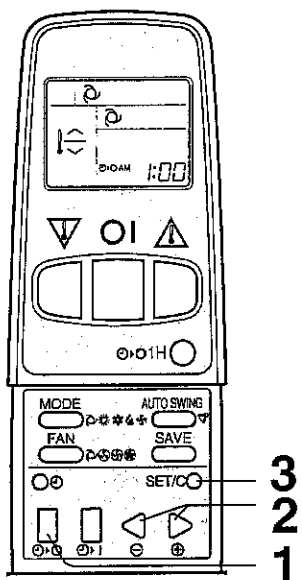

- 1 Press the TIMER OFF () button during operation.
- 2 The TIMER OFF indication will blink; press the TIME ADVANCE or REVERSE buttons to set the desired shut-off time. (The time can be set by 10 minutes .)
- 3 Point the remote control at the receiver window of the unit and press the TIMER SET (SET/C) button.
 - The yellow TIMER lamp on the unit lights up.
 - An audible sound indicates that the unit has received the signal.

HOW THE “AUTO SLEEP” FUNCTION WORKS

When the “AUTO SLEEP” FUNCTION is selected;

DURING COOL/DRY MODE

One hour after timer operation has begun, the temperature rises 1°C higher than the thermostat setting to prevent the room from getting too cool for sleeping.

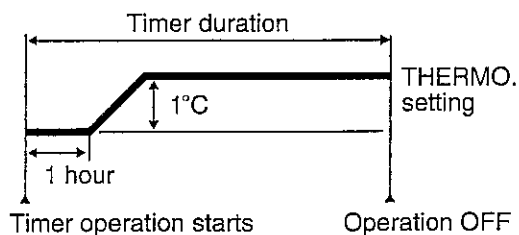

DURING HEAT MODE

One hour after timer operation has begun, the temperatures drops 3 °C lower than the thermostat setting to prevent the room from getting too warm for sleeping.

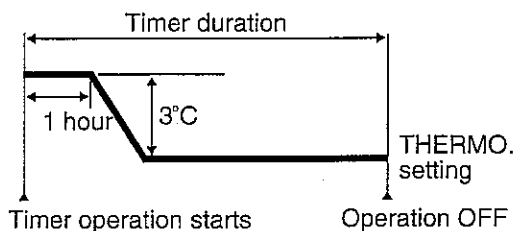

NOTE:

The “AUTO SLEEP” function will not activate during the FAN ONLY mode.

TIMER OPERATION (Continued)

COMBINED USE OF ON AND OFF TIMERS

Stop → ON → OFF

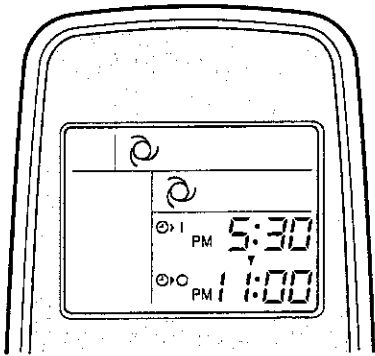

To obtain the desired room temperature by 5:30 p.m. and to stop operation at 11:00 p.m.

- 1 Set the TIMER ON to 5:30 p.m.
 - The yellow TIMER lamp on the unit lights up.
 - An audible sound indicates that the unit has received the signal.
- 2 Set the TIMER OFF to 11:00 p.m.
 - An audible sound indicates that the unit has received the signal.
- 3 Select the operation you wish to program.
Operation mode setting → MODE BUTTON
Fan speed setting → FAN BUTTON
Temperature setting → THERMO BUTTON

Operation → OFF → ON

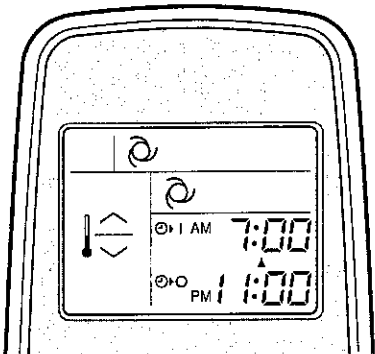

Stop operation at 11:00 p.m. and resume operation (using the same settings) to obtain the desired room temperature by 7:00 a.m.

- 1 Set the TIMER OFF to 11:00 p.m. during operation.
 - The yellow TIMER lamp on the unit lights up.
 - An audible sound indicates that the unit has received the signal.
- 2 Set the TIMER ON to 7:00 a.m.
 - An audible sound indicates that the unit has received the signal.

The arrows (▼ or ▲) between the TIMER ON indicator and TIMER OFF indicator shows which timer will activate first.

TO CANCEL THE COMBINED TIMER

Press the TIMER CANCEL button (SET/C).

Both TIMER ON and TIMER OFF will be canceled. The yellow TIMER lamp of the unit will go out and the current clock time will be displayed on the remote controller.

NOTES:

- You cannot program the ON and OFF timers to different temperatures or other settings.
- Either timer can be programmed prior to the other.

ONE-HOUR TIMER

When ONE-HOUR TIMER is set, the unit will turn off automatically after one hour .

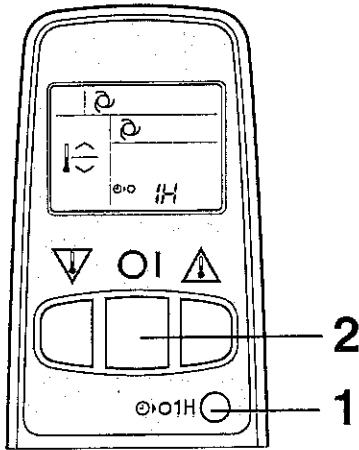

- 1** Press the ONE HOUR TIMER button.
 - "1 H" will be displayed on the remote control.
 - The unit will operate for one hour.
- 2** To turn off the unit within one hour, press the ON/OFF button.
 - The OPERATION lamp on the unit will go out.

If you wish to operate the unit additionally for another one hour, press the ONE-HOUR TIMER button again during operation.

NOTES:

- When the ONE HOUR TIMER button is pressed in the stop mode, the unit begins operating and turns off automatically after one hour.
- The ONE HOUR TIMER operation has priority over other timer operations, such as the TIMER ON and TIMER OFF.

Example 1:

If the timer off is set to 11:00 p.m. (A)
and the ONE HOUR TIMER button is pressed at 8:00 p.m. (B),

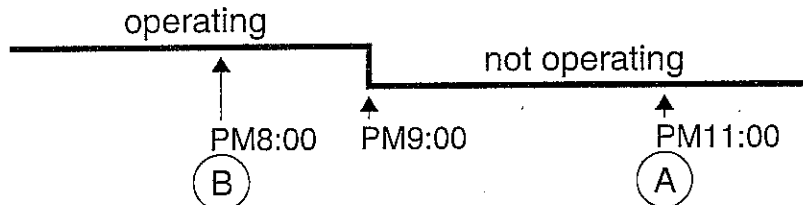

the unit will turn off at 9:00 p.m. The TIMER OFF indicator of the remote control will reappear after the "1H" indicator goes off. The TIMER OFF will be activated if you turn on the unit again before 11:00 p.m.

Example 2:

If the timer on is set to 8:00 a.m. (A)
and the ONE HOUR TIMER button is pressed at 5:00 a.m. (B),

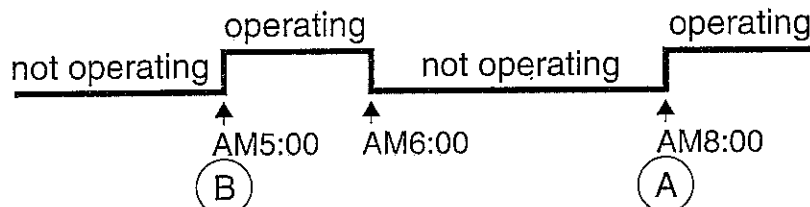

the unit will operate for one hour from 5:00 a.m. to 6:00 a.m. The TIMER ON indicator of the remote control will reappear after the "1H" indicator goes off. The unit will turn on when the TIMER ON (8:00 a.m.) activates.

USING THE AUXILIARY MODE

Use this mode when the remote control is not available.

TO TURN ON

Lift the panel of the indoor unit and press the AUX. button on the operation panel.

- The red OPERATION lamp on the unit will light up and the unit will start operating in the AUTO mode.
- The fan speed and temperature setting are set to AUTO.

TO TURN OFF

Press the AUX. button on the operation panel again.

- The red OPERATION lamp on the unit will go out.

NOTE:

If the AUX. button is pressed during normal operation, the unit will turn off.

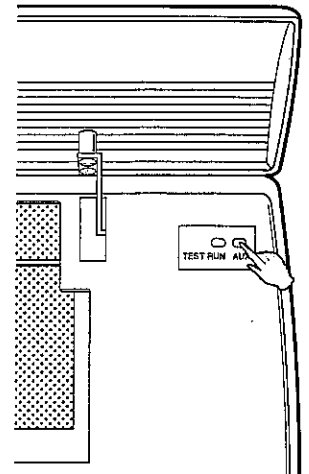

USING TEST RUN MODE

Use this mode to check the operation of the unit. Since the thermostat control does not function and runs in a continuous operation mode, do not use this mode during the normal operation.

Make sure the unit is turned off before conducting this test.

TO TURN ON

Lift the panel of the indoor unit and press the TEST RUN button on the operation panel.

- The red OPERATION lamp on the unit will blink and the unit will start operating in the COOL mode.

TO TURN OFF

Press the TEST RUN button on the operation panel again.

- The red OPERATION lamp on the unit will go out.

NOTE:

To conduct a test run in the HEAT mode, press the MODE button on the remote control to set the HEAT(☀) mode.

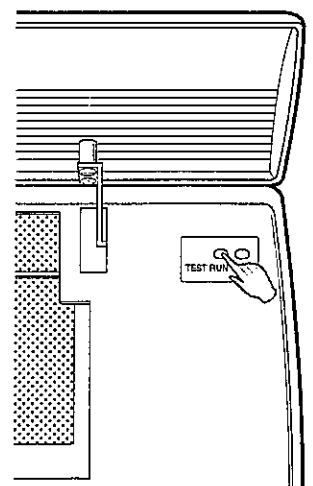

IMPORTANT OPERATIONAL POINTS

DURING THE AIR CONDITIONER OPERATION

- A built-in protective device may prevent the unit from operating when the ambient temperature is extremely high or low.
- Dew may form on the air outlet when the unit operates continuously in the COOL or DRY mode when the humidity is over 80%.

3-MINUTE PROTECTION

After the unit has been turned off, a protective mechanism prevents it from being turned on again for three minutes.

FAN SPEED

- When the fan speed is set to AUTO in the COOL mode, the fan speed automatically decreases as the room temperature nears the thermostat setting.
- When the room temperature reaches the thermostat setting in the HEAT mode, the compressor stops and the indoor fan changes to the SOFT setting or stops.
- In the DRY mode, the fan speed is controlled automatically.

PREHEATING FUNCTION

In the HEAT operation, the indoor fan may not start for 2-5 minutes after the unit is turned on to prevent the air from circulating before the unit is sufficiently warmed up.

DE-ICING FUNCTION

- When ice forms on the heat exchanger in the outdoor unit during the HEAT operation, an automatic de-icer provides heat for about 2-10 minutes to remove the ice. During de-icing, the inside and outside fans stop operating.
- After de-icing is completed, the unit automatically resumes operation in the HEAT mode.

HEATING EFFICIENCY

- The unit employs a heat pump that draws heat from the outside air and releases it into the room. The outside air temperature therefore greatly affects the heating efficiency.
- If low outside temperatures adversely affect the heating efficiency, use an additional heater.
- It takes time to warm up and heat the entire room because this unit employs a forced air circulation design. To warm up the room in advance, use the timer in the HEAT operation.

MAINTENANCE

Be sure to unplug the power cord from the wall outlet or turn off the circuit breaker before performing any maintenance.

CLEANING THE FILTERS

The air filters should be cleaned every 2 weeks. Clean the filters once a week, however, if there is a lot of dust in the room.

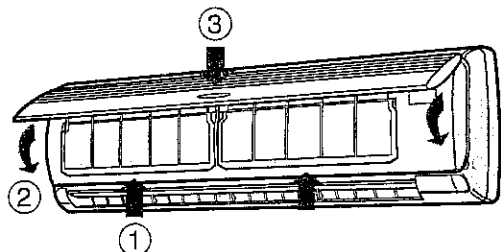
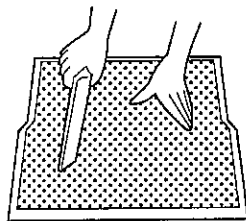
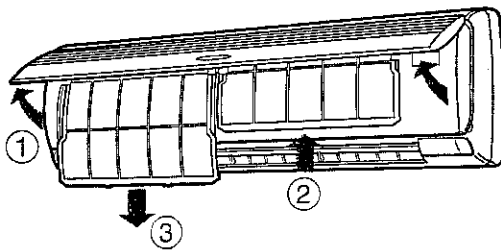

1 TURN OFF THE UNIT.

2 REMOVE THE FILTERS.

- 1 Lift up the cover.
- 2 Push the air filters up slightly to unlock them.
- 3 Pull the air filters down to remove them.

3 CLEAN THE FILTERS

Use a vacuum cleaner to remove the dust. If the filter is dirty, wash it with warm water and a mild detergent. Dry the filters in the shade before reinstalling.

4 REINSTALL THE FILTERS

- 1 Align and fit the filters in place.
- 2 Close the cover.
- 3 Push the centre of the cover firmly to lock it in place.

AVOID SPLASHING UNIT WITH WATER

Do not splash or pour water on the unit or the remote control. It could result in electrical shock or damage to the product. To clean the unit or the remote control, wipe them with a soft cloth.

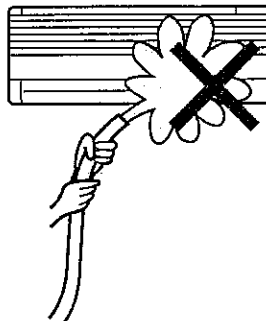

DO NOT USE HOT WATER OR SOLVENTS

Do not use hot water, thinner, abrasive powders or strong solvents to clean the unit or the remote control.

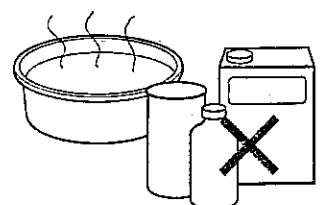

MAINTENANCE (Continued)

SEASONAL POST-OPERATION CHECK

RUN FAN FOR HALF A DAY

When you have finished using the unit for the season, run it in the FAN ONLY mode for about half a day to allow the mechanism to thoroughly dry.

TURN OFF CIRCUIT BREAKER

If you are using the home circuit breaker exclusively for the air conditioner, turn off the air conditioner, then turn off the circuit breaker.

CLEAN FILTERS

Clean the filters, then reinstall them.

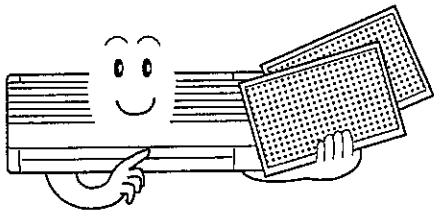

SEASONAL INSPECTION

ALWAYS INSTALL THE FILTERS

If the unit operates without a filter in place, dust can enter the machine and damage it.

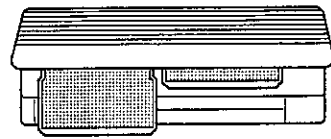

DO NOT BLOCK AIR INLET AND OUTLET

Blocking the air inlet and outlet can result in poor operation.

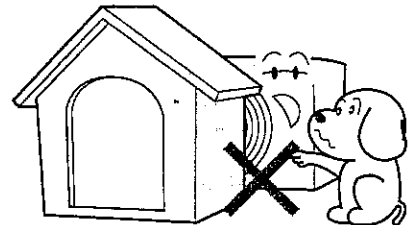

CHECK OUTDOOR UNIT MOUNTING RACK

Check the outdoor mounting rack periodically for wear and to make sure it is firmly in place.

ADDITIONAL NOTES ON OPERATION

THE FOLLOWING ARE NORMAL CONDITIONS FOR THE UNIT.

UNIT DOES NOT OPERATE

If you restart the air conditioner within 3 minutes after turning it off, or change the mode during operation, a protective device will work to shut off the unit for 3 minutes.

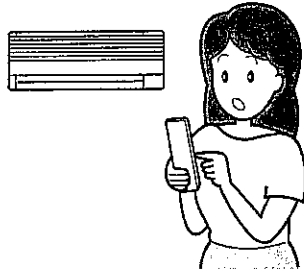

LOW NOISE

A soft, swishing noise can be heard during operation or immediately after the unit is turned off. This is the sound of the circulating refrigerant.

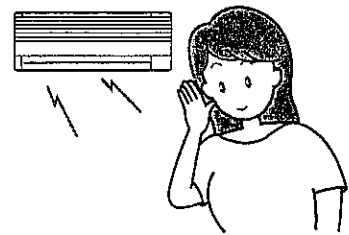

WARM AIR DOESN'T COME OUT

Warm air does not come out of the air outlets in the preheating or the de-icing operation.

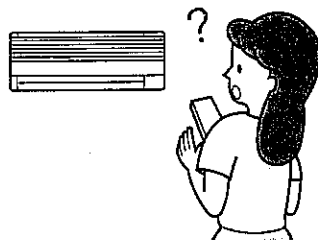

WATER VAPOUR

- In the COOL and DRY operation, water vapour can sometimes be seen coming from the air outlet due to the difference in temperature between the room air and the outlet air.
- In HEAT operation, water vapour may come out of the outdoor unit during the de-icing operation.

ODORS

Odors present in the room, such as those from the carpet or furniture, may be emitted from the unit.

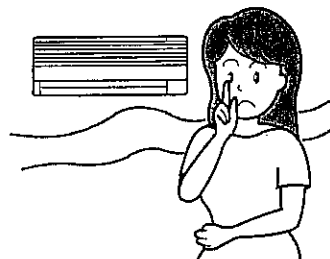

INDOOR UNIT FAN SPEED

When using the air swing mode, the speed of the indoor fan may vary slightly as the louvre moves up and down.

BEFORE CALLING FOR SERVICE

If the unit appears to be malfunctioning, check the following points before calling for service.

IF THE UNIT FAILS TO OPERATE

Check to see if the circuit breaker has tripped or the fuse has blown.

IF THE UNIT FAILS TO COOL THE ROOM PROPERLY

Check the filter. If it's dirty, clean it.

Check the outdoor unit to make sure nothing is blocking the air inlet or outlet.

Check whether the thermostat is set properly. If it is set too high in the COOL mode or too low in the HEAT mode, the unit may fail to operate properly.

Make sure all windows and doors are closed tightly. Air entering from outside can prevent the room from cooling sufficiently.

A large number of people in the room can prevent the desired temperature from being reached.

The use of heat-generating appliances in the room will adversely affect cooling efficiency.

IF THE UNIT FAILS TO RECEIVE THE REMOTE CONTROL SIGNAL

Check whether the remote control batteries have become old and weak.

Check whether the remote control batteries are installed in the proper polarity.

Try to send the signal again with the remote control pointed properly towards the unit's receiver window.

PRECAUTIONS FOR INSTALLATION

LOCATION

- The unit may not function well in locations where there is excessive dust, fumes or moisture in the air.

REMOVAL

- Do not attempt to remove the unit yourself. Consult your dealer or other qualified service personnel for assistance.

SPECIFICATIONS

Models	AY-A184J AE-A184J	AY-A244J AE-A244J
Rated A.C.voltage	230-240V	230-240V
Rated frequency	50Hz	50Hz
Cooling Capacity	4.98kW	6.53kW
Heating Capacity	5.90kW	7.83kW

SHARP CORPORATION
OSAKA, JAPAN

Free Manuals Download Website

<http://myh66.com>

<http://usermanuals.us>

<http://www.somanuals.com>

<http://www.4manuals.cc>

<http://www.manual-lib.com>

<http://www.404manual.com>

<http://www.luxmanual.com>

<http://aubethermostatmanual.com>

Golf course search by state

<http://golfingnear.com>

Email search by domain

<http://emailbydomain.com>

Auto manuals search

<http://auto.somanuals.com>

TV manuals search

<http://tv.somanuals.com>