



www.regency-fire.com

LIBERTY™ L900 Gas Fireplace

Owners & Installation Manual



Unit requires 120V to operate. See "Wiring Diagram" section in manual for more details. Receptacle is included with manual package.

MODELS: L900-NG Natural Gas L900-LP Propane

WARNING:

If the information in these instructions are not followed exactly, a fire or explosion may result causing property damage, personal injury or loss of life.

FOR YOUR SAFETY

Do not store or use gasoline or other flammable vapors and liquids in the vicinity of this or any other appliance.

Installation and service must be performed by a qualified installer, service agency or the gas supplier.

FOR YOUR SAFETY

What to do if you smell gas:

- Do not try to light any appliance
- Do not touch any electrical switch: do not use any phone in your building.
- Immediately call your gas supplier from a neighbour's phone. Follow the gas supplier's instructions.
- If you cannot reach your gas supplier, call the fire department.

tested by:



Installer: Please complete the details on the back cover and leave this manual with the homeowner.

Homeowner: Please keep these instructions for future reference.

To the New Owner:

Congratulations!

You are the owner of a state-of-the-art Gas Fireplace by REGENCY®. The L900 has been designed to provide you with all the warmth and charm of a wood fireplace at the flick of a switch. The model L900 has been approved by Warnock Hersey for both safety and efficiency. As it also bears our own mark, it promises to provide you with economy, comfort and security for many trouble free years to follow. Please take a moment now to acquaint yourself with these instructions and the many features of your Regency® Fireplace.

**MANUFACTURED MOBILE HOME REQUIREMENTS
INFORMATION FOR MOBILE/MANUFACTURED HOMES AFTER FIRST SALE**

This Regency® product has been tested and listed by Warnock Hersey as a Direct Vent Wall Furnace to the following standards: VENTED GAS FIREPLACE HEATERS ANSI Z21.88-2005 / CSA 2.33-2005, GAS-FIRED APPLIANCES FOR USE AT HIGH ALTITUDES CAN / CGA 2.17-M91 and ANSI Z21.50b-2003 / CSA 2.22b-2003.

This Direct Vent System Appliance must be installed in accordance with the manufacturer's installation instructions and the Manufactured Home Construction and Safety Standard, Title 24 CFR, Part 3280, or the current Standard of Fire Safety Criteria for Manufactured Home Installations, Sites, and Communities ANSI/NFPA 501A, and with CAN/CSA Z240-MH Mobile Home Standard in Canada.

This appliance installation must comply with the manufacturer's installation instructions and local codes, if any. In the absence of local codes follow the current National Fuel Gas Code, ANSI Z223.1 and the current National Electrical Code ANSI/NFPA 70 in the U.S.A., and the current CAN/CGA B149 Gas Installation Code and the current Canadian Electrical Code CSA C22.1 in Canada.

This appliance comes equipped with a dedicated #8 Ground Lug for attachment of the ground wire to the steel chassis as applicable to local codes.

The appliance, when installed, must be electrically grounded in accordance with local codes or, in the absence of local codes, with the National Electrical Code, ANSI/NFPA 70, or the Canadian Electrical Code, CSA C22.1.

This appliance may only be installed in an aftermarket permanently located, manufactured (U.S.A only) or mobile home, where not prohibited by local codes.

This appliance can only be used with the type of gas indicated on the rating plate. This appliance is not convertible for use with other gases, unless a certified kit is used.

Ensure that structural members are not cut or weakened during installation.

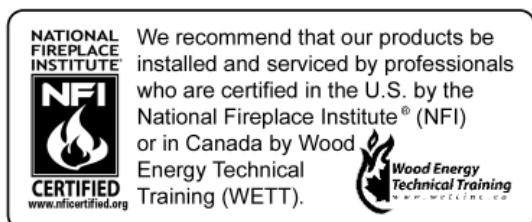

TABLE OF CONTENTS

SAFETY LABEL

Copy of Safety Decal.....	4
---------------------------	---

REQUIREMENTS

MA Code - CO Detector (for the State of Massachusetts only).....	5
---	---

UNIT DIMENSIONS

Unit Dimensions	6
-----------------------	---

INSTALLATION

Important Message	7
Before You Start	7
General Safety Information	7
Installation Checklist.....	7
Manufactured Mobile Home Additional Requirements ..	8
Locating Your Gas Fireplace	8
Heatwave Duct Kit	8
Heat Release Kit	8
Hearth Requirements	8
Clearances	9
Mantel Clearances	10
Mantel Leg Clearances	10
Framing & Finishing	11
Unit Assembly Prior To Installation	12
Top Standoff Assembly	12
Side Nailing Strips	12
Finishing Template.....	12
Venting Introduction.....	13
Vent Restrictor Position	13
Exterior Vent Termination Requirements.....	14
Venting Arrangements	15
Horizontal Termination (Flex).....	15
Rigid Pipe Venting Systems	16
Basic Horizontal & Vertical Terminations	16
5" x 8" Rigid Pipe Cross Reference Chart.....	17
Venting Arrangements	19
Allowable Horizontal Terminations.....	19
Venting Arrangements	22
Allowable Vertical Terminations	22
Unit Installation with Horizontal Termination.....	23
Unit Installation with Vertical Termination	24
Horizontal Termination with Flex Vent System	25
High Elevation	26
Gas Line Installation.....	26
Pilot Adjustment.....	26
Gas Pipe Pressure Testing.....	26
SIT 825 Valve Description	26

Back-Up Battery Installation (within Power Module) ...	27
Conversion Kit #546-969 from NG to LP.....	28
Brick Panel Installation	34
Log Set Installation	36
Aeration Adjustment	38
Wiring Diagram	38

OPERATING INSTRUCTIONS

Matching Remote Handset & Control Box ID Code	39
Operating Instructions	39
First Fire	39
Lighting Procedure	39

OPERATING INSTRUCTIONS

Normal Operating Sounds of Gas Appliances.....	40
Operation During Power Outage	40
Shutdown Procedure.....	40
Copy of Lighting Plate Instructions.....	41
Maintenance Instructions	42
General Vent Maintenance	42
Log Replacement	42
Thermopile / Thermocouple.....	42
Glass Gasket.....	42

MAINTENANCE

Door Glass	42
Glass Replacement	42
Back-Up Battery Replacement.....	43
Power Module Replacement	44
Control Module Replacement.....	45
DC Sparker Replacement	46
Valve Tray Replacement.....	47

PARTS LIST

Main Assembly	49
Burner & Log Assembly	51

WARRANTY

The Warranty: Limited Lifetime	55
--------------------------------------	----

SAFETY LABEL

This is a copy of the label that accompanies each L900-NG and L900-LP Direct Vent Gas Fireplace. We have printed a copy of the contents here for your review. The safety label is located on the right hand side of the unit, visible when the exterior right side brick panel is removed.

NOTE: Regency® units are constantly being improved. Check the label on the unit and if there is a difference, the label on the unit is the correct one.

COPY OF SAFETY DECAL

For the State of Massachusetts, installation and repair must be done by a plumber or gasfitter licensed in the Commonwealth of Massachusetts.

For the State of Massachusetts, flexible connectors shall not exceed 36 inches in length.

For the State of Massachusetts, the appliances individual manual shut-off must be a t-handle type valve.

The State of Massachusetts requires the installation of a carbon monoxide alarm in accordance with NFPA 720 and a CO alarm with battery back up in the same room where the gas appliance is installed.

DO NOT REMOVE THIS LABEL / NE PAS ENLEVER CETTE ÉTIQUETTE





320

Serial No. / No de serie

Listed: VENTED GAS FIREPLACE HEATER
Tested to: ANSI Z21.88-2005/ CSA 2.33-2005, CAN/CGA-2.17-M91,
ANSI Z21.50b-2003/ CSA 2.22b-2003
Certified for / Certifiée pour: CANADA AND U.S.A.



 Model/Modelo: L900-NG	NATURAL GAS FIREPLACE: MODEL L900-NG			
	Factory Equipped For Altitude 0-4500ft. (0-1372m)			
	Min. Supply Pressure	5"	WC	(1.25 kpa)
	Low Setting Man. Pressure	1.6"	WC	(0.39 kpa)
	Max. Manifold Pressure	3.5"	WC	(0.87 kpa)
	Orifice Size (Front Burner)	#47	DMS	
Orifice Size (Back Burner)	#30	DMS		
Minimum Input	11,000	Btu/h	(3.22 kW)	
Maximum Input	48,000	Btu/h	(14.06 kW)	

 Model/Modelo: L900-LP	PROPANE GAS FIREPLACE: MODEL L900-LP			
	Factory Equipped For Altitude 0-4500ft. (0-1372m)			
	Min. Supply Pressure	12"	WC	(2.98 kpa)
	Low Setting Man. Pressure	3.6"	WC	(0.9 kpa)
	Max. Manifold Pressure	10"	WC	(2.49 kpa)
	Orifice Size (Front Burner)	#56	DMS	
Orifice Size (Back Burner)	#50	DMS		
Minimum Input	9,500	Btu/h	(2.78 kW)	
Maximum Input	46,500	Btu/h	(13.62 kW)	

VENTED GAS FIREPLACE HEATER

This appliance must be installed in accordance with the manufacturer's installation instructions and with local codes, if any; if none, follow the current ANSI Z223.1 in the USA or the current CAN 1-B149 in Canada.

This vented gas fireplace heater is not for use with air filters.

For Manufactured Home Installation: This Direct Vent System Appliance must be installed in accordance with the manufacturer's installation instructions and Manufactured Home Construction and Safety Standard Title 24 CFR, Part 3280, or the current Standard for Fire Safety Criteria for Manufactured Home Installation, Sites, and Communities ANSI/NFPA 501A, and with CAN/CSA Z240 MH Mobile Home Standard in Canada.

This appliance is only for use with the type of gas indicated on the rating plate and may be installed in an aftermarket, permanently located, manufactured (mobile) home where not prohibited by local codes. See owner's manual for details. This appliance is not convertible for use with other gases, unless a certified kit is used (Kit #546-969). Certified for use with Heat Wave (Kit #946-556) and Heat Release (Kit #946-570). For use with glass doors certified with the appliance only.

Electrical Supply: 115 V, 0.1 A, 60 Hz
NOT FOR USE WITH SOLID FUEL

Minimum Clearances to Combustibles from Fireplace			
Side Walls	*A	16"	(406mm)
Ceiling	B	49"	(1245mm)
Min. Mantel Height	C	17-1/2"	(445mm)
Max. Mantel Depth	**D	13"	(330mm)
Alcove Width	E	84"	(2134mm)
Alcove Depth	F	36"	(914mm)

Non-Combustible Hearth Extension

Hearth Height	G	2"	(51mm)
Hearth Width	H	33-1/8"	(841mm)

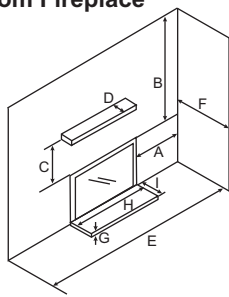

* Alcove side wall must have a min. of 16" (406mm) clearance on one side.
 ** Mantel depth taken at 27-1/2" (699mm) from front facing.

FPI Fireplace Products International Ltd., Delta BC, CANADA
MADE IN CANADA / FABRIQUE AU CANADA 918-609

MA Code - CO Detector (for the State of Massachusetts only)

5.08: Modifications to NFPA-54, Chapter 10

(2) Revise 10.8.3 by adding the following additional requirements:

(a) For all side wall horizontally vented gas fueled equipment installed in every dwelling, building or structure used in whole or in part for residential purposes, including those owned or operated by the Commonwealth and where the side wall exhaust vent termination is less than seven (7) feet above finished grade in the area of the venting, including but not limited to decks and porches, the following requirements shall be satisfied:

1. **INSTALLATION OF CARBON MONOXIDE DETECTORS.** At the time of installation of the side wall horizontal vented gas fueled equipment, the installing plumber or gasfitter shall observe that a hard wired carbon monoxide detector with an alarm and battery back-up is installed on the floor level where the gas equipment is to be installed. In addition, the installing plumber or gasfitter shall observe that a battery operated or hard wired carbon monoxide detector with an alarm is installed on each additional level of the dwelling, building or structure served by the side wall horizontal vented gas fueled equipment. It shall be the responsibility of the property owner to secure the services of qualified licensed professionals for the installation of hard wired carbon monoxide detectors

a. In the event that the side wall horizontally vented gas fueled equipment is installed in a crawl space or an attic, the hard wired carbon monoxide detector with alarm and battery back-up may be installed on the next adjacent floor level.

b. In the event that the requirements of this subdivision can not be met at the time of completion of installation, the owner shall have a period of thirty (30) days to comply with the above requirements; provided, however, that during said thirty (30) day period, a battery operated carbon monoxide detector with an alarm shall be installed.

2. **APPROVED CARBON MONOXIDE DETECTORS.** Each carbon monoxide detector as required in accordance with the above provisions shall comply with NFPA 720 and be ANSI/UL 2034 listed and IAS certified.

3. **SIGNAGE.** A metal or plastic identification plate shall be permanently mounted to the exterior of the building at a minimum height of eight (8) feet above grade directly in line with the exhaust vent terminal for the horizontally vented gas fueled heating appliance or equipment. The sign shall read, in print size no less than one-half (1/2) inch in size, "**GAS VENT DIRECTLY BELOW. KEEP CLEAR OF ALL OBSTRUCTIONS**".

4. **INSPECTION.** The state or local gas inspector of the side wall horizontally vented gas fueled equipment shall not approve the installation unless, upon inspection, the inspector observes carbon monoxide detectors and signage installed in accordance with the provisions of 248 CMR 5.08(2)(a)1 through 4.

(b) **EXEMPTIONS:** The following equipment is exempt from 248 CMR 5.08(2)(a)1 through 4:

1. The equipment listed in Chapter 10 entitled "Equipment Not Required To Be Vented" in the most current edition of NFPA 54 as adopted by the Board; and

2. Product Approved side wall horizontally vented gas fueled equipment installed in a room or structure separate from the dwelling, building or structure used in whole or in part for residential purposes.

(c) **MANUFACTURER REQUIREMENTS - GAS EQUIPMENT VENTING SYSTEM PROVIDED.** When the manufacturer of Product Approved side wall horizontally vented gas equipment provides a venting system design or venting system components with the equipment, the instructions provided by the manufacturer for installation of the equipment and the venting system shall include:

1. Detailed instructions for the installation of the venting system design or the venting system components; and

2. A complete parts list for the venting system design or venting system.

(d) **MANUFACTURER REQUIREMENTS - GAS EQUIPMENT VENTING SYSTEM NOT PROVIDED.** When the manufacturer of a Product Approved side wall horizontally vented gas fueled equipment does not provide the parts for venting the flue gases, but identifies "special venting systems", the following requirements shall be satisfied by the manufacturer:

1. The referenced "special venting system" instructions shall be included with the appliance or equipment installation instructions; and

2. The "special venting systems" shall be Product Approved by the Board, and the instructions for that system shall include a parts list and detailed installation instructions.

(e) A copy of all installation instructions for all Product Approved side wall horizontally vented gas fueled equipment, all venting instructions, all parts lists for venting instructions, and/or all venting design instructions shall remain with the appliance or equipment at the completion of the installation.

UNIT DIMENSIONS

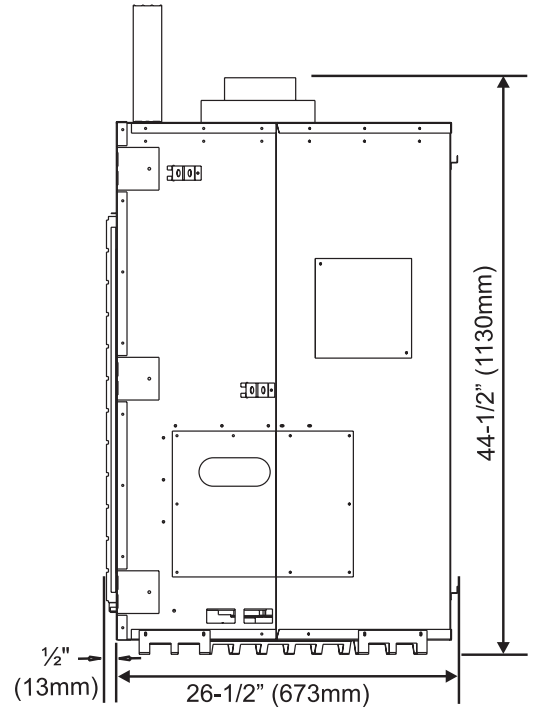
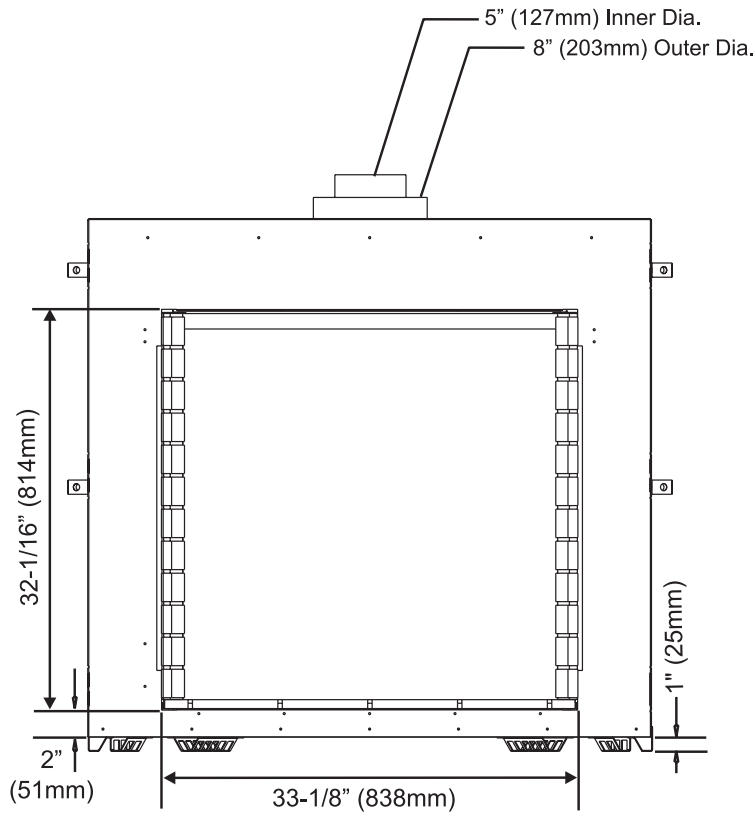
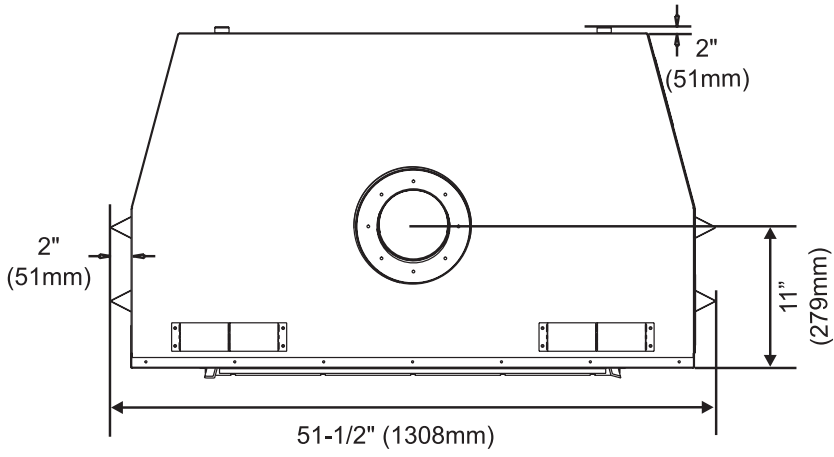

IMPORTANT MESSAGE SAVE THESE INSTRUCTIONS

The L900 Direct Vent Fireplace must be installed in accordance with these instructions. Carefully read all the instructions in this manual first. Consult the "authority having jurisdiction" to determine the need for a permit prior to starting the installation. It is the responsibility of the installer to ensure this fireplace is installed in compliance with manufacturers instructions and all applicable codes.

BEFORE YOU START

Safe installation and operation of this appliance requires common sense, however, we are required by the Canadian Safety Standards and ANSI Standards to make you aware of the following:

INSTALLATION AND REPAIR SHOULD BE DONE BY AN AUTHORIZED SERVICE PERSON. THE APPLIANCE SHOULD BE INSPECTED BEFORE USE AND AT LEAST ANNUALLY BY A PROFESSIONAL SERVICE PERSON. MORE FREQUENT CLEANING MAY BE REQUIRED DUE TO EXCESSIVE LINT FROM CARPETING, BEDDING MATERIAL, ETC. IT IS IMPERATIVE THAT CONTROL COMPARTMENTS, BURNERS AND CIRCULATING AIR PASSAGEWAYS OF THE APPLIANCE BE KEPT CLEAN.

DUE TO HIGH TEMPERATURES, THE APPLIANCE SHOULD BE LOCATED OUT OF TRAFFIC AND AWAY FROM FURNITURE AND DRAPERIES.

WARNING: FAILURE TO INSTALL THIS APPLIANCE CORRECTLY WILL VOID YOUR WARRANTY AND MAY CAUSE A SERIOUS HOUSE FIRE.

CHILDREN AND ADULTS SHOULD BE ALERTED TO THE HAZARDS OF HIGH SURFACE TEMPERATURES, ESPECIALLY THE FIREPLACE GLASS, AND SHOULD STAY AWAY TO AVOID BURNS OR CLOTHING IGNITION.

YOUNG CHILDREN SHOULD BE CAREFULLY SUPERVISED WHEN THEY ARE IN THE SAME ROOM AS THE APPLIANCE.

CLOTHING OR OTHER FLAMMABLE MATERIAL SHOULD NOT BE PLACED ON OR NEAR THE APPLIANCE.

GENERAL SAFETY INFORMATION

- 1) The appliance installation must conform with local codes or, in the absence of local codes, with the current Canadian or National Gas Codes, CAN1-B149 or ANSI Z223.1 Installation Codes.
- 2) The appliance when installed, must be electrically grounded in accordance with local codes, or in the absence of local codes with the current National Electrical Code, ANSI/NFPA 70 or CSA C22.1 Canadian Electrical Code.
- 3) See general construction and assembly instructions. The appliance and vent should be enclosed.
- 4) This appliance must be connected to the specified vent and termination cap to the outside of the building envelope. Never vent to another room or inside a building. Make sure that the vent is fitted as per Venting instructions.
- 5) Inspect the venting system annually for blockage and any signs of deterioration.
- 6) Venting terminals shall not be recessed into a wall or siding.
- 7) Any safety glass removed for servicing must be replaced prior to operating the appliance.
- 8) To prevent injury, do not allow anyone who is unfamiliar with the operation to use the fireplace.
- 9) Wear gloves and safety glasses for protection while doing required maintenance.
- 10) Be aware of electrical wiring locations in walls and ceilings when cutting holes for termination.
- 11) Under no circumstances should this appliance be modified. Parts that have to be removed for servicing should be replaced prior to operating this appliance.

- 12) Installation and any repairs to this appliance should be done by an authorized service person. A professional service person should be called to inspect this appliance annually. Make it a practice to have all of your gas appliances checked annually.
- 13) Do not slam shut or strike the glass door.
- 14) Under no circumstances should any solid fuels (wood, paper, cardboard, coal, etc.) be used in this appliance.
- 15) The appliance area must be kept clear and free of combustible materials, (gases and other flammable vapours and liquids).

Emissions from burning wood or gas could contain chemicals known to the State of California to cause cancer, birth defects or other reproductive harm.

INSTALLATION CHECKLIST

- 1) Locate appliance
 - a) Room location (Refer to "Locating Your Gas fireplace" section)
 - b) Clearances to Combustibles (Refer to "Clearances" section)
 - c) Mantle Clearances (Refer to "Mantel Clearances" section)
 - d) Framing & Finishing Requirements (Refer to "Framing & Finishing" section)
 - e) Venting Requirements (Refer to "Venting" section)
- 2) Assemble Top Standoffs (Refer to "Unit Assembly Prior to Installation).
- 3) Install back-up batteries. Refer to "Back-up Battery Installation" section.
- 4) Convert to propane if desired (Refer to "Conversion from NG to LP" section).
- 5) Slide unit into place.
- 6) Install vent (Refer to "Venting Arrangement" sections).
- 7) Make gas connections (Refer to "Gas Line Installation section).
- 8) Make electrical connections (Refer to "Wiring Diagram" section). **NOTE: Unit requires 120V to operate.**
- 9) Test the pilot (Refer to "Pilot Adjustment" section).
- 10) Test Gas Pressure (Refer to "Gas Pipe Pressure Testing" section).

INSTALLATION

11) Install standard and optional features. Refer to the following sections:

- a) Interior Brick Panels
- b) Log Set
- c) Exterior Brick Panels
- d) Remote Control - refer to "Matching Remote Handset & Control Box ID Code" section.

12) Final check.

Before leaving this unit with the customer, the installer must ensure that the appliance is firing correctly and **operation fully explained to customer.**

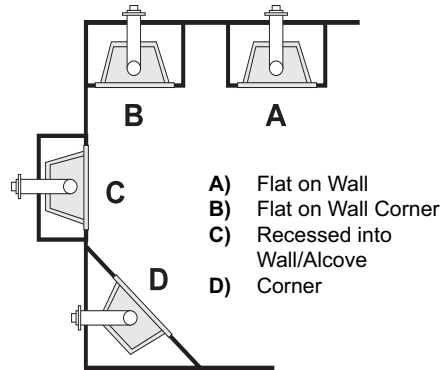

Diagram 1

This includes:

- 1) Clocking the appliance to ensure the correct firing rate (rate noted on label 48,000 (NG) Btu/h, 46,500 (LP) Btu/h) after burning appliance for 15 minutes.
- 2) If required, adjusting the primary air to ensure that the flame does not carbon. First allow the unit to burn for 15-20 min. to stabilize.

CAUTION: Any alteration to the product that causes sooting or carboning that results in damage is not the responsibility of the manufacturer.

MANUFACTURED MOBILE HOME ADDITIONAL REQUIREMENTS

- 1) Ensure that structural members are not cut or weakened during installation.
- 2) Ensure proper grounding using the #8 ground lug provided. See "Wiring Diagram" section.

LOCATING YOUR GAS FIREPLACE

- 1) When selecting a location for your fireplace, ensure that the clearances are met.
- 2) The appliance must be installed on a flat, solid, continuous surface (e.g. wood, metal, concrete). This may be the floor, or raised up on a platform to enhance its visual impact. The appliance must be installed on a metal or wood panel extending the full width and depth of the appliance.
- 3) The L900 Direct Vent Gas Fireplace can be installed in a recessed position or framed out into the room as in A, B, C and D. See Diagram 1.

- 4) This appliance is Listed for bedroom installations using the standard FireWizard Remote (millivolt thermostat system). Some areas may have further requirements, check local codes before installation.
- 5) The L900 Direct Vent Gas Fireplace is approved for alcove installations, see "Clearances" section for details.
- 6) We recommend that you plan your installation on paper using exact measurements for clearances and floor protection before actually installing this appliance. Have an authorized inspector, dealer, or installer review your plans before installation.

Note: For vent terminations refer to "Exterior Vent Termination Locations" section.

HEATWAVE DUCT KIT

The **HeatWave** Air Duct Kit increases the effectiveness of your fireplace by dispersing warm air from the fireplace to remote locations in the same room or other rooms in your home.

Up to two kits may be installed on the fireplace. **Please Note:** Only 1 HeatWave kit may be operated at one time.

See HeatWave installation manual for complete details and clearances from side only.



HEAT RELEASE KIT

The Heat Release Kit expels warm air from the fireplace to the outside of the building, allowing the fireplace to be operated with less heat entering the room. The kit may be used on either the left or right side.

See Heat Release installation manual for complete details and clearances from side only.

HEARTH REQUIREMENTS

A minimum 33-1/8" (838mm) wide x 12" (305mm) deep x 2" (51mm) thick non-combustible hearth is required if the finished floor is not flush with the base of the unit. The maximum height between the finished floor and sub-floor is 1" (25mm).

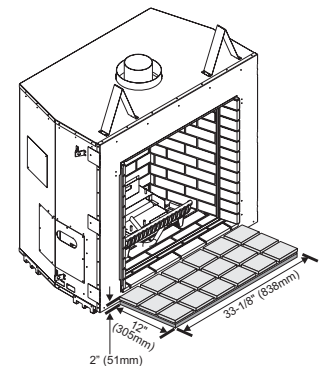
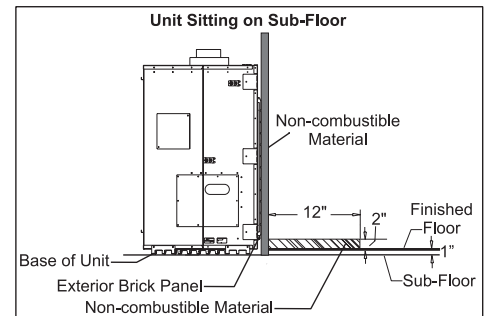

NOTE: No hearth is required when the unit is flush with the finished floor as shown below.

The minimum floor clearance must be maintained from the top surface of the carpet, etc. to the unit base.

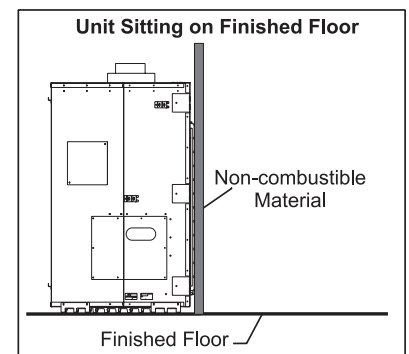

CLEARANCES

The clearances listed below are Minimum distances unless otherwise stated:

A major cause of chimney related fires is failure to maintain required clearances (air space) to combustible materials. It is of the greatest importance that this fireplace and vent system be installed only in accordance with these instructions.

Caution Requirements

The top, back and sides of the fireplace are defined by standoffs. The metal ends of the standoff may **NOT** be recessed into combustible construction.

Clearance to Combustibles from:

Back	0"	(0mm)
Side	0"	(0mm)
Floor	0"	(0mm)

Minimum Clearance from Top of Front Facing:

Mantel	min. 17-1/2"	(445mm)
Ceiling	49"	(1245mm) from top of front facing

Side Wall to Unit:

16"* (406mm)

Horizontal Vent Clearances to Combustibles:

Top	3"	(76mm)
Side	2"	(51mm)
Bottom	2"	(51mm)

Vertical Vent Clearances to Combustibles:

All Sides	2"	(51mm)
-----------	----	--------

Alcove Clearances:

Min. Depth	36"	(914mm)
Min. Width*	84"	(2134mm)
Min. Height	84"	(2134mm)

* Alcove side wall must have a minimum of 16" (406mm) clearance on one side.

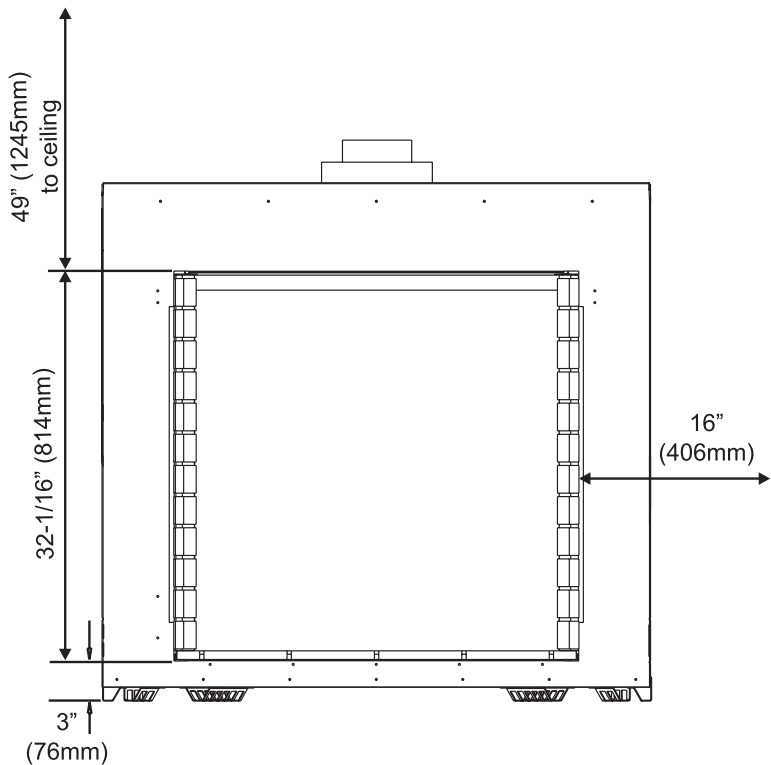

WARNING

Fire hazard is an extreme risk if these clearances (air space) to combustible materials are not adhered to. It is of greatest importance that this fireplace and vent system be installed only in accordance with these instructions.

IMPORTANT

If converting this unit to LP, it is highly recommended the conversion be done **BEFORE** the unit is slid into position for ease of conversion. See "Conversion from NG to LP" section for instructions.

INSTALLATION

MANTEL CLEARANCES

Because of the extreme heat this fireplace emits, the mantel clearances are critical. Combustible mantel clearances from top of front facing are shown in the diagram below.

Note: A non-combustible mantel may be installed at a lower height if the framing is made of metal studs covered with a non-combustible board.

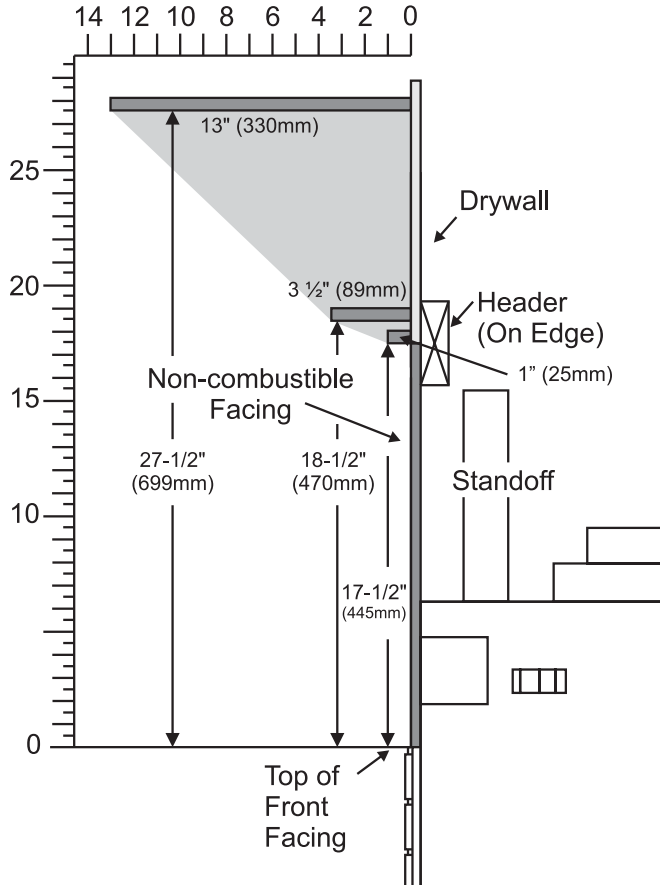

Note: Ensure the paint that is used on the mantel and the facing is "heat resistant" or the paint may discolour.

MANTEL LEG CLEARANCES

Combustible mantel leg clearances as per diagram:

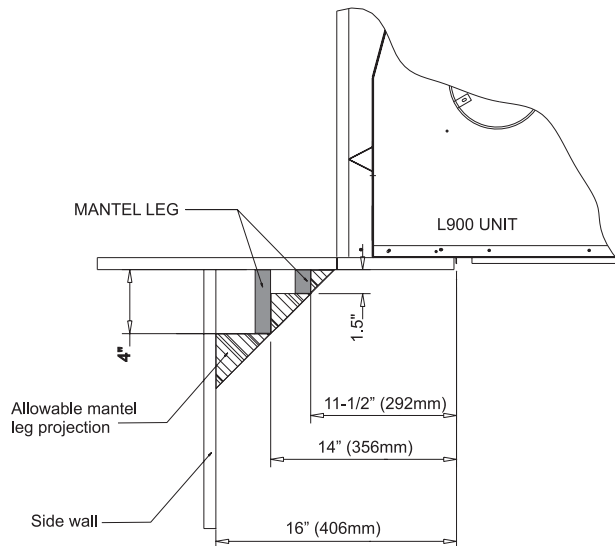

INSTALLATION

UNIT ASSEMBLY PRIOR TO INSTALLATION

The Top Facing Support, the Side Nailing Strips and the 2 Top Standoffs must be correctly positioned and attached to the top before unit is slipped into position.

TOP STANDOFF ASSEMBLY

The top standoffs are shipped in a flat position and must be folded into shape and attached.

- 1) Remove the standoffs from the fireplace top.
- 2) Take each standoff and bend into the correct shape. Bend up at the bend lines until the screw holes in the standoff and the pre-punched screw holes on the fireplace top line up.
- 3) Attach the standoff securely to the top with 2 screws per standoff (on opposite corners).

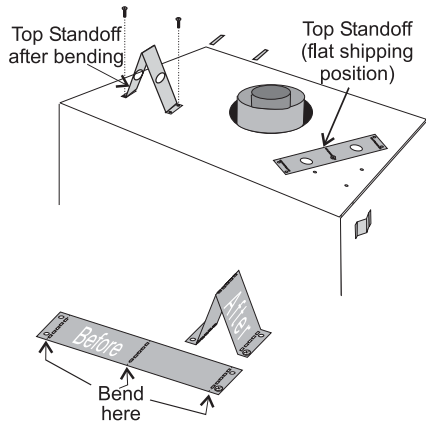

SIDE NAILING STRIPS

The side nailing strips come attached to the unit. There are 3 plates, one on the top and bottom that can be folded out as required.

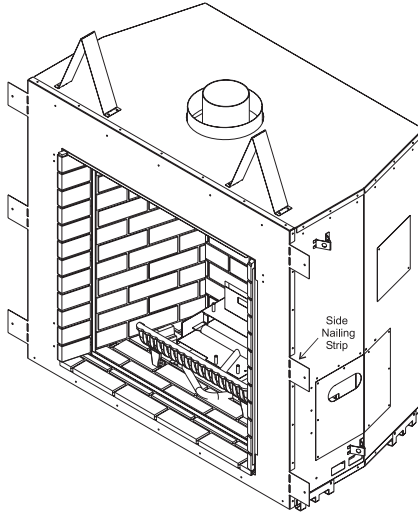

Side Nailing Strips shown folded out.

FINISHING TEMPLATE

In order to maintain a clean face; the L900 allows for a 1/8" in overlap of finishing material, such as rock or tile, on both the left and right hand sides of the unit (top and bottom sides do not allow for an overlap), this overlap must not be exceeded or the glass door will no longer open properly.

Non-combustible wall board is installed up to the flanges on all sides of the unit. When installing any additional facing material use the Finishing Template (included with the unit) to ensure that the finishing material does not exceed the allowable overlap.

The Finishing Template uses two magnets to attach itself to the flange on the left or right side of the unit (see diagram below). Install the facing material up to the outside edge (when facing the unit) of the finishing template. This template may be discarded after the facing material has been installed.

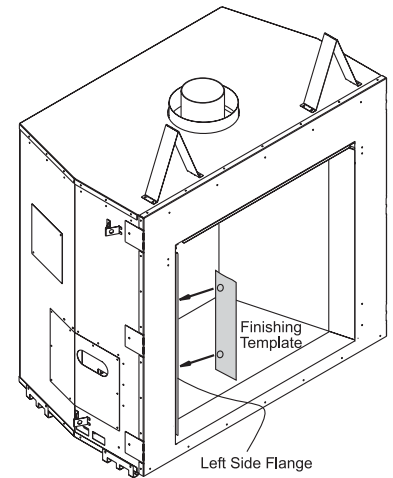

VENTING INTRODUCTION

The L900 uses the "balanced flue" technology Co Axial system. The inner liner vents products of combustion to the outside while the outer liner draws outside combustion air into the combustion chamber thereby eliminating the need to use heated room air for combustion and losing warm room air up the chimney.

Note: These flue pipes must not be connected to any other appliance.

The gas appliance and vent system must be vented directly to the outside of the building, and never be attached to a chimney serving a separate solid fuel or gas burning appliance. Each direct vent gas appliance must use it's own separate vent system. Common vent systems are prohibited.

VENT RESTRICTOR POSITION

Vent restriction is required for certain venting installations, see the diagrams in the "Venting Arrangements" section to determine if they are required for your installation.

The Vent Restrictor plate is located on the inside top of the firebox.

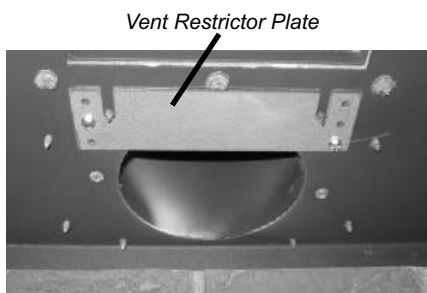

To set the vent restriction as indicated in the venting arrangements diagrams, refer to the instructions below;

- 1) Remove the glass door.
 - a. Release the 2 door latches on the left and right side at the top of the firebox.

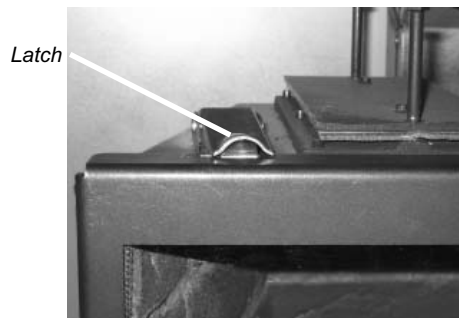

- b. Swing the door out from the top and release the hinges on the left and right side of the door by lifting them up.

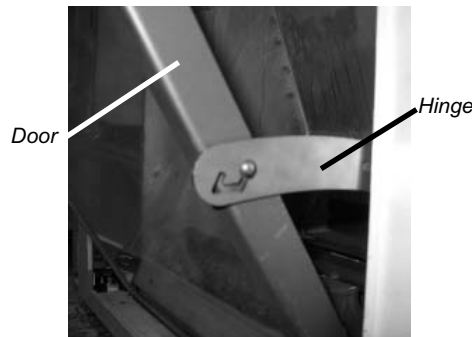

- 2) Remove the screws that hold the vent restrictor plate in place.
- 3) Adjust the vent restrictor plate to the required vent restrictor position as per the diagrams shown.
- 4) Once the vent restrictor plate is in the required position, secure with screws.

- Screws for plugging the holes. (all holes must be plugged with a screw).
- Screw holes for fixing the restrictor plate.

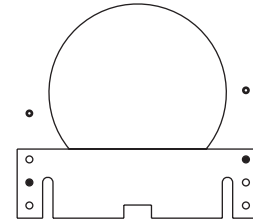

Factory Set Vent Restrictor Setting
(no adjustment required)

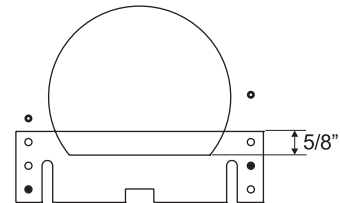

Vent Restrictor Set 1

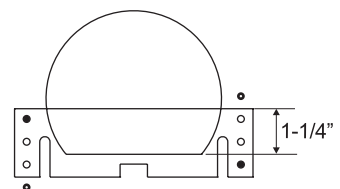

Vent Restrictor Set 2

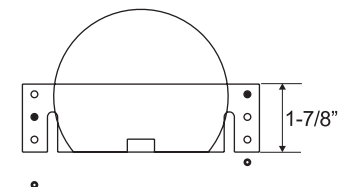

Vent Restrictor Set 3

EXTERIOR VENT TERMINATION REQUIREMENTS

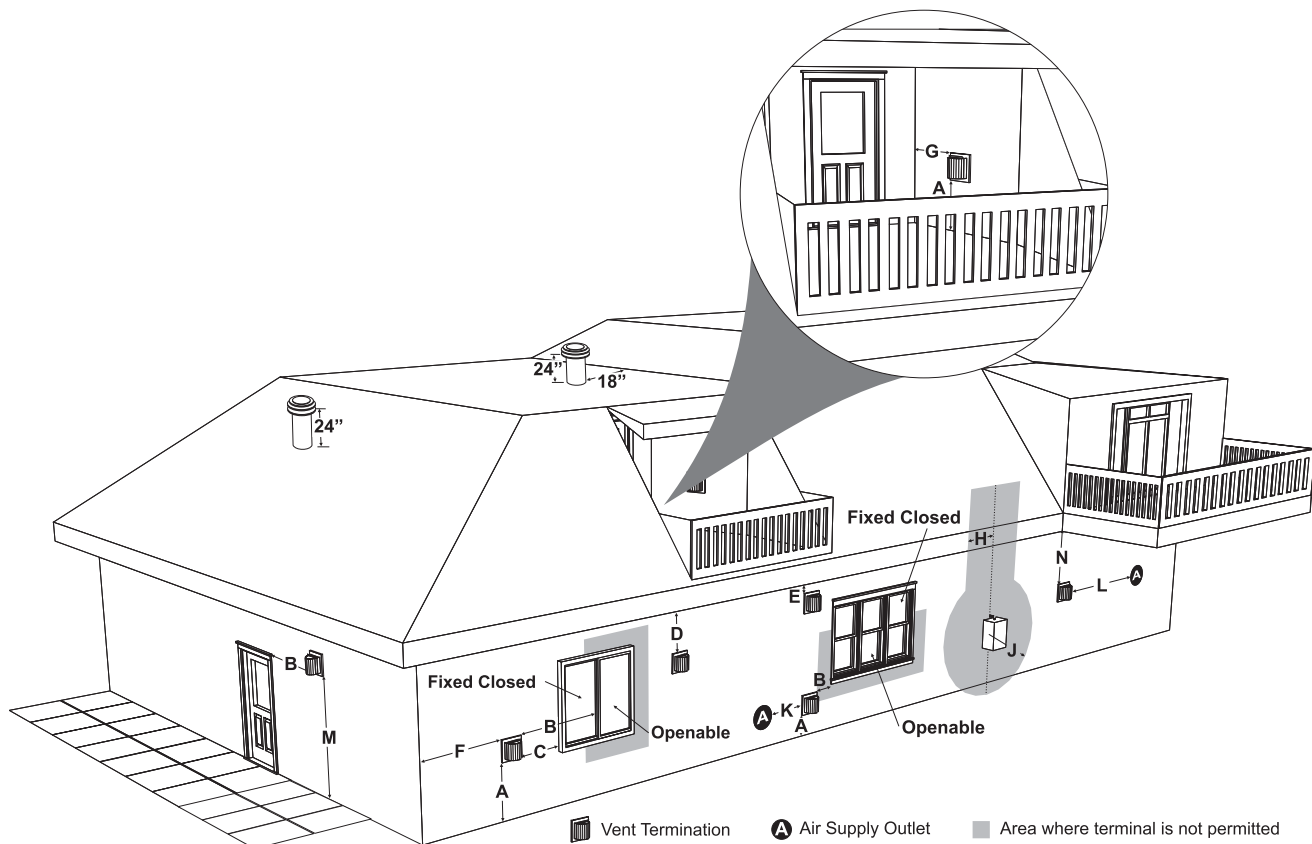

- A= Clearance above grade, veranda, porch, deck, or balcony *(min. 12"/30cm)
- B= Clearance to window or door that may be opened *(12"/30cm) #(9"/23cm)
- C= Clearance to permanently closed window *(min. 12"/30cm)
- D= Vertical clearance to ventilated soffit located above the terminal within a horizontal distance of (24"/60cm) from the centerline of the terminal (min. 33"/84cm) check with local code.
- E= Clearance to unventilated soffit (min. 33"/84cm)
- F= Clearance to outside corner: with **AstroCap** Termination Cap (min. 13")
- G= Clearance to inside corner: with **AstroCap** Termination Cap (min. 18")
- H= Not to be installed above a meter/regulator assembly within (3'/90cm) horizontally from the centerline of the regulator.
- J= Clearance to service regulator vent outlet *(min. 36"/90cm)
- K= Clearance to non-mechanical air supply inlet to building or the combustion air inlet to any other appliance *(12"/30cm) #(9"/23cm)
- L= Clearance to a mechanical air supply inlet *(min. 72"/1.8m)
#3' (91cm) above if within 10' (3m) horizontally.
- M= Clearance above paved sidewalk or a paved driveway located on public property *(min. 84"/2.1m)
- N= Clearance under veranda, porch, deck, or balcony *(min. 33"/84cm)

Note:

- Excluding direct vent or non-condensing appliances, a vent shall not terminate directly above a sidewalk or paved driveway which is located between two single family dwellings and serves both dwellings.
- Only permitted if veranda, porch, deck, or balcony is fully open on a minimum of two sides beneath the floor.
- If the vent termination is accessible, a certified guard shall be installed.

* As specified in CGA B149 Installation Code. Note: Local codes or regulations may require different clearances.

In accordance with the current ANSI Z223.1/NFPA 54, National Fuel Gas Code.

VENTING ARRANGEMENTS

HORIZONTAL TERMINATION (FLEX) Regency® Direct Vent System

These venting systems, in combination with the L900, have been tested and listed as a direct vent system by Warnock Hersey. The location of the termination cap must conform to the requirements in the Vent Terminal Locations diagram from the "Exterior Vent Termination Locations" section.

FPI Direct Vent (Flex) System Termination Kits include all the parts needed to install the L900 using a flexible vent.

FPI Kit #	Length	Contains:
#946-618	6 Feet	1) 8" flexible liner (Kit length) 2) 5" flexible liner (Kit length) 3) spring spacers (3) 4) thimble (2) 5) AstroCap termination cap (1)
#946-616	10 Feet	6) screws (12) 7) tube of Mill Pac (1) 8) plated screws (8) 9) S.S. screws #8 x 1-1/2" drill point, (4) 10) vinyl siding standoff

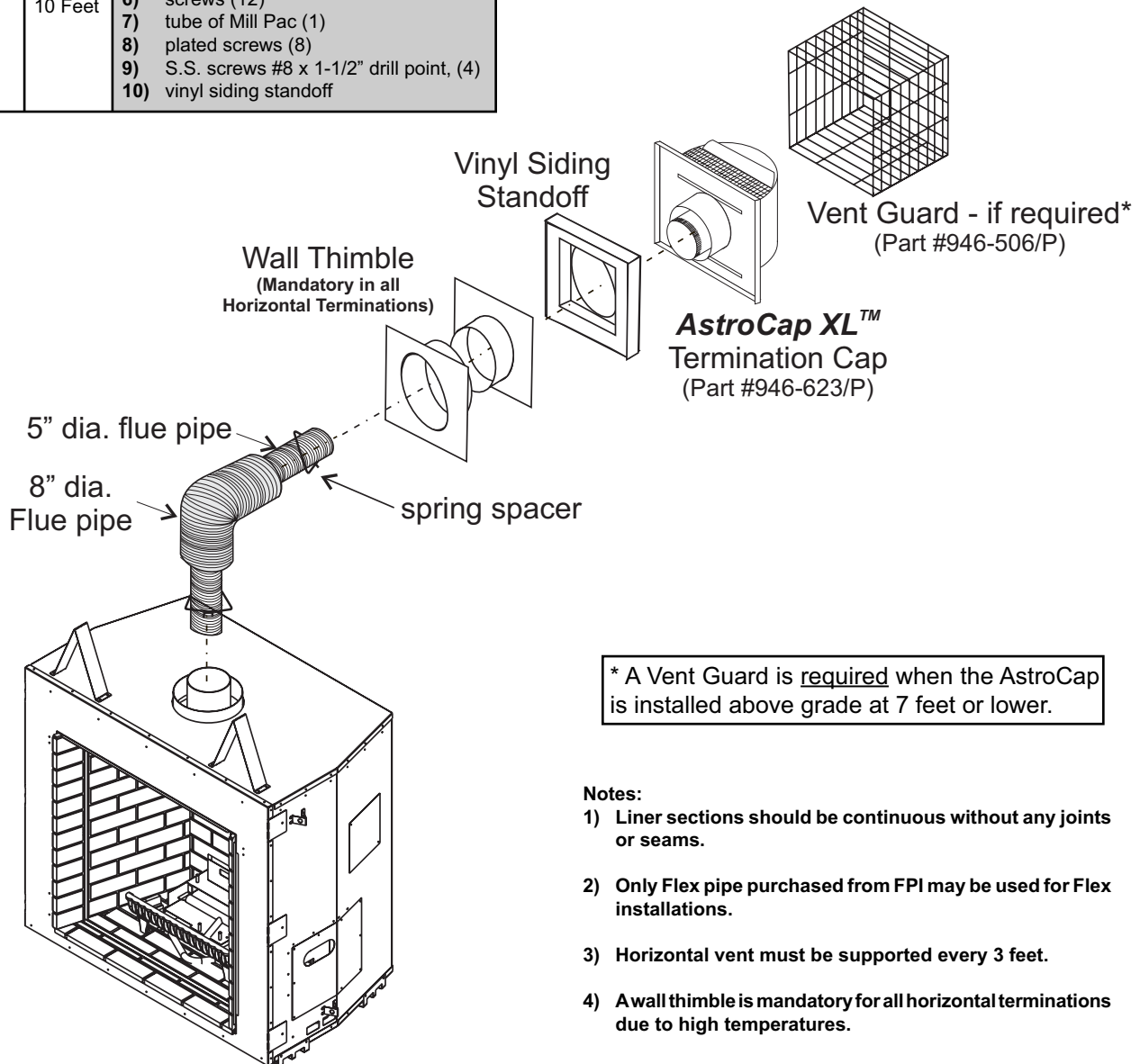

* A Vent Guard is required when the AstroCap is installed above grade at 7 feet or lower.

Notes:

- 1) Liner sections should be continuous without any joints or seams.
- 2) Only Flex pipe purchased from FPI may be used for Flex installations.
- 3) Horizontal vent must be supported every 3 feet.
- 4) A wall thimble is mandatory for all horizontal terminations due to high temperatures.

RIGID PIPE VENTING SYSTEMS

BASIC HORIZONTAL & VERTICAL TERMINATIONS

Rigid Pipe Vent Systems offer a complete line of component parts for installation of both horizontal and vertical installations. Many items are offered in decorative black, as well as galvanized finish.

The minimum components required for a basic horizontal termination are:

- 1 AstroCap XL
- 1 90° Elbow
- 1 Rigid Pipe Adaptor
- 1 Wall Thimble
- 1 Length of pipe to suit wall thickness

The minimum components required for a basic vertical termination are:

- 1 Vertical Termination Cap
- 1 Rigid Pipe Adaptor
- 1 Lengths of pipe to adequately penetrate roof
- 1 Ceiling Firestop
- 1 Flashing
- 1 Storm Collar

Wall thickness is measured from the back standoffs to the inside mounting surface of termination cap. For siding other than vinyl furring strips may be used, instead of the vinyl siding standoff, to create a level surface to mount the vent terminal. The Terminal must not be recessed into siding. Measure the wall thickness including furring strips.

If a Vinyl Siding Standoff is required (it must be used with vinyl siding), measure to outside surface of wall without siding and add 2 inches.

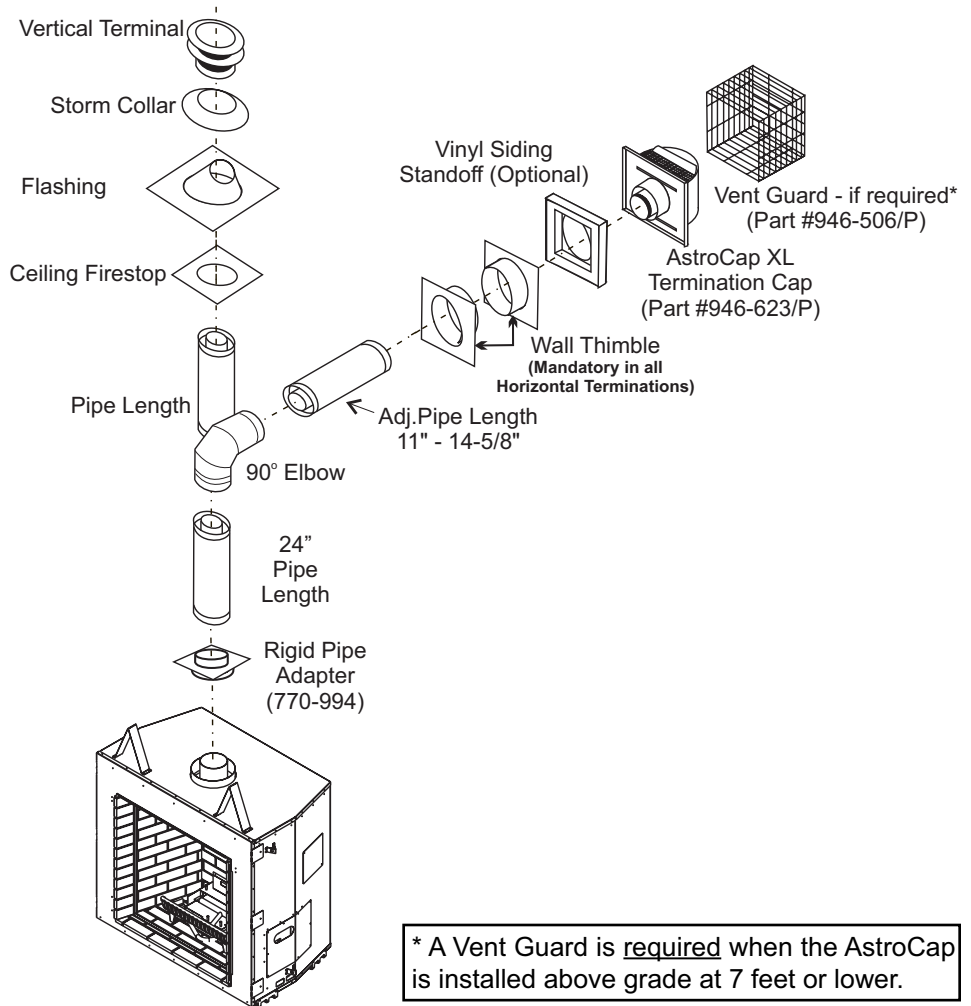

* A Vent Guard is required when the AstroCap is installed above grade at 7 feet or lower.

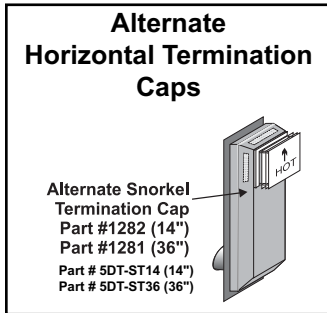

WARNING:

Do not combine venting components from different venting systems.

Use of the the AstroCap XL™ is acceptable with all systems.

This product has been evaluated by Intertek for using a Rigid Pipe Adaptor in conjunction with Duravent Direct-Vent GS and Selkirk Direct-Temp systems. Use of these systems with the Rigid Pipe adaptor is deemed acceptable and does not affect the Intertek WHI listing of components.

IMPORTANT NOTE

- The Simpson Dura-Vent and Selkirk Direct Temp horizontal termination caps cannot be used in any applications.
- Only the AstroCap XL and Snorkels are certified for horizontal terminations.

When using Rigid Vent other than Simpson Dura-Vent, 3 screws must be used to secure rigid pipe to adaptor.

The FPI AstroCap XL™ is certified for installations using FPI venting systems as well as Simpson Dura-Vent® Direct Vent GS and Selkirk Direct-Temp. AstroCap XL™ is a proprietary trademark of FPI Fireplace Products International Ltd. Dura-Vent® and Direct Vent GS are registered and/or proprietary trademarks of Simpson Dura-Vent Co. Inc.

5" X 8" RIGID PIPE CROSS REFERENCE CHART

Components from different Manufacturers may not be mixed. Not All Rigid Pipe components are available directly from FPI.

Description	Simpson Direct Vent Pro®	Simpson Direct Vent GS® Discontinued	Selkirk Direct-Temp™	Metal-Fab® Sure Seal
6" Pipe Length, Galvanized	58DVA-06	1208	5DT-6	5D6
6" Pipe Length, Black	58DVA-06B	1208B	5DT-6B	5D6B
9" Pipe Length, Galvanized	58DVA-09	1207	5DT-9	N/A
9" Pipe Length, Black	58DVA-09B	1207B	5DT-9B	N/A
12" Pipe Length, Galvanized	58DVA-12	1206	5DT-12	5D12
12" Pipe Length, Black	58DVA-12B	1206B	5DT-12B	5D12B
18" Pipe Length, Galvanized	58DVA-18	58DVA-18	5DT-18	5D18
18" Pipe Length, Black	58DVA-18B - N/A from FPI	58DVA-18B - N/A from FPI	5DT-18B	5D18B
24" Pipe Length, Galvanized	58DVA-24	1204	5DT-24	5D24
24" Pipe Length, Black	58DVA-24B	1204B	5DT-24B	5D24B
36" Pipe Length, Galvanized	58DVA-36	1203	5DT-36	5D36
36" Pipe Length, Black	58DVA-36B	1203B	5DT-36B	5D36B
48" Pipe Length, Galvanized	58DVA-48	1202	5DT-48	5D48
48" Pipe Length, Black	58DVA-48B	1202B	5DT-48B	5D48B
60" Pipe Length, Galvanized	58DVA-60	58DVA-60	N/A	N/A
60" Pipe Length, Black	58DVA-60B - N/A from FPI	58DVA-60B - N/A from FPI	N/A	N/A
Adjustable Length 3"-10", Galvanized	N/A	N/A	N/A	5DAL
Adjustable Length 3"-10", Black	N/A	N/A	N/A	5DALB
Adjustable Length 11"-14", Galvanized	Disc - See 58DV-08A	Disc - See 58DV-08A	5DT-AJ	N/A
Adjustable Length 11"-14", Black	Disc - See 58DV-08AB	Disc - See 58DV-08AB	5DT-AJB	N/A
Adjustable Length 17"-24", Galvanized	Disc - See 58DV-16A	Disc - See 58DV-16A	N/A	N/A
Adjustable Length 17"-24", Black	Disc - See 58DV-16AB	Disc - See 58DV-16AB	N/A	N/A
Extension Pipe 8-1/2", Galvanized	58DVA-08A - N/A from FPI	58DVA-08A - N/A from FPI	N/A	N/A
Extension Pipe 8-1/2", Black	58DVA-08AB	58DVA-08AB	N/A	N/A
Extension Pipe 16", Galvanized	58DVA-16A - N/A from FPI	58DVA-16A - N/A from FPI	N/A	N/A
Extension Pipe 16", Black	58DVA-16AB	58DVA-16AB	N/A	N/A
45° Elbow, Galvanized	58DVA-E45	1245	5DT-EL45	N/A
45° Elbow, Black	58DVA-E45B	1245B	5DT-EL45B	N/A
45° Elbow, Swivel, Galvanized	Disc - See 58DVA-E45	1245G	N/A	5D45L
45° Elbow, Swivel, Black	Disc - See 58DVA-E45B	1245BG	N/A	5D45LB
90° Elbow, Galvanized	58DVA-E90	58DVA-E90	5DT-EL90S	N/A
90° Elbow, Black	58DVA-E90B	58DVA-E90B	5DT-EL90SB	N/A
90° Elbow, Swivel, Galvanized	Disc - See 58DVA-E90	Disc - See 58DVA-E90	N/A	5D90L
90° Elbow, Swivel, Black	Disc - See 58DVA-E90B	Disc - See 58DVA-E90B	N/A	5D90LB
90° Starter Elbow, Swivel, Galvanized*	N/A	N/A	N/A	5D90A
Adaptor*	N/A	N/A	N/A	5DDA
Ceiling Support	58DVA-DC	1240	5DT-CS	5DSP
Cathedral Support Box	58DVA-CS	1241	5DT-CSS	5DRS
Wall Support/Band	58DVA-WS	1288	5DT-WS/B	5DWS
Offset Support	58DVA-ES - N/A from FPI	N/A	5DT-OS	N/A
Wall Thimble, Black	58DVA-WT	1247	5DT-WT	5DWT
Wall Thimble Support Box/Ceiling Support	58DVA-DC - N/A from FPI	N/A	N/A	N/A
Firestop Spacer	58DVA-FS	1263	5DT-FS	5DFS
Trim Plate, Black	58DAV-WFS	1242	5DT-TP	5DCP

INSTALLATION

Components from different Manufacturers may not be mixed. Not All Rigid Pipe components are available directly from FPI.

Description	Simpson Direct Vent Pro®	Simpson Direct Vent GS® Discontinued	Selkirk Direct-Temp™	Metal-Fab® Sure Seal
Round Support / Radiation Shield	N/A	N/A	N/A	N/A
Flat Flashing	N/A	N/A	N/A	N/A
Attic Insulation Shield 12"	58DVA-IS - N/A from FPI	58DVA-IS - N/A from FPI	N/A	N/A
Basic Horizontal Termination Kit (A)	N/A	N/A	5DT-HKA	N/A
Horizontal Termination Kit (B)	58DVA-KHA	N/A	5DT-HKB	N/A
Vertical Termination Kit	58DVA-VCH	1291	5DT-VKC	N/A
High Wind Vertical Cap	N/A	N/A	N/A	N/A
High Wind Horizontal Cap	DISC.	1285	N/A	N/A
Horizontal Square Termination Cap	N/A	1284	5DT-HHC	5DHT
Vertical Termination Cap	N/A	N/A	5DT-HVC	5DVT
Storm Collar	58DVA-SC	1253	5DT-SC	5DSC
Adjustable Flashing, 0/12-6/12	58DVA-F6	1243	5DT-AF6	5DF
Adjustable Flashing, 6/12-12/12	58DVA-F12	1243S	5DT-AF12	5DF-12
Vinyl Siding Standoff	58DVA-VSS	1250	5DT-VS	5DVS
Vinyl Siding Shield Plate	N/A	N/A	5DT-VSP	N/A
Snorkel Termination 14"	58DVA-SNK14	1282	5DT-ST14	5DST14
Snorkel Termination 36"	N/A	1281	5DT-ST36	5DST36
Restrictor Disk	58DVA-RD	N/A	N/A	N/A
Colinear Flex Liner Adapter (3" Ø)	N/A	N/A	N/A	N/A
FPI				
946-604/P	Simpson Direct Vent Vent Guard (Optional)	946-623/P	AstroCap XL Horizontal Cap	
770-994	Rigid Pipe Adapter (Must use with all Rigid Piping)	946-506/P	Vent Guard (Optional)	
		946-625	Vinyl Siding Standoff - AstroCap XL	

***NOTE:** When using Metal-Fab Sure Seal Rigid Piping please note that either the Adaptor (5DDA) or 90° Starter Elbow (5D90A) must be used in conjunction with FPI Rigid Pipe Adaptor (770-994).

L676 & L900 Direct Vent Fireplace

IMPORTANT NOTE

- A Vent Guard is required when the AstroCap is installed above grade at 7 feet or lower.
- The Simpson Dura-Vent and Selkirk Direct Temp horizontal termination caps cannot be used in any applications.
- Only the AstroCap XL and Snorkels are certified for horizontal terminations.

Offset Pipe Selection:

Use this table to determine offset pipe lengths.

Pipe Length	5" x 8" Venting	
	Run (X)	Rise (Y)
0"(0mm)	5-11/16"(144mm)	15-5/16"(389mm)
6"(152mm)	8-13/16"(224mm)	18-7/16"(468mm)
9"(229mm)	10-15/16"(278mm)	20-9/16"(522mm)
12"(305mm)	13"(330mm)	22-11/16"(576mm)
24"(610mm)	21-7/16"(697mm)	31-1/16"(789mm)
36"(914mm)	29-13/16"(757mm)	39-7/16"(1002mm)
48"(1219mm)	38-1/4"(972mm)	47-7/8"(1216mm)

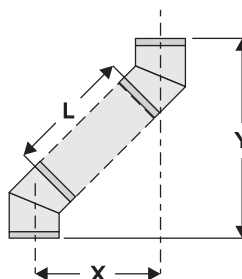

For specific instructions or details on particular venting components please visit the following websites:

Simpson Direct Vent Pro: www.duravent.com

Selkirk Direct-Temp: www.selkirkcorp.com

Metal-Fab Sure Seal: www.mtfab.com

NOTE: Horizontal runs of vent must be level, or have a 1/4 inch rise for every 1 foot of run towards the termination. Never allow the vent to run downward. This could cause high temperatures and may present a possible fire hazard.

VENTING ARRANGEMENTS

ALLOWABLE HORIZONTAL TERMINATIONS

The diagram shows all allowable combinations of vertical runs with horizontal terminations, using one 90° two 45° elbows equal one 90° elbow).

Note: Must use optional rigid pipe adapter (Part# 770-994) when using Rigid Pipe Venting Systems.

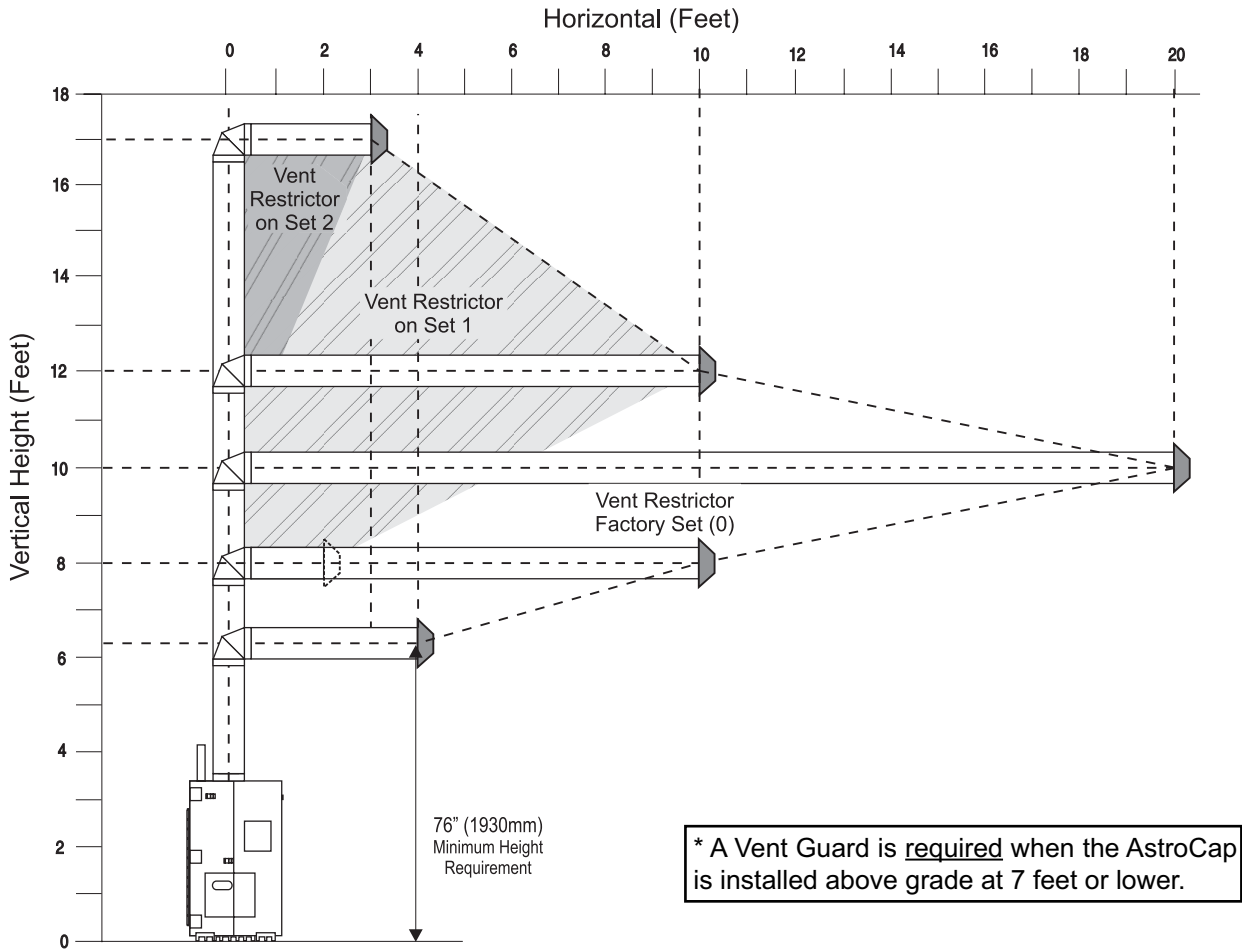

* A Vent Guard is required when the AstroCap is installed above grade at 7 feet or lower.

IMPORTANT NOTE

- The Simpson Dura-Vent and Selkirk Direct Temp horizontal termination caps cannot be used in any applications.
- Only the AstroCap XL and Snorkels are certified for horizontal terminations.

VENT RESTRICTOR SETTING:

Vent restrictor at 0" - factory set, no adjustment required unless otherwise indicated.

Refer to the "Vent Restrictor Position" section for details on how to change the vent restrictor to Set 1, Set 2 or Set 3 if required.

A vent guard is required when the AstroCap is installed above grade at 7 feet or lower.

A vent guard may also be required in other installations as per local codes, refer to "Exterior Vent Termination Requirements" section for details.

Note: Regency® Direct Vent System (Flex) is only approved for horizontal terminations.

- Maintain clearances to combustibles as listed in "Clearances" section
- Horizontal vent must be supported every 3 feet.
- Firestops are required at each floor level and whenever passing through a wall.
- A wall thimble is mandatory for all horizontal terminations due to high temperatures.

INSTALLATION

Horizontal Venting with Two (2) 90° Elbows

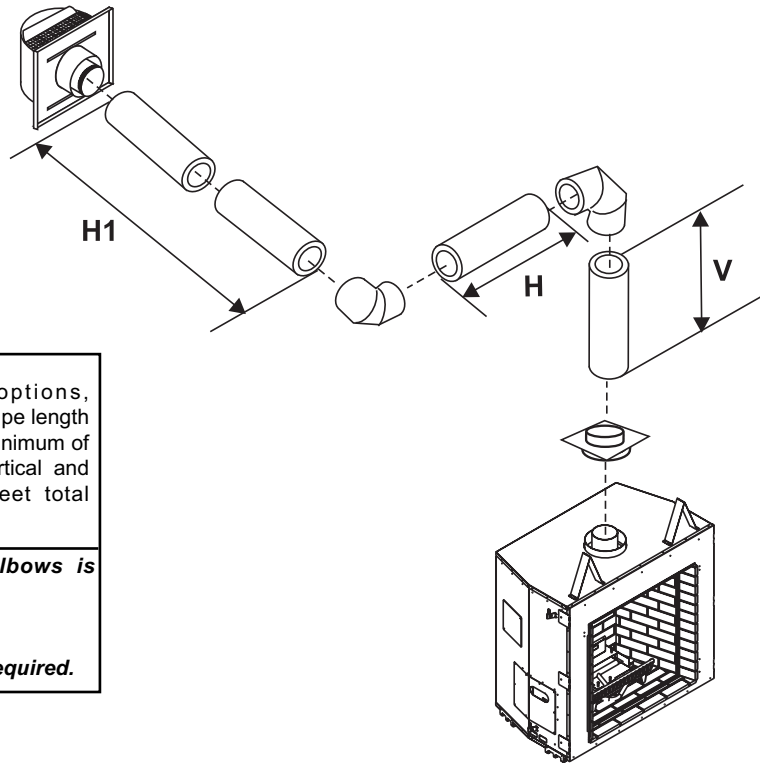

One 90° elbow = Two 45° elbows.

Option	V	H + H1	
A)	3' Min.	2' Max.	With these options, maximum total pipe length is 30 feet with minimum of 10 feet total vertical and maximum 10 feet total horizontal.
B)	4' Min.	4' Max.	
C)	6' Min.	8' Max.	
D)	8' Min.	9' Max.	
E)	10' Min.	10' Max.	

Please note minimum 1 foot between 90° elbows is required.

VENT RESTRICTOR SETTING:
Vent restrictor at 0" - factory set, no adjustment required.

Horizontal Venting with Three (3) 90° Elbows

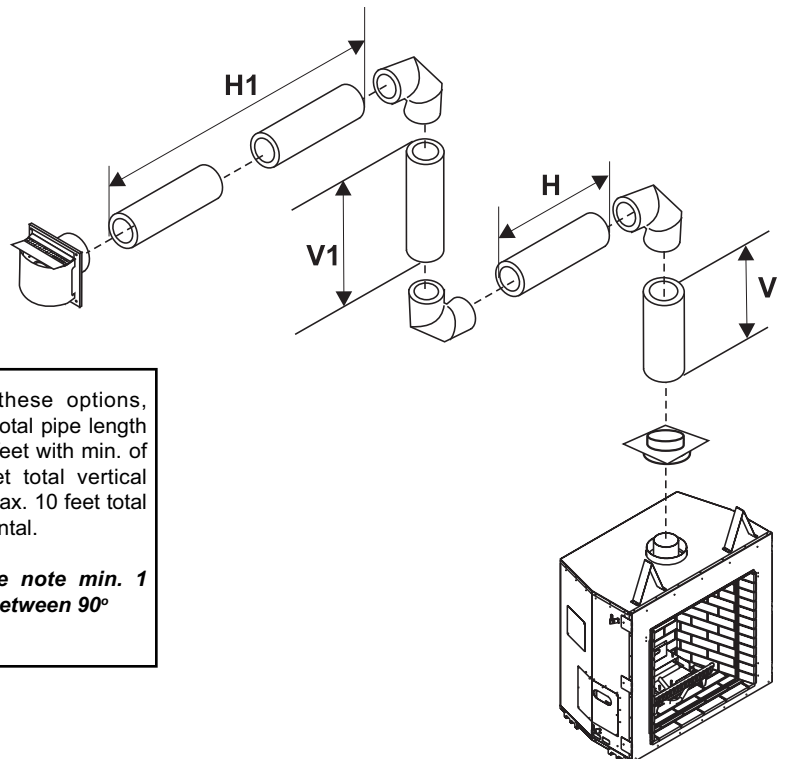

One 90° elbow = Two 45° elbows.

Option	V	H	V + V1	H + H1	
A)	2' Min.	1' Max.	5' Min.	2' Max.	With these options, max. total pipe length is 30 feet with min. of 11 feet total vertical and max. 10 feet total horizontal.
B)	3' Min.	1' Max.	6' Min.	3' Max.	
C)	4' Min.	3' Max.	8' Min.	6' Max.	
D)	5' Min.	4' Max.	10' Min.	8' Max.	
E)	5' Min.	4' Max.	11' Min.	10' Max.	

Please note min. 1 foot between 90°

VENT RESTRICTOR SETTING:
Vent restrictor at 0" - factory set, no adjustment required.

Vertical Venting with Three (3) 90° Elbows

One 90° elbow = Two 45° elbows.

Option	V	H + H1	V + V1
A)	2' Min.	3' Max.	4' Min.
B)	3' Min.	4' Max.	6' Min.
C)	4' Min.	5' Max.	8' Min.
D)	5' Min.	6' Max.	9' Min.
E)	6' Min.	8' Max.	10' Min.

With these options, max. total pipe length is 30 feet with min. of 10 feet total vertical and max. 8 feet total horizontal.

Please note min. 1 foot between 90° elbows is required.

VENT RESTRICTOR SETTING:
Vent restrictor at 0" - factory set, no adjustment required.

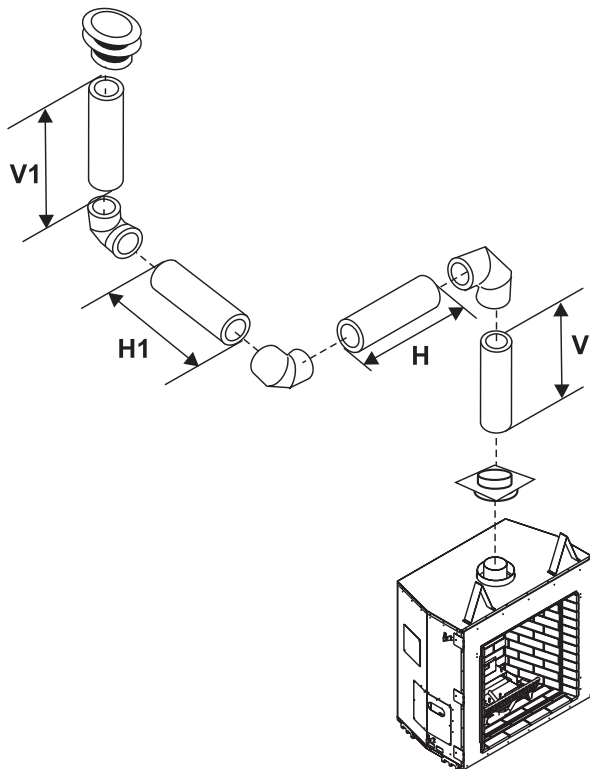

VENTING ARRANGEMENTS

ALLOWABLE VERTICAL TERMINATIONS

The shaded area in the diagram shows all allowable combinations of straight vertical and offset to vertical terminations, using two 90° elbows, with **Rigid Pipe Venting Systems** for Propane and Natural Gas. Two 45° elbows equal to one 90° elbow. Maximum of four 45° elbows allowed.

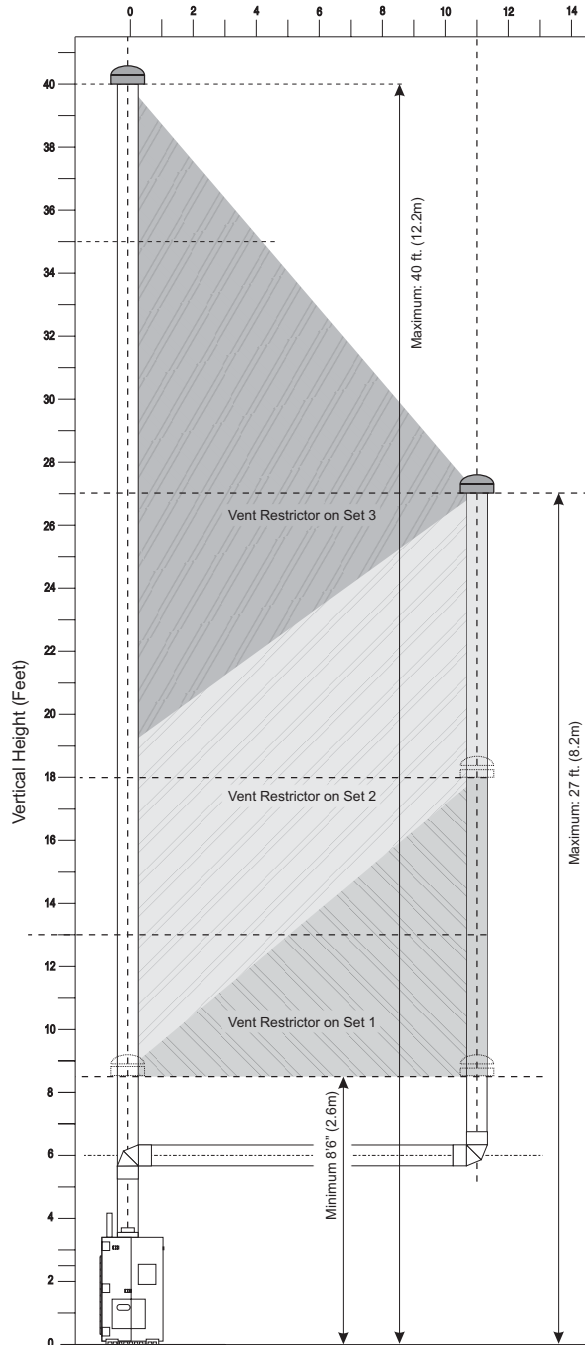

- Vent must be supported at offsets.
- Firestops are required at each floor level and whenever passing through a wall.
- Maintain clearances to combustibles as listed in the "Clearances" section.
- Refer to "Vent Restrictor Position" section for details on how to change the vent restrictor to Set 1, Set 2 or Set 3 if required.

Note: Must use optional flue adapter when using Rigid Pipe (Part # 770-994).

UNIT INSTALLATION WITH HORIZONTAL TERMINATION (Rigid Vent Systems)

Atop clearance of 3" (76mm) and side & bottom clearance of 2" (51mm) must be maintained; except when passing through a wall, ceiling, or at the termination where the use of a firestop or wall thimble reduces the required clearance to 1-1/2" (38mm). We recommend framing a 11" (279mm) x 11" (279mm) (inside dimensions) hole to give structural rigidity for mounting the termination.

Install the vent system according to the manufacturer's instructions included with the components.

- 1) Set the unit in its desired location. Check to determine if wall studs or roof rafters are in the way when the venting system is attached. If this is the case, you may want to adjust the location of the unit. Rough in the gas preferably on the right side of the unit and the electrical (junction block is on the left side) on the left.
- 2) Direct Vent pipe and fittings are designed with special twist-lock connections to connect the venting system to the appliance flue outlet. A twist-lock appliance adaptor is required.
- 3) In conjunction with the Simpson Dura-Vent Direct Vent GS system. Install the adaptor after the unit is set in its desired location. Put a bead of high temperature silicone inside the outer section of the adaptor and a bead of Mill Pack on the inner collar. Slip the adaptor over the existing inner and outer flue collar. Fasten to the outer collar only with the 3 supplied screws (drilling pilot holes will make this easier).
- 4) Level the fireplace and fasten it to the framing using nails or screws through the top and side nailing strips.
- 5) Assemble the desired combination of pipe and elbows to the appliance adaptor and twist-lock for a solid connection.

Note: For best results and optimum performance with each approved venting system, it is highly recommended to apply "Mill-Pac" sealant (supplied) to every inner pipe connection. Failure to do so may result in drafting or performance issues not covered under warranty. Silicone (red RTV) is optional.

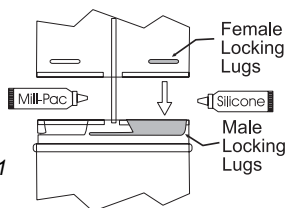

Diagram 1

Horizontal runs of vent must be supported every 3 feet (0.9meter). Wall straps are available for this purpose.

- 6) Mark the wall for a 11" x 11" (279mm x 279mm) square hole. The center of the square hole should line up with the center-line of the horizontal pipe. Cut and frame the 11 inch (279mm) square hole in the exterior wall where the vent will be terminated. See diagram 2 for center line requirements.

If the wall being penetrated is constructed of non-combustible material, i.e. masonry block or concrete, an 8" (203mm) diameter hole is acceptable.

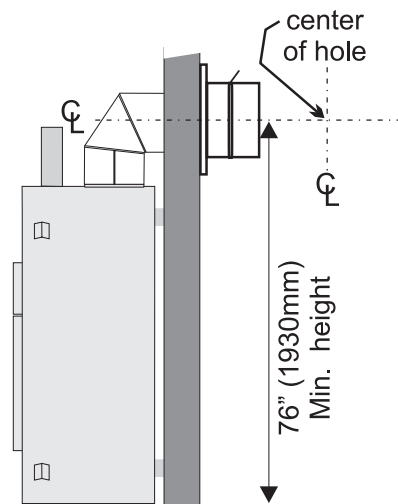

Diagram 2

Note:

- a) The horizontal run of vent must be level, or have a 1/4 inch rise for every 1 foot of run towards the termination. Never allow the vent to run downward. This could cause high temperatures and may present the possibility of a fire.
- b) The location of the horizontal vent termination on an exterior wall must meet all local and national building codes, and must not be blocked or obstructed. See "Exterior Vent Termination Locations" section for more details.

- 7) Ensure that the pipe clearances to combustible materials are maintained (Diagram 5). Install the termination cap.

Note: If installing termination on a vinyl siding covered wall, a vinyl siding standoff or furring strips must be used to ensure that the termination is not recessed into the siding.

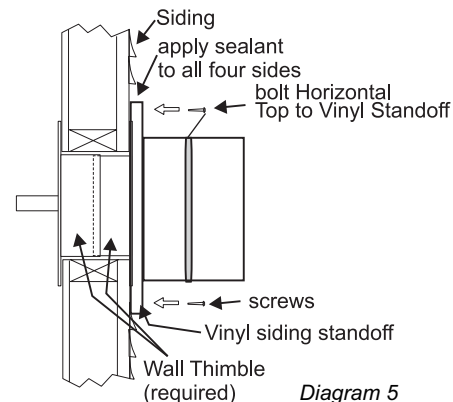

Diagram 5

The four wood screws provided should be replaced with appropriate fasteners for stucco, brick, concrete, or other types of sidings.

- 8) Before connecting the horizontal run of vent pipe to the vent termination, slide the Wall Thimble over the vent pipe. The wall thimble is required for all horizontal terminations.
- 9) Slide the appliance and vent assembly towards the wall carefully inserting the vent pipe into the vent cap assembly. It is important that the vent pipe extends into the vent cap sufficient distance so as to result in a minimum pipe overlap of 1-1/4 inches (32mm). Secure the connection between the vent pipe and the vent cap.
- 10) Install wall thimble in the center of the 11" (279mm) square and attach with wood screws (Diagram 7).

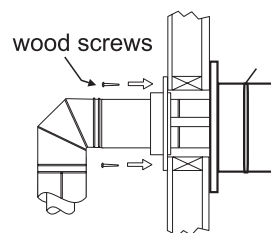

Diagram 7

NOTE: A Vent Guard is required when the AstroCap is installed above grade at 7 feet or lower.

INSTALLATION

UNIT INSTALLATION WITH VERTICAL TERMINATION (Rigid Vent Systems)

Note: A clearance of 2"(51mm) must be maintained; except when passing through a wall, ceiling, or at the termination where the use of a firestop or wall thimble reduces the required clearance to 1-1/2" (38mm). We recommend framing a 11"(279mm) x 11"(279mm) (inside dimensions) hole to give structural rigidity for mounting the termination.

- 1) Maintain the 2" (51mm) clearances (air spaces) to combustibles when passing through ceilings, walls, roofs, enclosures, attic rafter, or other nearby combustible surfaces. Do not pack air spaces with insulation. Check "Venting Arrangement - Vertical Termination" section for the maximum vertical rise of the venting system and the maximum horizontal offset limitations.

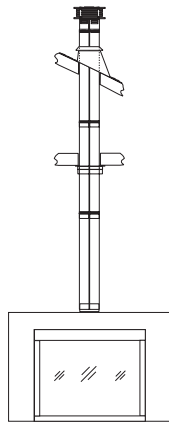

Diagram 1

- 2) Set the gas appliance in its desired location. Drop a plumb bob from the ceiling to the position of the appliance flue exit, and mark the location where the vent will penetrate the ceiling. Drill a small hole at his point. Next, drop a plumb bob from the roof to the hole previously drilled in the ceiling, and mark the spot where the vent will penetrate the roof. Determine if ceiling joists, roof rafters or other framing will obstruct the venting system. You may wish to relocate the appliance or to offset, as shown in Diagram 2 to avoid cutting load bearing members.

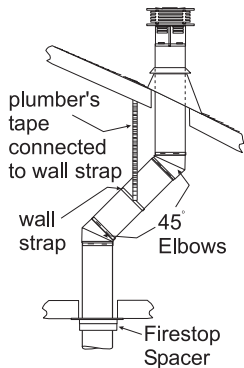

Diagram 2

- 3) A Firestop spacer must be installed in the floor or ceiling of every level.

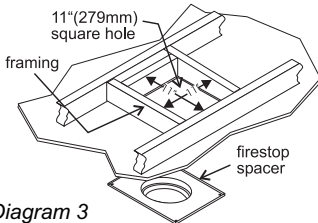
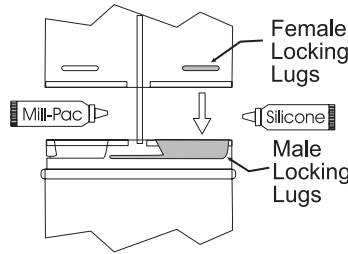

Diagram 3

- 4) Assemble the desired lengths of pipe and elbows. Ensure that all pipes and elbow connections are in the fully twist-locked position and sealed.

Note: For best results and optimum performance with each approved venting system, it is highly recommended to apply "Mill-Pac" sealant (supplied) to every inner pipe connection. Failure to do so may result in drafting or performance issues not covered under warranty. Silicone (red RTV) is optional.



- 5) Cut a hole in the roof centered on the small drilled hole placed in the roof in Step 2. The hole should be of sufficient size to meet the minimum requirements for clearance to combustibles of 1-1/2"(38mm). Slip the flashing under the shingles (shingles should overlap half the flashing) as per Diagram 4.

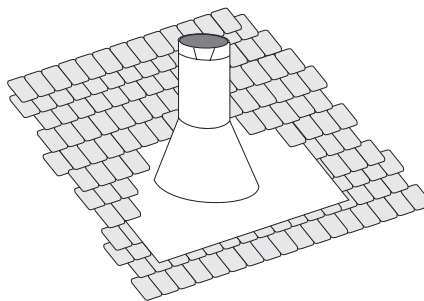

Diagram 4: The upper half of the flashing is installed under the roofing material and not nailed down until the chimney is installed. This allows for small adjustments.

- 6) Continue to assemble pipe lengths.

Note: If an offset is necessary in the attic to avoid obstructions, it is important to support the vent pipe every 3 feet (0.9 meter), to avoid excessive stress on the elbows, and possible separation. Wall straps are available for this purpose (Diagram 2).

Galvanized pipe is desirable above the roofline due to its higher corrosion resistance. Continue to add pipe sections through the flashing until the height of the vent cap meets the minimum height requirements specified in Diagram 5 or local codes. Note that for steep roof pitches, the vertical height must be increased.

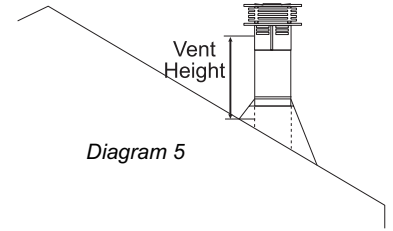

Diagram 5

Roof Pitch	Minimum Vent Height	
	Feet	Meters
flat to 7/12	2	0.61
over 7/12 to 8/12	2	0.61
over 8/12 to 9/12	2	0.61
over 9/12 to 10/12	2.5	0.76
over 10/12 to 11/12	3.25	0.99
over 11/12 to 12/12	4	1.22
over 12/12 to 14/12	5	1.52
over 14/12 to 16/12	6	1.83
over 16/12 to 18/12	7	2.13
over 18/12 to 20/12	7.5	2.29

A poor draft, or down drafting can result from high wind conditions near big trees or adjoining roof lines, in these cases, increasing the vent height may solve the problem.

- 7) Ensure vent is vertical and secure the base of the flashing to the roof with roofing nails, slide storm collar over the pipe section and seal with a mastic.
- 8) Install the vertical termination cap by twist-locking it.

Note: Any closets or storage spaces, which the vent passes through must be enclosed.

Offset Chart

GS 8"(203mm) Nominal Diameter ID					
Offset		Pipe Length (L)		Height	
inches	mm	inches	mm	inches	mm
4 3/4	121	0	0	13 1/4	337
9	229	6	152	17 1/2	445
11 1/4	286	9	229	19 1/2	495
13 1/4	337	12	305	21 3/4	552
21 3/4	552	24	610	30 1/4	768
30 1/4	768	36	914	39	991
38	965	48	1219	47	1194

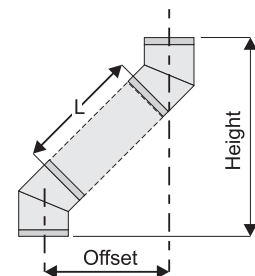

UNIT INSTALLATION HORIZONTAL TERMINATION WITH FLEX VENT SYSTEM

Note: A top clearance of 3"(76mm) and side & bottom clearance of 2"(51mm) must be maintained; except when passing through a wall, ceiling, or at the termination where the use of a firestop or wall thimble reduces the required clearance to 1-1/2" (38mm). We recommend framing a 11"(279mm) x 11"(279mm) (inside dimensions) hole to give structural rigidity for mounting the termination.

- 1) Locate the unit in the framing, rough in the gas (preferably on the right side of the unit) and the electrical (Junction block is on the left side) on the left. Locate the centerline of the termination and mark wall accordingly. Cut an 11"(279mm) hole in the wall (inside dimension).

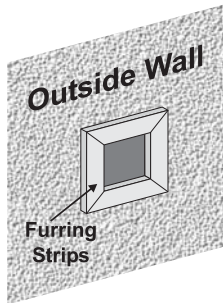

Note: If installing termination on a siding covered wall, a vinyl siding standoff or vinyl furring strips must be used to ensure that the termination is not recessed into the siding.

- 2) Level the fireplace and fasten it to the framing using nails or screws through the nailing strips.
- 3) Assemble the vent assembly by applying Mill Pac to the 5"(127mm) inner collar of the termination and slipping the 5"(127mm) liner over it at least 1-3/8" (35mm). Fasten with the 3 screws (drilling pilot holes will make this easier). Apply Mill Pac or high temperature silicone to the 8"(203mm) flex pipe and slip it over the 8" outer collar of the vent terminal at least 1-3/8"(35mm) and fasten with the 3 screws.

NOTE: Horizontal sections must be supported at intervals not exceeding 3 feet (0.9 meter). (Flame picture and performance will be affected by sags in the liner).

- 4) Separate the 2 halves of the wall thimble and securely fasten the one with the tabs to the outside wall making sure that the tabs are on top and bottom. Fasten the other thimble half to the inside wall. The thimble halves slip inside each other and can be adjusted for 2 x 4 or 2 x 6 walls.
- 5) Slip the assembled liner and termination assembly through the thimble making sure the termination cap faces up (there are markings on the cap that show which way is up). This will position the termination cap with proper down slope for draining water. Fasten the cap to the outer wall with the 4 supplied screws.
- 6) Pull the centre 5"(127mm) liner and outer 8"(203mm) liner out enough to slip over the flue collars of the fireplace. (You may wish to cut the liner shorter to make it more workable.) Do not bend liner more than 90°. **The liners must slip over the collars a minimum of 1-3/8".**
- 7) Apply Mill Pac over the fireplace inner collar and slip the 5"(127mm) liner down over it and attach with 3 supplied screws.
- 8) Do the same with the 8"(203mm) liner.
- 9) Apply a bead of silicone between the thimble and termination and around the outer edge of the terminal at the wall in order to keep the water out.

IMPORTANT: Do not locate termination hood where excessive snow or ice buildup may occur. Be sure to check vent termination area after snow falls, and clear to prevent accidental blockage of venting system. When using snow blowers, make sure snow is not directed towards vent termination area.

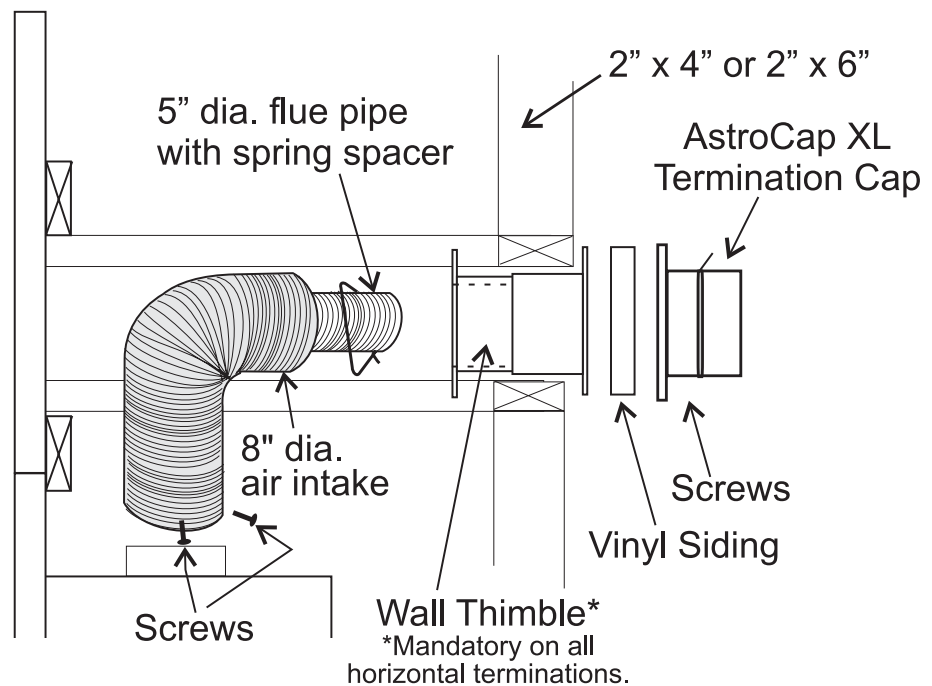
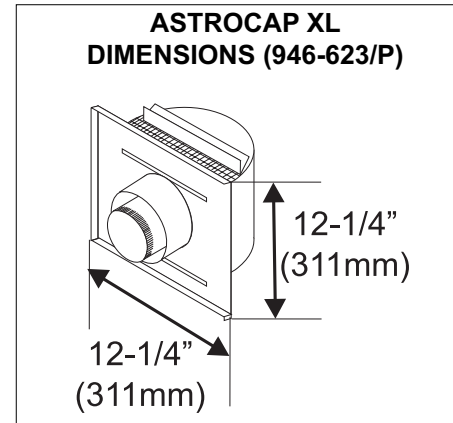

INSTALLATION

L900-NG SYSTEM DATA	
Min. Supply Pressure	5" WC (1.25 kpa)
Low Setting Man. Pressure	1.6" WC (0.39 kpa)
Max. Manifold Pressure	3.5" WC (0.87 kpa)
Orifice Size (Front Burner)	#47 DMS
Orifice Size (Back Burner)	#30 DMS
Minimum Input	11,000 Btu/h (3.22 kW)
Maximum Input	48,000 Btu/h (12.3 kW)
L900-LP SYSTEM DATA	
Min. Supply Pressure	12" WC (2.98 kpa)
Low Setting Man. Pressure	3.6" WC (2.49 kpa)
Max. Manifold Pressure	10" WC (2.98 kpa)
Orifice Size (Front Burner)	#56 DMS
Orifice Size (Back Burner)	#50 DMS
Minimum Input	9,500 Btu/h (2.64 kW)
Maximum Input	46,500 Btu/h (11.72 kW)

IMPORTANT: Always check for gas leaks with a soap and water solution or gas leak detector. Do not use open flame for leak testing.

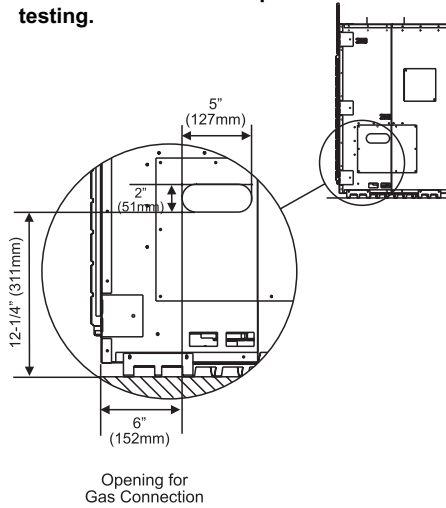

PILOT ADJUSTMENT

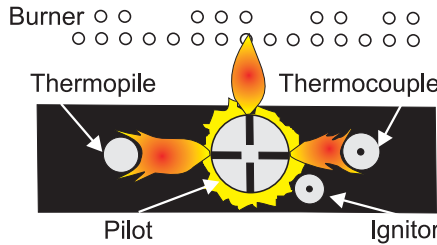

Periodically check the pilot flames. Correct flame pattern has three strong blue flames: 1 flowing around the thermopile, 1 around the thermocouple and 1 flowing across the burner (it does not have to be touching the burner).

Note: If you have an incorrect flame pattern, contact your Regency® dealer for further instructions.

Incorrect flame pattern will have small, probably yellow flames, not coming into proper contact with the rear burner or thermopile or thermocouple.

GAS PIPE PRESSURE TESTING

The appliance must be isolated from the gas supply piping system by closing its individual manual shut-off valve during any pressure testing of the gas supply piping system at test pressures equal to or less than 1/2 psig. (3.45 kPa). Disconnect piping from valve at pressures over 1/2 psig.

The manifold pressure is controlled by a regulator built into the gas control, and should be checked at the pressure test point.

Note: To properly check gas pressure, both inlet and manifold pressures should be checked using the valve pressure ports on the valve.

- 1) Make sure the valve is in the "OFF" position.
- 2) Loosen the "IN" and/or "OUT" pressure tap(s), turning counterclockwise with a 1/8" wide flat screwdriver.
- 3) Attach manometer to "IN" and/or "OUT" pressure tap(s) using a 5/16" ID hose.
- 4) Light the pilot and turn the valve to "ON" position.
- 5) The pressure check should be carried out with the unit burning and the setting should be within the limits specified on the safety label.
- 6) When finished reading manometer, turn off the gas valve, disconnect the hose and tighten the screw (clockwise) with a 1/8" flat screwdriver. **Note: Screw should be snug, but do not over tighten.**

SIT 825 VALVE DESCRIPTION

- 1) Gas on/off knob
- 2) Electronically Operated Hi/Lo
- 3) Pilot Adjustment
- 4) Thermocouple Connection - option
- 5) Outlet Pressure Tap
- 6) Inlet Pressure Tap
- 7) Pilot Outlet
- 8) Main Gas Outlet
- 9) Alternative TC Connection Point

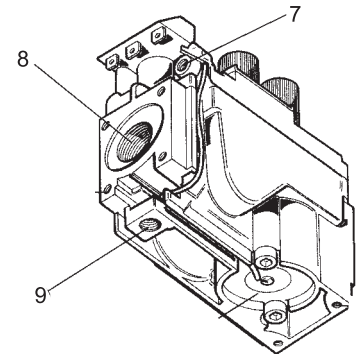
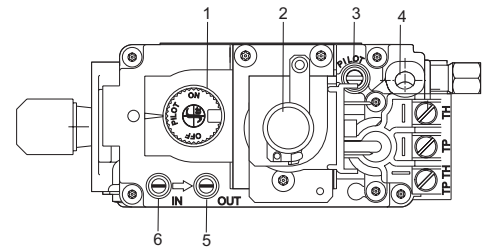

HIGH ELEVATION

This unit is approved in Canada for altitude 0 to 4500 ft. (CAN1 2.17-M91).

GAS LINE INSTALLATION

Since some municipalities have additional local codes it is always best to consult with your local authorities and the CAN/CGA B149 installation code.

For USA installations follow local codes and/or the current National Fuel Gas Code, ANSI Z223.1.

When using copper or flex connectors use only approved fittings. Always provide a union so that gas lines can be easily disconnected for servicing. Flare nuts for copper lines and flex connectors are usually considered to meet this requirement.

BACK-UP BATTERY INSTALLATION (within Power Module)

*The 9V battery operates the rear burner under power outage conditions.
The AA battery operates the DC Sparker for lighting the pilot.*

- 1) Remove the glass door.

- a. Release the 2 door latches on the left and right side at the top of the firebox.



Latch Location

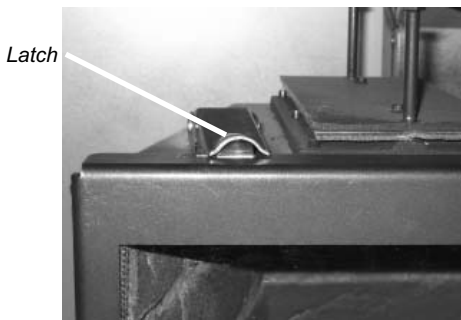

- b. Swing the door out from the top and release the hinges on the left and right side of the door by lifting them up.

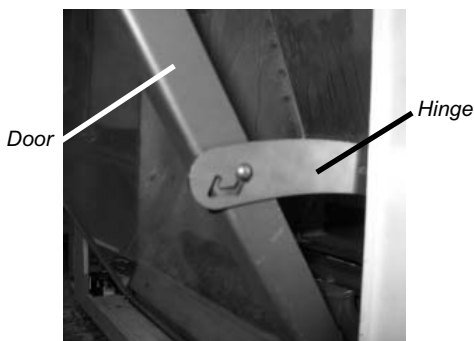

- c. Place the door on a soft surface to prevent scratching.

- 2) Loosen the 2 screws that hold the left side heat shield in place.

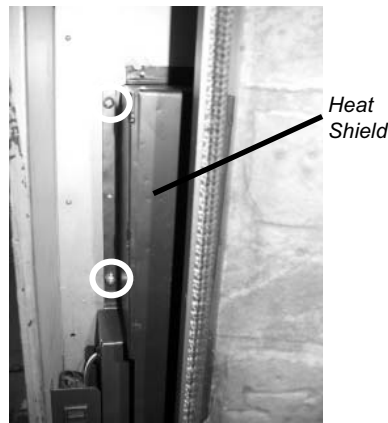

- 3) Lift up and pull out the heat shield slightly to clear the screwheads and then hang it on the top bracket (located directly above the heat shield).

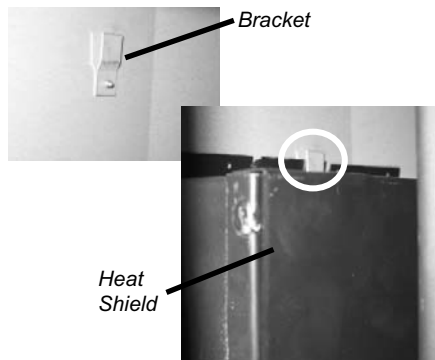

- 4) Unplug the power source.

- 5) Loosen the bottom screw and remove the top screw from the power module.

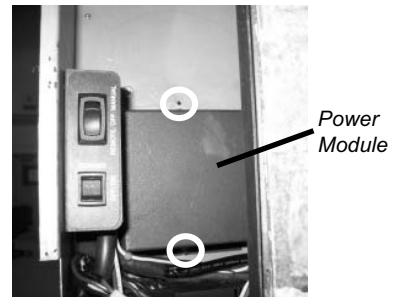

- 6) Cut the cable tie that holds together the wires for the power module and the pull out the power module.

- 7) Remove the power module cover by removing the 2 screws, one on each side.



- 8) Install the 9V battery and the AA battery.

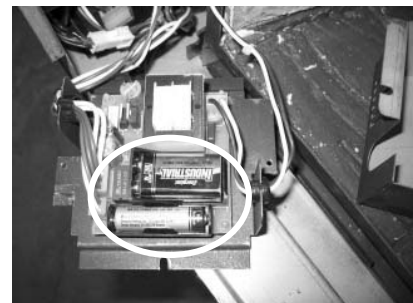

- 9) Reverse steps 7 to 1.

INSTALLATION

CONVERSION KIT #546-969 FROM NG TO LP

LP Conversion instructions for BEFORE UNIT INSTALLATION.

THIS CONVERSION MUST BE DONE BY A QUALIFIED GAS FITTER, IF IN DOUBT DO NOT DO THIS CONVERSION!!

LP Conversion Kit Contains:

Qty.	Part #	Description
1	910-462	LP Conversion Coil
1	904-573	Cable Tie
1	910-037	LP Pilot Orifice
1	904-641	Orifice #50 (back)
1	904-241	Orifice #56 (front)
1	904-529	Allen Key
1	918-590	LP Conversion Decal
1	908-528	Red Propane Label
1	918-608	Instruction Sheet

1) Remove the glass door.

- a. Release the 2 door latches on the left and right side at the top of the firebox.



Latch Location

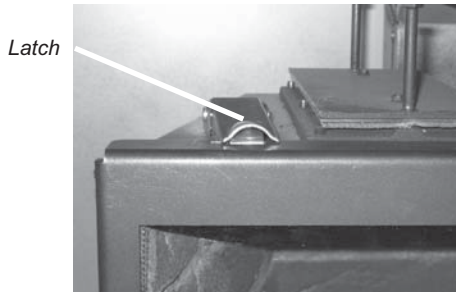

- b. Swing the door out from the top and release the hinges on the left and right side of the door by lifting them up.

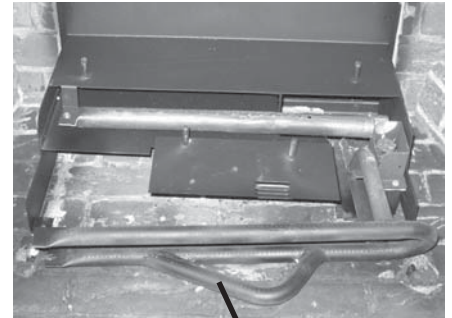

Front Burner Removed

- c. Place the door on a soft surface to prevent scratching.

2) Remove the grate by undoing the 2 screws on the right and left side.

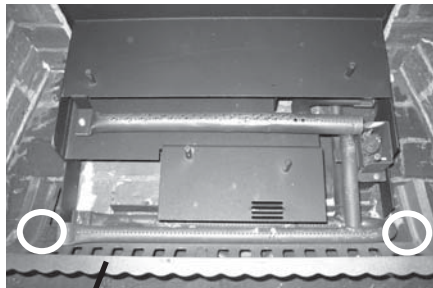

Grate

4) Remove the back burner by removing the screw.

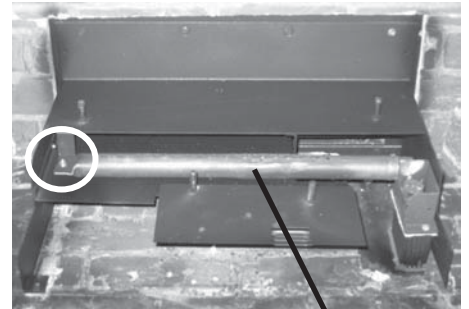

Back Burner

3) Remove the front burner by removing the screw.

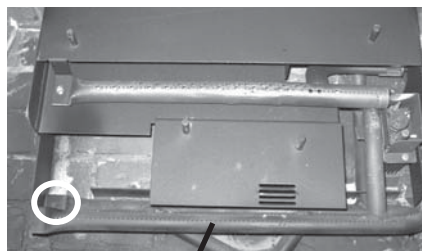

Front Burner

5) Remove the rear log stand by removing the 4 screws.

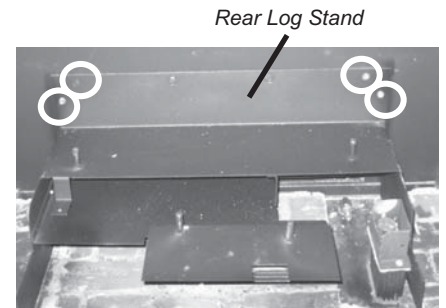

Rear Log Stand

- 6) Replace the front burner orifice with orifice #56. See image below. Use another wrench to hold onto the elbow behind the orifice.
- 7) Replace the back burner orifice with orifice #50. See image below. Use another wrench to hold onto the elbow behind the orifice.

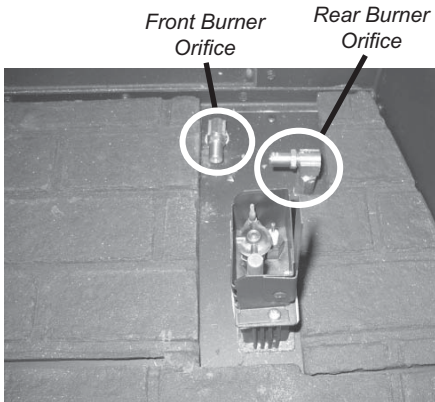

- 10) Remove the NG pilot orifice with the Allen Key and replace with LP pilot orifice.

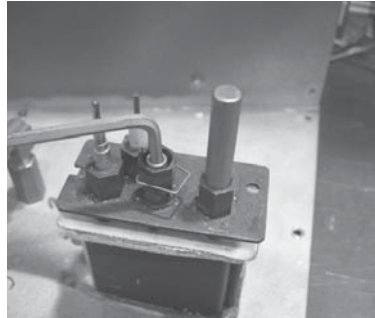

- 14) Disconnect the 2 grey connectors from the modulator coil.

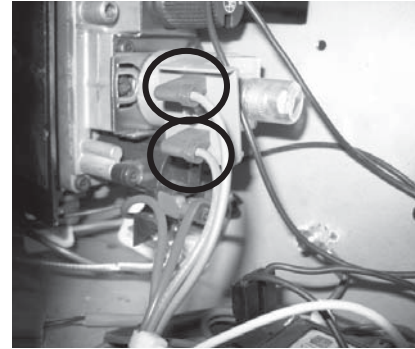

- 11) Re-install the pilot head and pilot shield.

- 12) Loosen the 2 screws that hold the right side heat shield.



- 15) Remove the right side panel by undoing the 9 screws.

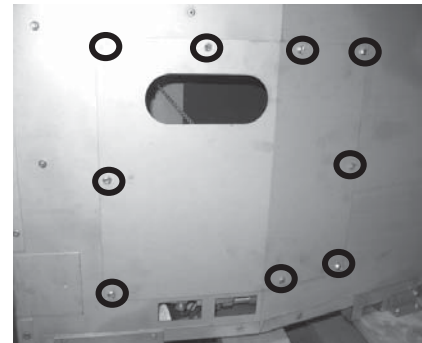

- 8) Remove the pilot shield by removing the 2 screws.

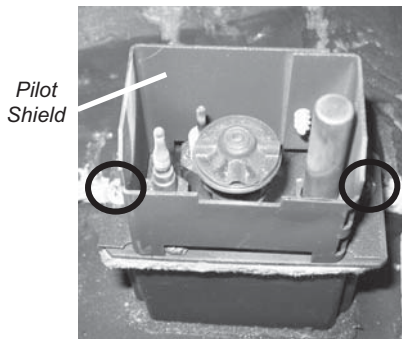

- 13) Lift up and pull out the heat shield slightly to clear the head screws and then hang it on the top bracket (located directly above the heat shield).

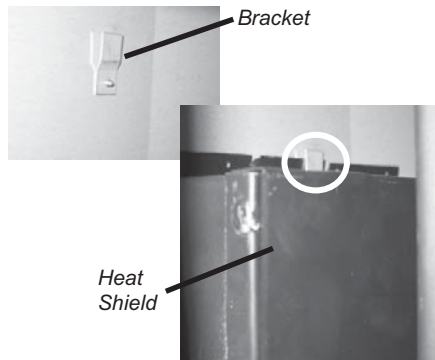

- 16) Using a Torx T20, remove and discard the 3 pressure regulator mounting screws. Remove the modulator coil and the gasket.

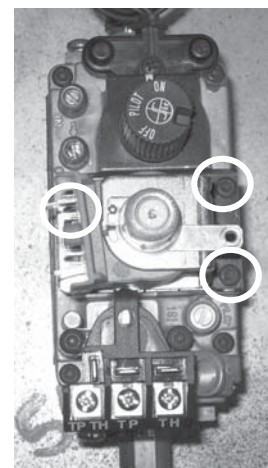

- 9) Remove the clip from the pilot head assembly using a flat head screw driver.

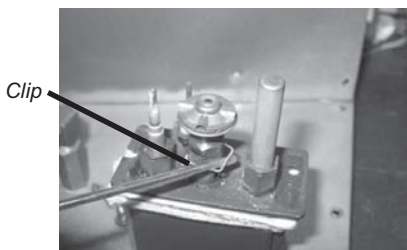

INSTALLATION

- 17) Ensure that the new rubber gasket (supplied with coil) is properly positioned and install the new modulating pressure regulator assembly to the valve using the screws supplied with the kit. Tighten screws securely.
- 18) Install the enclosed identification label to the valve body where it can be easily seen.
- 19) **Attach the LP conversion decal near or on top of the serial no. decal.**
- 20) Replace yellow "Natural Gas" label with red "Propane" label.
- 21) Re-install the right side panel and all electrical connections to the valve. (2 grey wires to modulating coil.)
- 22) Remove the left side panel by undoing the 8 screws.

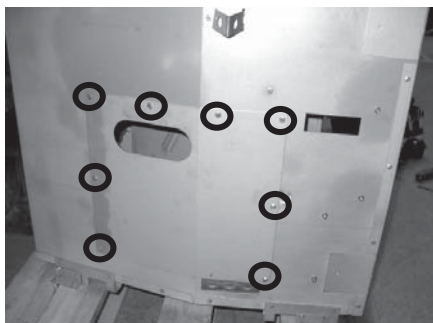

- 23) Locate the control box shown below and remove the J9 jumper using needle nose pliers.



J9 Jumper Location

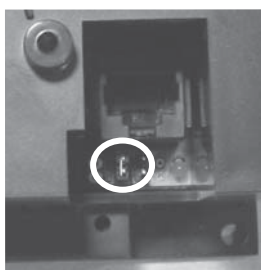

J9 Jumper

- 24) Re-install the left side panel.
- 25) Re-install the rear log support bracket.
- 26) Adjust the burner aeration settings to the LP settings and install the burners.

Front Burner	1/4"
Rear Burner	3/8"
- 27) Re-install the grate.
- 28) Re-install the glass door.
- 29) Re-install the right heat shield.
- 30) Continue with completing unit installation.

NOTE: Once the unit has been installed;

- a) Turn on the gas supply and check for gas leaks.
- b) Check the inlet and outlet pressures.
- c) Check operation of flame control using the remote control. Refer to FireWizard operation manual for details.
- d) Check for proper flame appearance.

Installer Notice:
This instructions must be left with the appliance.

LP Conversion instructions for when unit is ALREADY INSTALLED.

THIS CONVERSION MUST BE DONE BY A QUALIFIED GAS FITTER, IF IN DOUBT DO NOT DO THIS CONVERSION!!

LP Conversion Kit Contains:

Qty.	Part #	Description
1	910-462	LP Conversion Coil
1	904-573	Cable Tie
1	910-037	LP Pilot Orifice
1	904-641	Orifice #50 (back)
1	904-241	Orifice #56 (front)
1	904-529	Allen Key
1	918-590	LP Conversion Decal
1	908-528	Red Propane Label
1	918-608	Instruction Sheet

- 1) Turn control knob to the OFF position and shut off the gas supply to the valve.
- 2) Remove exterior brick panels, if installed.
- 3) Remove the glass door.
 - a. Release the 2 door latches on the left and right side at the top of the firebox.

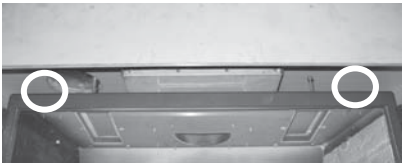

Latch Location

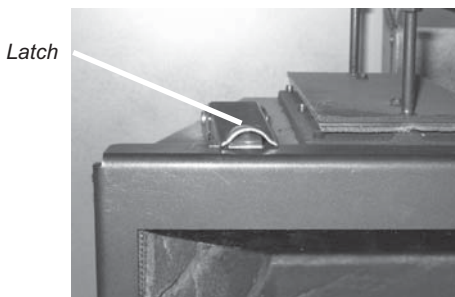

- b. Swing the door out from the top and release the hinges on the left and right side of the door by lifting them up.

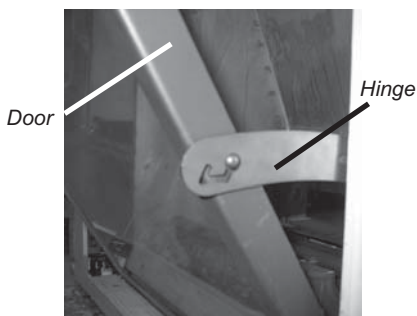

- c. Place the door on a soft surface to prevent scratching.

- 4) Loosen the 2 screws that hold the left side heat shield in place.

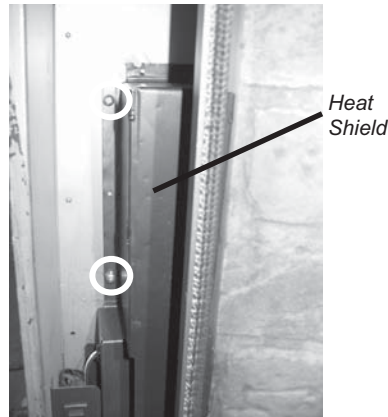

- 5) Lift up and pull out the heat shield slightly to clear the screwheads and then hang it on the top bracket (located directly above the heat shield).

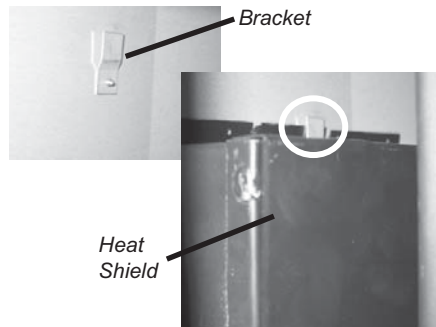

- 6) Unplug the power source.

- 7) Remove the log set, if installed.

- 8) Remove interior brick panels, if installed.

- 9) Remove the grate by undoing the 2 screws on the right and left side.

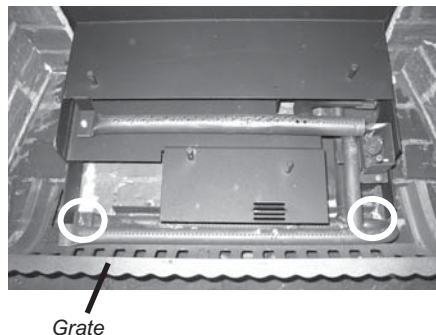

- 10) Remove the front burner by removing the screw.

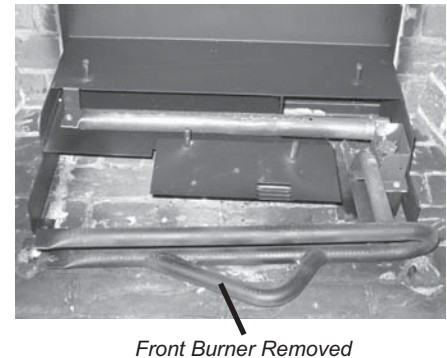
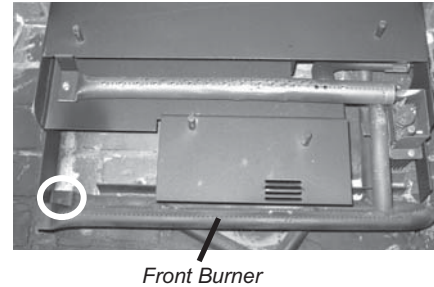

- 11) Remove the back burner by removing the screw.

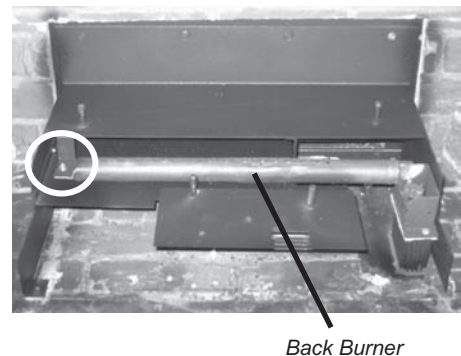

- 12) Remove the rear log stand by removing the 4 screws.

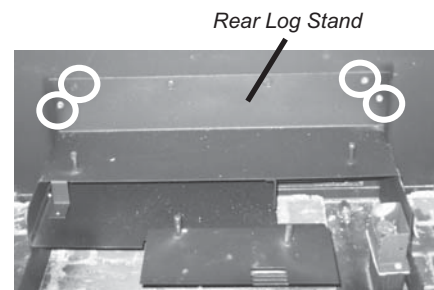

INSTALLATION

13) Carefully remove the bottom brick panel.

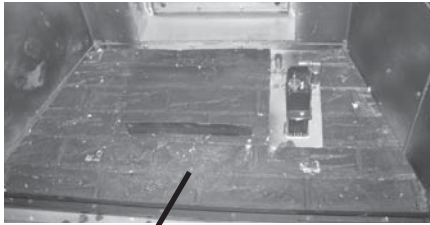

Bottom Brick Panel

14) Loosen the 2 screws that hold the right side heat shield.

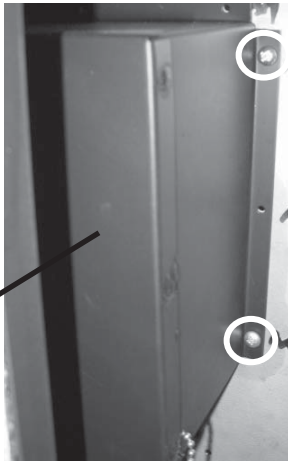

Heat Shield

15) Lift up and pull out the heat shield slightly to clear the head screws and then hang it on the top bracket (located directly above the heat shield).

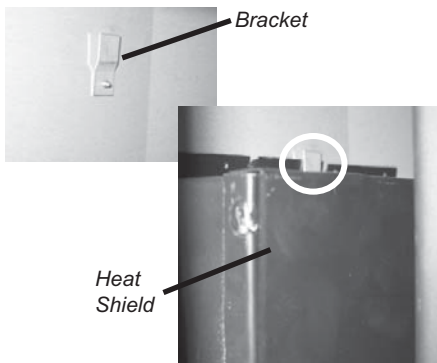

Bracket

Heat Shield

16) Disconnect the inlet gas line from the valve.

17) Disconnect the 2 connectors from the modulating coil.

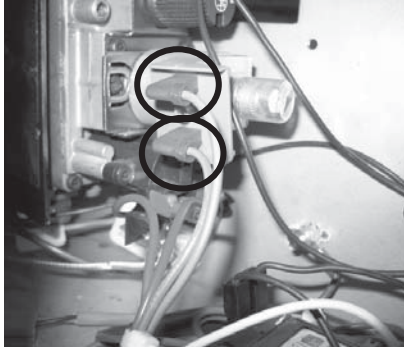

18) Remove the DC Sparker wires; 1 wire for the ignitor and 2 wires to the module box.

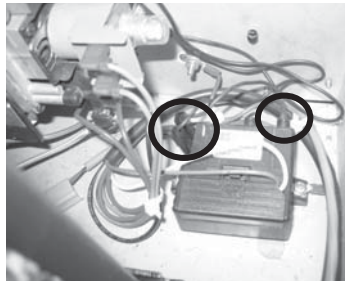

19) Remove the 16 screws that hold the valve tray to the firebox and slightly pull out the valve tray.

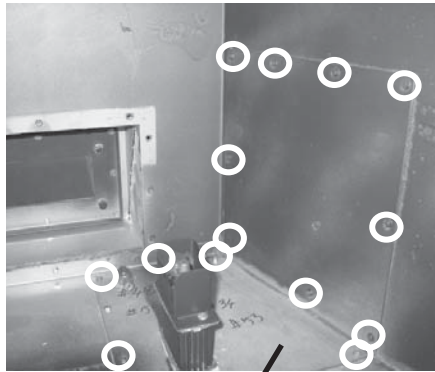

Valve Tray

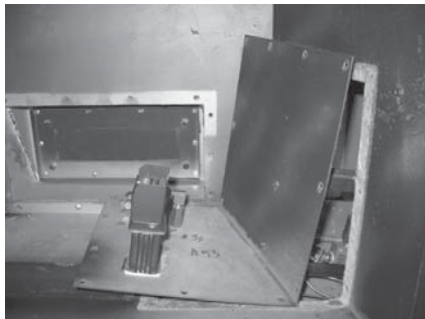

Valve Tray Slightly Removed

20) Disconnect the black and red wires from the solenoid valve.



21) Disconnect the 2 red wires and 1 black wire from the valve.

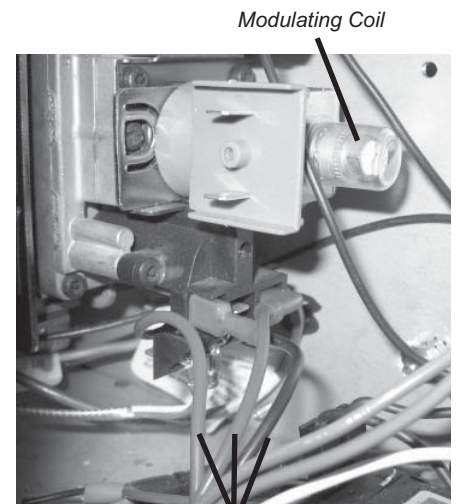

Modulating Coil

Wires

22) Completely pull out the valve tray.

23) Replace the front burner orifice with orifice #56. See image below. Use another wrench to hold onto the elbow behind the orifice.

24) Replace the back burner orifice with orifice #50. See image below. Use another wrench to hold onto the elbow behind the orifice.

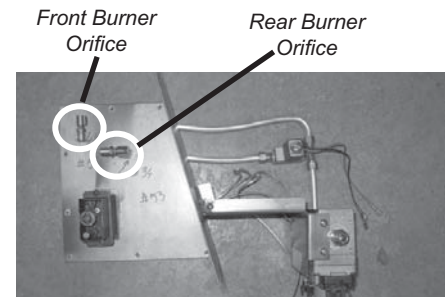

Front Burner Orifice

Rear Burner Orifice

- 25) Remove the pilot shield by removing the 2 screws.

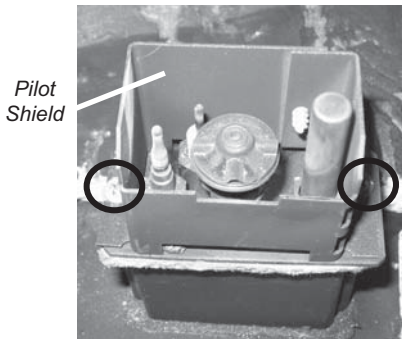

- 26) Remove the clip from the pilot head assembly using a flat head screw driver.

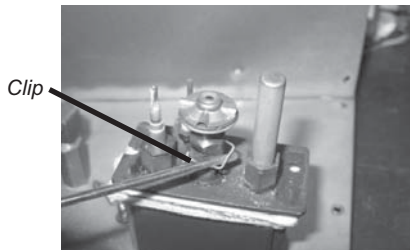

- 27) Remove the NG pilot orifice with the Allen Key and replace with LP pilot orifice.

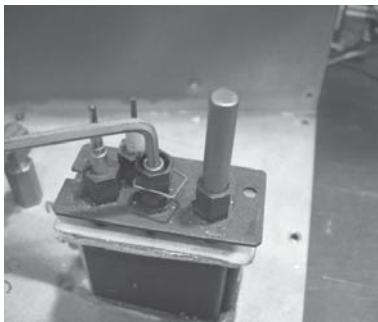

- 28) Re-install the pilot head and pilot shield.

- 29) Using a Torx T20, remove and discard the 3 pressure regulator mounting screws. Remove the modulator coil and the gasket.

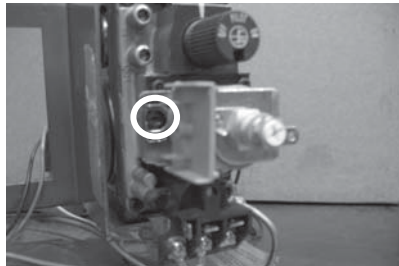
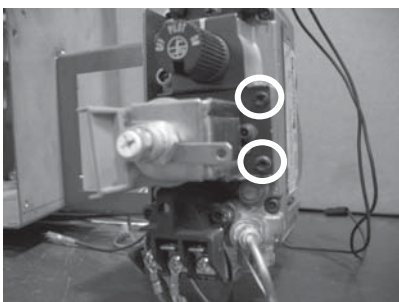

- 30) Ensure that the new rubber gasket (supplied with coil) is properly positioned and install the new modulating pressure regulator assembly to the valve using the screws supplied with the kit. Tighten screws securely.

- 31) Install the enclosed identification label to the valve body where it can be easily seen.

- 32) **Attach the LP conversion decal near or on top of the serial no. decal.**

- 33) Replace yellow "Natural Gas" label with red "Propane" label.

- 34) Re-install valve tray and all electrical connections to the valve and solenoid valve.

- 35) Cut the cable tie that holds the wires connected to the Control Module and pull out.

Note: An extra cable tie is included with the LP Kit for re-installation.

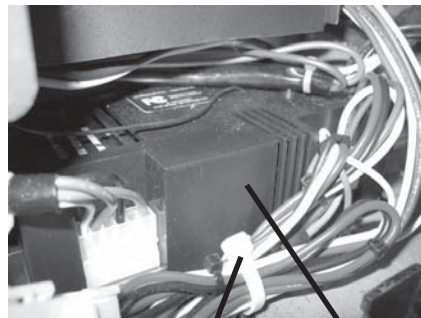

- 36) Remove the J9 jumper using needle nose pliers.

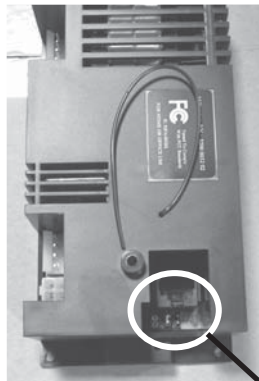

J9 Jumper Location

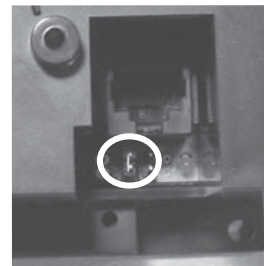

J9 Jumper

- 37) Re-install the control module.

- 38) Re-install the base brick panel.

- 39) Re-install the rear log support bracket.

- 40) Plug in the power source.

- 41) Re-install the left heat shield.

- 42) Install the interior brick panels.

- 43) Adjust the burner aeration settings to the LP settings and install the burners.

Front Burner	1/4"
Rear Burner	3/8"

- 44) Re-install the grate.

- 45) Turn on the gas supply and check for gas leaks.

- 46) Install the log set.

- 47) Re-install the glass door.

- 48) Check the inlet and outlet pressures.

- 49) Re-install the right heat shield.

- 50) Check operation of flame control using the remote control. Refer to FireWizard operation manual for details.

- 51) Check for proper flame appearance.

- 52) Install the exterior brick panels.

Installer Notice:
This instructions must be left with the appliance.

INSTALLATION

BRICK PANEL INSTALLATION

IMPORTANT: Must install 1 set of brick panels. The operation of this unit without the brick panels is prohibited.

**Dangerous operating conditions may occur if the panels are broken.
Handle with care. DO NOT FORCE INTO POSITION.**

Interior Brick Panel Installation:

1) Remove the glass door.

a. Release the 2 door latches on the left and right side at the top of the firebox.



Latch Location

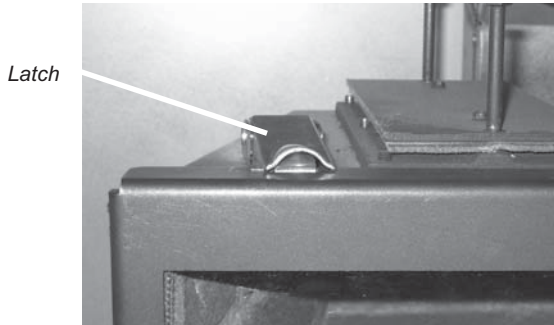

b. Swing the door out from the top and release the hinges on the left and right side of the door by lifting them up.

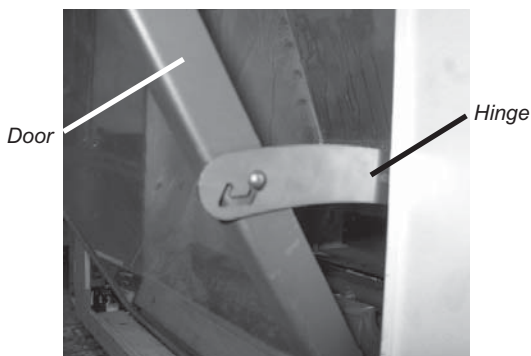

c. Place the door on a soft surface to prevent scratching.

2) Unwrap the brick panels from the protective wrapping.

Note: The logs must not be in the unit.

3) Remove the 2 brick panel clips on the inside left and right side of the firebox by removing the screw.

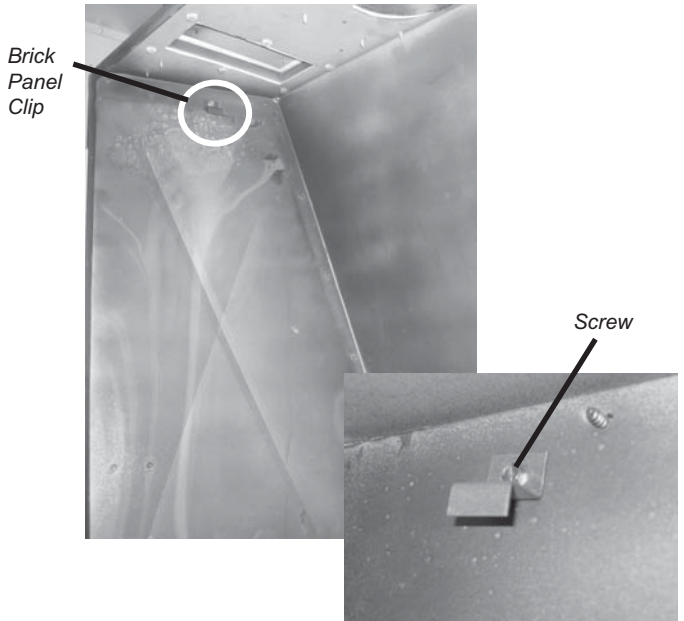

4) Place the 2 small back brick panels at the base of the firebox on the left and right side of the rear log tray.

Note: The left and right side back brick panels are different.

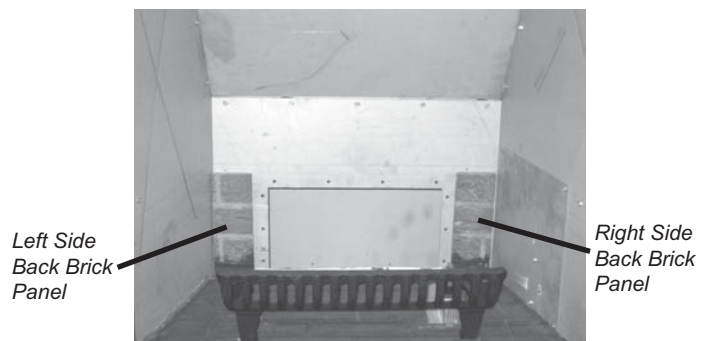
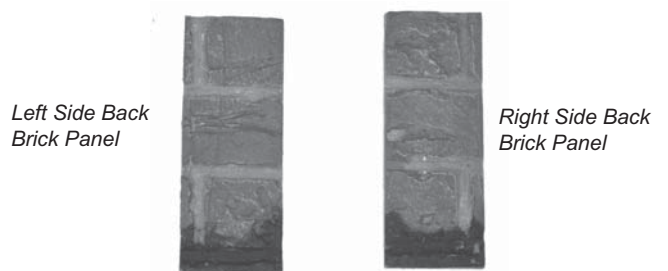

- 5) Install the back brick panel by carefully placing it against the back wall of the firebox.

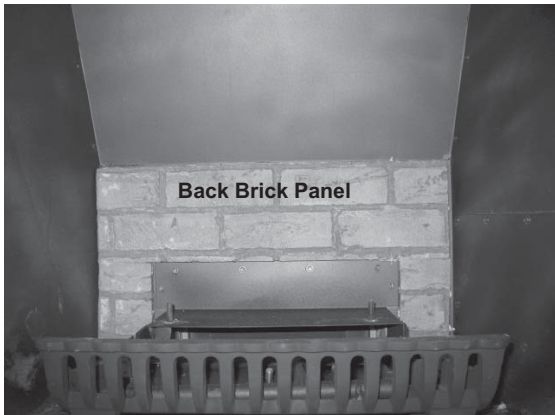

- 6) Place the top brick panel into position and hold it in place while sliding the right side brick panel into position and secure using the brick panel clip that was removed in step 3.

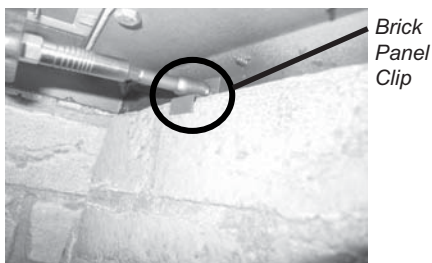
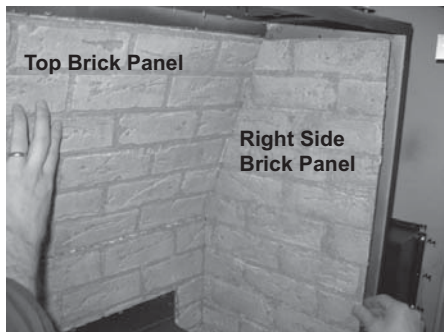
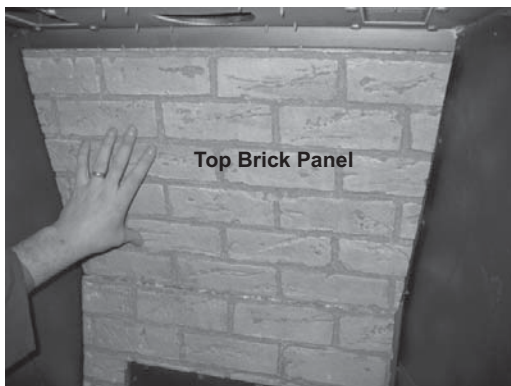

- 7) Slide the left side brick panel into position and secure in place with the brick panel clip that was removed in step 3.

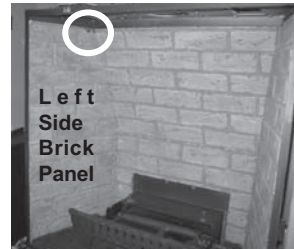

Exterior Brick Panel Installation:

- 1) Ensure installation of the logs and glass door has been completed before installing the exterior brick panels.
- 2) Line up the pins in the exterior base brick panel with the holes on the outerbox of the firebox and fit in place.

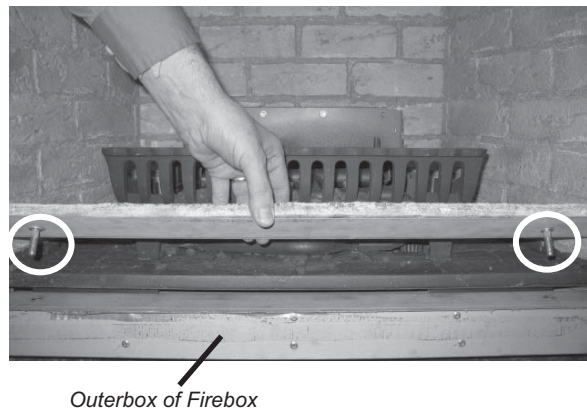

- 3) Install the right side exterior brick panel by placing the bottom tab into the slot of the exterior base brick panel.

The top of the brick panel is held in place by a magnet that sits against the bracket as shown in the image below.

Repeat for left side exterior brick panel.

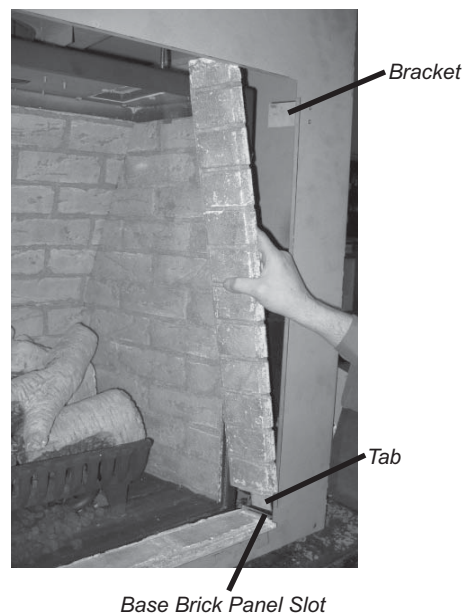

INSTALLATION

LOG SET INSTALLATION

Installation of Interior Brick Panels must be completed before installing the log set.

Read the instructions below carefully and refer to the diagrams. If the logs are broken do not use the unit until they are replaced. Broken logs can interfere with pilot operation.

Log kit (Part No. 546-930 and 546-935) contain the following pieces:

- a) 03-41 Log Rear
- b) 03-42 Log Front Left
- c) 03-43 Log Front Right
- d) 03-44 Log Cross Left
- e) 03-45 Log Cross Right
- f) 902-154 Embers Lava
- g) 902-179 Vermiculite

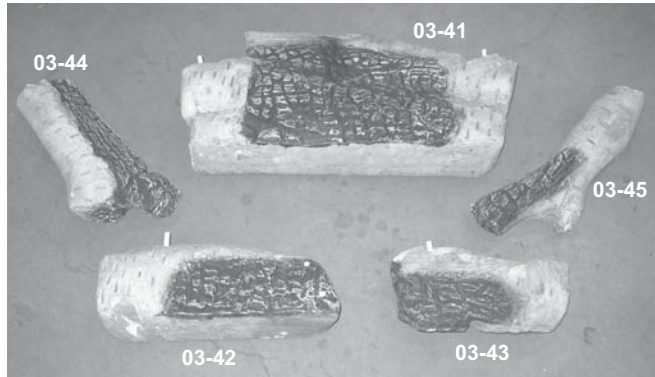

The "03" reference numbers (i.e. 03-41) are molded into the rear of each log.

- 1) Carefully remove the logs from the box and unwrap them. The logs are fragile, handle with care - **do not force into position**.
- 2) Place log 03-41 on the rear log support pins.

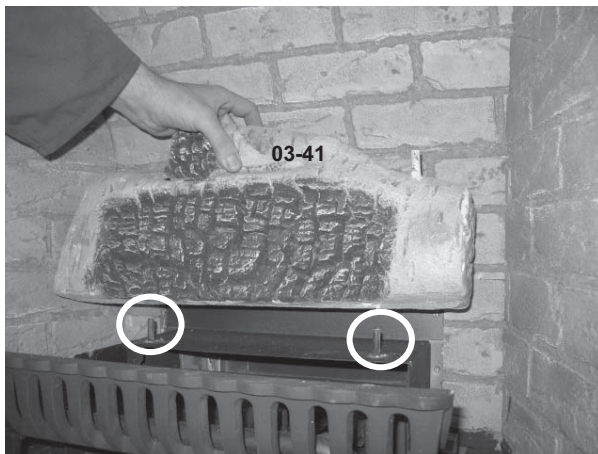

- 3) Place log 03-42 on the front left side of the burner. Place the right end of the log into the pin and rest the notch on the left end of the log on the grate.

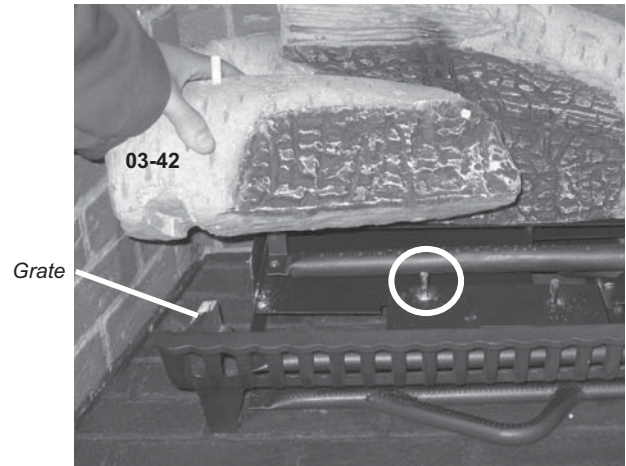

- 4) Spread some vermiculite on the front log tray next to log 03-42 as shown in the image below.

Note: Do not build up vermiculite as this will cause the next log (03-43) not to sit all the way down. Vermiculite is only needed to conceal the metal inbetween the left and right front logs.

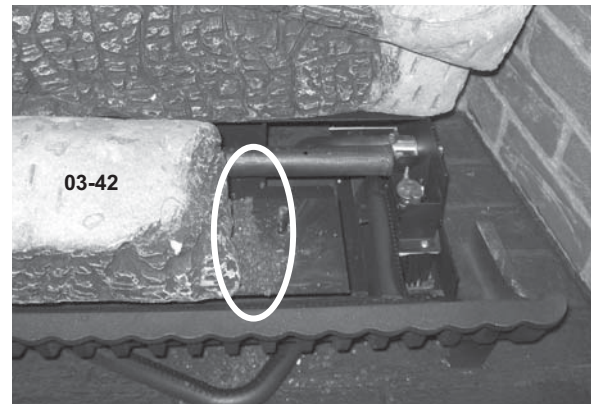

INSTALLATION

- 5) Place the left end of log 03-43 into the pin while fitting the notch onto the burner tube. Slide the right end of the log forward until it is approximately 3/8" away from the back side of the grate.

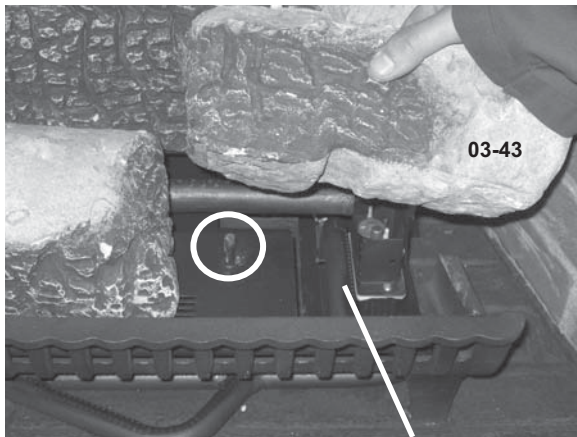

Burner Tube

- 8) Spread all of the Embers on the bottom brick panel around the burner tube and on the inside of the grate as shown.

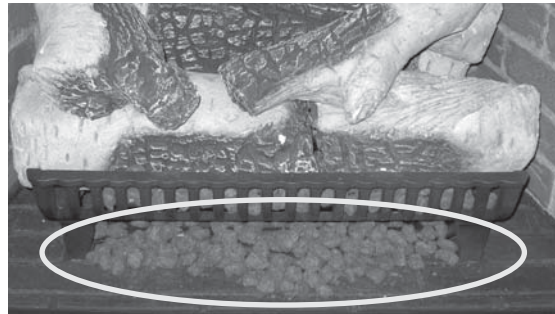

Embers on bottom brick panel.

- 6) Line up the two holes on the underside of log 03-44 with the pins on logs 03-41 and 03-42 and fit in place.

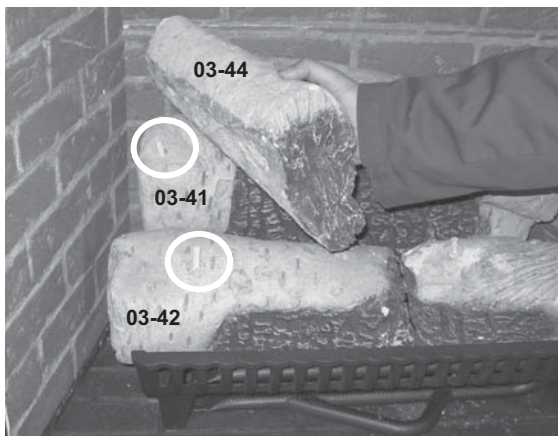

Embers on inside of grate.

- 9) Spread the vermiculite on the base brick panel covering the remaining exposed base brick.

- 7) Line up the two holes on the underside of log 03-45 with the pins on logs 03-41 and 03-43 and fit in place.

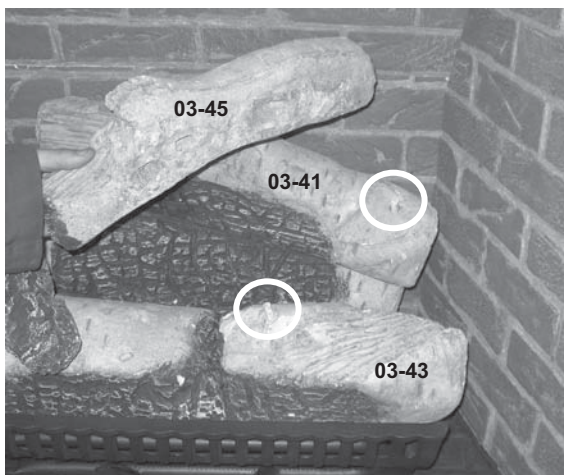

INSTALLATION

AERATION ADJUSTMENT

The burner aeration is factory set but may need adjusting due to either the local gas supply or altitude. Open the air shutter for a blue flame or close for a more yellow flame.

In order to adjust the aeration, the logs, grate and burners will need to be removed to be able to access the shutters.

Minimum Air Shutter Opening:

NG	Front Burner	1/4"
	Rear Burner	1/2"
LP	Front Burner	1/4"
	Rear Burner	3/8"

CAUTION: Carbon will be produced if air shutter is tightly closed.

Note: Any damage due to carboning resulting from improperly setting the aeration controls is **NOT** covered under warranty.

WIRING DIAGRAM

A receptacle is provided on the left hand side of the unit. 120 Volt AC power must be wired to the receptacle and the control module plugged in for the unit to operate fully. The front and rear burners will operate on low, when the unit is running on battery back-up.

(Do not cut the ground terminal off under any circumstances.)

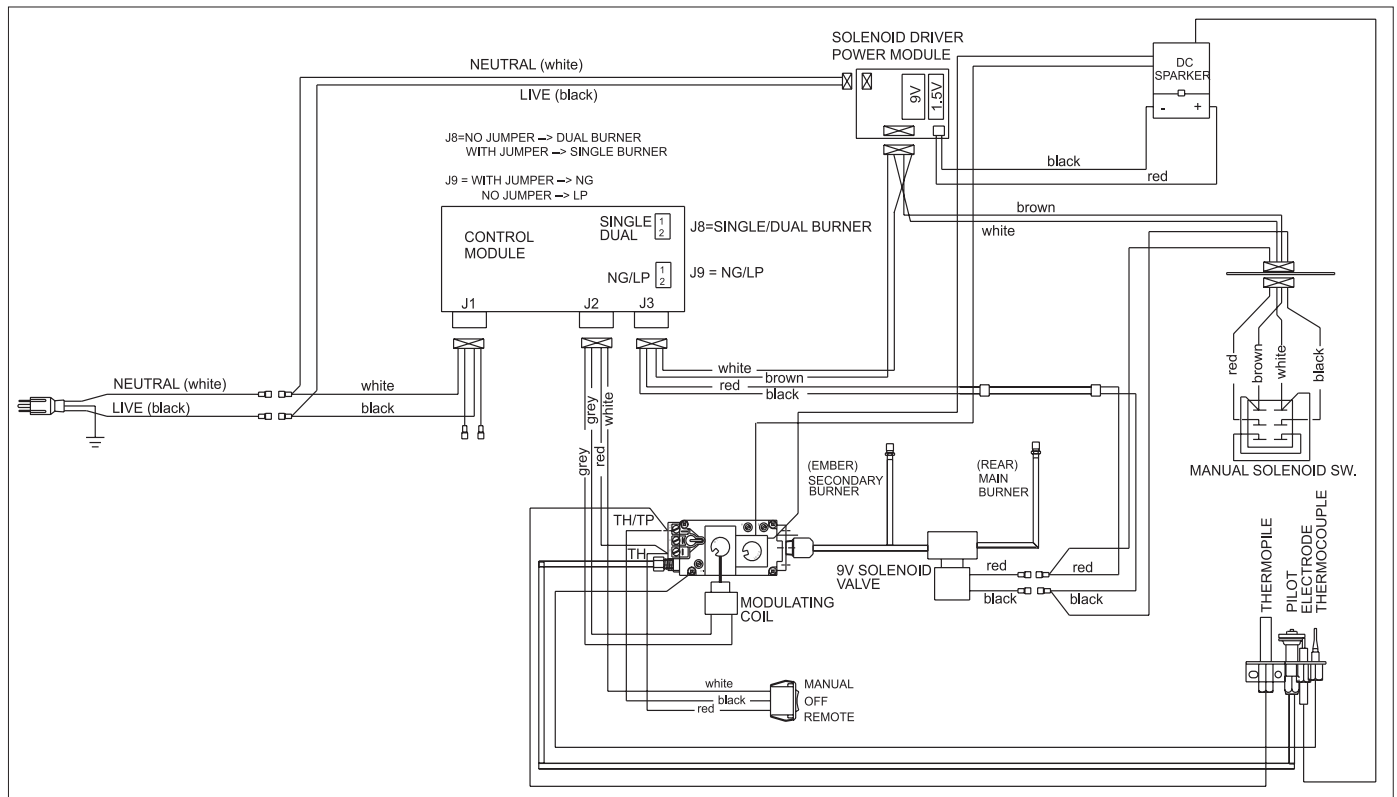

Caution: Ensure that the wires do not touch any hot surfaces and are away from sharp edges.

CAUTION: Label all wires prior to disconnection when servicing controls. Wiring errors can cause improper and dangerous operation.

OPERATING INSTRUCTIONS

MATCHING REMOTE HANDSET & CONTROL BOX ID CODE

The Remote Control Handset has a set of unique ID codes that is pre-programmed into its memory. This set of ID codes helps to differentiate one Remote Control Handset from another so that only the control box with a matching ID code will respond to the appropriate Remote Control Handset.

To ensure the remote control is matched to the receiver correctly, please follow the steps below:

1. Ensure that the Remote Control and the 3-way switch located at the appliance are both in the OFF position.
2. Ensure that the pilot is lit and the pilot control knob is in the ON position on the appliance.
3. Install the 2 x AAA alkaline batteries into the Remote Control.
4. Unplug and re-plug the power cord. The power cord is located on the left hand side of the appliance and will be plugged into the receptacle.
5. Switch the 3-way switch located on the appliance to the REMOTE position.
6. Press and hold the PROG and FAN buttons simultaneously for up to 20 seconds. During this time, the remote will display LC while it is transmitting codes to the receiver. Once it is successfully transmitted, one will hear the solenoid click and the burners will come on. If it does not work the first time, repeat steps 1 - 6.
7. Release both the PROG and FAN buttons. The remote will revert back to normal, but the burner will still be on.
8. Press the ON/OFF button on the remote control 2 times to turn the burner off.
9. The remote control is now programmed to the receiver and the appliance can now be operated with it.

The control box will only learn the Remote ID codes during the first 30 seconds after power is applied and will ignore this special command from the Remote after the first 30 seconds.

NOTE: This must only be performed by a qualified installer.

OPERATING INSTRUCTIONS

- 1) Read and understand these instructions before operating this appliance.
- 2) Check to see that all wiring is correct and enclosed to prevent possible shock.
- 3) Check to ensure there are no gas leaks.
- 4) Make sure the glass in the door frame is properly positioned. Never operate the appliance with the glass removed.
- 5) Verify that the venting and cap are unobstructed.
- 6) Ensure that the brick panels are installed.
- 7) Verify log placement. If the pilot cannot be seen when lighting the unit, the logs have been incorrectly positioned.
- 8) The unit should never be turned off, and on again without a minimum of a 60 second wait.

FIRST FIRE

The **FIRST FIRE** in your heater is part of the paint curing process. To ensure the paint is properly cured, it is recommended you burn your fireplace for at least four (4) hours the first time.

When first operated, the unit will release an odour caused by the curing of the paint and the burning off of any oils remaining from manufacturing. Smoke detectors in the house may go off at this time. Open a few windows to ventilate the room for a couple of hours. The glass may require cleaning.

NOTE: The main burner will always start on "HIGH" and resume it's last setting after 20 seconds of operation.

NOTE: When the glass is cold and the appliance is lit, it may cause condensation and fog the glass. This condensation is normal and will disappear in a few minutes as the glass heats up.

DO NOT BURN THE APPLIANCE WITHOUT THE GLASS FRONT IN PLACE.

DO NOT ATTEMPT TO CLEAN THE GLASS WHILE IT IS STILL HOT!

During the first few fires, a white film may develop on the glass front as part of the curing process. The glass should be cleaned after the unit has cooled down or the film will bake on and become very difficult to remove. Use a non-abrasive cleaner and **DO NOT ATTEMPT TO CLEAN THE GLASS WHILE IT IS HOT.**

LIGHTING PROCEDURE

IMPORTANT
To ignite or reignite the pilot, you must first remove the glass door.

Only when the pilot holds, without pressure being applied to the control knob, resecure the glass door to the unit. The unit **must not** be operated with the glass door removed.

IMPORTANT Gas on/off knob cannot be turned from "PILOT" to "OFF" unless it is partially depressed.

Ensure that the 3 way switch on the manual control panel is in the "Remote" position.

The manual control panel is located on the left hand side of the firebox behind the left side exterior brick panel.

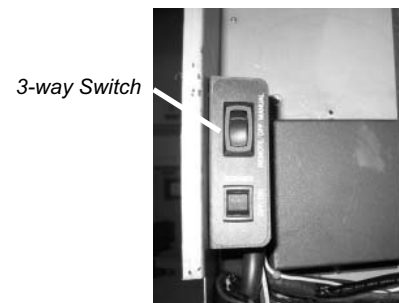

OPERATING INSTRUCTIONS

NOTE: The control knob is located on the right hand side of the firebox behind the right side exterior brick panel.

- 1) Push in gas control knob slightly and turn clockwise to "OFF". Knob cannot be turned from "PILOT" to "OFF" unless knob is pushed in slightly. Do not force.
- 2) Wait five (5) minutes to clear out any gas.
- 3) Turn knob on gas control counterclockwise to "PILOT".
- 4) Push in control knob all the way and hold in until the pilot lights up. Continue to hold the control knob in for about 20 seconds after the pilot is lit. Release knob and it will pop back up. Pilot should remain lit. If it goes out, repeat steps 1) to 4). If knob does not pop up when released, stop and immediately call your service technician or gas supplier. If the pilot will not stay lit after several tries, turn the gas control knob to "OFF" and call your service technician or gas supplier.
- 5) Turn gas control knob counterclockwise to "ON".
- 6) Turn the unit on with the remote.

NOTE: When using the remote control refer to the FireWizard manual for instructions.

SHUTDOWN PROCEDURE

- 1) Turn the 3-way switch to the "OFF" position.
- 2) Turn the main gas control clockwise to the "OFF" position to turn off the pilot.
- 3) Turn off all electric power to appliance if service is to be performed.

NORMAL OPERATING SOUNDS OF GAS APPLIANCES

It is possible that you will hear some sounds from your gas appliance. This is perfectly normal due to the fact that there are various gauges and types of steel used within your appliance. Listed below are some examples. All are **normal operating sounds** and should not be considered as defects in your appliance.

Burner Tray:

The burner tray is positioned directly under the burner tube and logs and is made of a different gauge material from the rest of the firebox and body. Therefore, the varying thicknesses of steel will expand and contract at slightly different rates which can cause "ticking" and "cracking" sounds. You should also be aware that as there are temperature changes within the unit these sounds will likely re-occur. Again, this is normal for steel fireboxes.

Pilot Flame:

While the pilot flame is on it can make a very slight "whisper" sound.

Gas Control Valve:

As the gas control valve turns ON and OFF, a dull clicking sound may be audible, this is normal operation of a gas regulator or valve.

Unit Body/Firebox:

Different types and thicknesses of steel will expand and contract at different rates resulting in some "cracking" and "ticking" sounds will be heard throughout the cycling process.

OPERATION DURING POWER OUTAGE

Important:

If the unit is not used for a prolonged period of time, we recommend turning the 3-way switch on the manual control panel to "Off" (manual control panel is located on the left hand side of the firebox behind the left side exterior brick panel).

Also see "Lighting Plate Instructions" for details on how to turn off the pilot.

Manual Control Panel

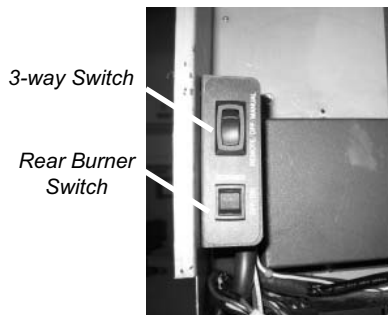

Located on the left hand side of the firebox behind the exterior brick panel.



When in "Remote" position:

In the event of a power failure, if the 3-way switch is in the "Remote" position, the unit cannot be operated with the Remote Control until after power is restored.

To operate unit during a power failure:

NOTE: Both burners when on will operate at the lowest flame setting. The BTU's for NG will be 32,000 and 27,000 for LP.

Front Burner Operation:

- 1) Remove the left side exterior brick panel to access to the Manual Control Panel.
- 2) To turn on the front burner, change the 3-way switch to "Manual" position.

Rear Burner Operation:

- 1) Remove the left side exterior brick panel to access to the Manual Control Panel.
- 2) To turn on the rear burner, change the Rear Burner Switch to the "On" position. Changing the switch to the "Off" position will turn the rear burner off.

Note: The rear burner will only operate if the front burner is on.

When in "Manual" position:

In the event of a power failure, if the 3-way switch is in the "Manual" position the front burner will remain on at the lowest setting and will remain on when power resumes. If the rear burner is not in use, to operate see "Rear Burner Operation" above.

Both burners when on will operate at the lowest flame setting. The BTU's for NG will be 32,000 and 27,000 for LP.

When power resumes the unit will remain on at the lowest setting until reset using the remote control.

NOTE: When power is restored, reset the 3-way switch on the Manual Control Panel to the "Remote" position to be able to use the FireWizard™ Remote Control.

OPERATING INSTRUCTIONS

COPY OF LIGHTING PLATE INSTRUCTIONS



FOR YOUR SAFETY READ BEFORE LIGHTING

This appliance must be installed in accordance with local codes, if any; if none, follow the National Fuel Gas Code, ANSI Z223.1/NFPA 54, or Natural Gas and Propane Installation Codes, CSA B149.1. (Australia: AS5601-2004, New Zealand: NZS 5261)

WARNING: If you do not follow these instructions exactly, a fire or explosion may result causing property damage, personal injury or loss of life. Improper installation, adjustment, alteration, service or maintenance can cause injury or property damage. Refer to the owner's information manual provided with this appliance. For assistance or additional information consult a qualified installer, service agency or gas supplier.

- A) This appliance has a pilot which must be lighted by hand. When lighting the pilot, follow these instructions exactly.
- B) **BEFORE LIGHTING** smell all around the appliance area for gas. Be sure to smell next to the floor because some gas is heavier than air and will settle on the floor.
WHAT TO DO IF YOU SMELL GAS
 - Do not try to light any appliance.
 - Do not touch any electric switch, do not use any phone in your building.
 - Immediately call your gas supplier from a neighbour's phone. Follow the gas supplier's instructions.
 - If you cannot reach your gas supplier, call the fire department.
- C) Use only your hand to push in or turn the gas control knob. Never use tools. If the knob will not push in or turn by hand, don't try to repair it, call a qualified service technician. Forced or attempted repair may result in a fire or explosion.
- D) Do not use this appliance if any part has been under water. Immediately call a qualified service technician to inspect the appliance and to replace any part of the control system and any gas control which has been under water.
- E) This appliance needs fresh air for safe operation and must be installed so there are provisions for adequate combustion and ventilation air.

CAUTION: Hot while in operation. Do not touch. Severe Burns may result. Due to high surface temperatures keep children, clothing and furniture, gasoline and other liquids having flammable vapors away. Keep burner and control compartment clean. See installation and operating instructions accompanying appliance.

LIGHTING INSTRUCTIONS

STOP! Read the safety information above on this label.

- 1) Push in gas control knob slightly and turn clockwise  to "OFF". Knob cannot be turned from "PILOT" to "OFF" unless knob is pushed in slightly. Do not force.

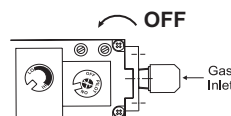
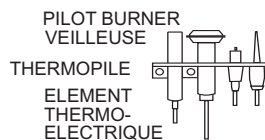

- 2) Wait five (5) minutes to clear out any gas. If you then smell gas STOP! Follow step "B" in the Safety Information above on this label. If you don't smell gas, go to the next step.
- 3) Turn knob on gas control counterclockwise  to "PILOT".
- 4) Push in control knob all the way and hold in until the pilot lights up. Continue to hold the control knob in for about 20 seconds after the pilot is lit. Release knob and it will pop back up. Pilot should remain lit. If it goes out, repeat steps 1) to 4). If knob does not pop up when released, stop and immediately call your service technician or gas supplier. If the pilot will not stay lit after several tries, turn the gas control knob to "OFF" and call your service technician or gas supplier.
- 5) Turn gas control knob counterclock-wise to "ON".
- 6) Turn the unit on.

TO TURN OFF GAS APPLIANCE

- 1) Turn off the unit.
- 2) Push in the gas control knob slightly and turn clockwise  to "OFF". Do not force.
- 3) Turn off all electric power to the appliance if service is to be performed.
You may shut off the pilot during prolonged non use periods to conserve fuel.

DO NOT REMOVE THIS INSTRUCTION PLATE

918-583

OPERATION

MAINTENANCE

MAINTENANCE INSTRUCTIONS

- 1) Always turn off the gas valve before cleaning. For relighting, refer to lighting instructions. Keep the burner and control compartment clean by brushing and vacuuming at least once a year. When cleaning the logs, use a soft clean paint brush as the logs are fragile and easily damaged.
- 2) Clean appliance and door with a damp cloth (never when unit is hot). Never use an abrasive cleaner. The glass should be cleaned with a gas fireplace glass cleaner. **The glass should be cleaned when it starts looking cloudy.**
- 3) The heater is finished in a heat resistant paint and should only be refinished with heat resistant paint. Regency® uses StoveBright Paint - Metallic Black #6309.
- 4) Make a periodic check of burner for proper position and condition. Visually check the flame of the burner periodically, making sure the flames are steady; not lifting or floating. If there is a problem, call a qualified service person.
- 5) The appliance and venting system must be inspected before use, and at least annually, by a qualified field service person, to ensure that the flow of combustion and ventilation air is not obstructed.

Note: Never operate the appliance without the glass properly secured in place.

- 6) Do not use this appliance if any part has been under water. Immediately call a qualified service technician to inspect the appliance and to replace any part of the control system and any gas control which has been under water.
- 7) In the event this appliance has been serviced check that the vent-air system has been properly resealed & reinstalled in accordance with the manufacturer's instructions.
- 8) Verify operation after servicing.

GENERAL VENT MAINTENANCE

Conduct an inspection of the venting system semiannually. Recommended areas to inspect as follows:

- 1) Check the Venting System for corrosion in areas that are exposed to the elements. These will appear as rust spots or streaks, and in extreme cases, holes.

These components should be replaced immediately.

- 2) Remove the Cap, and shine a flashlight down the Vent. Remove any bird nests, or other foreign material.
- 3) Check for evidences of excessive condensation, such as water droplets forming in the inner liner, and subsequently dripping out the joints. Continuous condensation can cause corrosion of caps, pipe, and fittings. It may be caused by having excessive lateral runs, too many elbows, and exterior portions of the system being exposed to cold weather.
- 4) Inspect joints, to verify that no pipe sections or fittings have been disturbed, and consequently loosened. Also check mechanical supports such as Wall Straps, or plumbers' tape for rigidity.

LOG REPLACEMENT

The unit should never be used with broken logs. Turn off the gas valve and allow the unit to cool before opening door and carefully remove the logs. (The pilot light generates enough heat to burn someone.) If for any reason a log should need replacement, you must use the proper replacement log. The position of these logs must be as shown in the diagrams under Log Installation.

Note: Improper positioning of logs may create carbon build-up and will severely alter the unit's performance which is not covered under warranty.

THERMOPILE / THERMOCOUPLE

- 1) Remove the valve tray by following the procedures from "Valve Tray Replacement" section.
- 2) Disconnect thermocouple by loosening nut from the valve with a 9mm wrench. Disconnect thermopile by loosening 2 screws marked TP on the valve.
- 3) Remove 2 screws from the pilot assembly and pull up far enough to be able to loosen the thermocouple or thermopile with a 7/16" wrench. NOTE: the pilot line is very fragile, use caution when pulling it up.
- 4) Drop the thermocouple or thermopile down through the extrusion and pull it out of the unit.
- 5) Reinstall the new ones in reverse order.

GLASS GASKET

If the glass gasket requires replacement use a tadpole glass gasket (Part # 936-155).

DOOR GLASS

Your Regency® fireplace is supplied with high temperature 5mm-Ceramic glass. If your glass requires cleaning, we recommend using an approved glass cleaner available at all authorized dealers. Do not use abrasive materials.

CAUTION & WARNINGS:

- * Do not clean when the glass is hot.
- * The use of substitute glass will void all product warranties.
- * Care must be taken to avoid breakage of the glass.
- * Do not strike or abuse the glass.
- * Do not operate this fireplace without the glass front or with a cracked or broken glass front.
- * Wear gloves when removing damaged or broken glass.
- * Replacement of the glass panel(s) should be done by a licensed or qualified service person.

GLASS REPLACEMENT

In the event that you break your glass by impact, purchase your replacement from an authorized Regency® dealer only.

Replacement glass is shipped already installed into the door frame.

CAUTION: Wear gloves when removing damaged or broken glass.

WARNING: Do not operate the appliance with the glass panels removed, cracked or broken. Replacement of the glass panels should be done by a licensed or qualified service person.

BACK-UP BATTERY REPLACEMENT (within Power Module)

1) Remove the exterior brick panels.

2) Remove the glass door.

a. Release the 2 door latches on the left and right side at the top of the firebox.



Latch Location

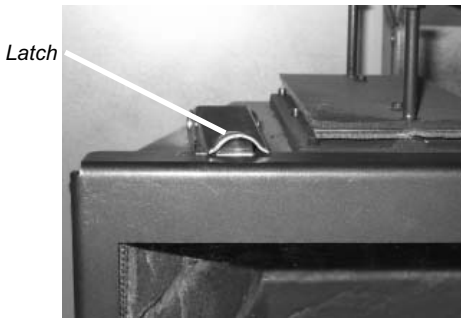

Latch

b. Swing the door out from the top and release the hinges on the left and right side of the door by lifting them up.

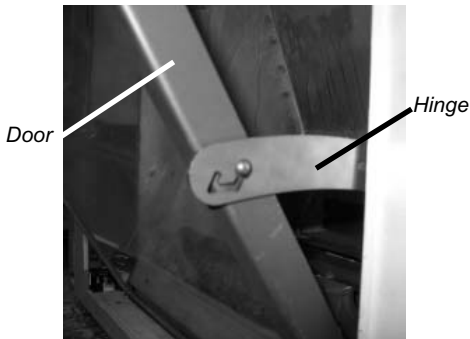

Door

Hinge

c. Place the door on a soft surface to prevent scratching.

3) Loosen the 2 screws that hold the left side heat shield in place.

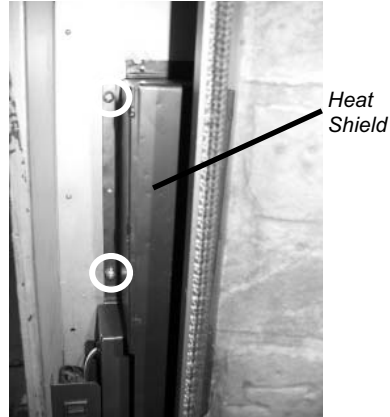

Heat Shield

4) Lift up and pull out the heat shield slightly to clear the screwheads and then hang it on the top bracket (located directly above the heat shield).

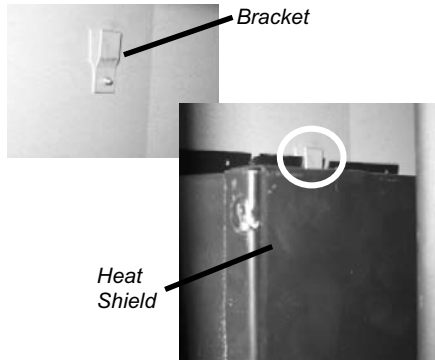

Bracket

Heat Shield

5) Unplug the power source.

6) Loosen the bottom screw and remove the top screw from the power module.

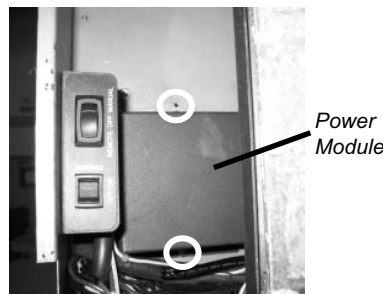

Power Module

7) Pull out the power module.

8) Remove the power module cover by removing the 2 screws, one on each side.



Power Module

9) Replace the 9V battery and the AA battery.

NOTE: *The 9V battery operates the rear burner under power outage conditions. The AA battery operates the DC Sparker for lighting the pilot.*

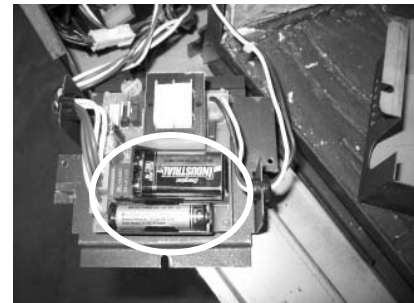

10) Reverse steps to re-install.

MAINTENANCE

POWER MODULE REPLACEMENT

1) Remove the exterior brick panels.

2) Remove the glass door.

a. Release the 2 door latches on the left and right side at the top of the firebox.



Latch Location

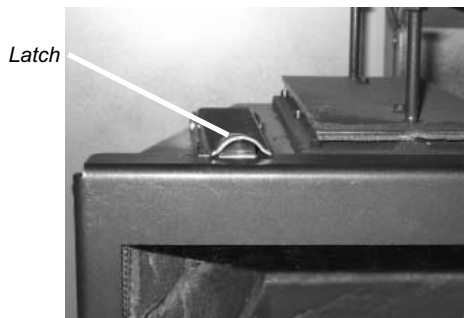

b. Swing the door out from the top and release the hinges on the left and right side of the door by lifting them up.

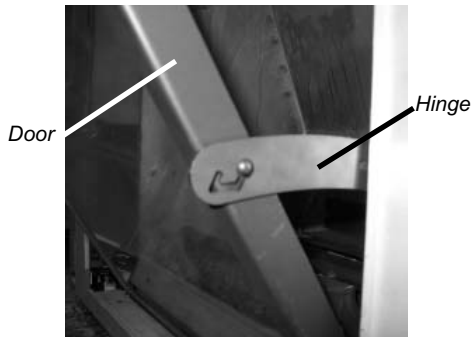

3) Loosen the 2 screws that hold the left side heat shield in place.

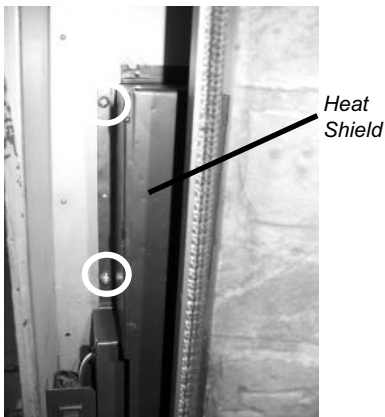

4) Lift up and pull out the heat shield slightly to clear the screwheads and then hang it on the top bracket (located directly above the heat shield).

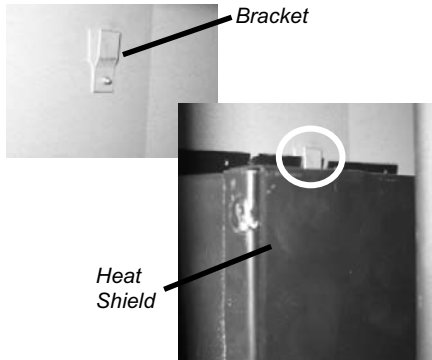

5) Unplug the power source.

6) Remove the top screw and loosen the bottom screw that hold the power module in place.

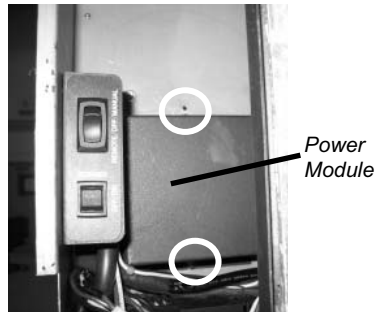

7) Remove the power module cover by removing the 2 screws, one on each side.



Power Module with Cover Removed

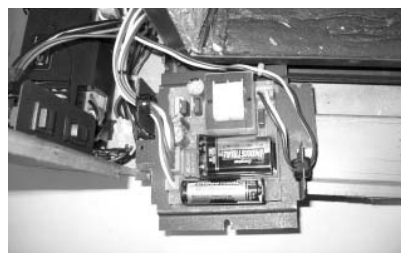

8) Remove the 3 connectors from the circuit board.

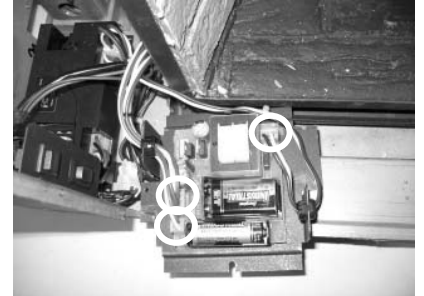

9) Remove the circuit board from the support bracket by turning it around and pushing the plastic pins with a plier.

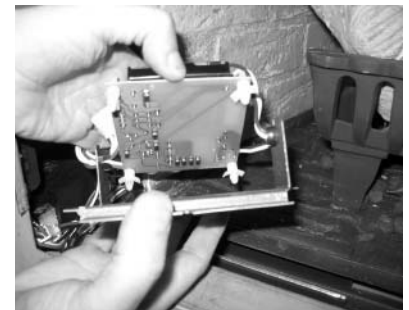
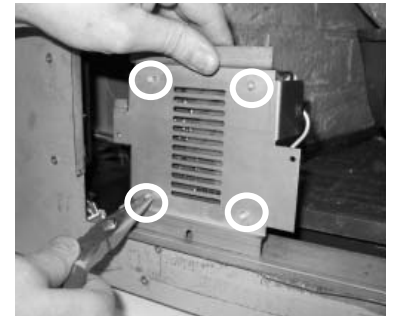

Circuit Board Removed

10) Replace the circuit board.

11) Reverse steps to re-install.

CONTROL MODULE REPLACEMENT

1) Remove the exterior brick panels.

2) Remove the glass door.

a. Release the 2 door latches on the left and right side at the top of the firebox.



Latch Location

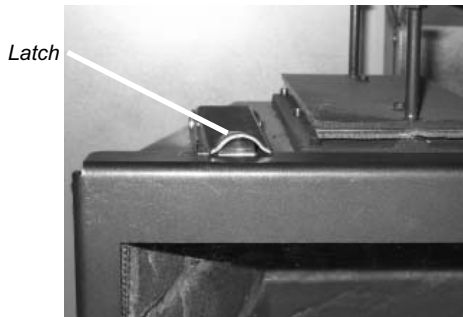

b. Swing the door out from the top and release the hinges on the left and right side of the door by lifting them up.

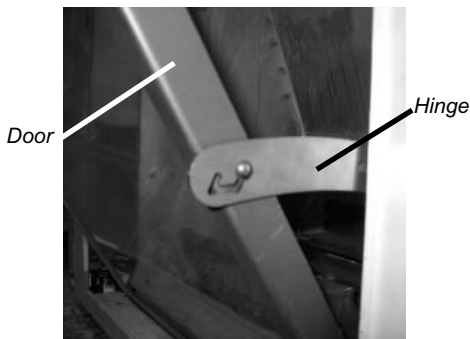

c. Place the door on a soft surface to prevent scratching.

3) Loosen the 2 screws that hold the left side heat shield in place.

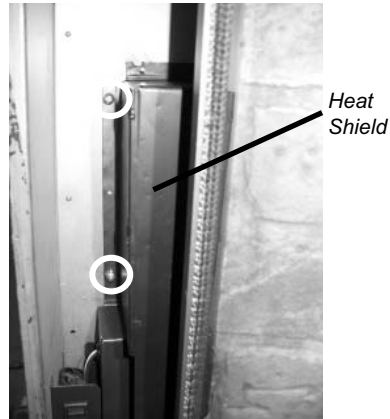

4) Lift up and pull out the heat shield slightly to clear the screwheads and then hang it on the top bracket (located directly above the heat shield).

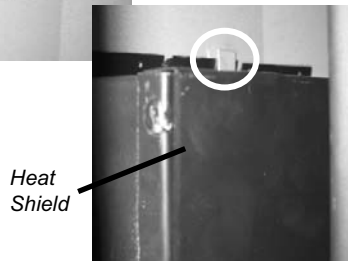
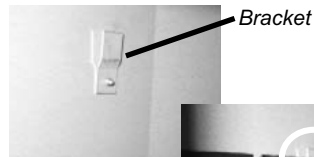

5) Unplug the power source.

6) Cut the cable tie that is holds the wires connected to the control module.

Control Module

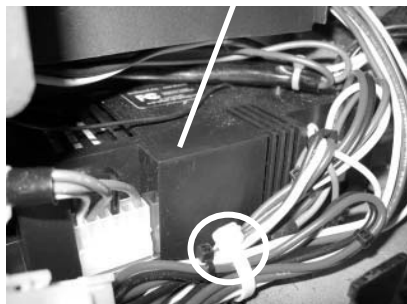

7) Disconnect the 3 connectors from the control module.



8) Pull out the control module.

NOTE: The control module is held in place with velcro.



9) Replace the control module

10) Reverse steps to re-install.

MAINTENANCE

DC SPARKER REPLACEMENT

- 1) Remove the exterior brick panels.
- 2) Remove the glass door.
 - a. Release the 2 door latches on the left and right side at the top of the firebox.



Latch Location

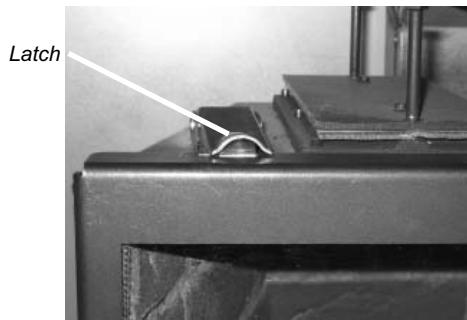

Latch

- b. Swing the door out from the top and release the hinges on the left and right side of the door by lifting them up.



Door

Hinge

- 3) Loosen the 2 screws that hold the left side heat shield in place.

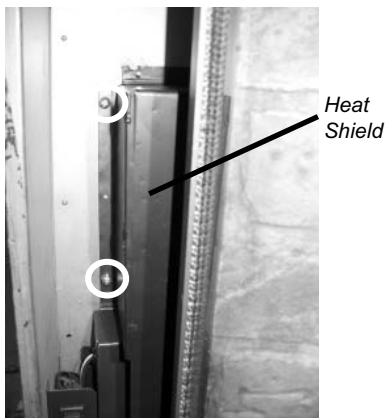

Heat Shield

- 4) Lift up and pull out the heat shield slightly to clear the screwheads and then hang it on the top bracket (located directly above the heat shield).

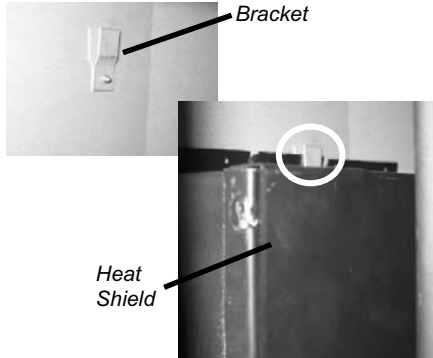

Bracket

Heat Shield

- 5) Unplug the power source.
- 6) Loosen the 2 screws that hold the right side heat shield.



Heat Shield

- 7) Lift up and pull out the heat shield slightly to clear the head screws and then hang it on the top bracket (located directly above the heat shield).

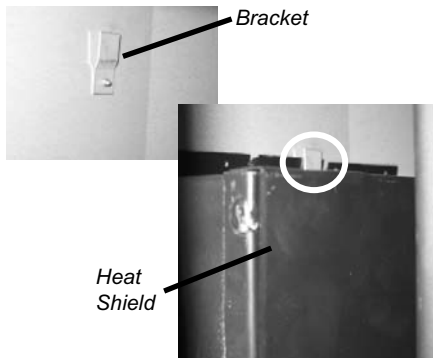

Bracket

Heat Shield

- 8) Remove the battery cover from the DC Sparker Box.

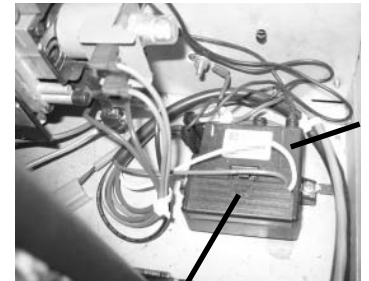

Battery Cover

- 9) Disconnect all the wires and connectors from the DC sparker.



- 10) Remove the 2 screws that hold the DC sparker.



- 11) Replace the DC sparker.
- 12) Reverse steps to re-install.

VALVE TRAY REPLACEMENT

1) Remove the exterior brick panels.

2) Remove the glass door.

a. Release the 2 door latches on the left and right side at the top of the firebox.



Latch Location

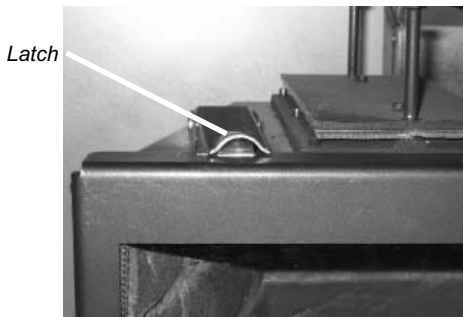

Latch

b. Swing the door out from the top and release the hinges on the left and right side of the door by lifting them up.

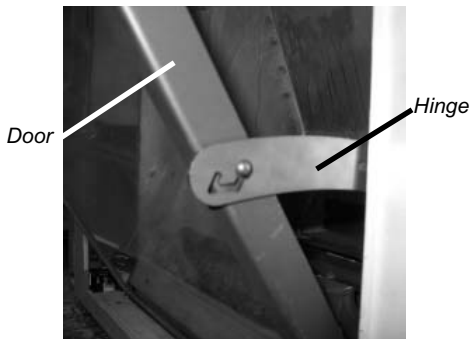

Door

Hinge

c. Place the door on a soft surface to prevent scratching.

3) Loosen the 2 screws that hold the left side heat shield in place.

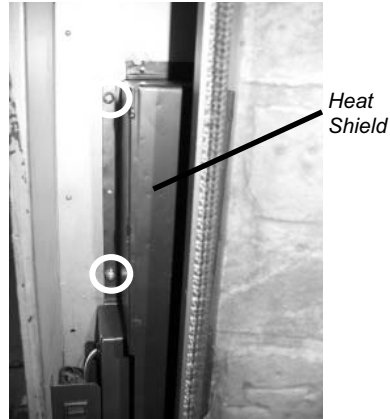

Heat Shield

4) Lift up and pull out the heat shield slightly to clear the screwheads and then hang it on the top bracket (located directly above the heat shield).

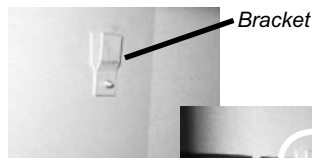

Bracket

Heat Shield

5) Unplug the power source.

6) Remove the log set.

7) Remove the interior brick panels.

8) Remove the grate by undoing the 2 screws on the right and left side.

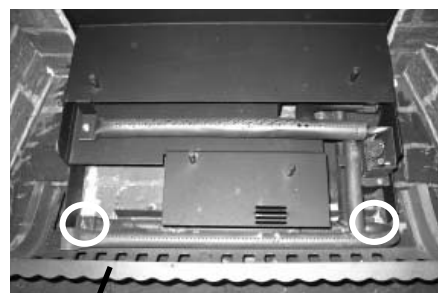

Grate

9) Remove the front burner by removing the screw.

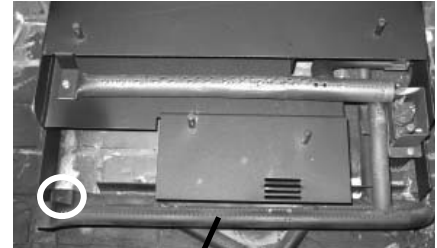

Front Burner



Front Burner Removed

10) Remove the back burner by removing the screw.



Back Burner

11) Remove the rear log stand by removing the 4 screws.

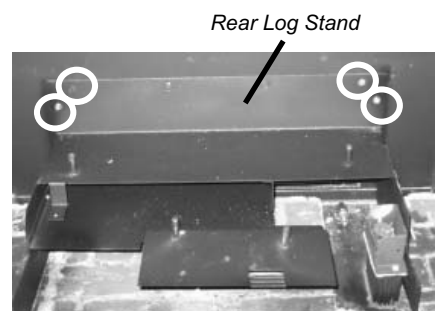

Rear Log Stand

MAINTENANCE

12) Carefully remove the bottom brick panel.

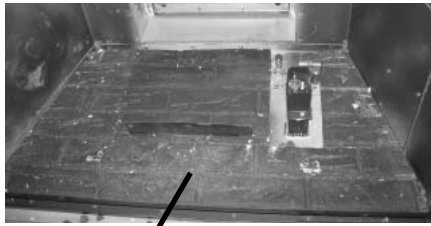

Bottom Brick Panel

13) Loosen the 2 screws that hold the right side heat shield.



Heat Shield

14) Lift up and pull out the heat shield slightly to clear the head screws and then hang it on the top bracket (located directly above the heat shield).

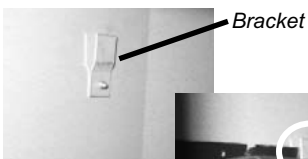

Bracket

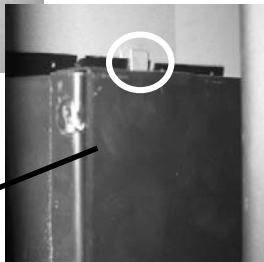

Heat Shield

15) Disconnect the inlet gas line from the valve.

16) Disconnect the 2 connectors from the modulating coil.

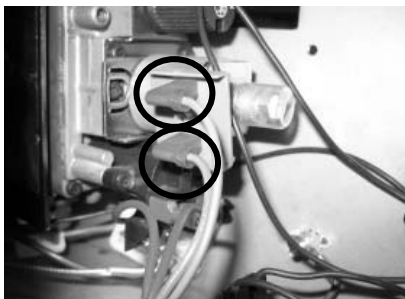

17) Disconnect the 2 red wires and 1 black wire from the valve.



Modulating Coil

Wires

18) Remove the DC Sparker wires; 1 wire for the ignitor and 2 wires to the module box.

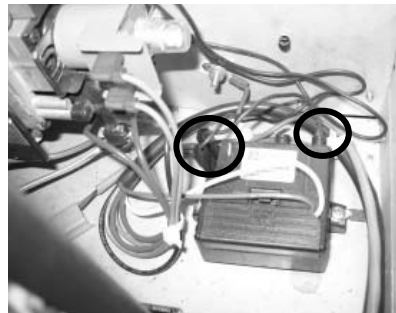

18) Remove the 16 screws that hold the valve tray to the firebox and slightly pull out the valve tray.

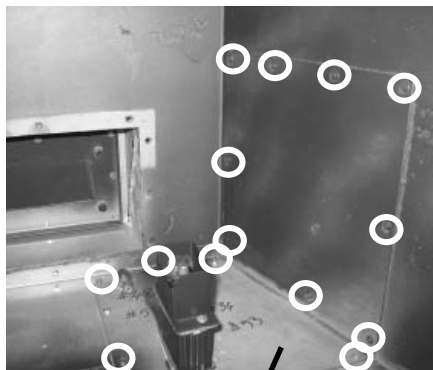

Valve Tray



Valve Tray Slightly Removed

19) Disconnect the black and red wires from the solenoid valve.



20) Completely pull out the valve tray.

21) Replace the valve tray and reverse steps to re-install.

22) Turn on the gas supply and check for gas leaks.

23) Plug in the power source.

24) Re-install the left heat shield.

25) Re-install the grate.

26) Re-install the interior brick panels.

27) Re-install the log set.

28) Re-install the glass door.

29) Check the inlet and outlet pressures.

30) Re-install the right heat shield.

31) Check operation of flame control.

32) Check for proper flame appearance.

33) Re-install the exterior brick panels.

MAIN ASSEMBLY

Part #	Description
1) 521-527	Flue Collar Inner Assembly
2) 502-008	Flue Collar Outer
5) 904-751	Capscrew 1/4 x 4-1/2
6) W260280	Gasket Top Relief Plate
7) 770-066F	Top Relief Plate
8) 942-117	Top Relief Frame
9) W260260	Top Relief Frame Gasket
11) 546-064	Heat Shield ECS
12) 546-540	Door Frame Assembly with Glass
940-354/P	Glass
13) 546-013	One Piece Faceplate
15) 521-021F	Control Arm
16) 521-019	Bracket Control Arm
17) 546-070	Heat Shield Valve
18) 521-024	Gas Line Screen Plate
20) 546-901	Brick Panel Set - Standard Brown
546-902	Brick Panel Set - Standard Red
*	Left Side Panel (Interior)
*	Top Panel (Interior)
*	Back Panel (Interior)
*	Right Side Panel (Interior)
*	Right Side Panel (Exterior)
*	Base Panel (Exterior)
*	Left Side Panel (Exterior)
946-556	Heat Wave Kit
946-570	Heat Release Kit
546-969	LP Conversion Kit
918-610	Manual

* Not available as a replacement part.

PARTS LIST

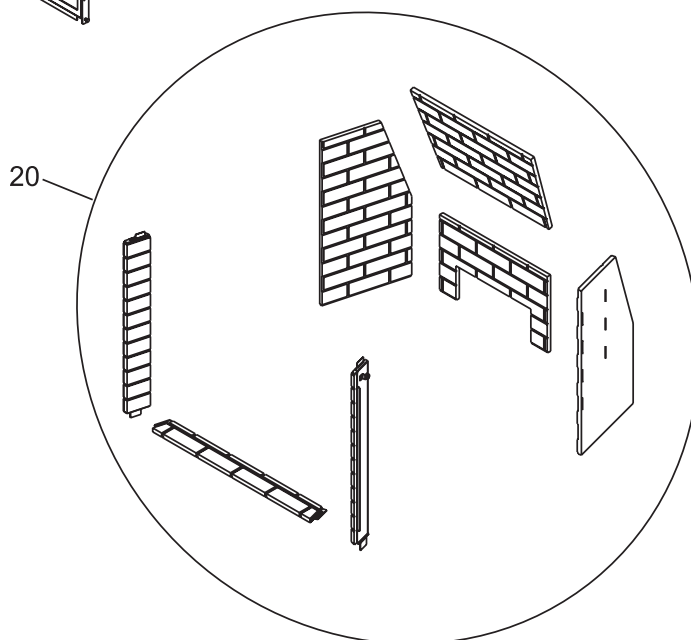
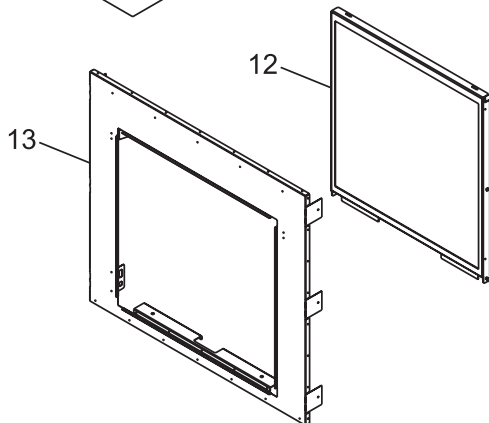
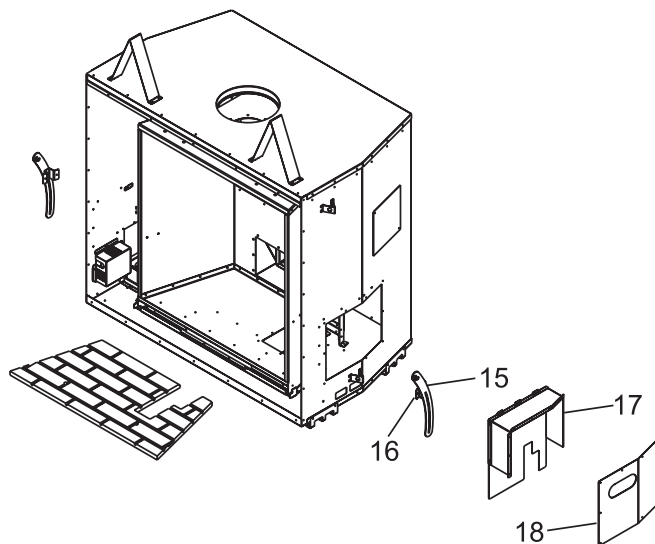
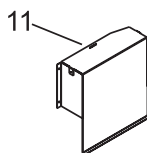
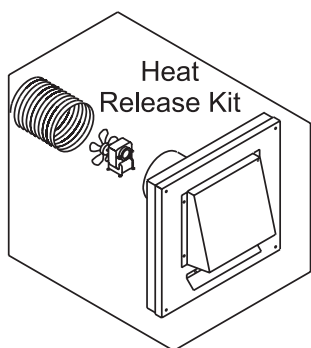
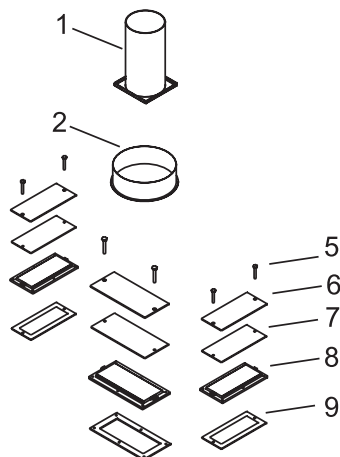
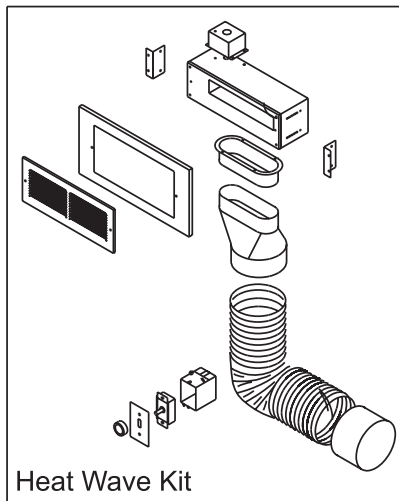

BURNER & LOG ASSEMBLY

Part #	Description	Part #	Description
30) 521-015	Bracket Log Tray	910-937	Valve Solenoid
31) 546-016	Log Tray	910-929	Control Module
32) 546-042	Deflector Log Tray	910-931	Power Module
35) 948-459	Burner Rear NG/LP	910-930	FireWizard™ Remote Control
36) 948-458	Burner Front NG/LP	918-582	Manual FireWizard™
37) 546-050	Grate		
41) 502-061	Pilot Shield		
42) 380-013	Pilot Holder		
43) W840470	Gasket Pilot Assembly		
46) 521-007	Valve Tray		
47) 546-025	Valve Bracket		
48) 910-460	Valve NG 825 SIT Electric		
910-461	Valve LP 825 SIT Electric		
546-574/P	Valve Assembly - NG		
546-576/P	Valve Assembly - LP		
910-008	Pilot Assembly - NG		
910-009	Pilot Assembly - LP		
904-617	NG - Orifice #30		
904-622	NG - Orifice #47		
904-241	LP - Orifice #56		
904-641	LP - Orifice #50		

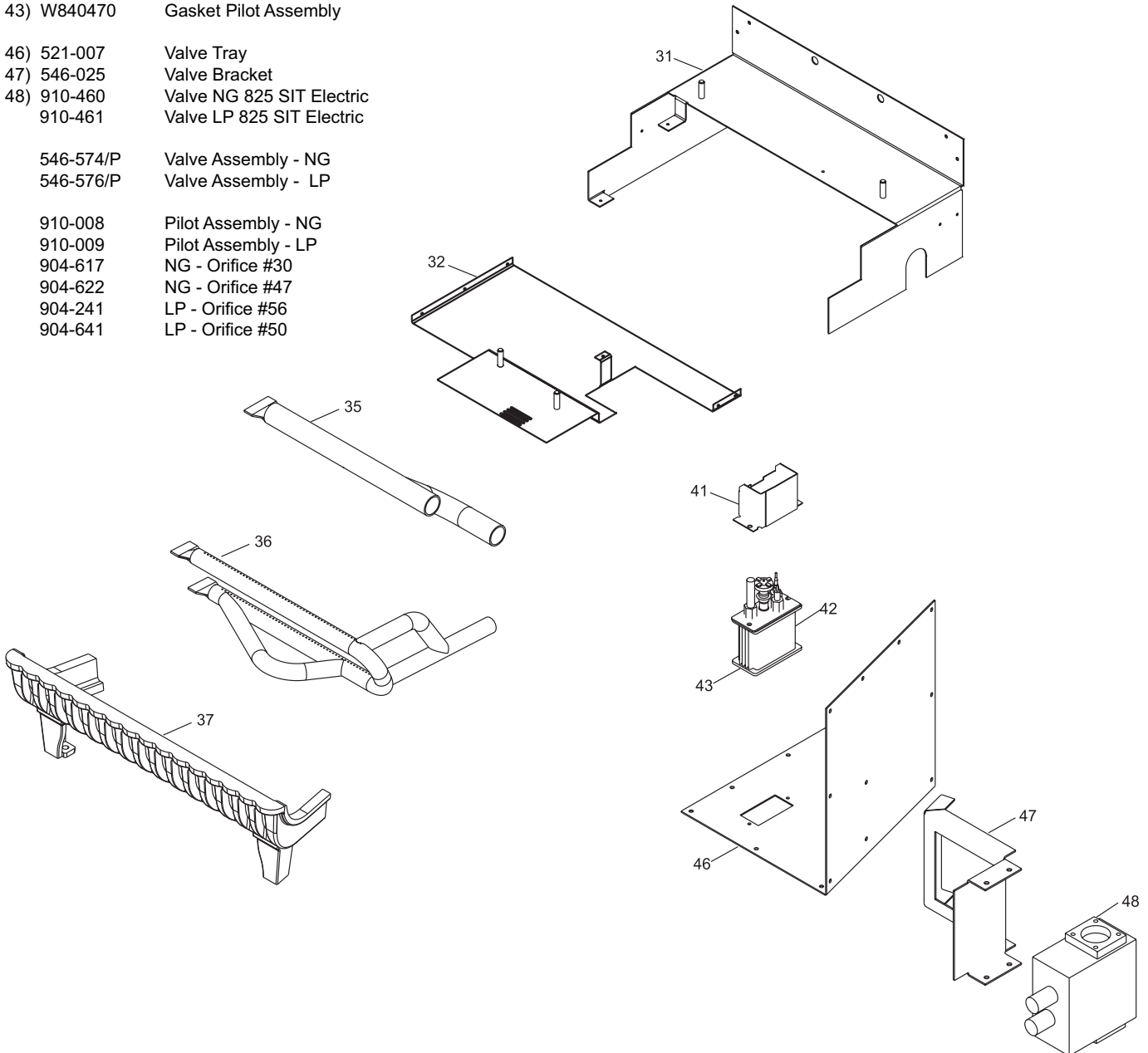



Regency® Fireplace Products are designed with reliability and simplicity in mind. In addition, our internal Quality Assurance Team carefully inspects each unit thoroughly before it leaves our facility. FPI Fireplace Products International Ltd. is pleased to extend this limited lifetime warranty to the original purchaser of a Regency® Product. This warranty is not transferable.

The Warranty: Limited Lifetime

The combustion chamber, heat exchanger, burner tubes/pans, logs, brick panels and gold plating (against defective manufacture only) are covered under the Limited Lifetime Warranty for five (5) years for parts and subsidized labour* and parts only thereafter.

Glass is covered for lifetime against thermal breakage only, parts and subsidized labour* for five (5) years and parts only thereafter from date of purchase.

External casting, surrounds and grills are covered against cracks and warps resulting from manufacturer defects, parts and subsidized labour* for three (3) years from the date of purchase and parts only thereafter.

Special Finishes - One year on brushed nickel and antique copper full screens and doors. You can expect some changes in color as the product "ages" with constant heating and cooling. FPI warranties the product for any manufacturing defects on the original product. However, the manufacturers warranty does not cover changing colors and marks, ie. finger prints, etc applied after the purchase of the product. Damage from the use of abrasive cleaners is not covered by warranty.

Electrical and mechanical components such as blowers, switches, wiring, thermodiscs, FPI remote controls, spill switches, thermopiles, thermocouples, pilot assembly components, and gas valves are covered for two years parts and one year subsidized labour* from the date of purchase. Blowers and valves replaced under warranty are considered repairs and continue as if new with appliance. ie. twelve (12) months from original purchase date of appliance with a minimum of three (3) months coverage from date of replacement.

FPI venting components are covered parts and subsidized labour* for three (3) years from date of purchase.

Simpson Dura-Vent venting components (Direct Vent units) are covered by Simpson Dura-Vent Inc. warranty.

Repair/replacement parts purchased by the consumer from FPI after the original coverage has expired on the unit will carry a 90 day warranty, valid with a receipt only. Any item shown to be defective will be repaired or replaced at our discretion. No labor coverage is included with these parts.

Conditions:

Any part or parts of this unit which in our judgement show evidence of such defects will be repaired or replaced at FPI's option, through an accredited distributor or agent provided that the defective part be returned to the distributor or agent **Transportation Prepaid**, if requested.

Porcelain/Enamel - Absolute perfection is either guaranteed nor commercially possible. Any chips must be reported and inspected by an authorized dealer within three days of installation. Reported damage after this time will be subject to rejection.

It is the general practice of FPI to charge for larger, higher priced replacement parts and issue credit once the replaced component has been returned to FPI and evaluated for manufacturer defect.

The authorized selling dealer is responsible for all in-field service work carried out on your Regency® product. FPI will not be liable for results or costs of workmanship from unauthorized service persons or dealers.

At all times FPI reserves the right to inspect product in the field which is claimed to be defective.

All claims must be submitted to FPI by authorized selling dealers. It is essential that all submitted claims provide all of the necessary information including customer name, purchase date, serial #, type of unit, problem, and part or parts requested, without this information the warranty will be invalid.

Exclusions:

This limited Lifetime Warranty does not extend to or include paint, door or glass gasketing or trim.

At no time will FPI be liable for any consequential damages which exceed the purchase price of the unit. FPI has no obligation to enhance or modify any unit once manufactured. ie. as products evolve, field modifications or upgrades will not be performed.

FPI will not be liable for travel costs for service work.

Installation and environmental problems are not the responsibility of the manufacturer and therefore are not covered under the terms of this warranty policy.

Embers, rockwool, gaskets, door handles and paint are not covered under the terms of this warranty policy.

Any unit which shows signs of neglect or misuse is not covered under the terms of this warranty policy.

The warranty will not extend to any part which has been tampered with or altered in any way, or in our judgment has been subject to misuse, improper installation, negligence or accident, spillage or downdrafts caused by environmental or geographical conditions, inadequate ventilation, excessive offsets, negative air pressure caused by mechanical systems such as furnaces, fans, clothes dryer, etc.

Freight damage to stoves and replacement parts is not covered by warranty and is subject to a claim against the freight carrier by the dealer.

FPI will not be liable for acts of God, or acts of terrorism, which cause malfunction of the appliance.

Performance problems due to operator error will not be covered by this warranty policy.

Products made or provided by other manufacturers and used in conjunction with the operation of this appliance without prior authorization from FPI, may nullify your warranty on this product.

Any alteration to the unit which causes sooting or carboning that results in damage to the interior / exterior facia is not the responsibility of FPI.

* Subsidy according to job scale as predetermined by FPI.

FPI fireplaces are designed with reliability and simplicity in mind. In addition, our internal Quality Assurance Team carefully inspects each unit thoroughly before it leaves our door.

FPI Fireplace Products International Ltd. is pleased to extend this Limited Lifetime Warranty to the original purchaser of a FPI Product.

See the inside back cover for details.

**Register your Regency® online at
<http://www.regency-fire.com>**

Installer: Please complete the following information

Dealer Name & Address: _____

Installer: _____

Phone #: _____

Date Installed: _____

Serial No.: _____

Free Manuals Download Website

<http://myh66.com>

<http://usermanuals.us>

<http://www.somanuals.com>

<http://www.4manuals.cc>

<http://www.manual-lib.com>

<http://www.404manual.com>

<http://www.luxmanual.com>

<http://aubethermostatmanual.com>

Golf course search by state

<http://golfingnear.com>

Email search by domain

<http://emailbydomain.com>

Auto manuals search

<http://auto.somanuals.com>

TV manuals search

<http://tv.somanuals.com>