

Distributed by
Raymarine

Any reference to Raytheon or RTN in this manual should be interpreted as Raymarine. The names Raytheon and RTN are owned by the Raytheon Company.

Raychart 420/ 420D Chartplotter

Owner's Handbook

Document number: 81162_2
Date: January 2000

RayChart 420 and 420D Chartplotter

Owner's Handbook

SAFETY NOTICES



1. HIGH VOLTAGE.

The display unit contains high voltages. Adjustments require specialised service procedures and tools only available to qualified service technicians – there are no user serviceable parts or adjustments. The operator should never remove the display unit cover or attempt to service the equipment.

2. NAVIGATION AID.

This device is only an aid to navigation. Its accuracy can be affected by many factors, including equipment failure or defects, environmental conditions and improper handling or use.

It is the user's responsibility to exercise common prudence and navigational judgement, and this device should not be relied upon as a substitute for such prudence and judgement.

RAYTHEON MARINE products are supported by a network of Authorized Service Representatives. For information on Raytheon products and services, contact either of the following:

UNITED STATES Raytheon Marine Company
22 Cotton Road, Suite 280
Nashua, NH 03063-4219
Telephone: (603) 881-5200
1-800-539-5539
Fax: (603) 864-4756

EUROPE Raytheon Marine Limited
Anchorage Park
Portsmouth
Hampshire PO3 5TD
England
Telephone: +44 (0)23 9269 3611
Fax: +44 (0)23 9269 4642

Website www.raymarine.com

Copyright © Raytheon Marine Company 1999

The technical and graphical information contained in this handbook, to the best of our knowledge, was correct as it went to press. However, the Raytheon policy of continuous improvement and updating may change product specifications without prior notice. As a result, unavoidable differences between the product and handbook may occur from time to time, for which liability cannot be accepted by Raytheon.

Raytheon is a registered trademark of Raytheon Company.

Navionics is a registered trademark.

Preface

This handbook covers the RayChart 420/420D Chartplotter manufactured by Raytheon Marine Company.

It contains very important information on the installation and operation of your new equipment. In order to obtain the best results in operation and performance, please read this handbook thoroughly.

Raytheon's Product Support representatives or your authorised dealer will be available to answer any questions you may have.

Warranty

To register your RayChart 420/420D Chartplotter ownership, please take a few minutes to fill out the warranty registration card found at the end of this handbook. It is very important that you complete the owner information and return the card to the factory in order to receive full warranty benefits.

EMC Conformance

All Raytheon equipment and accessories are designed to the best industry standards for use in the leisure marine environment.

The design and manufacture of Raytheon equipment and accessories conform to the appropriate Electromagnetic Compatibility (EMC) standards, but correct installation is required to ensure that performance is not compromised.

Contents

Preface	iii
Warranty	iii
EMC Conformance	iii
Chapter 1: Overview	1-1
1.1 Introduction	1-1
How this Handbook is organised	1-1
General	1-2
1.2 The chartplotter display	1-2
Display functions	1-2
Display options	1-3
1.3 Operating controls	1-3
Trackpad and cursor	1-4
Dedicated keys	1-5
Function bar	1-5
Pop-up menus	1-6
Database lists	1-6
Chapter 2: Getting started	2-1
2.1 Introduction	2-1
Conventions used	2-1
Simulator	2-1
2.2 Switching on/off	2-2
Changing the lighting and contrast	2-2
2.3 Chart simulator	2-3
2.4 Controlling the display	2-4
Selecting the display mode	2-4
Moving around the chart	2-6
Using FIND SHIP	2-6
Changing the chart scale	2-7
2.5 Using Navionics Nav-Chart cards	2-8
Inserting a Nav-Chart card	2-9
Removing a Nav-Chart card	2-10
Displaying the chart data	2-10
Displaying chart information	2-10

Chapter 3: Operation	3-1
3.1 Introduction	3-1
3.2 Working with waypoints	3-1
Introduction	3-1
Placing a waypoint	3-2
Selecting a waypoint	3-4
Waypoint data display	3-5
Editing the waypoint details	3-5
3.3 Working with routes	3-8
Creating a new route	3-9
Saving the Current Route	3-10
Clearing the current route from the screen	3-11
Retrieving a route from the database	3-11
Displaying route leg and waypoint information	3-12
Erasing or (re)naming a route	3-12
Inserting/deleting waypoints in a route	3-13
3.4 Following routes and going to target points	3-14
Follow a route	3-15
Reverse a route	3-15
Target point arrival	3-16
Alter a route	3-16
Join a route	3-16
Advance to a waypoint	3-17
Going to an individual target	3-18
Go to a waypoint	3-18
Go to cursor	3-19
Go to a port	3-19
Stop follow or stop goto	3-20
3.5 Changing the display mode	3-20
CDI display	3-21
BDI display	3-22
Waypoint data	3-23
Navigation data	3-24
Time/Date Data	3-25
3.6 Transferring waypoints and routes	3-26
Displayed waypoints	3-26
Managing database lists	3-26

3.7 Using tracks	3-27
Clearing the current track	3-29
SmartRoute	3-29
3.8 Man Overboard (MOB)	3-29
3.9 Alarms	3-30
Chapter 4: Setting up the chartplotter	4-1
4.1 Introduction	4-1
4.2 System set up parameters	4-1
Bearing mode	4-3
Key beep	4-3
Units	4-3
Variation	4-3
Date format	4-3
Time offset	4-4
Language	4-4
Simulator	4-4
Simulated SOG	4-4
Simulated COG	4-4
4.3 Chart set up parameters	4-5
Orientation	4-7
Plotter mode	4-7
Show waypoints	4-7
Waypoint symbol	4-7
Autozoom	4-7
Screen amplifier	4-8
COG vector	4-8
Arrival circle	4-8
Anchor alarm	4-8
XTE alarm	4-8
Chart text	4-8
Chart boundaries	4-9
Depth contours <5M	4-9
Depth contours 10M	4-9
Depth contours >20M	4-9
Position calibration	4-9
4.4 GPS setup	4-10

Chapter 5: Installation	5-1
5.1 Introduction	5-1
EMC Installation Guidelines	5-1
Suppression ferrites	5-2
Connections to other equipment	5-2
5.2 Unpacking and inspecting the components	5-2
Items Missing?	5-3
Registering this Product	5-3
5.3 Location	5-3
Selecting the best location	5-3
5.4 Connecting to other equipment	5-5
5.5 Mounting the chartplotter	5-5
Trunnion (yoke) mounting	5-5
Panel mounting	5-5
5.6 Cabling	5-7
Introduction	5-7
Chartplotter connectors	5-7
GPS connector	5-7
POWER/NMEA connector	5-8
5.7 System Check and Initial Switch On	5-9
EMC Conformance	5-9
System Check	5-10
Initial Switch On	5-10
Checking the Chartplotter Operation	5-11
 Chapter 6: Maintenance & fault finding	 6-1
6.1 Maintenance	6-1
Warnings	6-1
Routine checks	6-1
Servicing and Safety	6-1
6.2 Resetting the system	6-2
6.3 Problem solving	6-3
Fault finding	6-3
6.4 Worldwide support	6-4
How to contact Raytheon Marine (US)	6-4
For accessories and parts	6-4
For technical support	6-4
For product repair and service	6-4

How to contact Raytheon Marine (Europe)	6-5
For accessories and parts	6-5
For technical support	6-5
Appendix A: Specification	A-1
Appendix B: NMEA data	B-1
Appendix C: List of abbreviations	C-1
Installation Template	T-1

Chapter 1: Overview

1.1 Introduction

How this Handbook is organised

This handbook describes the RayChart 420 Chartplotter.

The handbook is organised as follows:

Chapter 1 - Overview (this chapter) provides an overview of the features and functions of the RayChart 420 Chartplotter. You should read this chapter to familiarise yourself with the chartplotter.

Chapter 2 - Getting Started provides an overview of the controls. It also explains how to start using the chartplotter.

Chapters 3 - Operation provides detailed operating information for the main chartplotter functions - plotting waypoints and routes, following routes, showing tracks and man overboard.

Chapter 4 - Setting Up the Chartplotter provides instructions for setting up your chartplotter system to suit your preferences. It includes instructions for setting up a differential GPS. You should read this chapter to determine how to set up your system preferences.

Chapter 5 - Installation provides planning considerations and detailed instructions for installing the chartplotter.

Chapter 6 - Maintenance & Fault Finding provides information on user maintenance and what to do if you experience problems.

Appendix A lists the technical specifications for the Chartplotter.

Appendix B defines the NMEA data transmitted by the Chartplotter.

Appendix C provides a list of abbreviations used in this handbook.

An **Installation Template** and **Warranty** information are included at the end of this handbook.

General

The RayChart 420 Chartplotter is waterproof and can be installed either above or below deck. The equipment comprises:

- 6 in LCD display with Chartholder compartment for a Navionics® Nav-Chart electronic chart card
- GPS receiver (RC420) or Differential/GPS (dGPS) receiver (RC420D)

The RayChart 420 Chartplotter can output GPS and Waypoint data (SOG and COG) to operate with other equipment, eg. an autopilot or repeater instrument connected via the NMEA 0183 interface.

1.2 The chartplotter display

Display functions

The RayChart 420 Chartplotter includes the following functions:

- Create, Place, Move, Edit or Erase a Waypoint.
- GoTo Waypoint, Port, Facility or Cursor.
- Create, Save, Name, Edit or Follow a Route.
- Review Route and Waypoint Lists.
- Display vessel's track on-screen; Convert a track to a route (*SmartRoute*).
- Set Up Alarms and Timers.
- Man OverBoard (MOB) to navigate back to a missing person or object.
- Satellite acquisition data (including a Differential GPS Setup page).
- Uses positional information from GPS (RC420) or dGPS (RC420D) to display vessel's position.
- The display and keys can be illuminated for night-time use.

The chartplotter includes a 64nm world map that can be used for route planning. Detailed navigation information is displayed when a Navionics® Nav-Chart card is installed.

Your vessel's position is shown as a boat symbol pointing in your current direction.

At the top of the chartplotter screen a status bar displays chart scale, cursor position plus range and bearing, the vessel's position, Speed Over Ground (SOG) and Course Over Ground (COG).

Waypoints you have placed are displayed and the current route is shown. Data can be viewed for current route or chart object.

The chartplotter screen can also show additional information, depending on your currently selected options, set up selections and data available from other equipment.

An example chart display in its default configuration, with a chart card installed, is shown in *Section 1.3, Operating controls*.

Several functions are available to control the display as follows:

- Zoom in/out
- Pan the Display.
- Centre the Chart around the Vessel.

Operation of these functions is described in *Chapter 2*.

Display options

Display options are selected in System Set Up and Chart Set Up as described in *Chapter 4*.

1.3 Operating controls

The chartplotter is operated by means of the following controls:

- A trackpad providing up, down, left, right and diagonal control of an on-screen cursor.
- Six dedicated push-button (labelled) keys.
- Pop-up menus, displayed on-screen, from which you select options.
- Database lists, displayed on-screen, which enable you to edit items.

Note: *The cursor is the cross-hair symbol (+) visible on the display. You move the cursor with the trackpad and use it to select a position or item on the chart.*

The controls are shown in the following illustration. They are back-lit for night-time use.

The following paragraphs describe the controls and on-screen facilities.

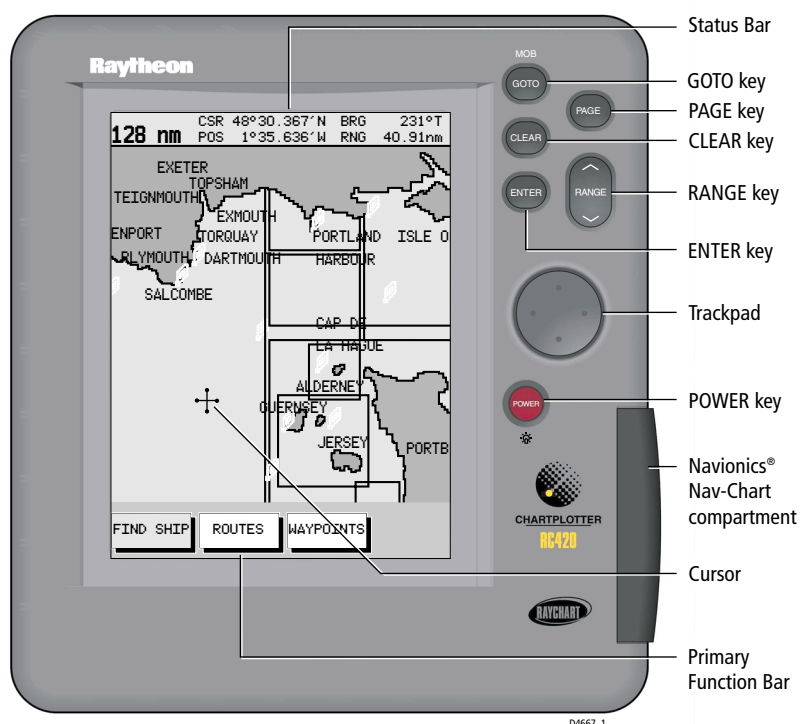

Trackpad and cursor

The trackpad has several functions:

- To move the cursor around the chart screen.
- To select an item from a pop-up menu or database list.
- To adjust a control setting.
- To enter names in database lists .

Press the corresponding edge of the trackpad to move the cursor horizontally, vertically or diagonally; the longer you press, the faster the cursor moves. The current cursor position is shown in the status bar at the top of the screen.

Note: During many operations you cannot move the cursor around the screen, eg. whilst a function bar is displayed, the cursor is used exclusively for selection.

The cursor is used to:

- Select a position on the chart.
- Select, access and, if valid, move an item, eg. a waypoint, on the chart.
- Pan the chart display.

The cursor is context-sensitive. Some items on the screen, such as waypoints and chart objects have information associated with them. When you place the cursor over such objects, the information is displayed in the status bar. In addition, a function bar is displayed for certain items. For example, when you place the cursor over a waypoint, the waypoint data is displayed in the status bar and the waypoint options function is displayed.

Dedicated keys

These keys have fixed functions. Some keys can be used in two ways:

- **Press:** Press the key momentarily and then release it. This method is used for most key operations.
- **Press and hold:** Press the key and hold it down for the period of time stated (eg. 3 seconds), then release it.

When you press a dedicated key, one of the following occurs:

1. The associated operation is actioned, eg. change chart scale (**RANGE** key).
2. A pop-up menu is displayed, providing further options.
3. A set of functions is displayed.

As you press a key, a single audio beep confirms the key action. If the key-press is not valid for the current screen or mode, three rapid beeps sound to indicate that no response is available. If required, you can turn the key beeps off as part of your set up procedure (see *Chapter 4*).

Function bar

The function bar at the bottom of the screen contains a number of functions which change according to the current operation. The functions are grouped into related sets and subsets providing access to the various functions. The primary function bar is displayed when you press the **ENTER** key.

The currently selected function is highlighted by means of a grey background.

When you invoke a function, one of the following occurs:

1. The associated operation is actioned, eg. GOTO WAYPOINT.
2. A sub-set of functions is displayed.
3. A pop-up menu is displayed, providing further options.
4. The appropriate database list (route or waypoint) is displayed.

As with dedicated keys, when you invoke the action, a single audio beep confirms the action. If the selection is not valid for the current screen or mode, three rapid beeps indicate invalid action. If required, you can turn the key beeps off as part of your set up procedure (see *Chapter 4*).

Pop-up menus

Pop-up menus usually provide various options. When a pop-up menu is on-screen, a set of associated functions is also displayed.

Use the trackpad to select an option from the menu, then use the appropriate function to set the option, eg. you can specify the radius of the waypoint arrival alarm and you can set selected navigation data on/off.

Database lists

The waypoints and routes that you create on the chartplotter are stored in database lists. You can view these lists and select items for editing.

As with pop-up menus, when a database list is on-screen, a set of associated soft keys is also displayed; use the trackpad to select an item from the list, then use the appropriate function to edit the item, eg. you can erase a waypoint or a route.

Chapter 2: Getting started

2.1 Introduction

This chapter provides information, instructions and a simple exercise to allow you to practice using the RayChart 420 Chartplotter. It is intended to help you become familiar with the controls before you start using the chartplotter for routine navigation.

Note: *There is often more than one method of performing a particular task. Normal operating procedures are detailed in Chapter 3. When you become familiar with the system you can adapt these procedures to suit your method of operation.*

Conventions used

Throughout this handbook, the dedicated (labelled) keys are shown in bold capitals; for example, **ENTER**. The functions and options are shown in normal capitals, eg. LIGHT.

Operating procedures, which may consist of a single key-press, or a sequence of numbered steps, are indicated by a ► symbol in the margin.

When textual data is displayed on screen, any unavailable data is shown as dashes, one per character.

Where procedures refer to *Select*, this implies using the trackpad to highlight a function, then pressing the **ENTER** key to action that function.

Simulator

The Chartplotter display unit includes a *simulator* mode, which allows you to practice operating your chartplotter without data from a GPS system. You will need to use the set up options to switch the display to *simulator* mode, as described in *Section 2.2, Switching on/off*. You can use it in either of two ways:

- Before the chartplotter has been installed on your vessel. In this case, you only need to connect the Chartplotter display unit to a 12V dc power supply, fused at 1A, connecting the red core from the power lead to positive (+) and the black core to negative (-); see *Chapter 5* for full details.
- After the chartplotter has been installed on your vessel, but while in the marina or at anchor.

2.2 Switching on/off

This section explains how to switch the chartplotter on and off.

- To turn the chartplotter display unit on, press the **POWER** key. The keys light up, the display unit beeps and the RayChart logo is displayed, followed by the following warning:

WARNING
THE ELECTRONIC CHART IS AN AID TO NAVIGATION DESIGNED TO FACILITATE THE USE OF AUTHORISED GOVERNMENT CHARTS, NOT TO REPLACE THEM. ONLY OFFICIAL GOVERNMENT CHARTS AND NOTICES TO MARINERS CONTAIN ALL INFORMATION NEEDED FOR THE SAFETY OF NAVIGATION AND, AS ALWAYS, THE CAPTAIN IS RESPONSIBLE FOR THEIR PROPER USE.

Press "ENTER" to continue.

When you have read and understood the warning, press the **ENTER** key. The chart is displayed.

If this is the first time that the chartplotter has been switched on, and no chart card is installed, the display shows the small-scale world map at Lat 0°/Lon 0°. Otherwise, the display shows the selected chart area and any data that were displayed when the display unit was last used.

- To turn the display unit off, press and hold the **POWER** key for at least 3 seconds. A countdown timer is displayed; when it reaches zero the display and key back-lights extinguish.

Changing the lighting and contrast

You can change the level of backlighting and contrast for the screen. The key backlighting remains on to enable the keys to be seen at all times.

- To change the lighting and contrast:
 1. Press the **POWER** key to display the lighting controls:

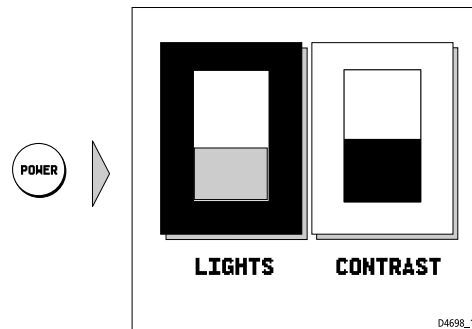

The last-used control is highlighted in inverse video.

2. Press the trackpad left/right to select the LIGHTS function.
3. Press the trackpad top/bottom to increase or decrease the lighting to one of four levels. You can press and hold the trackpad to change the setting more rapidly. The lighting level is adjusted as you change the setting.
4. Press the trackpad right to select the contrast control. There are 16 contrast levels. Adjust the setting in the same way as for lighting to select the best level.
5. Press **CLEAR** to return to the chart screen, with the new lighting and contrast levels retained.

When the display unit is switched on, screen lighting is restored to ON if it was ON previously. Whilst the unit is switched on, the chosen lighting level is retained until you reset it. The new contrast level is retained until you reset it, even after power-off, unless you set the control very low or very high; in this case, the contrast will be restored on power-up as follows:

Contrast set	< 30%	restored to 30%
Contrast set	> 70 %	restored to 70%

2.3 Chart simulator

When simulator mode is started, your initial simulated position is wherever the cursor was last positioned. To practice using the chartplotter in a particular chart area, use the trackpad to pan to that area, then switch simulator ON.

Note: *If real position data is available (via GPS or dGPS) and the simulator is active, simulated data takes precedence. On power-up the simulator defaults to its previous setting on power-down. Care should be taken to determine desired mode on power-up. Simulated data should never be used for navigational purposes.*

- To view a chart image using simulated data:
 1. Press the **PAGE** key to display the SET UP function bar:

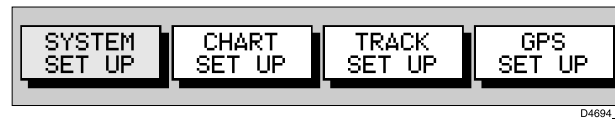

2. Press trackpad left/right to highlight SYSTEM SET UP and press **ENTER** to display the System Set Up menu.
3. Use trackpad up/down to highlight the SIMULATOR option .
4. Use trackpad left/right to select ON.
5. If necessary, use trackpad up/down to highlight, in turn, the SIMULATED SOG and COG options and trackpad left/right to set as required . These set Speed in 1Kt intervals and Course in 1° intervals, respectively.
6. Press **CLEAR** twice to return to the chart screen.

2.4 Controlling the display

This section describes how to:

- Change the display mode.
- Move around the chart by panning the display, changing the chart centre and changing the chart scale.

Selecting the display mode

Use the **PAGE** key to select the display mode. Select the following modes by repeat presses of the **PAGE** key as listed below and shown in the following illustration:

- Set Up functions (see *Chapter 4*)
- Course Deviation Indicator (CDI)
- Bearing & Distance Indication (BDI)
- Waypoint data
- Navigation data
- Time/Date data
- Return to Set Up functions

Note: Press **GOTO** to return to normal Chart display at any time.

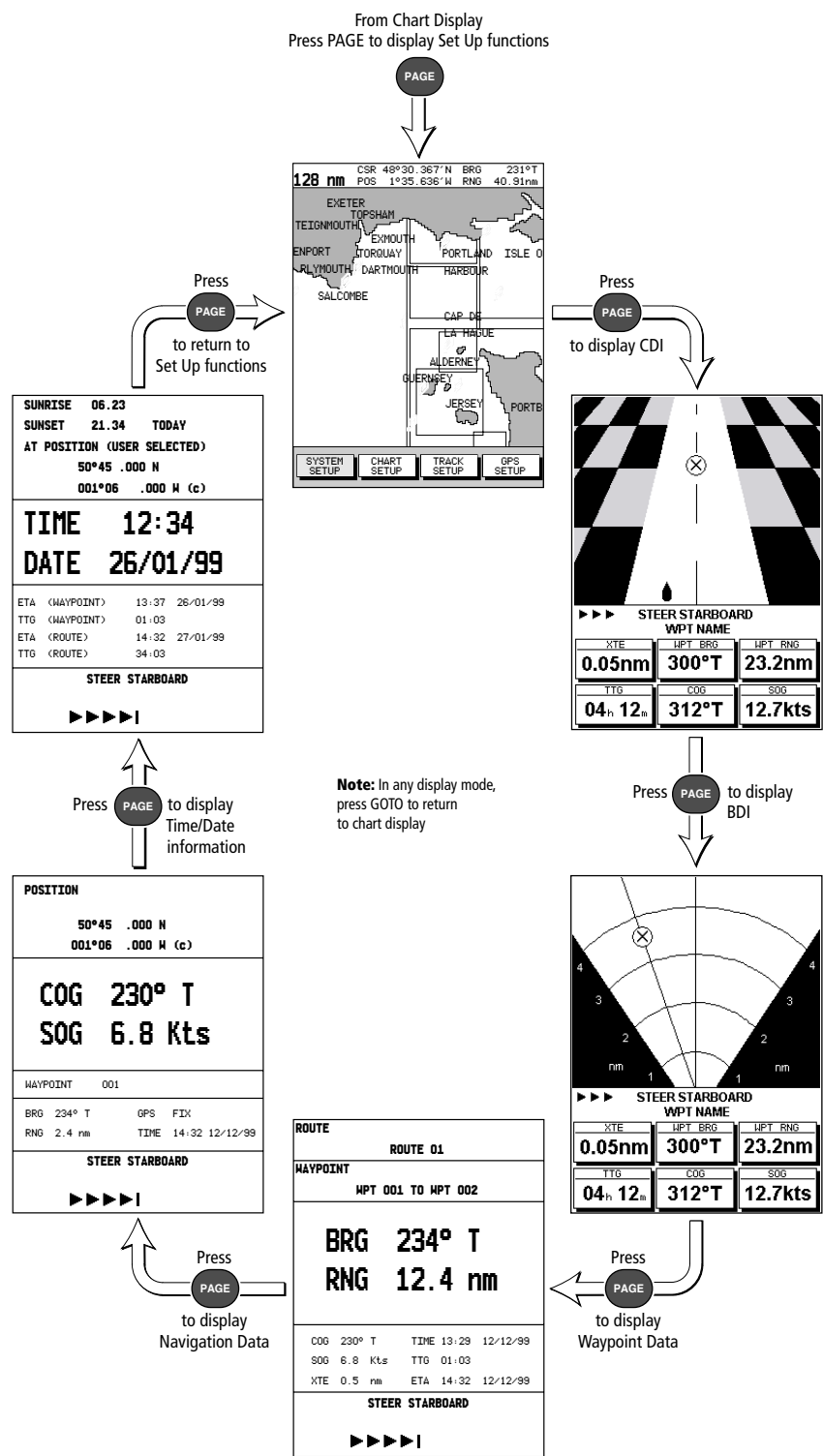

D4724_1

Moving around the chart

You will normally operate the chartplotter with the chart showing your vessel's current location.

In the default North-Up orientation, the vessel moves in relation to the screen. You will need to reposition the chart if your vessel moves out of the area currently displayed, or if you wish to examine or place waypoints in another area.

Alternatively, you can *home* the cursor onto the vessel using the FIND SHIP function. 'Homing' locks the vessel to the cursor and updates the display such that the chart is re-drawn so as to ensure that the vessel is always on screen, see *Using FIND SHIP* below.

There are three ways in which you can reposition the chart:

- Use the trackpad to move the cursor to the edge of the chart; the chart pans across. This method is useful if the area you wish to see is just off screen.
- Automatically re-centre the vessel using the FIND SHIP function.
- Change the chart scale using the **RANGE** key to zoom out and in to a new area. This method is useful if the area you wish to see is some distance away.

Using FIND SHIP

FIND SHIP is used to re-draw the chart with the vessel normally at its centre and the cursor homed on the vessel.

- To centre the vessel:

1. From chart mode, press **ENTER**; the primary function bar is displayed:

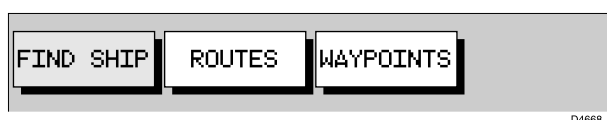

Select FIND SHIP; the following actions are performed:

- The chart is re-drawn with the vessel's position in the centre.
 - The cursor is homed onto the vessel position and moves with it.
 - When the vessel moves near the edge of the chart window, the chart is redrawn with the vessel at the centre and the cursor homed on the vessel.
 - Whilst homed, the status bar indicates vessel position, SOG and COG.
 - If Screen Amplifier is enabled, the vessel is positioned so as to increase screen forward visibility, see *Chapter 4, Setting Up the Chartplotter*.
- To release the cursor from homed mode press the trackpad to move the cursor away from the vessel's current position. The status bar shows the cursor position, range and bearing.

Changing the chart scale

The **RANGE** key allows you to change the chart scale so that you can see a smaller or larger area on the screen.

Plotter mode is available to allow you to zoom into a smaller area, even when no chart data is available for that scale. To enable plotter mode, see *Chapter 4, Setting Up the Chartplotter*.

You can change the chart scale for two purposes:

- To see either more detail (of a smaller area) or a larger area (in less detail) .
- To move the display to another area of the chart, by zooming out to a small scale chart, then zooming in on another position.

Each time you press the **RANGE** key, the chart scale changes to the next available setting. The Status Bar at the top of the screen indicates the distance, from top to bottom of the display, in nautical miles.

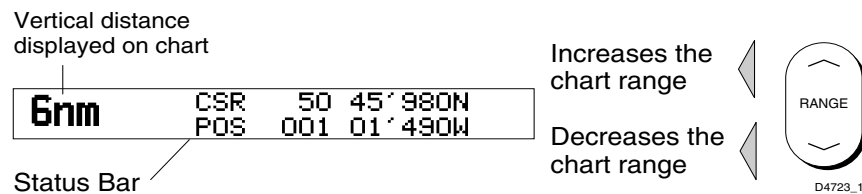

- For rapid scale change, press and hold the required arrow on the **RANGE** key.

The distance indicator at the left-hand end of the status bar is updated whenever you change the chart scale.

- To zoom in to a larger-scale (more detailed) chart:

1. Use the trackpad to position the cursor in the area you wish to see in more detail and press the bottom of the **RANGE** key to zoom into the area.

The section of the chart around the cursor is enlarged to fill the screen with a larger-scale chart showing more detail. The cursor is now positioned in the centre of the screen.

The distance indicated at the top left of the screen is updated.

3. If further chart enlargement is available using the current chart card you can press the bottom of the **RANGE** key to zoom in again, repositioning the cursor first if required.

An area of further chart detail is indicated by a box around the area as shown in the following illustration.

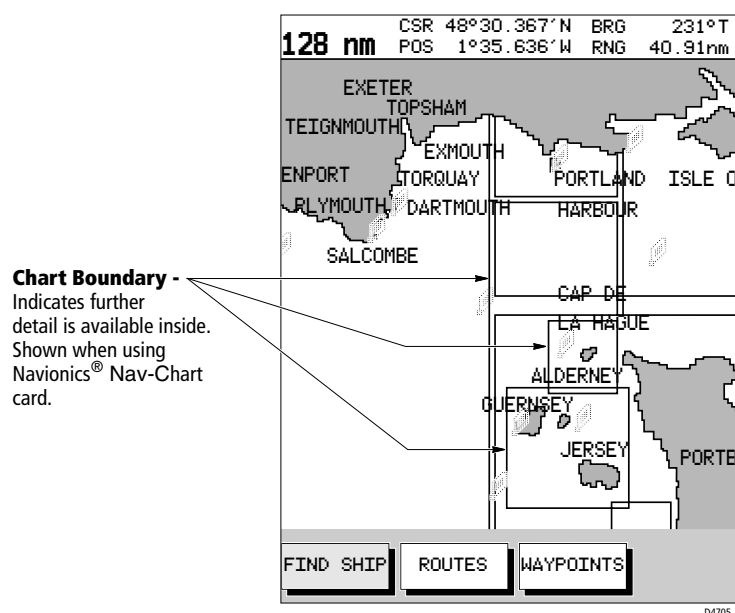

4. If no further chart detail is available then, when you press the bottom of the **RANGE** key, the result depends upon whether Plotter Mode is on or off :
- If Plotter Mode is Off, the unit beeps three times and the chart scale remains unchanged, indicating the smallest chart scale is displayed.
 - If Plotter Mode is On, the scale is decreased. The vessel, waypoints, routes and tracklines are displayed without cartography.

The chart information is restored when you return to a chart scale for which the information is available.

- To zoom out to a smaller-scale (less detailed) chart, press the top of the **RANGE** key as many times as required.

2.5 Using Navionics Nav-Chart cards

The chartplotter has a built-in world map that can be used for route planning. Most areas (these are shown with chart box boundaries) are covered at a range of approximately 64nm as shown on the Status Bar at the top of the screen.

Note: *To ensure maximum detail for the built-in world map, two versions are available covering the Americas and the Rest of the World.*

To use the chartplotter as a navigation aid, charts with detailed information for the area you wish to navigate are required. The charts are available on Navionics Nav-Chart cards, each of which can store as many as 20 charts in an electronic format, depending upon its memory storage capacity.

A Nav-Chart card provides an appropriate level of detail for a given geographic area and scale; this data can be displayed down to a range of $\frac{1}{8}$ nm on the screen (height) if the data is available.

The chart scale in use is indicated in the status bar; the number represents the distance (in nautical miles) displayed from the top to the bottom of the screen.

To obtain Navionics Nav-Chart cards contact your local dealer or:

Navionics S.p.A.
Via Vespucci 289
55049 Viareggio, Italy

Tel: (+39) 584 961696
Fax: (+39) 584 961309
website: www.navionics.com

Inserting a Nav-Chart card

CAUTION

To prevent the ingress of water and consequent damage to the unit, always ensure that the cartridge cover is fully and properly inserted, whether or not a Nav-Chart card is inserted.

- To insert a Nav-Chart card:
 1. Check that you are using the correct Nav-Chart card for the required area.
 2. Pull out the cartridge cover at the right hand side of the unit.
 3. Hold the card with the title label and keyway slot towards you, and the two circular holes outermost, as shown below. Gently push the card into its slot until it clicks into position. It will only fit in the correct orientation.
 4. To prevent the ingress of water, replace the cartridge cover.



D4706_1

Removing a Nav-Chart card

CAUTION:

DO NOT use a metallic instrument, eg. a screwdriver or pliers, to aid removal as doing so can cause irreparable damage.

- To remove a Nav-Chart card:
 1. Pull out the cartridge cover at the right hand side of the unit.
 2. Grip the card firmly and pull to remove it from its slot.
 3. To prevent the ingress of water, replace the cartridge cover.

Note: *If difficulty is experienced in removing the card, a short length of cord can be secured between the two circular holes in the card to ease its removal, making sure that fitting of the cartridge cover is not impeded.*

Displaying the chart data

The new chart data will be displayed when you move the cursor into an area covered by the new chart or, if it is already in the area, change the range scale.

The boundary of each chart digitized in the current card is defined by a box or rectangle. (You can switch off the chart boundaries display if you wish, as part of the chartplotter set up described in *Chapter 4*).

- To zoom in:
 1. Use the trackpad to move the cursor inside one of the chart boxes.
 2. Press the lower part of the **RANGE** key.

That area is expanded to show more detail. The smaller the chart box is on the screen, the greater the detail that is available when you zoom in.

Unless you have activated Plotter Mode (see *Chapter 4, Chart Set Up*), you cannot zoom in further than the most detailed chart and you cannot zoom out further than the world map.

Displaying chart information

Nav-Chart cards include a number of displayed objects for which data is available, eg. lights, buoys or ports. Placing the cursor over an object displays its associated data in a pop-up box.

At large chart scales, placing the cursor over a port symbol enables detailed information to be displayed. Port information is indicated by the  symbol. The port facilities are listed in the object information pop-up and, where available, details for each facility can be displayed.

In some areas the chart shows symbols for individual facilities. These facilities and symbols are dependent upon the particular area Nav-Chart card used.

► To obtain port services information:

1. Place the cursor over the port symbol for which you require information.
The PORT SERVICES function, together with help text, is displayed:

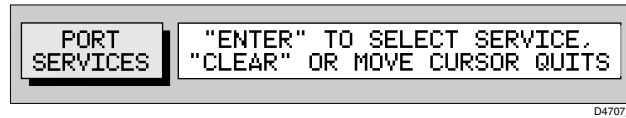

2. To view further details, press **ENTER**. The details available are listed on-screen in an object information pop-up:

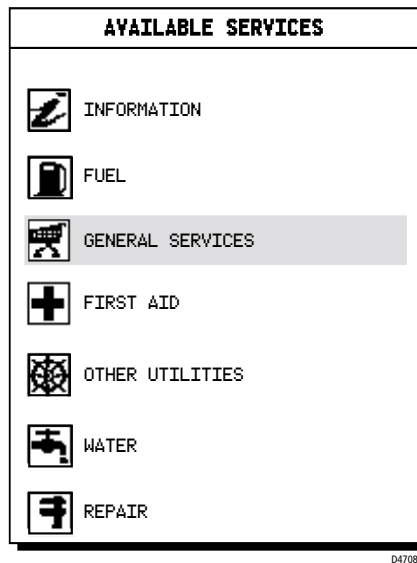

3. Use the trackpad to select the required service and press **ENTER** to display further details:

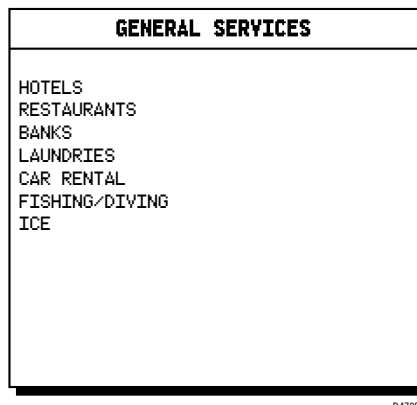

4. To see more options (if available), select the **.....More.....** option and press **ENTER**.
5. Press **CLEAR** to remove the pop-up from the screen.

Chapter 3: Operation

3.1 Introduction

This chapter explains how to use the chart functions to navigate with your RayChart 420. It covers the following topics:

- Controlling waypoints; placing, moving, editing and deleting waypoints
- Working with routes; creating a new route, managing routes using the route database and editing routes
- Going to waypoints and following routes
- Changing display modes
- Transferring waypoints and routes
- Using tracks; track set up, showing current track and converting a track to a route (*SmartRoute*)
- Man Overboard
- Alarms

Safety

The RayChart 420 makes it very easy to mark a waypoint and travel towards it. However, you should always check first that the route is safe. If you are using the chartplotter in combination with an autopilot connected via NMEA, the autopilot will normally prompt for confirmation before it steers the vessel towards the waypoint.

If you have entered your route using a small-scale chart, zoom in to a larger scale to check for hazards, such as small shoals, that may not be shown on the smaller scale charts.

Note: *Until you are familiar with interpreting the chart display, you should take every opportunity to compare the displayed objects with visual targets, such as buoys and coastal structures. You should practice harbour and coastal navigation during daylight and in clear weather conditions.*

The equipment should not be used as a substitute for good navigational practice.

3.2 Working with waypoints

Introduction

The RayChart 420 enables you to place up to 500 waypoints. A waypoint is a position entered on a chart as a reference or destination point. All waypoints placed on the chartplotter are stored in a waypoint database list which includes symbol, position, bearing, range, date and time.

All waypoints in the database are displayed on the screen, unless you set **SHOW WAYPOINTS** to **OFF** in the Chart Set Up menu, as described in *Chapter 4*. You can select a waypoint, either on-screen or from the list, for editing.

The waypoint is usually placed at the cursor position and can be part of a route; you can also place a waypoint at the vessel's current position. You can place waypoints before you install the chartplotter on your vessel.

When you place a new waypoint, it is displayed using either the default symbol of a cross or an alternative symbol available from the Chart Set Up menu, as described in *Chapter 4*. The waypoint is added to the waypoint list and named with the next available number. You can use the edit functions to change the symbol and name. When the cursor is positioned over a waypoint, the waypoint bearing and range are displayed.

You can also transfer waypoints between the chartplotter and other NMEA connected instruments using the Waypoint Transfer functions.

This section explains how to perform the following tasks using the on-screen cursor and the waypoint list:

- Placing a Waypoint
- Selecting a Waypoint
- Displaying Waypoint data
- Editing a Waypoint (symbol, name & position)
- Erasing a Waypoint
- Moving a Waypoint

Placing a waypoint

Note: *It is not possible to place multiple waypoints at the same position.*

➤ To place a new waypoint:

1. From chart mode, press **ENTER**; the primary function bar is displayed:

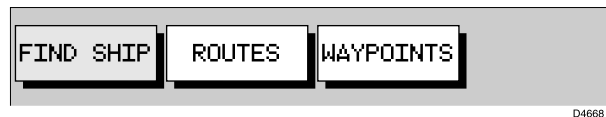

2. Using trackpad left/right, select **WAYPOINTS**.

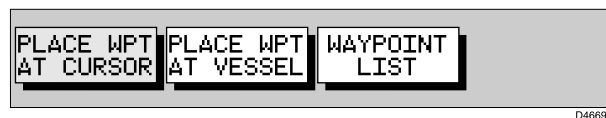

➤ To place a waypoint at the cursor position:

1. Select **PLACE WPT AT CURSOR**. The selected function now has help text appended to it:

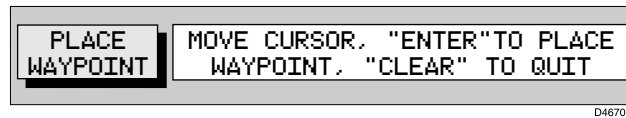

D4670_1

2. Place the cursor in the required position on the chart and press **ENTER** to place the waypoint. The waypoint is added to the waypoint list and named using the next available number.

The waypoint functions remain displayed so that you can place further waypoints.

If required, use **EDIT WAYPOINT** to name the waypoint as described in *Editing Waypoints* below.

3. When finished placing waypoints, press **CLEAR**.

➤ To place a waypoint at the vessel's position:

1. Select **PLACE WPT AT VESSEL**.

A new waypoint is placed at the vessel's current position.

➤ To place a waypoint using the Waypoint List:

1. Select **WAYPOINT LIST**. The Waypoint List and associated functions are displayed:

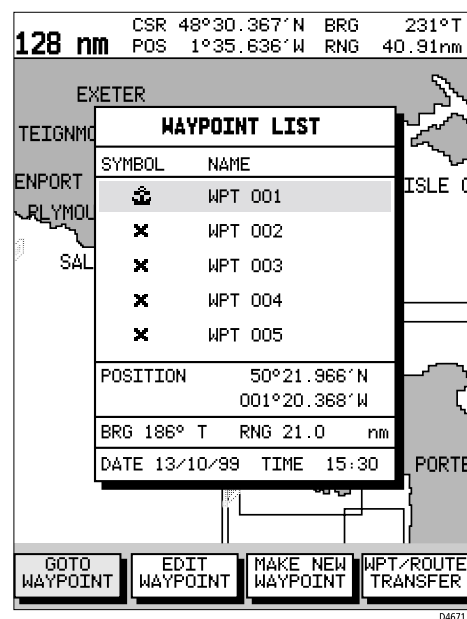

D4671_1

2. Select **MAKE NEW WAYPOINT**.

The waypoint is placed at the current vessel position or, if a GPS fix is not available, the cursor position. The new waypoint is added to the Waypoint List and named with the next available number.

To return to chart mode, press **CLEAR** twice.

Selecting a waypoint

Positioning the cursor over a waypoint selects that waypoint and accesses the WAYPOINT OPTIONS function bar. This enables you to go to (described in Section 3.4), edit (symbol, name, position), erase or move the waypoint.

Selecting a waypoint from the Waypoint List allows you to go to and edit (symbol, name, position, erase) the waypoint. The Waypoint List also provides options to make a new waypoint and transfer waypoints.

► To select a waypoint using the cursor:

1. Move the cursor over the waypoint; the WAYPOINT OPTIONS function bar, together with help text, is displayed:

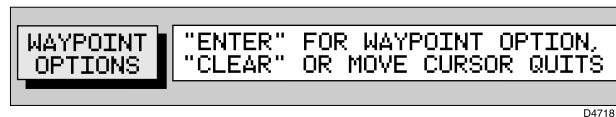

2. Press **ENTER** to select the waypoint function bar:

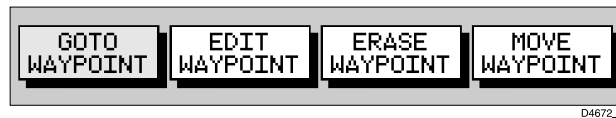

The selected waypoint can be edited via these functions.

► To select a waypoint using the Waypoint List:

1. Press **ENTER** to display the primary function bar:

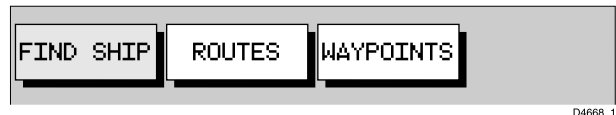

2. Select WAYPOINTS and press **ENTER** to display the waypoint function bar:

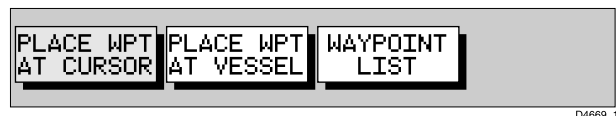

3. Select WAYPOINT LIST and press **ENTER** to display the Waypoint List.

The Waypoint List and associated function bar are displayed (see *Placing a waypoint*).

The list details all waypoints. The selected waypoint is indicated by the highlight bar with its position; bearing and range are provided (if GPS fix available).

4. Use trackpad up/down to move through the list to highlight the required waypoint.

The selected waypoint can be edited using the EDIT WAYPOINT function.

Waypoint data display

Waypoint data can be viewed in two ways: you can use the cursor to select the waypoint to display the waypoint data in the status bar at the top of the screen, or you can view waypoint details on the waypoint list.

- To display waypoint data:

Move the cursor over the waypoint. The waypoint data is displayed in the status bar, indicating waypoint number/name, bearing and range.

Whilst the cursor is over the waypoint, the WAYPOINT OPTIONS function bar is displayed.

- To remove the waypoint data :

Move the cursor away from the waypoint or press **CLEAR**.

- To display the waypoint details from the waypoint list:

Select the waypoint in the list as described above.

The details for the selected waypoint are displayed in the lower half of the window. Date and time are included for all waypoints.

To remove the Waypoint List and return to chart mode, press **CLEAR** twice.

Editing the waypoint details

You can change the name, symbol and position of a waypoint, which can be achieved either by means of the cursor or via the Waypoint List.

Note: *You cannot edit the target waypoint.*

- To edit a waypoint using the cursor:

1. Place the cursor over the waypoint, see *Selecting a waypoint* above.
2. Select EDIT WAYPOINT. The Edit Waypoint function bar is displayed:

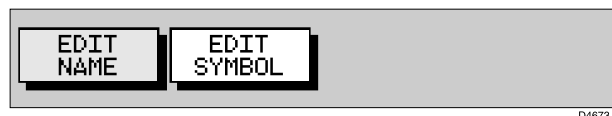

3. To edit the waypoint name, select EDIT NAME.

The NAME WAYPOINT window is displayed.

Use the trackpad to enter or edit the name as follows:

- Use trackpad left/right to move the cursor to the character you wish to change. Up to eight characters can be used.
- Use trackpad up/down to scroll through the characters.

When you have finished editing the name press **ENTER**. The waypoint name is updated and the window is removed

4. To edit the symbol, select EDIT SYMBOL.

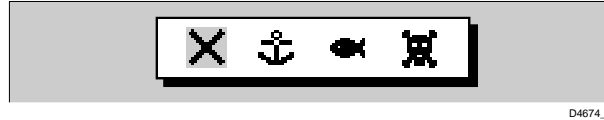

D4674_1

5. Use trackpad left/right to highlight the required symbol, then press **ENTER**.

► To edit a waypoint using the Waypoint List:

1. From chart mode, press **ENTER**; the primary function bar is displayed.



D4668_1

2. Using trackpad left/right, select WAYPOINTS.



D4669_1

3. Select WAYPOINT LIST.

The Waypoint List is displayed, with its associated function bar:

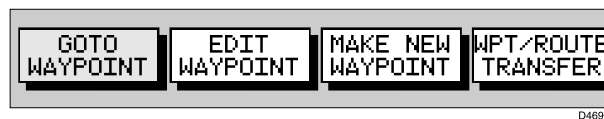

D4692_1

4. Select EDIT WAYPOINT; the waypoint edit functions are displayed:

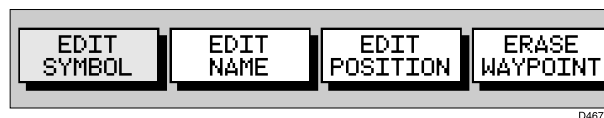

D4675_1

5. To edit the waypoint name, select EDIT NAME.
The cursor is placed in the name field of the selected waypoint.
Edit the name as previously described (up to eight characters).
6. Edit the waypoint symbol as previously described, using the cursor.
7. To change the waypoint's position, select EDIT POSITION. The cursor is placed in the Position field in the Waypoint List .
- Use trackpad left/right to select the latitude/longitude fields.
 - Use trackpad up/down to scroll through and edit the values.
8. When you have finished editing, press **ENTER** to save the new position.

Erasing a waypoint

Note: You cannot erase a waypoint that is the target waypoint or waypoints that are also used in any saved route(s).

If you try to erase a waypoint that is used in a saved route you are warned "WAYPOINT IS USED IN ROUTE(S) AND CANNOT BE ERASED"

- To delete a waypoint using the cursor:
 1. Place the cursor over the waypoint; see *Selecting a waypoint* above.
 2. Select ERASE WAYPOINT. A warning box appears. Press **ENTER** to erase or **CLEAR** to retain. If erased, the waypoint list is updated and the screen is cleared.
- To delete a waypoint using the waypoint list:
 1. Select the waypoint from the waypoint list as previously described. The waypoint list function bar is displayed.
 2. Use trackpad up/down to move through the list to highlight the required waypoint.
 2. Select ERASE WAYPOINT. Press **ENTER** to erase the waypoint.

To return to chart mode, press **CLEAR** three times.

Moving a waypoint

You can move any waypoint except the target waypoint. You can use the Waypoint function bar and cursor to move the selected waypoint, or you can edit the waypoint position.

Note: Take care when editing waypoints as it is possible to move waypoints that are used in routes stored in the Route Database List.

- To move a waypoint using the cursor:
 1. Place the cursor over the waypoint; see *Selecting a waypoint* above.
 2. Select MOVE WAYPOINT. The selected function now has help text appended to it:

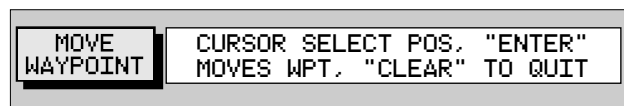

3. Move the cursor to the required waypoint position.
4. When the cursor is in the correct position, press **ENTER** to set the new position and return to normal cursor control.

To return to chart mode, press **CLEAR**.

- To move a waypoint using the Waypoint Edit functions:
 1. Select the waypoint using the Waypoint List as described above. The waypoint functions are displayed.
 2. To edit the waypoint position proceed as previously described in *Editing the Waypoint Details*.

3.3 Working with routes

A route is made up of a series of waypoints (maximum 50). To make a route you place a series of waypoints on the chart.

When a route is created it becomes the current route and is displayed on-screen. The current route is maintained when you power-off. Only one route can be current and is displayed (if it is in the field-of-view) as solid lines connecting waypoints. If you are following the route, the current leg is shown as a dotted line. You can use the Waypoint Transfer functions to transfer the route and waypoint database to a PC or another navigator.

When you have created a route you can use the **GOTO** key to follow the route. The **GOTO** key provides various other options as described in Section 3.4.

Up to 20 routes can be saved in the route database. You can then select a route from the database list to be used as the current route.

The current route can be edited by adding and/or moving waypoints. When a route has been saved, options are also provided to name a route or erase a route.

This section explains how to perform the following tasks:

- Create a new route.
- Save the current route in the database list.
- Clear the current route.
- Retrieve a route from the database list as the current route.
- Display route information, including the route leg data and waypoint details.
- Use the database list to erase and name existing routes.
- Edit a route by adding, removing and moving waypoints.

- To access the route function bar:
 1. Press **ENTER** to display the primary function bar:

The image shows a horizontal bar with three rectangular buttons. The first button is labeled 'FIND SHIP', the second is 'ROUTES', and the third is 'WAYPOINTS'. The buttons are arranged from left to right. Below the 'WAYPOINTS' button, there is a small text label 'D4668_1'.
 2. Select **ROUTES** to display the first level functions:

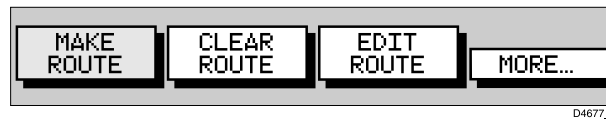

3. Select MORE to see more functions:

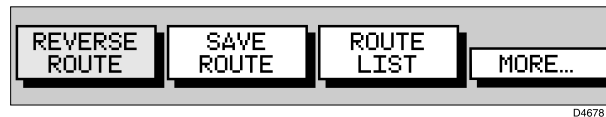

4. Select MORE again to return to the first level functions.
5. Press **CLEAR** to return to chart mode.

Creating a new route

Note: *If there is a current route on screen, it is cleared when you select MAKE ROUTE. If you are following the current route you are prompted to STOP FOLLOW. Press ENTER to continue or CLEAR to abandon route creation. If the route has not been saved you are prompted to save it.*

You can add/remove waypoints in a route after you have finished making it, either via the ROUTES function or via the cursor (see *Editing a Route* in the following sections).

- To make a new route by placing waypoints:

Note: *You can pan the chart and change the scale whilst placing waypoints.*

1. If necessary, move the cursor to the area in which you wish to make the route and select a suitable chart scale.
2. Select ROUTES then MAKE ROUTE. The MAKE ROUTE function is replaced with PLACE WAYPOINT, together with help text:

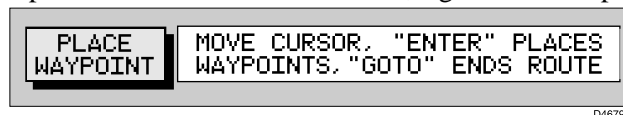

3. Move the cursor to the position on the chart where you want your first waypoint to be placed and press **ENTER**.

Note: *You can position the cursor on an existing waypoint, if required; the PLACE WAYPOINT function changes to USE THIS WAYPOINT. Press ENTER to use the waypoint.*

The waypoint appears on the screen at the cursor position. The number displayed alongside the waypoint identifies its position in the route.

Note: *If you Clear the route before it is saved, the waypoint is removed.*

4. Move the cursor to the next waypoint position; a dotted line connects the cursor to the last placed waypoint.
5. Press **ENTER** again. The next waypoint is placed and the dotted line changes to a solid line.

Note: *If you placed a waypoint incorrectly, you can delete it by pressing CLEAR. Successive waypoints can be deleted in this way.*

6. Repeat steps 4 and 5 until you have placed all your waypoints. You can have up to 50 waypoints in a route. Any existing waypoint(s) can be included by placing the cursor on the waypoint(s).
7. When you have entered all your waypoints, press **GOTO** to complete the route. Your route is displayed on the screen and is the current route, but is not active, ie. not being followed.
8. Select **MORE** to access the **SAVE ROUTE** function, or **ENTER** to return to chart mode.

Note: *The completed route is stored in the unit's memory and will be re-displayed if you turn the unit off and on again. However, it is recommended that you save the route as described below. The current route waypoints do not appear in the waypoint list until the route is saved.*

Saving the Current Route

You can save up to 20 named routes in the route database list. These routes can then be re-displayed and followed subsequently.

Note: *When you attempt an operation affecting this route (eg. **CLEAR ROUTE**) before the current route is saved, you are prompted to save it.*

- To save and name the current route:
 1. Select **ROUTES**, followed by **MORE**.
 2. Select **SAVE ROUTE**. The Save Route list is displayed.
 3. The next available entry on the list is highlighted. (If required, you can use trackpad up/down to select another position in the list; this can be a blank slot, or an existing route that you no longer require).

SAVE ROUTE	
1	ROUTE 01
2	-
3	-
4	-
5	-

D4712_1

4. Press **ENTER** to save the route. Press **ENTER** again (in response to the prompt) to name the route or **CLEAR** to save as the default ROUTE XX, where XX is the next available number.

When naming a route, use the trackpad to move the cursor right or left to the character you wish to edit. Use trackpad up/down to scroll through the characters or numerals. The name can contain up to eight alphanumeric characters, including spaces.

5. Press **ENTER** to finish and clear the Route List, then press **CLEAR** to return to the chart mode.

Clearing the current route from the screen

To clear the current route from the screen, select **CLEAR ROUTE**. If the current route has not been saved, you are prompted to save it.

- To clear the current route from the screen:
 1. Select **ROUTES** or place the cursor over a route leg until the leg data is displayed in the Status Bar.
 2. Select **CLEAR ROUTE** and press **ENTER** to clear the route or press **CLEAR** to cancel the operation.
 3. If the route has not been saved, a prompt gives the options **ENTER** to save or **CLEAR** to remove the route from the screen.
 4. To save the route in the database, press **ENTER**. The Name Route functions are displayed, see *Saving the Current Route* above.

Retrieving a route from the database

You can select a route as the current route from the database list. The list is accessed from the second set of **ROUTES** functions.

- To select a route as the current route:
 1. Select **ROUTES**, followed by **MORE**, then **ROUTE LIST**. The route list is displayed with the currently selected route highlighted:

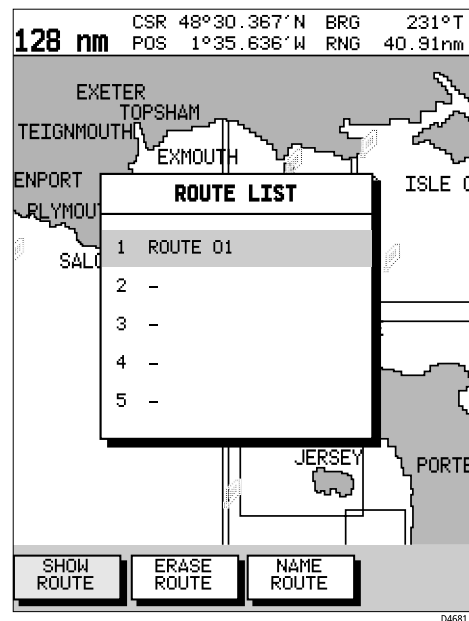

2. Select **SHOW ROUTE**. The route list is removed and the selected route is shown on screen as the current route.

Displaying route leg and waypoint information

- To display information about a route leg, move the cursor over the leg until its data is displayed in the status bar at the top of the screen.

```
ROUTE :- LEG:FROM WPT 004 BRG 180° T
CURRENT TO WPT 005 RNG 28 nm
```

D4682_1

To remove the data, move the cursor away from the route leg or press **CLEAR**.

- To display information about a route waypoint, move the cursor over the waypoint until its pop-up data box is displayed.

```
WAYPOINT :- 220° T 295 nm
WPT 004
```

D4683_1

To remove the data, move the cursor away from the waypoint or press **CLEAR**.

Erasing or (re)naming a route

You can delete a route or re-name a route via the route list. When deleting a route, you are prompted to confirm.

- To select a route to delete:
 1. Select **ROUTES**, followed by **MORE**, then **ROUTE LIST**. The route list is displayed with the selected route highlighted.
 2. Select **ERASE ROUTE**.
 3. Press **ENTER** to erase the route from the list. Press **ENTER** again to confirm or **CLEAR** to cancel the operation.
 4. Press **CLEAR** three times to remove the route list and return to chart mode.
- To select a route to (re)name:
 1. Select **ROUTES**, followed by **MORE**, then **ROUTE LIST**. The route list is displayed with the selected route highlighted. Select **NAME ROUTE**.
 2. To name or rename a route, use trackpad left/right to select the character you wish to edit. Use trackpad up/down to scroll through the characters or numerals.
 3. Press **ENTER** to accept the new name or **CLEAR** to cancel the operation.
 4. Press **CLEAR** to clear the Name List. To return to chart mode, press **CLEAR** again.

Editing a route

You can edit a route in order to:

- Add a Waypoint into a route
- Remove a Waypoint from a route

- Move a Waypoint (as described in Section 3.2)
- Reverse a Route

Any changes you make to the route affect only the current route, so you need to save the route if you want to keep the changes.

Inserting/deleting waypoints in a route

- To add a waypoint to the end of a route:

Note: *If no current route is displayed, select a route from the Route List and use the SHOW ROUTE function to make it active, see Retrieving a route from the database.*

1. Select EDIT ROUTE and press **ENTER**; the PLACE WAYPOINT function is shown as above (see *Creating a new route*).
2. Add waypoints to the route by moving the cursor and pressing **ENTER** in the same way as the route was first created.
3. Remove waypoints from a route by pressing **CLEAR** in the same way as the route was first created.

Note: *When deleting waypoints, if the route has not been saved, the waypoint is erased. If the route has been saved, the waypoint remains on the screen.*

- To insert a waypoint into a route:

1. Move the cursor over the route leg into which you wish to insert a waypoint. The route leg data is shown in the status bar and the ROUTE OPTIONS function, with help text, is displayed:

```
ROUTE: - LEG: FROM WPT 004   BRG 180° T
CURRENT TO WPT 005   RNG 28   nm
```

D4682_1

```
ROUTE  "ENTER" FOR ROUTE OPTIONS.
OPTIONS "CLEAR" OR MOVE CURSOR QUIT
```

D4720_1

2. Press **ENTER**; the Route Leg functions are displayed:

```
FOLLOW CLEAR REVERSE INSERT
ROUTE  ROUTE  ROUTE  WAYPOINT
```

D4719_1

3. Select INSERT WAYPOINT.
The cursor now controls the new waypoint which is connected to the existing waypoints on either side with a dotted line. The subsequent waypoint(s) are renumbered accordingly.
4. Using the trackpad, place the new waypoint and press **ENTER**.
5. Move the new waypoint to the required position and press **ENTER** to place it and return to normal cursor operation or **CLEAR** to cancel the operation.

6. Press **CLEAR** again to remove the function bar and route leg data.

The new waypoint is temporarily added to the waypoint list and named with the first available waypoint number. The waypoints in the current route are re-numbered to identify the new positions.

- To remove a waypoint from the route using the cursor:
 1. Place the cursor over the waypoint; see *Selecting a waypoint* in Section 3.2.. The Waypoint functions are displayed.
 2. Select REMOVE WAYPOINT; the waypoint is removed from the route.

3.4 Following routes and going to target points

The **GOTO** key accesses the functions to follow a route or go to a waypoint, port or current cursor position. When you select the target destination, the chartplotter calculates bearing, distance and cross track error; this information can be displayed or passed to an autopilot via NMEA. You can also restart the Cross Track Error (XTE) from the actual vessel position to set XTE to zero at that point.

When the chartplotter is following a route, the target destination is indicated by a square around the waypoint (or cursor marker) and a dotted line shows the intended track, from your start point or previous waypoint, to the target waypoint.

This section explains how to perform the following tasks:

- Follow a route.
- Reverse a route.
- Target Point Arrival.
- Altering the route, including joining at a selected waypoint, advancing waypoints and restarting XTE.
- Go to an individual point, either an existing waypoint or the cursor.
- Go to the nearest or a selected port.
- Stop and Restart Follow/Goto.

An alarm is triggered when you approach a waypoint. *Chapter 4* describes how to set the alarm.

- To access the follow and goto functions:
 1. Press the **GOTO** key to display the first level GOTO functions:

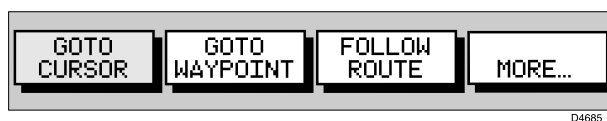

2. Select MORE to display the second level GOTO functions:



3. Select MORE to return to the first level functions.
4. Press **CLEAR** to return to the chart screen.

Note: *The functions differ if a FOLLOW or GOTO is already in progress (see Stop Follow or Stop Goto).*

Follow a route

Note: *If a route has been reversed or if a route on screen was being followed but stopped before completion, the target waypoint – outlined by a square box – may be different to when the route was created. You should always check the target waypoint before initiating a follow route.*

- To follow the current route:
 1. Press the **GOTO** key. The Goto/Follow functions are displayed. Alternatively, place the cursor over a route leg until the Route functions are displayed.
 2. Select FOLLOW ROUTE.

Your vessel's current position becomes the origin and the first waypoint in the current route becomes the target waypoint. A dotted line connects the vessel's current position to the target waypoint. This line remains fixed on screen as the vessel moves. The function bar is removed.

Reverse a route

This option enables a return route to be generated from an existing route which is then followed in reverse order, with waypoints renumbered accordingly.

- To reverse the current route:
 1. From the normal chart display **either**:
 - a) Press **ENTER** to display the primary function bar, then select ROUTES, followed by MORE, then REVERSE ROUTE.
 - or** b) Move the cursor over a route leg or waypoint until the ROUTE OPTIONS function is displayed. Press **ENTER** to display the options and select REVERSE ROUTE.

The current route is reversed on the screen and the waypoints are renumbered.

- To follow the reversed route:
 4. Press the **GOTO** key. The Goto/Follow functions are displayed.
 5. Press **FOLLOW ROUTE**.
Your vessel's current position becomes the origin and the first waypoint in the reversed route becomes the target waypoint. The function bar is removed.

Target point arrival

You can set up target alarms (see Chapter 4) to alert you when the vessel is approaching the target point. The arrival alarm is defined as a circle (not visible on the screen), with a specified radius around the target.

The alarm is triggered when either of the following conditions is met:

- The distance to the target point is less than that specified for the Arrival alarm.
 - Your vessel reaches the closest point of approach to the target (ie. it crosses a line passing through the waypoint and perpendicular to the track).
- To cancel the Arrival alarm and go towards the next waypoint in the route, press any key.

The target becomes the origin, the next waypoint becomes the target point and the two are connected by a dotted line indicating the current leg.

If the target waypoint was the subject of a GoTo, or was the last waypoint in a route, the pop-up alarm is cleared and any temporary waypoint is removed.

Alter a route

You can use the functions to follow a route from a selected waypoint (Join a route) or, if already following, you can advance to the next waypoint. You can also restart the XTE, setting the current vessel position as the new origin.

In addition, you can move a selected waypoint as described in section 3.2, or remove a waypoint from the route as described in section 3.3.

Join a route

- To start following the current route from a selected waypoint:
 1. Move the cursor over a route waypoint until the **ROUTE OPTIONS** function is displayed:

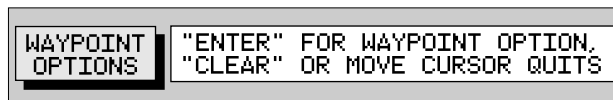

D4718_1

2. Press **ENTER** and select FOLLOW FROM HERE.

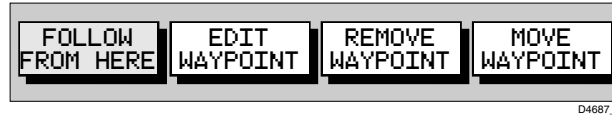

Your vessel follows the route, using the selected waypoint as the target.

3. To return to chart mode, move the cursor away from the waypoint or press **CLEAR**.

Advance to a waypoint

When following a route you can advance to the next waypoint, even if you have not reached the current target waypoint.

- To advance to a waypoint:

1. Press the **GOTO** key to display the Goto/Follow functions:

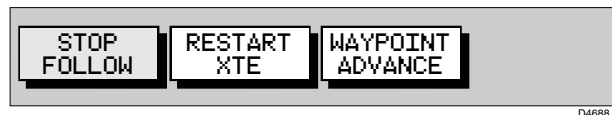

2. Select WAYPOINT ADVANCE. The current leg of the route is abandoned and the next waypoint becomes the target. The display is updated to show the new route leg.

Restart Cross Track Error (XTE)

Reset XTE is useful if you find yourself off track and want to go straight to your target, rather than get back onto the original track.

Whilst following a route, or going to a target point, you can restart the XTE. This sets the XTE to zero and moves the origin to the vessel's actual position.

- To restart XTE:

1. Press the **GOTO** key.

If following a route, the following functions are displayed:

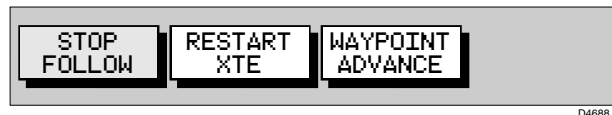

If a GOTO is already in progress, the following functions are displayed:



2. Select RESTART XTE. The dotted line between the previous and next waypoints is redrawn from the vessel's current position to the next waypoint and the XTE is reset to zero

Going to an individual target

Rather than following a route, you can go directly to a selected target. This can be an existing waypoint, a port or the current cursor position.

Go to a waypoint

► To navigate directly to an existing waypoint:

1. From the normal chart display **either**:

a) Use the trackpad to position the cursor over the required waypoint until the waypoint options function is displayed:

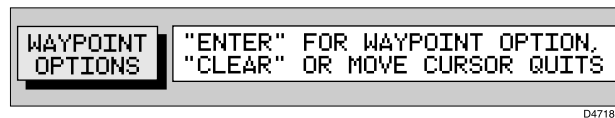

...then press **ENTER** to display the waypoint functions:

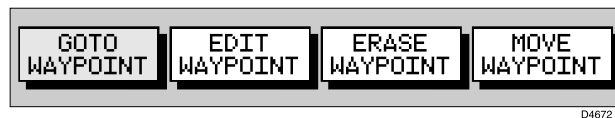

or b) press the **GOTO** key to display the waypoint options and select **GOTO WAYPOINT**; the waypoint list appears. Use the cursor to select the required waypoint:

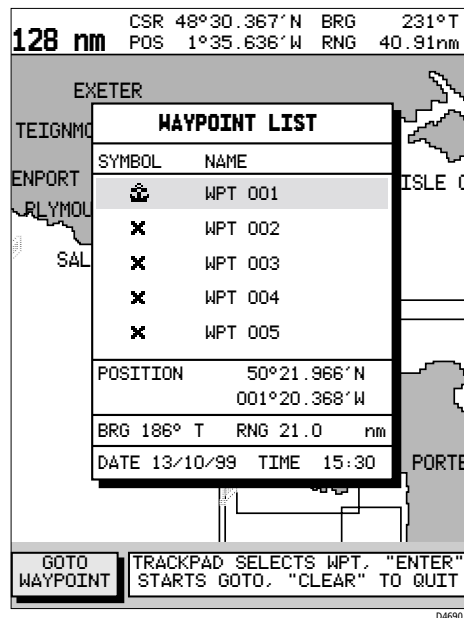

Alternatively, you can select the waypoint from the waypoint list as described in section 3.2

2. Select **GOTO WAYPOINT**.

A dotted line is drawn between the vessel's current position and the selected waypoint and navigation to the selected waypoint begins.

Go to cursor

Note: *If navigation is currently in progress or if the cursor is homed (Find Ship) it is not possible to go to cursor.*

- To navigate directly to the current cursor position:
 1. Press the **GOTO** key and select GOTO CURSOR. The GOTO CURSOR function now has help text appended to it:

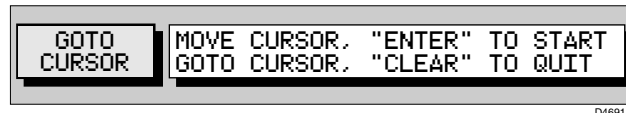

2. Use the trackpad to position the cursor as required.
3. Press **ENTER** to start the GoTo, or **CLEAR** to cancel the operation.

A temporary waypoint is placed at the cursor position and navigation proceeds towards it. The waypoint is shown as a square with a dot in the centre and is connected to the vessel's starting position with a dotted line.

On arrival, the arrival alarm is sounded and the arrival pop-up box is displayed.

Note: *The temporary waypoint is not added to the waypoint list; when the GoTo is complete, or is stopped, the temporary waypoint is erased.*

Go to a port

You can navigate directly to the nearest port or to a selected port or facility.

- To navigate directly to selected port:
 1. Press the **GOTO** key and select GOTO PORT to display the Port List.
 2. Use trackpad up/down to select the required port and press **ENTER** to start the GoTo, or **CLEAR** to cancel the operation.

A dotted line is drawn between the current vessel position and the target waypoint which is placed at the port. The line remains fixed on the screen as the vessel moves.

Bearing, Range and Cross Track Error are calculated for the target waypoint in the same manner as for GOTO CURSOR.

On arrival, the arrival alarm is sounded and the arrival pop-up box is displayed.

- To navigate directly to the nearest port or facility:
 1. Press the **GOTO** key and select GOTO NEAREST to display the list.
 2. Use trackpad up/down to select the required facility and press **ENTER** to start the GoTo, or **CLEAR** to cancel the operation.

The list shows the eight nearest places where the selected facility exists, in order of distance. The bearing and range (in selected units) for each one is shown.

3. Use trackpad up/down to select the required destination and press **ENTER** to start the GoTo, or **CLEAR** to cancel the operation.
The operation is conducted in the same manner as for GO TO PORT above.

Stop follow or stop goto

- To stop following the route or target point:
 1. Either press the **GOTO** key or move the cursor over the target waypoint.
 2. Select the STOP GOTO or STOP FOLLOW function respectively:

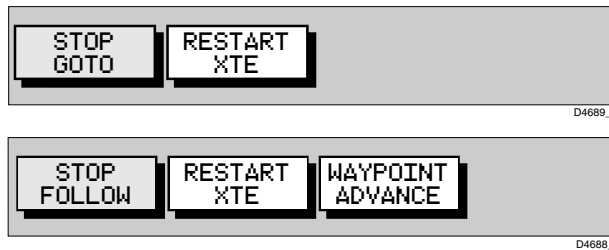

The dotted line from your vessel to the target waypoint disappears.

3.5 Changing the display mode

Use the **PAGE** key to select the required display mode. Repeat presses of the **PAGE** key provide the following display modes:

- Set Up functions (see Chapter 4)
- Course Deviation Indicator (CDI)
- Bearing & Distance Indication (BDI)
- Waypoint data
- Navigation data
- Time/Date data
- Return to Set Up functions

Note: Press **GOTO** in any display mode to return to normal Chart display.

- To change the display mode:
 1. Press the **PAGE** key to show the SET UP functions with SYSTEM SET UP highlighted:

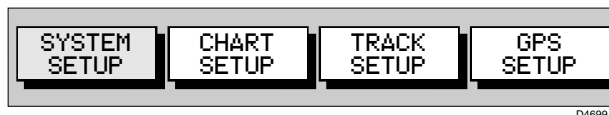

2. Repeat Step 1 to cycle through each of the available display modes.

Note: The Set Up Function Bar remains displayed in each display mode. To remove the Set Up Function Bar, press **CLEAR**.

CDI display

The CDI display shows Cross Track Error (XTE) and distance to waypoint presented in a 'runway' format:

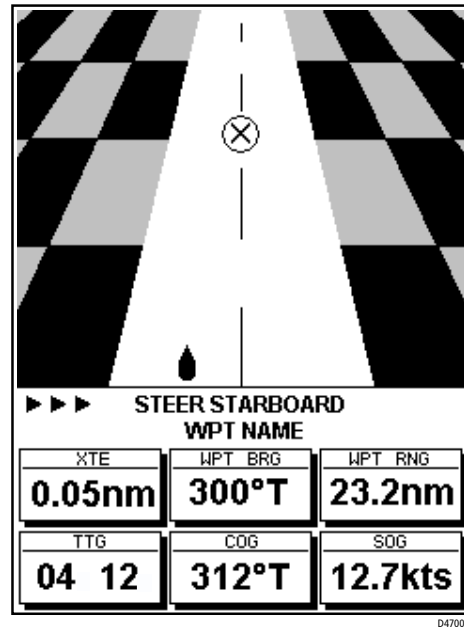

The 'runway' represents a 0.3nm width with the vessel symbol shown at the bottom. Bearing to Waypoint, Distance to Waypoint, Time to Go (TTG), Course Over Ground (COG) and Speed Over Ground (SOG) are also shown. Time to Go is calculated on the basis of distance to destination and Speed Over Ground (SOG) towards the destination.

At waypoint ranges greater than 4nm, the symbol remains at the top of the screen. As the waypoint range falls below 4nm, the symbol moves down the centre line.

The chequered pattern moves down the screen to simulate movement when SOG is greater than 2 knots.

The steering instruction is STEER STARBOARD if the XTE is 0.01nm or more to port, STEER PORT if the XTE is 0.01nm or more to starboard or ON COURSE if the XTE is less than 0.01 on either side. If no GOTO or follow is in progress, the steering instruction is NO TARGET.

The graphical XTE indication places arrows either side of the steering instruction and pointing towards it, dependent on the value of XTE.

The first arrow is shown when the XTE reaches 0.01nm, the second at .05nm and subsequently at 0.1nm intervals .

BDI display

The BDI display shows deviation from the bearing to waypoint and distance to waypoint. Cross track Error, Bearing to Waypoint, Distance to Waypoint, Time to Go, COG and SOG are also shown. Time to Go is calculated on the basis of distance to destination and velocity made good towards destination.

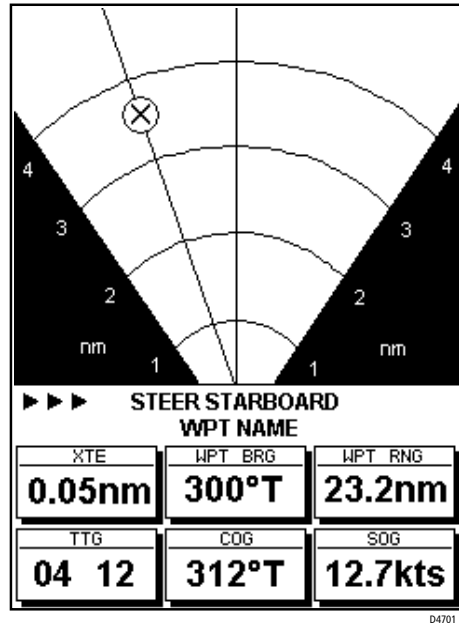

The line to the waypoint symbol is shown at an angle equal to the difference between the COG and the Bearing to Waypoint. The waypoint symbol is the symbol of the target waypoint as seen on the chart.

The range scale automatically scales for distance. The ranges shown are 4nm, 20nm, 40nm, 100nm, 200nm, 400nm, 1000nm, 2000nm, 4000nm. In each case the range scale has graduations at $\frac{1}{4}$, $\frac{1}{2}$ and $\frac{3}{4}$ of the current scale.

The steering instruction is STEER STARBOARD if the waypoint line is 1° or more to port, STEER PORT if the waypoint line is 1° or more to starboard or ON COURSE if the waypoint line is dead ahead. If no GOTO or follow is in progress, the steering instruction is NO TARGET, no steering arrows are shown, but the rhumb line indicator is shown.

The graphical XTE indication will place arrows either side of the steering instruction and pointing towards it dependent on the difference between COG and bearing to Waypoint. The first arrow is shown when the difference reaches 5° and thereafter at 5° intervals.

Waypoint data

The Waypoint Data display comprises text data occupying the whole screen :

ROUTE	
ROUTE 01	
WAYPOINT	
WPT 001	
BRG 234° T	
RNG 12.4 nm	
COG 230° T	TIME 13:29 12/12/99
SOG 6.8 Kts	TTG 01:03
XTE 0.5 nm	ETA 14:32 12/12/99
STEER STARBOARD	
▶▶▶▶	

D4702_1

If a route is not selected, the ROUTE field displays NO ROUTE.

The WAYPOINT field shows the name of the waypoint. If the waypoint is part of a route then the title field includes the waypoint index in the route. If there is no target waypoint the text indicates NO WAYPOINT and all waypoint data is shown as dashes, one per character. If a route is being followed and the waypoint is not named, the text shows the waypoint number within the route (as displayed on screen). If a GOTO Cursor or Port is in progress, the text indicates GOTO CURSOR or GOTO 'Port Name'.

BRG, RNG and XTE data relate to the target waypoint.

The Time refers to local time and is set in the System Set Up menu, *Chapter 4*.

The Time To Go (TTG) and Estimated Time of Arrival (ETA) data relate to the target waypoint (not the whole route) and are based on the Speed Over Ground (SOG) towards the target. If the VMG is negative, or data is not available, these fields are replaced by dashes, one per character.

The steering instruction is STEER STARBOARD if the XTE is 0.01nm or more to port, STEER PORT if the XTE is 0.01nm or more to starboard or ON COURSE if XTE is less than 0.01 on either side.

If no GOTO or follow is in progress, the steering instruction is NO TARGET, no steering arrows are shown, but the rhumb line indicator is shown.

The graphical XTE indication places arrows either side of the rhumb line indicator and pointing towards it, dependent on the value of XTE. The first arrow is shown when the XTE reaches 0.01nm, the second at .05nm and subsequently at 0.1nm intervals .

Note: *The steering instruction and graphical XTE indication are repeated on all text-only displays.*

Navigation data

The Navigation Data display comprises text data occupying the whole screen:

POSITION	
50°45	.000 N
001°06	.000 N (c)
COG	230° T
SOG	6.8 Kts
WAYPOINT	001
BRG 234° T	GPS FIX
RNG 2.4 nm	TIME 14:32 12/12/99
STEER STARBOARD	
▶▶▶▶	

D4703_1

Textual data provides Position, SOG, COG, Bearing and Range to waypoint, Time, Fix status and the XTE indicator. Any unavailable data is replaced by dashes, one per character. When there is no GPS fix but there is a value for the last fix, this is shown instead; POSITION is replaced with LAST POSITION.

The (c) indicator only appears when the position has been user calibrated.

The Fix indicator shows the GPS Fix status and indicates either FIX OK or NO FIX. In the case of a differential fix, D-FIX is displayed.

Note: *Graphical XTE indicator is as per Waypoint data screen, see above.*

Time/Date Data

The Time/Date display comprises text data occupying the whole screen:

SUNRISE	06.23		
SUNSET	21.34	TODAY	
AT POSITION (USER SELECTED)			
	50°45	.000 N	
	001°06	.000 W (c)	
TIME	12:34		
DATE	26/01/99		
ETA <WAYPOINT>	13:37	26/01/99	
TTG <WAYPOINT>	01:03		
ETA <ROUTE>	14:32	27/01/99	
TTG <ROUTE>	34:03		
STEER STARBOARD			
▶▶▶▶			

D4704-1

Textual data provides Sunrise and Sunset time, Current Time/Date, Waypoint and Route arrival times plus the XTE indicator.

Sunrise and Sunset times are for the selected day and at the selected position. The TODAY indicator emphasises that the sunrise and sunset times relate to the current day. If you select another day, the TODAY text is replaced with ON XX/XX/XX where XX/XX/XX is the selected date in the current format.

When the Time/Date screen is first opened, the data relates to the current day, unless there is no date information available. In this case the last date is used. The vessel's current position is used unless there is no GPS fix in which case the cursor position is used and shown as a USER SELECTED position.

The position data can be either as selected by you, in which case the text relating to the position is USER SELECTED, or the current position in which case the text is VESSEL.

The (c) indicator only appears when the position has been user calibrated.

The Time and Date fields show the local current time and date.

The TTG and ETA (WAYPOINT) data relates to the target waypoint. The TTG and ETA (ROUTE) data relates to the end of the route.

All data is based on the SOG towards the current target. If the SOG is negative, or data is not available, these fields are replaced with dashes, one per character.

3.6 Transferring waypoints and routes

Displayed waypoints

Waypoints and routes can be received and transmitted via NMEA, see also *Chapter 5, Section 5.4, Connecting to other equipment*. The NMEA link could be to a PC.

Managing database lists

The SEND WAYPOINTS function sends all waypoints in the Waypoint List and all routes in the Route List. Sending the Waypoint List does not affect current routes.

Note: *Sending the Waypoint List includes waypoints in an unsaved route.*

The RECEIVE WAYPOINTS function adds waypoints and routes received via NMEA to the Waypoint List and Route List.

Note: *Where multiple waypoints have the same position, the last waypoint sent is the only one included in the Waypoint List.*

► To send waypoints (and route lists):

1. From chart mode, press **ENTER**; the primary function bar is displayed:

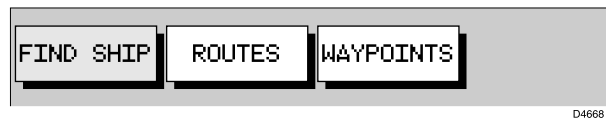

2. Using trackpad up/down, select WAYPOINTS.



3. Select WAYPOINT LIST.

The Waypoint List is displayed, with its associated function bar:

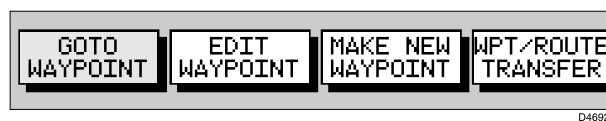

4. Initiate receiving of waypoints on the NMEA compatible equipment.
5. Select WPT/ROUTE TRANSFER.

The waypoint transfer functions are displayed:



6. Select SEND WAYPOINTS and press **ENTER**; the text changes to STOP SENDING.

7. To stop waypoint transfer, press **ENTER**.
- To receive waypoints and route lists:
1. Display the Waypoint List as previously described, then select WPT/ROUTE TRANSFER.
 2. Select RECEIVE WAYPOINTS and press **ENTER**; the text changes to STOP RECEIVING and remains selected.
 3. Initiate sending waypoints on the NMEA compatible equipment.
 4. To stop waypoint transfer, press **ENTER**.

Note: *If either the Waypoint List or Route List becomes full, a warning is displayed and the operation is terminated.*

3.7 Using tracks

The Track function is used to mark an on-screen trail that your vessel has followed, as if it had left a visible fixed wake.

While the track is turned on, it is recorded in the display unit's memory. You specify the interval at which track points are made and a line is drawn on-screen between each point. Up to 2000 track points can be saved in total.

The track remains on-screen, even following a Power off/on, until you clear the track.

Using the *SmartRoute* function, a track can also be converted to and saved as a route which is automatically reversed, ready for use as your return voyage.

This section describes how to:

- Set up a track and specify the interval between track points.
 - Clear the current track.
 - Convert the track to a route (*SmartRoute*).
- To access the track controls:
1. From chart mode, press the **PAGE** key to display the chart set up function bar:



2. Select TRACK SET UP to display the Track function bar:



D4695_1

The following instructions assume that the track functions are displayed.

Setting up a track

Use the track functions to switch the track on and to specify the interval at which track points are placed. The time interval between track points can be set to 1s, 10s, 30s, 1min, 10min or 30 minutes. The distance spacing between track points can be set to 0.05nm, 0.1nm, 0.5nm or 1nm. The maximum track length is 2000 points. When this limit has been reached, track points continue to be placed, but the oldest points start to be deleted. Track points continue to be placed until you switch track off; the current track is retained even when the unit is powered off.

Setting a short time interval between track points is best suited to navigation within a close or complex environment, eg. an estuary or marina whereas, in contrast, a greater distance interval is best suited to a long haul voyage.

When complete, a track can be converted to and saved as a route (*SmartRoute*).

Refer to the setting guide shown below to determine the best setting for your planned voyage; this is particularly important if you wish to use *SmartRoute* to convert your track to a route.

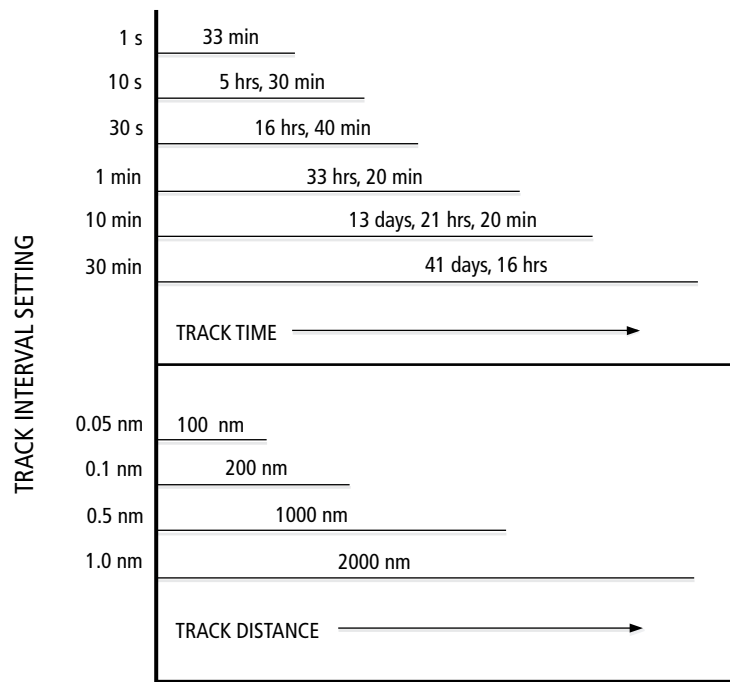

D4696_1

Track Interval Setting Guide

- To set up a track:
 1. Select the **INTERVAL** function.
Use trackpad up/down to select the appropriate options to set either a time interval or a distance interval; press up to increase the interval or down to decrease the interval.
 2. Use trackpad left/right to select **TRACK ON** and press **ENTER**.
The **TRACK ON** text changes to indicate **TRACK OFF**.
Your vessel's track is displayed on-screen with a line joining the points at the selected interval.

Clearing the current track

You can clear the current track from the screen.

- To clear the current track:
 1. Select **CLEAR TRACK**.
The current track is cleared from the screen and memory.
 2. If you do not require further track points to be placed, select **TRACK OFF** and press **ENTER**.
The **TRACK OFF** text changes to indicate **TRACK ON**.

SmartRoute

SmartRoute enables the latest track to be converted to a route.

- To convert a track into a route:
 1. Select **MAKE INTO ROUTE** and press **ENTER**.
The current track is converted to a new route, with the most recently placed track point as the start of the route, ie. the track is reversed.
If there is an unsaved current route on screen, the option to save the route is given, see *Section 3.3, Working with Routes*.
 2. Check the calculated route and, in particular, that the route deviation from the original, given in the warning box, is within navigable limits.

3.8 Man Overboard (MOB)

If you lose a person or object overboard, and need to return to the location, you should use the Man Overboard (MOB) function.

Note: *To obtain MOB position, you must have a valid GPS fix.*

- To initiate the MOB procedure, press and hold the **GOTO** key for two seconds. The system performs the following tasks automatically:
 - Stops any GoTo or Follow operation.
 - Selects a 1/2 nm scale (even if cartography is not available).

- Marks the current position as a temporary waypoint with an MOB symbol which replaces any current active waypoint and route.
- Displays the MOB data box, showing the bearing and range to the MOB position, the elapsed time since the MOB was initiated and COG data.
- Sends an MOB message, including bearing and range, to other units in the system, via NMEA.

Notes: (1) A suffix (c) to the POSition data indicates that the vessel's position has been User Calibrated, see Chart Set Up, Chapter 4.

(2) The **RANGE** key operates normally to change chart scale.

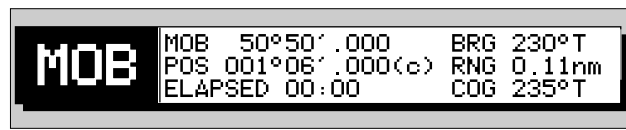

- To cancel MOB, press and hold the **GOTO** key for 2 seconds. The chart is re-drawn at its previous scale and the MOB symbol and data box are removed.

3.9 Alarms

The chartplotter reports the following alarms:

<u>Alarm</u>	<u>Indicates:</u>
Arrival	Your vessel has arrived at the active waypoint: it has either reached the arrival circle (the radius of which is specified) or, has reached its closest point of approach (defined by a line passing through the waypoint and perpendicular to the track).
XTE	Your vessel has exceeded the specified distance (maximum cross track error) from the active route leg.
Anchor	Your vessel has drifted from its anchor position (set when the alarm was turned on) by more than the specified distance.
No Fix	GPS fix or Differential data has been lost for more than 30 s.

The alarms are switched on or off, and the limits set, using the Chart Set Up function via the **PAGE** key menu, see Chapter 4.

When an alarm is triggered, the alarm buzzer sounds and a pop-up window, describing the alarm, is displayed.

- To silence the alarm and clear the message, press any key.

Chapter 4: Setting up the chartplotter

4.1 Introduction

When you have installed your system and are familiar with its basic operation, you may wish to set it up to operate according to your requirements and display information according to your preferences.

This is achieved using the function controls which are displayed when you press the **PAGE** key. These settings can be changed at any time.

When you have set your preferences, they maintain until you reset them; they are retained even when the unit is powered off.

This chapter covers the following topics:

- System parameters and default settings
- Chartplotter-specific parameters and default settings

The set up parameters are divided into three sections:

- **System**, controlling overall functionality
- **Chart**, controlling the chartplotting functions, including waypoint information and vectors.
- **GPS**, displaying the associated GPS (RC420) receiver status and dGPS set up (RC420D).

Note: *The additional TRACK SET UP function is covered in Chapter 3, Operation.*

This section provides instructions for displaying and changing the factory default values to your preferences. The following sections list the parameters and their possible settings and describe the function of each parameter in turn.

4.2 System set up parameters

- To set the System default parameters:
 1. From chart mode, with no function bar displayed, press the **PAGE** key to display the SET UP function bar:



D4694_1

2. Use trackpad left/right to highlight **SYSTEM SET UP** and press **ENTER** to display the System Set Up menu:

SYSTEM SET UP	
BEARING MODE	TRUE
KEY BEEP	ON
DISTANCE UNITS	nm
SPEED UNITS	KNOTS
DEPTH UNITS	METRES
VARIATION	5°W
DATE FORMAT	DD/MM/YY
TIME OFFSET	UTC
LANGUAGE	ENGLISH
SIMULATOR	ON
SIMULATED SOG	5.0 Kts
SIMULATED COG	340°T

D4711_1

- Use trackpad up/down to move the highlight up or down the list.
- When the required parameter is highlighted, use trackpad left/right to step through the settings.
- When you have reset to the required values, press **ENTER** to implement the change and return to the set up function bar.
- Press **CLEAR** to clear the function bar and return to the chart display.

Note: You can return all the settings to their original factory settings, if required, by performing a factory reset as described in Chapter 6.

The following table lists the System menus and their options, shows the factory default settings and provides space for you to make a note of your new settings. Each parameter is described in the following subsections.

Menu	Options	Factory Default	New Setting
BEARING MODE	MAGnetic TRUE	TRUE	
KEY BEEP	OFF/ON	ON	
DISTANCE UNITS	NAUTICAL MILES (nm) KILOMETRES (km) STATUTE MILES (sm)	NAUTICAL MILES	
SPEED UNITS	KNOTS KILOMETRES PER HOUR (KPH) MILES PER HOUR (MPH)	KNOTS	
DEPTH UNITS	METRES FEET FATHOMS	METRES	
VARIATION	30°W to 30°E (1° steps)	0.0E	

Menu	Options	Factory Default	New Setting
DATE FORMAT	DD/MM/YY MM/DD/YY	DD/MM/YY	
TIME OFFSET	UTC or local offset value up to ± 13 hours in 1-hr steps	UTC	
LANGUAGE	MULTI-LANGUAGE	ENGLISH	
SIMULATOR	OFF/ON	OFF	
SIMULATED SOG	00 Kt to 99 Kt in 1 Kt steps	00 Kt	
SIMULATED COG	000° to 359° in 1° steps	000°	

Bearing mode

The mode (MAGnetic or TRUE) of all the bearing and heading data displayed. This is indicated by M or T in the BRG or COG field of the Chart status bar.

Key beep

This setting controls audible feedback resulting from operation of the keys.

Note: *Alarms remain active.*

Units

You can set the units for distance, speed and depth. The units you set will be used to display all data. However, the distance units do not affect the chart scale, which is always in nautical miles.

Variation

The variation value is the difference between True and Magnetic direction data for heading or bearing values. The Magnetic value is derived from True by applying the user selected value of variation.

The variation is varied in 1° steps to 30° East or West. Press trackpad right to move the value eastward, or left to move it westward. The selected value is retained when the unit is switched off. The Default value is zero.

Date format

Set your preferred date format (DD/MM/YY or MM/DD/YY). The selected setting is retained when the unit switched off. The Default is DD/MM/YY.

Time offset

If you wish to display local time, use the trackpad to change from UTC to the required time offset. This can be up to plus or minus 13 hours, in 1 hour steps. The default is UTC.

Language

Select the language in which you wish information to be displayed. The selected language is used for screen text, labels, menus and options. Chart text, provided by the chart card, is not affected.

Simulator

The simulator allows you to operate your RayChart 420 without data from external sources. The options are ON or OFF.

When ON is selected the simulator will generate position, SOG and COG data and use the simulated data in place of any real data.

Note: *The simulated data overrides any real data that your display unit is receiving from externally connected equipment.*

The position is initially the position of the cursor when the simulator is switched on and the SOG and COG are as selected by the user. The position is updated to reflect the SOG and COG. See *Simulated SOG* and *Simulated COG* below.

If a GOTO or Follow is started, the simulator does not use the selected value of COG but, instead, generates a value of COG that simulates the navigation function in progress. When GOTO or Follow is stopped, the user selected value of COG is used.

Simulated SOG

Use horizontal movements of the trackpad to adjust the value of SOG which is adjustable in 1 knot intervals from 00 to 99.

The Default value is zero and the selected value is retained on power down.

If the simulator is switched OFF, the value is shown as dashes and no adjustment is possible.

Simulated COG

Use horizontal movements of the trackpad to adjust the value of COG which is adjustable in 1° intervals from 000° to 359°. It wraps around from 000 to 359 and from 359 to 000.

The Default value is zero and the selected value is retained on power down.

If the simulator is switched OFF, the value is shown as dashes and no adjustment is possible.

4.3 Chart set up parameters

The CHART SET UP function allows you to set up the chartplotter according to your system configuration and your personal preferences.

► To set the Chart default parameters:

1. Press the **PAGE** key to display the SET UP functions:



2. Use the trackpad left/right to highlight the CHART SET UP function and press **ENTER** to display the Chart Set Up menu:

CHART SET UP	
ORIENTATION	NORTH UP
PLOTTER MODE	ON
SHOW WAYPOINTS	ON
WAYPOINT SYMBOL	✕
AUTOZOOM	OFF
SCREEN AMPLIFIER	OFF
COG VECTOR	OFF
ARRIVAL CIRCLE	0.1 nm
ANCHOR ALARM	OFF
XTE ALARM	0.1 nm
CHART TEXT	ON
CHART BOUNDARIES	ON
DEPTH CONTOURS < 5M	ON
DEPTH CONTOURS 10M	ON
DEPTH CONTOURS > 20M	ON
POSITION CALIBRATION	OFF

D4712_1

3. Use trackpad up/down to highlight the required parameter, then use trackpad left/right to select the required setting.
4. When you have reset the required values, press **ENTER** to clear the menu and return to the set up function bar.
5. Press **CLEAR** to clear the function bar and return to the normal display.

Note: You can return all the settings to their original factory settings, if required, by performing a factory reset as described in Chapter 6.

The following table lists the Chart Set up parameters and their options, shows the factory default setting and provides a space for you to make a note of your new default setting. Each parameter is described in the following subsections.

Parameter	Options	Factory Default	New Setting
ORIENTATION	NORTH UP COURSE UP HEAD UP	NORTH UP	
PLOTTER MODE	OFF ON	ON	
SHOW WAYPOINTS	OFF ON	ON	
WAYPOINT SYMBOL	FISH,SKULL, ANCHOR or X	X	
AUTOZOOM	OFF ON	ON	
SCREEN AMPLIFIER	OFF ON	ON	
COG VECTOR	OFF ON	OFF	
ARRIVAL CIRCLE	0.01nm, 0.05nm, 0.1nm, 0.5nm	0.1nm	
ANCHOR ALARM	OFF, 0.01nm, 0.05nm, 0.1nm, 0.5nm	OFF	
XTE ALARM	OFF, 0.01nm, 0.05nm, 0.1nm, 0.3nm,0.5nm	OFF	
CHART TEXT	OFF ON	ON	
CHART BOUNDARIES	OFF ON	ON	
DEPTH CONTOURS <5M	OFF ON	ON	
DEPTH CONTOURS 10M	OFF ON	ON	
DEPTH CONTOURS >20M	OFF ON	ON	
POSITION CALIBRATION	OFF ON SET CAL	OFF	

Orientation

The chart orientation is normally North Up, but can be changed to Course Up or Head Up. The orientation modes give the following displays:

- **North Up:** The chart is displayed with north upwards. This is the default mode and is the only mode available if there is no COG data.
- **Course Up:** The chart is rotated such that the currently selected course (bearing to the target waypoint) or, if no navigation function is taking place, the current COG value is shown upwards.
To update the Course Up reference whilst Course Up is the current mode, re-select COURSE UP from the set up menu.
If you select a new course, eg. a new target waypoint, the chart displays the new course upwards.
- **Head Up:** The chart is displayed with the vessel's current COG upwards. As the heading changes the chart rotates periodically to maintain orientation.

Note: *Head Up and Course Up modes are dependent upon a valid GPS fix.*

Plotter mode

Plotter mode allows the user to zoom in beyond the level of cartography and continue to use plotter functions. The selected setting is retained when unit switched off.

Show waypoints

This option controls whether or not the waypoints are shown on the Chart display, with their appropriate symbols. The active waypoint, and waypoints in the current route, are always shown.

Waypoint symbol

This option allows selection of the symbol for waypoint display. The selected symbol is used for subsequent waypoints. Existing waypoints are not affected. The selected symbol is retained when the unit switched off.

Autozoom

When autozoom is enabled, commencing any navigation function or selecting FIND SHIP activates Autozoom. When active, this selects the chart range and position such that the vessel and the target waypoint are both on screen but at the largest scale possible. Moving the cursor off the vessel, or changing scale, deactivates Autozoom.

Autozoom will not zoom in beyond the largest cartographic scale (see also *Plotter Mode*). When in MOB mode, Autozoom is selected automatically and will zoom in as far as possible, irrespective of the selection of Plotter Mode.

Unless MOB is active Autozoom will not be activated if there is no cartridge or if the area being viewed is not covered by the cartridge.

Screen amplifier

Screen amplifier mode makes better use of the screen by positioning the vessel on the screen so as to increase forward visibility. The screen amplifier is only active when the cursor is 'homed' on the vessel.

COG vector

When ON, a vector line from the vessel is drawn in the direction of COG. This line extends to the edge of the screen. If COG is not valid, no line is drawn. The selected setting is retained when the unit switched off.

Arrival circle

The selected value is used as the arrival circle radius. When approaching the target waypoint, this is the distance at which the arrival alarm sounds. The selected setting is retained when unit switched off. Arrival criteria are met when the arrival circle is entered or a line perpendicular to the desired track and passing through the waypoint is crossed.

Anchor alarm

The selected value is used as the anchor alarm distance. If the vessel moves outside of the selected distance from its position (at the time that the alarm was enabled) the alarm sounds and an alarm message is displayed.

To silence the alarm, press any key. This removes the warning and resets the distance, ie. the alarm will not sound again unless the vessel moves the selected distance from its position (at the time that the alarm was silenced). The alarm is set to OFF on power up.

XTE alarm

The selected value is used as the cross track error limit. The alarm sounds when the cross track error exceeds the selected limit when a GOTO or a Route Follow is in progress and an alarm message is displayed.

Chart text

When ON, Chart text, eg. place names are shown on the screen. The selected setting is retained when the unit switched off.

Chart boundaries

When ON, Chart boundary lines are shown on the screen. The selected setting is retained when the unit switched off.

Depth contours <5M

When ON, depth contours less than 5 metres are shown. The selected setting is retained when the unit switched off.

Depth contours 10M

When ON, depth contours of 10 metres are shown. The selected setting is retained when the unit switched off.

Depth contours >20M

When ON, depth contours greater than 20 metres are shown. The selected setting is retained when the unit switched off.

Position calibration

When ON, all position data is offset from WGS 84 by the amount of the selected calibration and is suffixed by (c). The selected setting is retained when the unit switched off. The default calibration offset is zero.

► To perform position calibration:

1. Using horizontal trackpad movements, select **SET CAL**.

The menu is removed and a single function and help text are shown:

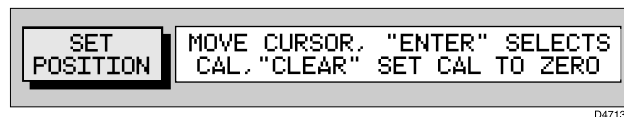

2. Using the trackpad, set the value of offset required. The distance and bearing of cursor from vessel is displayed in the Status Bar as BRG and RNG.
3. Press **ENTER** to confirm the selected offset value or **CLEAR** to reset the value to zero and return to the Chart Set Up menu.

An offset of 2nm or less is applied to all position data equal to the range and bearing between the WGS 84 position and the position entered. The menu returns with ON highlighted.

Note: Pressing **ENTER** with a selected offset of more than 2nm gives a warning message which is cleared on any key press. The Calibration Set Up mode maintains and the user can either reselect an acceptable offset or press **CLEAR** to reset the value to zero and return to the Set Up menu.

4.4 GPS setup

The GPS set up page provides information for the status of the tracked navigation satellites plus HDOP and satellite Fix Status. It also provides the ability to set up a Differential GPS (RC420D), by manually retuning it to a different differential beacon.

► To select GPS Set Up:

1. Press the **PAGE** key to display the SET UP functions:

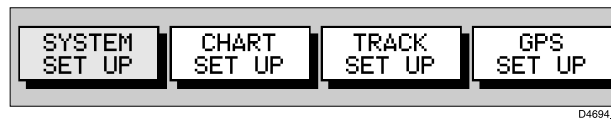

2. Use the trackpad to highlight the GPS SET UP function and press **ENTER** to display the GPS SET UP menu.

The GPS Status window is displayed as shown below. This provides, for each tracked satellite, the satellite number, a graphical signal strength bar, status, azimuth angle and its elevation angle from your vessel.

Positional accuracy is dependent upon these parameters; in particular, the azimuth and elevation angles are used in a triangulation process to calculate your position. HDOP (Horizontal Dilution Of Position) is a measure of this accuracy; a higher figure signifies greater error. In ideal circumstances, the figure should be in the region of 1.0. The Fix Status can indicate:

- NO FIX, where no satellite fix can be acquired
- FIX OK, where a satellite fix has been acquired
- D-FIX, where a differential beacon fix has been acquired

GPS STATUS				
SAT.	SIGNAL	STATUS	AZ.	ELEV.
15		SPARE	234	056
09		IN USE	054	027
08		IN USE	167	062
10		SPARE	232	012
20		SPARE	126	037
16		IN USE	075	085
18		SPARE	004	037
21		SPARE	026	063
04		SPARE	274	026
23		IN USE	147	071
06		IN USE	103	053
17		SPARE	253	071
HDOP		FIXED STATUS		
11.0		D-FIX		

D4714_1

The D-GPS SET UP function is also displayed, together with help text:

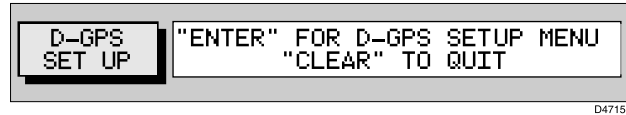

➤ To tune a differential GPS to another beacon:

1. Press **ENTER**; the Differential GPS Setup menu is displayed:

DIFFERENTIAL GPS SET UP	
MODE	MAN
BEACON FREQUENCY	287.5 kHz
BIT RATE	100 bps
BEACON ID	1024
SIGNAL STRENGTH	50 dB
SIGNAL/NOISE RATIO (SNR)	30 dB
DIFFERENTIAL AGE	2 s

D4716_1

2. Using vertical trackpad movements, select **MODE**.
3. Using horizontal trackpad movements, alternates between **MAN** and **AUTO**; select **MAN** to set the beacon to manual tuning.
4. Using vertical trackpad movements select **BEACON FREQUENCY** and use horizontal trackpad movements to set the required beacon frequency. The frequency is adjustable between 283.5kHz and 325.0kHz in 0.5kHz steps.
5. Using vertical trackpad movements select **BIT RATE** and use horizontal trackpad movements to set the bit rate value. The bit rate value is selectable as either 100bps or 200bps.
6. Press **ENTER** to select the new beacon settings and return to the GPS Status window, then press **CLEAR** again to return to the Setup functions.

The Beacon ID indicates the beacon transmitter reference number. The received signal strength and signal to noise ratio (SNR) are indicated in dB. The SNR provides a measure of the quality of the received signal and is dependent upon signal strength. The greater the signal strength, the better the SNR is likely to be. Generally, the best signal is determined by the distance from the transmitter and the obstacles in between.

Differential Age indicates the time elapsed since the last differential beacon fix.

A list of beacon stations is available from your local Raytheon distributor or the Raytheon Marine website: www.raymarine.com

Chapter 5: Installation

5.1 Introduction

This chapter provides instructions to assist in planning the installation of the RayChart 420 Chartplotter aboard your vessel.

Note: *If you wish to practice using the RayChart 420 before installation, you can connect it, via a 1A quick blow fuse, to a 12Vdc power supply and operate it using the simulator mode, as described in Chapter 2 Getting Started.*

EMC Installation Guidelines

All Raytheon equipment and accessories are designed to the best industry standards for use in the leisure marine environment.

Their design and manufacture conforms to the appropriate Electromagnetic Compatibility (EMC) standards, but correct installation is required to ensure that performance is not compromised. Although every effort has been taken to ensure that they will perform under all conditions, it is important to understand what factors could affect the operation of the product.

The guidelines given here describe the conditions for optimum EMC performance, but it is recognised that it may not be possible to meet all of these conditions in all situations. To ensure the best possible conditions for EMC performance within the constraints imposed by any location, always ensure the maximum separation possible between different items of electrical equipment.

For **optimum** EMC performance, it is recommended that **wherever possible**:

- All Raytheon equipment and cables connected to it are:
 - At least 1 m (3 ft) from any equipment transmitting or cables carrying radio signals e.g. VHF radios, cables and antennas. In the case of SSB radios, the distance should be increased to 2 m (7 ft).
 - More than 2 m (7 ft) from the path of a radar beam. A radar beam can normally be assumed to spread 20 degrees above and below the radiating element.
- The equipment is supplied from a separate battery from that used for engine start. Voltage drops below 10V in the power supply to our products, and starter motor transients, can cause the equipment to reset. This will not damage the equipment, but may cause the loss of some information and may change the operating mode.
- Raytheon specified cables are used at all times. Cutting and rejoining these cables can compromise EMC performance and so must be avoided unless doing so is detailed in the installation instructions.

- If a suppression ferrite is attached to a cable, this ferrite should not be removed. If the ferrite needs to be removed during installation it must be reassembled in the same position.

Suppression ferrites

The following illustration shows typical cable suppression ferrites fitted to Raytheon equipment. Always use the ferrites supplied by Raytheon.

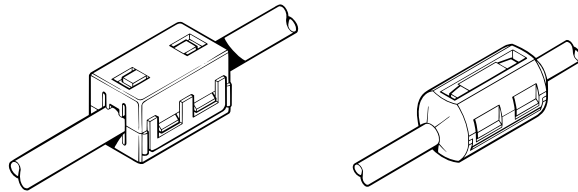

Connections to other equipment

If your Raytheon equipment is to be connected to other equipment using a cable not supplied by Raytheon, a suppression ferrite **MUST** always be fitted to the cable close to the Raytheon unit.

5.2 Unpacking and inspecting the components

Unpack your RayChart 420 Chartplotter carefully. Retain the carton and packing materials in the event that you need to return the unit for service.

Check that you have all the correct system components. These depend on your system package:

Item	Part No.	Supplied with
RC420 System	E32012	
comprising:		
RC420 Chartplotter	E32014	RC420
RS112LP	E32002	RC420
RC420D System	E32013	
comprising:		
RC420 Chartplotter	E32014	RC420D
RS114	E32003	RC420D
RC420 Accessories:		
Sun cover	E35004	All
Panel mounting kit	E35006	Optional
Trunnion mount kit	E35005	All
Power cable	R38024	All
GPS extension cable	E35003	Optional
Handbook	81162	All
Quick Reference Card	86051	All

Items Missing?

If any of the above items are missing or damaged, please contact your Raytheon dealer or our Product Support Department to obtain replacement parts. **Please note that missing or damaged items cannot be replaced without proof of purchase.**

Registering this Product

When you have checked that you have all of the listed components, please take the time to complete the pre-paid warranty registration card. This ensures that you receive prompt and expert attention should you experience any difficulties with the product.

5.3 Location

This section provides information affecting the possible location of the unit for ease of use, access for servicing and its position relative to the power supply.

Selecting the best location

The unit can be mounted using the trunnion (yoke) bracket, or panel mounted using the optional Panel Mounting Kit.

When planning the installation of your RayChart 420, the following points should be considered to ensure reliable and trouble free operation:

- **Convenience:** The unit should be installed in a convenient position where it can be viewed straight on or with a viewing angle of less than 35°. You may wish to apply power, before you install the unit, to determine the best viewing angle prior to fixing. The mounting location should be easily accessible to allow operation of the front panel controls.
- **Access:** There must be sufficient space behind the display unit to allow cable connections to the rear panel connectors, avoiding tight bends in the cable. At least 4cm should be allowed at the right to enable chart cards to be inserted and removed.
- **Interference:** The selected location should be far enough away from devices that may cause interference, such as motors and generators (see the EMC guidelines earlier in this section).
- **Cable runs:** The unit must be located near a dc power source. The power cable supplied is 1.5m, but a longer cable can be used if required. Power must be supplied via a 1A quick blow fuse or circuit breaker. Refer to *Section 5.6 Cabling*.

- **Environment:** The unit should be protected from physical damage, heat sources and excessive vibration. Although the unit is waterproof, it is good practice to mount it in a protected area away from prolonged and direct exposure to rain and/or salt spray.

The dimensions of the unit, including the bracket, are shown in the following diagram.

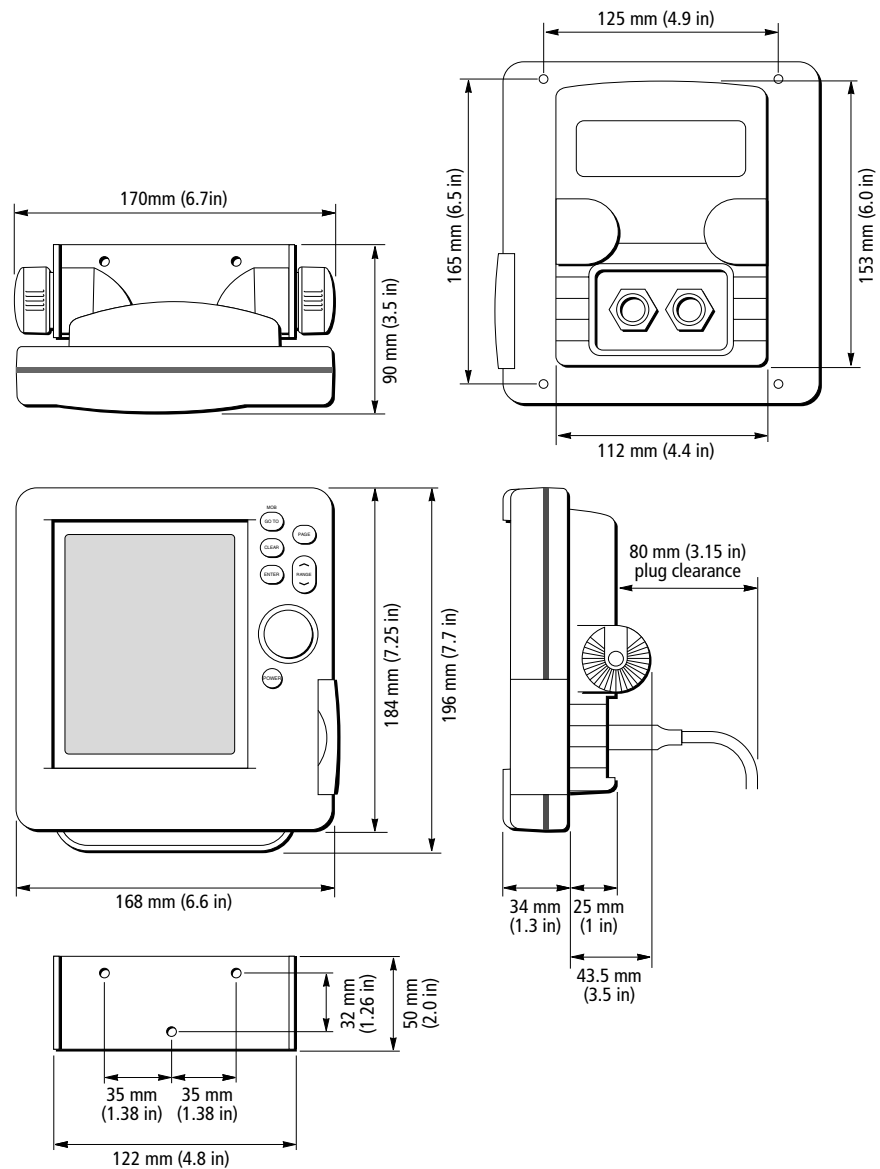

D4721-1

5.4 Connecting to other equipment

The unit transmits navigation and waypoint data on NMEA and, therefore, can be connected to an NMEA⁽¹⁾ compatible autopilot or compatible instrument repeater(s). The navigation data transmitted by the chartplotter is detailed in *Appendix B* to this handbook.

⁽¹⁾ *National Marine Electronics Association (NMEA) 0183 interconnection standard, Version 2.3 April 1998.*

5.5 Mounting the chartplotter

Trunnion (yoke) mounting

The display unit can be conveniently mounted on a dash area, chart table, bulkhead or deckhead, as shown in the following diagram.

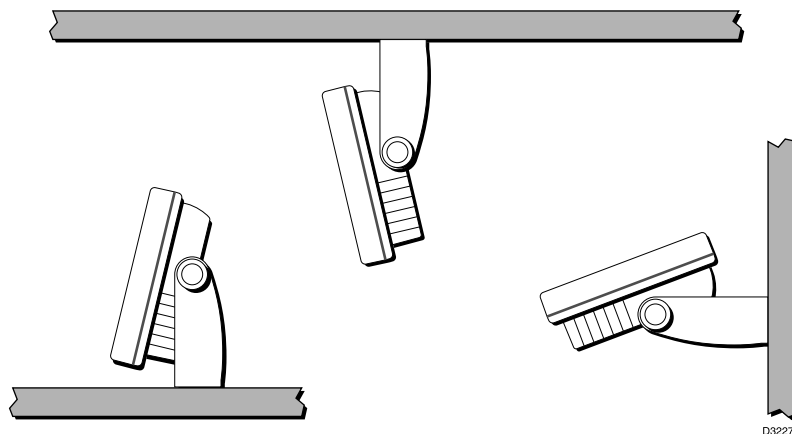

1. Loosen the trunnion knobs and remove the trunnion from the display unit.
2. Mark the locations of the trunnion screw holes on the mounting surface.
3. Use the screws supplied to fix the trunnion at the marked locations.
4. Fit the unit to the trunnion, adjust the display angle and tighten the knobs.
5. Connect the Power/NMEA and GPS cables to the unit, avoiding tight bends in the cables.

Panel mounting

CAUTION:

Make sure that there are no hidden electrical wires or other items behind the location before proceeding. Make sure that there is sufficient rear access for mounting and cabling. Allow at least 4cm at the right hand side of the display to enable chart cards to be inserted and removed.

The unit can be panel mounted, using the panel-mounting kit (accessory) available from your local Raytheon dealer.

► Panel mount the unit as follows:

1. Check the selected location for the unit. A clear, flat area at least 175mm (7in) wide by 190mm (7½in) high, with at least 90mm (3½in) of clearance behind the panel, is required.
2. Unpack the (optional) panel-mounting kit.
3. Using the supplied template, trace out the display unit cut-out and mark the drilling centres for the four securing holes outside of the cut-out area.
4. To provide start holes for removing the cut-out, drill four 10mm ($\frac{3}{8}$ in) holes in each opposing corner and four 6mm ($\frac{1}{4}$ in) holes for the two trunnion lug clearance slots in the cut-out area.
5. Using a suitable saw, cut along the inside edge of the cut-out line.
6. With the trunnion (yoke) and knobs removed, make sure that the unit fits in the cut-out area.
7. Drill out the four 5mm ($\frac{3}{16}$ in) securing holes as indicated on the template. It is recommended that a 1mm ($\frac{1}{16}$ in) pilot hole is drilled first.
8. Screw the studs into the vacant holes at the rear of the unit, hand tight only.
9. Place the gasket on the unit and slide the unit into the panel cut-out.
10. Secure the unit with the thumb nuts, hand tight only.

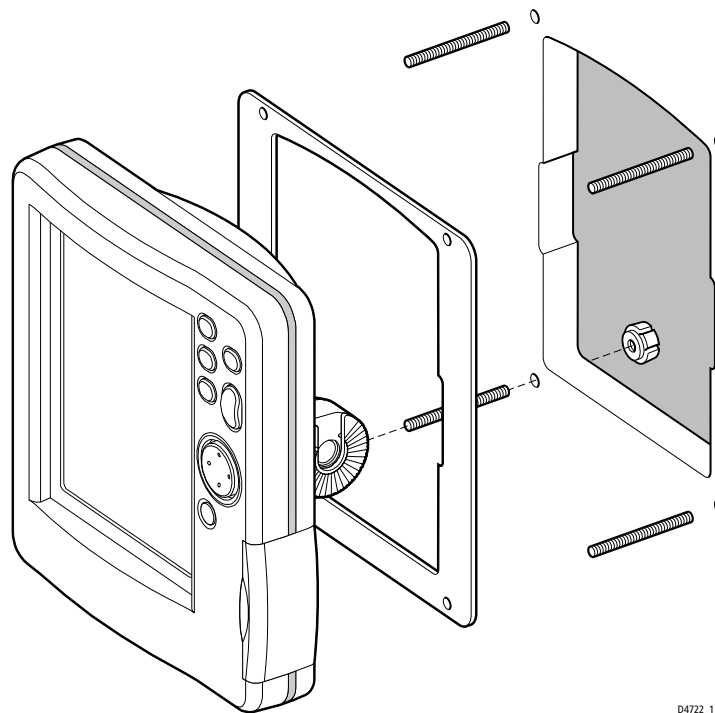

D4722_1

5.6 Cabling

Introduction

The following points need to be considered before installing the system cables:

- The minimum requirements are a power cable and a connection from the associated GPS. Additional cables will be required if you are connecting to other equipment.
- All cables should be adequately cleated and protected from physical damage and exposure to heat. Avoid running cables through bilges or doorways, or close to moving or hot objects.
- Where a cable passes through an exposed bulkhead or deckhead, a watertight gland or swan neck tube should be provided.

You need to run the following cables:

- **POWER/NMEA cable**, supplied with the unit. This has a connector at one end for connecting to the unit and seven cores at the other for connecting the power supply and (optionally) NMEA.
- **GPS cable** from the associated GPS antenna with a connector at one end.

Chartplotter connectors

The following connectors are provided at the rear of the chartplotter:

- **GPS**, for connection to the associated GPS receiver.
- **POWER/NMEA**, for 12Vdc power connection and NMEA inputs/outputs.

GPS connector

The GPS connector provides power and data connections to the associated GPS (RC420) or dGPS (RC420D).

- Connect the GPS/dGPS using the attached cable, as follows:
 1. Mount the GPS/dGPS according to its accompanying Installation Guide.
 2. Feed the cable through to the rear of the chartplotter.
 3. Coil up any unused cable in an appropriate safe space out of view. Do not bend the cable tighter than 100mm (4in) radius.

Note: *If the supplied cable is too short, use an extension cable (Part# E35003) available from your local Raytheon dealer.*

Connections to the GPS connector on the rear of the display unit are detailed in the following table:

GPS Function	Color
+12V dc	Red
0V dc	Black
Ground I/O	White
Data in from GPS	Green
Data out to GPS	Yellow

POWER/NMEA connector

CAUTION:

If you do not have a breaker in your power circuit, you must fit an in-line 1A quick-blow fuse to the positive (red) lead of the power cable.

This unit is not intended for use on positive ground vessels.

The power connections should be made at a dc power distribution panel through an isolator switch, a 1A circuit breaker or a 1A quick blow fuse. Check that all connections are clean and tight.

The dc power system should be either:

- Negative ground, with the negative battery terminal connected to the vessel's ground.
- Floating, with neither battery terminal connected to the vessel's ground.

The chartplotter is intended for use on vessels' dc power systems operating in the range 10.0Vdc to 18.0Vdc (ie. 12V systems, not 24V or 32V systems). A 1.5m (5ft) power cable is supplied .

If a longer power cable run is required, use the supplied power cable to connect to the unit, then use a suitable connector block to connect the free end to the extension cable. The supplied power cable has a cross-section of 2.0mm².

Longer power cable runs may require larger wire gauges to minimise any voltage drop in the cable. In order to determine the correct supply cable size if the power cable must be extended, estimate the length of cable between the vessel's main power source and the connector block then select the wire size indicated by the distance in the following table.

Maximum Extension Power Cable Lengths (m)

Power Cable Core mm ² :	1.5	2.0	2.5	4.0	6.0	10.0
AWG:	16	15	14	12	10	8
Maximum extension (m)	11.0	15.0	20.0	30.0	45.0	70.0

The dc power and NMEA inputs/outputs should be connected to the POWER/NMEA connector at the rear of the RayChart 420. The connector pin functions are detailed in the following table.

Function	Color
Battery negative	Black
Battery positive (10.0Vdc to 18.0Vdc)	Red
NMEA data input (+ve)	White
NMEA input (-ve) - common	Green
Not connected	Grey
NMEA data out	Yellow
Data output common	Brown
Not connected	Screen

- Connect the power supply using the standard power cable supplied, as follows:
 1. Connect the moulded power plug to the POWER/NMEA connector on the rear of the chartplotter. Run the free end back to the vessel's distribution panel or, if insufficient cable length to a junction box.
 2. Cut the cable to length and connect the red wire, via a fuse, to the +ve battery terminal and the black wire to 0V (-ve battery terminal). Protect the circuit with a 1A quick blow fuse or circuit breaker.
 3. Use a suitable junction box to connect to NMEA equipment if required.
 4. Cut any unused cores short or insulate and tape back.

Note: *If the power connections are accidentally reversed, the system will not function. Use a volt meter to check that the input power leads are connected with the correct polarity.*

5.7 System Check and Initial Switch On

When you have installed your Chartplotter and made all the connections, you need to check your installation before using the system for navigation. If you encounter any problems, refer to Chapter 6, Maintenance and Fault Finding.

EMC Conformance

Always check the installation before going to sea to make sure that it is not affected by radio transmissions, engine starting etc.

System Check

Before performing the functional test, check that:

- All securing bolts are fully tightened and mechanical locking arrangements as specified are in place.
- All connections have been made.
- All connecting wires are secured and protected as necessary.

Initial Switch On

To switch on the display unit, press and hold the **POWER** key until the unit beeps.

If necessary, adjust the lighting and contrast (see *Chapter 2*).

If required, change the default language settings as follows:

1. Press the **PAGE** key to display the setup function bar.
2. Using trackpad left/right, select the SYSTEM SET UP function and press **ENTER**.

The SYSTEM SET UP menu is displayed, listing the parameters and their current settings. The complete list, which you can scroll through, is shown in the following illustration:

SYSTEM SET UP	
BEARING MODE	TRUE
KEY BEEP	ON
DISTANCE UNITS	nm
SPEED UNITS	KNOTS
DEPTH UNITS	METRES
VARIATION	5°W
DATE FORMAT	DD/MM/YY
TIME OFFSET	UTC
LANGUAGE	ENGLISH
SIMULATOR	ON
SIMULATED SOG	5.0 Kts
SIMULATED COG	340°T

D4711_1

3. Using trackpad up/down, select the LANGUAGE option.
4. Using trackpad left/right, select the required language.
5. Press **ENTER** to return to the setup functions. The chartplotter now uses the selected language.
6. Press **CLEAR** to return to the normal chart screen.

Checking the Chartplotter Operation

To confirm that your chartplotter is operating correctly, perform the following checks:

1. Without a Navionics Microchart® card fitted, verify that the world map is visible.
2. Press the trackpad left/right, up/down and check cursor movement and normal scrolling action.
3. Insert a Navionics Microchart® card for the area of your vessel.
Use the **RANGE** key to zoom-in to check that the new chart cartridge is being displayed.
4. Ensure that position data is available; use the **FIND SHIP** function to check that the cursor is fixed on the vessel symbol which is correctly positioned at the centre of the chart display, see *Chapter 3, Operation*.

Chapter 6: Maintenance & fault finding

This chapter provides information on routine maintenance and on possible causes of problems you may experience with your RayChart 420 Chartplotter.

6.1 Maintenance

Warnings



The chartplotter contains **high voltage** and specialised circuits only accessible to qualified service technicians - there are no user serviceable parts or adjustments and **the operator should not attempt to service the equipment**. The operator should not remove the rear cover .

Routine checks

The Chartplotter is a sealed unit. Maintenance procedures are therefore limited to the following periodical checks:

- Wipe the display unit clean with a damp cloth.
- Examine the cables for signs of damage, such as chafing, cuts or nicks.
- Check that the cable connectors are firmly attached and that the connections to the vessel's dc power are clean and tight.
- Ensure that the cartridge cover is always fitted correctly.

Note: *Never use chemical or abrasive materials to clean the chartplotter. If the unit is dirty, wipe it with a clean, damp cloth.*

Servicing and Safety

Raytheon equipment should be serviced only by authorised Raytheon service technicians. They will ensure that service procedures and replacement parts used will not affect performance. There are no user serviceable parts in any Raytheon product.

Some products generate high voltages, so never handle the cables/connectors when power is being supplied to the equipment.

When powered up, all electrical equipment produces electromagnetic fields. These can cause adjacent pieces of electrical equipment to interact with one another, with a consequent adverse effect on operation. In order to minimise these effects and enable you to get the best possible performance from your Raytheon equipment, guidelines are given in the installation instructions, to enable you to ensure minimum interaction between different items of equipment, i.e. ensure optimum Electromagnetic Compatibility (EMC).

Always report any EMC-related problem to your nearest Raytheon dealer. We use such information to improve our quality standards.

In some installations, it may not be possible to prevent the equipment from being affected by external influences. In general this will not damage the equipment but it can lead to spurious resetting action, or momentarily may result in faulty operation.

6.2 Resetting the system

Two types of reset are available for the Chartplotter:

- **Power-On Reset:** When you turn the display unit off, then on again, the screen reverts to the chart display with all windows cleared.
- **Factory Reset:** This resets all values back to their original factory settings.

Note: *Take care - factory reset clears all Waypoint and Route databases.*

At power-on, the last-used values are retained for all the options, except for those listed in the following table which are reset to the factory default each time.

Item	Power-on setting
Heading Mode	North Up
Alarm	ON, with last-used value
Contrast Level	Within 30-70% range, if last-used value outside this range
Backlight Level	ON at the lowest level if previously ON

- To perform a factory reset:
1. Power off the unit.
 2. Press and hold **CLEAR** whilst powering up until <Erase backup procedure> is displayed.
 3. Either press **CLEAR** to abort Factory Reset and resume normal Power-Up or press **ENTER** to continue Factory Reset.
 4. Press **ENTER** again; the unit restarts as for a first time Power Up with all values reset to their original factory settings

Note: *The factory default settings are listed in Chapter 4.*

6.3 Problem solving

Prior to packing and shipping, all Raytheon products are subjected to comprehensive test and quality assurance programmes. However, if this unit should develop a fault, please refer to the following table to identify the most likely cause and the corrective action required to restore normal operation.

If you still have a problem after referring to the table, contact your local dealer, national distributor or Raytheon Product Support for further advice.

Always quote the product serial number.

Fault finding

Problem	Correction
Unit does not function	<ol style="list-style-type: none"> 1. Make sure that the power supply cable is sound and that all connections are tight and free from corrosion. 2. Check polarity of the dc power cables for proper connection. Reconnect leads if necessary. 3. Check in-line fuse. Replace if necessary. 4. Check vessel's power (battery) for correct voltage readings (10.0Vdc to 18.0Vdc)
Poor display definition	Adjust contrast setting and/or backlight level
No position information	Check the GPSconnection Check the GPSreceiver/antenna
No fix No dfix (RC420 only)	Check that GPS receiver not obstructed Check beacon station coverage Check antenna ground (see GPS antenna Installation Guide)
No NMEA data received	Check the POWER/NMEA connector and the NMEA equipment
Loss of stored data, eg. waypoints	Return to dealer for internal battery check
No detailed chart data	Check that Nav-Chart card is pushed fully home Check that the Nav-Chart card has appropriate cartography
Other problems	visit website www.raymarine.com

6.4 Worldwide support

In the first instance, contact the authorised distributor in your own country. A list of worldwide distributors is supplied with your system.

Or visit the Raytheon World Wide Web site:
www.raymarine.com

How to contact Raytheon Marine (US)

For accessories and parts

Many Raytheon accessory items and parts can be obtained directly from your authorized Raytheon dealer. However, if you are in need of an item not available from the retailer, please contact:

Sales & Order Services at: 1-800-539-5539 Extension 2333
or (603) 881-5200 Extension 2333

Sales & Order Services are available Monday through Friday 8:15am to 5:00pm Eastern Standard Time.

Please have the Raytheon item or part number ready when calling if placing an order. If you are not sure which item is appropriate for your unit, you should first contact the Technical Support Department at:

1-800-539-5539 Extension 2444
or (603) 881-5200 Extension 2444
to verify your requirements.

For technical support

For technical support, call: 1-800-539-5539 extension 2444
or (603) 881-5200 Extension 2444

The Raytheon Fax number is 1-603-864-4756

Or visit the Raytheon Marine World Wide Web site:
www.raymarine.com

Our Technical Support specialists are available to answer questions about installing, operating and trouble-shooting all Raytheon products. Questions may be addressed directly to our Technical Support Department via email at:
rmc_tech_raytheon@raymarine.com

For product repair and service

In the unlikely event your Raytheon unit should develop a problem, please contact your authorized Raytheon dealer for assistance. The dealer is best equipped to handle your service requirements and can offer timesaving help in getting the equipment back into normal operation.

In the event that repairs can not be obtained conveniently, product service may also be obtained by returning the unit to Raytheon's Product Repair Center using the prepaid UPS shipping tag supplied with your unit to:

Raytheon Product Repair Center
22 Cotton Road Unit H
Nashua, NH 03063

The Product Repair Center is open Monday through Friday 8:15am. to 5:00pm Eastern Standard Time. All products returned to the Repair Center are registered upon receipt. A confirmation letter will be sent to you acknowledging the repair status and the product's reference number.

Should you wish to inquire about the repair status of your unit, contact the Product Repair Center at 1-800-539-5539 Ext. 2118. Please have the product reference number, or unit serial number, ready when you call. We will do everything possible to repair and return your unit as quickly as possible.

How to contact Raytheon Marine (Europe)

Raytheon Marine Company
Anchorage Park
Portsmouth
PO3 5TD England
Tel: +44 (0)23 9269 3611
Fax: +44 (0)23 9269 4642

For accessories and parts

In Europe, Raytheon support, service, accessories and parts may be obtained from your authorised dealer. Please refer to the lists of component part numbers and accessories in *Chapter 5, Installation* and have the Raytheon part number ready when contacting your dealer.

If you are not sure which item is appropriate for your unit, you should first contact the Customer Services Department .

For technical support

The Customer Services Department handles enquiries concerning installation, operation, fault diagnosis and repair.

For technical helpdesk, Tel: +44 (0)23 9271 4713
Fax: +44 (0)23 9266 1228

Our technical support staff may also be reached via email at:
techsupra@raytheon.com

Appendix A: Specification

CE Y2K	Conforms to 89/336/EEC(EMC), EN60945:1997 Compliant	
Size	184mm (7.3in) x 168mm (6.7in) x 75mm (3in), excluding trunnion	
Weight	0.75 kg (1.65 lb)	
Environmental	Waterproofing	To CFR46; suitable for external mounting
	Temp Range	Operating: -10°C to 70°C
	Temp Range	Storage: -20°C to 70°C
	Humidity	20% to 95% RH
Mounting	Trunnion (yoke) or panel	
Power Input	10.0Vdc to 18.0Vdc 12Vdc nominal	
	Consumption - Typical	<9.6W @12Vdc including GPS or dGPS
Controls	6 defined keys and trackpad	
Display type	Film Super Twist Neumatic -(FSTN) LCD 320 x 240 pixels (1/4VGA) monochrome portrait with 4 grey scales, 4 levels of backlighting, 16 levels of contrast	
Display size	145mm (6in) diagonal 117mm (4.25in) x 88mm (3.5in) viewable area	
Interfaces	Power/NMEA	NMEA 0183 receive and transmit Waypoint upload/download (WPL and RTE)
	GPS	GPS/dGPS* antenna
Position data	GPS (RC420), dGPS* (RC420D)	
Cartography	Navionics Microchart cartridge	
Software update	Via Cartography cartridge interface	
Memory	Capacity:	Waypoints: 500 max (20 routes of up to 50 waypoints) Track history: 2000 points
	Protection:	Built in Lithium battery giving 3 to 5 years usage

* Differential GPS

Appendix B: NMEA data

Connector	Received	Transmitted
POWER/NMEA	GGA, GSV, GSA, GLL, VTG, MSS, WPL, RTE,	GGA, GSV, GSA, GLL, VTG, MSS, WPL, RTE XTE, APB, BWR, MSK

Connector	Received	Transmitted
GPS	GGA, GSU, GSA, GLL, VTG, MSS	MSK

Appendix C: List of abbreviations

BDI	Bearing Deviation Indicator
BTW	Bearing To Waypoint
CDI	Course Deviation Indicator
COG	Course Over Ground. The actual direction of your vessel's movement over the ground.
dGPS	Differential Global Positioning System
DTG	Distance To Go
EMC	Electro-Magnetic Compatibility
ETA	Estimated Time of Arrival
GPS	Global Positioning System
HDOP	Horizontal Dilution Of Precision. The multiplicative factor that modifies ranging error. It is caused solely by the geometry between your vessel and your set of satellites.
MOB	Man OverBoard
NMEA	National Marine Electronics Association (interconnection standard)
SOG	Speed Over Ground. The rate of movement of the vessel over the ground.
TTG	Time To Go
WPT	Waypoint
XTE	Cross Track Error

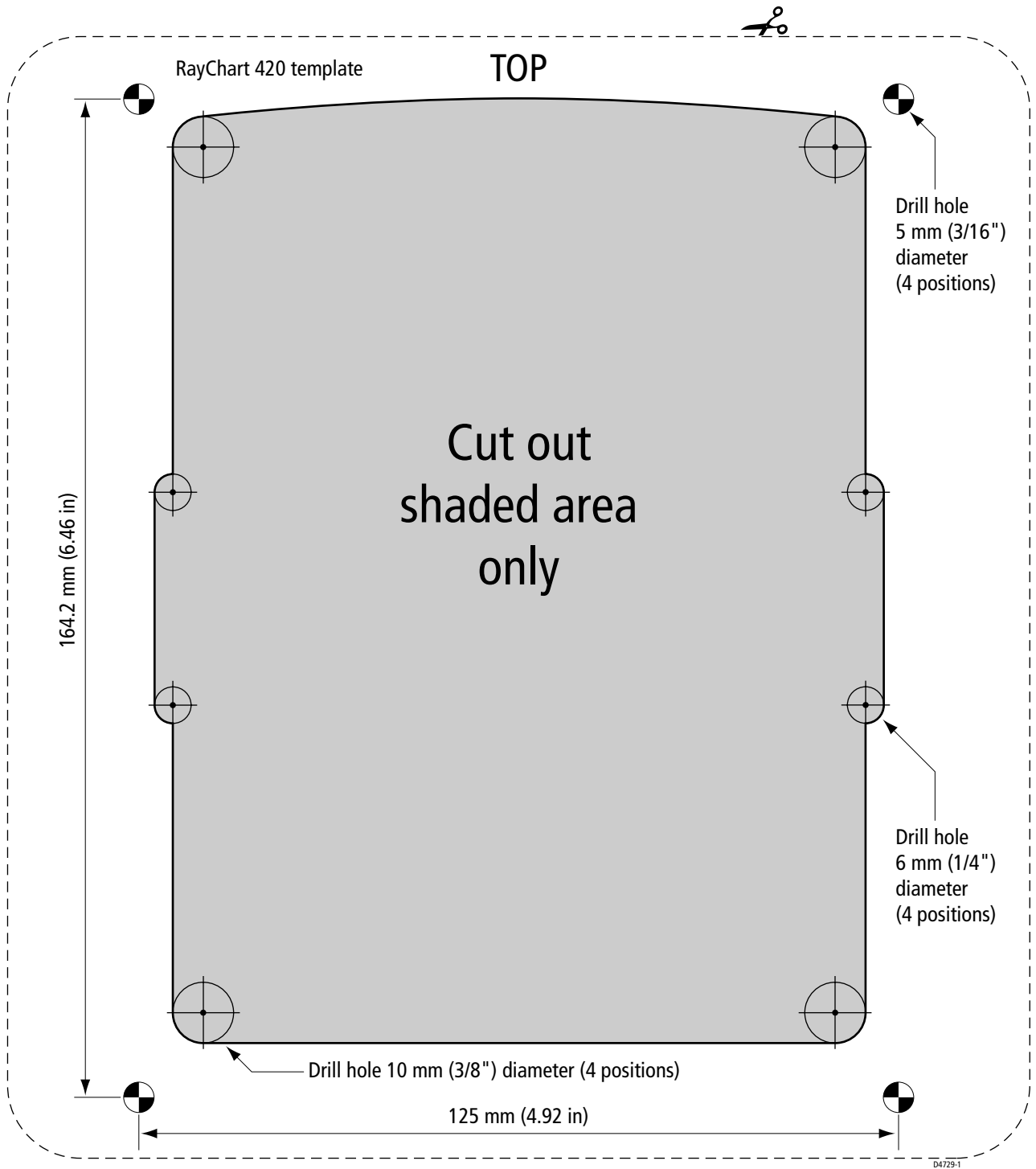

Limited Warranty Certificate

Raytheon Marine Company warrants each new Light Marine/Dealer Distributor Product to be of good materials and workmanship, and will repair or exchange any parts proven to be defective in material and workmanship under normal use for a period of 2 years/24 months from date of sale to end user, except as provided below.

Defects will be corrected by Raytheon Marine Company or an authorized Raytheon dealer. Raytheon Marine Company will, except as provided below, accept labor cost for a period of 2 years/24 months from the date of sale to end user. During this period, except for certain products, travel costs (auto mileage and tolls) up to 100 round trip highway miles and travel time of 2 hours, will be assumed by Raytheon Marine Company only on products where proof of installation or commission by authorized service agents, can be shown.

Warranty Limitations

Raytheon Marine Company Warranty policy does not apply to equipment which has been subjected to accident, abuse or misuse, shipping damage, alterations, corrosion, incorrect and/or non-authorized service, or equipment on which the serial number has been altered, mutilated or removed.

Except where Raytheon Marine Company or its authorized dealer has performed the installation, it assumes no responsibility for damage incurred during installation.

This Warranty does not cover routine system checkouts or alignment/calibration, unless required by replacement of part(s) in the area being aligned.

A suitable proof of purchase, showing date, place, and serial number must be made available to Raytheon Marine Company or authorized service agent at the time of request for Warranty service.

Consumable items, (such as: Chart paper, lamps, fuses, batteries, styli, stylus/drive belts, radar mixer crystals/diodes, snap-in impeller carriers, impellers, impeller bearings, and impeller shaft) are specifically excluded from this Warranty.

Magnetrons, Cathode Ray Tubes (CRT), hailer horns and transducers are warranted for 1 year/12 months from date of sale. These items must be returned to a Raytheon Marine Company facility.

All costs associated with transducer replacement, other than the cost of the transducer itself, are specifically excluded from this Warranty.

Overtime premium labor portion of services outside of normal working hours is not covered by this Warranty.

Travel cost allowance on certain products with a suggested retail price below \$2500.00 is not authorized. When/ or if repairs are necessary, these products must be forwarded to a Raytheon Marine Company facility or an authorized dealer at owner's expense will be returned via surface carrier at no cost to the owner.

Travel costs other than auto mileage, tolls and two (2) hours travel time, are specifically excluded on all products. Travel costs which are excluded from the coverage of this Warranty include but are not limited to: taxi, launch fees, aircraft rental, subsistence, customs, shipping and communication charges etc..

Travel costs, mileage and time, in excess to that allowed must have prior approval in writing.

TO THE EXTENT CONSISTENT WITH STATE AND FEDERAL LAW:

(1) THIS WARRANTY IS STRICTLY LIMITED TO THE TERMS INDICATED HEREIN, AND NO OTHER WARRANTIES OR REMEDIES SHALL BE BINDING ON RAYTHEON MARINE COMPANY INCLUDING WITHOUT LIMITATION ANY WARRANTIES OF MERCHANTABILITY OR FITNESS FOR A PARTICULAR PURPOSE.

(2) Raytheon Marine Company shall not be liable for any incidental, consequential or special (including punitive or multiple) damages.

All Raytheon Marine Company products sold or provided hereunder are merely aids to navigation. It is the responsibility of the user to exercise discretion and proper navigational skill independent of any Raytheon equipment.

44592-5
October 1999

Raytheon

Factory Service Centers

United States of America

Raytheon Marine Company
Recreational Products
22 Cotton Road, Suite 280
Nashua
NH 03063-4219, USA
Telephone +1 603 881 5200
Fax +1 603 864 4756
www.raymarine.com

Sales & Order Services +1 800 539 5539 Ext. 2333 or
+1 603 881 5200 Ext. 2333

Technical Support +1 800 539 5539 Ext. 2444 or
+1 603 881 5200 Ext. 2444

Product Repair Center +1 800 539 5539 Ext. 2118

UK, Europe, Middle East, Far East

Raytheon Marine Company
Recreational Products
Anchorage Park, Portsmouth
PO3 5TD, England
Telephone +44 (0)23 9269 3611
Fax +44 (0)23 9269 4642
www.raymarine.com

Customer Support
Telephone +44 (0)23 9271 4713
Fax +44 (0)23 9266 1228
E mail techsupra@rmeltd.co.uk

Stick barcode label here

Purchased from

Purchase date

Dealer Address

Installed by

Installation date

Commissioned by

Commissioning date

Owner's name

Mailing address

This portion of card should be completed and retained by the owner.

Free Manuals Download Website

<http://myh66.com>

<http://usermanuals.us>

<http://www.somanuals.com>

<http://www.4manuals.cc>

<http://www.manual-lib.com>

<http://www.404manual.com>

<http://www.luxmanual.com>

<http://aubethermostatmanual.com>

Golf course search by state

<http://golfingnear.com>

Email search by domain

<http://emailbydomain.com>

Auto manuals search

<http://auto.somanuals.com>

TV manuals search

<http://tv.somanuals.com>