



Kenmore Laundry Center Use and Care Guide

93701 Electric Series
93751 Gas Series

Contents

Important Safeguards	2-3
How to Prepare Laundry Loads	4
Dispensers	5
Laundry Aids and Uses	6
Stain Removal	7
How to Use Washer and Dryer	8-9
Laundry Center Control Settings	10
Special Washer Features Care of Special Fabrics	11
Special Care for Special Things	12
Drying Tips	13
Care and Storage	14
Warranty and Maintenance Agreement	15
Before Calling for Service	16

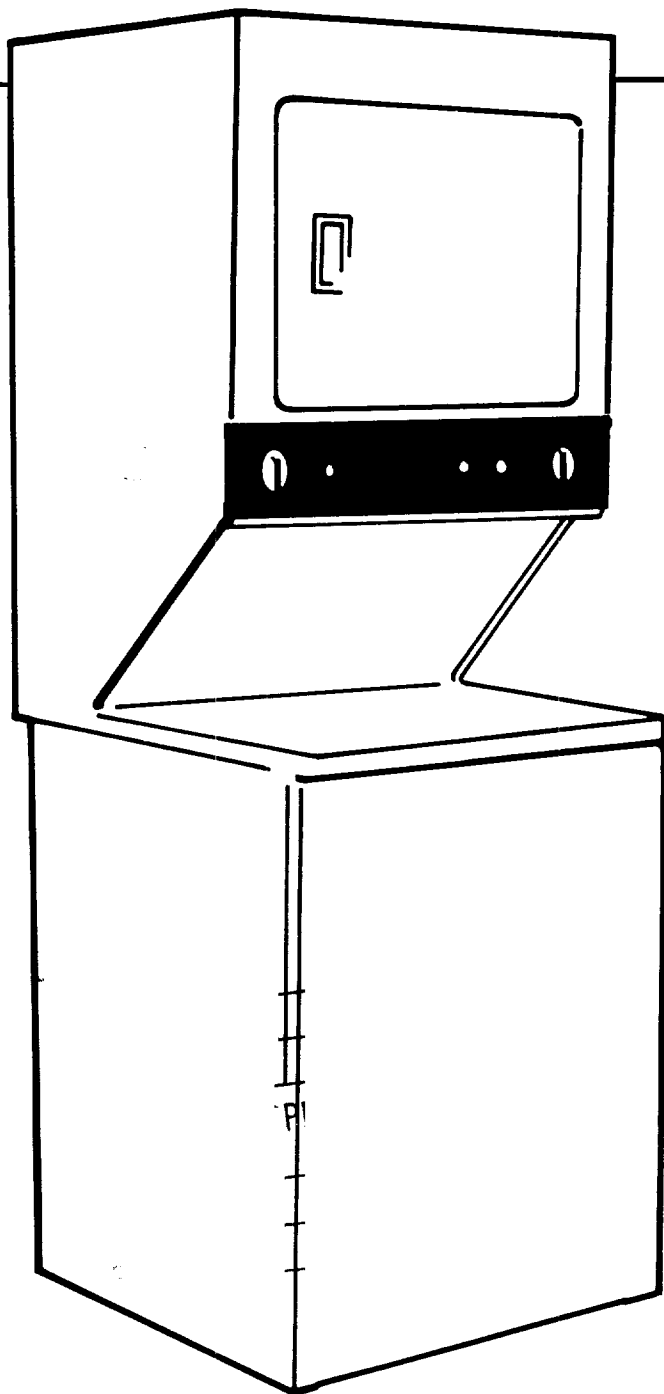

Model number:

Serial number:

Important Safeguards

Included with this Kenmore Laundry Center are the Installation Instructions, Operating Instructions, and this Use and Care Guide. Refer to these instructions for details on how to install and operate Laundry Center.

NOTE: The instructions appearing in this Owner's Guide are not meant to cover every possible condition and situation that may occur. Common sense and caution must be practiced when installing, operating and maintaining any appliance.

▲WARNING -For your safety the information in this manual must be followed to minimize the risk of fire or explosion or to prevent property damage, personal injury or loss of life.

- Do not store or use gasoline or other flammable vapors and liquids in the vicinity of this or any other appliance.

- WHAT TO DO IF YOU SMELL GAS

- Do not try to light any appliance.
- Do not touch any electrical switch; do not use any phone in your building.
- Clear the room, building or area of all occupants.
- Immediately call your gas supplier from a neighbor's phone. Follow the gas supplier's instructions.
- If you cannot reach your gas supplier, call the fire department.

Installation and service must be performed by a qualified installer, service agency or the gas supplier.

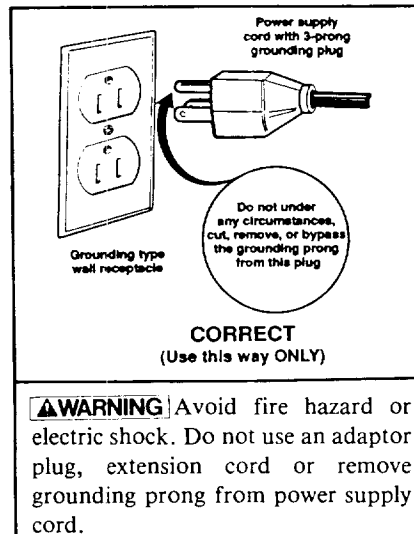

IMPORTANT SAFETY INSTRUCTIONS

▲WARNING To reduce the risk of fire, electric shock, or injury to persons when using washer and dryer follow basic precautions, including the following:

Prevent Fire

▲WARNING Do not wash or dry articles that have been previously cleaned in, soaked in, or spotted with gasoline, cleaning solvents, kerosene, cooking oil, waxes, etc. These substances give off vapors that could ignite or explode.

▲WARNING Do not put oily or greasy rags or clothing on top of dryer. These substances give off heat and vapors that could ignite the materials.

▲WARNING Do not add gasoline, dry-cleaning solvents, or other flammable or explosive substances to wash water. These substances give off vapors that could ignite or explode.

▲WARNING To prevent fire, do not use heat to dry articles containing plastic, foam rubber or similarly textured rubber-like materials, or pillows and clothing with feathers/down.

▲WARNING Under certain conditions, hydrogen gas may be produced in a hot water system that has not been used for 2 weeks or more. **HYDROGEN GAS IS EXPLOSIVE.** If hot water system has not been used for such a period, before using washer, turn on all hot water faucets and let water flow from each

for several minutes. This will release any accumulated hydrogen gas. As the gas is flammable, do not smoke or use an open flame during this time.

▲WARNING Clean dryer lint filter before or after each load. The interior of the machine, lint filter housing and exhaust duct should be cleaned approximately every 18 months by qualified service personnel. An excessive amount of lint build-up in these areas could result in inefficient drying and possible fire. See the "Care and Cleaning" section.

▲WARNING Keep area around exhaust opening and surrounding areas free from accumulation of lint, dust and dirt.

▲WARNING Fluorocarbon aerosol spray fabric softeners are not recommended for use in this dryer. Damage resulting from use of this type of softener can be considered as misuse of dryer.

▲ Failure to comply with these warnings could result in fire, explosion, serious bodily injury and/or damage to rubber or plastic parts of dryer.

Protect Children

▲WARNING Do not allow children to play on or in Laundry Center. Close supervision is necessary when Laundry Center is used near children. As children grow, teach them the proper, safe use of all appliances.

▲WARNING Destroy carton, plastic bags and metal band after Laundry Center is unpacked. Children might use them for play. Cartons covered with rugs, bedspreads or plastic sheets can become airtight chambers.

▲WARNING Keep laundry products out of children's reach. To prevent personal injury, observe all warnings on product labels.

▲WARNING Before Laundry Center is removed from service or discarded, remove lid to washer and dryer compartments to prevent accidental entrapment.

▲ Failure to comply with these warnings could result in serious personal injuries.

Prevent Injury

▲WARNING The Laundry Center must be installed and electrically grounded in accordance with local codes by a qualified service person to prevent electrical shock hazard and assure stability during operation. Installation instructions are packed on top of washer for installer's reference. Refer to INSTALLATION INSTRUCTIONS for detailed grounding procedures. If Laundry Center is moved to a new location, have unit checked and reinstalled by a qualified service person.

▲WARNING To prevent personal injury or damage to Laundry Center, the electrical cord of a gas dryer must be plugged into a properly grounded and polarized 3-prong outlet. The third grounding prong must never be removed. Never ground dryer to a gas pipe. Do not use an extension cord.

▲WARNING Follow package directions when using laundry products. Incorrect usage can produce poisonous gas—resulting in serious injury or death.

- Do not combine laundry products for use in one load unless specified on label.
- DO NOT mix chlorine bleach with ammonia or acids such as vinegar.

▲WARNING To prevent personal injury and damage to washer or dryer:

- Do not repair or replace any part of unit or attempt any servicing unless specifically recommended in this Owner's Guide. Use only authorized parts.
- Do not tamper with controls.
- Do not install or store washer and dryer where it will be exposed to weather.

▲WARNING ALWAYS DISCONNECT Laundry Center from electrical supply before attempting any service or cleaning. Failure to do so can result in electrical shock or injury.

DO'S AND DON'TS For a Better Wash

- | | |
|---------------|--|
| DO | read and follow manufacturer's care label. |
| DO | sort wash load by color, fabric and construction, amount of soil and linting. |
| DO | add measured amount of detergent or soap to empty washer. Follow recommendations on detergent (soap) package for size load, soil and water conditions. In hard water areas slightly more detergent may be required for satisfactory results. |
| DO | dissolve powdered detergent in warm water before adding to a cold wash. |
| DO | choose correct water level for size of wash load. |
| DO | select wash cycle designed for load to be washed. |
| DO | read additional information in this guide to make your laundering experience a satisfactory one. |
| DO NOT | put fabric softener in same water as soap, detergent or other laundry aids. Oil-like spots on articles may result. |
| DO NOT | overload washer. Articles must have room to move and turn freely. |

▲WARNING To prevent injury, never reach into washer while parts are moving. Before loading, unloading or adding items, push in Cycle Selector. Allow tub to coast to a complete stop before reaching inside.

▲WARNING To prevent injury, do not reach into dryer if drum is moving. Wait until machine has stopped completely before reaching into drum.

▲ Failure to comply with these warnings could result in serious personal injuries.

Safety Features

THERMAL-LIMITER SWITCH automatically shuts down dryer motor in the unlikely event of an over-heated situation (electric dryer models only).

MOTOR SAFETY SWITCH shuts off heat in dryer if motor stops.

▲WARNING To prevent possible fire hazard, do not put anything on top of Laundry Center.

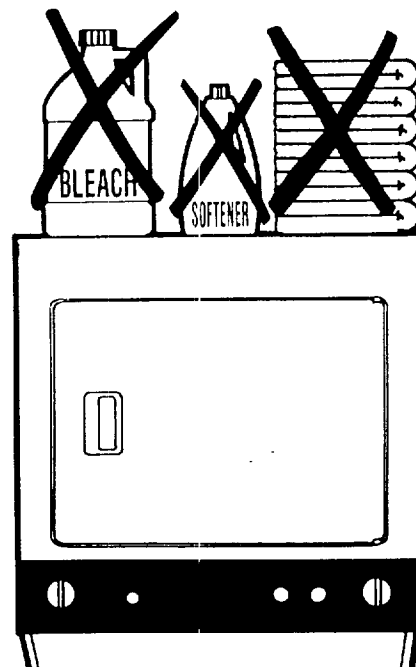

SAVE THESE INSTRUCTIONS

How to Prepare Laundry Loads

STOP

FOLLOW MANUFACTURER'S CARE LABELS FOR LAUNDERING

FOR BEST WASHING RESULTS—

Sort wash loads according to color, fabric type, construction, soil, and lint.

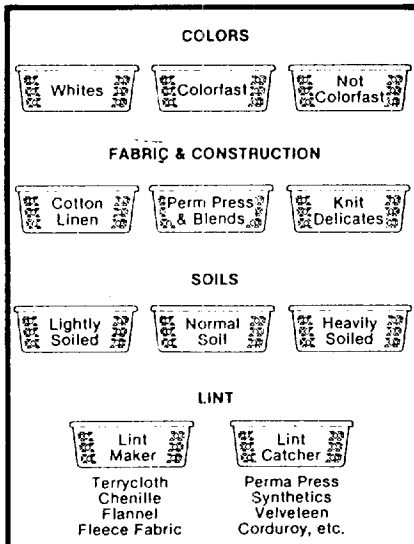

PREPARE WASH LOAD

- Close zippers, unbutton buttons, and remove detachable trimmings. Empty pockets and turn inside out.

CAUTION Remove all items from garments and fabrics to be washed or dried, such as facial tissues, matches, crayons, nails, safety pins or any metallic or hard objects which might damage clothes or appliance.

- Remove stains (see page 7).
- Pretreat very dirty areas (cuffs, collars, underarms, children's socks, oil and grease spots) with detergent-water paste or full strength liquid detergent (see Laundry Aids and Uses, page 6).
- When washing woolens, dilute all-purpose detergent before treating spot. Excessive rubbing will cause shrinkage.
- Permanent Press items require special care (see page 11).

CAUTION

Certain pretreatment products can damage washer's plastic and painted finishes. Directly apply pretreatment products to stained fabric but away from washer. After pretreatment, wash and dry fabric as usual. Damage to washer caused by pretreatment products is not covered by warranty.

SOAK HEAVILY SOILED AND STAINED AREAS

- Soaking helps loosen and remove certain kinds of dirt and stains.
- Use laundry detergent products, diluted bleach or ammonia.

WARNING

DO NOT USE CHLORINE BLEACH AND AMMONIA IN SAME LOAD—POISONOUS FUMES CAN OCCUR.

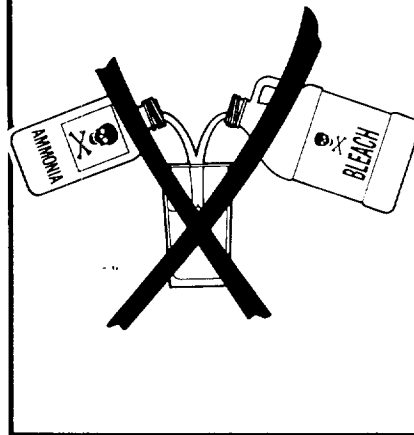

- Soaking does not replace washing. Always wash load after soaking, using detergent.

LOAD ARTICLES LOOSELY

- Load articles no higher than top row of circular holes in wash tub.
- Do not put items on top of agitator or wind them around it.
- Mix large articles with small ones. Large items should be no more than half total load.

WATER LEVEL

The water level control can be set to provide the proper amount of wash and rinse water for specific wash load sizes. Select water level that will cover top of dry load. The bulkiness of wash loads is important when determining a water level. Articles such as pillows, blankets and rugs are more absorbent and require larger amounts of water. For best results when washing bulky items, set the Water Level control at HIGH.

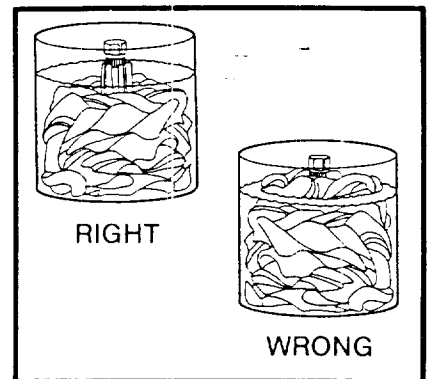

WATER TEMPERATURES

Water temperature is a very important factor. Approximate water temperatures are suggested in the chart below.

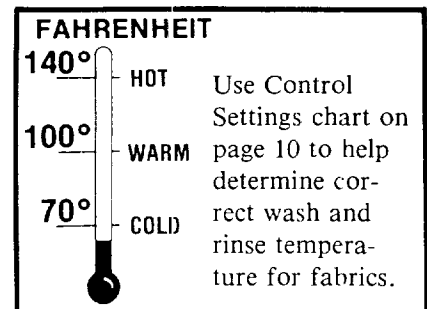

When using water temperature colder than 60° F, read instructions on detergent containers for cold water wash or the following may occur:

- Detergents may not dissolve well, leaving spots or streaks of detergent on articles.
- Soils are difficult to remove.
- Some fabrics will retain wear wrinkles and may have increased pilling.

WATER HARDNESS AFFECTS CHOICE OF LAUNDRY AIDS

Water hardness is determined by amount of minerals in water. Minerals react with soap and form scum and curd. Scum may remain on laundry, causing yellowing or gray, dingy clothing. **HARDNESS IS MEASURED IN GRAINS PER GALLON.**

Grains per Gallon			
SOFT	MED	HARD	VERY HARD
0-3	4-6	7-10	over 11

If water hardness in your home is over 7 grains, you will get better washing results by:

- Using detergent instead of soap.
- Adding extra detergent to wash, especially in cold water washes.
- Using a water conditioner.
- Installing a water softener.

If you do not know the hardness of your water supply, contact your local water department or bring a sample into Sears Store for testing.

STARCHES

Starch adds body to fabrics and helps to keep them clean longer. Follow package directions for starching in washer.

DYES

Follow package directions for dying in the washer. After dying, **clean washer thoroughly** by running a complete cycle using detergent and 1 cup chlorine bleach.

The tub and agitator may become dye stained but this will not harm the finish or transfer color to other wash loads.

Dispensers

LIQUID BLEACH DISPENSER

CAUTION Failure to follow these directions can cause bleach damage to wash load.

- ALWAYS USE HIGH WATER LEVEL.
- MEASURE LIQUID BLEACH AS FOLLOWS, DEPENDING ON SIZE AND SOIL.

SMALL



LARGE



EX-LARGE

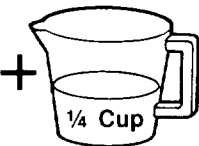

THEN ADD WATER TO DISPENSER

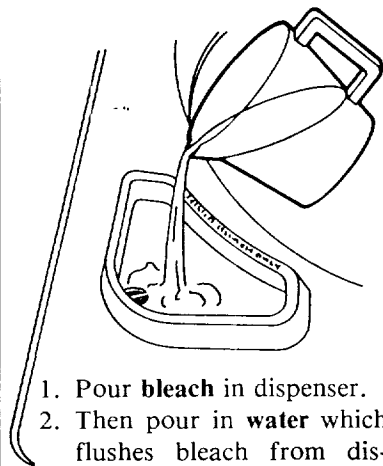

1. Pour **bleach** in dispenser.
2. Then pour in **water** which flushes bleach from dispenser so no bleach remains in dispenser to carry over to next load of wash.

POWDERED BLEACH must not be used in bleach dispenser. Add powdered bleach to wash water, following directions on package.

FABRIC SOFTENER DISPENSER (Optional)

TO FILL: Measure fabric softener according to directions on package. Add water to top of peg. (Follow instructions on container; some softeners are already diluted.)

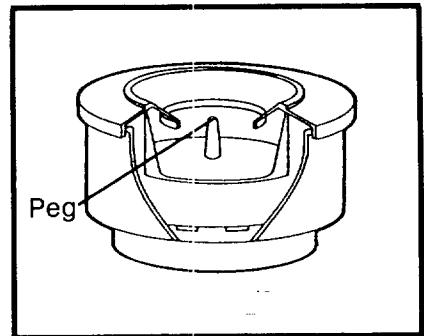

TO ATTACH: Place dispenser on agitator cap and press down firmly. Make sure lid is snapped firmly onto dispenser.

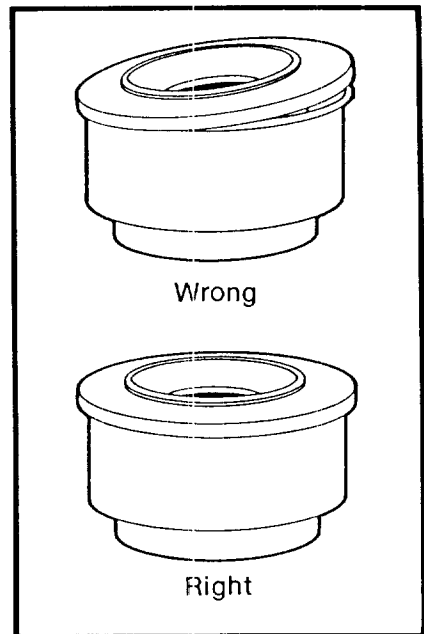

To remove dispenser from agitator cap just pull up and off.

TO CLEAN DISPENSER:

Thoroughly rinse out dispenser in warm water to eliminate buildup of fabric softener. Lid can be snapped off for easier cleaning. After cleaning, snap lid firmly in place. Any black, waxy residue can be removed by washing in hot soapy water. Use only bar soap products. Laundry or dishwashing detergents are not suitable.

Laundry Aids and Uses

LAUNDRY AID	USE	 CAUTIONS
AMMONIA	<ul style="list-style-type: none"> Use with detergent or soap for greasy soil when soaking or washing. 	<p>⚠ WARNING</p> <ul style="list-style-type: none"> DO NOT USE WITH CHLORINE BLEACH. Can produce poisonous gas resulting in serious personal injury or death.
BLEACH Chlorine Oxygen-type	<ul style="list-style-type: none"> Use to whiten clothes and to remove stains and odors when soaking or washing. Follow directions on care label of garment. Follow directions on bleach package. Bleach is not a substitute for detergent. Always use normal amount of detergent. Can be used with detergents, soaps and water conditioners. Most effective during last five minutes of wash. <ul style="list-style-type: none"> Use in warm soak or hot wash. Safe for all washable fabrics but check care instructions. Can be used with detergents, soaps and water conditioners. 	<ul style="list-style-type: none"> Do not pour directly on fabrics. Do not use in rinse cycle. Bleach must be rinsed. Do not use if there is iron in water. THIS WILL CAUSE BROWN STAIN. DO NOT USE ON WOOL, SILK OR SPANDEX. Chlorine bleach will turn wool and silk yellow and will damage the fibers, causing holes in fabric. Concentrated, chlorine bleach will damage some fibers, even cause holes. Do not use bleach with pre-soak products. <ul style="list-style-type: none"> Do not use in rinse. Slower, less effective
DETERGENTS Phosphate type Non-phosphate type	<ul style="list-style-type: none"> Use when soaking or washing to remove dirt and soil. Can be used on all types of fibers. Can be used with bleaches and water conditioners. Use recommended amounts suggested on detergent packages. <ul style="list-style-type: none"> Can be used in any water. Pretreat stains and grease spots on fabric before loading in washer. Use soft water—install a mechanical softener or use a non-precipitating softening agent. Use hottest water fabric will permit. Dissolve detergent in small amount of water before adding washload. At the end of the cycle wipe out tub with a damp cloth. 	<ul style="list-style-type: none"> If too little is used will cause fabric to become yellow or gray. Follow package instructions for amount. Do not add fabric softeners. GRAYISH GREASY STAIN WILL RESULT. Do not use more than recommended amount or excessive suds will result. <ul style="list-style-type: none"> White steaks and powdery residue may occur. Bright colors may become faded or masked. Fabrics may become stiff and hard. Whites may become grayed. Stain removal is more difficult. Flame retardant finishes may become ineffective. Abrasion and linting may increase. Rough deposits may coat the tub and interior components.
FABRIC SOFTENERS	<ul style="list-style-type: none"> Use in deep rinse to soften bath towels, diapers, etc. and to reduce static electricity in synthetic fibers. Add to rinse to minimize wrinkling of permanent press fabric. Help fabric repel lint. 	<ul style="list-style-type: none"> Do not use with detergent or bleach. GREASY CURD OR FABRIC STAIN WILL RESULT. Add only to rinse. Do not use excessively Do not pour directly onto fabric. Some may cause dark spots. See stain removal directions page.
SOAKING AGENT	<ul style="list-style-type: none"> Use in soak cycle or overnight to remove tough dirt protein and some stains. 	<p>⚠ WARNING</p> <ul style="list-style-type: none"> DO NOT USE WITH CHLORINE BLEACH. Can produce poisonous fumes resulting in serious personal injury or death. Do not use on non-colorfast fabrics, silk, wool, or acetate.
PRE-WASH PRODUCT	<ul style="list-style-type: none"> Use on fresh stains, lightly soiled areas, grease or oil stains on permanent press. See package directions. 	
SOAP	<ul style="list-style-type: none"> Use in soak and wash to remove soil or fabric softener stain. Use with bleach or water conditioners. 	<ul style="list-style-type: none"> Must be used in soft water or with water conditioner to prevent soap curd.
WATER CONDITIONER/ SOFTENER	<ul style="list-style-type: none"> Use in wash to reduce amount of detergent or soap required. Must be used with soap to prevent soap curd, in hard water. Use in rinse to aid in removing soap. Use 1 cup of conditioner at start of rinse fill. Use with detergents, soaps and bleaches. 	<ul style="list-style-type: none"> Precipitating water conditioners such as washing soda, form insoluble particles which may be difficult to rinse out.

Stain Removal

Remove stain before washing item. *If you treat stain with a flammable solution, wash item in a basin before machine washing item.*

For specific kinds of stains, follow the directions below. Use mildest treatment first. Avoid using hot water on unidentified stains; it may "set" the stain. Never iron a stain.

▲WARNING

Never put highly flammable substances like gasoline, kerosene, naphtha, waxes, cooking oils, etc. into a washer or dryer. Never put articles that have been cleaned with such substances in a washer or dryer. Failure to comply with these warnings could result in a fire, explosion or bodily injury. All items with these substances on them should be thoroughly hand-washed with a detergent so that no trace of the flammable substance remains. The articles can then be machine washed or dried.

STAIN	MAN-MADE FABRICS, WASHABLE SILK, WOOL AND NON-COLORFAST COTTONS	COLORFAST COTTONS AND LINENS
Airplane Glue	Sponge with fingernail polish remover to dissolve glue. Wash in warm water. For acetate, do not use fingernail polish remover containing acetone because it will dissolve the fabric.	Same procedure. Use hot water.
Alcoholic Beverages	Sponge immediately with cold water, then wash in warm water. Remove old stains with oxygen bleach.	Same procedure. Use chlorine bleach. Wash in hot water.
Blood	Sponge with cold water, or soak in cold water with a laundry pre-soak product. Then wash.	Same procedure. Wash in hot water. Bleach remaining stains.
Candle Wax	Remove excess wax. Press between blotters with moderately hot iron. Sponge with cleaning fluid. Wash. Bleach remaining stain with oxygen bleach.	Same procedure except use chlorine bleach.
Chewing Gum	Harden with ice cube and remove excess. Sponge with cleaning fluid. Wash normally.	Same procedure.
Chlorine Bleach	Soak in 2 tablespoons sodium hypo-sulfite to 1 quart water. Or remove yellow with commercial color remover. Rinse, then wash normally.	Same procedure.
Chocolate	Soak in warm water with a pre-soak product. Wash in lukewarm detergent solution. Use solvent to remove any grease spots. See ▲WARNING.	Soak in warm water with a pre-soak or detergent solution. Bleach remaining stains.
Coffee	Soak in cool water. Wash. Bleach remaining stain with oxygen bleach.	Same procedure. Use chlorine bleach.
Cosmetic Stains	Pretreat before washing. If greasy, treat with a grease solvent. Wash in warm water with plenty of detergent. Bleach remaining stain with oxygen bleach. See ▲WARNING.	Same procedure. Use chlorine bleach and hot water wash.
Crayon	Same as for candle wax.	Same as for candle wax. If stain has spread throughout load of clothes, wash with hot water, soap and 1 cup baking soda. Or wash with detergent or soap and chlorine bleach.
Cream, Ice Cream	Soak in cold water. If grease spot remains, sponge with cleaning fluid. See ▲WARNING.	Same procedure.
Deodorant	Sponge with white vinegar. For stubborn stains, saturate cotton with denatured alcohol. Wash.	Same procedure.
Dye Transfer	Wash. Bleach remaining stain with oxygen bleach.	Wash. Bleach remaining stain.
Fabric Softener Spots	Wet fabric, rub spots with mild bar soap, rinse. Repeat if necessary, do not use bleach.	Same procedure.
Fresh Fruit, Wine	Sponge with warm water. Wash. Bleach remaining stain with oxygen bleach.	Pour boiling water through stain. Bleach remaining stain.
Grass	Soak in warm water with a pre-soak product. Wash. Bleach remaining stain with oxygen bleach.	Soak in warm water with a pre-soak product. Wash. Bleach remaining stain.
Grease and Tar	Use a spot remover. Wash with detergent. See ▲WARNING.	Same procedure.
Ink	Washable ink: Rub in detergent or glycerine, then wash in warm detergent water. Bleach remaining stain with oxygen bleach. Ball point: Sponge with cleaning fluid or alcohol. Wash in warm water. Bleach with oxygen bleach. See ▲WARNING.	Same procedure. Use hot water. Bleach remaining stain.
Lipstick	Sponge with solvent. Wash in warm detergent solution. Bleach remaining stain with oxygen bleach. See ▲WARNING.	Sponge with solvent. Wash in hot detergent solution. Bleach.
Mildew (light)	Wash. Bleach remaining stain by soaking in an oxygen bleach solution. Wash in hot or warm detergent water.	Wash. Bleach remaining stain by soaking in chlorine bleach solution. Wash in hot or warm detergent water.
Nail Polish	Treat with nail polish remover. For acetate, do not use fingernail polish remover containing acetone because it will dissolve fabric.	Same procedure.
Paint	Before washing, treat with turpentine or solvent, depending on type of paint. See ▲WARNING.	
Perspiration	Sponge fresh stain with ammonia, old stain with white vinegar. Rinse. Soak in warm water with a pre-soak product. Follow with warm wash.	Same procedure. Wash in hot water.
Rust	Never use oxalic acid or rust remover containing acid in or around washer. It will damage porcelain surfaces. Instead, use a rust remover designed for water softeners or a laundry aid rust remover.	Same procedure.
Scorch	Wash. Bleach with mild oxygen bleach.	Wash. Bleach with chlorine bleach.
Tea	Pour boiling water through stain. Bleach with oxygen bleach.	Same procedure. Use chlorine bleach.

Dryer

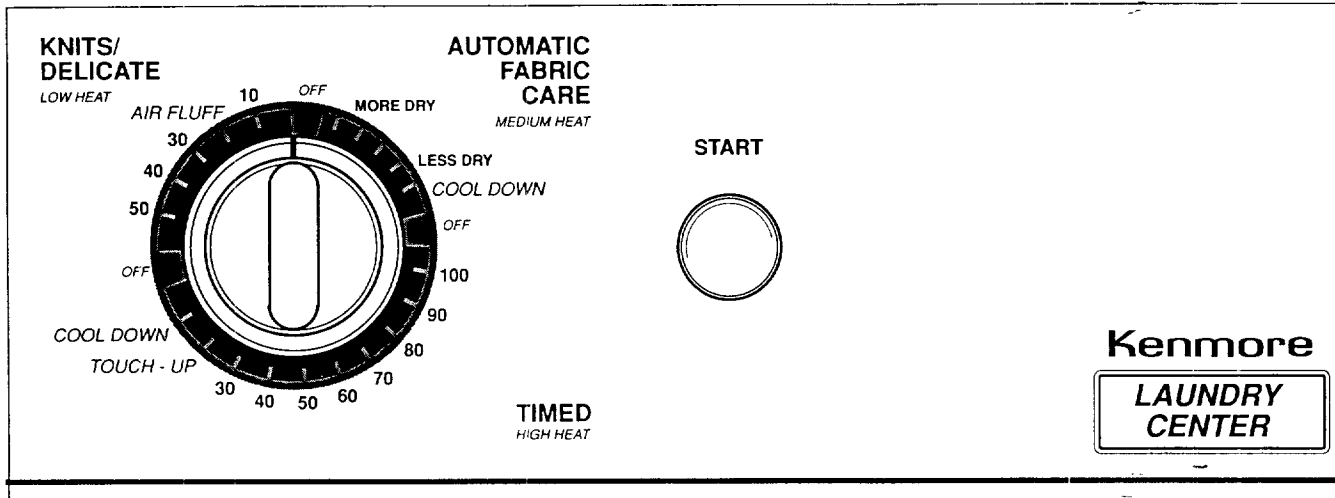

USING THE DRYER

1. **Check to be sure lint filter is clean** and in place before each load.
2. **Place wash load in dryer.** Never dry more than one wash load at a time. Add a sheet of dryer fabric softener if desired.
3. **Close dryer door.** Dryer will not operate unless door is closed.
4. **Turn dryer knob** to desired setting. The setting can be changed any time during cycle.
5. **To start dryer,** push and hold Start button about two seconds. The dryer will always stop when door is opened. If door is opened during a cycle, Start button must be pushed in to restart dryer. If the Cycle Selector is in the OFF position when Start button is pushed, dryer will not start.
6. **Cycle End Signal** sounds when drying time is completed.
7. **Remove dried load promptly** to minimize wrinkling. If load is removed before cycle is completed, turn dryer Timer knob to OFF.
8. **Clean lint filter after each load.**

CYCLE SELECTIONS

AUTOMATIC FABRIC CARE This cycle provides drying at medium heat. Drying time is determined automatically. When items are dry, heat automatically shuts off and load is tumbled for 7 minutes without heat to help reduce wrinkling. When using Automatic Fabric Care for the first time, set dryer timer halfway between MORE DRY and LESS DRY. Experience will determine if future adjustments are needed. This cycle works best with items of similar fabric, weight and construction.

TIMED This cycle provides up to 100 minutes of drying time at high heat. A cool down period is provided during the last 6 minutes of the cycle to help reduce wrinkling.

TOUCH-UP Use this setting to release wrinkles from dry clothing which may have become creased during storage or wearing. Best results are achieved by tumbling only a few items at a time with a damp towel. Hang or fold items immediately after cycle ends.

KNITS/DELICATE This cycle provides up to 50 minutes of drying time at low heat. A 20 minute cool down period is provided at the end of the cycle to help reduce wrinkling.

AIR FLUFF This setting provides up to 20 minutes of tumbling without heat. Use Air Fluff to freshen pillows and blankets and dust draperies and clothing. Use this no heat setting to dry heat-sensitive items such as plastics, foam rubber or similarly textured, rubber-like materials and items made with feathers or down. To absorb excess moisture, add several dry bath towels to load.

SAFETY FEATURES AND INSTRUCTIONS

SAFETY DOOR SWITCH stops dryer automatically if door is opened during a cycle. Close door, push and hold Start button about 2 seconds to restart. Cycle resumes automatically from point where it stopped.

AUTOMATIC MOTOR PROTECTOR stops motor when overheated from overload. It resets automatically after motor cools for approximately 30 minutes. Push and hold Start button about 2 seconds to resume cycle. Door must be closed.

AUTOMATIC TEMPERATURE HI-LIMIT SWITCH shuts off heat in event of overheating.

⚠ WARNING Do not operate dryer if lint filter is blocked, damaged or missing. Overheating, damage to fabrics and fire hazard can occur.

Washer

Remember—Select Water Temperature and Water Level for each load.



WASH TEMPERATURE

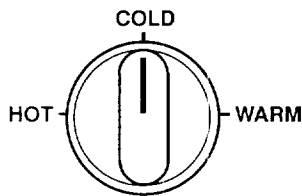

WATER LEVEL

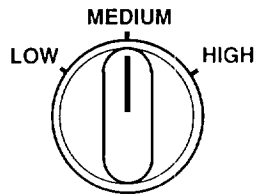
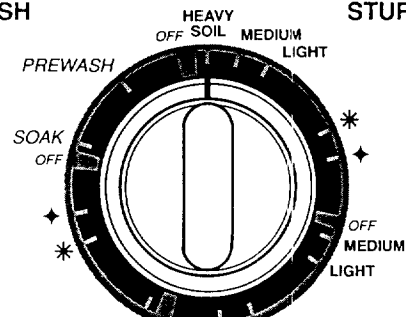
SOAK/
PREWASHCOTTON
STURDYKNITS/
DELICATEPERM
PRESS

USING THE WASHER

1. Prepare and sort laundry as directed on page 4.
2. Measure correct amount of laundry aids and add to empty tub. (Refer to pages 6 and 7 for laundry products and water hardness information.)
3. If desired, add diluted liquid bleach as directed in Bleach Dispenser section on page 5. Do not pour bleach directly onto wash load.
4. Add wash load to tub.
5. Choose control settings according to type of load and amount of soil.

• WATER TEMPERATURE

Select desired wash/rinse temperature combination. The washer will not fill if the knob is pointing between 2 settings. See page 10 for suggested settings.

• WATERLEVEL

Select water level that is best for size of load washed. Water should cover top of wash load.

6. Push cycle selector knob in and turn right (clockwise) to desired wash cycle and time. For best results, follow fabric care labels for washing instructions.
7. Turn on hot and cold water faucets.

8. Start washer by closing lid and pulling out timer knob. Washer will operate with the lid open. However, it will not go into spin cycle unless lid is closed. To stop washer or change cycle, push in Cycle Selector knob and turn it clockwise to desired setting.
9. Add fabric softener, if desired, to final rinse. Follow manufacturer's directions on product label. (If a fabric softener dispenser is available, follow directions on page 5.)
10. After the last spin cycle, wait approximately 1 to 2 minutes for the safety lid lock to release. Remove wash load for drying.

CYCLE SELECTIONS

COTTON STURDY This cycle provides up to 18 minutes of normal agitation, a spray rinse in the first spin followed by a deep rinse and 8 minutes of fast spin with a final spray rinse. Set selector according to amount of soil in each load.

PERM PRESS This cycle provides up to 12 minutes of normal agitation followed by a 1 minute cool down rinse to reduce wrinkling in the first spin, a deep rinse and 6 minutes of slow spin with a final spray rinse. The slower spin speed minimizes wrinkling during the final spin.

KNITS/DELICATE This cycle provides 6 minutes of gentle agitation followed by a spray rinse in the first spin, a deep rinse and 4 minutes of slow spin with a spray rinse.

SOAK This cycle can be used to treat heavily soiled or stained items that may require more than one wash. It provides 2 minutes of normal agitation followed by 12 minutes of soak, 2 minutes of normal agitation and 6 minutes of fast spin. Use recommended amounts of detergent and bleach or soaking agent for one wash cycle. (See package labels for amounts.) Cold water is used in this cycle.

NOTE: The Soak cycle should always be followed by a wash cycle using recommended amount of detergent.

PREWASH The Prewash portion of the Soak cycle can be used alone to help remove protein-based stains such as milk, grass and blood or to loosen soils before washing. Prewash provides 2 minutes of normal agitation followed by 6 minutes of fast spin. Use recommended amount of detergent for one wash cycle. Water temperature will be the same as wash water temperature selected.

CAUTION Using hot water in Prewash can set stains. See Stain Removal chart on page 7.

Kenmore Laundry Center Control Settings

Times for Timed Drying are approximate based on average size loads. Actual time needed will vary depending on size of load, weight of fabrics, and household voltage. Man-made fibers (synthetics) such as polyester, nylon, and acrylics should be dried on low heat.

Clothes dried in a dryer operating on a 208 volt circuit instead of a 240 volt circuit will result in longer drying time.

⚠WARNING To prevent fire and serious personal injury, do not use heat to dry foam rubber, similarly textured rubber-like materials, or pillows and clothing with feathers/down.

TYPE OF LOAD	WASHER			DRYER	
	WASH TEMP.	RINSE TEMP.	WASH CYCLE	DRYER CYCLE	DRYING TIME (Minutes)
Baby Clothes Plastic lined items Diapers** Delicate Mixed Cottons	If Label states FLAME RETARDANT, DO NOT USE SOAP—CHLORINE BLEACH will destroy some retardant finishes.				
	Warm	Warm	Knits/Delicate	Air Fluff	15-20
	Hot	Cold	Cotton Sturdy	Timed	50-60
	Warm	Cold	Knits/Delicate	Knits/Delicate	30-40
	Warm	Cold	Perm Press	Auto Fabric Care	
Bedspreads	FOLLOW LABEL INSTRUCTIONS				
	Warm	Cold	Knits/Delicate	Auto Fabric Care	
Blankets	Prewash if stained or heavily soiled.				
Cotton	Warm	Cold	Cotton Sturdy	Timed	50-60
Synthetic	Warm	Cold	Knits/Delicate	Knits/Delicate	40-50
Electric/Woolen	IMPORTANT—FOLLOW LABEL INSTRUCTIONS				
Cottons and Linens Colorfast/White Non-Colorfast	Hot	Cold	Cotton Sturdy	Timed	50-60
	Warm	Cold	Cotton Sturdy	Timed	50-60
Curtains	Prewash if heavily soiled.				
Cotton	Warm	Cold	Cotton Sturdy	Cotton Sturdy	40-50
Synthetics	Warm	Cold	Knits/Delicate	Knits/Delicate	20-30
Permanent Press	Warm	Cold	Perm Press	Auto Fabric Care	
Delicates, Lingerie	Warm	Cold	Knits/Delicate	Knits/Delicate	20-30
Foundation Garments* *See WARNING above	Warm	Cold or Warm	Knits/Delicate	Knits/Delicate	30-40
Knits Cotton/Blends Woolens Synthetics	Warm	Cold	Knits/Delicate	Cotton Sturdy	40-50
	Warm	Cold	Knits/Delicate	Knits/Delicate	30-40
Fiberglass	DO NOT MACHINE WASH OR DRY				
Permanent Press Drapes Dresses, sportswear White shirts, blouses, work uniforms Sheets and pillowcases	Warm	Cold	Knits/Delicate	Auto Fabric Care	
	Warm	Cold	Perm Press	Auto Fabric Care	
	Hot	Cold	Perm Press	Auto Fabric Care	
Plastic shower curtain	Warm	Warm	Knits/Delicate	Air Fluff	15-20 Add dry towels to absorb moisture.
Quilted Items	FOLLOW LABEL INSTRUCTIONS				
Tennis Shoes	Always consult labels before washing or drying tennis shoes. Improper care can permanently damage some shoes.				
Work Clothes—Denim Rugs—1 large or 2 small	Hot or Warm	Cold	Cotton Sturdy	Timed	50-60 DO NOT DRY RUBBER-BACKED RUGS. USE AIR FLUFF FOR 20 MINUTES.

**Soak diapers in a solution of cool water and a deodorizer until ready to wash. Remove excess water from diapers before washing by using spin only cycle.

Special Washer Features

SAFETY LID LOCK

Washer will fill and agitate while lid is open. However, it will not go into spin cycle unless lid is closed. As a safety precaution during spin in each cycle, the lid will AUTOMATICALLY LOCK to help prevent children from reaching into the wash tub. The lid will unlock approximately 1 to 2 minutes after end of spin. If required, the lid may be opened during spin cycle by pushing in Cycle Selector knob. Lid lock will release after approximately 1 to 2 minutes.

SELF-CLEANING LINT FILTER

Washer lint filter does not require cleaning after each load. Lint collected during washing and rinsing is automatically flushed away during spin cycle. If washer is drained into sink or laundry tub, remove lint that may have collected in drain or strainer.

DYNAMIC BALANCE SYSTEM

If wash load becomes unbalanced, washer compensates and reduces spin speed to complete cycle. Items may be damper than normal at end of cycle. To spin clothes drier, rearrange load, push Cycle Selector knob in, turn to right to **+** SPIN ONLY, close lid and pull out Cycle Selector knob.

Care of Special Fabrics

GLASS FIBER ITEMS

Some people are very sensitive to glass fibers and develop a skin rash after contact with fibers. Do not wash glass fiber items in washer.

For best results, follow instructions on care label. Most labels today suggest "Hand Wash—Drip Dry."

Do not dry glass fiber items in dryer.

KNITS

Man-made acrylic, polyester, and nylon knits:

- Use warm water, cold rinse and Knits/Delicate cycle.
- Bleach with either chlorine or oxygen-type bleach as needed, following care label.
- Some man-made knits have a tendency to "pill" (small balls of fibers on surface of fabric). Turn garments inside out before laundering or place them in mesh bag.
- Dry small loads. Follow manufacturer's instructions.
- Allow garment to complete drying cycle, including automatic cool down period before end of cycle.
- Remove items from dryer when tumbling stops to help prevent wrinkling.

COTTON KNITS

- Use hot or warm wash and warm or cold rinse, Cotton Sturdy cycle.

- Check care label before using bleach; add fabric softener to rinse, if desired.
- When drying small loads, add several dry bath towels.
- Remove from dryer while slightly damp.
- Reshape and finish drying on flat surface.

PLASTICS

Soft pliable plastics such as shower curtains, window curtains, mattress covers, tablecloths without backings, children's bibs, foam rubber, etc. can be machine laundered. Stiff items such as place mats should be wiped with damp cloth rather than placed in washer.

To wash:

- Select Knits/Delicate cycle.
- Use warm wash and warm or cold rinse.
- When washing shower curtains streaked with soap, do not add detergent to wash. Use water conditioner instead.

To dry:

- Use Air Fluff for 20 minutes.
- Add one or two bath towels to absorb moisture and help tumbling action.

SHEER CURTAINS

Most sheer curtains are made from nylon or polyester fibers which require special attention to prevent permanently set wrinkles.

To wash:

- Wash in small loads to allow curtains room to move freely in washer.
- Use of liquid detergent is suggested.
- Use warm wash, cold rinse.
- Use Knits/Delicate cycle.

To dry:

- Use Knits/Delicate cycle.
- Tumble for 30 to 35 minutes.
- Remove immediately to avoid wrinkling.

SLIPCOVERS

Many slipcovers now have a permanent press finish and should be laundered frequently in warm water with a cold rinse.

To wash:

- Use Perm Press cycle.
- Select warm wash, cold rinse.

To dry:

- Use Automatic Fabric Care heat setting/less dry.
- Remove from dryer while still slightly damp.
- Place on furniture and smooth into shape so they dry smooth and tight.

WOOLENS

Not all woolens are washable. Some woolens have a special finish or fiber blend which makes it possible to machine wash and dry them. Garments with this special finish will be labeled as "Machine Wash and Dry." Follow garment manufacturer's recommendations on care labels.

Special Care for Special Things

In the following hints for better washing, an all-purpose detergent should be used unless stated otherwise. See Control Setting Chart (page 10) for dryer timer settings.

Always consult garment labels and hang tags for manufacturer's washing and drying instructions before machine washing and drying.

⚠WARNING Do not use heat to dry foam rubber or similarly textured rubber-like materials, or pillows and clothing with feathers/down. Man-made fibers (synthetics) such as polyester, nylon, and acrylics must be dried on LOW heat.

TYPE OF GARMENT	HELPFUL HINTS	WASHER			DRYER
		WASH	RINSE	CYCLE	CYCLE
Cotton Baby Clothes: Gowns, Shirts Bedding	Pretreat heavily soiled areas; brush on a little liquid detergent, or wet area and rub in detergent. Use Warm soak for oil, juice stains; Cold for egg, milk, cereal stains.	Hot	Cold	Cotton Sturdy	Timed (High Heat)
Delicates—dresses, fine cotton knits	Wash separately.	Warm	Cold	Knits/Delicate	Knits/Delicate (Low Heat)
Diapers	Rinse at once, soak in diaper pail with solution of cold water and borax (½ tsp. to gal.). Soak before washing with a pre-soak product and warm water.	Hot	Cold	Cotton Sturdy	Timed (High Heat)
Plastic items	Plastic lined pants, bibs, crib sheets should be dried separately.	Wash with regular baby wash.			Air Fluff
Blankets	Shake out dust. Remove stains. Pretreat heavily soiled areas with detergent. Wash one large or two small blankets at a time. Follow manufacturer's recommendations.	Warm	Cold	Knits/Delicate	
Synthetics	Follow manufacturer's directions.				
Electric/Woolen					
Curtains, Draperies	If badly sun-weakened, even hand washing will cause tearing. Be sure colors are fast and fabric is washable. Remove hooks and non-washable trim. Use Warm soak if heavily soiled.	Warm	Cold	See page 11.	
Glass Fiber	Do not wash or dry.				
Sheer—Synthetics	Requires regular washing. If required, use Warm soak.	Warm	Cold	Knits/Delicate	See page 11.
Permanent Press Dresses, blouses, skirts, slacks	Turn slacks and dark items inside out to prevent whitening and frosting of seams and creases.	Warm	Cold	Perm Press	Auto. Fabric Care (Med. Heat)
White shirts and blouses, sheets and pillowcases	Pretreat collars and cuffs with liquid laundry detergent.	Hot	Cold	Perm Press	Auto. Fabric Care (Med. Heat)
Work clothes	Pretreat heavily soiled areas by rubbing in liquid laundry detergent. Let stand 30 to 60 minutes. If clothes are heavily soiled use Warm SOAK for grease and oil, Cold SOAK for dust or blood-stained garments. Use 1/4 to 1/2 cup liquid laundry detergent in SOAK, 1/2 to 1 cup in WASH.	Hot	Cold	Perm Press	Auto. Fabric Care (Med. Heat)
Foundation Garments (See Warning above)	Frequent washing lengthens life, helps retain shape. Remove non-washable trim. Close zippers, fasten hooks.	Warm	Cold	Knits/Delicate	Knits/Delicate (Low Heat)
Plastics	Some plastics will tear if machine-washed. Place small items in mesh bag for washing. If shower curtains are soap-stained, add water softener to wash water; don't use detergent.	Warm	Cold	Knits/Delicate	Air Fluff
Quilted Mattress Pads	Follow label directions.				
Rugs	Shake out dirt. Air dry rubber-like or rubber-backed rugs. Wash one large or two small rugs at a time. Follow label instructions.				
Sheets, Pillowcases	Use Warm Soak for pillowcases stained with hair oil.	Hot	Cold	Perm Press	Auto. Fabric Care (Med. Heat)
Slipcovers	Be sure colors are fast and fabric is washable. Mend tears; remove detachable trim and fasteners. Wash only one large or two small chair covers at a time. Cotton covers may be lightly starched.	Warm	Cold	Perm Press	Auto. Fabric Care (Med. Heat)
Sweaters, Synthetics	Pretreat around neckline. Follow manufacturer's recommendations.	Warm	Cold	Knits/Delicate	Knits/Delicate (Low Heat)
Woolens, Cashmeres	Need special care to avoid shrinkage.	See "Woolens," page 11.			See page 11.
Table Linens	Remove stains. Soak if necessary. Use Hot wash for white and color-fast, Warm for others.	Hot or Warm	Cold	Cotton Sturdy	Timed (High Heat)
Towels	Use Warm Soak with 1/2 cup bleach for stained tea towels.	Hot or Warm	Cold	Cotton Sturdy	Timed (High Heat)
Woolens— Sweaters, socks, scarves, blankets, skirts, etc.	Many are machine washable. However, because of its physical properties, wool may shrink during washing. As a general rule, if it can be hand washed, it can be "washed" by soaking in the water. A liquid detergent is preferred because it dissolves faster in a soak than granulated. Pre-treat woolens with liquid detergent. Never use chlorine bleach.	See "Washing Woolens," page 11. Warm	Cold	Knits/Delicate Keep agitation to a minimum	See page 11.
Work Clothes	Shake out dirt, turn pockets inside out. Soak clothes (see page 6), then wash thoroughly.	Hot	Cold	Cotton Sturdy	Timed (High Heat)

Drying Tips



CONSULT CARE LABELS BEFORE DRYING ARTICLES

DRY PRACTICALLY ANY FABRIC

Generally fabrics that can be washed in the Kenmore Laundry Center can be dried in the Kenmore Laundry Center.

Washables not recommended for dryer: loosely woven or hand-knitted woolens and some rayons and silks. (Check care label. See warnings below.)

Be sure plastic buttons and buckles are heat-proof.

When using delicate and permanent press fabrics, check for dryness after minimum time suggested.

If various types of fabrics are mixed in drying load, set controls for lighter weight fabrics and remove when dry. Reset temperature for remaining fabrics.

GENERAL SUGGESTIONS FOR GOOD RESULTS

An average size washer load is usually a dryer load. Items that are washed together can generally be dried together. Consult care label before drying.

CAUTION Remove all items from garments and fabrics to be dried, such as facial tissues, matches, crayons, nails, safety pins or any metallic or hard objects which might damage clothes or appliance.

- Close zippers, empty pockets, fasten hooks and eyes to prevent snagging.
- Put socks and other small items in mesh bag for easier removal.
- Items to be ironed should be removed while slightly damp.
- Put damp dry items together in one load.
- If drying sheer items, start with a cold drum.
- If drying only a few items, add a bath towel or two to maintain proper tumbling action.
- If desired, add a dryer fabric softener sheet.

- Remove and fold or hang clothes quickly to prevent wrinkling.
- Do not overload dryer. Clothes must have room to tumble and billow.
- Clothes (except permanent press) should be removed while they feel slightly damp. If they are absolutely dry to touch, they are too dry; over-drying increases wrinkling and shrinkage, and wastes heat.
- To test for dryness, take garment out of dryer and feel it in room temperature air. Clothes will feel damper in warm, moist air of dryer drum than they will in room air.
- When using TIMED cycle, set minimum time shown on Control Settings Chart (page 10).

USE OF FABRIC SOFTENER SHEETS

Over use of fabric softener can cause buildup of softener in clothing, giving a greasy feeling. Buildup can also form on lint screen and restrict airflow. Softener buildup on lint screen can be removed by washing in warm soapy water. Buildup in clothing can be removed by:

- Reconditioning load with water conditioner (follow package instructions),
- or
- Laundering several times without using fabric softener.

WARNING Fluorocarbon aerosol spray or pump fabric softeners are not to be used in this dryer. Damage resulting from use of this type of softener can be considered as misuse of dryer. Failure to follow this warning can cause serious personal injury.

AIR FLUFF

Use Air Fluff to air bedding, dust draperies and slipcovers, fluff decorative pillows, and freshen clothes that have been stored in mothballs or in a "stale" closet. Also use for safe drying of plastic and extra-sensitive sheer fabrics.

- Place items in dryer.
- Set dryer timer to the last 20 minutes of Knits/Delicate cycle which provides no heat on Air Fluff setting.



Foam Shoulder Pads



Feather or Foam Pillow

WARNING To prevent fire, do not use heat to dry articles containing plastic, foam rubber or similarly textured rubber-like materials, or pillows and clothing with feathers/down.

USE THE DRYER AS A VALET

The Kenmore Laundry Center is wonderful for steaming out wrinkles and refreshing corduroy, woolens, and velveteen skirts, jackets, slacks or blouses. Follow these directions:

- Place garments in dryer with one or two slightly dampened bath towels.
- Select proper cycle for garments.
- Select 30 minutes of heat and let clothes tumble. Steam from towels will "press" clothes.
- After 15-20 minutes (before dryer stops tumbling), remove garments and fold or place on hangers.

Care and Storage

CLEANING WASHER INSIDE TUB

- Remove clothes from washer as soon as cycle is completed to prevent development of mildew.
- Often, when heavily soiled clothes have been washed, a deposit of sand or dirt may appear around tub after completion of cycle. This may be easily removed by using a liquid cleanser and rinsing thoroughly with water.

OUTSIDE CABINET

- Never use harsh, gritty or abrasive cleaners on any surface of the Laundry Center.
- At end of each laundry day, push Cycle Selector in, wipe top and both sides of washer lid and dryer door with a damp cloth. Turn off hot and cold water to reduce pressure on water hoses.
- Occasionally clean entire cabinet with a damp cloth. Stains on lid, top or tub can be removed with a diluted solution of chlorine bleach (1/2 cup to 1 quart water). Rinse well with clear water.
- Spray cans of color-matched enamel are available from your SEARS Store or Service Center to touch up scratches on painted cabinet.

CLEANING DRYER LINT FILTER

BEFORE OR AFTER DRYING EACH LOAD

Remove and clean lint filter located at the bottom of the door opening. Failure to do so will result in longer drying times.

▲WARNING Lint filter must be in place when dryer is operating.

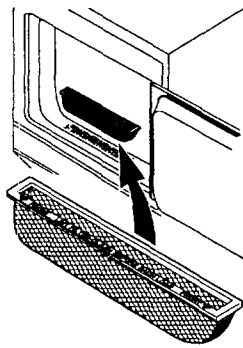

Dryer door will not close if lint filter is not properly inserted.

Dryer Drum

▲WARNING Disconnect electrical supply cord before doing any of the following cleaning or servicing procedures on the Laundry Center. Failure to disconnect can cause electrical shock or serious personal injury.

▲WARNING Do not use any type of spray cleanser when cleaning dryer interior. Poisonous fumes or electrical shock can occur.

- If drum is stained from noncolorfast fabrics, clean with a damp cloth and mild liquid household cleanser. Wipe away the cleanser residue before drying the next load of clothes.

EXHAUST SYSTEM AND INTERIOR

▲WARNING The interior of the dryer cabinet and exhaust duct can gather lint and dust over time, depending on the type of articles dried and amount of use. An excessive amount of lint build-up could result in inefficient drying and possible fire hazard. These areas should be cleaned approximately every 18 months by qualified service personnel.

TO STORE LAUNDRY CENTER IN THE COLD:

The unit cannot be operated in freezing temperatures. Before storing appliance, remove water from all parts of washer.

1. Turn off water supply faucets. Disconnect hoses from faucets and drain.
2. Add 1 gallon of non-toxic RV antifreeze (available from hardware or recreational vehicle store) to washer tub.
3. Push in Cycle Selector knob, turn knob to the right to SPIN only and pull out knob.
4. Let washer spin for 1 or 2 minutes to let all water drain out. Some, but not all, of the RV antifreeze will be expelled.
5. Push in Cycle Selector knob, dry tub interior, disconnect electrical plug and close lid.

Store appliance in an upright position.

To remove antifreeze after storage, run washer through a complete cycle using 1/2 cup detergent. **Do not add clothes load.**

Warranty and Maintenance Agreement

Warranty

Kenmore Laundry Center

FULL ONE YEAR WARRANTY ON MECHANICAL OR ELECTRICAL PARTS AND MECHANICAL ADJUSTMENTS

For one year from the date of purchase, when the Kenmore Laundry Center washer/dryer is installed and operated in accordance with the instructions in the owner's manual and installation manual, Sears will repair or replace any mechanical or electrical parts in this washer/dryer, if defective in material or workmanship, and perform any necessary adjustments, at no charge.

LIMITED WARRANTY ON WASHER GEAR CASE

After one year and until five years from the date of purchase, Sears will furnish a replacement gear case, if defective in material or workmanship. You will be responsible for labor.

The above warranty coverage applies to Kenmore Laundry Center used for private family purposes only.

WARRANTY SERVICE IS AVAILABLE BY CONTACTING THE NEAREST SEARS SERVICE CENTER IN THE UNITED STATES.

This warranty gives you specific legal rights and you may also have other rights which vary from state to state.

SEARS ROEBUCK AND CO., Sears Tower, D-731 CR-W, Chicago, IL 60684

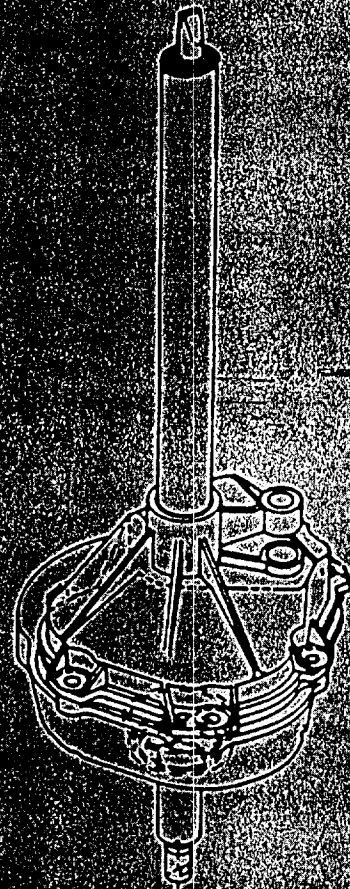

SEARS MAINTENANCE AGREEMENT

Kenmore Laundry Center is engineered, manufactured and tested for years of dependable operation. Yet, any precision machine may require service from time to time. A Sears Maintenance Agreement relieves you completely of undue inconvenience and unexpected repair bills. It

- Extends mechanical adjustment and service on a new Kenmore Laundry Center beyond the warranty period.
- Includes all parts and labor at no additional cost.
- Covers all service calls and necessary repairs any time for the entire period of the Maintenance Agreement.
- Provides a complete Prevention Maintenance check during the last month of the Maintenance Agreement, at your request and convenience . . . as listed.

- Complete operational check of switches and valves.
- Operation check of Timer settings.
- Check belts for wear and tension.
- Check all moving parts and oil leaks, and lubricate as required.
- Check electrical system.
- Check pump and hoses.
- Check operation of timer, door switch and thermostats.
- Check leveling and balance mechanisms.
- Check dispensers.
- Check elements and connections.
- Clean base and motor as needed, and check drum seal.
- Inspect exhaust systems.

This unlimited coverage is available for only pennies a day. Let your Sears Sales or Service Technician explain all the benefits of a Sears Maintenance Agreement.

Sears service is nationwide . . .

Your Kenmore Laundry Center takes on new value when you discover that Sears has service units around the country using fully-equipped trucks and staffed by Sears-trained technicians. These are Service Professionals who back up all Sears warranties. These professionals use Sears approved methods for expert repairs to fulfill the pledge: "We Service What We Sell."

If you need SERVICE or PARTS for your Kenmore Laundry Center

Be ready to give your Sears Service Center the model number, serial number, and date of purchase. The model and serial numbers of your Kenmore Laundry Center are found inside the dryer door.

Before Calling for Service, Check the Following Points

If Laundry Center does not start:

- Is plug disconnected from power supply or is plug loose in outlet, not making good connection?
- Is house fuse blown or circuit breaker off?
- Is washer Timer knob pulled out?
- Is lid closed if in spin cycle?
- Is dryer door closed?
- Is Timer set?
- Have you pressed Start button for about two seconds?
- The internal motor protector will stop motor if it is overheated, but will automatically reset after motor cools. Press Start button for two seconds to restart dryer.

If water does not enter:

- Are faucets turned on?
- Are filter screens clogged? They are located at water valve ends of hoses.
- Are hot and cold hoses reversed? Hot water hose is identified.
- Is the Wash Temperature selector pointing directly to Hot, Cold or Warm? The washer will not fill with water if the selector is pointing between 2 settings.

If water does not drain:

- Are there kinks in drain hose?
- Is drain system clogged or restricted?
- Is drain hose lower than 33" in standpipe? This can cause siphoning and washer will continue to fill. See Installation Instructions for further information.
- Is the lid closed? The washer will not spin out wash water unless the lid is closed.

If water is leaking at hose connection:

- Disconnect hose from valve. Remove rubber washer at end of hose and replace with new washer. Reconnect hose to valve. DO NOT overtighten.

⚠WARNING Disconnect electrical supply cord before servicing laundry center. Failure to disconnect can cause electrical shock or serious personal injury.

If articles are spotted or not clean:

- Is there iron in the water? Iron remover or water softener may be needed.
- Is fabric softener dispenser cracked? Fabric softener applied directly to articles will cause stains which resemble oil or grease stains.
- Is washer overloaded? Check loading section of this book.

If articles are still wet at end of spin cycle:

- Is load unbalanced? Unit is designed to complete cycle with unbalanced load which could leave articles damp. Redistribute articles and repeat spin cycle.
- Is drain system clogged or restricted?

If articles are not drying satisfactorily:

- Is lint filter clean?
- Are exhaust duct and vent hood free of obstruction or lint blockage?
- Is dryer set at Air Fluff for 20 minutes which provides no heat? --
- Are there too many articles in dryer? Check loading section of this booklet.
- Have installation instructions been followed?

⚠WARNING Do not use plastic flexible duct to exhaust dryer. Replace plastic duct with rigid or flexible metal duct. Excessive lint can build up inside duct work, creating a fire hazard and restricting air flow. Restricted air flow will increase drying time.

If you still have a problem after checking these items, you can obtain service simply by contacting your nearest Sears Service Center throughout the United States. When calling

your Sears Service Center, be ready to give the model number, serial number, and date of purchase of your appliance.

Optional Accessories for your Kenmore Laundry Center available from your nearest Sears Service Center.

- Fabric Softener Dispenser P/N 145836-000
- Drying Rack P/N 131155200
- Syphon Break P/N 0766660-000
- Drain Hose, 9 Ft. Long P/N 142337-000
- For additional accessories check Laundry Center Parts List or your local Sears Service Center.

Free Manuals Download Website

<http://myh66.com>

<http://usermanuals.us>

<http://www.somanuals.com>

<http://www.4manuals.cc>

<http://www.manual-lib.com>

<http://www.404manual.com>

<http://www.luxmanual.com>

<http://aubethermostatmanual.com>

Golf course search by state

<http://golfingnear.com>

Email search by domain

<http://emailbydomain.com>

Auto manuals search

<http://auto.somanuals.com>

TV manuals search

<http://tv.somanuals.com>